

HAZET®

Das Werkzeug



Errors excepted

WHB24/EN/XX/0



Page
18 – 115

**General workshop
equipment**



Page
116 – 283

Hand tools



Page
284 – 331

Torque technology



Page
332 – 387

**Pneumatic tools
Cordless tools**



Page
388 – 407

**Workshop tools
Safety at work**



Page
408 – 499

Specialty tools
Application chart page 409



Page
500 – 528

**Components and spare parts
Information**



- **Tool trolleys *Assistant*** Page 35 – 46
- **Work benches *Assistant* / Tool cabinets** Page 47 – 51
- **Tool trolley / Work bench accessories** Page 52 – 57
- **Tool trolleys *Assistant* with assortment** Page 58 – 84

- **Work benches *Assistant* with assortment** Page 84 – 87
- **Tool cases** Page 88 – 90
- **Tool assortments** Page 91 – 93
- **Tool modules** Page 94 – 115

- **Wrenches** Page 118 – 128
- **Range of sockets** Page 129 – 195
 - ₃ ¼ from page 142 □₁₀ ¾ from page 152 □₁₂ ½ from page 163
 - ₂₀ ¾ from page 187 □₂₅ † from page 192
 - TORX®** tools from page 194
- **Screwdrivers / Bits** Page 196 – 228
- **Pliers** Page 229 – 243

- **Hammers / Chisels / Centre punches** Page 244 – 250
- **Pullers / Extractors** Page 251 – 259
- **Grinding, separation and cutting** Page 260 – 264
- **Thread repair** Page 265 – 267
- **Measurement** Page 268 – 269
- **Tools with protective insulation / Tools for electricians** Page 270 – 283

- **Torque technology** Page 284 – 331
 - SYSTEM 5000 CT / SYSTEM 5000 CLT Page 308 – 311
 - SYSTEM 6000 CT Page 311 – 319
 - SYSTEM 7000 sTAC Page 320 – 321
 - SYSTEM 6300 CT Page 323 – 324

- **Torque screwdrivers** Page 322
- **Insert tools** Page 325 – 328
- **Torque testers and accessories** Page 328 – 331

- **Pneumatic tools** Page 332 – 379
 - Impact wrenches Page 343 – 348
 - Air ratchets Page 349 – 351
 - Drilling and grinding machines Page 352 – 366
 - Blind rivet guns Page 367
 - Air blow tools Page 368 – 370
 - Tyre inflators and measuring instruments Page 371

- Grease gun, spray gun, air blow and suction gun Page 372 – 373
- Pneumatic adaptors Page 374 – 377
- Pneumatic accessories Page 377 – 379
- **Cordless / Electrical devices** Page 380 – 387
 - Cordless impact wrenches Page 382 – 384
 - Cordless drilling machine / right-angle grinder / reciprocating saw Page 384 – 386
 - Heat guns Page 387

- **Diagnostics / Borescope technology** Page 393 – 395
- **Lights** Page 396 – 400
- **Workshop creepers / seats · Floor mats** Page 401

- **Lubrication technology** Page 402 – 405
- **General workshop tools** Page 406
- **Safety at work** Page 407

- **Passenger cars** Page 411 – 483
 - Engine Page 411 – 433
 - Gearbox Page 434
 - Oil service Page 435 – 439
 - Brakes Page 440 – 447
 - Chassis Page 448 – 468
 - Electricity / Battery service Page 469 – 473
 - Body and interior equipment Page 474 – 483

- **Commercial vehicles** Page 483 – 499
 - Engine Page 483 – 487
 - Oil service Page 487 – 488
 - Brakes Page 488 – 490
 - Chassis Page 491 – 498
 - Electricity / Battery service Page 498 – 499
 - Body and interior equipment Page 499

- **Components and spare parts** Page 500 – 509
- **Comparison** Page 510 – 511
- **A – Z Table of Contents** Page 512 – 515
- **Numerical index** Page 516 – 517

- **Terms and conditions** Page 518 – 519
- **General safety recommendations** Page 520
- **Suggestions for improvement** Page 527
- **HAZET Guarantee** Page 528





Legend

Structure of the HAZET article number:	
-	In the case of a single article, you will find e.g. the wrench size after the hyphen [-] Example: 600 N-17 → Wrench size 17 mm
/	In the case of a set or an assortment, you will find the number of parts in the assortment after the slash [/]
A	American size (dimensions in inches)
S	For impact operation (e.g. impact wrench)
Z	12-point profile
G	With hinge
KK	With ball-head
K	Short design
Lg / TZ	Long or deep design
S Lg	Very long design
T	For inside TORX ® screws
E	For outside TORX ® screws
PH	For Phillips-Recess screws
PZ	For Pozidriv screws
L	Empty, e.g. tool box empty
H / HL	In holder / holder, empty
P / PL	In plastic insert / insert, empty
K / KL	In tool box / case / tool box, empty
R	With ring
VDE	Tool with protective insulation
MgT	With magnet
IG	For inside thread
AG	For outside thread
X	Material: stainless steel
N	New design due to change of model

Structure of the tables	
T	Depth in mm
t	Load in tons
	TORX ® Size in mm
	Actuating force in kg
	Number of pieces in set/assortment

Explanations of icons	
	Components available (Pages 500 – 509) Please also see our spare parts shop www.hazet.de/ersatzteil-shop
	For slotted screws
	For Phillips-Recess screws (PH)
	For Pozidriv screws (PZ)
	For inside hexagon screws
	For outside hexagon screws
	For inside TORX ® screws
	For tamper-resistant TORX ® screws (Inside TORX ® screws with pin)
	For outside TORX ® screws
	TORX ® is the trademark of Acument Intellectual Properties LLC. HAZET is licensee for the manufacture of TORX ® Tools
	For screws with internal serration (XZN)
	For screws with internal serration with pin
	For spline socket screws (RIBE CV)
	For polydrive screws
	For inside 5-star screws with pin
	TRACTION PROFILE 6-point
	TRACTION PROFILE 12-point
	EN/IEC 60900
	6.3 1/4" Nominal size 6.3
	10 3/8" Nominal size 10
	12.5 1/2" Nominal size 12.5
	20 3/4" Nominal size 20
	25 1" Nominal size 25
	Inside square
	Outside square
	Inside hexagon
	Outside hexagon

Explanations of icons	
	Insert socket for torque wrenches
	Drive for torque wrench insert tools
	Car body
	Drive
	Chassis Axles/shock absorbers Wheels/tie rods
	Oil service
	Exhaust system
	Gearbox / shafts
	Motor electrical system
	Spark plug Glow plug
	Cylinder head Valves
	Test equipment
	Engine block Coolant pump Hose connections
	Ignition distributor alternator/generator
	Engine components Fuel supply Carburettor/Injection engine
	Clutch
	Starter
	Battery
	Piston
	Steering
	Brakes
	General workshop equipment
	Passenger car
	Commercial vehicle
	Agricultural machinery
	Motorcycles
	Industry
	Aircraft and Aerospace
	HAZET INFORMATION TECHNICAL SERVICE Further information material at: www.hazet.de → H.I.T.S. video clips
	Borescope / Service technology
	Blister packed
	HAZET blue Registered community trade mark (RAL 660-2 effect)

Structure of the tables	
	EAN = European Article Number
<i>B</i>	Width in mm
<i>L</i>	Length in mm
<i>d d1 d2</i>	Diameter in mm
<i>l1</i>	Blade length in mm
<i>l2</i>	Total length in mm
<i>M</i>	Metric thread
<i>s</i>	Wrench size in mm or inches
<i>sb</i>	Clamping range in mm
<i>st</i>	Clamping depth in mm

Additional pictograms are explained at <https://www.hazet.de/en/RenderSingleAppCon/index/type/Pictogram>

Contact details

Plant 1

Postal address:

✉ 10 04 61 · 42804 REMSCHEID Germany

Visitor's address:

Güldenwerther Bahnhofstraße 25–29
42857 REMSCHEID Germany

☎ +49 (0) 21 91 / 7 92-0

FAX Management +49 (0) 21 91 / 7 92-100

FAX Head Office +49 (0) 21 91 / 7 92-375

FAX International Sales +49 (0) 21 91 / 7 92-400

FAX Procurement +49 (0) 21 91 / 7 92-700

www hazet.de

e-mail info@hazet.de

HAZET-WERK – Hermann Zerver GmbH & Co. KG · Wuppertal · HRA 17574 · VAT ID no. DE 120803534

General Partner: Zerver Verwaltungsges. mbH. · Wuppertal HRB 11054 · Managing Partners: Matthias J. Hoffmann, Guido Schmidt

Plant 2

Industriestraße 46 · 52525 Heinsberg · Germany

☎ +49 (0) 24 52 / 1 08-0

FAX +49 (0) 24 52 / 1 08-100

Plant 3

Am Langen Siepen 13 – 15 · 42857 Remscheid

Plant 4

Vieringhausen 85 · 42857 Remscheid · Germany

Technical specialist advice

☎ +49 (0) 21 91 / 7 92-333

FAX +49 (0) 21 91 / 7 92-373

e-mail anwendungstechnik@hazet.de

Service Centre



The HAZET Service Centre is the direct contact and coordination point for services for all of our products.

In our specially equipped Service Centre, you can receive the best aftersales service with short response times and the complete HAZET competence.

Address:

HAZET-WERK

Service Centre

Güldenwerther Bahnhofstraße 17
42857 REMSCHEID

☎ +49 (0) 21 91 / 7 92-355

FAX +49 (0) 21 91 / 7 92-523

e-mail service-center@hazet.de

In essence, the HAZET Service Centre provides you with the following services:

- Repair, adjustment, calibration and certification of HAZET torque wrenches
- All service tasks on HAZET torque wrenches, pneumatic tools, tool trolleys and the rest of the catalogue programme
- Short response times
- Test equipment monitoring service for torque wrenches
- Contact partner in service matters

HAZET tools are used for:



ALFA ROMEO · AUDI · BAYER · CITROËN · DACIA · DAF · FENDT · FIAT · FORD · HARLEY-DAVIDSON · HONDA · HYUNDAI · JAGUAR · JEEP · KIA · LAND ROVER · LUFTHANSA · MAN · MAZDA · NISSAN · RENAULT · SAAB · SCANIA · SEAT · ŠKODA · SUBARU · SUZUKI · TELEKOM · TOYOTA · TRUMPF · VOLKSWAGEN

Innovative Manufacturing Competence developed and manufactured

 **Made in Germany**



reddot winner 2023

2300SH

SmartHolder

**HAZET
SMART
HOLDER** >>



2200SC

SmartCase

2200SC-1 · 2200SC-2 · 2200SC-3

2200SC-31 · 2200SC-32

**HAZET
SMART
CASE** >>

Development

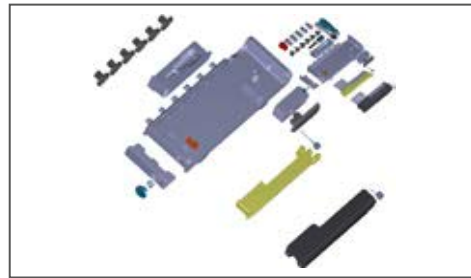

Production



Application



Marketing





Assistant

179NXXLD

Tool trolley concept in 5 variants
 179N · 179NX [b 786 mm]
 179NXL · [b 959 mm]
 179NXXL · [b 1133 mm]
 179NXXLD · [b 1133x b 642 mm]



HiPer

863HP – 916HP Lg

Fine-tooth reversible ratchets
 6.3 1/4 10 3/8 12⁵ 1/2 6.3 1/4
 90 teeth



smartTAC

SYSTEM 7000 sTAC

Electronic torque wrenches
 with built-in angle gauge, 1–1000 Nm,
 ± 1

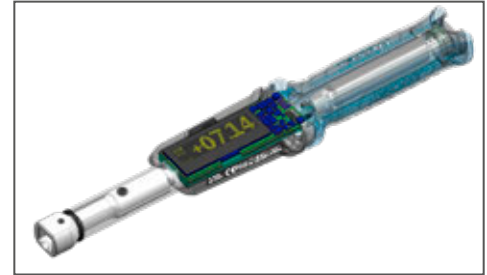

Neue Werkstattwagen Generation!
Assistant
 179N



Extrem robust – Made in Germany

- 1. **Robustheit** – Die 179N Serie ist für den Einsatz in der Industrie konzipiert. Sie ist aus hochwertigem Stahl gefertigt und verfügt über eine robuste Lackierung.
- 2. **Flexibilität** – Die 179N Serie ist in fünf Varianten erhältlich, die sich in der Breite unterscheiden. So kann die Trolley perfekt an den Platz in Ihrer Werkstatt angepasst werden.
- 3. **Praktische Ausstattung** – Die 179N Serie verfügt über eine Vielzahl an praktischen Details, wie zum Beispiel eine abschließbare Schublade, eine Ablagefläche für Werkzeuge und eine Abzugshilfe für die Schränke.
- 4. **Lebensdauer** – Die 179N Serie ist für einen langjährigen Einsatz konzipiert. Sie ist robust und langlebig, was sie zu einer idealen Investition für Ihre Werkstatt macht.
- 5. **Service** – Die 179N Serie ist ein Produkt der HAZET Gruppe. Sie profitiert von der Erfahrung und dem Know-how der HAZET Gruppe bei der Herstellung von Werkzeugen.

HiPer
 THE ORIGINAL
 MADE IN GERMANY
 Statisch UND Dynamisch – Doppelte Präzision in Perfektion!



- 1. **Präzision** – Die HiPer Ratchets sind für höchste Präzision bei der Montage konzipiert. Sie gewährleisten eine exakte Drehmomentübertragung.
- 2. **Lebensdauer** – Die HiPer Ratchets sind für einen langjährigen Einsatz konzipiert. Sie sind robust und langlebig, was sie zu einer idealen Investition für Ihre Werkstatt macht.
- 3. **Flexibilität** – Die HiPer Ratchets sind in verschiedenen Größen erhältlich, um alle Ihre Anforderungen zu erfüllen.
- 4. **Service** – Die HiPer Ratchets sind ein Produkt der HAZET Gruppe. Sie profitieren von der Erfahrung und dem Know-how der HAZET Gruppe bei der Herstellung von Werkzeugen.

smartTAC System 7000 sTAC
 Elektronischer Drehmoments- / Drehwinkelmessgerät für herkömmliche Verschraubungsanwendungen mit Smart-Schraube – Made in Germany 4.0



Bluetooth



Quality assurance and sustainability

HAZET management system for quality – environment – energy



“In our family company, we focus on services for the community and the environment alongside our economic aims, in order to ensure we can do business sustainably for generations to come.

For us, it goes without saying that we assume a role model function and integrate the necessary sense of responsibility into the company in terms of protecting and conserving the environment. We therefore also place great value on maintaining our standards when selecting our suppliers and service providers. We also set the bar very high for safety at work as our employees are our most important asset.”

Your HAZET management team

Sustainability measures

 Green energy

 Use of steel from Germany (environmentally friendly thanks to shorter transport distances)

 Conservation of resources

 Energy evaluation

 In-house production proportion of approx. 75 %

 Safety at work

 Continual optimisation measures

 PARTSLIFE environmental prize for a sustainable overall concept in environmental management

 ISO 14001 Certificate (environmental management standard with focus on a continuous improvement process)

 Klimainvest Green Concepts GmbH certifies that our Plant 2 in Heinsberg gets eco-electricity exclusively from renewable energy plants

 FSC paper (responsibly sourced paper) use in packaging and catalogues

 ISO 50001 certificate (energy management with a focus on increasing energy efficiency)

WHAT YOU CAN TRUST:

RELIABILITY

Owner-managed, German family business in its 5th generation

DOUBLY SUSTAINABLE

1. Repairable for long service life
2. Repairing with tools instead of disposing of them
High-quality tools for generations

PREMIUM QUALITY

Safety – far above the standards

DEVELOPMENT EXPERTISE

Innovator for tool solutions

MANUFACTURING EXPERTISE

High manufacturing range of over 75% * Made in Germany

Strong partnership in the Independent Aftermarket (IAM)

- Strategic cooperation
- Joint development of innovative solutions for professional workshops
- Dynamic exchange of technical expertise
- Premium rolling bearings and premium tools – hand in hand



HAZET – Awards and recognitions



**SYSTEM
5000-3 CT**

**HAZET
SMART
CASE**

7920 E

**HiPer
916 HP**

HAZET HiPer Feinwerkzeuge Gewindeschleifwerkzeuge 22-Lauf
Hochdruck 1,0
MOTOR & MASCHINE
ESSEN 2018

916 HP Lg

2300 SH-1

Manufacturing competence
Development – Production – Logistics

Development and design

Plant 1, Remscheid



Blanking

Plant 1, Remscheid



Tool and die making

Plant 1, Remscheid



Production

Plant 1, Remscheid



Electroplating

Plant 2, Heinsberg



Production

Plant 1, Remscheid



We stand for solutions – from concept to series production

With over 150 years of experience in the development and production of hand tools, tool trolleys and special tools in three plants in Remscheid and one in Heinsberg, HAZET is one of the leading manufacturers for professional applications in industry, automotive engineering and aeronautics.

Production

Plant 2, Heinsberg



Robotic manufacturing of blanks

Plant 2, Heinsberg



Sheet metal forming

Tool trolley production *Assistant*

Plant 3, Remscheid



Powder coating

Plant 3, Remscheid



Torque wrench assembly

Plant 4, Remscheid



Logistics centre

Plant 2, Heinsberg

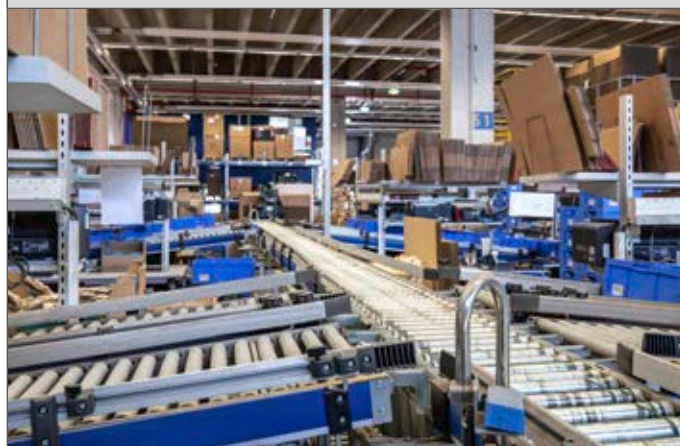



Consistently high quality standards from the initial product idea through to the after-sales service

High-tech programme

for simulation e.g. of forging processes

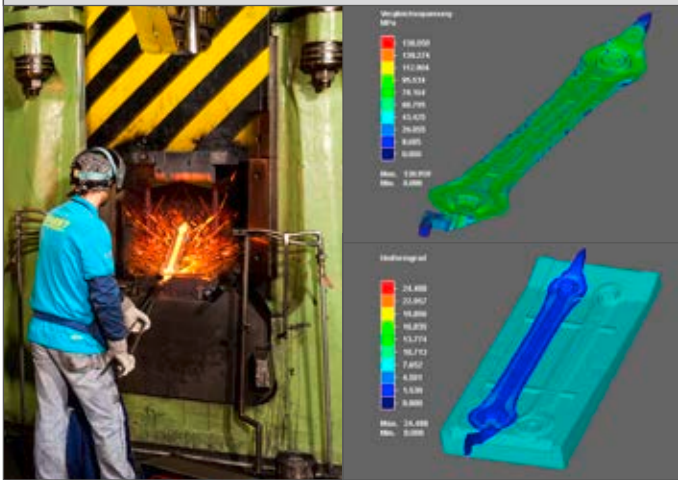

Prototyping –

for testing the first design drafts and functionalities



Maximum precision

and accuracy in all production processes



Service lifetime tests –

Alongside high loads, endurance tests are the focus of our quality assurance



Own DAkkS calibration laboratory

and HAZET calibration facility



Service centre –

the best after-sales service even long after purchase!



Service – Training – Competence and Quality

HAZET WELT

Show and training centre on 600 m²



Trade shows and exhibitions

65 x per year in Germany and abroad for you on site



20 demonstration vans in Germany and abroad

for directly assisting customers



Competent specialist advice

Problem solver on four wheels



Own DAkkS calibration laboratory

Accredited according to
DIN EN ISO/IEC 17025



Integrated management system

for quality, environment and energy in
accordance with DIN EN ISO 9001,
DIN EN ISO 14001 and DIN EN ISO 50001





Short company profile



- HAZET was established in 1868 by Hermann Zerver.
- The brand name “HAZET” has its roots in the initials of its founder, where the „H“ (HA in German) stands for Hermann and the „Z“ (ZET in German) for Zerver.
- HAZET is now a fifth generation family business.

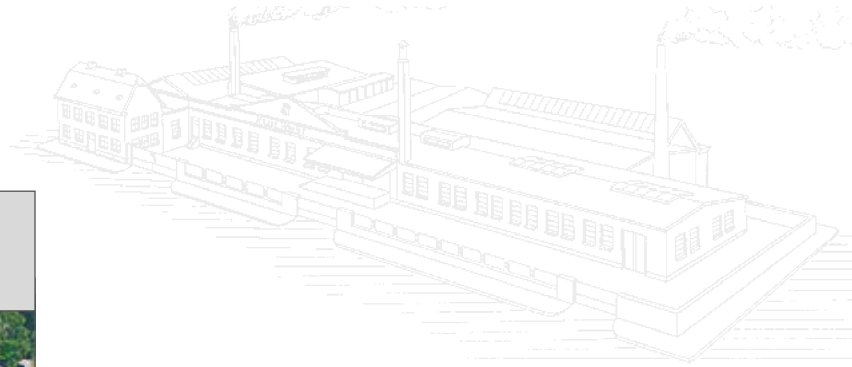

Production locations

Plant 1 · Remscheid
Blanking, production and administration

Plant 2 · Heinsberg
Logistics centre and production, for example, of reversible ratchets and sockets

Plant 3 · Remscheid
Sheet metal forming, powder system and production of tool trolleys *Assistent*

Plant 4 · Remscheid
Torque technology

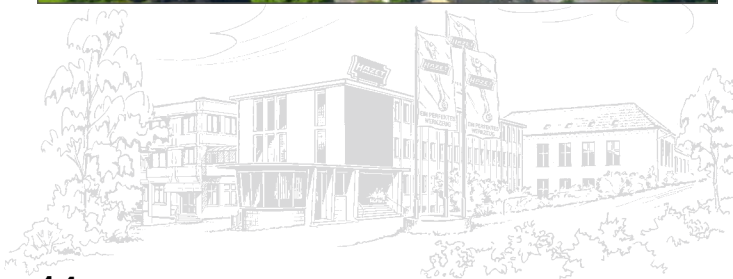

New Products and Specials

Separation sheet sets



161 T-179 N XXLD/6 → 53
161 T-179 N XXLD/6 H → 53

Vice fastening



179 ND-75 → 57

Bit holder



866 BH-14 → 226 866 BH-4 → 226

SmartRail · Flexible plastic plug-in rail



850 SR-7 → 145 850 A-SR/7 → 147 850 E-SR/7 → 148
850-SR/7 → 147 850 LG-SR/7 → 148 8500-SR/7 → 150

Adapter



2239-9 → 227

SmartHolder tool holder



2304 SH-1 → 220 2304 SH-3 → 221 2304 SH-12 → 221
2304 SH-2 → 221 2304 SH-11 → 221 2304 SH-13 → 222

Quick-clamping puller · 2-arm





















1750/5 → 255

Quick-clamping puller · 2-arm



1750-9 → 255 1750-14 → 255 1750-26 → 255 1750-44 → 255
1750-11 → 255 1750-19 → 255 1750-34 → 255

New Products and Specials

<p>Palm impact wrench  344</p>  <p>9012 PTT → 344</p>	<p>Micro die grinder  353</p>  <p>9032 MK → 353</p>	<p>Open hose reel  375</p>  <p>9040 OS-10 → 375</p>
<p>Turbo air blow gun  368</p>  <p>9040 T-1 → 368</p>	<p>Cordless impact wrench  383</p>  <p>9212-1000 LB/3 → 383 9212-1000 LB/4 → 383</p>	<p>Cordless impact wrench  384</p>  <p>9213-1000 LB/3 → 384 9213-1000 LB/4 → 384</p>
<p>Cordless screwdriver set  384</p>  <p>9230 B-1 → 384</p>	<p>HD video borescope set  393</p>  <p>4812-11/5 FS → 393</p>	<p>HD probe Ø 4.9 mm, front and side camera  393</p>  <p>4812-11 FS → 393</p>
<p>HD touchscreen video borescope set  394</p>  <p>4812-23/5 AF → 394</p>	<p>HD swivelling probe 180°, Ø 3.9 mm, front camera  394</p>  <p>4812-23 AF → 394</p>	<p>Mechanic's creeper  401</p>  <p>195 N-2 → 401</p>

New Products and Specials

<p>Releasing tool · coolant expansion tank cover · VAG</p> 	<p>Hook wrench</p> 	<p>Hook wrench</p> 
		
<p>4803-1 → 432</p>	<p>4684-1 A → 432</p>	<p>4684-2 A → 432</p>
<p>Assembly tool</p> 	<p>Assembly tool</p> 	<p>Assembly tool</p> 
		
<p>2730-2 → 444</p>	<p>2730 A → 444</p>	<p>4964-1 A → 441</p>
<p>Screwdriver socket</p> 	<p>Universal spreader · mechanical</p> 	<p>Special tool for battery plugs</p> 
		
<p>2584 LG-1 A → 463</p>	<p>4912-5 N → 460</p>	<p>4650-3 A → 470</p>





General workshop equipment



Tool trolleys *Assistant*

35–46

Work benches *Assistant* / Tool cabinets

47–51

Tool trolley / Work bench accessories

52–57

Tool trolleys *Assistant* with assortment

58–84

Work benches *Assistant* with assortment

84–87

Tool cases

88–90

Tool assortments

91–93

Tool modules

94–115

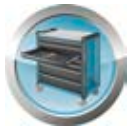

HAZET tool trolleys – Job well done – by HAZET!



HAZET YouTube channel



Assistant[®]

Made in Germany



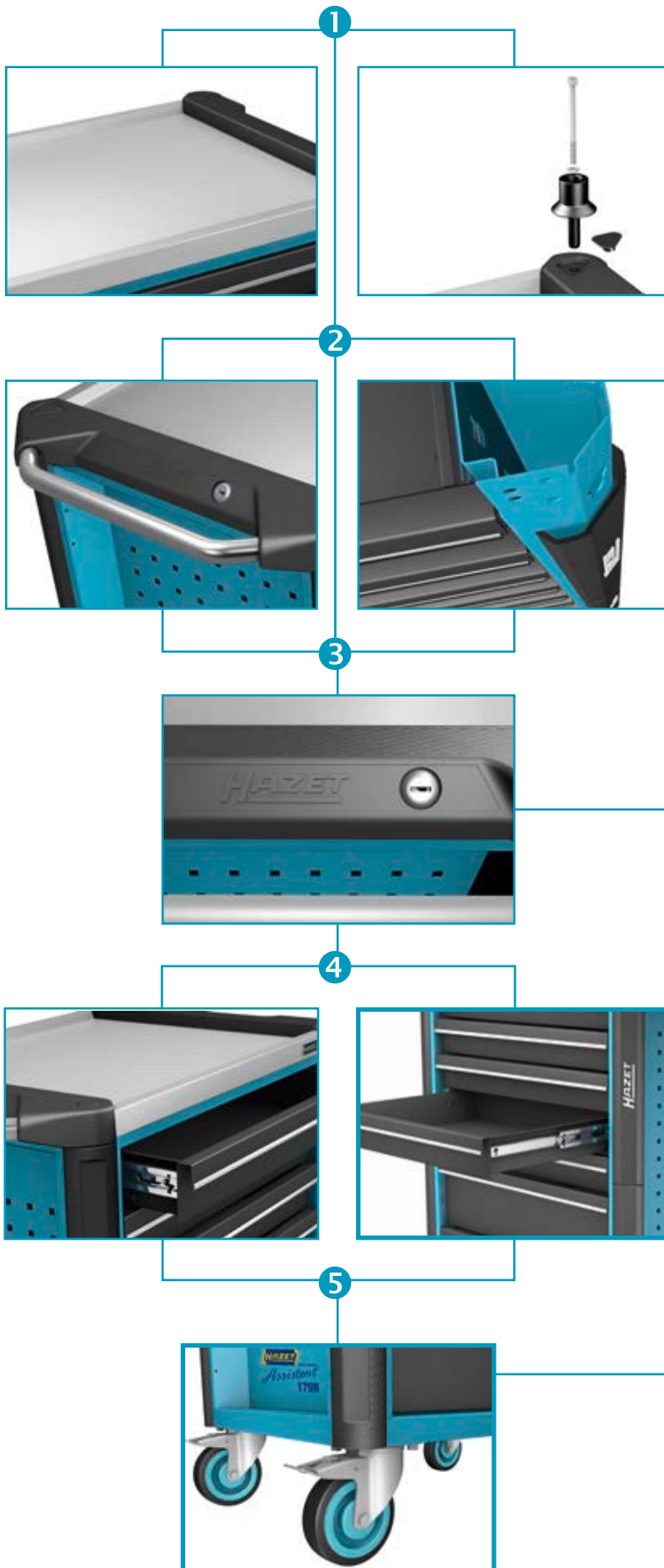

Work surfaces, edge protection and drawer fronts

- 179N with plastic or 179NX, 179NXL, 179NXXL with stainless steel work surface
- Much bigger storage and work area, depending on trolley variant up to 30 %

1

Work areas

- Fully sealed, solvent-resistant plastic or stainless steel work surface protects inside of trolley from leaking liquids
- Extra protection through high-quality plastic end caps
- Stainless steel work surface (179NX, 179NXL, 179NXXL)
- Interfaces integrated in the work area for accessories such as laptop holders and top modules

2

Body / Pull-handle

- Extremely robust design thanks to dual-wall structure
- Complete welded construction of the entire body for tough daily workshop use
- Optimised, yielding edge protection on all four corners with real impact protection thanks to internal damping concept
- Ergonomically optimised pull handle for better manoeuvrability
- Left metal handle, powder coated in black for the 179N or robust brushed stainless steel handle for the 179NX and 179NXL and 179NXXL

3

Locking concept

- Ergonomically arranged side lock position for better operability protects keys and lock against damage
- Highly secure closing system with new central locking technology for optimum protection of your property
- 2-stage locking:
 - Central locking, lockable with cylinder lock and two folding keys
 - Mutual drawer locking for a minimum tilting risk

4

Drawer concept

- Self-closing and reciprocal locking of the drawers prevents unwanted opening
- Loading capacity per drawer
 - 25 kg: 179N · 179NX
 - 40 kg: 179NXL · 179NXXL
- 100% slide-out with ball-bearing telescopic rails
- New drawer design for optimum use of the interior
- New drawer fronts for optimised handling
- New dirt-insensitive drawer coating for easy cleaning
- Drawer size for order system 3/3+
- Flat drawer (*h* 76.5 mm), high drawer (*h* 161 mm)

5

High performance chassis

- Large wheels with high loading capacity (\varnothing 125 mm) with precision ball bearing and dual ball race in the swivel bearing, easy manoeuvrability, even with high dynamic load
- 2 swivel castors with double stop function: fixed castor prevents inadvertent rolling of the trolley, fixed swivel bearing prevents the castors from swivelling, e.g. on an inclined surface
- Protective ring prevents dirt and threads from getting in
- Non-marking elastic tyres enable smooth movement

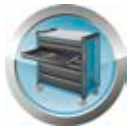

HAZET tool trolleys – job done better by HAZET!

Assistent[®] 179 N XXL-8 D



1/2++	1/2++	3/3	3/3	1/9
				1/3+
1/3	1/3+	1/9		
2/3	2/3	1/3		

Made in Germany



Mobile work bench

Assistant® 179 NW



HAZET YouTube channel



1

Cable duct on rear panel allows battery devices to be charged when the door is closed, for instance

2

Lock located in the centre (central locking and cylinder lock) closes the door and drawers at the same time. One key for locking the door and drawer at the same time. (Included in delivery: 2 keys)

3

Optimised, yielding edge protection on all four corners with real impact protection thanks to internal damping concept

4

Complete welded construction of the entire body for tough daily workshop use

5

Additional rectangular perforation for tool holder, e.g. HAZET 112-230

6

6 flat drawers, loading capacity 25 kg, 76 mm high

7

1 heavy duty drawer, loading capacity: 40 kg, 161 mm high

6 + 7

100% drawer slide-out with ball-bearing telescopic rails – self-closing. Mutual drawer locking for a minimum tilting risk

8

Intermediary tray adjustable in 9 positions, permanently mounted door

9

Wood multiplex birch work surface, replaceable

Made in Germany



Tool trolley and work bench accessories



HAZET No.	Designation	Tool trolley <i>Assistant</i> type:										
		166 C	167 T	167-3S	177	177 W	178 N	179 N (X)	179 NW	179 NXL	179 NXXL	179 NXXLD
112/11	Tool holder		X ₄₎	X	X	X	X	X	X	X	X	X
161-1	Anti-slipping mat				X	X	X					
161-9	Window pane holder	X ₁₎										
161N-3D/2	Cable drum			X	X	X	X	X	X	X	X	X
161N-5D	Socket strip											X
161T-178N/4	Separation sheet set						X					
161T-179N/4	Separation sheet set							X	X			
161T-179N/4H	Separation sheet set							X	X			
161T-179NXL/5	Separation sheet set									X		
161T-179NXL/5H	Separation sheet set									X		
161T-179NXXL/6	Separation sheet set										X	
161T-179NXXL/6H	Separation sheet set										X	
161T-179NXXLD/6	Separation sheet set											X
161T-179NXXLD/6H	Separation sheet set											X
161T-347x120/5	Separation sheets				X	X						
161T-347x60/5	Separation sheets				X	X						
161T-395x120/5	Separation sheets							X	X	X	X	
161T-395x60/5	Separation sheets							X	X	X	X	
162C-5	Container for small parts	X	X									
162C-6/5	Separation sheets for intermediary tray	X										
167T23	Storage board		X									
167T26	Perforated tool panel		X									
173-38	Storage board									X		
177W-21	Door					X						
179-35	Can holder		X ₄₎	X	X	X	X	X	X	X	X	X
179N-21	Lateral door							X		X	X	
179N-21D	Lateral door											X
179N-26	Vertical tool panel							X				
179N-33	Paper bin			X	X	X	X	X	X	X	X	X
179N-35	Can holder		X ₄₎	X	X	X	X	X	X	X	X	X
179N-40	Basic fixture							X		X	X	X
179N-42	Laptop holder - complete							X		X	X	X
179N-45	Tray holder				X ₂₎		X ₂₎	X ₂₎		X ₂₎	X ₂₎	X ₂₎
179N-50	Bracket for an L-Boxx							X	X	X	X	X
179N-51	Bracket set for two L-Boxxes							X	X	X	X	X
179N-510	Bracing surface for L-Boxx bracket 179N-51								X ₇₎	X ₇₎	X ₇₎	X ₇₎
179N-75	Vice fastening							X		X	X	
179ND-75	Vice fastening											X
179NW-11	Machinist's vice fastening set					X			X			
179NW-22	Shelf drawer								X			
179NW-23	Tray								X			
179NW-26	Vertical tool panel								X			
179NXL-26	Vertical tool panel									X		
179NXXL-26	Vertical tool panel										X	X
179W-40	Basic fixture					X			X			
179W-42	Laptop holder					X			X			
180-24	Document holder		X ₄₎	X	X	X	X	X	X	X	X	X
180-34	Holder for paper reel			X	X	X	X	X	X	X	X	X
180-35	Can holder		X ₄₎	X			X		X			X
2175N	Machinist's vice				X ₃₎	X ₆₎		X ₅₎	X ₆₎	X ₅₎	X ₅₎	X ₈₎
2175N-11	Washer				X							

1) To be used in pairs

2) Observe application note

3) Together with 2175N-11

4) Together with 167T26

5) Together with 179N-75

6) Together with 179NW-11

7) Together with 179N-51

8) Together with 179ND-75



The modules

The right insert for every drawer

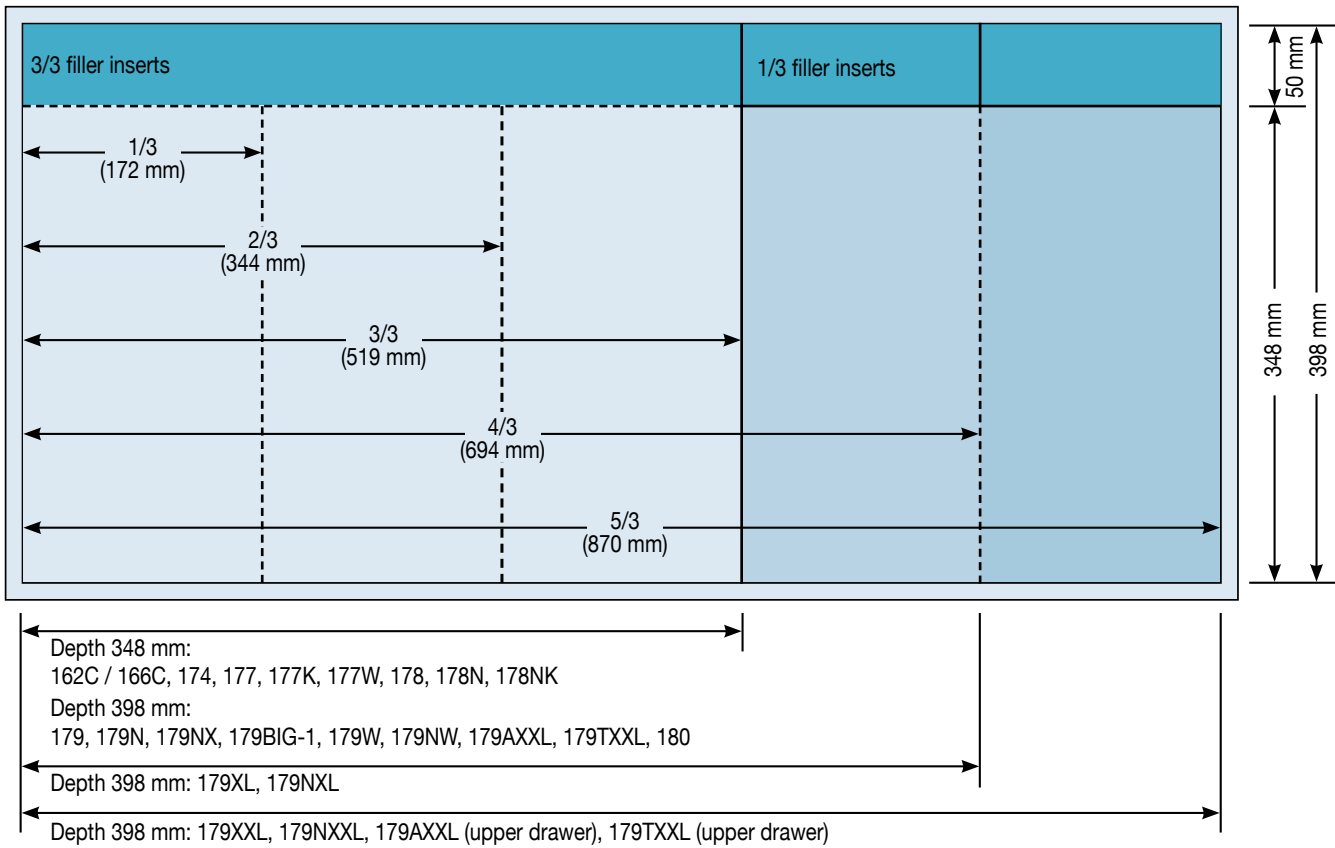

1/9

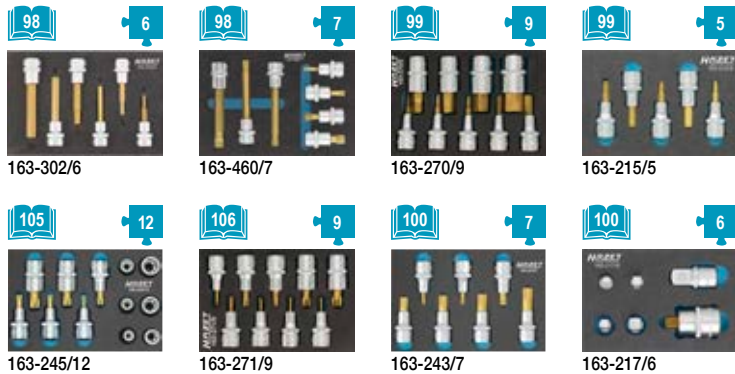
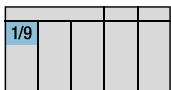

3/3 Filler inserts

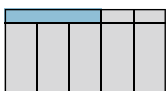

1/3 Filler inserts

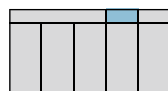

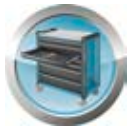

1/3

1/3			
-----	--	--	--



163-95/8



163-292/8



163-428/15



163-97/6



163-259/14



163-483/33



163-272/32



163-191/18



163-459/15



163-463/15



163-220/13



163-468/8



163-587/35



163-184/6

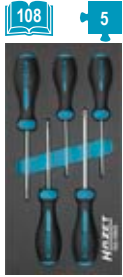

163-185/5



163-266/6



163-264/5



163-461/5



163-122/3



163-182/9



163-96/3



163-124/4



163-121/4



163-425/3



163-464/3



163-426/4



163-580/18



163-229/7



163-226/4



163-227/3



163-548/14



163-130 L

1/3+

1/3+			
------	--	--	--



163-519/12



163-509/12



163-515/16



163-520/15



163-518/9



163-379/38



163-570/24



163-571/22



163-522/6

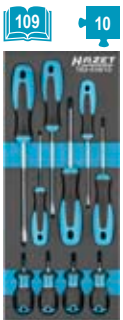

163-516/10



163-380/4



163-517/15



163-382/3



163-375/5



163-511/4



163-510/8



163-523/11



General workshop equipment



2/3

2/3		
-----	--	--

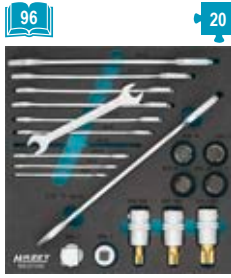

163-211/20

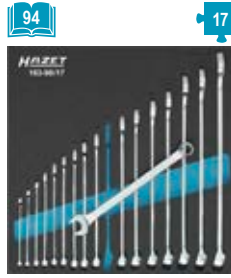

163-98/17

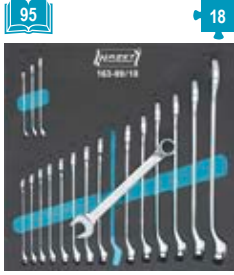

163-99/18

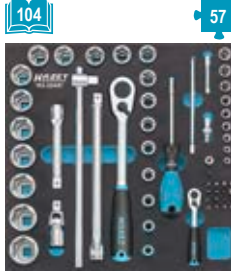

163-224/57

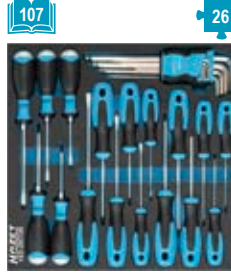

163-297/26

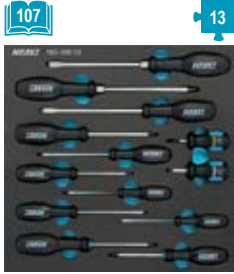

163-100/13

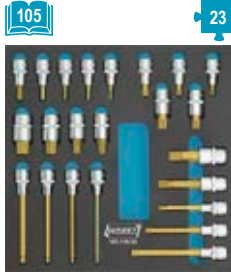

163-119/23

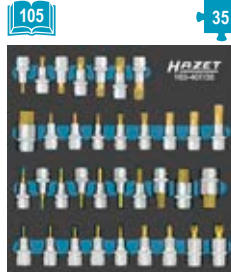

163-407/35

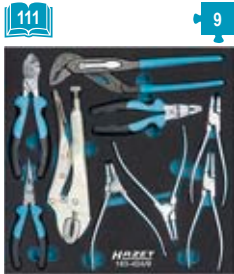

163-424/9

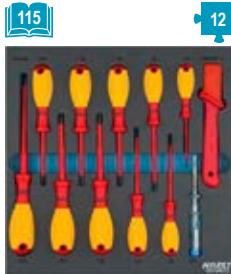

163-546/12

2/3+

2/3+		
------	--	--



163-542/18

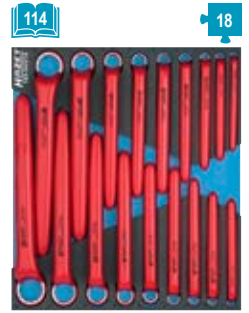

163-543/18

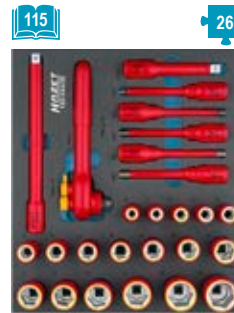

163-544/26



163-545/41

3/3

3/3		
-----	--	--



163-210/19

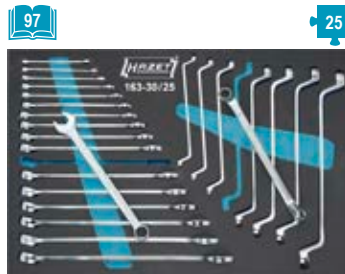

163-30/25



163-366/18

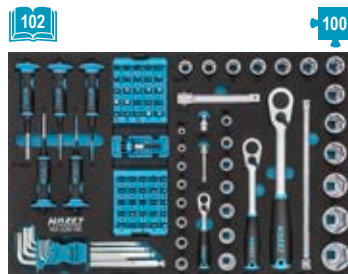

163-329/100

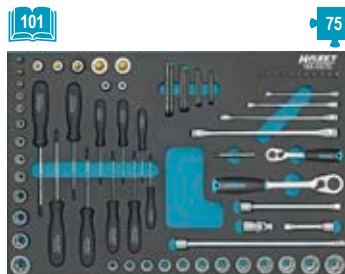

163-53/75

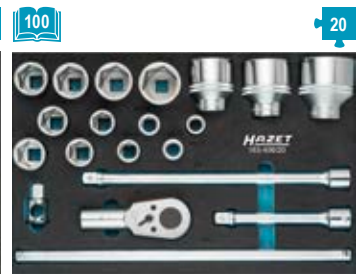

163-406/20

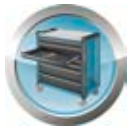

3/3 (Continued)

3/3		
-----	--	--

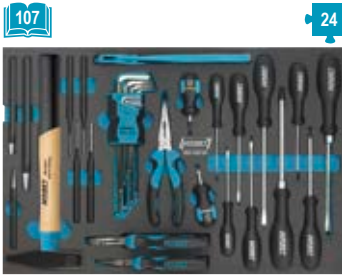

163-120/24

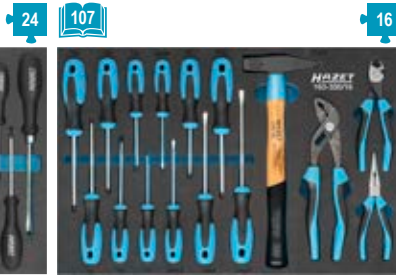

163-330/16



163-60/22

3/3+

3/3+		
------	--	--



163-374/27



163-140/33

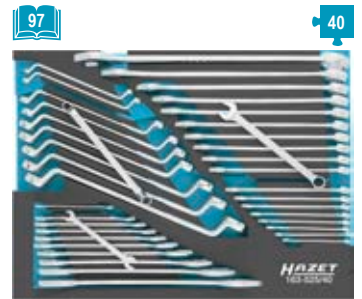

163-525/40



163-371/7



163-138/77

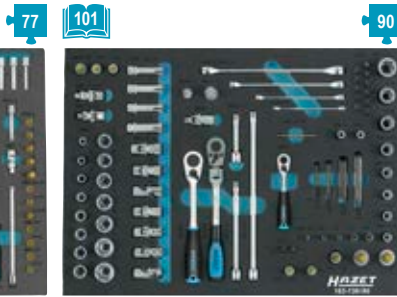

163-139/90

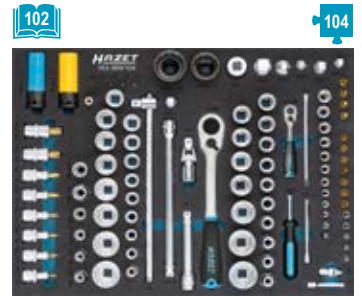

163-369/104

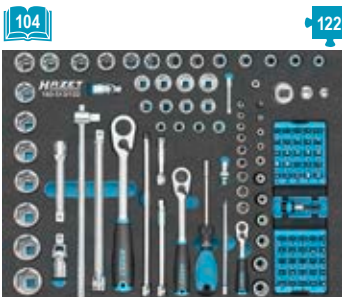

163-513/122



163-141/31

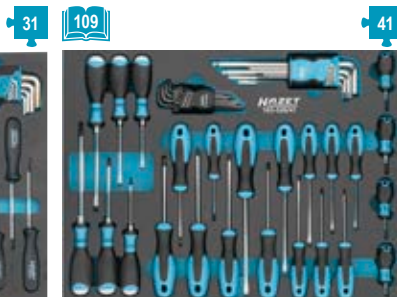

163-526/41



163-524/31



163-372/25



163-143/18



General workshop equipment



4/3+

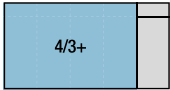

96

40



163-478/40

96

45

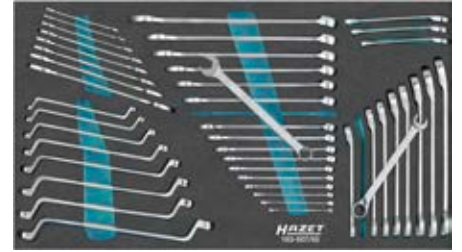

163-507/45

97

56



163-528/56

102

138



163-508/138

103

194



163-481/194

103

160



163-549/160

109

57



163-480/57

108

56



163-527/56

112

26



163-479/26

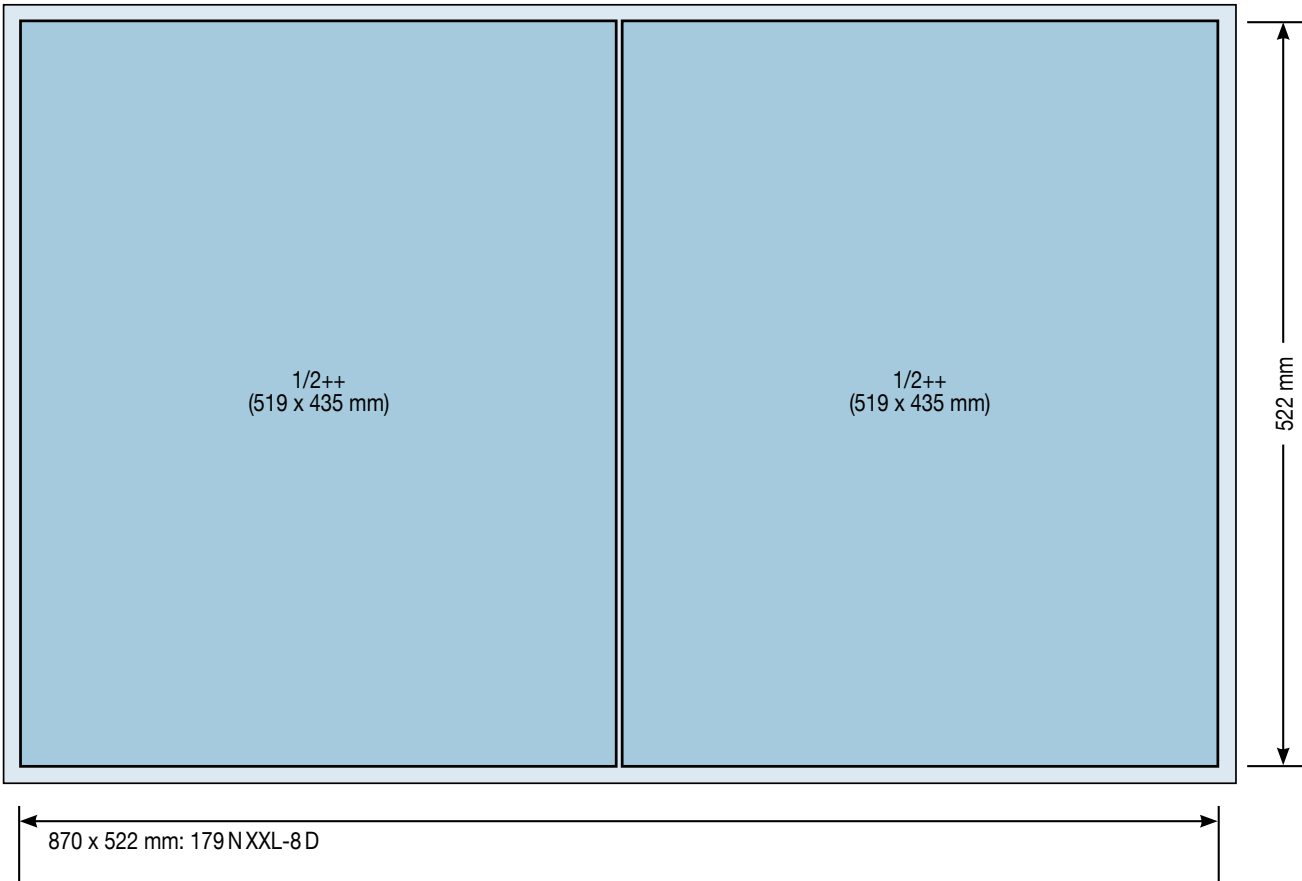
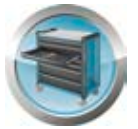

1/2++

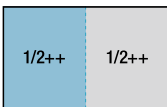

97



163D-10/30

30

94



163D-9/42

42

104



163D-1/148

148



General workshop equipment



1/2++ (Continued)

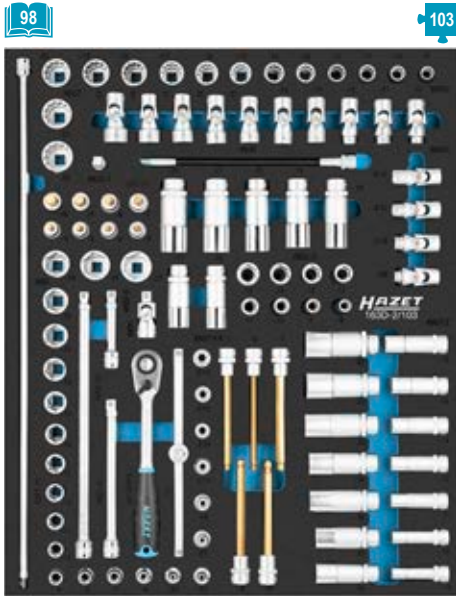

163 D-2/103



163 D-4/44

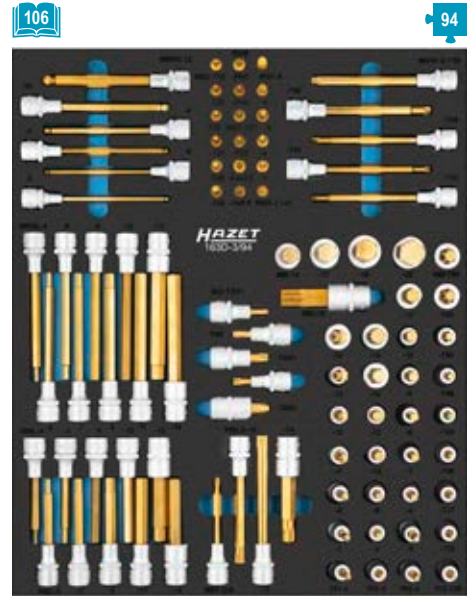

163 D-3/94

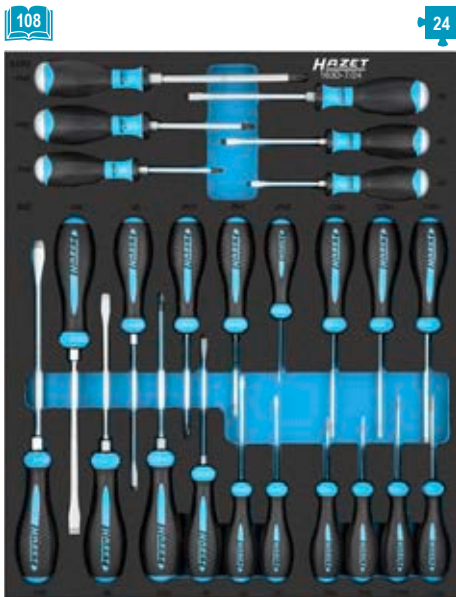

163 D-7/24

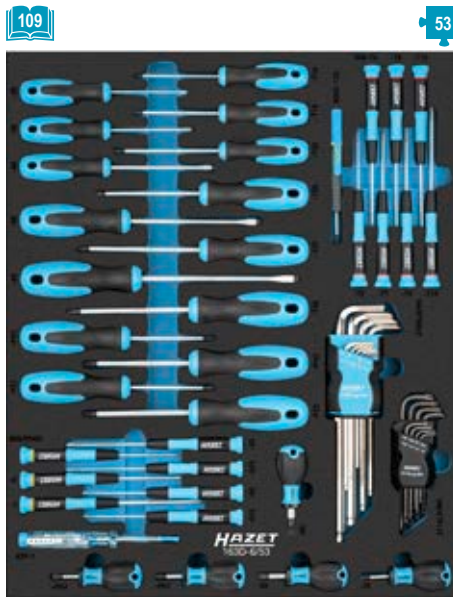

163 D-6/53

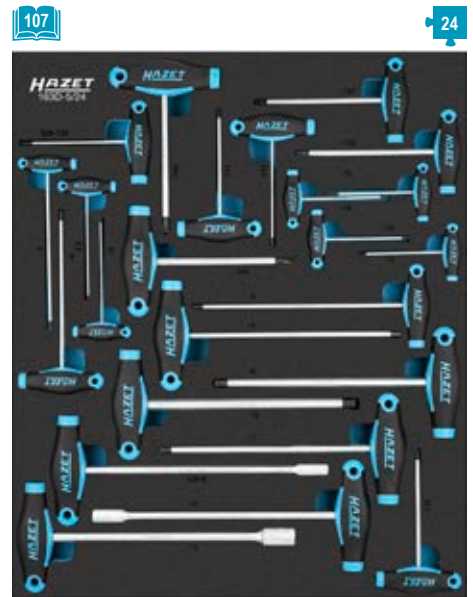

163 D-5/24



163 D-8/13



163 D-11/11



163 D-12/30



HAZET tool trolleys













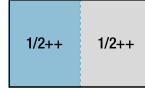

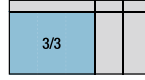
Made in Germany

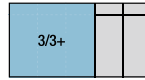
HAZET No.	Technical Specifications					Design			
	L x W x H mm	Total loading capacity (static) kg	Loading capacity per drawer kg	Drawer sliding-out %	Module size	Impact protection	Work-top	Drawer lock	
177-6 -7 	780x498x915	300	20	100%			Plastic, solvent resistant	Central locking Individual drawer locking per drawer	35
178 N-7 	781x498x1037	480	20	100%			Plastic, solvent resistant	Central locking Individual drawer locking per drawer	37
178 N K-3 	696x488x390	145	20	100%				Central locking Individual drawer locking per drawer	37
179 N-6 ... -9 	785x518x1020	540	25	100%		All corners are protected by rubber edge protection	Plastic, solvent resistant	Self-closing Central locking Mutual drawer locking	39
179 N X-6 ... -8 	786x518x1020	540	25	100%		All corners are protected by rubber edge protection	Stainless steel	Self-closing Central locking Mutual drawer locking	39
179 N XL-6 ... -8 	959x518x1020	1000	40	100%		All corners are protected by rubber edge protection	Stainless steel	Self-closing Central locking Mutual drawer locking	41
179 N XXL-7 ... -8 	1133x518x1020	1000	40	100%		All corners are protected by rubber edge protection	Stainless steel	Self-closing Central locking Mutual drawer locking	42

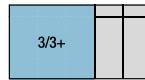

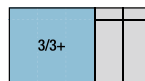
General workshop equipment

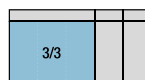

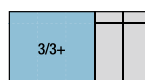
HAZET No.	Technical Specifications					Design			
	L x W x H mm	Total loading capacity (static) kg	Loading capacity per drawer kg	Drawer sliding-out %	Module size	Impact protection	Work-top	Drawer lock	
 179 N XXL-8 D	1133x642x1020	1000	40	100%		All corners are protected by rubber edge protection	Stainless steel	Self-closing Central locking Mutual drawer locking	43
 166 N	680x350x965	300				Plastic profile for shock protection	PVC mat	Padlock	44
 166 C	725x398x1102	300				Plastic profile for shock protection	Wood multiplex beech	Padlock	44
 167-3	890x542x899	150			 3x				45
 167-3S	888x541x899	150			 3x				46
 167 T	773x740x1345	150							46
 177 W-6 -7	1040x520x934	750	20	100%			Wood multiplex birch	Central locking Individual drawer locking per drawer	47
 179 NW-7	1150x600x965	750	25 / 40	100%		All corners are protected by rubber edge protection	Wood multiplex birch	Central locking Mutual drawer locking	48



The HAZET tool trolley *Assistant* ... at home in every sector!



#passengercars



#industry



#commercialvehicles



#trade



#agriculture



#home



General workshop equipment

Tool trolleys *Assistant*



Tool trolleys *Assistant*

177 Tool trolley *Assistant*

Made in Germany

• Tool trolley

- Large ball-bearing wheels (∅ 100 mm), easy manoeuvrability, even with high dynamic load
- 2 swivel castors (∅ 100 mm), 1 x lockable
- Thread guard – protects the bearings against dirt and threads
- Grey non-marking elastic tyres enable smooth movement
- Two-stage locking concept:
 - Central locking, lockable with cylinder lock and 2 keys
 - Individual drawer locking prevents unwanted drawer opening
 - 100% sliding-out with roller guides
- Total loading capacity (dynamic): 300 kg
- Loading capacity (static): 300 kg
- Loading capacity of high drawer: 20 kg
- Colour: HAZET blue



The following accessories are available separately:

HAZET No.	Designation		HAZET No.	Designation	
112/11	Tool holder	50	179 N-35	Can holder	55
161-1	Anti-slipping mat	52	179 N-45	Tablet holder	56
161 N-3D/2	Cable drum	52	180-24	Document holder	57
161 T-347 x 60/5	Separation sheets	52	180-34	Holder for paper reel	57
161 T-347 x 120/5	Separation sheets	52	2175 N	Machinist's vice	57
179-35	Can holder	55	2175 N-11	Washer	57
179 N-33	Paper bin	54			

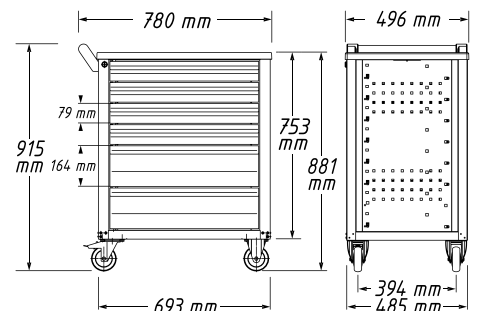
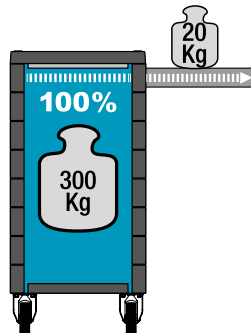
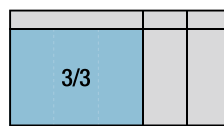

HAZET No.	L x W x H mm	79x527x348 mm	164x527x348 mm	79x527x348 mm	kg	EAN-No. 4000896+
• 4 flat and 2 high drawers 177-6	780x498x915	4x	2x	6x	62.8	148578
• 6 flat and 1 high drawer 177-7	780x498x915	6x	1x	7x	64.8	148592

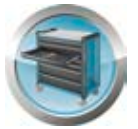

178 N Tool trolley *Assistant*

Made in Germany

• Tool trolley

- Large ball-bearing wheels (125 mm), easy manoeuvrability, even with high dynamic load
- 2 swivel castors with double stop function: fixed castors prevent inadvertent rolling of the trolley, fixed swivel bearing prevents the castors from swivelling, e.g. on inclined surfaces
- Protective ring prevents dirt and threads from getting in
- Elastic tyres enable smooth movement
- Two-stage locking concept:
 - Central locking, lockable with cylinder lock and 2 folding keys
 - Individual drawer locking prevents unwanted drawer opening
 - 100% sliding-out with roller guides
- Total loading capacity (dynamic): 480 kg
- Loading capacity (static): 480 kg
- Loading capacity of high drawer: 20 kg
- Colour: HAZET blue



The following accessories are available separately:

HAZET No.	Designation		HAZET No.	Designation	
112/11	Tool holder	50	179 N-35	Can holder	55
161-1	Anti-slipping mat	52	179 N-45	Tablet holder	56
161 N-3D/2	Cable drum	52	180-24	Document holder	57
161 T-178 N/4	Separation sheet set	53	180-34	Holder for paper reel	57
179-35	Can holder	55	180-35	Can holder	55
179 N-33	Paper bin	54			

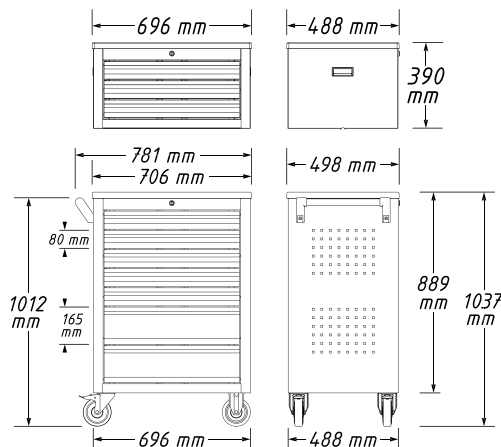
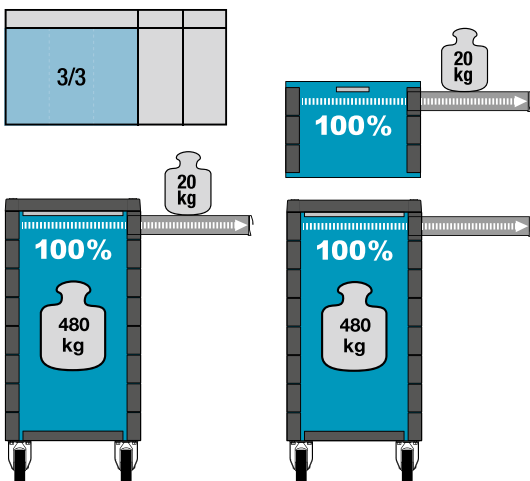

YouTube Clip





General workshop equipment

Tool trolleys *Assistant*



178 N Tool trolley *Assistant*



HAZET No.	L x W x H mm	80x527x348 mm	165x527x348 mm	kg		EAN-No. 4000896+
Tool trolley 178N-7						
<ul style="list-style-type: none"> • 5 flat drawers and 2 high drawers • Sturdy handle firmly attached to the trolley • Work surface: Plastic, resistant to solvent, with integrated storage wells • Work surface border strip prevents parts from falling down • Rectangular perforations on the side panels offer individual fastening options, e.g. for tool hooks of the article group HAZET 112 or other accessories such as can holder, holder for paper reel, paper bin, etc. 						
178 N-7	781x498x1037	5x	2x	74.1	-	202782
178N-10 consisting of tool trolley 178N-7, tool chest 178NK-3						
Tool trolley 178N-7:						
<ul style="list-style-type: none"> • 5 flat and 2 high drawers • Sturdy handle firmly attached to the trolley • Work surface: Plastic, resistant to solvent, with integrated storage wells • Work surface border strip prevents parts from falling down • Rectangular perforations on the side panels offer individual fastening options, e.g. for tool hooks of the HAZET 112 article group or other accessories such as a can holder, holder for paper reel, paper bin, etc. 						
Tool chest 178NK-3:						
<ul style="list-style-type: none"> • For <i>Assistant</i> 178N tool trolleys • 3 flat drawers • 2 sturdy handles firmly attached to the trolley • Optional: Work surface made from solvent-resistant plastic with integrated storage wells, HAZET No. 177-05 						
178 N-10	781x498x1410	8x	2x	107.8	2	202805
Tool chest 178NK-3						
<ul style="list-style-type: none"> • For <i>Assistant</i> 178N tool trolleys • 3 flat drawers • 2 sturdy handles firmly attached to the trolley • Optional: Work surface made from solvent-resistant plastic with integrated storage wells, HAZET No. 177-05 						
178 NK-3	696x488x390	3x	-	33.7	-	202799





179 N Tool trolley *Assistant*

Made in Germany

• Tool trolley



Work areas

- Much larger storage and work areas in plastic (179N) or stainless steel (179NX)
- Fully sealed work surface protects inside of trolley from leaking liquids
- Interfaces integrated in the work area for accessories such as laptop holders and top modules

Body / Pull-handle

- Extremely robust design thanks to dual-wall structure
- Complete welded construction of the entire body for tough daily workshop use
- Optimised, yielding edge protection on all four corners with real impact protection thanks to internal damping concept
- Ergonomically optimised pull handle for better manoeuvrability

Locking concept

- Ergonomically arranged side lock position for better operability protects keys and lock against damage
- Highly secure closing system with central locking technology for optimum protection of your property
- 2-stage locking
 - Central locking, lockable with cylinder lock and 2 folding keys
 - Mutual drawer locking for minimum tilting risk

Drawer concept

- Self-closing and reciprocal locking of the drawers prevents unwanted opening
- 100% sliding-out with ball-bearing telescopic slides
- Drawer design for optimum use of the interior
- Drawer fronts for optimised handling
- Dirt-resistant drawer coating for easy cleaning

High performance chassis

- Large wheels with high loading capacity, precision ball bearing and dual rounded rim in the pivot bearing, easy manoeuvrability, even with high dynamic load
- 2 swivel castors with double stop function: fixed castor prevents inadvertent rolling of the trolley, fixed swivel bearing prevents the castors from swivelling, e.g. on an inclined surface
- Protective ring prevents dirt and threads from getting in
- Elastic tyres enable smooth movement

Assistant 179N-6 – 9:

- Solvent-resistant plastic work surface
- Metal handle, powder coated in black

Assistant 179NX-6 – 8:

- Stainless steel work surface
- Extra protection through high-quality plastic end caps
- Brushed stainless steel handle
- Total loading capacity (dynamic): 540 kg
- Loading capacity (static): 1000 kg
- Loading capacity of high drawer: 25 kg
- Colour: HAZET blue

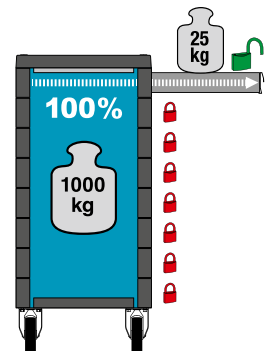
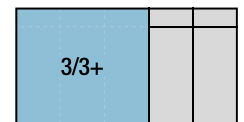

YouTube Clip

The following accessories are available separately:

HAZET No.	Designation		HAZET No.	Designation	
112/11	Tool holder	50	179 N-35	Can holder	55
161 N-3D/2	Cable drum	52	179 N-40	Basic fixture	55
161 T-179 N/4	Separation sheet set	53	179 N-42	Laptop holder - complete	55
161 T-179 N/4H	Separation sheet set	53	179 N-45	Tablet holder	56
161 T-395 x 120/5	Separation sheets	52	179 N-50	Bracket for one L-Boxx	57
161 T-395 x 60/5	Separation sheets	52	179 N-51	Bracket set for two L-Boxxes	57
179-35	Can holder	55	179 N-75	Vice fastening	57
179 N-21	Lateral door	54	180-24	Document holder	57
179 N-26	Vertical perforated tool board	56	180-34	Holder for paper reel	57
179 N-33	Paper bin	54	2175 N	Machinist's vice	57

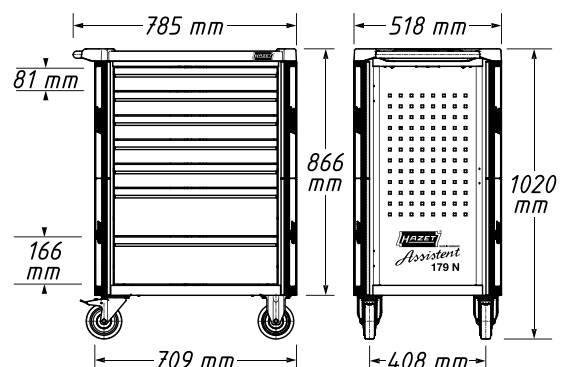



General workshop equipment

Tool trolleys *Assistant*



179 N Tool trolley *Assistant*

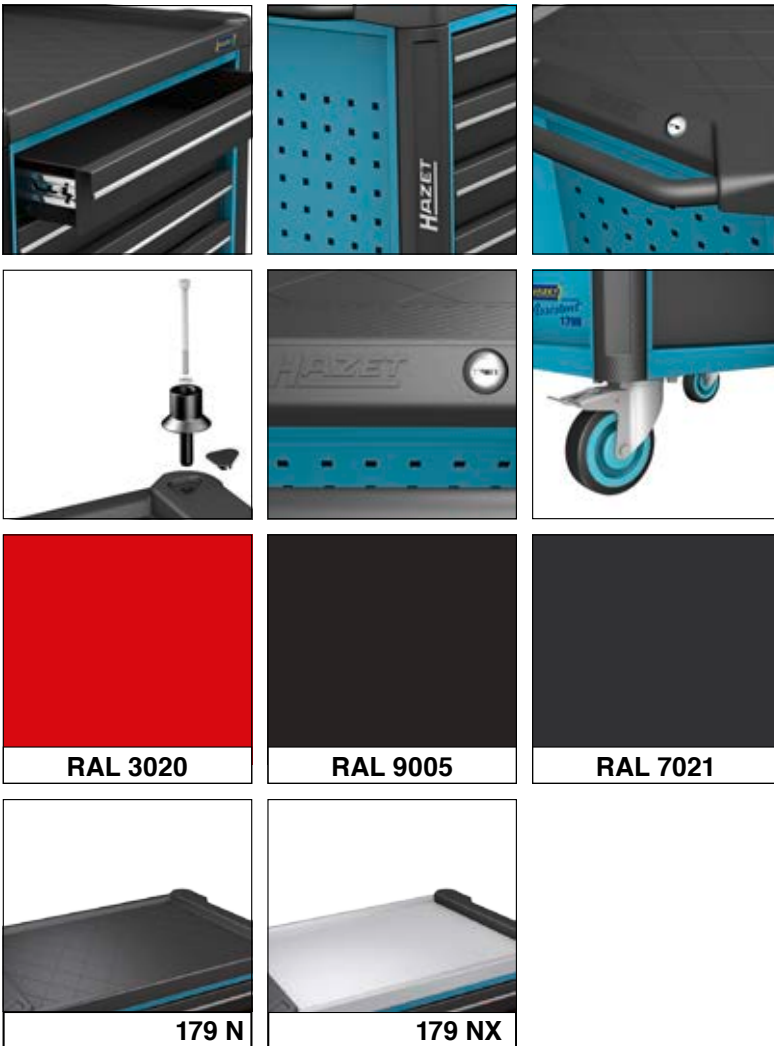

HAZET No.	L x W x H mm	81 x 522 x 398 mm		kg	EAN-No. 4000896+
		81 x 522 x 398 mm	166 x 522 x 398 mm		
• 3 flat and 3 high drawers 179 N-6	785x518x1020	3x	3x	90	214570
• 5 flat and 2 high drawers 179 N-7	785x518x1020	5x	2x	90	214488
• 5 flat and 2 high drawers • Colour RAL 3020 (red) 179 N-7-RAL 3020	785x518x1020	5x	2x	90	220212
• 5 flat and 2 high drawers • Colour RAL 9005 (matt black) 179 N-7-RAL 9005	785x518x1020	5x	2x	90	220229
• 7 flat drawers and 1 high drawer 179 N-8	785x518x1020	7x	1x	90	214587
• 7 flat drawers and 1 high drawer • Colour: RAL 7021 (black grey) 179 N-8-RAL 7021	785x518x1020	7x	1x	90	220311
• 9 flat drawers 179 N-9	785x518x1020	9x	–	90	220236
• 3 flat and 3 high drawers 179 NX-6	786x518x1020	3x	3x	90	215560
• 5 flat and 2 high drawers 179 NX-7	786x518x1020	5x	2x	90	215577
• 5 flat and 2 high drawers • Colour RAL 3020 (red) 179 NX-7-RAL 3020	786x518x1020	5x	2x	90	219322
• 7 flat drawers and 1 high drawer 179 NX-8	786x518x1020	7x	1x	90	215584

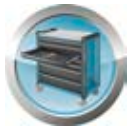

179 NXL Tool trolley *Assistant*

Made in Germany

• Tool trolley



Work areas

- Much larger storage and work areas in stainless steel
- Fully sealed work surface protects inside of trolley from leaking liquids
- Interfaces integrated in the work area for accessories such as laptop holders and top modules
- Stainless steel work surface
- Extra protection through high-quality plastic end caps

Body / Pull-handle

- Extremely robust design thanks to dual-wall structure
- Complete welded construction of the entire body for tough daily workshop use
- Optimised, yielding edge protection on all four corners with real impact protection thanks to internal damping concept
- Ergonomically optimised pull handle for better manoeuvrability
- Brushed stainless steel handle

Locking concept

- Ergonomically arranged side lock position for better operability protects keys and lock against damage
- Highly secure closing system with central locking technology for optimum protection of your property
- 2-stage locking
 - Central locking, lockable with cylinder lock and 2 folding keys
 - Mutual drawer locking for minimum tilting risk

Drawer concept

- Self-closing and reciprocal locking of the drawers prevents unwanted opening
- 100% sliding-out with ball-bearing telescopic slides
- Drawer design for optimum use of the interior
- Drawer fronts for optimised handling
- Dirt-resistant drawer coating for easy cleaning

High performance chassis

- Large wheels with high loading capacity, precision ball bearing and dual rounded rim in the pivot bearing, easy manoeuvrability, even with high dynamic load
- 2 swivel castors with double stop function: fixed castor prevents inadvertent rolling of the trolley, fixed swivel bearing prevents the castors from swivelling, e.g. on an inclined surface
- Protective ring prevents dirt and threads from getting in
- Elastic tyres enable smooth movement
- Total loading capacity (dynamic): 750 kg
- Loading capacity (static): 1000 kg
- Loading capacity of high drawer: 40 kg
- Colour: HAZET blue

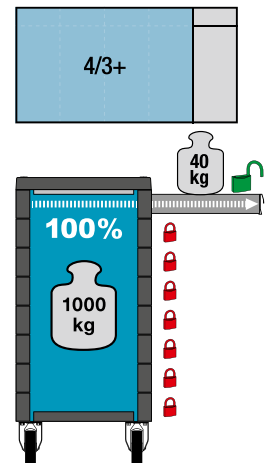

YouTube Clip

The following accessories are available separately:

HAZET No.	Designation		HAZET No.	Designation	
112/11	Tool holder	50	179 N-40	Basic fixture	55
161 N-3D/2	Cable drum	52	179 N-42	Laptop holder - complete	55
161 T-179 N XL/5	Separation sheet set	53	179 N-45	Tablet holder	56
161 T-179 N XL/5 H	Separation sheet set	53	179 N-50	Bracket for one L-Boxx	57
161 T-395 x 60/5	Separation sheets	52	179 N-51	Bracket set for two L-Boxxes	57
161 T-395 x 120/5	Separation sheets	52	179 N-510	Bracing surface for L-Boxx bracket 179N-51	57
173-38	Anti-slipping mat	54	179 N-75	Vice fastening	57
179-35	Can holder	55	179 N XL-26	Vertical perforated tool board	56
179 N-21	Lateral door	54	180-24	Document holder	57
179 N-33	Paper bin	54	180-34	Holder for paper reel	57
179 N-35	Can holder	55	2175 N	Machinist's vice	57

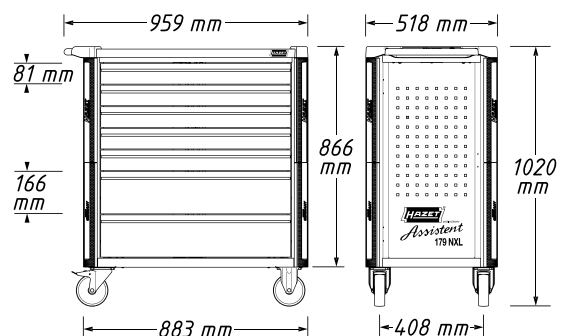



General workshop equipment



Tool trolleys *Assistant*

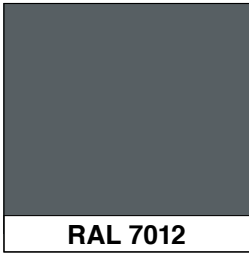

179 NXL Tool trolley *Assistant*



RAL 7012

HAZET No.	L x W x H mm	 81 x 696 x 398 mm	 166 x 696 x 398 mm	 kg	EAN-No. 4000896+
• 3 flat and 3 high drawers 179 NXL-6	959x518x1020	3x	3x	125	215171
• 5 flat and 2 high drawers 179 NXL-7	959x518x1020	5x	2x	125	215164
• 7 flat drawers and 1 high drawer 179 NXL-8	959x518x1020	7x	1x	125	215218
• 7 flat drawers and 1 high drawer • Colour RAL 7012 (basalt grey) 179 NXL-8-VW	959x518x1020	7x	1x	125	220243



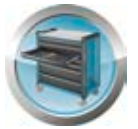

179 NXXL Tool trolley *Assistant*

Germany Made in Germany

• Tool trolley

Work areas

- Much larger storage and work areas in stainless steel
- Fully sealed work surface protects inside of trolley from leaking liquids
- Interfaces integrated in the work area for accessories such as laptop holders and top modules
- Stainless steel work surface
- Extra protection through high-quality plastic end caps

Body / Pull-handle

- Extremely robust design thanks to dual-wall structure
- Complete welded construction of the entire body for tough daily workshop use
- Optimised, yielding edge protection on all four corners with real impact protection thanks to internal damping concept
- Ergonomically optimised pull handle for better manoeuvrability
- Brushed stainless steel handle

Locking concept

- Ergonomically arranged side lock position for better operability protects keys and lock against damage
- Highly secure closing system with central locking technology for optimum protection of your property
- 2-stage locking
 - Central locking, lockable with cylinder lock and 2 folding keys
 - Mutual drawer locking for minimum tilting risk

Drawer concept

- Self-closing and reciprocal locking of the drawers prevents unwanted opening
- 100% sliding-out with ball-bearing telescopic slides
- Drawer design for optimum use of the interior
- Drawer fronts for optimised handling
- Dirt-resistant drawer coating for easy cleaning

High performance chassis

- Large wheels with high loading capacity, precision ball bearing and dual rounded rim in the pivot bearing, easy manoeuvrability, even with high dynamic load
- 2 swivel castors with double stop function: fixed castor prevents inadvertent rolling of the trolley, fixed swivel bearing prevents the castors from swivelling, e.g. on an inclined surface
- Protective ring prevents dirt and threads from getting in
- Elastic tyres enable smooth movement
- Total loading capacity (dynamic): 750 kg
- Loading capacity (static): 1000 kg
- Loading capacity of high drawer: 40 kg
- Colour: HAZET blue



YouTube Clip

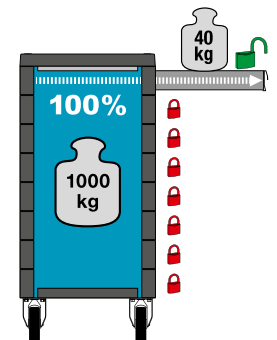
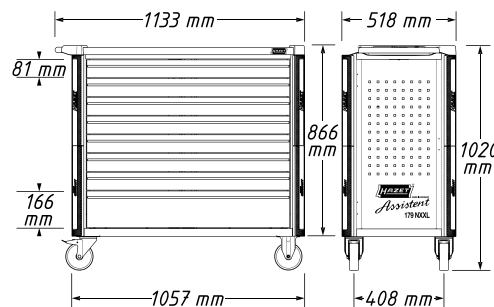
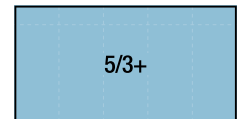

The following accessories are available separately:

HAZET No.	Designation		HAZET No.	Designation	
112/11	Tool holder	50	179 N-42	Laptop holder - complete	55
161 N-3D/2	Cable drum	52	179 N-45	Tablet holder	56
161 T-179 N XXL/6	Separation sheet set	53	179 N-50	Bracket for one L-Boxx	57
161 T-179 N XXL/6H	Separation sheet set	53	179 N-51	Bracket set for two L-Boxxes	57
161 T-395 x 60/5	Separation sheets	52	179 N-510	Bracing surface for L-Boxx bracket 179N-51	57
161 T-395 x 120/5	Separation sheets	52	179 N-75	Vice fastening	57
179-35	Can holder	55	179 NXXL-26	Vertical perforated tool board	56
179 N-21	Lateral door	54	180-24	Document holder	57
179 N-33	Paper bin	54	180-34	Holder for paper reel	57
179 N-35	Can holder	55	2175 N	Machinist's vice	57
179 N-40	Basic fixture	55			



HAZET No.	L x W x H mm	81 x 870 x 398 mm	166 x 870 x 398 mm	kg	EAN-No. 4000896+
• 5 flat and 2 high drawers 179 NXXL-7	1133x518x1020	5x	2x	145	214624
• 7 flat and 1 high drawer 179 NXXL-8	1133x518x1020	7x	1x	145	214778



General workshop equipment

Tool trolleys *Assistant*



179 NXXLD Tool trolley *Assistant*

Made in Germany

• Tool, material, and assembly trolley – extra deep

Work areas

- Much larger storage and work areas in stainless steel
- Fully sealed work surface protects inside of trolley from leaking liquids
- Interfaces integrated in the work area for accessories such as laptop holders and top modules
- Extra protection through high-quality plastic end caps

Body / Pull-handle

- Extremely robust design thanks to dual-wall structure
- Complete welded construction of the entire body for tough daily workshop use
- Optimised, yielding edge protection on all four corners with real impact protection thanks to internal damping concept
- Ergonomically optimised pull handle for better manoeuvrability
- Brushed stainless steel handle

Locking concept

- Ergonomically arranged side lock position for better operability protects keys and lock against damage
- Highly secure closing system with central locking technology for optimum protection of your property
- 2-stage locking
 - Central locking, lockable with cylinder lock and 2 folding keys
 - Mutual drawer locking for minimum tilting risk

Drawer concept

- Self-closing and reciprocal locking of the drawers prevents unwanted opening
- 100% sliding-out with ball-bearing telescopic slides
- Drawer design for optimum use of the interior
- Drawer fronts for optimised handling
- Dirt-resistant drawer coating for easy cleaning

High performance chassis

- Large wheels with high loading capacity, precision ball bearing and dual rounded rim in the pivot bearing, easy manoeuvrability, even with high dynamic load
- 2 swivel castors with double stop function: fixed castor prevents inadvertent rolling of the trolley, fixed swivel bearing prevents the castors from swivelling, e.g. on an inclined surface
- Protective ring prevents dirt and threads from getting in
- Elastic tyres enable smooth movement
- Total loading capacity (dynamic): 750 kg
- Loading capacity (static): 1000 kg
- Loading capacity of high drawer: 40 kg
- Colour: HAZET blue



YouTube Clip

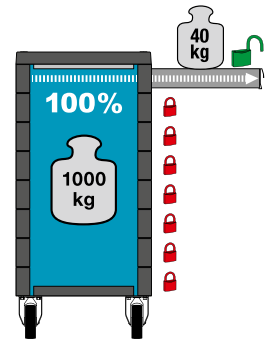
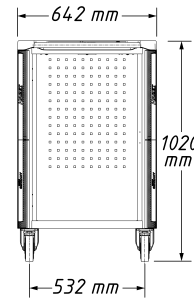
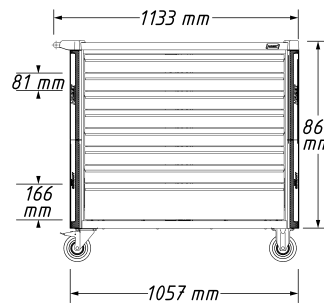
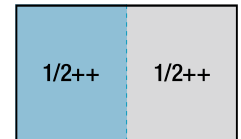

The following accessories are available separately:

HAZET No.	Designation	
112/11	Tool holder	50
161 N-3D/2	Cable drum	52
161 N-5D	Socket strip	52
161 T-179 N XXLD/6	Separation sheet set	53
161 T-179 N XXLD/6 H	Separation sheet set	53
179-35	Can holder	55
179 N-21 D	Lateral door	54
179 N-33	Paper bin	54
179 N-35	Can holder	55
179 N-40	Basic fixture	55
179 N-42	Laptop holder - complete	55

HAZET No.	Designation	
179 N-45	Tablet holder	56
179 N-50	Bracket for one L-Boxx	57
179 N-51	Bracket set for two L-Boxxes	57
179 N-510	Bracing surface for L-Boxx bracket 179N-51	57
179 N-D-75	Vice fastening	57
179 N-XXL-26	Vertical perforated tool board	56
180-24	Document holder	57
180-34	Holder for paper reel	57
180-35	Can holder	55



HAZET No.	L x W x H mm	81 x 870 x 522 mm	166 x 870 x 522 mm	kg		EAN-No. 4000896+
• 7 flat and 1 high drawers						
179 N-XXL-8D	1133x642x1020	7x	1x	146.5	-	242931
• 7 flat and 1 high drawers						
• Complete with lateral door and socket strip (without assortment)						
179 N-XXL-8D/3	1167x642x1020	7x	1x	155.5	3	245178

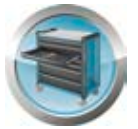

166 N Tool trolley *Assistant*

- Made in Germany**
- Tool trolley



The Original

- Space saving
- **Pillars can swing down to minimum height (500 mm)** for space saving transport. Swung down pillars can be used as carrying handle
- Lockable with padlock (including 2 keys)
- Wraparound rubber profiles protecting table board and intermediary containers from damage
- Table board with rubber mat, 2 intermediary containers (including 4 partition sheets), spacious bottom container
- 4 rubber castors with thread guard and double ball bearings, of which 2 swivel castors with brake
- Total loading capacity (dynamic): 150 kg
- Loading capacity (static): 300 kg
- Colour: HAZET blue

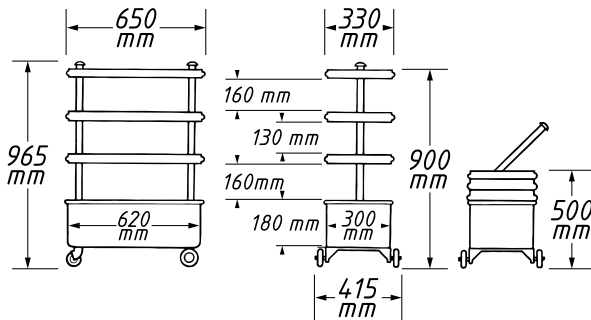

HAZET No.	L x W x H mm	kg	EAN-No. 4000896+
166 N	650x415x965	24.5	004959

166 C Tool trolley *Assistant*

- Made in Germany**
- Tool trolley



- Pillars can swing down to minimum height (647 mm) for space saving transport
- Intermediary containers suitable for HAZET plastic drawer inserts, 2 separation sheets included
- Additional sliding tray, to be integrated into the intermediary containers, e.g. for calliper gauges and small parts
- Spacious bottom container made of sheet steel
- Big castors to level out uneven ground surfaces
- **Collapsible**, lockable, padlock and 2 keys included
- Provided with wraparound protecting rubber strips
- Loading capacity (static): 300 kg
- Colour: HAZET blue

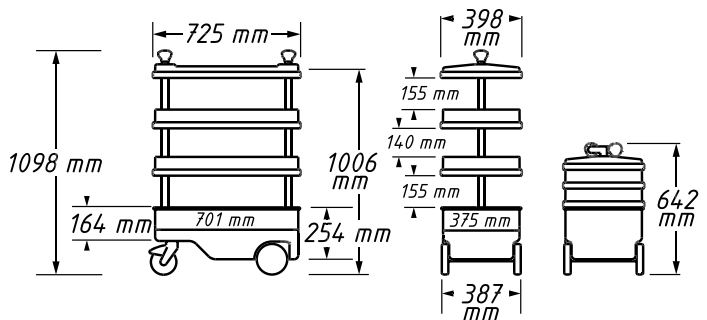
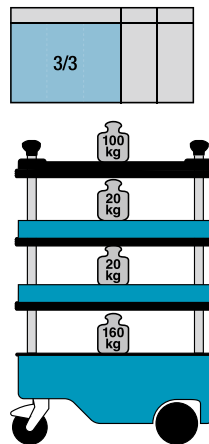

The following accessories are available separately:

HAZET No.	Designation	Book icon	HAZET No.	Designation	Book icon
161-9	Window pane holder	52	162C-6/5	Separation sheets for intermediary tray	53
162C-5	Container for small parts	54			

HAZET No.	L x W x H mm	kg	EAN-No. 4000896+
166 C	725x398x1102	27.6	072286



General workshop equipment

Tool trolleys *Assistant*



167-3 Service trolley *Assistant*

Made in Germany



• Flexible and stable for all purposes

- Adjustable in 15 height positions (middle tray)
- More layers and anti-slipping mats (2x 180-38) are optionally available
- Robust sheet steel construction, loading capacity per tray: 50 kg
- Large ball-bearing wheels (∅ 100 mm), 2 swivel castors (1x with double stop), 2 fixed castors
- Thread guard – protects the bearings against dirt and threads
- Easy manoeuvrability, even with high dynamic load
- Grey non-marking elastic tyres enable smooth movement
- Sturdy handle, firmly attached to the trolley
- For HAZET Safety-Insert-System, 2-component soft foam insert
- Loading capacity per tray: 50 kg
- Total loading capacity (dynamic): 150 kg
- Loading capacity (static): 150 kg
- Colour: HAZET blue

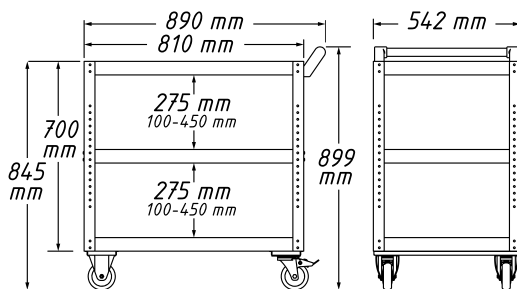

YouTube Clip



HAZET No.	L x W x H mm	EAN-No. 4000896+
167-3	890x542x899	205332





167-3S Service trolley *Assistant*

Made in Germany



- Rectangular perforation on the side panels offer individual fastening options
- Adjustable in 15 height positions (middle tray)
- More layers and anti-slipping mats (2x 180-38) are optionally available
- Robust sheet steel construction, loading capacity per tray: 50 kg
- Large ball-bearing wheels (∅ 100 mm), 2 swivel castors (1 x with double stop), 2 fixed castors
- Thread guard – protects the bearings against dirt and threads
- Easy manoeuvrability, even with high dynamic load
- Grey non-marking elastic tyres enable smooth movement
- Sturdy handle, firmly attached to the trolley
- For HAZET Safety-Insert-System, 2-component soft foam insert
- Loading capacity per tray: 50 kg
- Side fastening options for comprehensive HAZET accessories range (optional)
- Colour: HAZET blue / black side panels
- Total loading capacity (dynamic): 150 kg
- Loading capacity (static): 150 kg

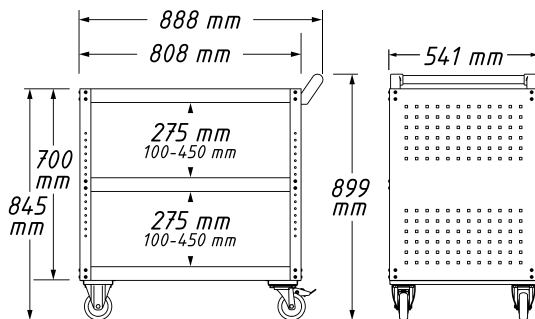
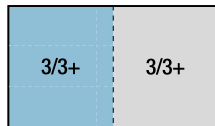

The following accessories are available separately:

HAZET No.	Designation		HAZET No.	Designation	
112/11	Tool holder	50	179 N-35	Can holder	55
161 N-3D/2	Cable drum	52	180-24	Document holder	57
179-35	Can holder	55	180-34	Holder for paper reel	57
179 N-33	Paper bin	54	180-35	Can holder	55

HAZET No.	L x W x H mm	kg	EAN-No. 4000896+
167-3S	888x541x899	27	207206

167 T Multi table *Assistant*

Made in Germany



- Sturdy ram protection on all important struts for protecting important areas, e.g. body and high quality rims
- Table can be collapsed downwards by 90°
- Adjustable in 15 height positions (steps: 25 mm)
- Robust welded design
- Ball-bearing wheels (∅ 50 mm), 4 swivel castors, 2 castors with brake
- Easy manoeuvrability, even with high dynamic load
- Grey non-marking elastic tyres enable smooth movement
- Fits under vehicles with a ground clearance greater than 130 mm
- Loading capacity of table: 35 kg
- Delivery, flat packed (h x w x d: approx. 110 x 930 x 780 mm)
- Accessories 112/11 · 179-35 · 179 N-35 · 180-24 · 180-35 only together with 167T26
- Total loading capacity (dynamic): 150 kg
- Loading capacity (static): 150 kg
- Colour: HAZET blue

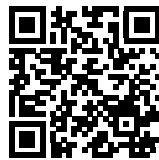

YouTube Clip

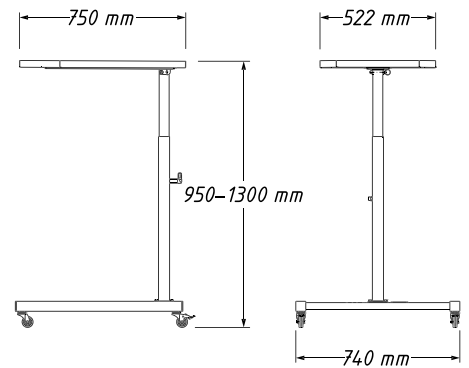
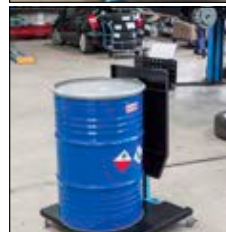

The following accessories are available separately:

HAZET No.	Designation		HAZET No.	Designation	
112/11	Tool holder	50	179-35	Can holder	55
162 C-5	Container for small parts	54	179 N-35	Can holder	55
167 T 23	Storage board	54	180-24	Document holder	57
167 T 26	Perforated tool panel	54	180-35	Can holder	55

¹⁾ Accessories only together with 167T-26

HAZET No.	L x W x H mm	kg	EAN-No. 4000896+
167 T ¹⁾	773x740x1345	17.9	210503



General workshop equipment

Work benches *Assistant* / Tool cabinets



Work benches *Assistant* / Tool cabinets

177W Mobile work bench

Made in Germany

- Large ball-bearing wheels (∅ 125 mm), easy manoeuvrability, even with high dynamic load
- 2 swivel castors with double stop function: fixed castor prevents inadvertent rolling of the trolley, fixed swivel bearing prevents the castors from swivelling, e.g. on inclined surfaces
- Protective ring prevents dirt and threads from getting in
- Grey non-marking elastic tyres enable smooth movement
- Two-stage locking concept:
 - Central locking, lockable with cylinder lock and 2 keys
 - Individual drawer locking prevents unwanted drawer opening
 - 100% sliding-out with roller guides
- Boards in the storage compartment:
 - Loading capacity top: 15 kg / bottom 35 kg
 - Storage shelves adjustable
- Optional: 177W-21: Door for right storage compartment, lockable, including 2 keys
- Total loading capacity (dynamic): 500 kg
- Loading capacity (static): 750 kg
- Worktop: Wood multiplex birch, replaceable
- Loading capacity of high drawer: 20 kg
- Colour: HAZET blue



The following accessories are available separately:

HAZET No.	Designation	
112/11	Tool holder	50
161-1	Anti-slipping mat	52
161 N-3D/2	Cable drum	52
161 T-347 x 60/5	Separation sheets	52
161 T-347 x 120/5	Separation sheets	52
177 W-21	Door	54
179-35	Can holder	55
179 N-33	Paper bin	54

HAZET No.	Designation	
179 N-35	Can holder	55
179 NW-11	Machinist's vice fastening set	57
179 W-40	Basic fixture	55
179 W-42	Laptop holder	55
180-24	Document holder	57
180-34	Holder for paper reel	57
2175 N	Machinist's vice	57

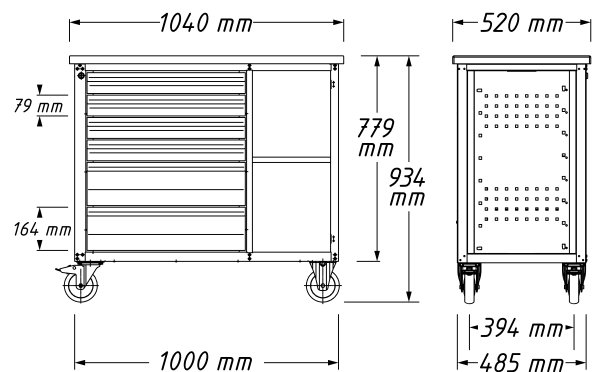
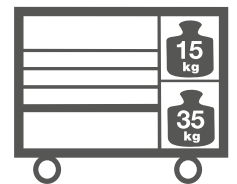
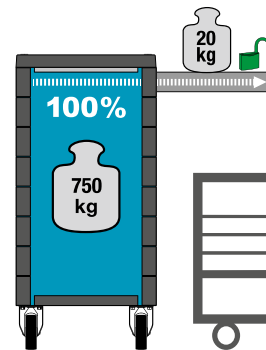
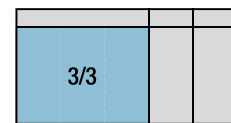

HAZET No.	L x W x H mm	79 x 527 x 348 mm	164 x 527 x 348 mm		kg	EAN-No. 4000896+
177W-6	1040x520x934	4x	2x	6x	85	154630
177W-7	1040x520x934	6x	1x	7x	85	155644



179 NW Mobile work bench

Made in Germany

• More storage space than preceding model

- 30 mm wood multiplex birch work surface, oiled, replaceable
- Including 9-fold adjustable intermediary tray and fixed mounted door
- Cable duct on rear panel allows battery devices to be charged when the door is closed, for instance
- Complete welded construction of the entire body for tough daily workshop use
- Additional rectangular perforation for tool holder, e.g. HAZET 112-230
- Optimised, yielding edge protection on all four corners with real impact protection thanks to internal damping concept
- Flexible vice assembly (front, right, left) e.g. HAZET 2175N according to drilling template specification
- **Chassis:**
 - Large wheels with high loading capacity (∅ 125 mm) with precision ball-bearing and dual ball race in the swivel bearing, easy manoeuvrability even under high dynamic load
 - 2 swivel castors with double stop function: fixed castor prevents inadvertent rolling of the trolley, fixed swivel bearing prevents the castors from swivelling, e.g. on an inclined surface
 - Protective ring prevents dirt and threads from getting in
 - Elastic tyres enable smooth movement
- **Locking concept:**
 - Mutual drawer locking for minimum tilting risk
 - Lock located in the centre (central locking and cylinder lock) closes the door and drawers at the same time
 - Only one key for locking the door and drawers at the same time (Included in delivery: 2 keys)
 - 180° rotation, prevents the key from breaking off
 - Slides out completely by means of ball-bearing, self-closing telescopic rails
- 1 heavy duty drawer, loading capacity 40 kg, 166 mm high
- 6 drawers, loading capacity 25 kg, 81 mm high
- 2 work surfaces in the storage compartment, top: 15 kg / bottom: 35 kg
- Total loading capacity (dynamic): 750 kg
- Loading capacity (static): 1000 kg
- Worktop: Wood multiplex birch, replaceable
- Colour: HAZET blue



The following accessories are available separately:

HAZET No.	Designation		HAZET No.	Designation	
112/11	Tool holder	50	179 N-510	Bracing surface for L-Boxx bracket 179N-51	57
161 N-3D/2	Cable drum	52	179 NW-11	Machinist's vice fastening set	57
161 T-179 N/4	Separation sheet set	53	179 NW-22	Shelf drawer	56
161 T-179 N/4 H	Separation sheet set	53	179 NW-23	Tray	56
161 T-395 x 60/5	Separation sheets	52	179 NW-26	Vertical tool panel	56
161 T-395 x 120/5	Separation sheets	52	179 W-40	Basic fixture	55
179-35	Can holder	55	179 W-42	Laptop holder	55
179 N-33	Paper bin	54	180-24	Document holder	57
179 N-35	Can holder	55	180-34	Holder for paper reel	57
179 N-50	Bracket for one L-Boxx	57	180-35	Can holder	55
179 N-51	Bracket set for two L-Boxxes	57	2175 N	Machinist's vice	57

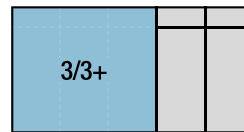

YouTube Clip

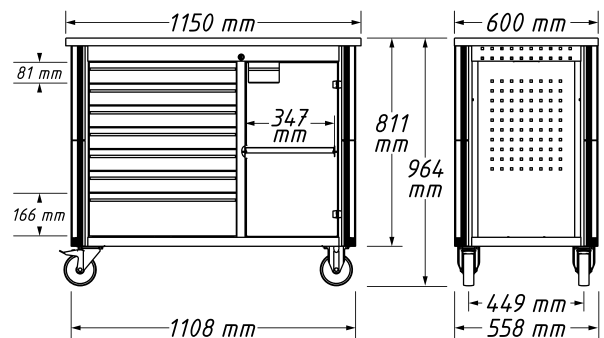
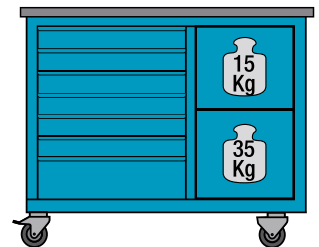
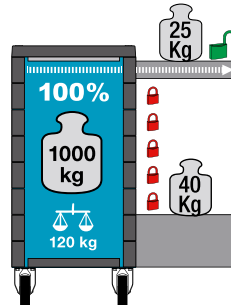

HAZET No.	L x W x H mm				EAN-No. 4000896+
179 NW-7	1150x600x964	6x	1x	120	219629



General workshop equipment

Work benches *Assistant* / Tool cabinets



130 Work bench

Made in Germany

- 40 mm thick multi-layer beechwood board
- Front steel lining
- Structurally sound due to stable steel framework
- Loading capacity (static): 1000 kg



HAZET No.	L x W x H mm	kg	EAN-No. 4000896+
130-1	2000x760x845	89	003358

111 L Tool cabinet

Made in Germany

- Blind, lockable
- Including padlock with 2 keys
- Including suspension device
- Empty, for individual tool assortment

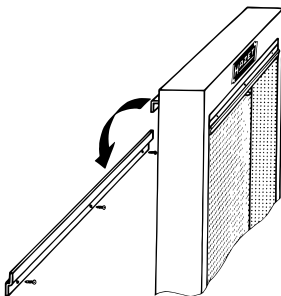

HAZET No.	L x W x H mm	kg	EAN-No. 4000896+
111 L	640x250x1000	27	003266

111 Tool cabinet · with assortment

- Suspension plan and tool holders and soft foam inserts for socket sets



111 Tool cabinet · with assortment



111 L



111/116 HL



603 •

6 • 7 • 8 • 9

603 •

10 • 11 • 12 • 13 • 14
15 • 16 • 17 • 18 • 19
21 • 22 • 24



630 •

6x7 • 8x9 • 10x11
12x13 • 14x15 • 16x17
18x19 • 20x22 • 21x23
24x27 • 30x32

730

730-3 • 730-6

746-1

748 B

748 B-3 • 748 B-4

748 B-5 • 748 B-6

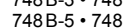

760 N

760 N-1 • 760 N-2

760 N-3

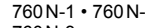

802 •

0.8x4 • 1x5.5

1.2x8 • 1.6x10

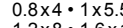

802-PH •

PH1 • PH2

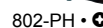

802-PZ •

PZ1 • PZ2



824 •

0.5x23



850 •

4 • 4.5 • 5 • 5.5

6 • 7 • 8 • 9

10 • 11



863 HP •

1/4



867-2 •

1/4 • 1/4



868 •

1/4 • 1/4



869 •

1/4 • 1/4



900 •

1/2

10 • 11 • 12 • 13 • 14

15 • 16 • 17 • 18 • 19

20 • 21 • 22 • 23 • 24

26 • 27 • 28 • 30 • 32



915 •

1/2

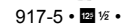

916 HP •

1/2



917-5 •

1/2 • 1/2



918-10 •

1/2 • 1/2



920 •

1/2 • 1/2



985 •

1/2

5 • 6 • 8 • 10

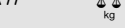

1802-11



1841 A-22



1845 A-19



1845 C-19



1952-35



1980 N

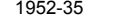

1981



2100/7 R •



2115-T/7 R •

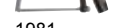

2120-8



2122-8



2123-8



2140-50



2154 N-3

HAZET No.	L x W x H mm	kg	HiPer inside	EAN-No. 4000896+
111/116	640x250x1000	46.4	116	003105

111 Tool holder

Made in Germany

- For 116-pc. tool assortment
- 0-111/116



HAZET No.	kg	HiPer inside	EAN-No. 4000896+
111/116 HL	0.9	14	003112



0-111 Tool assortment

- 116 pieces contents see assortment 111/116,
- Without cabinet



HAZET No.	kg		EAN-No. 4000896+
0-111/116	17	116	000098

111 Tool holder

Made in Germany



HAZET No.	EAN-No. 4000896+
• Holder, for e.g. 630-6x7 up to -20x22, to be used with 111-03L	
111-03 R	002849
• Hanger, to be used with 111-03R	
111-03 L	002832
• Holder, for 4 $\frac{1}{2}$ sockets	
111-04	002856
• Hanger, for e.g. chisels 730-3 up to -6, centre punch 746-1, drift pin 748	
111-05	002863

Made in Germany



HAZET No.	EAN-No. 4000896+
• Hook, for e.g. 279, 760N, 2100/7R etc.	
111-06	002870
• Hanger, for e.g. combination wrenches 603 or hammers 2140 etc.	
111-10	002917
• Holder, for e.g. tape measures	
111-15	002962

Made in Germany



111 Tool holder

HAZET No.	EAN-No. 4000896+
• Tool hanger \varnothing 6 mm, length 75 mm	
111-21	003020
• Tool hanger	
111-22	003037
• Tapping screw	
111-28	003099

112 Tool holder

- Installation on perforated tool panels with rectangular perforation

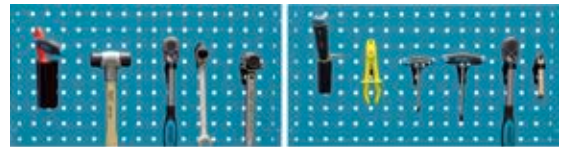

HAZET No.	EAN-No. 4000896+
• Double hook, 30 mm long, e.g. for tools with T-handle	
112-230	103898
• Double hook, 60 mm long, e.g. for tools with T-handle	
112-260	103881
• Hanger, 25 mm long, e.g. for tools with hanging hole	
112-325	103874
• Hanger, 50 mm long, e.g. for tools with hanging hole	
112-350	103867
• Double hook, wide, 40 mm long, e.g. for torque wrenches	
112-440	103850
• Double hook, wide, 50 mm long, e.g. for torque wrenches	
112-450	103843
• Staple, \varnothing 12 mm, e.g. for reversible ratchets from series 863 · 6.3 mm ($\frac{1}{4}$ inch)	
112-612	103836
• Staple, \varnothing 18 mm, e.g. for reversible ratchets from series 8816 · 10 mm ($\frac{3}{8}$ inch)	
112-618	103720
• Staple, \varnothing 24 mm, e.g. for reversible ratchets from series 916 · 12.5 mm ($\frac{1}{2}$ inch)	
112-624	103713
• Plastic cup, \varnothing 30 mm, 80 mm high, e.g. for pins, centre punches etc.	
112-830	103706
• Plastic cup, \varnothing 50 mm, 114 mm high, e.g. for marking tool 2150-1 or similar	
112-850	103690
• Tool holder set	
• For tool trolleys <i>Assistant</i> 167-3S · 167T (together with 167T26) · 167XXL · 177 · 178 · 178N · 179 · 179T · 179-10 · 179AXXL · 179BIG-1 · 179N · 179NT · 179NX · 179NXL · 179NXXL · 179NXXL-8D · 179TXXL · 179XL · 179XXL · 180 · 180K-4 and work bench <i>Assistant</i> 177W · 179W · 179NW	
Contents: 112-230 · 260 · 325 · 350 · 440 · 450 · 612 · 618 · 624 · 830 · 850	
112/11	11 104239



General workshop equipment

Work benches *Assistant* / Tool cabinets



2025 X Tool holder

- Universal clamping rails 
- Handy storage for any kind of tools
- Rail with 2 long holes allowing variable fixation even on perforated sheet metal displays
- Two flexible clamps embrace each tool without damaging it
- Flexible clamps made of oil resisting and antifreezing plastic, **flexible, durable**
- Rail made of anodized light metal



HAZET No.	l mm	EAN-No. 4000896+
• 20 clamping brackets 2025 X	440	010301
• 6 clamping brackets 2025 X-1	150	010424

2025 X Tool hangers and guiding rails

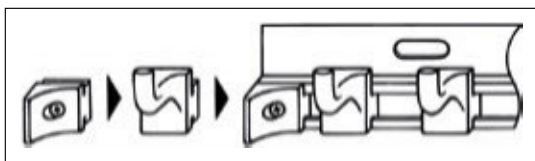

HAZET No.	l mm	□	EAN-No. 4000896+
• Guiding rail, complete, with three tool hangers			
• 150 mm long			
• Wall mounting			
2025 X-6/4	–	4	058259
• Tool hanger, self-locking,			
• Variable insertion into guiding rails 2025X-5 and 2025X-6			
2025 X-06	–	–	010394
• Guiding rail for above tool hanger			
2025 X-5	440	–	010479
2025 X-6	150	–	010486





Tool trolley / Work bench accessories

161 T Separation sheets

Made in Germany

• For HAZET *Assistant*



HAZET No.		EAN-No. 4000896+
<ul style="list-style-type: none"> • Separation sheets, 5 pieces, for flat drawers • For <i>Assistant</i> 177 tool trolley and the <i>Assistant</i> 177W work bench • L 347 x H 60 mm 		
161 T-347 x 60/5	5	120758
<ul style="list-style-type: none"> • Separation sheets, 5 pieces, for high drawers • For <i>Assistant</i> 177 tool trolley and the <i>Assistant</i> 177W work bench • L 347 x H 120 mm 		
161 T-347 x 120/5	5	120765
<ul style="list-style-type: none"> • Separation sheets, 5 pieces, for flat drawers • For tool trolley <i>Assistant</i> 179N · 179NX · 179NXL · 179NXXL and work bench <i>Assistant</i> 179NW • L 395 x H 60 mm 		
161 T-395 x 60/5	5	226931
<ul style="list-style-type: none"> • Separation sheets, 5 pieces, for high drawers • For tool trolley <i>Assistant</i> 179N · 179NX · 179NXL · 179NXXL and work bench <i>Assistant</i> 179NW • L 395 x H 120 mm 		
161 T-395 x 120/5	5	226948

173 Anti-slipping mat



HAZET No.		EAN-No. 4000896+
<ul style="list-style-type: none"> • Anti-slipping mat • For <i>Assistant</i> 173 · 179XL · 179NXL tool trolleys • L 694 x W 395 mm 		
173-38	0.15	089789
<ul style="list-style-type: none"> • Anti-slipping mat • For <i>Assistant</i> 179 · 179-10 · 179BIG-1 · 180 · 180K-4 tool trolleys and <i>Assistant</i> 179W work bench • L 529 x W 394 mm 		
180-38	0.1	120819
<ul style="list-style-type: none"> • Anti-slipping mat • For <i>Assistant</i> 168 · 169N · 174 · 176 · 177 · 178 · 178N(K) tool trolleys and <i>Assistant</i> 177W work bench • L 523 x W 348 mm 		
161-1	0.11	058884

161 Window pane holder

Made in Germany

- **Window pane holder** with hinge and swivelling suction cups 120 mm Ø,
- For *Assistant* 162C · 162N · 166C · 166N · 171 · 172HD · 176 · 178 · 179 · 180 und 180K-4
- **Please use in pairs**



HAZET No.	EAN-No. 4000896+
161-9	004867

161 N Cable drum



HAZET No.	EAN-No. 4000896+
<ul style="list-style-type: none"> • Cable drum without holder • Additional holder 161 N-3 HL required for installing on workshop trolleys, etc. • For tool trolley <i>Assistant</i> 167-3S · 177 · 178N · 179N · 179NX · 179NXL · 179NXXL · 179NXXL-8D and work bench 177W · 179W · 179NW • Cable length: 10 m • Cable quality: H07RN-F 3G1,5 • 230 V safety plug • 4 power outlets 230 V/16 A, max 3500 W • Thermal switch 	
161 N-3D	237517
<ul style="list-style-type: none"> • Cable drum with holder • For tool trolley <i>Assistant</i> 167-3S · 177 · 178N · 179N · 179NX · 179NXL · 179NXXL · 179NXXL-8D and work bench 177W · 179W · 179NW • Cable length: 10 m • Cable quality: H07RN-F 3G1,5 • 230 V safety plug • 4 power outlets 230 V/16 A, max 3500 W • Thermal switch 	
161 N-3D/2	237654

161 N Socket strip

- **Socket strip**
- Can be integrated in the right side panel of *Assistant* 179NXXL-8D
- Toggle switch for interrupting the power supply
- 3-way protective earth socket strip 230V, 50/60 Hz
- 4 USB ports (4x 2.1 A)
- Cable length: 205 cm



HAZET No.	l mm	EAN-No. 4000896+
161 N-5D	325	245161



General workshop equipment

Tool trolley / Work bench accessories



Tool trolley accessories

HAZET
No.

EAN-No.
4000896+



- Separation sheet set, 4 pieces, for flat drawers
- For HAZET *Assistant* 174 · 178N-7 · 178NK-3 tool trolleys

161 T-178 N/4

206384



- Separation sheet set, 4 pieces, for flat drawers
- For *Assistant* 179N · 179NT · 179NX tool trolleys and the *Assistant* 179NW work bench
- L 516xH 58 mm

161 T-179 N/4

215485



- Separation sheet set, 4 pieces, for high drawers
- For *Assistant* 179N · 179NT · 179NX tool trolleys and the *Assistant* 179NW work bench
- L 516xH 118 mm

161 T-179 N/4H

226979



- Separation sheet set, 5 pieces, for flat drawers
- For the *Assistant* 179NXL tool trolley
- L 688xH 58 mm

161 T-179 NXL/5

215492



- Separation sheet set, 5 pieces, for high drawers
- For the *Assistant* 179NXL tool trolley
- L 688xH 118 mm

161 T-179 NXL/5H

226962



- Separation sheet set, 6 pieces, for flat drawers
- For *Assistant* 179NXXL tool trolley
- L 863xH 58 mm

161 T-179 NXXL/6

215508

Tool trolley accessories

HAZET
No.

EAN-No.
4000896+



- Separation sheet set, 6 pieces, for high drawers
- For *Assistant* 179NXXL tool trolley
- L 863xH 118 mm

161 T-179 NXXL/6H

226955



- Separation sheet set, 6 pieces, for flat drawers
- For tool trolley *Assistant* 179NXXL-8D
- L 519xH 50.5 mm

161 T-179 NXXLD/6

255108



- Separation sheet set, 6 pieces, for high drawers
- For tool trolley *Assistant* 179NXXL-8D
- L 519xH 110.5 mm

161 T-179 NXXLD/6H

255085



- Separation sheet for intermediary tray
- For HAZET *Assistant* 162C and 166C tool trolleys

162 C-6

079810



- Separation sheets, 5 pieces for intermediary tray
- For *Assistant* 162C · 166C tool trolleys

162 C-6/5

120772



- Separation sheets, flat, 5 pieces
- For *Assistant* 173 · 179 · 179-10 · 179BIG · 179XL · 179XXL · 179A XXL · 179T XXL · 180 · 180K-4 tool trolleys and the *Assistant* 179W work bench
- H 60 x L 397 mm (for flat drawers)

173-31/5

090150



Tool trolley accessories

HAZET No. EAN-No. 4000896+



- Separation sheet set · high, 5 pieces
 - For *Assistant* 173 · 179 · 179-10 · 179BIG · 179XL · 179XXL · 179A XXL · 179T XXL · 180 tool trolleys and the *Assistant* 179W work bench
 - L 397 x H 120 mm (for high drawers)
- 173-32/5** 120796



- Storage board
 - For *Assistant* 167T tool trolley
- 167 T 23** 209972



- Perforated tool panel
 - For *Assistant* 167T tool trolley
- 167 T 26** 209996



- Anti-slipping mat
 - For *Assistant* 173 · 179XL · 179NXL tool trolleys
 - L 694 x W 395 mm
- 173-38** 089789



- Anti-slipping mat
 - For *Assistant* 179 · 179-10 · 179BIG-1 · 180 · 180K-4 tool trolleys and *Assistant* 179W work bench
 - L 529 x W 394 mm
- 180-38** 120819



- Container for small parts
 - For HAZET *Assistant* 162C · 166C · 167T tool trolleys
- 162 C-5** 078189

Tool trolley accessories

HAZET No. EAN-No. 4000896+



- Door, lockable
 - For right side
 - For the *Assistant* 177W work bench
- 177 W-21** 154739



- Lateral door, lockable
 - For left or right side panel on *Assistant* 179N · 179NX · 179NXL and 179NXXL
 - 90 mm clear depth, approx. 770 mm usable height
 - Including 2 keys
- 179 N-21** 215553



- Lateral door, lockable
 - For left or right side panel on *Assistant* 179NXXL-8D
 - 90 mm clear depth, approx. 770 mm usable height
 - Including 2 keys
 - Cable opening in the door (above and below)
- 179 N-21 D** 245154



- Paper bin
 - For tool trolleys *Assistant* 167-3S · 177 · 178N · 179N · 179NX · 179NXL · 179NXXL · 179NXXL-8D and work benches *Assistant* 177W · 179W · 179NW
- 179 N-33** 236206



General workshop equipment

Tool trolley / Work bench accessories



Tool trolley accessories

HAZET
No.

EAN-No.
4000896+



- **Can holder**, for 3 cans
- For tool trolleys *Assistant* 167-3S · 167T (together with 167T 26) · 177 · 178N · 179N · 179NX · 179NXL · 179NXXL · 179NXXL-8D and work benches *Assistant* 177W · 179NW as well as behind doors 179-21 and 179N-21

179-35

141074



- **Can holder**, for at least 4 cans
- For hole pattern of side panels *Assistant* 167-3S · 167T (together with 167T26) · 177 · 178N · 179 · 179XL · 179XXL · 179BIG · 179N · 179NX · 179NXL · 179NXXL · 179NXXL-8D and work bench *Assistant* 177W · 179W · 179NW
- Fits behind the 179 N-21 door
- Easy-to-clean due to smooth coating
- Square perforation for additional hooks
- Simple assembly due to attachment function including securing with locking clip

179 N-35

224258



- **Can holder**, for 4 cans
- Includes installation kit for tool trolleys *Assistant* 167-3S · 167T (together with 167T26) · 178N · 179NXXL-8D and the work bench *Assistant* 179NW
- No additional adapter necessary for hooking into the rectangular perforation

180-35

120826



- **Basic fixture**
- For *Assistant* 179 · 179XL · 179XXL tool trolleys
- For screens
- As per Vesa 75 and 100
- Loading capacity: 5 kg

179-40

219575

Tool trolley accessories

HAZET
No.

EAN-No.
4000896+



- **Basic fixture**
- For tool trolleys *Assistant* 179N · 179NX · 179NXL · 179NXXL · 179NXXL-8D
- For screens
- As per Vesa 75 and 100
- Loading capacity: 5 kg

179 N-40

215591



- **Basic fixture**
- For *Assistant* 177W · 179W · 179NW work benches
- For screens
- As per Vesa 75 and 100
- Loading capacity: 5 kg

179 W-40

219568



- **Laptop holder**
- For tool trolleys *Assistant* 179N · 179NX · 179NXL · 179NXXL · 179NXXL-8D
- Loading capacity: 5 kg
- As per Vesa 75 and 100
- Hook-and-loop strip for securing the laptop included in delivery

179 N-42

215621



- **Laptop holder**
- For work benches *Assistant* 177W · 179W · 179NW
- Loading capacity: 5 kg
- As per Vesa 75 and 100

179 W-42

219551



Tool trolley accessories

1) Observe application note

HAZET No. EAN-No. 4000896+



• Tray holder

- For tool trolleys *Assistant* 177 · 178N · 179N · 179NX · 179NXL · 179NXXL · 179NXXL-8D and work bench *Assistant* 177W
- Secure tensioning mechanism works for all standard tablet/PC models between 120 and 222 mm
- Universally suitable for Apple iPad · mini · Air · Pro, Amazon Kindle · Fire, Samsung Galaxy Tab, Google Nexus, Asus Transformer, Microsoft Surface
Use of tablets with protective cover or case is possible
- Clamp draw spring enables quick insertion and removal
- General clamping jaws with integrated foam rubber pad guarantee secure hold without damaging the device
- Adjustable bracket with felt pad and rubber cap for additional security when the tablet holder is positioned vertically – Prevents the tool from falling out
- Individually adjustable clamping jaws – the operating controls on the device are in no way functionally impaired
- Quick switch between profile and landscape formats, undesired turning is not possible
- Mounting on round pipes (maximum 30 mm) and worktops possible
The bracket is fixed using a clamping screw

179N-45¹⁾ 224210



- **Supplementary storage drawer**, for right storage compartment
- For work bench *Assistant* 179NW
- Dimensions (inner) W 318xD 398xH 77 mm
- 25 kg loading capacity with self-retraction

179NW-22 219636



- **Tray**
- For work bench *Assistant* 179NW
- Flexible installation into the right storage compartment
- Loading capacity 15 kg
- Including 4 screws

179NW-23 220199

Tool trolley accessories

HAZET No. EAN-No. 4000896+

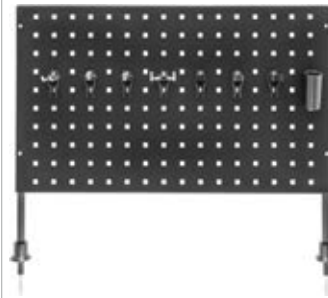

- **Vertical tool panel**
- Attachable to *Assistant* 179N · 179NX tool trolleys
- Holds additional tools
- Assortment of holders included 112-260 · 112-325 · 112-350 · 112-450 · 112-612 · 112-618 · 112-624 · 112-830

179N-26 215522



- **Vertical tool panel**
- Can be screwed onto workbench *Assistant* 179NW
- Holds additional tools
- Assortment of 8 holders included: 112-260 · 325 · 350 · 450 · 612 · 618 · 624 · 830
- Number of perforations: 336
- L 1150xW 10xH 510 mm

179NW-26 219612

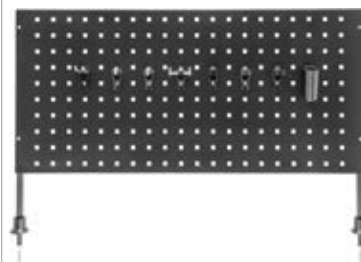

- **Vertical tool panel**
- Attachable to *Assistant* 179NXL tool trolleys
- Holds additional tools
- Assortment of holders included 112-260 · 112-325 · 112-350 · 112-450 · 112-612 · 112-618 · 112-624 · 112-830

179NXL-26 215539

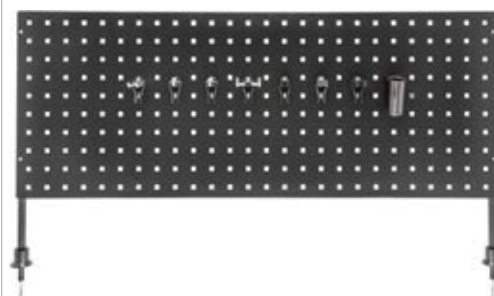

- **Vertical tool panel**
- Attachable to tool trolleys *Assistant* 179NXXL · 179NXXL-8D
- Holds additional tools
- Assortment of holders included 112-260 · 112-325 · 112-350 · 112-450 · 112-612 · 112-618 · 112-624 · 112-830

179NXXL-26 215546



General workshop equipment

Tool trolley / Work bench accessories



Tool trolley accessories

HAZET No.

EAN-No. 4000896+



- **Document holder**, for working papers
- For tool trolleys *Assistant* 167T (together with 167T26) · 167-3S · 177 · 178N · 179N · 179NX · 179NXL · 179NXXL · 179NXXL-8D and work benches *Assistant* 177W · 179NW

180-24

110827



- **Holder for paper reel**
- For tool trolleys *Assistant* 167-3S · 177 · 178N · 179N · 179NX · 179NXL · 179NXXL · 179NXXL-8D and work benches *Assistant* 177W · 179NW
- Includes installation kit (without paper reel)
- For paper reels up to maximum 350 mm Ø and maximum 280 mm width

180-34

120840



- **Machinist's vice**
- Drop forged
- Gripping jaw width: 100 mm
- Installation on *Assistant* 177W · 179W · 179NW work benches together with 179NW-11 machinist's vice fastening set Assembly on *Assistant* 177 tool trolleys together with 2175N-11 wooden liner
- For assembly on *Assistant* 179N · 179NX · 179NT · 179NXL · 179NXXL model year 01/07/2019 tool trolleys → together with 179N-75 vice fastening

2175 N

013685



- **Distance plate** (wooden) for machinist's vice 2175N
- Installation of the vice on work benches or tool trolleys *Assistant* 172HD · 177 · 180 · 180K-4
- Including installation accessories

2175N-11

013692



- **Machinist's vice fastening set** for simple assembly of the HAZET 2175N vice on wooden work bench plates
- For work bench *Assistant* 177W · 179W · 179NW
- Use of the on-site fastening points

179NW-11

221967

Tool trolley accessories

HAZET No.

EAN-No. 4000896+



- **Vice fastening** for machinist's vice 2175N
- For *Assistant* 179N · 179NX · 179NXL · 179NXXL model year 1/7/2019 tool trolleys
- Easy installation on the worktop of the right side of the trolley
- Includes fixing materials (screws and discs) for vice 2175N
- Easy installation of the door 179N-21, the laptop holder 179W-42 and the basic fixture 179W-40 when the vice is installed

179 N-75

241835



- **Vice fastening** for machinist's vice 2175N
- For tool trolley *Assistant* 179NXXLD
- Easy installation on the worktop of the right side of the trolley
- Includes fixing materials (screws and discs) for vice 2175N

179 N-D-75

252343



- **Bracket for an L-Boxx**
- For attachment to tool trolleys *Assistant* 179N · 179NX · 179NXL · 179NXXL · 179NW · 179NXXL-8D

179 N-50

243068



- **Bracket set** for two L-Boxes
- Bracket with two bracing surfaces
- For attachment to tool trolleys *Assistant* 179 · 179XL · 179XXL · 179N · 179NX · 179NXL · 179NXXL · 179NXXL-8D · 179NW
- Optionally extendable with 179N-510 for three L-Boxes
- Contents:
 - 1x bracket
 - 2x bracing surfaces (179N-510)

179 N-51

243051



- **Bracing surface** for L-Boxx bracket 179N-51
- Bracing surface for installing a third L-Boxx on L-Boxx bracket 179N-51
- Installation only on tool trolleys *Assistant* 179XL · 179XXL · 179NXL · 179NXXL · 179NW · 179NXXL-8D

179 N-510

243075

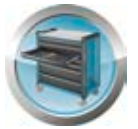

Tool trolleys *Assistant* with assortment

177 Tool trolley *Assistant* with assortment

• Tool trolley

HiPer inside

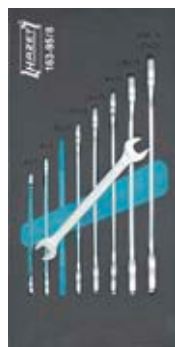
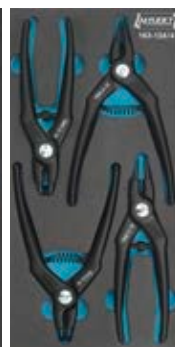
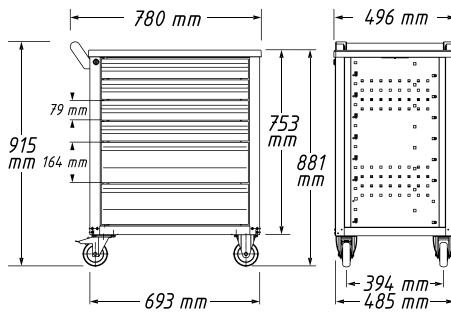
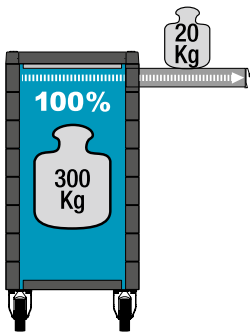
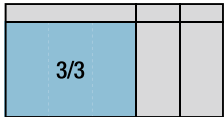



General workshop equipment

Tool trolleys *Assistent* with assortment



177 Tool trolley *Assistent* · with assortment



177-7



163-95/8 · ●

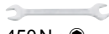

450N · ●
6x7 · 8x9 · 10x11
12x13 · 14x15 · 16x17
18x19 · 21x22

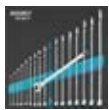

163-98/17



600N · ●
6 · 7 · 8 · 9 · 10
11 · 12 · 13 · 14 · 15
16 · 17 · 18 · 19 · 21
22 · 24



163-124/4



1845A-19



1845B-19



1845C-19



1845D-19



163-182/9



828-T · ●
T 6 · T 7 · T 8
T 9 · T 10 · T 15
T 20 · T 25 · T 30



163-192/24 · ●, ○
1/2, 3/4



850E · ●, ○, 1/4
E 5 · E 6 · E 7 · E 8 · E 10



8502 · ●, ○, 1/4
T 10 · T 15 · T 20 · T 25
T 27 · T 30 · T 40



900E · ●, ○, 1/2
E 10 · E 12 · E 14
E 16 · E 18 · E 20



992 · ●, ○, 1/2
T 30 · T 40 · T 45
T 50 · T 55



2115-T/7R · ●



163-224/57
●, ○, ○, ○, ○, ○
1/2, 3/4, 1/2



810SPC-6.3 · ●, ○



850 · ●, ○, 1/4
5.5 · 6 · 7 · 8 · 9
10 · 11 · 12 · 13



863HP · ●, 1/4



867-2 · ●, 1/4, 3/4



868 · ●, 1/4, 3/4



869 · ●, 1/4, 3/4



900 · ●, ○, 1/2
10 · 11 · 12 · 13 · 14
15 · 16 · 17 · 18 · 19
20 · 21 · 22 · 23 · 24
26 · 27 · 28 · 30 · 32



915 · ●, 1/2



916HP · ●, 1/2

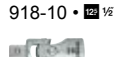

917-5 · ●, 1/2, 3/4

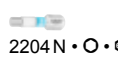

918-10 · ●, 1/2, 3/4

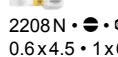

920 · ●, 1/2, 3/4

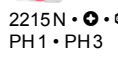

2204N · ○, ○, ○

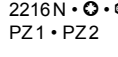

2208N · ●, ○, ○
0.6x4.5 · 1x6 · 1.2x6.5

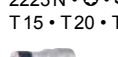

2215N · ●, ○, ○
PH 1 · PH 3



2216N · ●, ○, ○
PZ 1 · PZ 2



2223N · ●, ○, ○
T 15 · T 20 · T 25 · T 30



2250-1 · ●, ○, 1/4



2304N · ●, 1/4, ○



163-269/3



1859SPC/3



163-297/26 · ●, ○, ○, ○



810U-1/5 · ●, ○

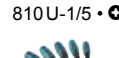

810/6 · ●, ○



810T/6 · ○



2105LG/9H · ○



163-299/8

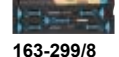

730

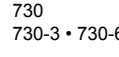

730-3 · 730-6



751HS/5



2140-50



2128N-1



2240N/36
●, ○, ○, ○, ○, ○, ○

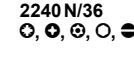

2204N · ○, ○, ○
3 · 4 · 5 · 6 · 8

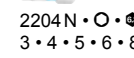

2208N · ●, ○, ○
0.6x4.5 · 1x6 · 1.2x6.5

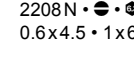

2215N · ●, ○, ○
PH 1 · PH 3

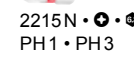

2216N · ●, ○, ○
PZ 1 · PZ 2

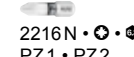

2223N · ●, ○, ○
T 10 · T 15 · T 20 · T 25
T 27 · T 30 · T 40

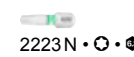

2223N · ●, ○, ○
T 20H · T 30H

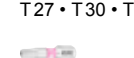

2239N-6 · ●, ○, ○

HAZET No.	L x W x H mm	79x527x348 mm	164x527x348 mm		kg		EAN-No. 4000896+
<ul style="list-style-type: none"> • 6 flat drawers and 1 high drawer • Complete with 217-piece tool assortment in Safety-Insert-System soft foam insert 							
177-7/217	780x498x915	6x	1x	7x	62.8	217	202461
177-7	780x498x915	6x	1x	7x	64.8	-	148592
<ul style="list-style-type: none"> • Tool assortment • In soft foam insert Safety-Insert-System 							
0-6/217	-	-	-	-	-	217	190492

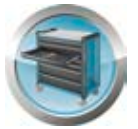

178 N Tool trolley *Assistant*

• Tool trolley

HiPer Inside

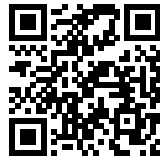

YouTube Clip

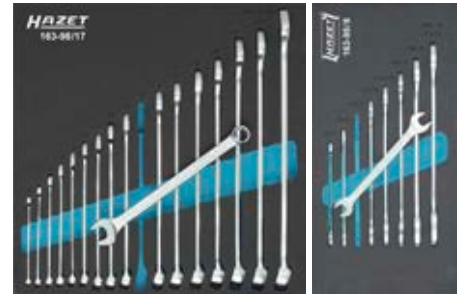
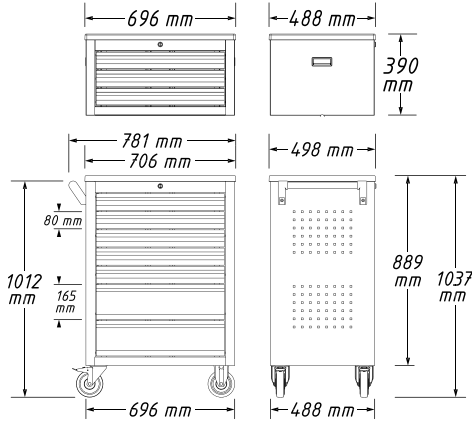
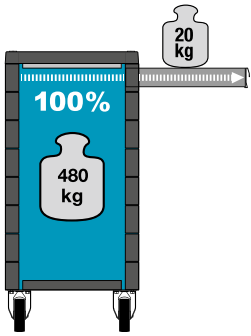
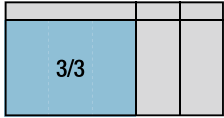

178 N-7



163-98/17



810/6 •



163-466/106



863 HP •



2105 LG/9H •



867-2 •



2116 LG/8H •



900 •

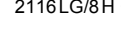

2240 N/51

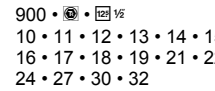

10 • 11 • 12 • 13 • 14 • 15 • 16 • 17 • 18 • 19 • 21 • 22 • 24 • 27 • 30 • 32

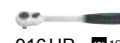

916 HP •

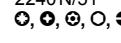

2250-1 •



917-5 •



163-95/8 •



600 N •

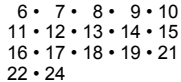

6 • 7 • 8 • 9 • 10 • 11 • 12 • 13 • 14 • 15 • 16 • 17 • 18 • 19 • 21 • 22 • 24



810 T/6 •



751 HS/5



1859 SPC/3



850 •

4 • 4.5 • 5 • 5.5

6 • 7 • 8 • 9

10 • 11 • 12 • 13



2140-50

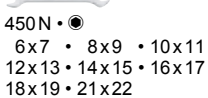

450 N •

6x7 • 8x9 • 10x11 • 12x13 • 14x15 • 16x17 • 18x19 • 21x22



163-330/16 •

HAZET No.	L x W x H mm	80x527x348 mm	165x527x348 mm	kg		EAN-No. 4000896+
• 5 flat and 2 high drawers						
• Complete with 147-piece tool assortment in Safety-Insert-System soft foam insert						
178 N-7/147	781x498x1037	5x	2x	–	147	205080
178 N-7	781x498x1037	5x	2x	74.1	–	202782
• Tool assortment						
• In soft foam insert Safety-Insert-System						
0-178 N/147	–	–	–	–	147	205097



General workshop equipment

Tool trolleys *Assistent* with assortment



The HAZET tool trolley *Assistent*® – quality through and through. Job well done by HAZET!

Design



Sheet metal forming



Welding robot



Powder coating



Installation



Quality management



Made in Germany



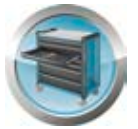

179 N Tool trolley *Assistant*

• Tool trolley

HiPer inside

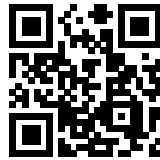
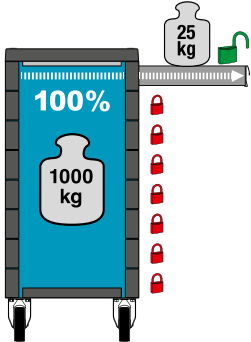
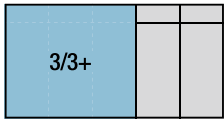

YouTube Clip

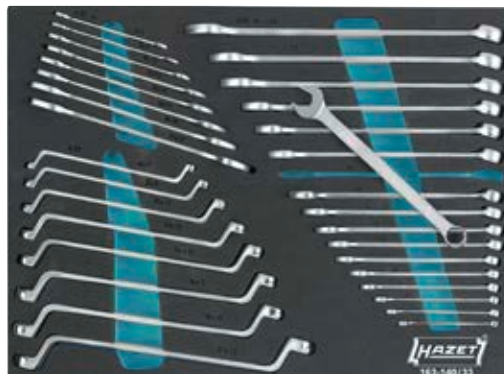
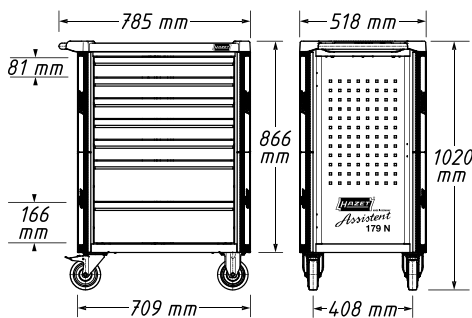



General workshop equipment

Tool trolleys *Assistant* with assortment



179N Tool trolley *Assistant*



179N-7



163-138/77



850 • 1/4
 4 • 5 • 5.5 • 6
 7 • 8 • 9 • 10
 11 • 12 • 13 • 14



850LG • 1/4
 4 • 5 • 5.5 • 6
 7 • 8 • 9 • 10
 11 • 12 • 13



858-1 • 3/8 • 1/4



863HP • 1/4



865 • 1/4



866U • 1/4



867-2 • 3/8 • 1/4

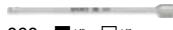

868 • 1/4 • 3/8



869 • 1/4 • 3/8



8501 • 3/4
 3 • 4 • 5 • 6 • 8



8503 • 3/4
 0.6x3.5 • 1x5.5 • 1.2x8



8506 • 3/4
 PH1 • PH2



8507 • 3/4
 PZ1 • PZ2



900 • 1/2
 10 • 11 • 12 • 13 • 14
 15 • 16 • 17 • 18 • 19
 20 • 21 • 22 • 24 • 27
 30 • 32



903SLG • 1/2
 17 • 19



915 • 1/2



916HP • 1/2



917-5 • 1/2 • 1/2

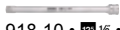

918-10 • 1/2 • 1/2

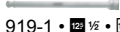

919-1 • 1/2 • 1/2



920 • 1/2 • 1/2



958-1 • 3/8 • 1/2

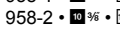

958-2 • 3/8 • 1/2



986 • 1/2
 5 • 6 • 7 • 8
 10 • 12 • 14 • 17



163-140/33 • 3/8 • 1/2 • 3/8



450N •
 6x7 • 8x9 • 10x11
 12x13 • 14x15 • 16x17
 18x19 • 21x22



600N •
 6 • 7 • 8 • 9 • 10
 11 • 12 • 13 • 14 • 15
 16 • 17 • 18 • 19 • 21
 22 • 24



630 •
 6x7 • 8x9 • 10x11
 12x13 • 14x15 • 16x17
 18x19 • 21x22



163-141/31 • • • •



802 •
 0.6x3.5 • 0.8x4 • 1x5.5
 1.2x6.5 • 1.2x8 • 1.6x10
 2x12



802-PH •
 PH1 • PH2 • PH3



801NK •
 1x5.5



801NK-PH •
 PH2



803-T •
 T 6 • T 7 • T 8 • T 9
 T 10 • T 15 • T 20 • T 25
 T 27 • T 30



2105LG/9H •



163-143/18 •



426 •
 6 • 7



612N •
 10x11



730
 730-3 • 730-6



746-1



748B
 748B-3 • 748B-4
 748B-5 • 748B-6
 748B-8



824 •
 0.5x23



1952-40



2140-40



2152N/3



2154N-5



4968-2



2128N-1



2240N/36



2204N •
 3 • 4 • 5 • 6



2208N •
 0.6x4.5 • 0.8x5.5 • 1x6



2215N •
 PH1 • PH2 • PH3



2216N •
 PZ1 • PZ2 • PZ3



2223N •
 T 10 • T 15 • T 20 • T 25
 T 27 • T 30 • T 40



2223N •
 T 20H • T 30H



2239N-6 •

HAZET No.	L x W x H mm	81x522x398 mm	166x522x398 mm	kg		EAN-No. 4000896+
• 5 flat and 2 high drawers						
179N-7/220	785x518x1020	5x	2x	90	220	220267
179N-7	785x518x1020	5x	2x	90	-	214488
• Tool assortment						
• In soft foam insert Safety-Insert-System						
0-179/220	-	-	-	-	220	168439

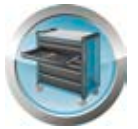

179 N Tool trolley *Assistant*

• MERCEDES-BENZ tool trolley

HiPer inside

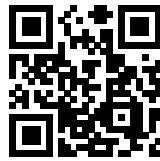
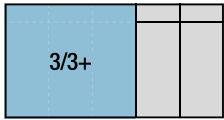

YouTube Clip

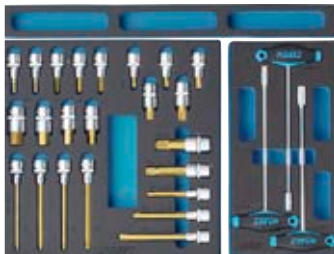
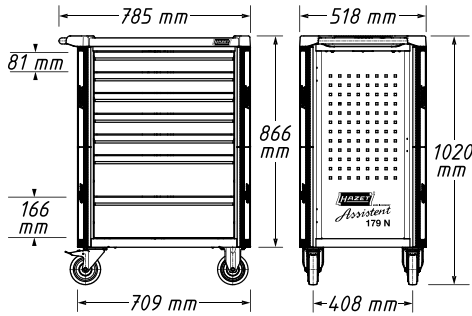
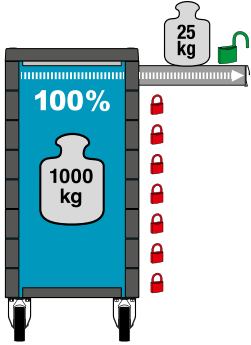

179N-8



163-118/57 • O,



850 •
4 • 5 • 5.5 • 6
7 • 8 • 9 • 10
11 • 12 • 13 • 14



8501 •
3 • 4 • 5 • 6 • 8



8503 •
0.6x3.5 • 1x5.5 • 1.2x8



8506 •
PH1 • PH2



8507 •
PZ1 • PZ2



863HP •

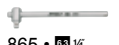

865 •



866U •

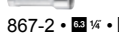

867-2 •

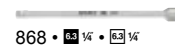

868 •



869 •



900Z •
10 • 11 • 12 • 13 • 14 • 15
16 • 17 • 18 • 19 • 20 • 21
22 • 23 • 24 • 26 • 27 • 28
30 • 32 • 34



915 •



916HP •

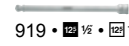

919 •



919-5 • 919-10

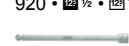

920 •



919-1 •

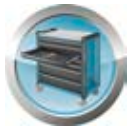

179 N Tool trolley *Assistant*

• With tool assortment for VW / AUDI

HiPer inside

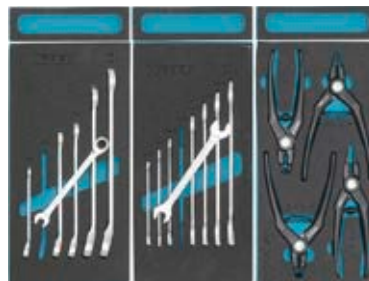
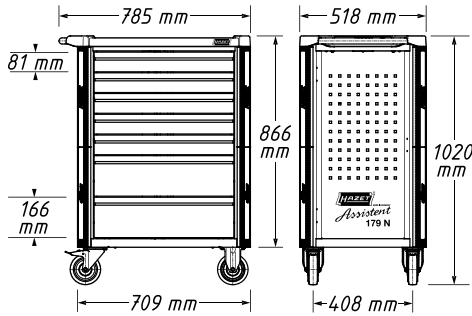
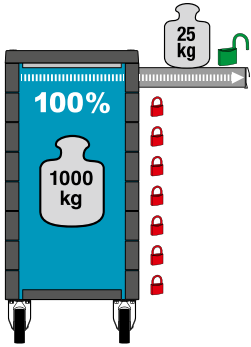
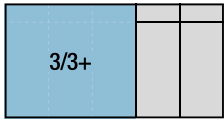

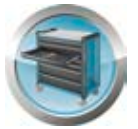

0-2500 Standard tool assortment for AUDI

Standard tool assortment for AUDI



Safety-Insert-System, 2-component soft foam insert.
Insert also suitable for HAZET Assistant



163-30/25 • ●, ○



600N • ●
6 • 7 • 8 • 9 • 10
11 • 12 • 13 • 14 • 15
16 • 17 • 18 • 19 • 21
22 • 24



630 • ●
6x7 • 8x9 • 10x11
12x13 • 14x15 • 16x17
18x19 • 21x22



163-97/6 • ●



606 • ●
8 • 10 • 12 • 13 • 17 • 19

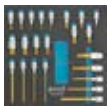

163-119/23 • ○, ○, □ 1/2



986 • ○, □ 1/2
5 • 6 • 7 • 8 • 10
12 • 14 • 17 • 19



986KK • ○, □ 1/2
6 • 7 • 8 • 10



990 • ○, □ 1/2
M 8 • M10 • M12
M14 • M16 • M18



990LG • ○, □ 1/2
M8 • M14



990SLG • ○, □ 1/2
M10 • M12



163-141/31 • ●, ○, ●, ○



802 • ●
0.6x3.5 • 0.8x4 • 1x5.5
1.2x6.5 • 1.2x8 • 1.6x10
2x12



802-PH • ●
PH1 • PH2 • PH3



801NK • ●
1x5.5



801NK-PH • ●
PH2



803-T • ○
T 6 • T 7 • T 8 • T 9
T10 • T15 • T20 • T25
T27 • T30



2105LG/9H • ○



163-143/18 • ●



426 • ●
6 • 7



612N • ●
10x11



730
730-3 • 730-6



746-1



748B
748B-3 • 748B-4
748B-5 • 748B-6
748B-8



824 • -
0.5x23



1952-40



2140-40



2152N/3



2154N-5



4968-2



163-172X50



163-257/4



760-2



1802M-22



1841MB-33



1850M-22



163-258/92



850 • ●, □ 1/4
4 • 5 • 5.5 • 6
7 • 8 • 9 • 10
11 • 12 • 13 • 14



850E • ●, □ 1/4
E4 • E5 • E6 • E7 • E8



8501 • ○, □ 1/4
3 • 4 • 5 • 6



8502 • ○, □ 1/4
T10 • T15 • T20
T25 • T27



8503 • ●, □ 1/4
1x5.5



8506 • ●, □ 1/4
PH1 • PH2



863HP • □ 1/4



866U • □ 1/4



867-2 • □ 1/4 • □ 1/4



867-4 • □ 1/4 • □ 1/4



868 • □ 1/4 • □ 1/4



869 • □ 1/4 • □ 1/4



900 • ●, □ 1/2
10 • 11 • 12 • 13 • 14
15 • 16 • 17 • 18 • 19
20 • 21 • 22 • 24 • 27
30 • 32



900Z • ●, □ 1/2
8 • 9 • 10 • 12 • 13
14 • 15 • 16 • 17 • 18
19 • 21 • 22 • 24 • 27
30 • 32



900E • ●, □ 1/2
E10 • E12 • E14
E16 • E18 • E20



915 • □ 1/2



916HP • □ 1/2



919 • □ 1/2 • □ 1/2
919-1 • 919-5 • 919-10



920 • □ 1/2 • □ 1/2



992 • ○, □ 1/2
T30 • T40 • T45
T50 • T55 • T60



2223N • ○, □ 1/4
T6 • T7 • T8 • T9



2250-1 • □ 1/4 • □ 1/4



163-522X50

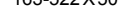

600N • ●
27 • 30 • 32

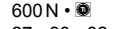

630 • ●
24x27 • 30x32



650-20

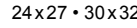

1841MA-22

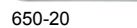

2116LG/8H • ○



General workshop equipment

Tool trolleys *Assistent* with assortment



0-2500 Supplementary tool assortment for AUDI

• Supplementary tool assortment for AUDI



• Safety-Insert-System, 2-component soft foam insert.
Insert also suitable for HAZET Assistent



450 N • ●
163-95/8 • ●



450 N • ●
6x7 • 8x9 • 10x11
12x13 • 14x15 • 16x17
18x19 • 21x22



163-121/4



755-10A



1802M-33



1803M-11



1841MA-11



428 • ●
163-122/3



428 • ●
8 • 10 • 13



1845
163-124/4



1845A-19



1845B-19



1845C-19



1845D-19



163-131/8
63 1/4, 10 3/8, 12 1/2, 20 3/4



858-1 • 10 3/8 • 63 1/4



8858-1 • 12 1/2 • 10 3/8



8858-2 • 63 1/4 • 10 3/8



903SLG • 12 1/2 • 17 • 19



958-1 • 20 3/4 • 12 1/2



958-2 • 10 3/8 • 12 1/2



1058-2 • 12 1/2 • 20 3/4



163-172X50



163-181/17 • 10 • 10 3/8



880 • 10 • 10 3/8



900SZ • 12 1/2 • 32 • 36



918-23 • 12 1/2 • 12 1/2



8816HP • 10 3/8



8820 • 10 3/8 • 10 3/8



8821 • 10 3/8 • 10 3/8



8821-3 • 8821-6 • 8821-10



426 • ●
8



450 N • ●
24x27 • 30x32



803LG-T • ●
T 15 • T 20 • T 25 • T 30



828-T • ●
T 45



880 G/10 H • ● • 10 3/8



880 G • ● • 10 3/8

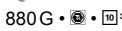

880 TZ • ● • 10 3/8

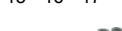

880 TZ • ● • 10 3/8

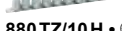

8822-1 • 10 3/8 • 10 3/8

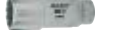

8822-10 • 10 3/8 • 10 3/8

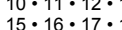

8822-3 • 10 3/8 • 10 3/8



900SZ • 12 1/2 • 32 • 36



918-23 • 12 1/2 • 12 1/2

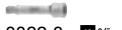

1015/2 • 20 3/4



1014

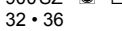

1015-1 • 20 3/4

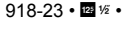

2211 • ● • 10 3/8

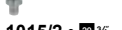

2212 • ● • 10 3/8



6420B • 10 3/8 • 10 3/8



6420C • 10 3/8 • 10 3/8



HAZET No.

0-2500-163/86

kg

12

kg

86

EAN-No.
4000896+

179503

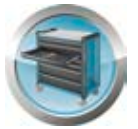

179 N Tool trolley *Assistant*

• Full BMW passenger car assortment

HiPer Inside

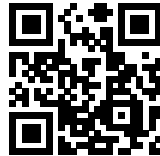
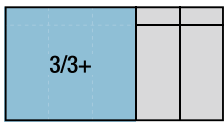

YouTube Clip

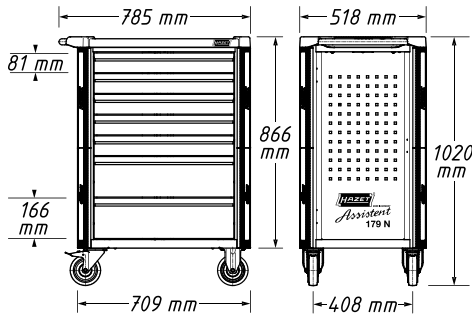
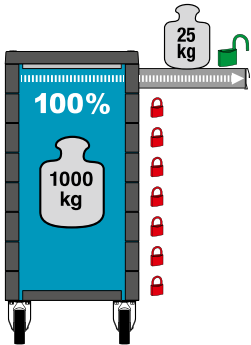

Specialised tool assortment for BMW

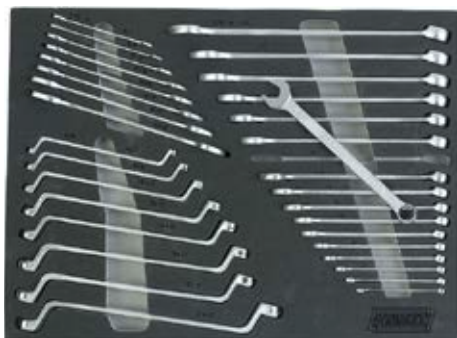

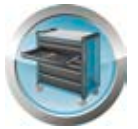

179 N Tool trolley *Assistant*

- Developed with leading automobile manufacturers
- Machining aluminium car body parts with special tools, e.g. on pure aluminium car bodies and aluminium components of mixed construction bodies
- Red marking of the tools signals to the users its special use at aluminium or mixed workstations

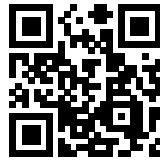
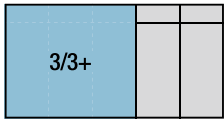

YouTube Clip

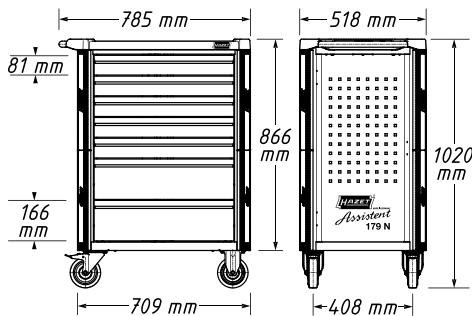
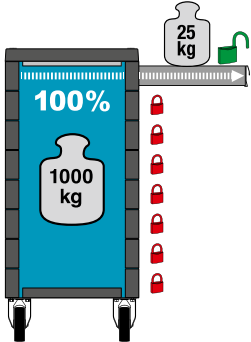



General workshop equipment

Tool trolleys *Assistant* with assortment



179 N Tool trolley *Assistant*

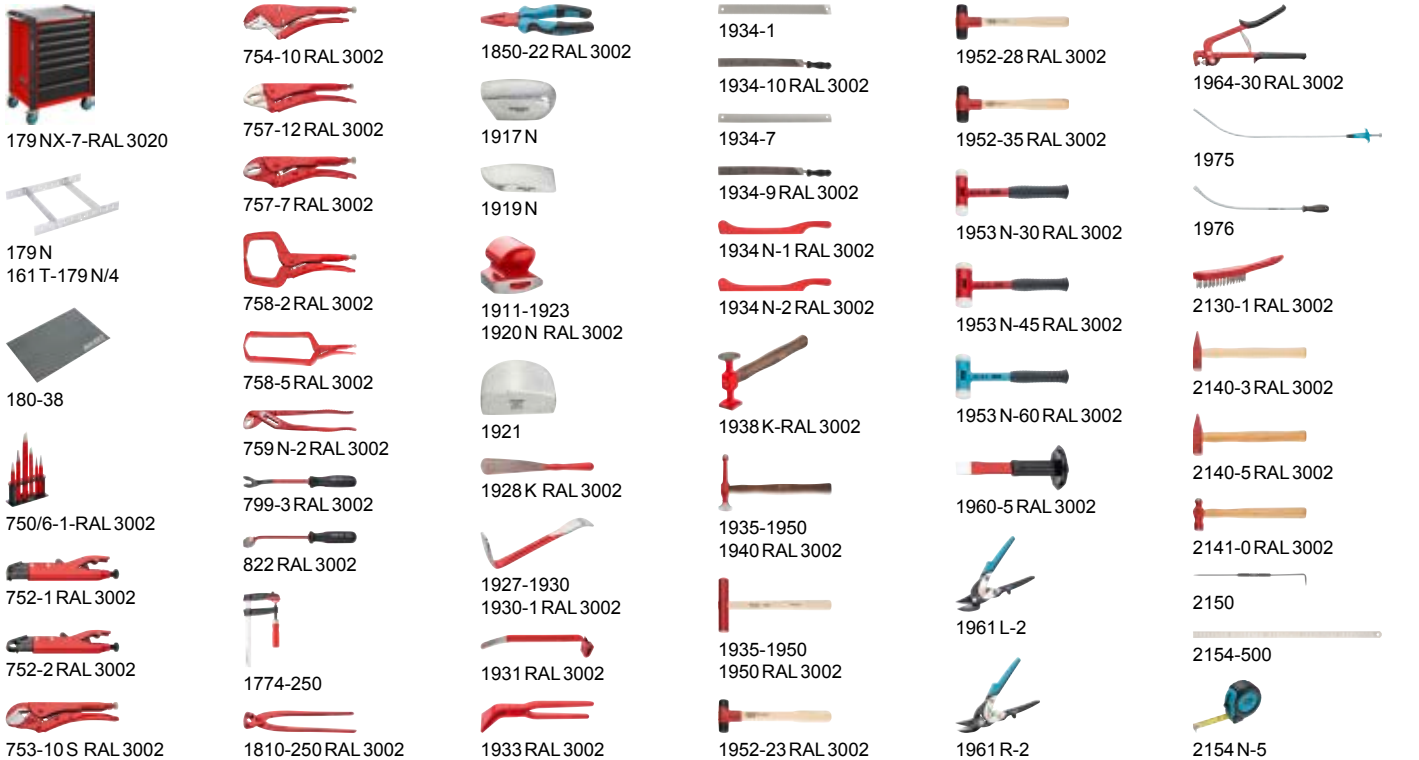

HAZET No.	L x W x H mm	81 x 522 x 398 mm	166 x 522 x 398 mm	kg		EAN-No. 4000896+
<ul style="list-style-type: none"> • Tool trolley 179NX-7-RAL 3020: 5 flat and 2 high drawers • Complete with 65-piece aluminium-body tool assortment • Machining aluminium car body parts with special tools, e.g. on pure aluminium car bodies and aluminium components of mixed construction bodies • For e.g. AUDI Q7 model year 2015 → A2 (partial) · A6 model year 2011 → A8 · R8 · TT BMW 5-Series · 6-Series · Z8 LAND ROVER Defender MITSUBISHI i-MiEV model year 2009 → 2016 PORSCHE Cayenne model year 2018 → VW Touareg model year 2018 → • Red marking of the tools signals to the users its special use at aluminium or mixed workstations 						
179 NX-7/65ALU	786x518x1020	5x	2x	90	65	219117
179 NX-7-RAL 3020	786x518x1020	5x	2x	90	–	219322
<ul style="list-style-type: none"> • Aluminium-body tool assortment • Machining aluminium car body parts with special tools, e.g. on pure aluminium car bodies and aluminium components of mixed construction bodies • For e.g. AUDI Q7 model year 2015 → A2 (partial) · A6 model year 2011 → A8 · R8 · TT BMW 5-Series · 6-Series · Z8 LAND ROVER Defender MITSUBISHI i-MiEV model year 2009 → 2016 PORSCHE Cayenne model year 2018 → VW Touareg model year 2018 → • Red marking of the tools signals to the users its special use at aluminium or mixed workstations 						
0-179 NX/65ALU	–	–	–	–	65	219124

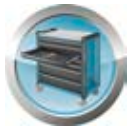

179 NXL Tool trolley *Assistant*

• Tool trolley

HiPer inside

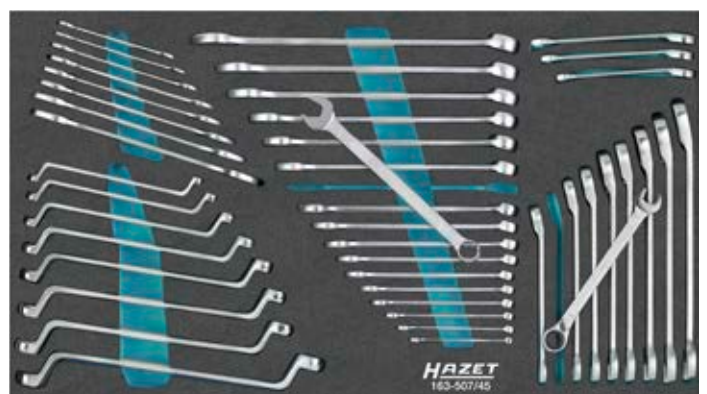
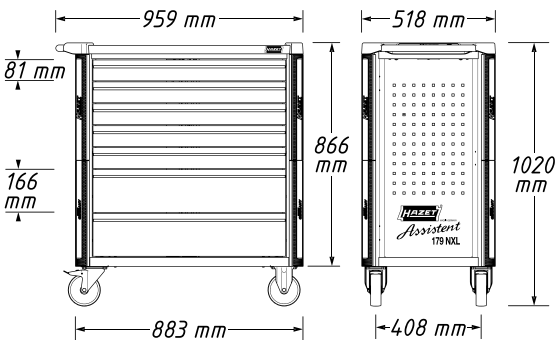
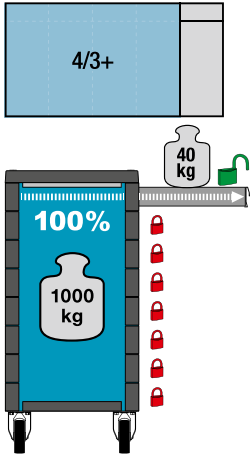



General workshop equipment

Tool trolleys *Assistant* with assortment



179 NXL Tool trolley *Assistant*



179NXL-7



163-480/57 • • • • •

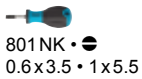

801NK • •

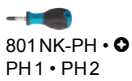

801NK-PH • •

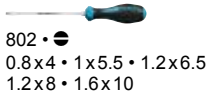

802 • • • •



802-PH • • • •



805/7 • •



808/7 •

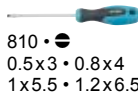

810 • •

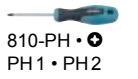

810-PH • •

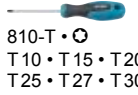

810-T • •

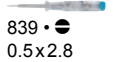

839 • •



2105LG/9H •



2116LG/8H •



163-507/45 • •

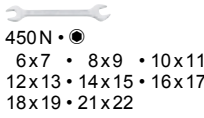

450N •

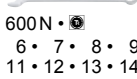

600N •

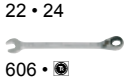

606 •

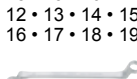

630 •

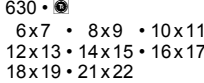

163-508/138 • • • •



760-2 •

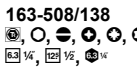

810SPC-6.3 •



850 • •

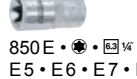

850E • •

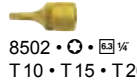

8502 • •



863HP •

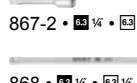

867-2 • •



868 • •



869 • •

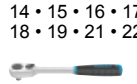

880 • •



8816HP •



8820 • •

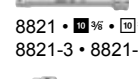

8821 • •

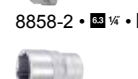

8858-2 • •

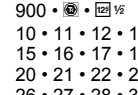

900 • •

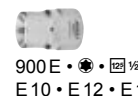

900E • •

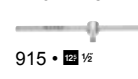

915 •

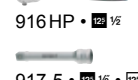

916HP •

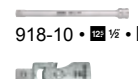

917-5 • •



918-10 • •



920 • •

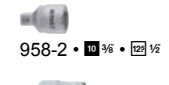

958-2 • •

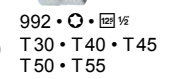

992 • •

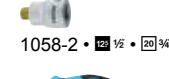

1058-2 • •

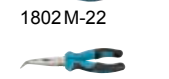

1802M-22 •



1841MB-33 •



1850M-22 •

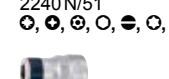

2240N/51 • • • •



2250-1 • •



2128N-1 •



HAZET No.	L x W x H mm	81 x 696 x 398 mm	166 x 696 x 398 mm	125 kg	265	EAN-No. 4000896+
<ul style="list-style-type: none"> • 5 flat and 2 high drawers • Complete with 265-piece tool assortment in Safety-Insert-System soft foam insert 						
179 NXL-7/265	959x518x1020	5x	2x	125	265	215201
179 NXL-7	959x518x1020	5x	2x	125	-	215164
<ul style="list-style-type: none"> • Tool assortment • In soft foam insert Safety-Insert-System 						
0-179 NXL/265	-	-	-	-	265	214761



179 NXL Tool trolley *Assistant*

• Tool trolley

HiPer Inside

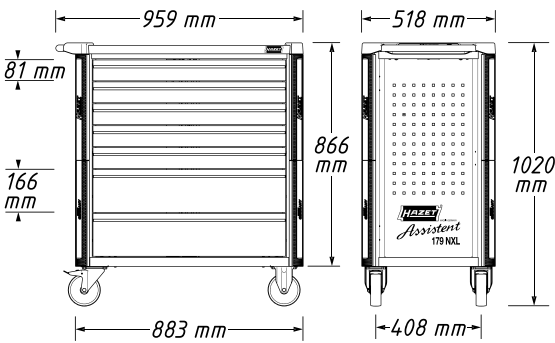
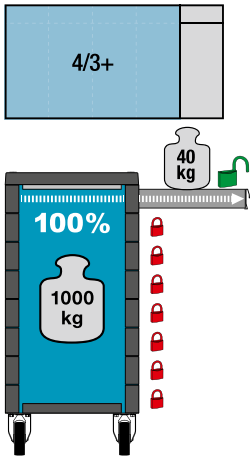

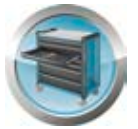

179 NXL Tool trolley *Assistant*

- VW / AUDI tool set
- Supplementary tool assortments, see also:
 - Supplementary tool assortment for AUDI 0-2500-163/86

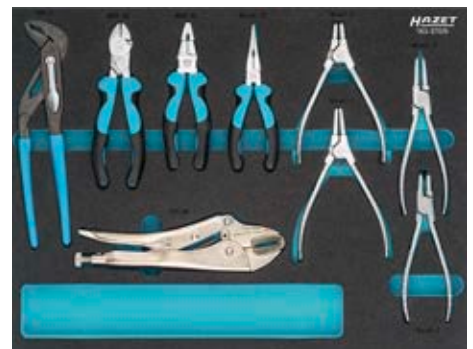
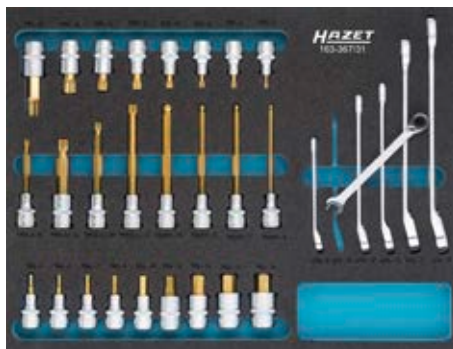
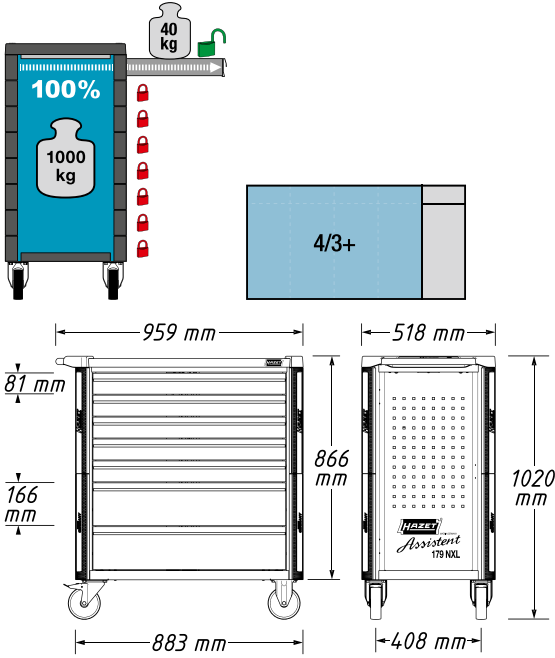



General workshop equipment

Tool trolleys *Assistant* with assortment



179 NXL Tool trolley *Assistant*



179 NXL-8-VW



163-367/31 • ●, ○, ○, □ ½

606 • ●
8 • 10 • 12 • 13 • 17 • 19

986 • ○ □ ½
5 • 6 • 7 • 8 • 10
12 • 14 • 17 • 19

986KK • ○ □ ½
6 • 7 • 8 • 10

990 • ○ □ ½
M 5 • M 6 • M 8 • M 10
M 12 • M 14 • M 16 • M 18

990LG • ○ □ ½
M 8 • M 14

990SLG • ○ □ ½
M 10 • M 12



163-369/104
●, ○, ○, □ ½, □ ¾

850 • ● □ ¼
4 • 5 • 5.5 • 6
7 • 8 • 9 • 10
11 • 12 • 13 • 14

850 E • ● □ ¼
E 4 • E 5 • E 6 • E 7 • E 8

8501 • ○ □ ¼
3 • 4 • 5 • 6

8502 • ○ □ ¼
T 10 • T 15 • T 20
T 25 • T 27

8503 • ● □ ¼
1 x 5.5

8506 • ● □ ¼
PH 1 • PH 2

858-1 • ● □ ¾ • □ ¼

863 HP • ● □ ¼

866 U • ● □ ¼

867-2 • ● □ ¼ • □ ¼

867-4 • ● □ ¼ • □ ¼

868 • ● □ ¼ • □ ¼

869 • ● □ ¼ • □ ¼

8858-1 • ● □ ½ • □ ¾

8858-2 • ● □ ¼ • □ ¾

900 • ● □ ½
10 • 11 • 12 • 13 • 14
15 • 16 • 17 • 18 • 19
20 • 21 • 22 • 24 • 27
30 • 32

900 E • ● □ ½
E 10 • E 12 • E 14
E 16 • E 18 • E 20

900 SZ • ● □ ½
32 • 36

900 Z • ● □ ½
8 • 9 • 10 • 12 • 13
14 • 15 • 16 • 17 • 18
19 • 21 • 22 • 24 • 27
30 • 32

903 SLG • ● □ ½
17 • 19

915 • ● □ ½

916 HP • ● □ ½

919 • ● □ ½ • □ ¼

920 • ● □ ½ • □ ¼

958-1 • ● □ ¾ • □ ½

958-2 • ● □ ¾ • □ ½

992 • ● □ ½
T 25 • T 27 • T 30 • T 40
T 45 • T 50 • T 55 • T 60

1058-2 • ● □ ½ • □ ¾

2223 N • ● □ ¼

2250-1 • ● □ ¼

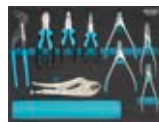

163-370/9

757-10

760-2

1802-22

1841 A-22

1846 A-2

1846 B-2

1846 C-2

1846 D-2

1850-22



163-371/7
●, ○, □ ½, □ ¾

600 N • ●
27 • 30 • 32

650-20

918-23 • ● □ ½ • □ ¼

1014

1015-1 • ● □ ¾



163-372/25 • ●

612 N • ●
10 x 11

666-5

730

730-3 • 730-6

746-1

748 B

748 B-3 • 748 B-4

748 B-5 • 748 B-6

748 B-8

824 • -
0.5 x 23

1952-40

1976-2

1977-2/4

2140-40

2147 MS

2152 N/3

2154 N-5

2157-1

4968-2

163-373/39 • ●, ○, ○, □

163-373/39 • ●, ○, ○, □

163-373/39 • ●, ○, ○, □

163-373/39 • ●, ○, ○, □



801 NK • ●
1 x 5.5

801 NK-PH • ●
PH 2

802 • ●
0.6 x 3.5 • 1.2 x 8
1.6 x 10 • 2 x 12

802-PH • ●
PH 3

803-T • ●
T 6 • T 7 • T 8 • T 9
T 10 • T 15 • T 20 • T 25
T 27 • T 30

810 U-1/5 • ●, ●

2105 LG/9 H • ○

2116 LG/8 H • ○

163-374/27 • ●, ●, ●

163-374/27 • ●, ●, ●

600 N • ●
6 • 7 • 8 • 9 • 10
11 • 12 • 13 • 14 • 15
16 • 17 • 18 • 19 • 21
22 • 24

630 • ●
6 x 7 • 8 x 9 • 10 x 11
12 x 13 • 14 x 15 • 16 x 17
18 x 19 • 21 x 22 • 24 x 27
30 x 32

HAZET No.	L x W x H mm	81 x 696 x 398 mm	166 x 696 x 398 mm	kg		EAN-No. 4000896+
<ul style="list-style-type: none"> • 7 flat drawers and 1 high drawer • Colour RAL 7012 (basalt grey) • Complete with 243-piece tool assortment in Safety-Insert-System soft foam insert 						
179 NXL-8-VW/243	959 x 518 x 1020	7x	1x	125	243	220250
179 NXL-8-VW	959 x 518 x 1020	7x	1x	125	-	220243
<ul style="list-style-type: none"> • Tool assortment • In soft foam insert Safety-Insert-System 						
0-2500-163/242	-	-	-	-	242	196890

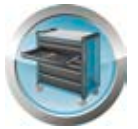

179 NXXL Tool trolley *Assistant*

• Tool trolley

HiPer inside

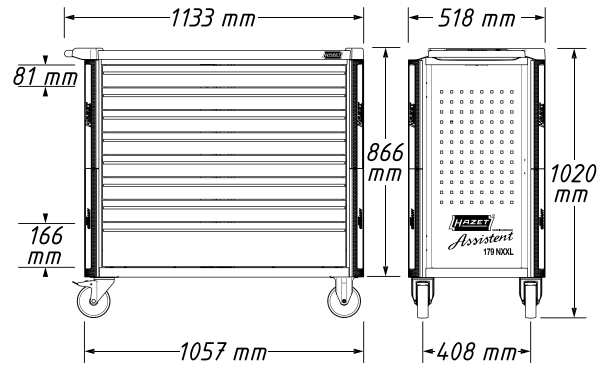
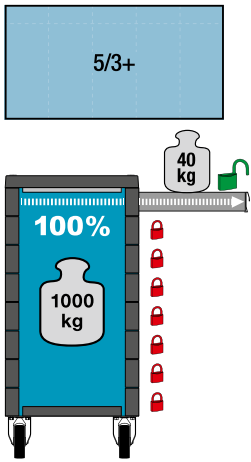



General workshop equipment

Tool trolleys *Assistant* with assortment



179 NXXL Tool trolley *Assistant*



179 NXXL-7



163-478/40 •

450 N •

6x7 • 8x9 • 10x11
12x13 • 14x15 • 16x18
17x19 • 21x22 • 22x24
24x27 • 30x32 • 34x36

600 N •

8 • 9 • 10 • 11 • 12
13 • 14 • 15 • 16 • 17
18 • 19 • 21 • 22 • 24
27 • 30 • 32 • 34

630 •

6x7 • 8x9 • 10x11
12x13 • 14x15 • 16x17
18x19 • 21x22 • 24x27



163-480/57 •

801 NK •

0.6x3.5 • 1x5.5

801 NK-PH •

PH1 • PH2

802 •

0.8x4 • 1x5.5 • 1.2x6.5
1.2x8 • 1.6x10

802-PH •

PH0 • PH1 • PH2 • PH3



805/7 •



808/7 •

810 •

0.5x3 • 0.8x4
1x5.5 • 1.2x6.5

810-PH •

PH1 • PH2

810-T •

T10 • T15 • T20
T25 • T27 • T30

839 •

0.5x2.8

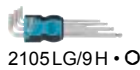

2105LG/9H •



2116LG/8H •



163-481/194

810 SPC-6.3 •

850 •

3 • 4 • 5 • 6
7 • 8 • 9 • 10
11 • 12 • 13 • 14

850 E •

E4 • E5 • E6 • E8 • E10

8501 •

3 • 4 • 5 • 6 • 8

8502 •

T15 • T20 • T25
T27 • T30 • T40

8503 •

0.6x3.5 • 1x5.5 • 1.2x8

8506 •

PH1 • PH2

8507 •

PZ1 • PZ2

850 LG •

4 • 5 • 6 • 7 • 8
9 • 10 • 11 • 12 • 13

858-1 •

863 HP •

865 •

866 U •

867-2 •

868 •

869 •

880 •

10 • 11 • 12 • 13
14 • 15 • 16 • 17
18 • 19 • 21 • 22

8801 K •

5 • 6 • 8 • 10

880 LG •

12 • 13 • 14 • 15
16 • 17 • 18 • 19

8816 HP •

8820 •

8821 •

8821-3 • 8821-6 • 8821-10

900 •

10 • 11 • 12 • 13 • 14
15 • 16 • 17 • 18 • 19
20 • 21 • 22 • 23 • 24
26 • 27 • 28 • 30 • 32

915 •

916 HP •

917-5 •

918-10 •

920 •

986 •

4 • 5 • 6 • 7 • 8 • 9
10 • 12 • 17 • 19 • 22

990 •

M 5 • M 6 • M 8 • M10
M12 • M14 • M16 • M18

991 •

M 6 • M 7 • M 8 • M 9
M10 • M12 • M14

992 •

T20 • T25 • T27
T30 • T40 • T45
T50 • T55 • T60

2240 N/51

2250-1 •



606 •

606 •

8 • 9 • 10 • 11
12 • 13 • 14 • 15
16 • 17 • 18 • 19



163-510/8

730
730-3 • 730-6



751 HS/5



2140-50



163-511/4



760-2



1802 M-22



1841 MB-33



1850 M-22



2128 N-1

HAZET No.	L x W x H mm	81x870x398 mm	166x870x398 mm	kg		EAN-No. 4000896+
<ul style="list-style-type: none"> • 5 flat and 2 high drawers • Complete with 340-piece tool assortment in Safety-Insert-System soft foam insert 						
179 NXXL-7/340	1133x518x1020	5x	2x	145	340	215072
179 NXXL-7	1133x518x1020	5x	2x	145	-	214624
<ul style="list-style-type: none"> • Tool assortment • In soft foam insert Safety-Insert-System 						
0-179 NXXL/340	-	-	-	-	340	214754

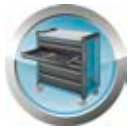

179 NXXLD Tool trolley *Assistant*

• Tool trolley – extra deep

HiPer inside

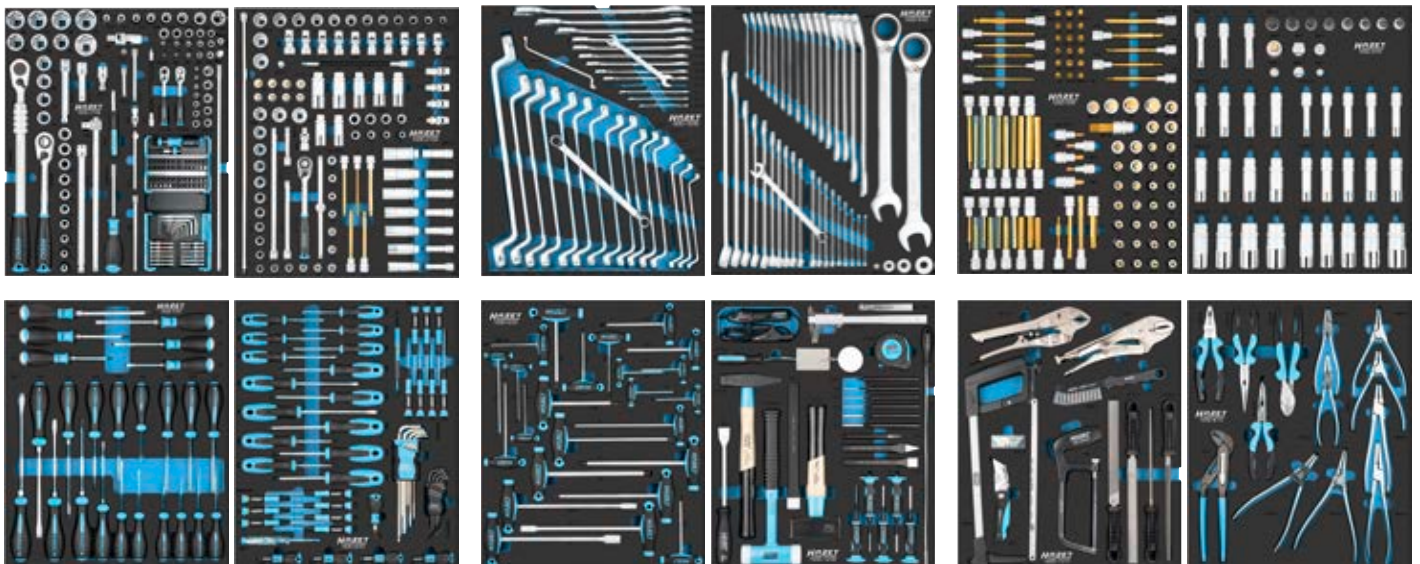
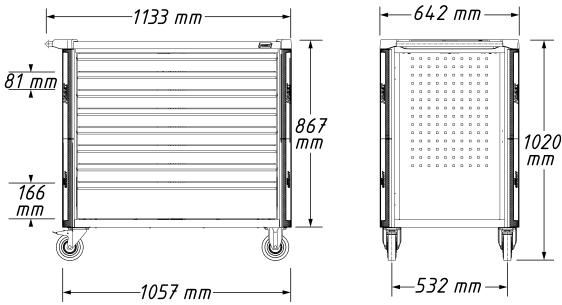
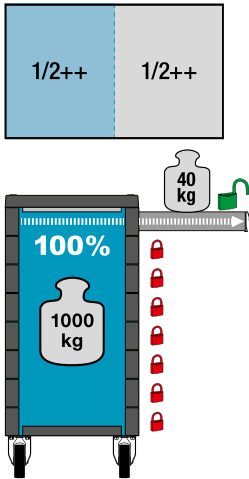

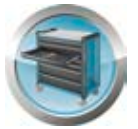

179 NXXLD Tool trolley *Assistant*



163D-10/30

450N • ●
5x5.5 • 6x7 • 8x9
10x11 • 12x13 • 14x15
16x18 • 17x19 • 20x22
21x23 • 24x27 • 30x32
34x36



630 • ●

6x7 • 8x9 • 10x11
12x13 • 14x15 • 16x17
17x19 • 18x19 • 20x22
21x22 • 21x23 • 24x26
24x27 • 25x28 • 27x32
30x32 • 36x41



163D-11/11

755-10A
757-10



1980N



1981

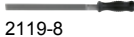

2119-8

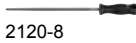

2120-8

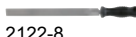

2122-8

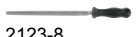

2123-8



2157-07



2157-1



4968-2



163D-12/30



730

730-3 • 730-7



740-3



746-2



748B

748B-2 • 748B-3

748B-4 • 748B-5

748B-6 • 748B-8



751HS/5



824 • -
0.5x23



1953N-40



1976-2



1977-2/4



2140-50



2142-2



2147MS



2152N/3



2154-10



2154N-5

HiPer Inside (E)

HAZET No.	L x W x H mm	81x870x522 mm	166x870x522 mm	kg		EAN-No. 4000896+
• 7 flat and 1 high drawer • Complete with lateral door and socket strip and 619-piece tool assortment in Safety-Insert-System soft foam insert						
179 NXXL-8D/619	1167x642x1020	7x	1x	-	619	245185
179 NXXL-8D	1133x642x1020	7x	1x	146.5	-	242931
• 7 flat and 1 high drawer • Complete with lateral door and socket strip (without assortment)						
179 NXXL-8D/3	1167x642x1020	7x	1x	155.5	3	245178
• Tool assortment • In soft foam insert Safety-Insert-System						
0-179 NXXLD/616	-	-	-	-	616	246069

Work benches *Assistant* with assortment

177 W Mobile work bench · with assortment

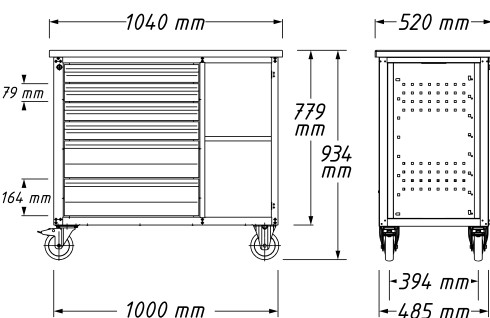
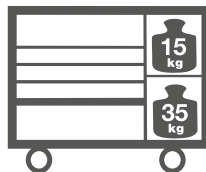
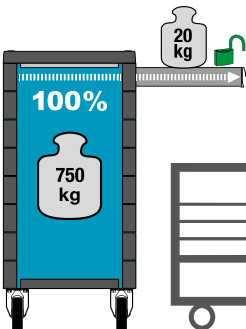
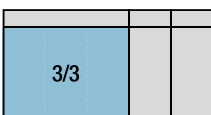

HiPer Inside (E)





General workshop equipment

Work benches *Assistant* with assortment



177 W Mobile work bench · with assortment

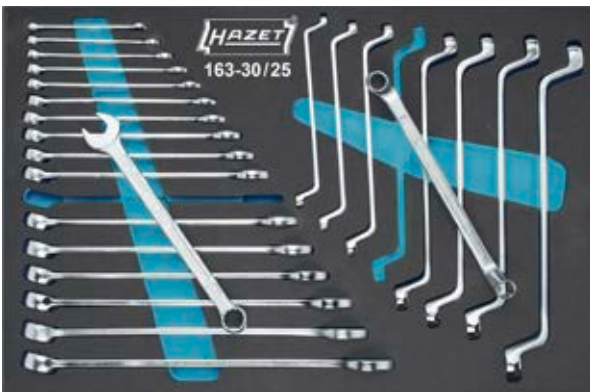

177W-7



163-30/25



600N
6 · 7 · 8 · 9 · 10
11 · 12 · 13 · 14 · 15
16 · 17 · 18 · 19 · 21
22 · 24



630
6x7 · 8x9 · 10x11
12x13 · 14x15 · 16x17
18x19 · 21x22



163-31/27

730
730-3 · 730-6

746-1

748B
748B-3 · 748B-4
748B-5 · 748B-6

760-2

801NK
1x5.5

801NK-PH
PH2

803
0.4x2.5 · 0.5x3 · 0.6x3.5
0.8x4 · 1.2x6.5 · 1.2x8

803-PH
PH1 · PH2

803-T
T10 · T15 · T20
T25 · T30

1802M-22

1841MB-33

1850M-22

2140-50



163-57/56

850
4 · 5 · 5.5 · 6
7 · 8 · 9 · 10
11 · 12 · 13 · 14

8501
3 · 4 · 5 · 6 · 8

8503
0.6x3.5 · 1x5.5 · 1.2x8

8506
PH1 · PH2

8507
PZ1 · PZ2

863HP

865

866U

867-2

868

869

900

915

916HP

917-5

918-10

920

2128N-1



2240N/36

2204N

2208N

2215N

2216N

2223N

2223N

2239N-6

HAZET No.	L x W x H mm	79x527x348 mm	164x527x348 mm	kg	EAN-No. 4000896+		
177W-7/169	1040x520x934	6x	1x	7x	85	169	157310
177W-7	1040x520x934	6x	1x	7x	85	-	155644
0-178/169	-	-	-	-	-	169	162208



179 NW Mobile work bench

- More storage space than preceding model

HiPer inside

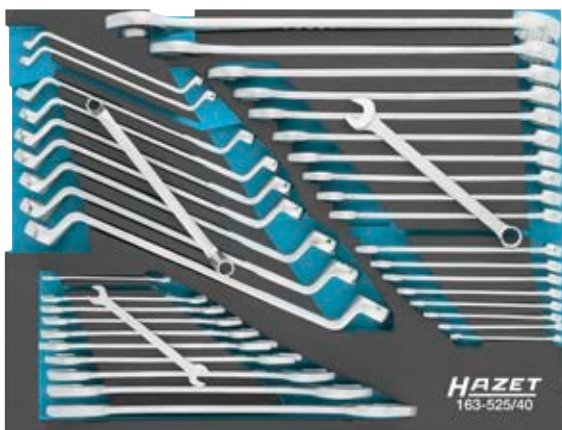
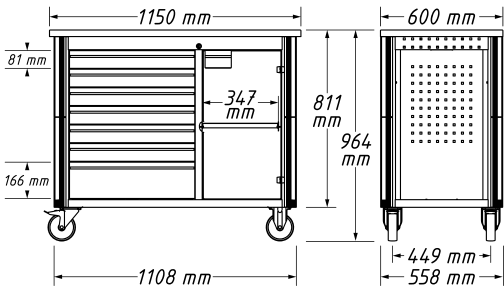
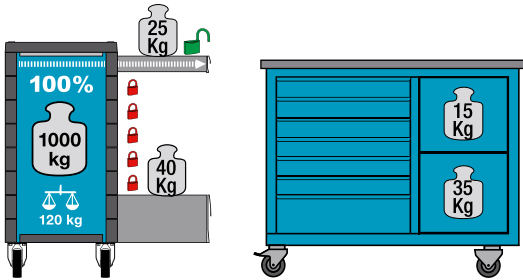
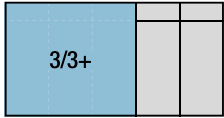

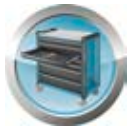

Tool cases

190 Metal tool box · with assortment

- Tool box 190 L, complete with assortment and padlock
- 1 spacious bottom compartment, 4 side compartments which can be folded out
- Lockable with padlock (included)
- Sturdy and blue/black design
- Stove-enamelled in HAZET blue / black



- | | | | |
|---------------|-----------------|-------------------|----------------|
| | | | |
| 190L | 740-3 | 824 | 986 |
| 450N | 745A | 0.5x23 | 5 • 6 • 8 • 10 |
| 6x7 • 8x9 | 745A-2 • 745A-4 | | 1802 M-22 |
| 10x11 • 12x13 | 746-2 | 10 • 11 • 12 • 13 | 1841 MA-33 |
| 14x15 • 16x17 | 760N | 14 • 15 • 16 • 17 | 1952-35 |
| 18x19 • 21x22 | 760N-1 • 760N-2 | 18 • 19 • 21 • 22 | |
| 24x27 • 30x32 | 803 | 24 • 26 • 27 • 28 | 2140-50 |
| 630 | 0.4x2.5 • 0.5x3 | 30 • 32 | 2154 N-3 |
| 6x7 • 8x9 | 0.6x3.5 | | |
| 10x11 • 12x13 | 0.8x4 • 1x5.5 | | |
| 14x15 • 16x17 | 1.2x8 | | |
| 18x19 • 21x22 | 915 | | |
| 24x27 • 30x32 | 916 HP | | |
| 36x41 | 917-5 | | |
| 650-20 | 918-10 | | |
| 730 | 920 | | |
| 730-3 • 730-6 | 803-PH | | |
| | PH1 • PH2 • PH3 | | |
| | 803-PZ | | |
| | PZ1 • PZ2 | | |

HAZET No.	L x W x H mm	Weight	EAN-No. 4000896+
190/80	575x210x245	80	048922

190 L L-Boxx

- Patented click system connects the L-Boxx to other L-Boxxes easily and reliably

- Extremely robust due to impact and shock resistant ABS plastic
- Cover loading capacity: up to 100 kg
- Loading capacity of the carrying handles (loading content): 25 kg
- Ergonomic transport handles on head and side panels
- With labeling fields
- Dirt repellent and easy to clean
- Internal dimensions (LxWxH): 378x310x101 mm
- Volume: 13.3 l



190 L L-Boxx

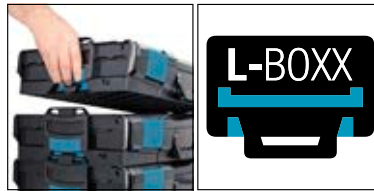

- | | | |
|---------------------|------------|---|
| | | |
| 190L-136 | 839 | 2140-30 |
| 279-6 | 0.5x2.8 | 2154 N-5 |
| 450N | 1859 SPC/3 | 2157 |
| 8x9 • 10x13 • 17x19 | 1979-11 | 2200 SC-1 |
| 810 SPC-6.3 | 1981 | 2, 3, 4, 5, 6, 7, 8, 9, 10, 11, 12, 13, 14, 15, 16, 17, 18, 19, 20, 21, 22, 23, 24, 25, 26, 27, 28, 29, 30, 31, 32, 33, 34, 35, 36, 37, 38, 39, 40, 41, 42, 43, 44, 45, 46, 47, 48, 49, 50, 51, 52, 53, 54, 55, 56, 57, 58, 59, 60, 61, 62, 63, 64, 65, 66, 67, 68, 69, 70, 71, 72, 73, 74, 75, 76, 77, 78, 79, 80, 81, 82, 83, 84, 85, 86, 87, 88, 89, 90, 91, 92, 93, 94, 95, 96, 97, 98, 99, 100 |

HAZET No.	L x W x H mm	Weight	EAN-No. 4000896+
190 L-136/83	445x358x152	83	243303

1520 Leather tool case

- Sturdy micro-leather with super-soft, water-repellent surface
- HAZET logo – embossed in high quality

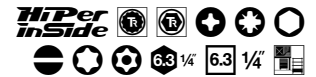

- | | | |
|-------------------|-----------|---|
| | | |
| 600N | 866 U | 2140-20 |
| 8 • 10 • 11 • 12 | 867-4 | 2240 N/36 |
| 13 • 15 • 17 • 19 | 1803 M-11 | 2, 3, 4, 5, 6, 7, 8, 9, 10, 11, 12, 13, 14, 15, 16, 17, 18, 19, 20, 21, 22, 23, 24, 25, 26, 27, 28, 29, 30, 31, 32, 33, 34, 35, 36, 37, 38, 39, 40, 41, 42, 43, 44, 45, 46, 47, 48, 49, 50, 51, 52, 53, 54, 55, 56, 57, 58, 59, 60, 61, 62, 63, 64, 65, 66, 67, 68, 69, 70, 71, 72, 73, 74, 75, 76, 77, 78, 79, 80, 81, 82, 83, 84, 85, 86, 87, 88, 89, 90, 91, 92, 93, 94, 95, 96, 97, 98, 99, 100 |
| 760-2 | 1965-21 | 2250-1 |
| 839 | 1979N-71 | 4850-1 |
| 0.5x2.8 | 1987N-4 | |
| 850 | | |
| 5.5 • 7 • 8 • 10 | | |
| 11 • 12 • 13 | | |
| 863 HP | | |

HAZET No.	L x W x H mm	Weight	EAN-No. 4000896+
1520/64	275x310x65	64	214556



General workshop equipment

Tool cases



1520 Tool case

- "Slim-Line" – only 105 mm high
- For universal applications, e.g. for hobby, house and garden
- Clear and reliable tool arrangement
- Inserts with clamping effect – tools cannot fall down
- Covered compartment for small parts



450 N • ●
6x7 • 8x9 • 10x11
12x13 • 14x15 • 16x17
18x19 • 21x22

760-2

802 • ●
0.8x4 • 1x5.5 • 1.2x6.5

802-PH • ●
PH1 • PH2

802-PZ • ●
PZ2

839 • ●
0.5x2.8

880 • ● • □ 3/8
8 • 10 • 11 • 12 • 13
14 • 15 • 16 • 17 • 18
19 • 20 • 21 • 22

8816 HP • □ 3/8

8821 • □ 3/8 • □ 1/2
8821-3 • 8821-6

1803-22

1979-N-71

1981

2100 • ○
2 • 2.5 • 3 • 4 • 5 • 6 • 7 • 8

2115/8 KH • ○

2140-50

2154-2

2157

2158

HAZET No.	L x W x H mm	56	EAN-No. 4000896+
1520/56	445x360x105	56	111183

190 L Metal tool box · empty

- 1 spacious bottom compartment, 4 side compartments which can be folded out
- Lockable with padlock (included)
- Sturdy and blue/black design
- Stove-enamelled in HAZET blue / black

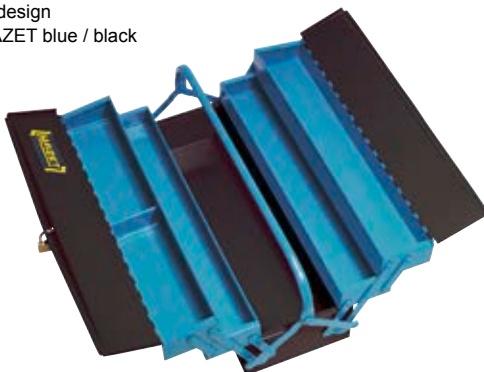

190 L Metal tool box · empty



HAZET No.	L x W x H mm	EAN-No. 4000896+
190 L	575x210x245	007462

190 L Plastic tool box

Germany Made in Germany

Mobile workplace

- For professionals and demanding hobbyists
- Very sturdy design
- Compact dimensions with highest possible storage capacity
- Safe carrying due to tough aluminium handle
- Sturdy aluminium latches
- Two folding-down trays
- Plastic, HAZET blue / black



HAZET No.	L x W x H mm	EAN-No. 4000896+
190 L-2	470x250x215	150533
190 L-3	550x250x270	133987

190 L Plastic tote tray

Germany Made in Germany

- Open and practical
- Metre/inch scale at the top
- Also for transporting liquids and cans
- Rugged aluminium handle
- Solvent-resistant plastic, HAZET blue
- Stackable

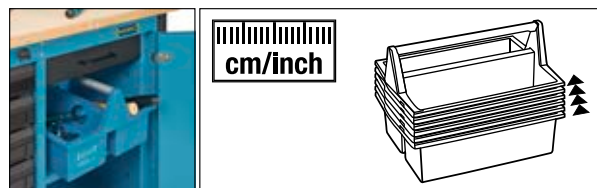

HAZET No.	L x W x H mm	EAN-No. 4000896+
190 L-1	396x294x215	133901

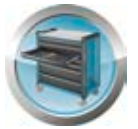

165 Tool box for Safety-Insert-System

Made in Germany

- Modern two-coloured design HAZET blue / black
- Pull-out kickstand for fast and ergonomic tool access
- Cover may be used as a storage space for the tools or for small parts
- Sturdy ABS plastic – lighter than sheet metal box



190 L L-Boxx

Made in Germany

- Patented click system connects the L-Boxx to other L-Boxxes easily and reliably
- Extremely robust due to impact and shock resistant ABS plastic
- Cover loading capacity: up to 100 kg
- Loading capacity of the carrying handles (loading content): 25 kg
- Ergonomic transport handles on head and side panels
- With labeling fields
- Dirt repellent and easy to clean



HAZET No.	L x W x H mm	EAN-No. 4000896+
• For all 1/9 Safety-Insert-System 2-component soft foam inserts from the HAZET range		
165-S	185x153x52	167784
• For all 1/3 Safety-Insert-System 2-component soft foam inserts from the HAZET range		
• Carrying handle		
165-L	355x235x65	167777

HAZET No.	L x W x H mm	l mm	EAN-No. 4000896+
• Internal dimensions (L x W x H): 378 x 313 x 65 mm			
• Volume: 8.8 l			
190 L-102	445x358x118	445	237609
• Internal dimensions (L x W x H): 378 x 310 x 101 mm			
• Volume: 13.3 l			
190 L-136	445x358x152	445	237616





Tool assortments

0-7 Tool assortment

• Mechanic's basic assortment for car repairs

• Safety-Insert-System, 2-component soft foam insert.
Insert also suitable for HAZET Assistent



163-57/56 • O, ⊖, ⊕, ⊗, ⊙
⊚ 1/2, ⊚ 3/4



850 • ⊖ • ⊚ 1/4
4 • 5 • 5.5 • 6
7 • 8 • 9 • 10
11 • 12 • 13 • 14



8501 • O • ⊚ 1/4
3 • 4 • 5 • 6 • 8



8503 • ⊖ • ⊚ 1/4
0.6x3.5 • 1x5.5 • 1.2x8



8506 • ⊕ • ⊚ 1/4
PH1 • PH2



8507 • ⊕ • ⊚ 1/4
PZ1 • PZ2



863HP • ⊚ 1/4



865 • ⊚ 1/4



866U • ⊚ 1/4



867-2 • ⊚ 1/4 • ⊚ 3/4



868 • ⊚ 1/4 • ⊚ 3/4



869 • ⊚ 1/4 • ⊚ 3/4



900 • ⊖ • ⊚ 1/2
10 • 11 • 12 • 13 • 14 • 15
16 • 17 • 18 • 19 • 20 • 21
22 • 23 • 24 • 26 • 27 • 28
30 • 32 • 34



915 • ⊚ 1/2



916HP • ⊚ 1/2

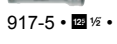

917-5 • ⊚ 1/2 • ⊚ 3/4

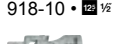

918-10 • ⊚ 1/2 • ⊚ 3/4

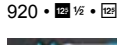

920 • ⊚ 1/2 • ⊚ 3/4

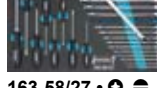

163-58/27 • ⊕, ⊖, ⊙



600N • ⊖
6 • 7 • 8 • 9 • 10
11 • 12 • 13 • 14 • 15
16 • 17 • 18 • 19 • 21
22 • 24



803 • ⊖
0.4x2.5 • 0.5x3 • 0.6x3.5
0.8x4 • 1.2x6.5 • 1.2x8



803-PH • ⊕
PH1 • PH2



801NK • ⊖
1x5.5



801NK-PH • ⊕
PH2



163-59/12 • ⊖



630 • ⊖
6x7 • 8x9 • 10x11
12x13 • 14x15 • 16x17
18x19 • 20x22 • 21x23



760-2



1802-22



1841A-22



163-60/22 • O



730

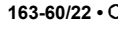

730-3 • 730-6

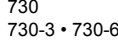

746-1

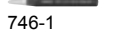

748B

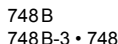

748B-3 • 748B-4
748B-5 • 748B-6



824 • -
0.5x23

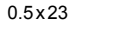

1952-35

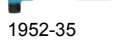

1976



2105LG/9H • O



2140-50



2147MS

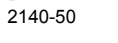

2154-2

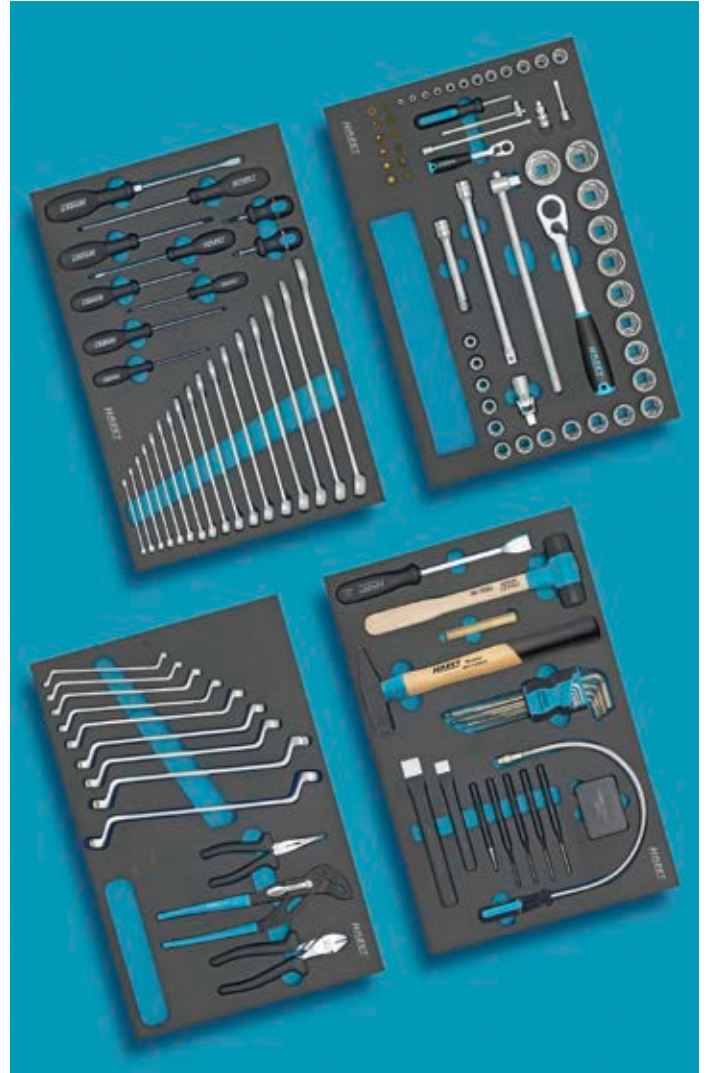

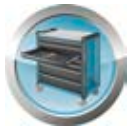











0-20 Tool assortment · with protective insulation

- Tool assortment for electricians
- IEC 60900:2018



- | | | |
|--|--|---|
| 
810VDE-22
0.4x2.5 · 0.6x3.5 · 0.8x4 | 
1816VDE-22 | 
1850VDE-22 |
| 
810VDE-PH · PH1 · PH2 | 
1826VDE-22 | 
1862N |
| 
839 · 0.5x2.8 | 
1841AVDE-22 | 
2154N-3 |
| 
1803VDE-33 | 
1841BVDE-33 | |





0-1900 Tool assortment

Assortment for car bodies
• For tool trolleys *Assistant*



- | | | |
|---------------------------------|------------------|-------------------|
| | | |
| 428 • ● | 1810-250 | 1937K |
| 6 • 7 • 8 • 10 • 11 • 13 | | |
| | 1851-44 | 1940 |
| 600N • ● | | |
| 8 • 9 • 10 • 11 | 1917N | 1944-1950 |
| 12 • 13 • 14 • 15 | | 1950 |
| 17 • 19 • 22 • 24 | 1919N | |
| | | 1960-5 |
| 745-3 | 1920N | |
| | | 1961L-2 |
| 745A-6 | 1921 | |
| | | 1961R-2 |
| 746-1 | 1922 | |
| | | 1965/5 |
| 757-10 | 1923 | |
| | | 2130 |
| 760-2 | 1927 | |
| | | 2140-30 • 2140-50 |
| 799-3 | 1929-1 | |
| | | 2143 |
| 801NK • ● | 1930 | |
| 1 x 5.5 | | 2150 |
| | | |
| 803 • ● | 1934 | 2165-1 • 2165-2 |
| 0.4 x 2.5 • 1 x 5.5 • 1.2 x 6.5 | | |
| 1.2 x 8 • 1.6 x 10 | 1934-1 | |
| | | |
| 803-PH • ● | 1934-4 | |
| PH1 • PH2 • PH3 | 1934 | |
| | | |
| 821-2 | 1934-9 • 1934-10 | |
| | | |
| 900 • ● • □ 1/2 | | |
| 10 • 11 • 12 • 13 | | |
| 15 • 17 • 19 • 22 | | |
| | | |
| 916HP • □ 1/2 | | |
| | | |
| 917-5 • □ 1/2 • □ 1/2 | | |
| | | |
| 918-10 • □ 1/2 • □ 1/2 | | |





Tool modules

163 Double open-end wrench set

Made in Germany

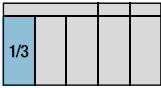

450N • ●
6x7 • 8x9 • 10x11 • 12x13
14x15 • 16x17 • 18x19 • 21x22

HAZET No.	L x W mm	□	EAN-No. 4000896+
163-95/8	342x172	8	145669

Made in Germany



For HAZET *Assistant* with drawer depth of 398 mm:
173 · 179 · 179N · 179NX · 179W · 179NW · 179BIG-1 · 179XL · 179NXL · 179XXL · 179NXXL · 179AXXL · 179TXXL · 180



450N • ●
6x7 • 8x9 • 10x11 • 12x13 • 14x15 • 16x18
17x19 • 20x22 • 21x23 • 24x27 • 30x32 • 34x36

HAZET No.	L x W mm	□	EAN-No. 4000896+
163-519/12	392x172	12	218684

163 Combination wrench set

Made in Germany

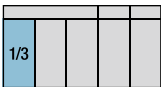

600N • ●
10 · 11 · 13 · 14 · 15 · 17 · 19 · 22

HAZET No.	L x W mm	□	EAN-No. 4000896+
163-292/8	342x172	8	186372

Made in Germany

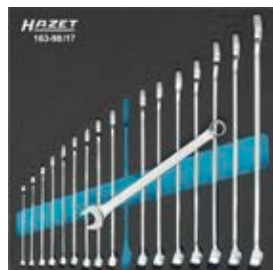
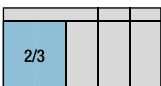

163 Combination wrench set



600N • ●
6 · 7 · 8 · 9 · 10 · 11
12 · 13 · 14 · 15 · 16 · 17
18 · 19 · 21 · 22 · 24

HAZET No.	L x W mm	□	EAN-No. 4000896+
163-98/17	344x342	17	145690

Made in Germany

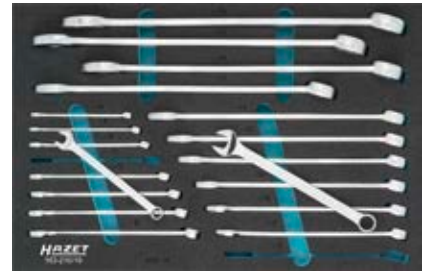
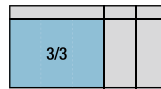

600N • ●
8 · 9 · 10 · 11 · 12 · 13 · 14
15 · 16 · 17 · 18 · 19 · 21 · 22
24 · 27 · 30 · 32 · 34

HAZET No.	L x W mm	□	EAN-No. 4000896+
163-210/19	519x342	19	164714

163 Wrench set

For HAZET *Assistant* with a drawer depth of 522 mm: 179NXXL-8D

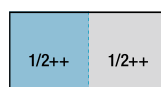

600N • ●
5.5 · 6 · 7 · 8 · 9
10 · 11 · 12 · 13 · 14
15 · 16 · 17 · 18 · 19
21 · 22 · 24 · 27 · 32



606 • ●
8 · 9 · 10 · 11 · 12
13 · 14 · 15 · 16 · 17
18 · 19 · 21 · 22 · 24
27 · 30 · 32



HAZET No.	L x W mm	□	EAN-No. 4000896+
163 D-9/42	522x435	42	245802

163 Combination wrench set

Made in Germany

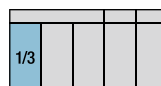





General workshop equipment

Tool modules



163 Combination wrench set

603
 ● 6 · 7 · 8 · 9
 ● 10 · 11 · 12 · 13 · 14 · 15 · 16 · 17 · 18 · 19 · 22

HAZET No.	L x W mm		EAN-No. 4000896+
163-428/15	342x172	15	202560

Made in Germany 

2/3			
-----	--	--	--

603
 ● 6 · 7 · 8 · 9
 ● 10 · 11 · 12 · 13 · 14 · 15 · 16 · 17 · 18 · 19 · 21 · 22 · 24 · 27



HAZET No.	L x W mm		EAN-No. 4000896+
163-99/18	344x342	18	145706

163 Ratcheting combination wrench set





1/3			
-----	--	--	--

606 ●
 8 · 10 · 12 · 13 · 17 · 19



HAZET No.	L x W mm		EAN-No. 4000896+
163-97/6	342x172	6	145683

For HAZET *Assistant* with drawer depth of 398 mm:
 173 · 179 · 179N · 179NX · 179W · 179NW · 179BIG-1 · 179XL · 179NXL · 179XXL · 179NXXL · 179AXXL · 179TXXL · 180



1/3+			
------	--	--	--

606 ●
 8 · 9 · 10 · 11 · 12 · 13
 14 · 15 · 16 · 17 · 18 · 19



HAZET No.	L x W mm		EAN-No. 4000896+
163-509/12	392x172	12	214969

For HAZET *Assistant* with drawer depth of 398 mm:
 173 · 179 · 179N · 179NX · 179W · 179NW · 179BIG-1 · 179XL · 179NXL · 179XXL · 179NXXL · 179AXXL · 179TXXL · 180



1/3+			
------	--	--	--



163 Ratcheting combination wrench set

606 ●
 8 · 9 · 10 · 11 · 12 · 13
 14 · 15 · 16 · 17 · 18 · 19





HAZET No.	L x W mm		EAN-No. 4000896+
163-515/16	392x172	16	218721

Made in Germany 

3/3			
-----	--	--	--

606 ●
 8 · 9 · 10 · 11 · 12
 13 · 14 · 15 · 16 · 17
 18 · 19 · 21 · 22 · 24
 27 · 30 · 32



HAZET No.	L x W mm		EAN-No. 4000896+
163-366/18	519x342	18	196920

163 Double box-end wrench set

Made in Germany 

For HAZET *Assistant* with drawer depth of 398 mm:
 173 · 179 · 179N · 179NX · 179W · 179NW · 179BIG-1 · 179XL · 179NXL · 179XXL · 179NXXL · 179AXXL · 179TXXL · 180

1/3+			
------	--	--	--

610N ●
 6x7 · 8x9 · 10x11 · 12x13
 14x15 · 16x17 · 18x19 · 20x22
 21x22 · 21x23 · 24x26 · 25x28
 27x32 · 30x32 · 30x34





HAZET No.	L x W mm		EAN-No. 4000896+
163-520/15	392x172	15	218677

Made in Germany 

For HAZET *Assistant* with drawer depth of 398 mm:
 173 · 179 · 179N · 179NX · 179W · 179NW · 179BIG-1 · 179XL · 179NXL · 179XXL · 179NXXL · 179AXXL · 179TXXL · 180

1/3+			
------	--	--	--

630 ●
 6x7 · 8x9 · 10x11
 12x13 · 14x15 · 16x17
 18x19 · 20x22 · 21x23



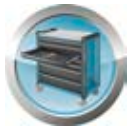

HAZET No.	L x W mm		EAN-No. 4000896+
163-518/9	392x172	9	218707

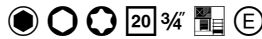

163 Wrench / socket set

Made in Germany



2/3			
-----	--	--	--

1010 • • 20 ^{3/4}
14 • 17 • 19 • 22

1012 • • 20 ^{3/4}
T 60 • T 80 • T 100

1058-1 • • 25 • ¹/₂ • 20 ^{3/4}
1058-2 • • 25 • ¹/₂ • 20 ^{3/4}



450N •
8x9 • 10x11
12x13 • 14x15
16x18 • 17x19
20x22 • 21x22
24x27 • 30x32
34x36

HAZET No.	L x W mm		EAN-No. 4000896+
163-211/20	344x342	20	164707

163 Tool set

Made in Germany



For HAZET *Assistant* with drawer depth of 398 mm:

173 · 179 · 179N · 179NX · 179W · 179NW · 179BIG-1 · 179XL · 179NXL · 179XXL · 179NXXL · 179AXXL · 179TXXL · 180

3/3+			
------	--	--	--



600N •
27 • 30 • 32

918-23 • • 12 ¹/₂ • 12 ¹/₂

1015-1 • • 20 ^{3/4}

650-20

1014

HAZET No.	L x W mm		EAN-No. 4000896+
163-371/7	519x392	7	196777

163 Wrench set

Made in Germany



For HAZET *Assistant* with drawer depth of 398 mm:

173 · 179 · 179N · 179NX · 179W · 179NW · 179BIG-1 · 179XL · 179NXL · 179XXL · 179NXXL · 179AXXL · 179TXXL · 180

3/3+			
------	--	--	--



163 Wrench set



450N •

6x7 • 8x9 • 10x11
12x13 • 14x15 • 16x17
18x19 • 21x22

600N •

6 • 7 • 8 • 9 • 10
11 • 12 • 13 • 14 • 15
16 • 17 • 18 • 19 • 21
22 • 24

630 •

6x7 • 8x9 • 10x11
12x13 • 14x15 • 16x17
18x19 • 21x22

HAZET No.	L x W mm		EAN-No. 4000896+
163-140/33	519x392	33	151899

For HAZET *Assistant* with drawer dimension of at least 398x694 mm:

179XL · 179NXL · 179XXL · 179NXXL
and 179AXXL · 179TXXL in the upper drawer



4/3+			
------	--	--	--

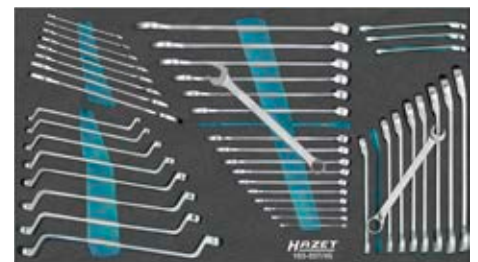

450N •

6x7 • 8x9
10x11 • 12x13
14x15 • 16x17
18x19 • 21x22

600N •

6 • 7 • 8 • 9
10 • 11 • 12 • 13
14 • 15 • 16 • 17
18 • 19 • 21 • 22
24

606 •

8 • 9 • 10 • 11
12 • 13 • 14 • 15
16 • 17 • 18 • 19

630 •

6x7 • 8x9
10x11 • 12x13
14x15 • 16x17
18x19 • 21x22

HAZET No.	L x W mm		EAN-No. 4000896+
163-507/45	691x392	45	214938

Made in Germany



For HAZET *Assistant* with drawer dimension of at least 398x694 mm:

179XL · 179NXL · 179XXL · 179NXXL
and 179AXXL · 179TXXL in the upper drawer

4/3+			
------	--	--	--



450N •

6x7 • 8x9 • 10x11
12x13 • 14x15 • 16x18
17x19 • 21x22 • 22x24
24x27 • 30x32 • 34x36

600N •

8 • 9 • 10 • 11 • 12
13 • 14 • 15 • 16 • 17
18 • 19 • 21 • 22 • 24
27 • 30 • 32 • 34

630 •

6x7 • 8x9 • 10x11
12x13 • 14x15 • 16x17
18x19 • 21x22 • 24x27

HAZET No.	L x W mm		EAN-No. 4000896+
163-478/40	691x392	40	207831



General workshop equipment

Tool modules



163 Wrench set

Made in Germany

For HAZET *Assistant* with drawer depth of 398 mm:
173 · 179 · 179N · 179NX · 179W · 179NW · 179BIG-1 · 179XL · 179NXL · 179XXL · 179NXXL · 179AXXL · 179TXXL · 180

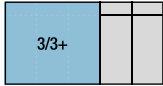
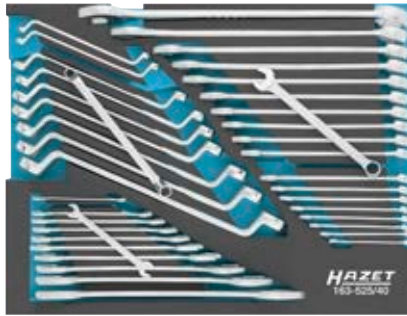

- 450N • ●
6x7 · 8x9 · 10x11 · 12x13 · 14x15 · 16x17 · 18x19 · 21x22 · 24x27 · 30x32 · 34x36
- 600N • ●
6 · 7 · 8 · 9 · 10 · 11 · 12 · 13 · 14 · 15 · 16 · 17 · 18 · 19 · 21 · 22 · 24 · 27 · 32
- 630 • ●
6x7 · 8x9 · 10x11 · 12x13 · 14x15 · 16x17 · 18x19 · 20x22 · 21x23 · 24x27

HAZET No.	L x W mm	□	EAN-No. 4000896+
163-525/40	519x392	40	218639

For HAZET *Assistant* with drawer dimension of at least 398 x 694 mm:
179XL · 179NXL · 179XXL · 179NXXL and 179AXXL · 179TXXL in the upper drawer

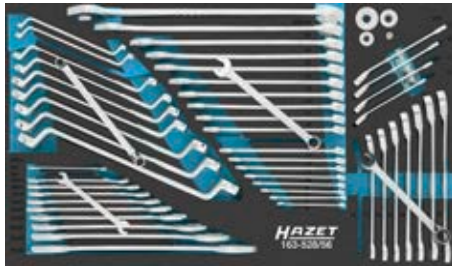

- 450N • ●
6x7 · 8x9 · 10x11 · 12x13 · 14x15 · 16x17 · 18x19 · 21x22 · 24x27 · 30x32 · 34x36
- 600N • ●
6 · 7 · 8 · 9 · 10 · 11 · 12 · 13 · 14 · 15 · 16 · 17 · 18 · 19 · 21 · 22 · 24 · 27 · 32
- 606/4-SPC
- 606 • ●
8 · 9 · 10 · 11 · 12 · 13 · 14 · 15 · 16 · 17 · 18 · 19
- 630 • ●
6x7 · 8x9 · 10x11 · 12x13 · 14x15 · 16x17 · 18x19 · 20x22 · 21x23 · 24x27

HAZET No.	L x W mm	□	EAN-No. 4000896+
163-528/56	691x392	56	218622

For HAZET *Assistant* with a drawer depth of 522 mm: 179NXXL-8D

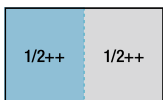

163 Wrench set



- 450N • ●
5x5.5 · 6x7 · 8x9 · 10x11 · 12x13 · 14x15 · 16x18 · 17x19 · 20x22 · 21x23 · 24x27 · 30x32 · 34x36
- 630 • ●
6x7 · 8x9 · 10x11 · 12x13 · 14x15 · 16x17 · 17x19 · 18x19 · 20x22 · 21x22 · 21x23 · 24x26 · 24x27 · 25x28 · 27x32 · 30x32 · 36x41

HAZET No.	L x W mm	□	EAN-No. 4000896+
163D-10/30	522x435	30	245819

163 Combination wrench / double box-end wrench set

Made in Germany

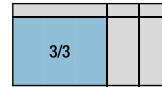
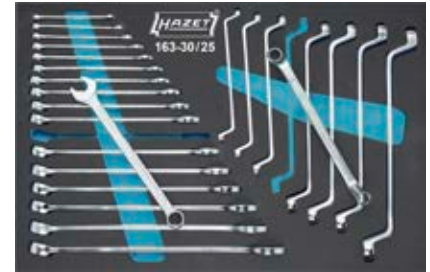

- 600N • ●
6 · 7 · 8 · 9 · 10 · 11 · 12 · 13 · 14 · 15 · 16 · 17 · 18 · 19 · 21 · 22 · 24
- 630 • ●
6x7 · 8x9 · 10x11 · 12x13 · 14x15 · 16x17 · 18x19 · 21x22

HAZET No.	L x W mm	□	EAN-No. 4000896+
163-30/25	519x342	25	118601

163 Wrench set

Made in Germany



For HAZET *Assistant* with drawer depth of 398 mm:
173 · 179 · 179N · 179NX · 179W · 179NW · 179BIG-1 · 179XL · 179NXL · 179XXL · 179NXXL · 179AXXL · 179TXXL · 180

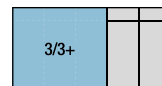

- 600N • ●
6 · 7 · 8 · 9 · 10 · 11 · 12 · 13 · 14 · 15 · 16 · 17 · 18 · 19 · 21 · 22 · 24
- 630 • ●
6x7 · 8x9 · 10x11 · 12x13 · 14x15 · 16x17 · 18x19 · 21x22 · 24x27 · 30x32

HAZET No.	L x W mm	□	EAN-No. 4000896+
163-374/27	519x392	27	196753



General workshop equipment

Tool modules



163 Screwdriver socket set

Made in Germany

For HAZET *Assistant* with drawer depth of 398 mm:
173 · 179 · 179N · 179NX · 179W · 179NW · 179BIG-1 · 179XL ·
179NXL · 179XXL · 179NXXL · 179AXXL · 179TXXL · 180

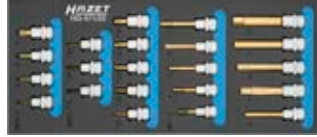
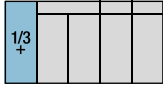
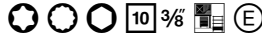

8801 · · 3/8
3 · 4 · 5 · 6 · 7
8 · 9 · 10 · 11 · 12

8802 · · 3/8
T15 · T20 · T25 · T27
T30 · T40 · T45 · T50

8808 · · 3/8
M5 · M6 · M8 · M10

HAZET No.	L x W mm		EAN-No. 4000896+
163-571/22	392x172	22	233434

163 Socket set

Made in Germany

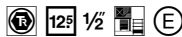

900 LG · · 1/2
10 · 12 · 13 · 14 · 15
16 · 17 · 18 · 19 · 21
22 · 24 · 27 · 30 · 32



HAZET No.	L x W mm		EAN-No. 4000896+
163-459/15	342x172	15	204649

For HAZET *Assistant* with a drawer depth of 522 mm: 179NXXL-8D

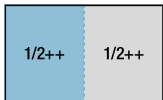

858-1 · 3/8 · 1/2

900 LG · · 1/2
10 · 12 · 13 · 14 · 15
16 · 17 · 18 · 19 · 21
22 · 24 · 27 · 30 · 32

958-1 · 3/8 · 1/2
958-2 · 3/8 · 1/2

985 · · 1/2
5 · 6 · 8 · 10
12 · 14 · 17 · 19

8858-1 · 1/2 · 3/8
8858-2 · 3/8 · 3/8

900 TZ · · 1/2
10 · 11 · 12 · 13 · 14
15 · 16 · 17 · 18 · 19
21 · 22 · 24 · 27 · 30

1058-2 · 1/2 · 3/8

HAZET No.	L x W mm		EAN-No. 4000896+
163-D/44	522x435	44	245758

163 Socket set

Made in Germany

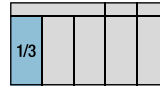

900 · · 1/2
10 · 11 · 12 · 13 · 14
15 · 16 · 17 · 18 · 19
21 · 22 · 24 · 27

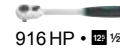

916 HP · 1/2



917-5 · 1/2 · 1/2

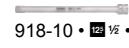

918-10 · 1/2 · 1/2



920 · 1/2 · 1/2

HAZET No.	L x W mm		EAN-No. 4000896+
163-191/18	342x172	18	162307

Made in Germany

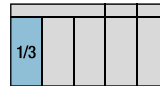

900 · · 1/2
10 · 11 · 12 · 13 · 14 · 15
16 · 17 · 18 · 19 · 21 · 22
24 · 27 · 30 · 32



917-5 · 1/2 · 1/2



920 · 1/2 · 1/2



986 · · 1/2
5 · 6 · 7 · 8 · 10 · 12 · 14



992 · · 1/2
T20 · T25 · T30
T40 · T45 · T50

HAZET No.	L x W mm		EAN-No. 4000896+
163-272/32	342x172	32	181414

163 Screwdriver socket set

Made in Germany

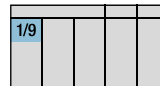
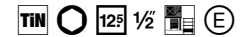

986 · · 1/2
5 · 6 · 7 · 8 · 10



HAZET No.	L x W mm		EAN-No. 4000896+
163-215/5	172x114	5	168217

Made in Germany

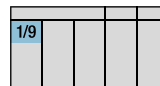
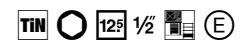

986 · · 1/2
5 · 6 · 7 · 8 · 10 · 12 · 14 · 17 · 19



HAZET No.	L x W mm		EAN-No. 4000896+
163-270/9	172x114	9	181063

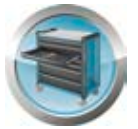

163 Screwdriver socket set

Made in Germany

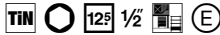

1/3			
-----	--	--	--



986 • • 12 1/2
5 • 6 • 7 • 8 • 10 • 12 • 14 • 17 • 19

986 KK • • 12 1/2
6 • 7 • 8 • 10

HAZET No.	L x W mm		EAN-No. 4000896+
163-220/13	342x172	13	168286

163 Screwdriver socket set · XZN

Made in Germany

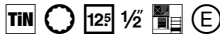

1/9			
-----	--	--	--

990 • • 12 1/2
M 6 • M 8 • M 10 • M 12
M 14 • M 16 • M 18



HAZET No.	L x W mm		EAN-No. 4000896+
163-243/7	172x114	7	178032

163 Socket set

Made in Germany

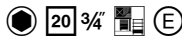

3/3		
-----	--	--



1000 • • 20 3/4
19 • 21 • 22 • 24
27 • 30 • 32 • 34
36 • 38 • 41 • 46
50 • 55 • 60

1014

1016 • • 20 3/4

1018 • • 20 3/4 • 20 3/4

1015-1 • • 20 3/4

1017-8 • • 20 3/4 • 20 3/4

HAZET No.	L x W mm		EAN-No. 4000896+
163-406/20	519x342	20	200054

Made in Germany

For HAZET Assistant with drawer depth of 398 mm:

173 ·
179 · 179N · 179NX · 179W ·
179NW · 179BIG-1 · 179XL ·
179NXL · 179XXL · 179NXXL ·
179AXXL · 179TXXL · 180



3/3+		
------	--	--

163 Socket set



850 • • 6.3 1/4
4 • 5 • 5.5 • 6
7 • 8 • 9 • 10
11 • 12 • 13 • 14

869 • • 6.3 1/4 • 6.3 1/4

903 SLG • • 12 1/2
17 • 19

850 LG • • 6.3 1/4
4 • 5 • 5.5 • 6
7 • 8 • 9 • 10
11 • 12 • 13

8501 • • 6.3 1/4
3 • 4 • 5 • 6 • 8

915 • • 12 1/2

8503 • • 6.3 1/4
0.6x3.5 • 1x5.5 • 1.2x8

916 HP • • 12 1/2

917-5 • • 12 1/2 • 12 1/2

858-1 • • 10 3/8 • 6.3 1/4

8506 • • 6.3 1/4
PH 1 • PH 2

918-10 • • 12 1/2 • 12 1/2

919-1 • • 12 1/2 • 12 1/2

863 HP • • 6.3 1/4

8507 • • 6.3 1/4
PZ 1 • PZ 2

920 • • 12 1/2 • 12 1/2

920 • • 12 1/2 • 12 1/2

865 • • 6.3 1/4

900 • • 12 1/2
10 • 11 • 12 • 13 • 14
15 • 16 • 17 • 18 • 19
20 • 21 • 22 • 24 • 27
30 • 32

958-1 • • 20 3/4 • 12 1/2

958-2 • • 10 3/8 • 12 1/2

866 U • • 6.3 1/4

867-2 • • 6.3 1/4 • 6.3 1/4

986 • • 12 1/2

986 • • 12 1/2

HAZET No.	L x W mm		EAN-No. 4000896+
163-138/77	519x392	77	151875

163 Tool set · TORX®

Made in Germany

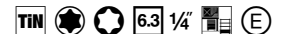

--	--	--



850 E • • 6.3 1/4
E 4 • E 5 • E 6 • E 7 • E 8 • E 10 • E 11

8502 • • 6.3 1/4
T 10 • T 15 • T 20 • T 25
T 27 • T 30 • T 40

HAZET No.	L x W mm		EAN-No. 4000896+
163-251/14	172x50	14	178063

163 Adapter set

Made in Germany

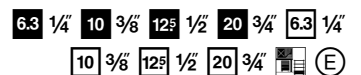

1/9		
-----	--	--



858-1 • • 10 3/8 • 6.3 1/4

958-1 • • 20 3/4 • 12 1/2

1058-2 • • 12 1/2 • 20 3/4

8858-1 • • 12 1/2 • 10 3/8

958-2 • • 10 3/8 • 12 1/2

8858-2 • • 6.3 1/4 • 10 3/8

HAZET No.	L x W mm		EAN-No. 4000896+
163-217/6	172x114	6	168231



General workshop equipment

Tool modules



163 Socket set

Made in Germany

6.3 1/4" 10 3/8" 12.5 1/2" 20 3/4"



858-1 • 10 3/8 • 6.3 1/4"

903 SLG • 12.5 1/2
17 • 19

958-1 • 20 3/4 • 12.5 1/2
958-2 • 10 3/8 • 12.5 1/2

8858-1 • 12.5 1/2 • 10 3/8
8858-2 • 6.3 1/4 • 10 3/8

1058-2 • 12.5 1/2 • 20 3/4

HAZET No.	L x W mm		EAN-No. 4000896+
163-131/8	519x50	8	153626

For HAZET Assistant with drawer depth of 398 mm:

173 · 179 · 179NX · 179W · 179NW · 179BIG-1 · 179XL · 179NXL · 179XXL · 179NXXL · 179AXXL · 179TXXL · 180

HiPer inside 12.5 1/2"

10 3/8" 6.3 1/4" 6.3 1/4"



609 •
E 6, E 8 • E 10, E 12
E 14, E 18 • E 20, E 24

880 • 10 3/8
7 • 8 • 9 • 10 • 11
12 • 13 • 14 • 15 • 16
17 • 18 • 19 • 21 • 22

850 E • 6.3 1/4
E 4 • E 5 • E 6 • E 7 • E 8

880 E • 10 3/8
E 10 • E 11 • E 12 • E 14

880 G • 10 3/8
10 • 11 • 12 • 13
14 • 15 • 16

880 G-E • 10 3/8
E 8 • E 10

880 LG • 10 3/8
10 • 11 • 12 • 13

8801 K • 10 3/8
9

8802 • 10 3/8
T 40 • T 45

8808 • 10 3/8
M 6 • M 8 • M 10

8816 HP • 10 3/8

8816 GK • 10 3/8

8820 • 10 3/8 • 10 3/8

8821 • 10 3/8 • 10 3/8
8821-3 • 8821-6 • 8821-10

8858-1 • 12.5 1/2 • 10 3/8
8858-2 • 6.3 1/4 • 10 3/8

900 E • 12.5 1/2
E 16 • E 18 • E 20 • E 24

992 • 12.5 1/2
T 50 • T 55 • T 60

2115 •
T 6 • T 7 • T 8 • T 9
T 10 • T 15 • T 20 • T 25
T 27 • T 30 • T 40

2215 N • 6.3 1/4 • 6.3 1/4
PH 1 • PH 2 • PH 3

2223 N • 6.3 1/4 • 6.3 1/4
T 6

2223 N • 6.3 1/4 • 6.3 1/4
T 7 H • T 8 H • T 9 H
T 10 H • T 15 H • T 20 H
T 25 H • T 27 H • T 30 H
T 40 H

2223 LG • 6.3 1/4 • 6.3 1/4
T 25

2250-1 • 6.3 1/4 • 6.3 1/4
2250-2 • 6.3 1/4 • 10 3/8

863 HPB • 6.3 1/4

HAZET No.	L x W mm		EAN-No. 4000896+
163-139/90	519x392	90	151882

163 Socket set · TORX® double box-end wrenches · sockets, etc.

HiPer inside 12.5 1/2"



609 •
E 6, E 8 • E 10, E 12
E 14, E 18 • E 20, E 24

803-T •
T 6 • T 7 • T 8 • T 9
T 10 • T 15 • T 20 • T 25
T 27 • T 30

850 E • 6.3 1/4
E 4 • E 5 • E 6 • E 7 • E 8

880 • 10 3/8
10 • 11 • 12 • 13
14 • 15 • 16 • 17
18 • 19 • 21 • 22

880 E • 10 3/8
E 10 • E 11 • E 12 • E 14

8802 • 10 3/8
T 40 • T 45

8816 HP • 10 3/8

8820 • 10 3/8 • 10 3/8

8821 • 10 3/8 • 10 3/8
8821-3 • 8821-6 • 8821-10

900 E • 12.5 1/2
E 16 • E 18 • E 20 • E 24

992 • 12.5 1/2
T 50 • T 55 • T 60

2115 •
T 6 • T 7 • T 8 • T 9
T 10 • T 15 • T 20 • T 25
T 27 • T 30 • T 40

2223 N • 6.3 1/4 • 6.3 1/4
T 6

2223 N • 6.3 1/4 • 6.3 1/4
T 7 H • T 8 H • T 9 H
T 10 H • T 15 H • T 20 H
T 25 H • T 27 H • T 30 H
T 40 H

2223 LG • 6.3 1/4 • 6.3 1/4
T 25

2250-1 • 6.3 1/4 • 6.3 1/4
2250-2 • 6.3 1/4 • 10 3/8

863 HPB • 6.3 1/4

HAZET No.	L x W mm		EAN-No. 4000896+
163-53/75	519x342	75	122783

163 Tool set · TORX®

Made in Germany

TIN 10 3/8"



880 E • 10 3/8
E 8 • E 10 • E 12 • E 14

8802 • 10 3/8
T 25 • T 30 • T 40 • T 45 • T 50

HAZET No.	L x W mm		EAN-No. 4000896+
163-252/9	172x50	9	178070



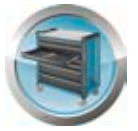

163 Socket set

For HAZET *Assistant* with drawer depth of 398 mm:

173 · 179 · 179N · 179NX · 179W · 179NW · 179BIG-1 · 179XL · 179NXL · 179XXL · 179NXXL · 179AXXL · 179TXXL · 180



3/3+	
------	--

- | | | |
|--|---|--|
| 850 • 6.3 1/4 | 867-4 • 6.3 1/4 • 6.3 1/4 | 903 SLG • 12 1/2 • 17 • 19 |
| 4 • 5 • 5.5 • 6
7 • 8 • 9 • 10
11 • 12 • 13 • 14 | 868 • 6.3 1/4 • 6.3 1/4 | 915 • 12 1/2 |
| 850 E • 6.3 1/4 | 869 • 6.3 1/4 • 6.3 1/4 | 916 HP • 12 1/2 |
| E 4 • E 5 • E 6 • E 7 • E 8 | 8858-1 • 12 1/2 • 10 3/8 | 919 • 12 1/2 • 12 1/2 |
| 8501 • 6.3 1/4 | 8858-2 • 6.3 1/4 • 10 3/8 | 919-1 • 919-5 • 919-10 |
| 3 • 4 • 5 • 6 | 900 • 6.3 1/4 • 12 1/2 | 920 • 12 1/2 • 12 1/2 |
| 8502 • 6.3 1/4 | 900 • 6.3 1/4 • 12 1/2 | 958-1 • 20 3/4 • 12 1/2 |
| T 10 • T 15 • T 20
T 25 • T 27 | 900 • 6.3 1/4 • 12 1/2 | 958-2 • 10 3/8 • 12 1/2 |
| 8503 • 6.3 1/4 | 900 E • 6.3 1/4 • 12 1/2 | 992 • 6.3 1/4 • 12 1/2 |
| 1 x 5.5 | E 10 • E 12 • E 14
E 16 • E 18 • E 20 | T 25 • T 27 • T 30 • T 40
T 45 • T 50 • T 55 • T 60 |
| 8506 • 6.3 1/4 | 900 SZ • 6.3 1/4 • 12 1/2 | 1058-2 • 12 1/2 • 20 3/4 |
| PH 1 • PH 2 | 32 • 36 | 2223 N • 6.3 1/4 • 6.3 1/4 |
| 858-1 • 10 3/8 • 6.3 1/4 | 900 Z • 6.3 1/4 • 12 1/2 | T 6 • T 7 • T 8 • T 9 |
| 863 HP • 6.3 1/4 | 8 • 9 • 10 • 12 • 13
14 • 15 • 16 • 17 • 18
19 • 21 • 22 • 24 • 27
30 • 32 | 2250-1 • 6.3 1/4 • 6.3 1/4 |
| 866 U • 6.3 1/4 | | |
| 867-2 • 6.3 1/4 • 6.3 1/4 | | |

HAZET No.	L x W mm		EAN-No. 4000896+
163-369/104	519x392	104	196722

163 Tool set



3/3	
-----	--

163 Tool set



- | | | | |
|------------------------------------|---------------------------|---|---|
| 751 HS/5 | 867-2 • 6.3 1/4 • 6.3 1/4 | 900 • 6.3 1/4 • 12 1/2 | 2105 LG/9 H • O |
| 850 • 6.3 1/4 | 880 • 6.3 1/4 • 10 3/8 | 13 • 14 • 15 • 16
17 • 18 • 19 • 21
22 • 24 • 27 • 30
32 | 2240 N/51 • 6.3 1/4 • 6.3 1/4 • 6.3 1/4 • 6.3 1/4 • 6.3 1/4 • 6.3 1/4 |
| 6 • 7 • 8 • 9
10 • 11 • 12 • 13 | 8816 HP • 10 3/8 | 916 HP • 12 1/2 | 2250-1 • 6.3 1/4 • 6.3 1/4 |
| 863 HP • 6.3 1/4 | 8821-10 • 10 3/8 • 10 3/8 | 917-5 • 12 1/2 • 12 1/2 | |

HAZET No.	L x W mm		EAN-No. 4000896+
163-329/100	519x342	100	191833

163 Socket set

For HAZET *Assistant* with drawer dimension of at least 398x694 mm: 179XL · 179NXL · 179XXL · 179NXXL and 179AXXL · 179TXXL in the upper drawer



4/3+	
------	--

- | | | |
|---|--|---|
| 760-2 | 880 • 6.3 1/4 • 10 3/8 | 917-5 • 12 1/2 • 12 1/2 |
| 810 SPC-6.3 • 6.3 1/4 | 10 • 11 • 12 • 13
14 • 15 • 16 • 17
18 • 19 • 21 • 22 | 918-10 • 12 1/2 • 12 1/2 |
| 850 • 6.3 1/4 | 8816 HP • 10 3/8 | 920 • 12 1/2 • 12 1/2 |
| 5.5 • 6 • 7 • 8 • 9
10 • 11 • 12 • 13 | 8820 • 10 3/8 • 10 3/8 | 958-2 • 10 3/8 • 12 1/2 |
| 850 E • 6.3 1/4 | 8821 • 10 3/8 • 10 3/8 | 992 • 6.3 1/4 • 12 1/2 |
| E 5 • E 6 • E 7 • E 8 • E 10 | 8821-3 • 8821-6 • 8821-10 | T 30 • T 40 • T 45
T 50 • T 55 |
| 8502 • 6.3 1/4 | 8858-2 • 6.3 1/4 • 10 3/8 | 1058-2 • 12 1/2 • 20 3/4 |
| T 10 • T 15 • T 20 • T 25
T 27 • T 30 • T 40 | 900 • 6.3 1/4 • 12 1/2 | 1802 M-22 |
| 863 HP • 6.3 1/4 | 10 • 11 • 12 • 13 • 14
15 • 16 • 17 • 18 • 19
20 • 21 • 22 • 23 • 24
26 • 27 • 28 • 30 • 32 | 1841 MB-33 |
| 867-2 • 6.3 1/4 • 6.3 1/4 | 900 E • 6.3 1/4 • 12 1/2 | 1850 M-22 |
| 868 • 6.3 1/4 • 6.3 1/4 | E 10 • E 12 • E 14
E 16 • E 18 • E 20 | 2240 N/51 • 6.3 1/4 • 6.3 1/4 • 6.3 1/4 • 6.3 1/4 • 6.3 1/4 • 6.3 1/4 |
| 869 • 6.3 1/4 • 6.3 1/4 | 915 • 12 1/2 | 2250-1 • 6.3 1/4 • 6.3 1/4 |
| | 916 HP • 12 1/2 | |

HAZET No.	L x W mm		EAN-No. 4000896+
163-508/138	691x392	138	214907



General workshop equipment

Tool modules



163 Socket set

For HAZET *Assistant* with drawer dimension of at least 398x694 mm: 179XL · 179NXL · 179XXL · 179NXXL and 179AXXL · 179TXXL in the upper drawer



810SPC-6.3 •

850 • •
3 • 4 • 5 • 6
7 • 8 • 9 • 10
11 • 12 • 13 • 14

850E • •
E4 • E5 • E6 • E8 • E10

8501 • •
3 • 4 • 5 • 6 • 8

8502 • •
T15 • T20 • T25
T27 • T30 • T40

8503 • •
0.6x3.5 • 1x5.5 • 1.2x8

8506 • •
PH1 • PH2

8507 • •
PZ1 • PZ2

850LG • •
4 • 5 • 6 • 7 • 8
9 • 10 • 11 • 12 • 13

858-1 • • •
10 • 11 • 12 • 13 • 14
15 • 16 • 17 • 18 • 19
20 • 21 • 22 • 23 • 24
26 • 27 • 28 • 30 • 32

863HP • •

865 • •

866U • •

867-2 • • •

868 • • •

869 • • •

880 • •
10 • 11 • 12 • 13
14 • 15 • 16 • 17
18 • 19 • 21 • 22

8801K • •
5 • 6 • 8 • 10

880LG • •
12 • 13 • 14 • 15
16 • 17 • 18 • 19

8816HP • •

8820 • • •

8821 • • •
8821-3 • 8821-6 • 8821-10

900 • •
10 • 11 • 12 • 13 • 14
15 • 16 • 17 • 18 • 19
20 • 21 • 22 • 23 • 24
26 • 27 • 28 • 30 • 32

915 • •

916HP • •

917-5 • • •

918-10 • • •

920 • • •

986 • •
4 • 5 • 6 • 7 • 8 • 9
10 • 12 • 17 • 19 • 22

990 • •
M 5 • M 6 • M 8 • M 10
M 12 • M 14 • M 16 • M 18

991 • •
M 6 • M 7 • M 8 • M 9
M 10 • M 12 • M 14

992 • •
T20 • T25 • T27
T30 • T40 • T45
T50 • T55 • T60

2240N/51
 • • • • •

2250-1 • • •

163 Socket set

For HAZET *Assistant* with drawer dimension of at least 398x694 mm: 179XL · 179NXL · 179XXL · 179NXXL and 179AXXL · 179TXXL in the upper drawer

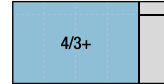
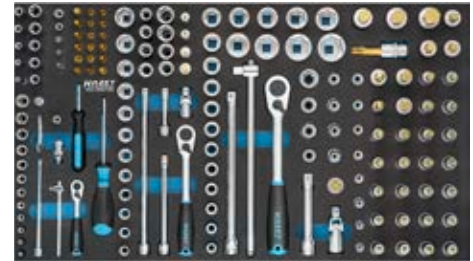
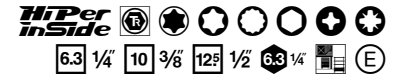

810SPC-6.3 •

850 • •
3 • 4 • 5 • 6
7 • 8 • 9 • 10
11 • 12 • 13 • 14

850E • •
E4 • E5 • E6 • E8 • E10

8501 • •
3 • 4 • 5 • 6 • 8

8502 • •
T15 • T20 • T25
T27 • T30 • T40

8503 • •
0.6x3.5 • 1x5.5 • 1.2x8

8506 • •
PH1 • PH2

8507 • •
PZ1 • PZ2

850LG • •
10 • 11 • 12 • 13 • 4
5 • 6 • 7 • 8 • 9

858-1 • • •

863HP • •

865 • •

866U • •

867-2 • • •

868 • • •

869 • • •

880 • •
10 • 11 • 12 • 13
14 • 15 • 16 • 17
18 • 19 • 21 • 22

880E • •
E 5 • E 6 • E 7 • E 8
E 10 • E 11 • E 12 • E 14

8801K • •
5 • 6 • 8 • 10

880LG • •
12 • 13 • 14 • 15
16 • 17 • 18 • 19

8816HP • •

8820 • • •

8821 • • •
8821-3 • 8821-6 • 8821-10

900 • •
10 • 11 • 12 • 13 • 14
15 • 16 • 17 • 18 • 19
20 • 21 • 22 • 23 • 24
26 • 27 • 28 • 30 • 32

900E • •
E 10 • E 11 • E 12 • E 14
E 16 • E 18 • E 20 • E 24

915 • •

916HP • •

917-5 • • •

918-10 • • •

920 • • •

986 • •
4 • 5 • 6 • 7
8 • 9 • 10 • 12
14 • 17 • 19 • 22

990 • •
M 5 • M 6 • M 8 • M 10
M 12 • M 14 • M 16 • M 18

991 • •
M 6 • M 7 • M 8 • M 9
M 10 • M 12 • M 14

992 • •
T20 • T25 • T27
T30 • T40 • T45
T50 • T55 • T60

2250-1 • • •

HAZET No.	L x W mm		EAN-No. 4000896+
163-481/194	691x392	194	208227

HAZET No.	L x W mm		EAN-No. 4000896+
163-549/160	691x392	160	224388



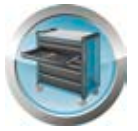

163 Socket set

For HAZET *Assistant* with a drawer depth of 522 mm: 179NXXL-8D



1/2++	1/2++
-------	-------

810SPC-6.3 • 6.3^{1/4}

850 • 3 • 4 • 5 • 6 • 7 • 8 • 9 • 10 • 11 • 12 • 13 • 14

850E • E10 • E4 • E5 • E6 • E8

850LG • 4 • 5 • 6 • 7 • 8 • 9 • 10 • 11 • 12 • 13

858-1 • 10 • 11 • 12 • 13

863HPB • 8 • 9 • 10 • 11 • 12 • 13

863HPS • 8 • 9 • 10 • 11 • 12 • 13

865 • 8 • 9 • 10 • 11 • 12 • 13

866U • 8 • 9 • 10 • 11 • 12 • 13

867-2 • 8 • 9 • 10 • 11 • 12 • 13

868 • 8 • 9 • 10 • 11 • 12 • 13

868-16 • 8 • 9 • 10 • 11 • 12 • 13

869 • 8 • 9 • 10 • 11 • 12 • 13

870 • 8 • 9 • 10 • 11 • 12 • 13

871-1 • 8 • 9 • 10 • 11 • 12 • 13

871-4 • 8 • 9 • 10 • 11 • 12 • 13

900 • 8 • 9 • 10 • 11 • 12 • 13

2200SC-1 • 8 • 9 • 10 • 11 • 12 • 13 • 14 • 15 • 16 • 17 • 18 • 19 • 20 • 21 • 22 • 23 • 24 • 26 • 27 • 28 • 30 • 32

900E • E10 • E11 • E12 • E14 • E16 • E18 • E20 • E24

915 • 10 • 11 • 12 • 13 • 14

916HPLG • 10 • 11 • 12 • 13 • 14

916HPS • 10 • 11 • 12 • 13 • 14

917-3 • 10 • 11 • 12 • 13 • 14

919 • 919-1 • 919-5 • 919-10

920 • 10 • 11 • 12 • 13 • 14

2250-1 • 10 • 11 • 12 • 13 • 14 • 15 • 16 • 17 • 18 • 19 • 20 • 21 • 22 • 23 • 24 • 26 • 27 • 28 • 30 • 32

HAZET No.	L x W mm	mm	EAN-No. 4000896+
163D-1/148	522x435	148	245727

163 Socket / screwdriver set



2/3			
-----	--	--	--

810SPC-6.3 • 6.3^{1/4}

850 • 5.5 • 6 • 7 • 8 • 9 • 10 • 11 • 12 • 13

863HP • 8 • 9 • 10 • 11 • 12 • 13

867-2 • 8 • 9 • 10 • 11 • 12 • 13

163 Socket / screwdriver set



868 • 6.3^{1/4} • 6.3^{1/4}

869 • 6.3^{1/4} • 6.3^{1/4}

900 • 10 • 11 • 12 • 13 • 14 • 15 • 16 • 17 • 18 • 19 • 20 • 21 • 22 • 23 • 24 • 26 • 27 • 28 • 30 • 32

915 • 12 • 13 • 14

916HP • 12 • 13 • 14

917-5 • 12 • 13 • 14 • 15 • 16 • 17 • 18 • 19

918-10 • 12 • 13 • 14 • 15 • 16 • 17 • 18 • 19

920 • 12 • 13 • 14 • 15 • 16 • 17 • 18 • 19

2204N • 3 • 4 • 5 • 6 • 8

2208N • 0.6x4.5 • 1x6 • 1.2x6.5

2215N • PH1 • PH3

2216N • PZ1 • PZ2

2223N • T15 • T20 • T25 • T30

2250-1 • 10 • 11 • 12 • 13 • 14

2304N • 6.3^{1/4} • 6.3^{1/4}

HAZET No.	L x W mm	mm	EAN-No. 4000896+
163-224/57	344x342	57	176311

163 Socket set

For HAZET *Assistant* with drawer depth of 398 mm: 173 · 179 · 179N · 179NX · 179W · 179NW · 179BIG-1 · 179XL · 179NXL · 179XXL · 179NXXL · 179AXXL · 179TXXL · 180



3/3+		
------	--	--

810SPC-6.3 • 6.3^{1/4}

850 • 5.5 • 6 • 7 • 8 • 9 • 10 • 11 • 12 • 13

850E • E5 • E6 • E7 • E8 • E10

863HP • 8 • 9 • 10 • 11 • 12 • 13

867-2 • 8 • 9 • 10 • 11 • 12 • 13

868 • 8 • 9 • 10 • 11 • 12 • 13

869 • 8 • 9 • 10 • 11 • 12 • 13

900E • E10 • E12 • E14 • E16 • E18 • E20

915 • 10 • 11 • 12 • 13 • 14

8816HP • 10 • 11 • 12 • 13

8820 • 10 • 11 • 12 • 13

8821 • 10 • 11 • 12 • 13

8821-3 • 8821-6 • 8821-10

8858-2 • 8 • 9 • 10 • 11 • 12 • 13

900 • 10 • 11 • 12 • 13 • 14 • 15 • 16 • 17 • 18 • 19 • 20 • 21 • 22 • 23 • 24 • 26 • 27 • 28 • 30 • 32

915 • 10 • 11 • 12 • 13 • 14

920 • 12 • 13 • 14 • 15 • 16 • 17 • 18 • 19

920 • 12 • 13 • 14 • 15 • 16 • 17 • 18 • 19

920 • 12 • 13 • 14 • 15 • 16 • 17 • 18 • 19

916HP • 12 • 13 • 14

917-5 • 12 • 13 • 14 • 15 • 16 • 17 • 18 • 19

918-10 • 12 • 13 • 14 • 15 • 16 • 17 • 18 • 19

920 • 12 • 13 • 14 • 15 • 16 • 17 • 18 • 19

958-2 • 10 • 11 • 12 • 13 • 14

1058-2 • 12 • 13 • 14 • 15 • 16 • 17 • 18 • 19

2240N/51 • 10 • 11 • 12 • 13 • 14 • 15 • 16 • 17 • 18 • 19

2250-1 • 10 • 11 • 12 • 13 • 14

HAZET No.	L x W mm	mm	EAN-No. 4000896+
163-513/122	519x392	122	214990



General workshop equipment

Tool modules



163 Tool set · TORX®

Made in Germany

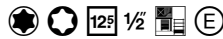

1/9			
-----	--	--	--



900 E • • 1/2
E 10 • E 12 • E 14 • E 16 • E 18 • E 20



992 • • 1/2
T 30 • T 40 • T 45 • T 50 • T 55 • T 60

HAZET No.	L x W mm		EAN-No. 4000896+
163-245/12	172x114	12	178049

163 Impact socket set

Made in Germany

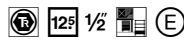

1/3			
-----	--	--	--



900 S • • 1/2
17 • 18 • 19 • 21
22 • 24 • 27



900 SLG • • 1/2
17 • 18 • 19 • 21
22 • 24 • 27



9006 S • • 1/2 • 1/2

HAZET No.	L x W mm		EAN-No. 4000896+
163-463/15	342x172	15	205066

Made in Germany

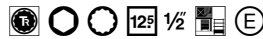

For HAZET Assistant® with drawer depth of 398 mm:
173 · 179 · 179N · 179NX · 179W · 179NW · 179BIG-1 · 179XL ·
179NXL · 179XXL · 179NXXL · 179AXXL · 179TXXL · 180

1/3+			
------	--	--	--



900 SZ6 • • 1/2,
19 • 21 • 22 • 24
27 • 30 • 32 • 36



985 S • • 1/2
14 • 17 • 19



990 S • • 1/2,
M 14 • M 16 • M 18



985 S • • 1/2
14 • 17 • 19



990 S • • 1/2,
M 14 • M 16 • M 18



1007 S-7/4 • • 1/2 • 3/4

HAZET No.	L x W mm		EAN-No. 4000896+
163-570/24	392x172	24	233441



163 Screwdriver socket set

Made in Germany

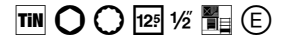

2/3			
-----	--	--	--



986 • • 1/2
5 • 6 • 7 • 8 • 10
12 • 14 • 17 • 19



990 • • 1/2
M 8 • M 10 • M 12
M 14 • M 16 • M 18



990 SLG • • 1/2
M 10 • M 12



986 KK • • 1/2
6 • 7 • 8 • 10



990 LG • • 1/2
M 8 • M 14

HAZET No.	L x W mm		EAN-No. 4000896+
163-119/23	344x342	23	153510

Made in Germany

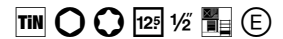

1/3			
-----	--	--	--



986 KK • • 1/2
5 • 6 • 8 • 10



992 SLG • • 1/2
T 30 • T 40 • T 45 • T 50

HAZET No.	L x W mm		EAN-No. 4000896+
163-468/8	342x172	8	205479

Made in Germany



2/3			
-----	--	--	--



986 • • 1/2
4 • 5 • 6 • 7 • 8 • 9
10 • 12 • 17 • 19 • 22



991 • • 1/2
M 6 • M 7 • M 8 • M 9
M 10 • M 12 • M 14



990 • • 1/2
M 5 • M 6 • M 8 • M 10
M 12 • M 14 • M 16 • M 18



992 • • 1/2
T 20 • T 25 • T 27 • T 30 • T 40
T 45 • T 50 • T 55 • T 60

HAZET No.	L x W mm		EAN-No. 4000896+
163-407/35	344x342	35	199990



163 Screwdriver socket set · TORX®

Made in Germany

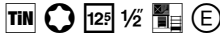

1/9			
-----	--	--	--



992 · · 1/2
 T20 · T25 · T27 · T30 · T40
 T45 · T50 · T55 · T60



HAZET No.	L x W mm		EAN-No. 4000896+
163-271/9	172x114	9	181056

Made in Germany

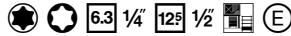

1/3			
-----	--	--	--



850E · · 1/4
 E 5 · E 6 · E 7 · E 8
 E 10 · E 11 · E 12



900E · · 1/2
 E 12 · E 14 · E 16
 E 18 · E 20 · E 24



992 · · 1/2
 T20 · T25 · T27
 T30 · T40 · T45
 T50 · T55 · T60



8502 · · 1/4
 T 8 · T 9 · T 10
 T 15 · T 20 · T 25
 T 27 · T 30 · T 40



992SLG · · 1/2
 T30 · T40 · T45 · T50

HAZET No.	L x W mm		EAN-No. 4000896+
163-587/35	342x172	35	239863

163 Screwdriver socket set

For HAZET *Assistant* with a drawer depth of 522 mm: 179NXXL-8D



1/2++	1/2++
-------	-------



8501 · · 1/4
 3 · 4 · 5 · 6 · 8



8506 · · 1/4
 PH1 · PH2



986KK · · 1/2
 5 · 6 · 7 · 8 · 10 · 12



8502 · · 1/4
 T 15 · T 20 · T 25
 T 27 · T 30 · T 40



8507 · · 1/4
 PZ1 · PZ2



986L · · 1/2
 4 · 5 · 6 · 7 · 8
 9 · 10 · 11 · 12 · 14



8503 · · 1/4
 0.6x3.5 · 1x5.5 · 1.2x8



986 · · 1/2
 4 · 5 · 6 · 7
 8 · 9 · 10 · 12
 14 · 17 · 19 · 22



986SL · · 1/2
 4 · 5 · 6 · 7 · 8
 9 · 10 · 11 · 12 · 14

163 Screwdriver socket set



990 · · 1/2
 M 5 · M 6 · M 8 · M 10
 M 12 · M 14 · M 16 · M 18



991 · · 1/2
 M 6 · M 7 · M 8 · M 9
 M 10 · M 12 · M 14



992H · · 1/2
 T30H · T40H · T45H
 T50H · T55H



990LG · · 1/2
 M8 · M14



992 · · 1/2
 T20 · T25 · T27
 T30 · T40 · T45
 T50 · T55 · T60



992SLG · · 1/2
 T30 · T40 · T45
 T50 · T55



990SLG · · 1/2
 M10 · M12

HAZET No.	L x W mm		EAN-No. 4000896+
163D-3/94	522x435	94	245741

163 Flexible nut-driver set

Made in Germany



1/3			
-----	--	--	--



426 ·
 5 · 6 · 7 · 8 · 10



HAZET No.	L x W mm		EAN-No. 4000896+
163-461/5	342x172	5	204625

163 Nut-driver set · with T-handle

Made in Germany



1/3			
-----	--	--	--



428 ·
 8 · 10 · 13

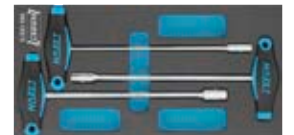

HAZET No.	L x W mm		EAN-No. 4000896+
163-122/3	342x172	3	153534

Made in Germany



For HAZET *Assistant* with drawer depth of 398 mm:
 173 · 179 · 179N · 179NX · 179W · 179NW · 179BIG-1 · 179XL ·
 179NXL · 179XXL · 179NXXL · 179AXXL ·
 179TXXL · 180

1/3+			
------	--	--	--



428 ·
 8 · 10 · 13



HAZET No.	L x W mm		EAN-No. 4000896+
163-382/3	392x172	3	196821



General workshop equipment

Tool modules



163 Socket set · with T-handle

For HAZET *Assistant* with a drawer depth of 522 mm: 179NXXL-8D

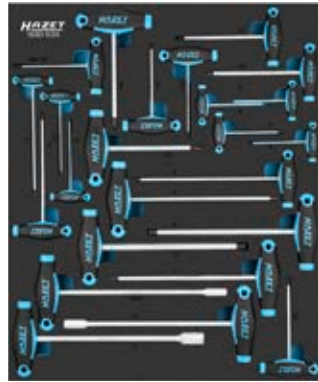

1/2++	1/2++
-------	-------

428 · ●
8 · 10 · 13

828 · ○
2 · 2.5 · 3 · 4 · 5
6 · 7 · 8 · 10

828-T · ⊙
T 6 · T 7 · T 8 · T 9
T 10 · T 15 · T 20 · T 25
T 27 · T 30 · T 40 · T 45

HAZET No.	L x W mm	□	EAN-No. 4000896+
163D-5/24	522x435	24	245765

163 HEXAnamic® screwdriver set

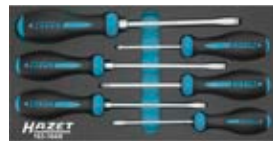

1/3			
-----	--	--	--

802 · ●
0.8x4 · 1x5.5 · 1.2x6.5 · 1.2x8

802-PH · ⊕
PH1 · PH2

HAZET No.	L x W mm	□	EAN-No. 4000896+
163-184/6	342x172	6	161461

163 Screwdriver set

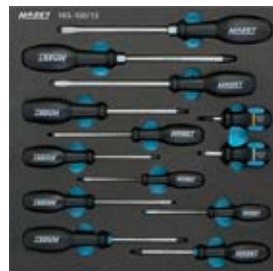

2/3			
-----	--	--	--

803 · ●
0.4x2.5 · 0.5x3 · 0.6x3.5
0.8x4 · 1.2x6.5 · 1.2x8

801NK-PH · ⊕
PH2

803-PZ · ⊕
PZ1 · PZ2

801NK · ●
1x5.5

803-PH · ⊕
PH1 · PH2 · PH3

HAZET No.	L x W mm	□	EAN-No. 4000896+
163-100/13	344x342	13	145713

163 Tool set



3/3		
-----	--	--

810/6 · ●, ●

810T/6 · ⊙

1859SPC/3

2140-50



HAZET No.	L x W mm	□	EAN-No. 4000896+
163-330/16	519x342	16	191826

163 Screwdriver set



2/3		
-----	--	--

810U-1/5 · ●, ●

810/6 · ●, ●

810T/6 · ⊙

2105LG/9H · ○



HAZET No.	L x W mm	□	EAN-No. 4000896+
163-297/26	344x342	26	186242

163 Universal set



3/3		
-----	--	--

730
730-3 · 730-6

746-1

748B
748B-3 · 748B-4
748B-5 · 748B-6

760-2

801NK · ●
1x5.5

801NK-PH · ⊕
PH2

803 · ●
0.4x2.5 · 0.5x3 · 0.6x3.5
0.8x4 · 1.2x6.5 · 1.2x8

803-PH · ⊕
PH1 · PH2 · PH3

1802M-22

1841MB-33

1850M-22

2105LG/9H · ○

2140-50

HAZET No.	L x W mm	□	EAN-No. 4000896+
163-120/24	519x342	24	153572

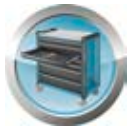

163 Screwdriver set

For HAZET *Assistant* with drawer depth of 398 mm:
173 · 179 · 179N · 179NX · 179W · 179NW · 179BIG-1 · 179XL · 179NXL · 179XXL · 179NXXL · 179AXXL · 179TXXL · 180



3/3+	
------	--

802 · ·
0.6x3.5 · 0.8x4 · 1x5.5
1.2x6.5 · 1.2x8 · 1.6x10
2x12

801NK · ·
1x5.5

803-T · ·
T 6 · T 7 · T 8 · T 9
T 10 · T 15 · T 20 · T 25
T 27 · T 30

802-PH · ·
PH 1 · PH 2 · PH 3

801NK-PH · ·
PH 2

2105LG/9H · ·

HAZET No.	L x W mm		EAN-No. 4000896+
163-141/31	519x392	31	151905

For HAZET *Assistant* with a drawer depth of 522 mm: 179NXXL-8D



1/2++	1/2++
-------	-------



802-TH · ·
T 8H · T 9H
T 10H · T 15H
T 20H · T 25H
T 30H

802 · ·
0.6x3.5 · 0.8x4
1x5.5 · 1.2x6.5
1.2x8 · 1.6x10
2x12

810U · ·
0.8x4.5 · 1x5.5
1.2x7

802-PH · ·
PH 0 · PH 1
PH 2 · PH 3

810U-PH · ·
PH 1 · PH 2 · PH 3

HAZET No.	L x W mm		EAN-No. 4000896+
163D-7/24	522x435	24	245789

163 HEXAnamic® screwdriver set



1/3			
-----	--	--	--

802-TH · ·
T 10H · T 15H · T 20H
T 25H · T 30H

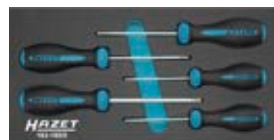

HAZET No.	L x W mm		EAN-No. 4000896+
163-185/5	342x172	5	161478

163 Screwdriver set · TORX®

For HAZET *Assistant* with drawer depth of 398 mm:
173 · 179 · 179N · 179NX · 179W · 179NW · 179BIG-1 · 179XL · 179NXL · 179XXL · 179NXXL · 179AXXL · 179TXXL · 180



1/3+			
------	--	--	--

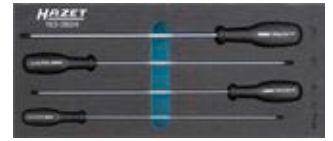

803LG-T · ·
T 15 · T 20 · T 25 · T 30

HAZET No.	L x W mm		EAN-No. 4000896+
163-380/4	392x172	4	196814

163 Electronic screwdriver set

For HAZET *Assistant* with drawer depth of 398 mm:
173 · 179 · 179N · 179NX · 179W · 179NW · 179BIG-1 · 179XL · 179NXL · 179XXL · 179NXXL · 179AXXL · 179TXXL · 180



1/3+			
------	--	--	--

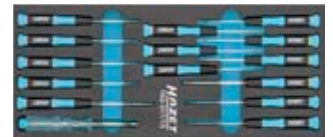

805/7 · · · ·
808/7 · · · ·
839 · ·
0.5x2.8

HAZET No.	L x W mm		EAN-No. 4000896+
163-517/15	392x172	15	218745

163 Screwdriver set

For HAZET *Assistant* with drawer dimension of at least 398x694 mm:
179XL · 179NXL · 179XXL · 179NXXL
and 179AXXL · 179TXXL in the upper drawer



4/3+			
------	--	--	--



801NK · ·
0.6x3.5 · 1x5.5

808/7 · · · ·

810-PH · ·
PH 0 · PH 1 · PH 2

810U-PH · ·
PH 1 · PH 2

801NK-PH · ·
PH 1 · PH 2

810-T · ·
T 10 · T 15 · T 20
T 25 · T 27 · T 30

839 · ·
0.5x2.8

805/7 · · · ·
810 · ·
0.4x2.5 · 0.5x3
0.8x4 · 1x5.5
1.2x6.5

810U · ·
0.8x4.5 · 1x5.5
1.2x7

2105LG/9H · ·
2116LG/8H · ·

HAZET No.	L x W mm		EAN-No. 4000896+
163-527/56	691x392	56	218691



General workshop equipment

Tool modules



163 Screwdriver set

For HAZET *Assistant* with drawer depth of 398 mm:
173 · 179 · 179N · 179NX · 179W · 179NW ·
179BIG-1 · 179XL · 179NXL ·
179XXL · 179NXXL · 179AXXL ·
179TXXL · 180

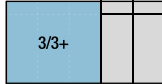

- | | | | |
|------------------------------|--|---|-----------------------------------|
| 801NK • ●
0.6x3.5 · 1x5.5 | 810 • ●
0.4x2.5 · 0.5x3
0.8x4 · 1x5.5
1.2x6.5 | 810-T • ⊕
T 10 · T 15 · T 20
T 25 · T 27 · T 30 | 810U-PH • ⊕
PH 1 · PH 2 · PH 3 |
| 801NK-PH • ⊕
PH 1 · PH 2 | 810-PH • ⊕
PH 0 · PH 1 · PH 2 | 810U • ●
0.8x4.5 · 1x5.5
1.2x7 | 2105LG/9H • ○
2116LG/8H • ⊙ |

HAZET No.	L x W mm	□	EAN-No. 4000896+
163-526/41	519x392	41	218646

For HAZET *Assistant* with drawer depth of 398 mm:
173 · 179 · 179N · 179NX · 179W · 179NW · 179BIG-1 ·
179XL · 179NXL · 179XXL · 179NXXL · 179AXXL · 179TXXL · 180

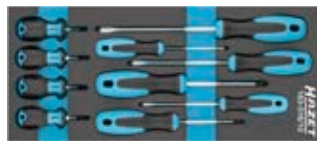

- | | | | |
|------------------------------|-----------------------------|---|---------------------------|
| 801NK • ●
0.6x3.5 · 1x5.5 | 801NK-PH • ⊕
PH 1 · PH 2 | 810 • ●
0.5x3 · 0.8x4
1x5.5 · 1.2x6.5 | 810-PH • ⊕
PH 1 · PH 2 |
|------------------------------|-----------------------------|---|---------------------------|

HAZET No.	L x W mm	□	EAN-No. 4000896+
163-516/10	392x172	10	218738

For HAZET *Assistant* with drawer dimension of at least
398x694 mm:
179XL · 179NXL · 179XXL · 179NXXL
and 179AXXL · 179TXXL in the upper drawer

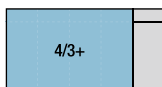

- | | | | |
|------------------------------|--|--------------|-----------|
| 801NK • ●
0.6x3.5 · 1x5.5 | 802 • ●
0.8x4 · 1x5.5 · 1.2x6.5
1.2x8 · 1.6x10 | 805/7 • ⊕, ● | 808/7 • ⊙ |
| 801NK-PH • ⊕
PH 1 · PH 2 | 802-PH • ⊕
PH 0 · PH 1 · PH 2 · PH 3 | 808/7 • ⊙ | |

163 Screwdriver set



- | | | |
|---|---|---------------|
| 810 • ●
0.5x3 · 0.8x4
1x5.5 · 1.2x6.5 | 810-T • ⊕
T 10 · T 15 · T 20
T 25 · T 27 · T 30 | 2105LG/9H • ○ |
| 810-PH • ⊕
PH 1 · PH 2 | 839 • ●
0.5x2.8 | 2116LG/8H • ⊙ |

HAZET No.	L x W mm	□	EAN-No. 4000896+
163-480/57	691x392	57	208234

For HAZET *Assistant* with a drawer depth
of 522 mm: 179NXXL-8D

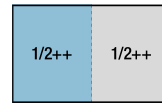

- | | | | |
|---------------------------------------|--|--|---|
| 801NK • ●
0.6x3.5 · 1x5.5
1.2x8 | 808/7 • ⊙ | 810 • ●
0.4x2.5 · 0.5x3
0.8x4 · 1x5.5
1.2x6.5 | 2105LG/9H • ○
2116LG/8H • ⊙ |
| 801NK-PH • ⊕
PH 1 · PH 2 | 810 • ●
0.4x2.5 · 0.5x3
0.8x4 · 1x5.5
1.2x6.5 | 810-PH • ⊕
PH 1 · PH 2 | 810-T • ⊕
T 10 · T 15 · T 20
T 25 · T 27 · T 30 |
| 805/7 • ⊕, ● | 810-PH • ⊕
PH 1 · PH 2 | 810-PZ • ⊕
PZ 1 · PZ 2 | 839 • ●
0.5x2.8 |
| 805C • ●
0.4x2.5 | 810-PZ • ⊕
PZ 1 · PZ 2 | | |

HAZET No.	L x W mm	□	EAN-No. 4000896+
163D-6/53	522x435	53	245772

For HAZET *Assistant* with drawer depth of 398 mm:
173 · 179 · 179N · 179NX · 179W · 179NW · 179BIG-1 ·
179XL · 179NXL · 179XXL · 179NXXL · 179AXXL · 179TXXL · 180

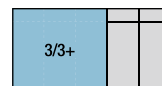
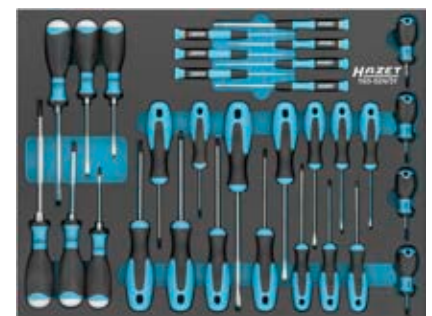

- | | | | |
|------------------------------|--|---|--------------------------------------|
| 801NK • ●
0.6x3.5 · 1x5.5 | 805/7 • ⊕, ● | 810-PH • ⊕
PH 0 · PH 1 · PH 2 | 810U • ●
0.8x4.5 · 1x5.5
1.2x7 |
| 801NK-PH • ⊕
PH 1 · PH 2 | 810 • ●
0.4x2.5 · 0.5x3 ·
0.8x4 · 1x5.5
1.2x6.5 | 810-T • ⊕
T 10 · T 15 · T 20
T 25 · T 27 · T 30 | 810U-PH • ⊕
PH 1 · PH 2 · PH 3 |

HAZET No.	L x W mm	□	EAN-No. 4000896+
163-524/31	519x392	31	218653



163 Screwdriver set · TORX®



1/3				
-----	--	--	--	--

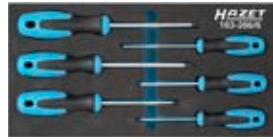

810-T ·
 T 10 · T 15 · T 20 · T 25 · T 27 · T 30

HAZET No.	L x W mm		EAN-No. 4000896+
163-266/6	342x172	6	180615

163 Screwdriver set · with impact cap



1/3				
-----	--	--	--	--



810U ·
 0.8x4.5 · 1x5.5 · 1.2x7



810U-PH ·
 PH1 · PH2

HAZET No.	L x W mm		EAN-No. 4000896+
163-264/5	342x172	5	180592

163 Screwdriver set

For HAZET *Assistant* with drawer depth of 398 mm:
173 · 179 · 179N · 179NX · 179W · 179NW · 179BIG-1 · 179XL · 179NXL · 179XXL · 179NXXL · 179AXXL · 179TXXL · 180



1/3+				
------	--	--	--	--

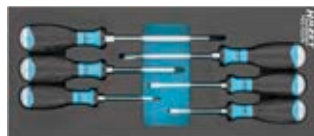

810U ·
 0.8x4.5 · 1x5.5 · 1.2x7



810U-PH ·
 PH1 · PH2 · PH3

HAZET No.	L x W mm		EAN-No. 4000896+
163-522/6	392x172	6	218660

163 Screwdriver set · with T-handle



1/3				
-----	--	--	--	--



828-T ·
 T 6 · T 7 · T 8 · T 9 · T 10 · T 15 · T 20 · T 25 · T 30

HAZET No.	L x W mm		EAN-No. 4000896+
163-182/9	342x172	9	162352

163 Hose clamp pliers set

Made in Germany



1/3				
-----	--	--	--	--



798-3



798-13



798-17

HAZET No.	L x W mm		EAN-No. 4000896+
163-425/3	342x172	3	202614

163 Pliers set

Made in Germany



1/3				
-----	--	--	--	--



760-2



1802-22



1841 A-22

HAZET No.	L x W mm		EAN-No. 4000896+
163-96/3	342x172	3	145676

Made in Germany

For HAZET *Assistant* with drawer depth of 398 mm:
173 · 179 · 179N · 179NX · 179W · 179NW · 179BIG-1 · 179XL · 179NXL · 179XXL · 179NXXL · 179AXXL · 179TXXL · 180



1/3+				
------	--	--	--	--



760-2



1802 M-22



1841 MB-33



1850 M-22

HAZET No.	L x W mm		EAN-No. 4000896+
163-511/4	392x172	4	214976

Made in Germany

For HAZET *Assistant* with drawer depth of 398 mm:
173 · 179 · 179N · 179NX · 179W · 179NW · 179BIG-1 · 179XL · 179NXL · 179XXL · 179NXXL · 179AXXL · 179TXXL · 180



1/3+				
------	--	--	--	--



1802 M-33



1841 MA-11



1850 M-33

HAZET No.	L x W mm		EAN-No. 4000896+
163-375/5	392x172	5	196838



General workshop equipment

Tool modules



163 Pliers set

Germany Made in Germany



1/3			
-----	--	--	--



- 755-10 A 1802M-33 1803M-11 1841 MA-11

HAZET No.	L x W mm	■	EAN-No. 4000896+
163-121/4	342x172	4	153541

163 Circlip pliers set

Germany Made in Germany



1/3			
-----	--	--	--



- 1845A-19 1845B-19 1845C-19 1845D-19

HAZET No.	L x W mm	■	EAN-No. 4000896+
163-124/4	342x172	4	153602

163 Pliers set

Germany Made in Germany



2/3			
-----	--	--	--



- 757-10 1841A-22 1846C-2
 760-2 1846A-2 1846D-2
 1802-22 1846B-2 1850-22

HAZET No.	L x W mm	■	EAN-No. 4000896+
163-424/9	344x342	9	202546

163 Pliers set

For HAZET Assistant with a drawer depth of 522 mm: 179NXXL-8D



1/2++	1/2++
-------	-------



- 760-2 1846 A 1846 D
 1802-33 1846 A-2 • 1846 A-3 1846 D-2 • 1846 D-3
 1841 A-33 1846 B 1846 B-2 • 1846 B-3
 1841 B-33 1846 C 1846 C-2 • 1846 C-3
 1850-33

HAZET No.	L x W mm	■	EAN-No. 4000896+
163D-8/13	522x435	13	245796

163 File set

Germany Made in Germany



1/3			
-----	--	--	--



- 2119-8 2120-8 2122-8 2123-8

HAZET No.	L x W mm	■	EAN-No. 4000896+
163-426/4	342x172	4	202621

163 Hammer set

Germany Made in Germany



1/3			
-----	--	--	--



- 1952-28 2140-40 2142-1

HAZET No.	L x W mm	■	EAN-No. 4000896+
163-464/3	342x172	3	205059

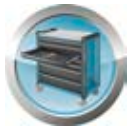

163 Drift pin set

Made in Germany

For HAZET *Assistant* with drawer depth of 398 mm:
173 · 179 · 179N · 179NX · 179W · 179NW · 179BIG-1 · 179XL · 179NXL · 179XXL · 179NXXL · 179AXXL · 179TXXL · 180

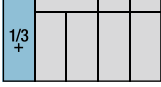

HAZET No.	L x W mm		EAN-No. 4000896+
163-510/8	392x172	8	215003

163 Universal set

Made in Germany

For HAZET *Assistant* with drawer dimension of at least 398x694 mm:
179XL · 179NXL · 179XXL · 179NXXL
and 179AXXL · 179TXXL in the upper drawer

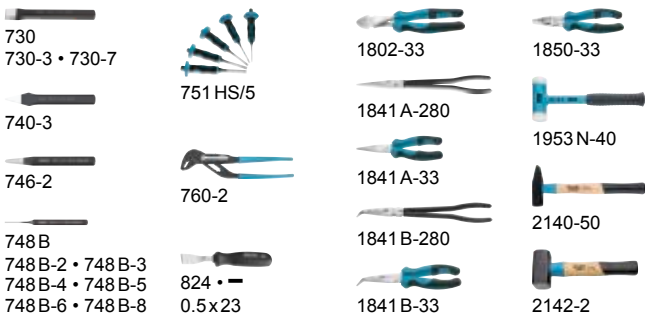
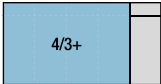

HAZET No.	L x W mm		EAN-No. 4000896+
163-479/26	691x392	26	208104

For HAZET *Assistant* with drawer depth of 398 mm:
173 · 179 · 179N · 179NX · 179W · 179NW · 179BIG-1 · 179XL · 179NXL · 179XXL · 179NXXL · 179AXXL · 179TXXL · 180

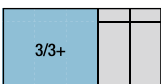

163 Universal set

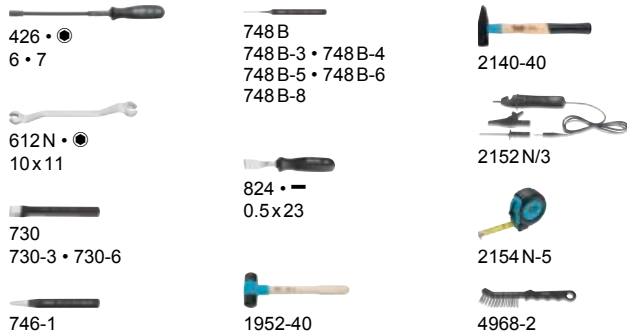

HAZET No.	L x W mm		EAN-No. 4000896+
163-143/18	519x392	17	151929

163 Tool set · offset screwdriver · various tools

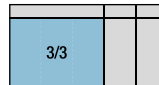

HAZET No.	L x W mm		EAN-No. 4000896+
163-60/22	519x342	22	122851

163 Universal set

Made in Germany

For HAZET *Assistant* with drawer depth of 398 mm:
173 · 179 · 179N · 179NX · 179W · 179NW · 179BIG-1 · 179XL · 179NXL · 179XXL · 179NXXL · 179AXXL · 179TXXL · 180

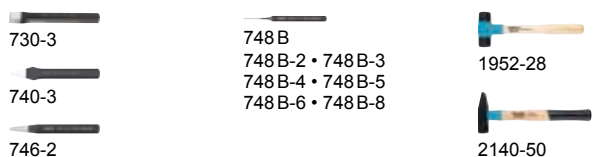
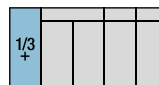

HAZET No.	L x W mm		EAN-No. 4000896+
163-523/11	392x172	11	218714



General workshop equipment

Tool modules



163 Universal set

For HAZET *Assistant* with drawer depth of 398 mm:
173 · 179 · 179N · 179NX · 179W · 179NW · 179BIG-1 ·
179XL · 179NXL · 179XXL · 179NXXL · 179AXXL · 179TXXL · 180



3/3+		
------	--	--

- 612N • ●
10x11
- 666-5
- 730
730-3 • 730-6
- 746-1
- 748B
748B-3 • 748B-4
748B-5 • 748B-6
748B-8
- 824 • -
0.5x23
- 1952-40
- 1976-2
- 1977-2/4
- 2140-40
- 2147MS
- 2152N/3
- 2154N-5
- 2157-1
- 4968-2

HAZET No.	L x W mm	■	EAN-No. 4000896+
163-372/25	519x392	25	196760

For HAZET *Assistant* with a drawer depth of 522 mm: 179NXXL-8D



163 Tool set

For HAZET *Assistant* with a drawer depth of 522 mm: 179NXXL-8D



1/2++	1/2++
-------	-------

- 730
730-3 • 730-7
- 740-3
- 746-2
- 748B
748B-2 • 748B-3
748B-4 • 748B-5
748B-6 • 748B-8
- 751 HS/5
- 824 • -
0.5x23
- 1953N-40
- 1976-2
- 1977-2/4
- 2140-50
- 2142-2
- 2147MS
- 2152N/3
- 2154-10
- 2154N-5

HAZET No.	L x W mm	■	EAN-No. 4000896+
163D-12/30	522x435	30	245833

163 Universal brake tool set



1/2++	1/2++
-------	-------



- 755-10A
- 757-10
- 1980N
- 1981
- 2119-8
- 2120-8
- 2122-8
- 2123-8
- 2157-07
- 2157-1
- 4968-2

HAZET No.	L x W mm	■	EAN-No. 4000896+
163D-11/11	522x435	11	245826

1/3		
-----	--	--



- 751 KHS-3
- 751 KHS-4
- 748LGB
748LGB-3 • 748LGB-4
- 810U-PH • ⊕
PH3
- 8801K • ○ • □^{3/8}
7
- 986 • ○ • □^{1/2}
9
- 986L • ○ • □^{1/2}
9 • 11
- 2584-8 • ○ • □^{3/8}
8
- 2784 • ○ • □^{3/8}
7
- 2901G • ○ • □^{3/8}
7
- 4968-2
- 4968-6

HAZET No.	L x W mm	■	EAN-No. 4000896+
163-548/14	342x172	14	224197

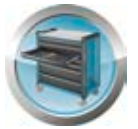

163 Pliers set · with protective insulation

Made in Germany



1/3				
-----	--	--	--	--



- 1802 VDE-22
- 1804 VDE-33
- 1860 VDE-11

HAZET No.	L x W mm		EAN-No. 4000896+
163-227/3	342x172	3	177868

Made in Germany



1/3				
-----	--	--	--	--



- 759N-2VDE
- 1803 VDE-22
- 1841 BVDE-33
- 1850 VDE-22

HAZET No.	L x W mm		EAN-No. 4000896+
163-226/4	342x172	4	177875

163 Open-end wrench set · with protective insulation

Made in Germany



For HAZET Assistant with drawer depth of 398 mm:
173 · 179 · 179N · 179NX · 179W · 179NW · 179BIG-1 · 179XL · 179NXL · 179XXL · 179NXXL · 179AXXL · 179TXXL · 180

2/3+				
------	--	--	--	--

- 450 KV · ●
- 7 · 8 · 9 · 10 · 11
- 12 · 13 · 14 · 15 · 16
- 17 · 18 · 19 · 22 · 24
- 27 · 30 · 32



HAZET No.	L x W mm		EAN-No. 4000896+
163-542/18	392x344	18	223626



163 Box-end wrench set · with protective insulation

Made in Germany



For HAZET Assistant with drawer depth of 398 mm:
173 · 179 · 179N · 179NX · 179W · 179NW · 179BIG-1 · 179XL · 179NXL · 179XXL · 179NXXL · 179AXXL · 179TXXL · 180

2/3+				
------	--	--	--	--

- 630 KV · ●
- 7 · 8 · 9 · 10 · 11
- 12 · 13 · 14 · 15 · 16
- 17 · 18 · 19 · 22 · 24
- 27 · 30 · 32



HAZET No.	L x W mm		EAN-No. 4000896+
163-543/18	392x344	18	223831

163 Socket set · with protective insulation

For HAZET Assistant with drawer depth of 398 mm:



173 · 179 · 179N · 179NX · 179W · 179NW · 179BIG-1 · 179XL · 179NXL · 179XXL · 179NXXL · 179AXXL · 179TXXL · 180

2/3+				
------	--	--	--	--

- 880 KV · ● · 10 3/8
- 6 · 7 · 8 · 9 · 10
- 11 · 12 · 13 · 14 · 16
- 17 · 18 · 19 · 20 · 22
- 8802 KV · ● · 10 3/8
- T 10 · T 15 · T 20
- T 25 · T 27 · T 30
- T 40 · T 45 · T 50
- 8808 LgKV · ● · 10 3/8
- M 8 · M 10 · M 12
- 8816 KV · 10 3/8
- 8801 K-KV · ● · 10 3/8
- 5 · 6
- 8802 KV-LG · ● · 10 3/8
- T 10 · T 15 · T 20 · T 25
- T 30 · T 40 · T 45 · T 50
- 8821 KV · 10 3/8 · 10 3/8
- 8821 KV-3 · 8821 KV-5



HAZET No.	L x W mm		EAN-No. 4000896+
163-545/41	392x344	41	223855

1/3				
-----	--	--	--	--

- 880 KV · ● · 10 3/8
- 6 · 7 · 8 · 9 · 10
- 11 · 12 · 13 · 14 · 16
- 17 · 18 · 19 · 20 · 22
- 8816 KV · 10 3/8
- 8821 KV · 10 3/8 · 10 3/8
- 8821 KV-3 · 8821 KV-5

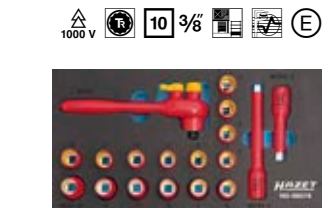

HAZET No.	L x W mm		EAN-No. 4000896+
163-580/18	342x172	18	235520



General workshop equipment

Tool modules



163 Socket set · with protective insulation

For HAZET *Assistant* with drawer depth of 398 mm:

173 · 179 · 179N · 179NX · 179W · 179NW · 179BIG-1 · 179XL · 179NXL · 179NXXL · 179XXL · 179NXXL · 179AXXL · 179TXXL · 180

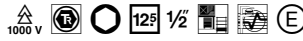

2/3+			
------	--	--	--



900KV · 10 · 11 · 12 · 13 · 14 · 15 · 16 · 17 · 18 · 19 · 20 · 22 · 23 · 24 · 26 · 27 · 30 · 32



986LGKV · 4 · 5 · 6 · 8 · 10



917/918KV · 917KV-5 · 918KV-10



916KV

HAZET No.	L x W mm	□	EAN-No. 4000896+
163-544/26	392x344	26	223848

163 Screwdriver set · with protective insulation



1/3			
-----	--	--	--



810VDE · 0.4x2.5 · 0.5x3 · 0.6x3.5 · 0.8x4



810VDE-PH · PH1 · PH2 · PH3

HAZET No.	L x W mm	□	EAN-No. 4000896+
163-229/7	342x172	7	177844



2/3			
-----	--	--	--



810VDE · 0.4x2.5 · 0.5x3 · 0.6x3.5 · 0.8x4



810VDE-PH · PH1 · PH2 · PH3



810VDE-T · T20 · T25 · T30



839 · 0.5x2.8



2156VDE-2

HAZET No.	L x W mm	□	EAN-No. 4000896+
163-546/12	344x342	12	223619

163 Soft foam insert · with compartments for small pieces

Made in Germany

- **Safety-Insert-System** – all tools are snugly embedded
- **Missing tools are noticed immediately**
- For all HAZET tool trolleys *Assistant* with drawers
- For tool trolleys *Assistant* 173 · 179 · 179N · 179NX · 179BIG-1 · 179XL · 179NXL · 179NXXL · 179W · 179NW we also recommend soft foam inserts 163-172x50 or 163-522x50

1/3			
-----	--	--	--



HAZET No.	L x W mm	EAN-No. 4000896+
163-130 L	342x172	153589

Made in Germany

- **Safety-Insert-System** – all tools are snugly embedded
- **Missing tools are noticed immediately**
- For all HAZET tool trolleys *Assistant* with drawers
- For tool trolleys *Assistant* 173 · 179 · 179N · 179NX · 179BIG-1 · 179XL · 179NXL · 179NXXL · 179W · 179NW we also recommend soft foam inserts 163-172x50 or 163-522x50
- 1 compartment for small pieces
- H 33xW 172xD 50 mm
- For *Assistant* 173 · 179 · 179N · 179NX · 179BIG-1 · 179XL · 179NXL · 179NXXL · 179W · 179NW



HAZET No.	L x W mm	EAN-No. 4000896+
163-172 x 50	172x50	154692

Made in Germany

- **Safety-Insert-System** – all tools are snugly embedded
- **Missing tools are noticed immediately**
- For all HAZET tool trolleys *Assistant* with drawers
- For tool trolleys *Assistant* 173 · 179 · 179N · 179NX · 179BIG-1 · 179XL · 179NXL · 179NXXL · 179W · 179NW we also recommend soft foam inserts 163-172x50 or 163-522x50
- 3 compartments for small pieces
- H 33xW 522xD 50 mm
- For *Assistant* 173 · 179 · 179N · 179NX · 179BIG-1 · 179XL · 179NXL · 179NXXL · 179W · 179NW



HAZET No.	L x W mm	EAN-No. 4000896+
163-522 x 50	522x50	141043





Hand tools



Wrenches

118–128

Range of sockets

129–195

Screwdrivers / Bits

196–228

Pliers

229–243

Hammers / Chisels / Centre punches

244–250

Pullers / Extractors

251–259

Grinding, separation and cutting

260–264

Thread repair

265–267

Measurement

268–269

Tools with protective insulation / Tools for electricians

270–283

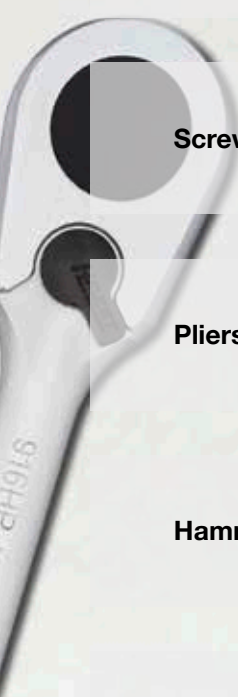



Manufacturing process of a HAZET combination wrench

- 1 Cut to size
- 2 Forging
- 3 Blank trimmed
- 4 Blank sand blasted
- 5 Open-end head milled
- 6 Box-end head broached
- 7 Fine-ground (Heads and handle)
- 8 Hardened and tempered
- 9 Vibratory ground
- 10 Sand blasted
- 11 Heads polished
- 12 Nickel- and chrome-plated

Wrench tolerances

Precision work for perfectly fitting nominal dimension

Tolerance achieved by HAZET



Permissible tolerance in accordance with DIN standard

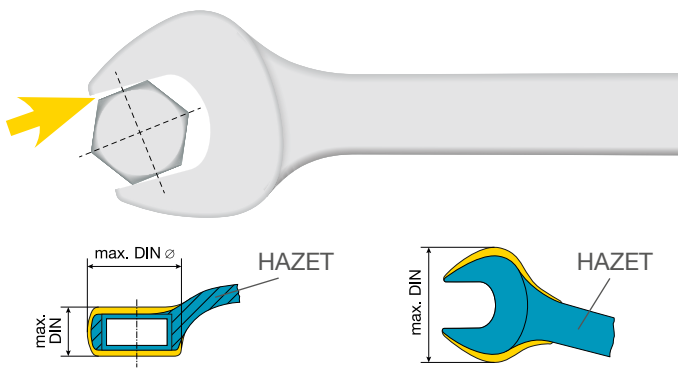

HAZET wrench – high precision tightening and loosening of screw connections

- Long service life due to:
 - High-quality chrome vanadium steel
 - Compacted material structure from drop forging
 - Careful heat treatment
 - Correct hardness and dimensional stability as guarantors of wear resistance and high load capacity
- Shape, dimensions and surface design are perfectly coordinated to one another which guarantees functional handling and meets ergonomic requirements
- **Slim construction** through optimum material composition guarantees sufficient freedom of movement even with hard-to-reach screw connections
- HAZET torque values are considerably higher than the DIN ISO requirements for all wrench sizes – here DIN is the minimum requirement
- Slim open-end and box-end head shape does not reduce the wrench's loading capacity, although this is well below the maximum permissible limit value according to DIN ISO



Comparison of the HAZET traction profile with conventional screw profiles

HAZET traction profile

The HAZET traction profile has been especially developed for HAZET wrenches without sharp edges or points. A strong and also safe transfer of torque is ensured by the protected contact surface of the traction profile in the screw head. This reduces the notching effect in the tool

to a minimum and protects the screw head from damage, such as deformations or wearing of corners. Even damaged screws can still be turned safely and effectively, because slipping out and sliding off are virtually ruled out.

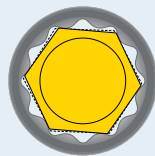
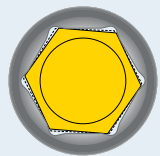

More secure friction lock thanks to protected contact surface (also for screws outside the tolerance).

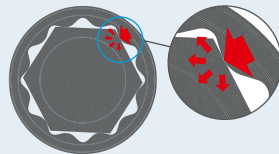
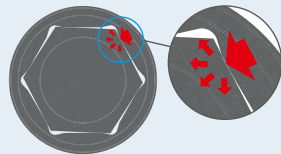

Equal distribution of force on the screw head edges. No straight turning of the screw head due to a changed point of application.

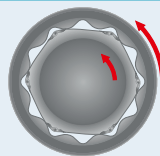
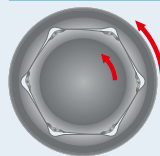

Secure loosening of slightly damaged or worn screw heads thanks to a gentle transfer of torque. The tool is prevented from sliding out.

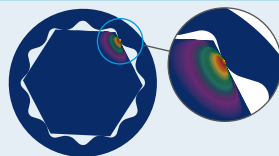
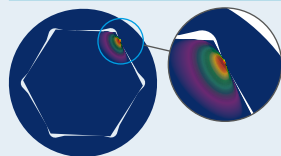

Up to 20% higher torques thanks to an optimal friction lock.

Conventional screw profiles

6-point

12-point

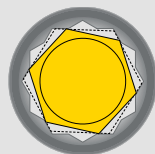
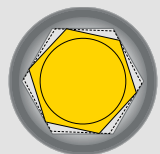

Poorer friction lock due to an unprotected contact surface. Slipping out when working with screws poses the risk of injuries or damage to components. The torque can no longer be applied safely.

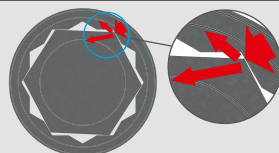
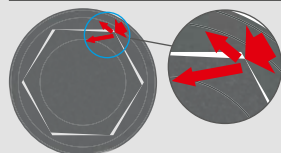

Sharp edges or points increase the risk of a notching effect and in the worst cases can damage or destroy the screw profile of the tool.

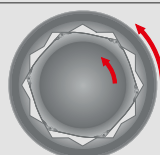
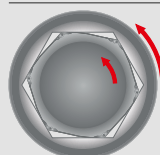

Due to the slipping out of the wrench with damaged (e.g. straight-turned) screw heads, the loosening process is made more difficult or impossible. An effective transfer of the required torque is no longer possible.

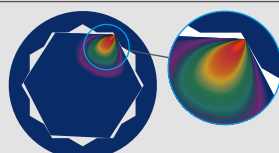
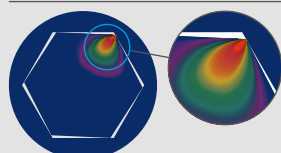

Force acts primarily on the point of the screw profile. This isolated loading causes damage to the screw profile.



Overview of HAZET wrenches

Which wrench in which size

Product group	Designation	Design	Wrench size			as set		
			metric mm	inches "	TORX®			
	279	Open-end wrench, adjustable	• With scale	13 – 53	0.5 – 2.1		123	
	450 N (A)	Double open-end wrench	• Slim heads • Shank with extra sturdy HAZET double-T-profile	4 x 5 – 46 x 50	1/4 x 5/16 – 1.1/16 x 1.1/4		450 N/10 450 N/12 450 N/8 RS 450 N/12 N RS 163-95/8	122
	600 N (A)	Combination wrench	• Long, slim design • Slim heads • Shank with extra sturdy HAZET double-T-profile	5.5 – 80	1/4 – 1.1/2		600 N/12 N 600 N/17 N 600 N/21 600 N/30 163-98/17 163-292/8 600 N A/10 600 N A/12-1	123
	600 Lg	Combination wrench, extra long	• At least 25% longer than comparable standard wrenches • Better accessibility with low-lying screw connections	10 – 41			600 Lg/8 600 Lg/10 600 Lg/12 600 Lg/13	124
	603	Combination wrench	• Box-end head 10° offset	5.5 – 32			603/17 N 603/17 H 163-99/18	125
	606	Ratcheting combination wrench	• For the operation of screw connections in areas with restricted access	8 – 32			606 N/12 606 N/6 606/6-1 163-366/18 163-186/16 606/4 SPC 163-97/6	126
	610 N	Double box-end wrench	• Ergonomically shaped, heads offset	6 x 7 – 30 x 34			610 N/8 610 N/8 RS 610 N/12 RS 163-520/15	126
	630 (A)	Double box-end wrench	• Deep offset • Heads thin-walled	6 x 7 – 36 x 41	1/4 x 5/16 – 1.1/16 x 1.1/4		630/8 630/12 163-101/9 163-296/7	127
	612 (N)	Double box-end wrench (open)	• For tube connections, union nuts and male fittings for pipes	8 x 10 – 30 x 32				128
	609	TORX® double box-end wrench	• Straight design			E6 x E8 – E20 x E24		128
	848 Z	Box-end wrench, 12-point, open		17 – 27				157
				30 – 46				170



Do you know?



HAZET tools have an elaborate surface

Why matt chrome-plated?

- The safer chrome plating because it adheres optimally to the steel
- Good grip, can even be securely held with dirty hands
- Glare-free look
- Looks subtle and elegant
- Double protection against corrosion



Tightening torques

Screw size	Quality range	3.6	5.6	6.9	8.8	10.9	12.9	Minimum testing torque	
								Ring as per DIN Series A	Jaws as per DIN Series A
Thread	Size mm	Nm	Nm	Nm	Nm	Nm	Nm		
M6	10	3	4	8	10	14	17	58,1	24,8
M7	11	5	7	14	17	24	28	72,7	32,3
M8	13	8	10	21	25	35	42	107	51,6
M10	17	16	21	42	50	70	85	201	109
M12	19	28	38	73	87	122	147	261	149
M14	22	45	60	116	138	194	235	368	225
M16	24	59	93	178	210	299	357	451	287
M18	27	95	127	245	289	411	490	594	399
M20	30	135	180	348	411	578	696	760	536
M22	32	182	245	470	558	784	941	884	642
M24	36	230	308	598	710	1000	1196	1165	894
M27	41	343	460	887	1049	1480	1480	1579	1154
M30	46	465	622	1206	1421	2010	2402	2067	1453
M33	50	632	848	1627	1931	2716	3265	2515	1716
M36	55	813	1088	2098	2481	3491	4197	3140	2077
M39	60	1059	1412	2716	3226	4530	5442	3849	2471
M42	65	1304	1745	3363	3991	5609	6727	4021	2900
M45	70	1637	2177	4207	4991	7011	8414	4658	3364



450 N Double open-end wrench

Made in Germany

- Slim heads
- Shank with sturdy HAZET double-T-profile
- Head set at: 15°
- Surface: chrome-plated
- DIN 3110, ISO 10102

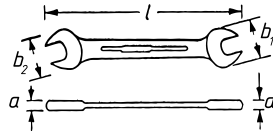

¹⁾ Not according to DIN

HAZET No.	l mm	a mm	b ₁ mm	b ₂ mm	EAN-No. 4000896+
450 N-4 x 5 ¹⁾	99.5	3.2	11.4	13.2	020683
450 N-5 x 5.5 ¹⁾	99.6	3.6	13.4	15.1	020706
450 N-6 x 7	121.3	3.5	15.1	17.1	020713
450 N-8 x 9	139	3.8	18.5	21	020744
450 N-8 x 10	140.1	4.1	19	23.2	020737
450 N-10 x 11	155.7	4.6	23.2	25.2	020355
450 N-10 x 13	172	5.1	25.1	29.9	020362
450 N-12 x 13	172.7	5.1	27.1	29.1	020386
450 N-13 x 17	205.5	6	29.3	36	020423
450 N-14 x 15	187.8	5.7	30.9	32.8	020430
450 N-16 x 17	205.7	6	34.8	37	020454
450 N-16 x 18	205.7	6	34.8	38.3	020461
450 N-17 x 19	220.9	6.7	37.4	40.6	020478
450 N-18 x 19	221.2	6.7	38.6	40.6	020485
450 N-20 x 22 ¹⁾	238.9	7	43.9	47.8	020515
450 N-21 x 22	238	7	44.8	46.8	020522
450 N-21 x 23 ¹⁾	246	7.1	44.8	48.8	020539
450 N-22 x 24	254.6	7.1	47.8	51.9	020553
450 N-24 x 26 ¹⁾	269.4	7.8	50.9	54.9	020560
450 N-24 x 27	269	7.8	50.9	57	020577
450 N-25 x 28 ¹⁾	284.2	8.4	53.4	59	020584
450 N-27 x 32	303.8	9.1	58	67.3	020607
450 N-30 x 32	303.4	9	63.4	67.3	020614
450 N-32 x 36	343.2	10.1	66.9	75.2	020638
450 N-34 x 36	343.2	10.1	67.9	74.5	020645
450 N-36 x 41	396.7	10.5	74.6	81.1	020652
450 N-41 x 46	439.5	11.4	85.5	94.4	020669
450 N-46 x 50	498	12.3	94.3	102.2	020676

450 N Double open-end wrench set

Made in Germany

- Surface: chrome-plated
- DIN 3110, ISO 10102



HAZET No.	EAN-No. 4000896+
450 N • ● 6x7 • 8x9 • 10x11 • 12x13 • 14x15 • 16x17 • 18x19 • 21x22 • 24x26 • 27x32	020751
450 N/10 6x7 • 8x9 • 10x11 • 12x13 • 14x15 • 16x17 18x19 • 20x22 • 21x23 • 24x26 • 25x28 • 27x32	020775
450 N/12	020775

Made in Germany

- Suitable for wall fixation
- Plastic tool holder
- Surface: chrome-plated
- DIN 3110, ISO 10102



450 N Double open-end wrench set

HAZET No.	L x W x H mm	EAN-No. 4000896+
450 N • ● 6x7 • 8x9 • 10x11 • 12x13 • 14x15 • 16x17 • 18x19 • 21x22		
450 N/8 RS	260x110x55 8	020867
450 N • ● 6x7 • 8x9 • 10x11 • 12x13 • 14x15 • 16x17 18x19 • 20x22 • 21x23 • 24x27 • 25x28 • 30x32		
450 N/12 NRS	340x165x75 12	020805

Made in Germany

- Safety-Insert-System, 2-component soft foam insert. Insert also suitable for HAZET Assistent
- DIN 3110, ISO 10102

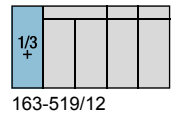
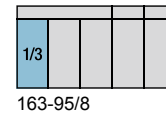

HAZET No.	L x W mm	EAN-No. 4000896+
450 N • ● 6x7 • 8x9 • 10x11 • 12x13 • 14x15 • 16x17 • 18x19 • 21x22		
163-95/8	342x172 8	145669
For HAZET Assistent with drawer depth of 398 mm: 173 • 179 • 179N • 179NX • 179W • 179NW • 179BIG-1 • 179XL • 179NXL • 179XXL • 179NXXL • 179AXXL • 179TXXL • 180		
450 N • ● 6x7 • 8x9 • 10x11 • 12x13 • 14x15 • 16x18 17x19 • 20x22 • 21x23 • 24x27 • 30x32 • 34x36		
163-519/12	392x172 12	218684

450 NA Double open-end wrench

Made in Germany

- Slim heads
- Shank with sturdy HAZET double-T-profile
- Head set at: 15°
- American dimensions
- Surface: chrome-plated
- DIN 895

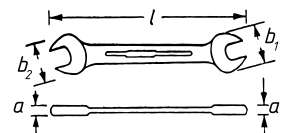

HAZET No.	l mm	a mm	b ₁ mm	b ₂ mm	EAN-No. 4000896+
450 N A-1/4 x 5/16 VKH	129.9	3	17.1	18.5	020911
450 N A-5/16 x 3/8 VKH	140.1	4.1	19	23.2	020973
450 N A-3/8 x 7/16 VKH	155.7	4.6	23.2	25.2	020966
450 N A-1/2 x 9/16 VKH	172.4	5.1	30.1	31	020904
450 N A-9/16 x 5/8 VKH	189.8	5.7	32.4	35.4	021000
450 N A-19/32 x 11/16 V	205.7	6	34.8	38.3	020935
450 N A-5/8 x 3/4 VKH	220.9	6.7	37.4	40.6	020980
450 N A-25/32 x 7/8 VKH	238.9	7	43.9	47.8	020959
450 N A-7/8 x 15/16 VKH	254.6	7.1	47.8	51.9	020997
450 N A-15/16 x 1 VKH	269.4	7.8	50.9	54.9	020928
450 N A-1 x 1.1/8 VKH	284.2	8.4	53.4	59	020942
450 N A-1.1/16 x 1.1/4	303.8	9	58	67.3	020881



Hand tools

Wrenches



279 Open-end wrench · adjustable

• Adjustable wrench

- With scale
- Head set at: 15°
- Surface: phosphatised, mirror, highly polished, blank

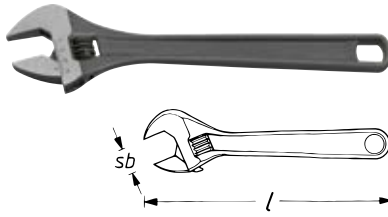

HAZET No.	l mm	sb mm	EAN-No. 4000896+
279- 4	108	17	018086
279- 6	157	24	018093
279- 8	206	29	018109
279-10	256	33	018048
279-12	306	38	018055
279-15	383	51	018062
279-18	461	60	018079

600 N Combination wrench

• Made in Germany

- Long, slim design
- Slim heads
- Shank with sturdy HAZET double-T-profile
- Box-end head angled at 15°
- Surface: chrome-plated, head polished
- DIN 3113 form A, ISO 3318, ISO 7738

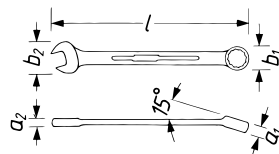

1) Not according to DIN

HAZET No.	l mm	a ₁ mm	a ₂ mm	b ₁ mm	b ₂ mm	EAN-No. 4000896+
600 N-5.5 ¹⁾	105	6	4	9.6	15.5	023288
600 N-6	105	6	4	9.6	15.5	023295
600 N-7	118.5	6.6	4	10.9	17.5	023301
600 N-8	130	7	4.5	12	18.5	023318
600 N-9	143	8	4.5	13.7	21	023325
600 N-10	154.5	8	5	15	23	023028
600 N-11	168.5	8.4	5.5	15.9	25.5	023035
600 N-12	180.5	9	5.5	17.8	27.5	023042
600 N-13	193	10	6.3	19	29	023059
600 N-14	204.5	10	6.5	20.1	31	023073
600 N-15	218	11	7	21.4	32.5	023080
600 N-16	230.5	11.4	7	23.1	35	023097
600 N-17	242.5	12.4	7.5	24.5	37	023103
600 N-18	255	13	8	26	39	023110
600 N-19	268.5	13.5	8	27.5	41	023127
600 N-20 ¹⁾	279.5	13.5	8.5	29	43	023134
600 N-21	292	13.7	8.5	30	45	023141
600 N-22	304.5	14	8.5	31.5	47	023158
600 N-23 ¹⁾	328	14.3	9.5	33	49	023165
600 N-24	328	14.7	9.5	34.5	51	023172
600 N-25 ¹⁾	354	15	10	36	53.5	023189
600 N-26 ¹⁾	354	15.5	10	37.5	55	023196
600 N-27	380	16	10.5	39	57	023202
600 N-28 ¹⁾	380	16.5	11	40.5	59	023219
600 N-29 ¹⁾	380	17	11.5	41.5	60	023226
600 N-30	405.5	17.5	12.2	43	63	023233
600 N-32	420	18	12	45.5	66.5	023240
600 N-34	432	19	13	48.5	67	023257
600 N-36	460	20	13	51.8	75	023264
600 N-41	500	20.6	14	58.8	85	023271

600 N Combination wrench

1) Not according to DIN

HAZET No.	l mm	a ₁ mm	a ₂ mm	b ₁ mm	b ₂ mm	EAN-No. 4000896+
• Box-end head 10° offset						
• DIN 3113 form B, ISO 3318, ISO 7738						
600 N-46	520	24	15	69	95	048564
600 N-50	560	26	16.5	75	103	048571
600 N-55	610	28	18	84.5	113	048588
600 N-60	660	31	20	90	123	048595
600 N-65 ¹⁾	710	33	22	98	133	048601
600 N-70 ¹⁾	760	35	24	105	143	048618
600 N-75 ¹⁾	810	38	26	110	153	048625
600 N-80 ¹⁾	860	41	28	119	163	048632

600 N Combination wrench set

• Made in Germany

- Surface: chrome-plated, head polished
- DIN 3113 form A, ISO 3318, ISO 7738



HAZET No.	EAN-No. 4000896+
600 N • 10 • 11 • 12 • 13 • 14 • 15 • 16 • 17 • 18 • 19 • 21 • 22	023332
600 N/12 N	12
600 N • 7 • 8 • 9 • 10 • 11 • 12 • 13 • 14 • 15 • 16 • 17 • 18 • 19 • 21 • 22 • 24 • 27	023349
600 N/17 N	17
600 N • 6 • 7 • 8 • 9 • 10 • 11 • 12 • 13 • 14 • 15 • 16 • 17 • 18 • 19 • 21 • 22 • 24 • 27 • 30 • 32 • 34	023356
600 N/21	21
600 N • 5.5 • 6 • 7 • 8 • 9 • 10 • 11 • 12 • 13 • 14 • 15 • 16 • 17 • 18 • 19 • 20 • 21 • 22 • 23 • 24 • 25 • 26 • 27 • 28 • 29 • 30 • 32 • 34 • 36 • 41	023363
600 N/30	30

• Made in Germany

- Safety-Insert-System, 2-component soft foam insert. Insert also suitable for HAZET Assistant
- DIN 3113 form A, ISO 3318, ISO 7738



2/3		
-----	--	--

HAZET No.	L x W mm	EAN-No. 4000896+
600 N • 6 • 7 • 8 • 9 • 10 • 11 • 12 • 13 • 14 • 15 • 16 • 17 • 18 • 19 • 21 • 22 • 24		
163-98/17	344x342	145690



600 N Combination wrench set

Made in Germany

- Safety-Insert-System, 2-component soft foam insert. Insert also suitable for HAZET Assistant
- DIN 3113 form A, ISO 3318, ISO 7738



1/3				
-----	--	--	--	--

HAZET No.	L x W mm		EAN-No. 4000896+
600 N •			
10 • 11 • 13 • 14 • 15 • 17 • 19 • 22			
163-292/8	342x172	8	186372

600 NA Combination wrench

Made in Germany

- Long, slim design
- Slim heads
- Shank with sturdy HAZET double-T-profile
- Box-end head angled at 15°
- American dimensions
- Surface: chrome-plated

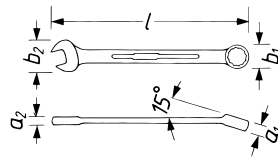

HAZET No.	l mm	a ₁ mm	a ₂ mm	b ₁ mm	b ₂ mm	EAN-No. 4000896+
600 NA-1/4	105	6	4	9.6	15.1	023493
600 NA-5/16	130	7	4.5	12	18.3	023554
600 NA-3/8	154.5	8	5	15	23.1	023547
600 NA-7/16	168.5	8.4	5.5	15.9	25.3	023578
600 NA-1/2	193	10	6.3	19	29.1	023486
600 NA-9/16	204.5	10	6.5	20	30.9	023592
600 NA-5/8	230	11.4	7	23.1	34.7	023561
600 NA-11/16	242.5	12.4	7.5	25	36.6	023509
600 NA-3/4	268	13.5	8	27.5	40.6	023530
600 NA-13/16	292	13.7	8.5	30	44.6	023516
600 NA-7/8	304	14	8.5	31.5	46.8	023585
600 NA-15/16	328	14.7	9.5	34.5	50.7	023523
600 NA-1	354	15.5	10	37.5	54.7	023400
600 NA-1.1/8	380	17	11.5	41.5	59.7	023448
600 NA-1.1/4	420	18	12	45.2	66.4	023431
600 NA-1.5/16	432	19	13	48.5	66.7	023462
600 NA-1.1/2	486	20.5	13.7	54.7	77.1	023424



600 NA Combination wrench set

Made in Germany

- Long, slim design
- Slim heads
- Shank with sturdy HAZET double-T-profile
- Box-end head angled at 15°
- American dimensions
- Surface: chrome-plated



HAZET No.		EAN-No. 4000896+
600 NA •		
1/4 • 5/16 • 3/8 • 7/16 • 1/2 • 9/16 • 5/8 • 3/4 • 7/8 • 1		
600 NA/10	10	023608
600 NA •		
1/4 • 5/16 • 3/8 • 7/16 • 1/2 • 9/16 • 5/8 • 3/4 • 7/8 • 1 • 1.1/8 • 1.5/16		
600 NA/12-1	12	023615

600 LG Combination wrench · extra long

Made in Germany

- Loading capacity at least twice as high as DIN

- At least 25% longer than comparable standard wrenches – for greater power transmission
- Better accessibility with low-lying screw connections
- Shank with extra sturdy double-T-profile slim design
- Surface: chrome-plated



YouTube Clip

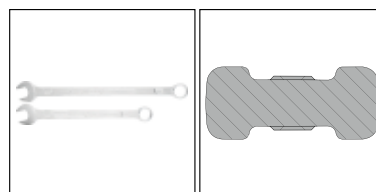

HAZET No.	l mm	a ₁ mm	a ₂ mm	b ₁ mm	b ₂ mm	EAN-No. 4000896+
600 LG-10	210	8.5	5.5	16.5	23.1	197644
600 LG-11	220	9	5.5	18	25.1	199518
600 LG-12	230	9.5	6	19.5	27	199501
600 LG-13	245	10	6	20.8	29.1	198238
600 LG-14	255	11	6.5	22.5	30.9	197651
600 LG-15	270	11.6	7	23.8	32.6	209958
600 LG-16	290	12	7	25.2	34.7	209200
600 LG-17	305	12.5	7.5	26.5	36.6	197668
600 LG-18	320	13.8	8	28	38.6	209194
600 LG-19	335	15	8.5	29.5	40.6	198245
600 LG-21	365	15.8	8.5	32	44.6	209965
600 LG-22	380	16	9	33.7	46.8	199525
600 LG-24	430	18	10	36.5	50.7	198252
600 LG-27	480	20	11	40.5	56.6	198269
600 LG-30	510	21	12	45.1	63.1	199723
600 LG-32	530	21.5	12	47.6	66.4	197675
600 LG-36	580	24	13	53	74.6	205745
600 LG-41	600	26	14	60.4	84.9	205738



Hand tools

Wrenches



600 LG Combination wrench · extra long

Made in Germany

• Loading capacity at least twice as high as DIN

- At least 25% longer than comparable standard wrenches – for greater power transmission
- Better accessibility with low-lying screw connections
- Shank with extra sturdy double-T-profile slim design
- Surface: chrome-plated

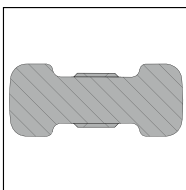
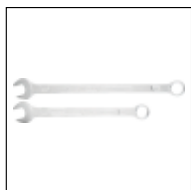

YouTube Clip

HAZET No.		EAN-No. 4000896+
600 LG • 8	10 • 13 • 14 • 17 • 19 • 24 • 27 • 32	199938
600 LG • 10	10 • 11 • 12 • 13 • 14 • 15 • 16 • 17 • 18 • 19	218424
600 LG • 12	10 • 11 • 12 • 13 • 14 • 17 • 19 • 22 • 24 • 27 • 30 • 32	202492
600 LG • 13	10 • 11 • 12 • 13 • 14 • 15 • 16 • 17 • 18 • 19 • 21 • 22 • 24	218417

603 Combination wrench

Made in Germany

- Box-end head 10° offset
- Head setting: 15°
- Surface: chrome-plated
- DIN 3113 form B, ISO 3318, ISO 7738, In accordance with DIN EN 3709

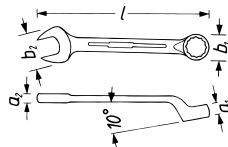

¹⁾ Box-end head with hexagon

²⁾ Not according to DIN

HAZET No.	l mm	a ₁ mm	a ₂ mm	b ₁ mm	b ₂ mm	EAN-No. 4000896+
603-5.5 ^{1) 2)}	90	4.7	3.7	9.8	14.1	023929
603-6 ¹⁾	100	5.1	4	10.5	14.9	023950
603-7 ¹⁾	110	5.5	4.3	12.2	16.8	023981
603-8 ¹⁾	120	5.9	4.5	13.1	18.3	024018
603-9 ¹⁾	130	6.3	4.5	14.6	21	024025
603-10	137	6.7	5	15.6	23	023691
603-11	145	7.1	5.2	17.1	25	023714
603-12	152	7.6	5.4	18.4	26.8	023721
603-13	160	8	5.6	19.9	28.8	023738
603-14	170	8.5	5.8	21.4	30.7	023752
603-15	180	9	6	22.5	32.6	023769
603-16	190	9.5	6.2	24	34.6	023776
603-17	200	10	6.4	25.5	36.5	023783
603-18	210	10.5	6.7	26.9	38.6	023790
603-19	220	11	7	28.4	40.6	023806
603-21	240	12	7.6	30.7	44.8	023820
603-22	250	12.5	7.9	32.2	46.8	023837

603 Combination wrench

HAZET No.	l mm	a ₁ mm	a ₂ mm	b ₁ mm	b ₂ mm	EAN-No. 4000896+
603-24	270	13.5	8.5	35.1	51	023844
603-27	305	15	9.3	38.5	57.3	023868
603-30	340	16	10	42.7	63.4	050260
603-32	360	17	10.5	45.5	67.2	023882

603 Combination wrench set

Made in Germany

- Surface: chrome-plated
- DIN 3113 form B, ISO 3318, ISO 7738, In accordance with DIN EN 3709



HAZET No.		EAN-No. 4000896+
603 • 17 N	7 • 8 • 9 • 10 • 11 • 12 • 13 • 14 • 15 • 16 • 17 • 18 • 19 • 21 • 22 • 24 • 27	024063

Made in Germany

- Surface: chrome-plated
- DIN 3113 form B, ISO 3318, ISO 7738, In accordance with DIN EN 3709

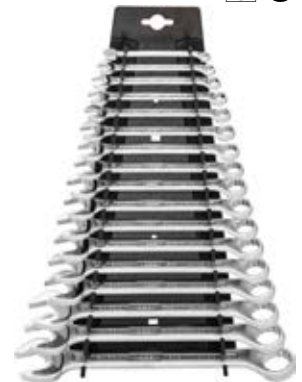

HAZET No.		EAN-No. 4000896+
603 • 17 H	6 • 7 • 8 • 9 • 10 • 11 • 12 • 13 • 14 • 15 • 16 • 17 • 18 • 19 • 21 • 22 • 24	024049

Made in Germany

- Safety-Insert-System, 2-component soft foam insert. Insert also suitable for HAZET Assistant
- DIN 3113 form B, ISO 3318, ISO 7738, In accordance with DIN EN 3709



HAZET No.	L x W mm		EAN-No. 4000896+
603 • 18	344x342	18	145706



606 Ratcheting combination wrench

• Operation of screw connections in areas with restricted access, ratchet function enables continuous working



- Long, slim design
- Shank with sturdy HAZET double-T-profile
- Box-end wrench with reversible ratchet
- Fine-tooth, 72 teeth · Operating angle 5°
s 8 and 9 mm: 60 teeth · Operating angle 6°
- Box-end side 13° offset
- Head set at: 15°
- Surface: chrome-plated

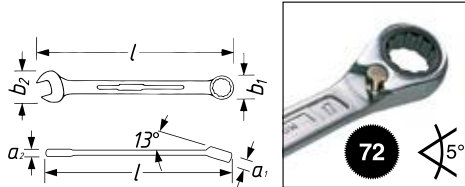

HAZET No.	l mm	a ₁ mm	a ₂ mm	b ₁ mm	b ₂ mm	EAN-No. 4000896+
606- 8	129.9	6.8	4.9	16.8	16.7	100941
606- 9	143	7.2	5.2	18.5	18.8	100958
606-10	154.5	7.6	5.6	20.1	20.9	100965
606-11	168.6	8	6	21.7	23	100972
606-12	180.3	8.5	6.4	22.9	25.9	100989
606-13	193.2	8.9	6.7	24.9	27.2	100996
606-14	204.6	9.3	7.1	27.2	29.3	101009
606-15	218	9.7	7.4	28.6	31.3	101016
606-16	230.2	10.2	7.7	30.1	33.4	101023
606-17	242.2	10.6	8.1	32	35.5	101030
606-18	255	11	8.5	32.9	37.6	101047
606-19	268.3	11.5	9.1	34.1	39.7	101054
606-21	291.5	13.3	12	44.3	48.3	151233
606-22	291.5	13.3	12	44.3	48.3	151028
606-24	333.1	14.8	12.5	51.2	53.5	151011
606-27	359.2	15.8	14.7	54.9	60.2	151004
606-30	402.5	17.3	15.2	60.8	67	150991
606-32	425.8	17.8	15.7	64.2	71	150984

606 Ratcheting combination wrench set

• Surface: chrome-plated



HAZET No.	EAN-No. 4000896+
606 • 21 • 22 • 24 • 27 • 30 • 32	
606/6-1	175178

- Plastic box 165-L (1/3)
- Safety-Insert-System, 2-component soft foam insert. Insert also suitable for HAZET Assistant
- Surface: chrome-plated



1/3			
-----	--	--	--

606 Ratcheting combination wrench set



HAZET No.	L x W x H mm	EAN-No. 4000896+
606 • 8 • 9 • 10 • 11 • 12 • 13 • 14 • 15 • 16 • 17 • 18 • 19		
606 N/12	355x235x65	12 197378
606 • 8 • 10 • 12 • 13 • 17 • 19		
606 N/6	355x235x65	6 196937

• Safety-Insert-System, 2-component soft foam insert. Insert also suitable for HAZET Assistant



1/3			
-----	--	--	--

163-97/6

1/3			
-----	--	--	--

163-515/16

3/3			
-----	--	--	--

163-366/18

HAZET No.	L x W mm	EAN-No. 4000896+
606 • 8 • 10 • 12 • 13 • 17 • 19		
163-97/6	342x172	6 145683
For HAZET Assistant with drawer depth of 398 mm: 173 · 179 · 179N · 179NX · 179W · 179NW · 179BIG-1 · 179XL · 179NXL · 179XXL · 179NXXL · 179AXXL · 179TXXL · 180		
606 • 8 • 9 • 10 • 11 • 12 • 13 • 14 • 15 • 16 • 17 • 18 • 19 • 606/4 SPC		
163-515/16	392x172	16 218721
606 • 8 • 9 • 10 • 11 • 12 • 13 • 14 • 15 • 16 • 17 • 18 • 19 • 21 • 22 • 24 • 27 • 30 • 32		
163-366/18	519x342	18 196920

610 N Double box-end wrench

■ Made in Germany



- Ergonomically shaped, heads offset
- Shank with sturdy HAZET double-T-profile
- Surface: chrome-plated, head polished
- DIN 837 form B, ISO 10103

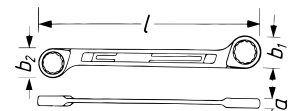

¹⁾ Not according to DIN

HAZET No.	l mm	a mm	b ₁ mm	b ₂ mm	EAN-No. 4000896+
610 N- 6x7	97.9	4.5	9.6	11	024940
610 N- 8x9	113.3	5.2	12.3	13.6	024957
610 N-10x11	125.3	6	14.9	16.2	024735
610 N-12x13	139	6.2	17.8	18.9	024742
610 N-14x15	154.5	7	20.2	21.5	024780
610 N-16x17	170	7.5	22.7	24.1	024797
610 N-18x19	188.6	8.5	26	27	024827
610 N-20x22 ¹⁾	208.8	9	28.4	30.4	024834
610 N-21x22 ¹⁾	232.3	10	29.8	32.2	024841
610 N-21x23 ¹⁾	232.3	10	29.8	32.7	024858
610 N-24x26 ¹⁾	254	11	34.1	37	024872
610 N-25x28 ¹⁾	280.1	11.5	35.5	39.8	024896
610 N-27x32	308.7	13	38.9	45.4	024902
610 N-30x32	324.1	13	42.7	45.4	024919
610 N-30x34	326.7	14	42.7	48	024926



Hand tools

Wrenches



610 N Double box-end wrench set

Made in Germany

- Safety-Insert-System, 2-component soft foam insert. Insert also suitable for HAZET Assistant
- DIN 837 form B, ISO 10103



1/3+				
------	--	--	--	--



HAZET No.	L x W mm		EAN-No. 4000896+
For HAZET Assistant with drawer depth of 398 mm: 173 · 179 · 179N · 179NX · 179W · 179NW · 179BIG-1 · 179XL · 179NXL · 179XXL · 179NXXL · 179AXXL · 179TXXL · 180			
610 N •			
6x7 · 8x9 · 10x11 · 12x13 · 14x15 · 16x17 · 18x19 · 20x22			
21x22 · 21x23 · 24x26 · 25x28 · 27x32 · 30x32 · 30x34			
163-520/15	392x172	15	218677

Made in Germany

- Surface: chrome-plated, head polished
- DIN 837 form B, ISO 10103



HAZET No.		EAN-No. 4000896+
610 N •		
6x7 · 8x9 · 10x11 · 12x13 · 14x15 · 16x17 · 18x19 · 21x22		
610 N/8	8	024995

Made in Germany

- Suitable for wall fixation
- Plastic tool holder
- Surface: chrome-plated, head polished
- DIN 837 form B, ISO 10103



HAZET No.	L x W x H mm		EAN-No. 4000896+
610 N •			
6x7 · 8x9 · 10x11 · 12x13 · 14x15 · 16x17 · 18x19 · 21x22			
610 N/8RS	260x110x55	8	025008
• With carrying handle			
610 N •			
6x7 · 8x9 · 10x11 · 12x13 · 14x15 · 16x17			
18x19 · 20x22 · 21x23 · 24x26 · 25x28 · 27x32			
610 N/12RS	340x165x75	12	024988

630 Double box-end wrench

Made in Germany

- Deep offset
- Heads thin-walled
- Surface: chrome-plated, head polished
- DIN 838, ISO 10104



630 Double box-end wrench

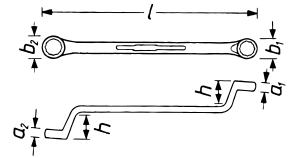

1) Not according to DIN

2) Matt chrome-plated

HAZET No.	l mm	h mm	a ₁ mm	a ₂ mm	b ₁ mm	b ₂ mm	EAN-No. 4000896+
630-6x7	165	18	6	6.5	10.5	12.2	026555
630-8x9	180	20.5	7	7.5	13.1	14.6	026579
630-10x11	200	23.5	8	9	15.6	17.1	026227
630-12x13	220	25	9	9.5	18.4	19.9	026241
630-14x15	240	27	10	10.5	21.4	22.5	026296
630-16x17	255	29	11	11.3	24	25.5	026302
630-17x19	265	29	11.3	11.9	25.5	28.4	026326
630-18x19	265	31	11.6	11.9	26.9	28.4	026333
630-20x22 ¹⁾	295	32.5	12.2	12.9	29.3	32.2	026364
630-21x22	295	32.5	12.9	12.9	30.7	32.2	026371
630-21x23 ¹⁾	315	34	12.5	13.2	30.7	33.6	026388
630-24x26 ¹⁾	330	34	13.5	14.1	35.1	37.1	026401
630-24x27	340	35	13.5	14.4	35.1	38.5	026418
630-25x28 ¹⁾	350	35	13.8	14.7	36.5	39.9	026432
630-27x32	365	36.5	14.4	16	38.5	45.5	026463
630-30x32	365	36.5	15.4	16	42.7	45.5	026470
630-36x41 ²⁾	440	40	17.2	18.8	51.3	58.2	026517

630 Double box-end wrench set

Made in Germany

- Safety-Insert-System, 2-component soft foam insert. Insert also suitable for HAZET Assistant
- DIN 838, ISO 10104



1/3+				
------	--	--	--	--



HAZET No.	L x W mm		EAN-No. 4000896+
For HAZET Assistant with drawer depth of 398 mm: 173 · 179 · 179N · 179NX · 179W · 179NW · 179BIG-1 · 179XL · 179NXL · 179XXL · 179NXXL · 179AXXL · 179TXXL · 180			
630 •			
6x7 · 8x9 · 10x11 · 12x13 · 14x15 · 16x17 · 18x19 · 20x22 · 21x23			
163-518/9	392x172	9	218707

Made in Germany

- Surface: chrome-plated, head polished
- DIN 838, ISO 10104



HAZET No.		EAN-No. 4000896+
630 •		
6x7 · 8x9 · 10x11 · 12x13 · 14x15 · 16x17 · 18x19 · 21x22		
630/8	8	026654
630 •		
6x7 · 8x9 · 10x11 · 12x13 · 14x15 · 16x17		
18x19 · 20x22 · 21x23 · 24x26 · 25x28 · 27x32		
630/12	12	026593



630 Double box-end wrench set

Made in Germany

- Surface: chrome-plated, head polished
- DIN 838, ISO 10104



HAZET No.	Size	EAN-No. 4000896+
630 •	6x7 • 8x9 • 10x11 • 12x13 • 14x15 • 16x17 • 18x19 • 21x22	
630/8	8	026654
630 •	6x7 • 8x9 • 10x11 • 12x13 • 14x15 • 16x17 • 18x19 • 20x22 • 21x23 • 24x26 • 25x28 • 27x32	
630/12	12	026593

630 A Double box-end wrench

Made in Germany

- Deep offset
- Heads thin-walled
- American dimensions
- Surface: chrome-plated, head polished
- ISO 1085

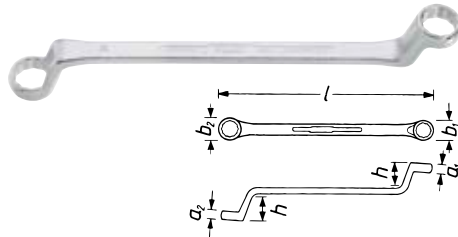

HAZET No.	l mm	h mm	a ₁ mm	a ₂ mm	b ₁ mm	b ₂ mm	EAN-No. 4000896+
630 A-1/4 x 5/16	170	19.5	6.6	7	12.2	13.1	026722
630 A-3/8 x 7/16	200	23.5	8	9	15.6	17.1	026807
630 A-1/2 x 9/16	230	26	9.5	10.5	19.9	22.5	026715
630 A-19/32 x 11/16	255	29	10.8	11.5	22.7	26.5	026753
630 A-5/8 x 3/4	265	29	11	11.9	24	28.4	026821
630 A-3/4 x 7/8	295	32.5	11.9	12.9	28.4	32.2	026791
630 A-25/32 x 13/16	295	32.5	12.2	12.5	29.3	30.2	026777
630 A-15/16 x 1	330	34	13.5	14.1	35.1	37.1	026746
630 A-1 x 1.1/8	350	36.5	14.1	15.6	36.3	42.1	026760
630 A-1.1/16 x 1.1/4	365	36.5	14.8	16.4	39.4	46.5	026692

612 Double box-end wrench · open

Made in Germany

- For tube connections, union nuts and male fittings for pipes
- Heads angled at 15°
- Jaw opening 15° slotted
- Shank with sturdy HAZET double-T-profile

Note: For wrenches for working on brake lines see HAZET 612N

- Surface: chrome-plated
- DIN 3118

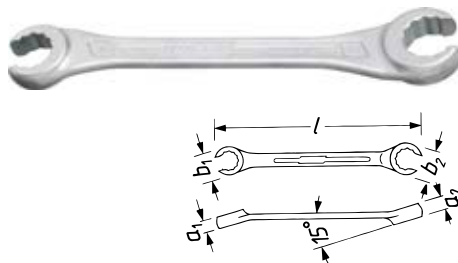

612 Double box-end wrench · open

¹⁾ With 6-point

²⁾ Not according to DIN

HAZET No.	l mm	a ₁ mm	a ₂ mm	b ₁ mm	b ₂ mm	EAN-No. 4000896+
612- 8 x 10 ¹⁾	140	7	8	18	20	025206
612-10 x 11 ¹⁾	147	8	8.7	20	22	025091
612-11 x 13 ¹⁾	160	8.7	9.8	22	26	025107
612-12 x 14 ¹⁾	168	9.2	10.3	24	28	025114
612-13 x 15 ²⁾	182	9.8	10.9	26	29	025121
612-16 x 18 ²⁾	208	12	13.2	30	32	025145
612-17 x 19	208	12	13.2	30	32	025152
612-19 x 22	222	13.8	15.8	34.5	40.5	025169
612-24 x 27	260	16.2	18	42	46	025183
612-30 x 32	300	21	23	50	52	025190

612N Double box-end wrench · open

Made in Germany

• For screwed connections on lines

• Reinforced design

• Offset design (15° and 40°)

• With 6-point

• Straight slot

• Surface: chrome-plated

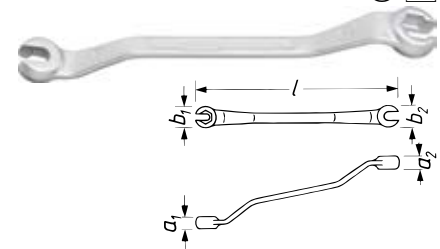

HAZET No.	l mm	a ₁ mm	a ₂ mm	b ₁ mm	b ₂ mm	EAN-No. 4000896+
612N-10 x 11	172	11	11	20	21.5	025428
612N-11 x 13	185.5	11.5	11.5	21.5	24.5	025435
612N-12 x 14	198.5	11.5	11.5	23.2	26	025442

612N Brake line wrench · open

Made in Germany

• Reinforced design

• Straight design for the operation of the brake line / hose fitting at the front axle

• Offset design for the safe operation of the brake line screwing at the wheel brake cylinder, past the circumferential edge of the anchor plate

• Anti-slipping

• Straight slot / with 6-point

• Surface: chrome-plated

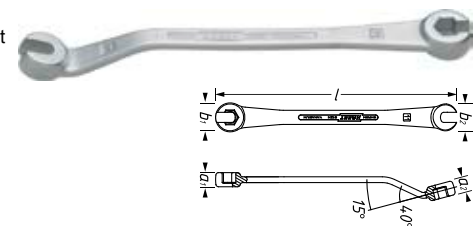

HAZET No.	l mm	a ₁ mm	a ₂ mm	b ₁ mm	b ₂ mm	EAN-No. 4000896+
612N-11	177.7	11	11	20	21.5	129133

609 double box-end wrench

Made in Germany

• Straight design

• Surface: chrome-plated, head polished

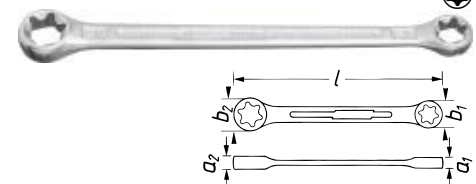

HAZET No.	l mm	a ₁ mm	a ₂ mm	b ₁ mm	b ₂ mm	Weight mm	EAN-No. 4000896+
609-E 6 x E 8	113	4.8	5.8	10	12	5.74x7.52	024711
609-E 10 x E 12	140	6.8	8	13	15	9.42x11.17	024650
609-E 14 x E 18	180	7.9	9.5	17	21	12.90x16.70	024674
609-E 20 x E 24	224	11	13	24	28	18.49x22.16	024698



Hand tools

Range of sockets



Range of sockets



6.3 1/4"	Socket sets	142–144
	Operating tools	145–147
	Sockets / Screwdriver sockets	147–150
	Connectors	150–151
10 3/8"	Socket sets	152–154
	Operating tools	154–156
	Sockets	156–159
	Screwdriver sockets	160–161
	Connectors	161–162
	Range of impact tools	162
12.5 1/2"	Socket sets	163–164
	Operating tools	165–168
	Sockets	168–171
	Screwdriver sockets	171–176
	Connectors	176–178
	Impact socket sets	178
	Impact sockets	178–184
	Impact screwdriver sockets	184–186
	Impact connectors	186
20 3/4"	Socket sets	187
	Operating tools	188
	Sockets / Screwdriver sockets	188–189
	Connectors	190
	Range of impact tools	190–191
25 1"	Socket sets	192
	Operating tools	192
	Sockets	193
	Connectors	193
	Range of impact tools	193–194
 TORX® Tools		194–195



HiPer

HIGH PERFORMANCE

THE ORIGINAL

MADE IN GERMANY

Static AND dynamic –
Double precision
in perfection!

Fine-tooth reversible ratchets

- Complete range 1/4" · 3/8" · 1/2"
- 10 versions extendable or with safety lock, among other features
- Maximum power: almost double DIN (916HP 1000 Nm, DIN 512 Nm)
- High precision: 90 teeth
- 4° operating angle for restricted spaces
- Developed and produced „Made in Germany“
- High permanent load for durability
- Locking function of the lever prevents unwanted switching
- Strict production tolerances prevent dirt from getting in



- Progressively adjustable from 414 to 614 mm

1000 Nm

/ max. 614 mm

12⁵ 1/2"



reddot winner 2020

HiPer HPS – with safety locking

- Loosening-proof locking thanks to push button actuation
- Attached tools can easily be released by pressing the button with just one hand
- Firm hold of sockets



850 Nm

/ 275 mm

12⁵ 1/2"

340 Nm

/ 200 mm

10 3/8"

100 Nm

/ 116 mm

6.3 1/4"





Hand tools

Range of sockets



1000 Nm
/ 415 mm
12⁵ 1/2"

1000 Nm
/ 275 mm
12⁵ 1/2"

400 Nm
/ 200 mm
10 3/8"

120 Nm
/ 116 mm
6.3 1/4"

120 Nm
/ 116 mm
6.3 1/4"



916HP performance comparison example

Peak load

DIN 3122:2017-04 (static load)

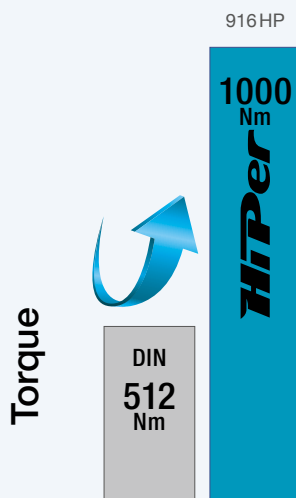

Durability · Permanent load

ISO 3315:2018-05 (dynamic load)



Ergonomic shift lever



Integrated suspension option in the handle



- ① Pawl
- ② Ratchet wheel
- ③ Shift lever
- ④ Housing
- ⑤ 2-component handle



Manufacturing process for HAZET sockets – The tool for tough applications

Job well done – by HAZET

Socket



①

Material section sawn from round bar steel



②

Blank outside ground to size

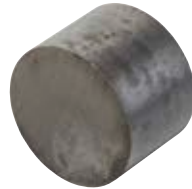

③

Blank metallurgically heat-treated

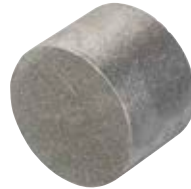

④

Blank sand-blasted



⑤

Cold extrusion, inside profile produced ready, outside profile adjusted



⑥

Mechanically worked, turned, drilled, inner groove milled, knurled and inscribed



⑦

Hardened and tempered



⑧

Surface worked, sand-blasted



⑨

Outside surface partially ground



⑩

Nickel-plated and chrome-plated

Screwdriver socket



①

Material section sawn from round bar steel

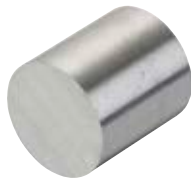

②

Blank outside ground to size



③

Blank metallurgically heat-treated



④

Blank sand-blasted



⑤

Cold extrusion, inside profile produced ready, outside profile adjusted



⑥

Mechanically worked, turned, drilled, inner groove milled, knurled and inscribed



⑦

Hardened and tempered



⑧

Surface worked, sand-blasted



⑨

Nickel-plated and chrome-plated



⑩

Blade pressed in

Advantages of cold compression moulding

- High degree of dimensional accuracy
- High surface quality



Hand tools

Range of sockets



Manufacturing process of a HAZET reversible ratchet



①

Splitter



②

Forging



③

Deburring



④

Turning



⑤

Processing
hardening and
tempering



⑥

Chrome-plating



⑦

Ratchet wheel
installation



⑧

Cover plate
installation



⑨

Retaining ring
installation



⑩

Handle
installation



Key:

- ① Pawl
- ② Spring sleeve
- ③ Shift lever
- ④ Ball
- ⑤ Compression spring
- ⑥ Ratchet wheel
- ⑦ Cover plate
- ⑧ Circlip



At a glance

The HAZET reversible ratchet range

		6.3 1/4"	10 3/8"	12.5 1/2"	20 3/4"	25 1"	6.3 1/4"	8 5/16"
	Fine-tooth	863 HP 90 teeth l 116 mm	8816 HP 90 teeth l 200 mm	916 HP 90 teeth l 275 mm 916 HP K 90 teeth l 200 mm			863 HP B 90 teeth l 116 mm	
	Fine-tooth, quick-release locking device	863 HP S 90 teeth l 116 mm	8816 HP S 90 teeth l 200 mm	916 HP S 90 teeth l 275 mm				
	Standard	863 P 20 teeth l 115 mm	8816 P 30 teeth l 199 mm	916 SP 32 teeth l 275 mm	1016/2 32 teeth l 620 mm	1116/2 32 teeth l 824 mm		
	With hinge		8816 G 30 teeth l 276 mm	916 GL 32 teeth l 511 mm				
	Short, with hinge		8816 GK 30 teeth l 218 mm					
	Short			916 K 32 teeth l 199 mm				
	Solid steel						863 M Bit 20 teeth l 89 mm 863 MB 60 teeth l 90 mm	
	Long, fine-tooth			916 HP L 90 teeth l 415 mm				
	Long, extendable, fine-tooth			916 HP Lg 90 teeth l 414-614 mm				



HAZET sockets

	Design		6.3 1/4"	10 3/8"	12.5 1/2"	20 3/4"	25 1"
Sockets for manual operation							
	Hexagon profile		850 (A) 3 - 14 (5/16 - 9/16)	880 6 - 22	900 8 - 36	1000 19 - 60	
	12-point profile			880 Z 9 - 22 (1/4 - 15/16)	900 Z 8 - 36 (5/8 - 1.1/4)	1000 Z 22 - 55 (7/8 - 2)	1100 Z 32 - 80
	Hexagon profile, long		850 Lg 4 - 13	880 Lg 8 - 22	900 Lg 10 - 32		
	12-point profile, long		850 TZ 8	880 TZ 9 - 22	900 TZ 10 - 30		
	With hinge, Hexagon profile			880 G 10 - 19			
	With hinge, 12-point profile			880 G-Z 16 - 18			
	Outside TORX ® profile		850-E E 4 - E 12	880 E E 5 - E 14	900 E E 10 - E 24		
	Outside TORX ® profile, long			880 Lg-E E 8 - E 14			
	With hinge, Outside TORX ® profile		850 Lg-G E 10	880 G E 8 - E 14			
Screwdriver sockets for manual operation							
	Slot profile		8503 3,5 - 10		980 13 - 19		
	Slot profile, long			8803 5,5 - 10			
	Cross recess profile PH (Phillips)		8506 PH 1 - PH 4				
	Cross recess profile PH (Phillips), long			8806 PH 1 - PH 4			
	Cross recess profile PZ (Pozidriv)		8507 PZ 1 - PZ 3				
	Inside hexagon profile		8501 2,5 - 8	8801 3 - 10	985 5 - 22 986 4 - 22 (5/32 - 1/2) 2584	1010 14 - 22 2784	
	Inside hexagon profile, long			8801 3 - 12 (1/8 - 3/8)	986 (S) L 4 - 14 2584-1	2784 14	
	Inside hexagon profile, long, ball-head		8501 KK 4	8801 KK 5 - 10	986 KK 5 - 12 2527-8		



Design			6.3 1/4"	10 3/8"	12.5 1/2"	20 3/4"	25 1"
Screwdriver sockets for manual operation							
	Inside TORX ® profile		8502 T 8 – T 40	8802 T 15 – T 50	992 T 20 – T 60	1012 T 60 – T 100	
	Inside TORX ® profile, long				992 (S) Lg T 30 – T 70		
	Tamper TORX ® profile				992 T 30 H – T 55 H		
	RIBE CV profile				991 5 – 16		
	Internal serration profile (XZN)			8808 5 – 10	990 5 – 18		
	Internal serration profile (XZN), long			8808 Lg 6 – 10	990 Lg 6 – 14 2751		
Adapters for manual operation							
	Adapter (amplifier)	6.3 1/4"		8858-2			
	Adapter (reducer and amplifier)	10 3/8"	858-1		958-2		
	Adapter (reducer and amplifier)	12.5 1/2"		8858-1		1058-2	
	Adapter (reducer and amplifier)	20 3/4"			958-1		1158-2
	Adapter (reducer)	25 1"				1058-1	
	Adapters for bits		2250-1	2250-2 2250-3	2250-4 2250-5		
	Universal joint		869	8820	920	1021	1121
Sockets for impact operation							
	Hexagon profile for impact operation				900 S 13 – 32	1000 S 19 – 36	1100 S 24 – 60
	Hexagon profile, short, for impact operation				900 S K 14 – 24		
	Hexagon profile, long, for impact operation				900 S Lg 13 – 27	1000 S Lg 24 – 36	1100 S Lg 24 – 46
	Hexagon profile, long, extra slim, for impact operation				901 S Lg 902 S Lg 15 – 21		



Hand tools

Range of sockets



	Design		6.3 1/4"	10 3/8"	12.5 1/2"	20 3/4"	25 1"
Sockets for impact operation							
	Hexagon profile, extra long, for impact operation					1004 S 32 - 33	1104 S 32
	Hexagon profile, extra long, for impact operation				900 S Z 12 - 36 900 SZ 6-18-36 3047-36		
	Outside TORX ® profile, for impact operation			880 S-E 10 - 12	900 S-E10 - 24		
	Outside TORX ® profile, long, for impact operation					2850-E 20, 24	
Screwdriver sockets for impact operation							
	Inside hexagon profile, for impact operation				985 S 14 - 24		
	Inside hexagon profile, long, for impact operation				985 S Lg 14 - 19		
	Internal serration profile (XZN), for impact operation				990 S 14 - 18		
	Internal serration profile (XZN), long, for impact operation				990 S Lg 14 - 18		
	Inside TORX ® profile, for impact operation				995 S T 30 - T 60		
Adapters for impact operation							
	Universal joint, for impact operation				9006 S	1006 S	1106 S
	Reducer, for impact operation			8807 S	9007 S	1007 S-1	1107 S
	Amplifier, for impact operation			8807 S-1	9007 S-1	1007 S-2	
	Adapter, for impact operation		8508 S-1	8808 S-1			
	Adapter, for impact operation		2304 N 2238-1 8508 S-3 4				
	Adapter, for impact operation				2311		
	Adapter, for impact operation					1003 S-1	



Hand tools

Range of sockets



HAZET SMART CASE

 **DESIGNED & PRODUCED
IN GERMANY**



**GERMAN
INNO
VATION
AWARD '21
WINNER**

BE SMART. IN ANY CASE



www.hazet.de/smartcase





Hand tools

Range of sockets

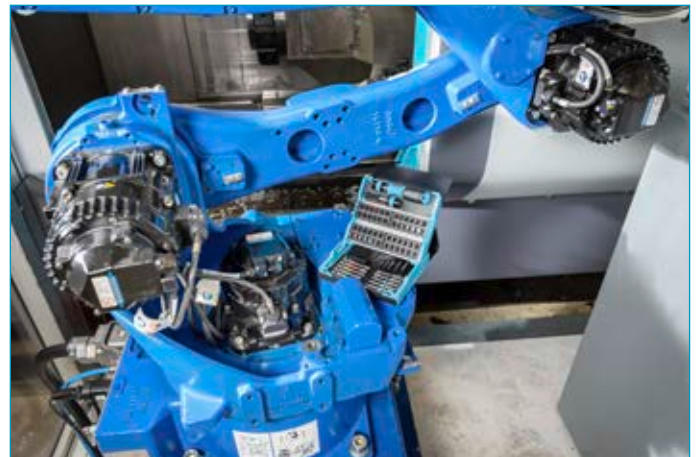
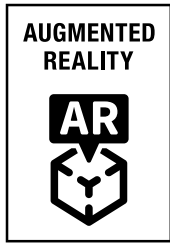



HAZET SMART RAIL

Landing page
SmartRails



SmartRails available for holding
5 1/2" sockets



...or 8 1/2" sockets



...or 7 1/4" sockets





Hand tools

Range of sockets



HAZET SMART HOLDER

Landing page
SmartHolder



reddot winner 2023



863 MB

Mini solid steel fine-tooth reversible ratchet with 60 teeth and a 6° operating angle for working in restricted spaces



810 BMK

Bit holder (length: 80 mm) with magnet for securing bits

SmartHolder with 16 screwdriver bits, short



SmartHolder with 8 screwdriver bits, long



Bit magazine with pull-out kickstand. Set up using the button on the side



Bit strips push away against each other – all bits are easy to remove

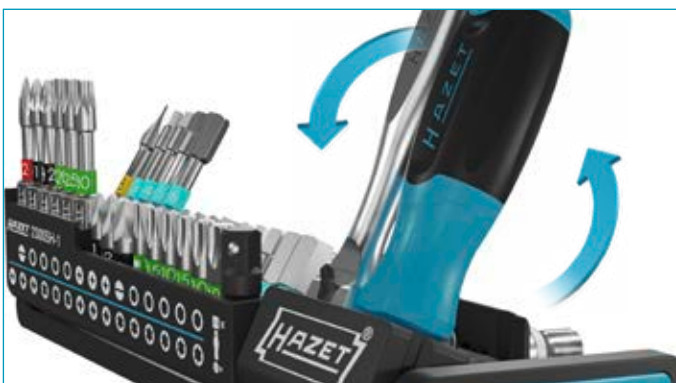

Tool storage with bit holder and mini solid steel fine-tooth reversible ratchet. Set up by simply pulling on one of the two tools



When closed, all parts are always safely locked in place – it's impossible for parts to fall out! To remove, turn the socket and pull it out upwards



6.3 1/4 Range of sockets

853 Socket set

Made in Germany

- Plastic box 165-S (1/9)
- Safety-Insert-System, 2-component soft foam insert. Insert also suitable for HAZET Assistant



1/9			
-----	--	--	--



850 • • 1/4
5.5 • 6 • 7 • 8 • 9
10 • 11 • 12 • 13 • 14

863 HP • 1/4

866 U • 1/4

867-2 • 1/4 • 1/4

867-4 • 1/4 • 1/4

2204 N • • 1/4
3 • 4 • 5 • 6 • 7

2208 N • • 1/4
0.6x4.5 • 1.2x6.5 • 1.2x8

2215 N • • 1/4
PH1 • PH2 • PH3

2216 N • • 1/4
PZ1 • PZ2 • PZ3

2223 N • • 1/4
T10H • T15H • T20H
T25H • T27H • T30H
T40H

2250-1 • • 1/4

HAZET No.	L x W x H mm		EAN-No. 4000896+
853-1	185x153x52	36	154654

854 Socket set

Made in Germany

- Screwdriver sockets, CVD-Titanium Nitride (TIN) coated
- Plastic box 165-S (1/9)
- Safety-Insert-System, 2-component soft foam insert. Insert also suitable for HAZET Assistant



1/9			
-----	--	--	--

850 • • 1/4
4 • 5 • 5.5 • 6
7 • 8 • 9 • 10
11 • 12 • 13 • 14

8501 • • 1/4
3 • 4 • 5 • 6 • 8

8503 • • 1/4
0.6x3.5 • 1x5.5 • 1.2x8

8506 • • 1/4
PH1 • PH2

8507 • • 1/4
PZ1 • PZ2

863 HP • 1/4

865 • 1/4

866 U • 1/4

867-2 • 1/4 • 1/4

868 • 1/4 • 1/4

869 • 1/4 • 1/4

HAZET No.	L x W x H mm		EAN-No. 4000896+
854	185x153x52	30	038336

854 Socket set

Made in Germany

- Screwdriver sockets, CVD-Titanium Nitride (TIN) coated
- Plastic box 165-S (1/9)
- Safety-Insert-System, 2-component soft foam insert. Insert also suitable for HAZET Assistant



1/9			
-----	--	--	--

850 • • 1/4
4 • 5 • 6 • 7 • 8 • 9
10 • 11 • 12 • 13 • 14

8501 • • 1/4
3 • 4 • 5 • 6 • 8

8503 • • 1/4
0.6x3.5 • 0.8x4
1x5.5 • 1.2x8

8506 • • 1/4
PH1 • PH2 • PH3 • PH4

8507 • • 1/4
PZ1 • PZ2 • PZ3

863 HP • 1/4

865 • 1/4

866 U • 1/4

867-2 • 1/4 • 1/4

868 • 1/4 • 1/4

869 • 1/4 • 1/4

HAZET No.	L x W x H mm		EAN-No. 4000896+
854-1	185x153x52	33	038343

854T Socket set

Made in Germany

- Screwdriver sockets, CVD-Titanium Nitride (TIN) coated
- Plastic box 165-S (1/9)
- Safety-Insert-System, 2-component soft foam insert. Insert also suitable for HAZET Assistant



1/9			
-----	--	--	--

850 • • 1/4
5 • 5.5 • 6 • 7
8 • 9 • 10 • 11
12 • 13 • 14

850E • • 1/4
E5 • E6 • E7 • E8 • E10

8501 • • 1/4
3 • 4 • 5 • 6

8502 • • 1/4
T10 • T15 • T20
T25 • T30

8503 • • 1/4
1x5.5

8506 • • 1/4
PH2

863 HP • 1/4

866 U • 1/4

867-2 • 1/4 • 1/4

868 • 1/4 • 1/4

869 • 1/4 • 1/4

871-4 • 1/4 • 1/4

HAZET No.	L x W x H mm		EAN-No. 4000896+
854T	185x153x52	33	109579



Hand tools

6.3 1/4 Range of sockets



855 Socket set

Made in Germany

- Sockets in long and short design
- Screwdriver sockets, CVD titanium nitride (TIN) coated
- Plastic box 165-L (1/3)
- Safety-Insert-System, 2-component soft foam insert. Insert also suitable for HAZET Assistant

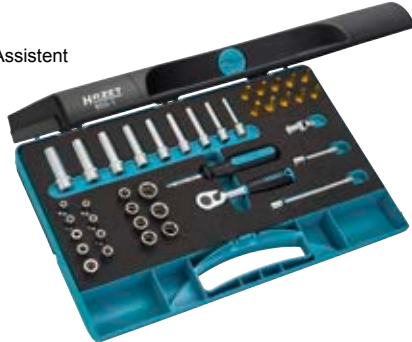

1/3			
-----	--	--	--

850 • 6.3 1/4
4 • 4.5 • 5 • 6
7 • 8 • 9 • 10
11 • 12 • 13

850 LG • 6.3 1/4
5 • 6 • 7 • 8 • 9
10 • 11 • 12 • 13

850 E • 6.3 1/4
E5 • E6 • E7 • E8 • E10

8501 • 6.3 1/4
3 • 4 • 5

8502 • 6.3 1/4
T10 • T15 • T20
T25 • T30

8503 • 6.3 1/4
1x5.5

8506 • 6.3 1/4
PH2

863 HP • 6.3 1/4

866 U • 6.3 1/4

867-2 • 6.3 1/4 • 6.3 1/4

867-4 • 6.3 1/4 • 6.3 1/4

869 • 6.3 1/4 • 6.3 1/4

HAZET No.	L x W x H mm	□	EAN-No. 4000896+
855-1	355x235x65	40	115983

2200 Socket set

- Plastic box 165-S (1/9)
- Safety-Insert-System, 2-component soft foam insert. Insert also suitable for HAZET Assistant



1/9			
-----	--	--	--

850 • 6.3 1/4
5 • 5.5 • 6 • 7
8 • 9 • 10 • 11
12 • 13 • 14

2204 N • 6.3 1/4
2 • 2.5 • 3 • 4 • 5 • 6 • 8

2208 N • 6.3 1/4
0.5x4 • 0.6x4.5
1.2x6.5 • 0.8x5.5

2215 N • 6.3 1/4
PH1 • PH2

2216 N • 6.3 1/4
PZ1 • PZ2

2223 N • 6.3 1/4
T10H • T15H • T20H
T25H • T30H • T40H

2238-1 • 6.3 1/4 • 6.3 1/4

2239-3 • 6.3 1/4 • 6.3 1/4

863 HPB • 6.3 1/4

2304 N • 6.3 1/4 • 6.3 1/4

HAZET No.	L x W x H mm	□	EAN-No. 4000896+
2200/36	185x153x52	36	063734

2200 SmartCase socket set

HAZET SmartCase – be smart – In any case

- Developed and produced „Made in Germany“
- Innovative concept of a compact, foldable tool set
- Easy to clean material and pleasant surface feel
- Combines the advantages of a slim and light soft surface (black) with the durability of a hard-shell tool box
- Durable, robust tool holder – no tools rolling around or rattling
- Magnetic fastener – quick to open and wear-free
- Stable and easily accessible tool storage
- Maximum number of tools in the smallest space for the best overview
- Optimal overview and easy removal of the tool – can be folded flat or – similar to a tablet case – can be stood up
- 21 bits 25 mm long · 12 bits 50 mm long



863 HPB • 6.3 1/4

850 • 6.3 1/4
4 • 5 • 5.5 • 6
7 • 8 • 9 • 10
11 • 12 • 13 • 14

867-4 • 6.3 1/4 • 6.3 1/4

2304 N • 6.3 1/4 • 6.3 1/4

2208 N • 6.3 1/4
0.5x4 • 0.6x4.5 • 1.2x6.5

2208 NSLG • 6.3 1/4
0.8x5.5

2215 N • 6.3 1/4
PH1 • PH2 • PH3

2215 NSLG • 6.3 1/4
PH1 • PH2

2216 N • 6.3 1/4
PZ1 • PZ2 • PZ3

2216 NSLG • 6.3 1/4
PZ1 • PZ2

2204 N • 6.3 1/4
2 • 3 • 4 • 5 • 6

2204 NSLG • 6.3 1/4
3 • 4 • 5 • 6

2223 N • 6.3 1/4
T10 • T15 • T20 • T25
T27 • T30 • T40

2223 NSLG • 6.3 1/4
T20 • T25 • T30



HAZET No.	L x W x H mm	□	EAN-No. 4000896+
2200 SC-2	130x118x50	50	239603



2200 SmartCase socket set

HAZET SmartCase – be smart – In any case

- Developed and produced „Made in Germany“
- Innovative concept of a compact, foldable tool set
- Easy to clean material and pleasant surface feel
- Combines the advantages of a slim and light soft surface (black) with the durability of a hard-shell tool box
- Durable, robust tool holder – no tools rolling around or rattling
- Magnetic fastener – quick to open and wear-free
- Stable and easily accessible tool storage
- Maximum number of tools in the smallest space for the best overview
- Optimal overview and easy removal of the tool – can be folded flat or – similar to a tablet case – can be stood up
- 15 bits 25 mm long · 12 bits 50 mm long · 12 bits 89 mm extra long

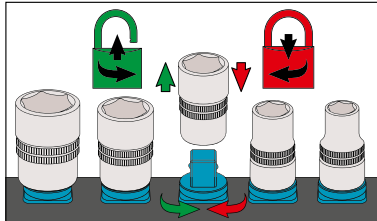

810BHK • 6.3 1/4

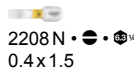

2208 N • 0.4x1.5

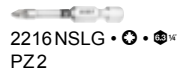

2216 NSLG • PZ2

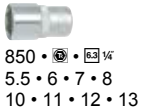

850 • 5.5 • 6 • 7 • 8
10 • 11 • 12 • 13

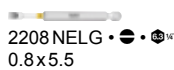

2208 NELG • T10 • T15 • T20
T25 • T30 • T40



2223 N • T10 • T15 • T20
T25 • T30 • T40



863 HPB

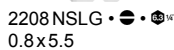

2208 NSLG • 0.8x5.5

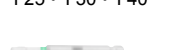

2223 NELG • T20 • T25 • T30



2100 • PH1 • PH2 • PH3

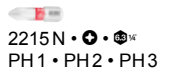

2215 N • PH1 • PH2

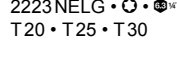

2223 NSLG • T20 • T25 • T30

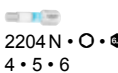

2204 N • 4 • 5 • 6

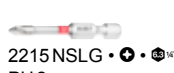

2215 NELG • PH1 • PH2



2239-1

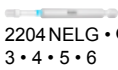

2204 NELG • 3 • 4 • 5 • 6



2216 N • PZ1 • PZ2



2239 N-6

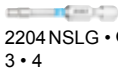

2204 NSLG • 3 • 4

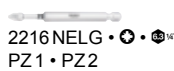

2216 NELG • PZ1 • PZ2

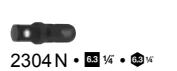

2304 N

HAZET No.	L x W x H mm	Icon	EAN-No. 4000896+
2200 SC-32	210x118x50	59	244546

856 Socket set

Made in Germany

- Ergonomic design
- Easy handling, operating tools are ready to hand when needed
- Plastic box (52x98x180 mm)

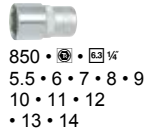

850 • 5.5 • 6 • 7 • 8 • 9
10 • 11 • 12
• 13 • 14

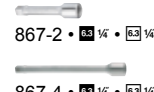

867-2 • 6.3 1/4 • 6.3 1/4

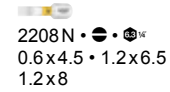

2208 N • 0.6x4.5 • 1.2x6.5
1.2x8

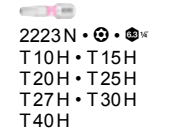

2223 N • T10H • T15H
T20H • T25H
T27H • T30H
T40H



863 P • 6.3 1/4



869 • 6.3 1/4 • 6.3 1/4

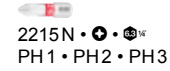

2215 N • PH1 • PH2 • PH3

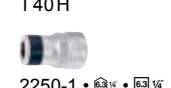

2250-1 • 6.3 1/4 • 6.3 1/4



866 U • 6.3 1/4

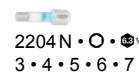

2204 N • 3 • 4 • 5 • 6 • 7



2216 N • PZ1 • PZ2 • PZ3



2304 N • 6.3 1/4 • 6.3 1/4

HAZET No.	L x W x H mm	Icon	EAN-No. 4000896+
856-1	180x98x52	38	164813

856 Socket set

Made in Germany

- Ergonomic design
- Easy handling, operating tools are ready to hand when needed
- Plastic box (52x98x180 mm)

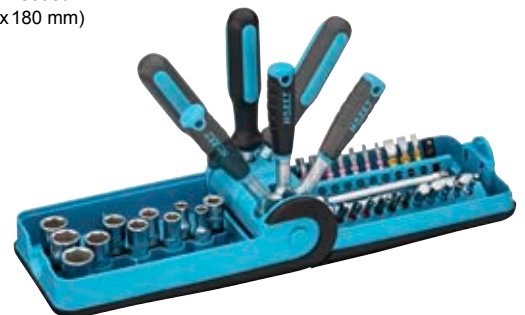

850 • 5.5 • 6 • 7 • 8 • 9
10 • 11 • 12
• 13 • 14

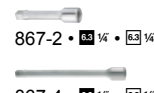

867-2 • 6.3 1/4 • 6.3 1/4

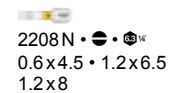

2208 N • 0.6x4.5 • 1.2x6.5
1.2x8

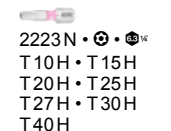

2223 N • T10H • T15H
T20H • T25H
T27H • T30H
T40H



863 HP • 6.3 1/4



869 • 6.3 1/4 • 6.3 1/4

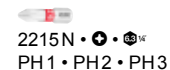

2215 N • PH1 • PH2 • PH3



2250-1 • 6.3 1/4 • 6.3 1/4

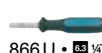

866 U • 6.3 1/4

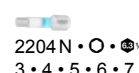

2204 N • 3 • 4 • 5 • 6 • 7

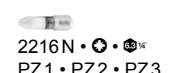

2216 N • PZ1 • PZ2 • PZ3



2304 N • 6.3 1/4 • 6.3 1/4

HAZET No.	L x W x H mm	Icon	EAN-No. 4000896+
856-1 HP	180x98x52	38	233380



Hand tools

6.3 1/4" Range of sockets



850 HL Socket rail

- Easy installation: 2 boreholes, e.g. for wall fixation
- Holding clamps adapted to the drive size
- Suitable for sockets 850
- Empty, with 16 retaining clamps

6.3 1/4"



HAZET No.	l mm	EAN-No. 4000896+
850 HL	430	037575

850 SR SmartRail · Flexible plastic plug-in rail

Made in Germany

6.3 1/4"

- Magnetic underside ensures grip on all ferrous surfaces, e.g. on tool trolleys, tool walls, machines, lifting platforms and in metal drawers

- HAZET SmartRail – Developed and produced „Made in Germany“
- Easy to clean
- Durable, robust twist lock for a tight fit and instant access
- More securely fixed when locked: turn socket left to remove
- Robust metal lug for hanging
- With 1/4" square sockets
- Empty, with 7x 1/4" square sockets

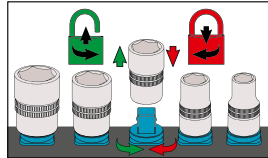

HAZET No.	L x W x H mm	EAN-No. 4000896+
850 SR-7	245x37.4x29.2	249626

863 1/4" Reversible ratchet · fine-tooth

Made in Germany

6.3 1/4"

- A lot more power than with ratchets with the same dimensions

- Latching function of the shift lever provides protection against unwanted switching
- Increased service life thanks to the use of state-of-the-art lubricants in the ratchet mechanism
- Strict production tolerances prevent dirt from getting in
- HAZET internal quality standards guarantee loading capacity far beyond the standard requirements
- High-quality, easy to clean, corrosion-resistant
- Integrated suspension option in the handle
- VPA tested, static torque according to DIN 3122: 120 Nm (DIN: 62 Nm)
- Number of teeth: 90 (Opening angle 4°)
- With locking ball
- HAZET 2-component handle
- Surface: chrome-plated
- DIN 3122, ISO 3315



YouTube Clip



YouTube Clip



863 1/4" Reversible ratchet · fine-tooth

6.3 1/4"



HAZET No.	l mm	EAN-No. 4000896+
863 HP	116	226917

863 1/4" Reversible ratchet

Made in Germany

6.3 1/4"

- Number of teeth: 20 (Opening angle 18°)
- With locking ball
- HAZET 2-component handle
- Surface: chrome-plated, head polished
- DIN 3122, ISO 3315



HAZET No.	l mm	EAN-No. 4000896+
863 P	115	038558

863 1/4" Reversible ratchet · fine-tooth

Made in Germany

6.3 1/4"

- A lot more power than with ratchets of the same dimensions

- Latching function of the shift lever provides protection against unwanted switching
- Increased service life thanks to the use of state-of-the-art lubricants in the ratchet mechanism
- Strict production tolerances prevent dirt from getting in
- HAZET internal quality standards guarantee loading capacity far beyond the standard requirements
- High-quality, easy to clean, corrosion-resistant
- Integrated suspension option in the handle
- VPA tested, static torque according to DIN 3122: 100 Nm (DIN: 62 Nm)
- Quick-release safety lock
- Sockets are securely locked in place
- Attached tools can easily be released by pressing the button with just one hand
- Number of teeth: 90 (Opening angle 4°)
- With locking ball
- HAZET 2-component handle
- Surface: chrome-plated
- DIN 3122, ISO 3315

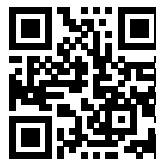

YouTube Clip



HAZET No.	l mm	EAN-No. 4000896+
863 HPS	116	237234



863-Bit 1/4" Reversible ratchet for screwdriver bits · fine-tooth

Made in Germany

• A lot more power than with ratchets with the same dimensions



- Latching function of the shift lever provides protection against unwanted switching
- Increased service life thanks to the use of state-of-the-art lubricants in the ratchet mechanism
- Strict production tolerances prevent dirt from getting in
- HAZET internal quality standards guarantee loading capacity far beyond the standard requirements
- Chrome-plated surface: High-quality, easy to clean, corrosion resistant
- Integrated suspension option in the handle
- VPA tested, static torque according to DIN 3122: 120 Nm (DIN: 62 Nm)
- Number of teeth: 90 (Opening angle 4°)
- With locking spring to securely hold the bits
- HAZET 2-component handle
- Surface: chrome-plated

HiPer
HIGH PERFORMANCE
THE ORIGINAL
MADE IN GERMANY



HAZET No.	l mm	EAN-No. 4000896+
863 HPB	116	235346

863-Bit 1/4" Reversible ratchet · solid steel · for bits

Made in Germany

• 90 mm short design



- Number of teeth: 60 (Opening angle 6°)
- With locking spring to securely hold the bits
- Surface: chrome-plated



HAZET No.	l mm	EAN-No. 4000896+
863 MB	90	212187



Wear? – No problem!

- HAZET tools are manufactured to the highest quality. During long intensive loading there is a certain level of wear even for high-quality tools.
- For this reason, there are spare parts and replacement sets available for many of our tools.



Please also see our spare parts shop
www.hazet.de/ersatzteil-shop

Cost-saving – Sustainable – Resource-saving!
For long-term pleasure with your HAZET tools

863 Replacement set

Made in Germany

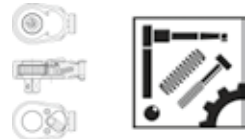

HAZET No.	EAN-No. 4000896+
<ul style="list-style-type: none"> • Replacement set for shift lever consisting of: shift lever · pawl · screws · ball · compression spring For HAZET reversible ratchet 863K · 863 · 863G · 863P · 863PC · 863Q · 863S · 863ST · 863BGL · 863BKC · 863BK · 863MC · 863Mbit · 2264 	144600
<ul style="list-style-type: none"> • Replacement set for ratchet wheel 6.3 = 1/4" ■ consisting of: ratchet wheel · pawl · shift lever · screws · ball · compression spring For HAZET reversible ratchet 863G · 863P · 863PC · 863ST · 863K · 863MC 	038596
<ul style="list-style-type: none"> • Replacement set for ratchet wheel with safety lock 6.3 = 1/4" ■ consisting of: Ratchet wheel with safety lock · pawl · shift lever · screws · ball · compression spring For HAZET reversible ratchets 863Q · 863S as well as for retrofitting HAZET reversible ratchets 863P · 863PC · 863G · 863ST · 863K · 863MC 	048472
<ul style="list-style-type: none"> • Replacement set for ratchet wheel 6.3 = 1/4" ■ consisting of: pawl · compression spring · ball · spring sleeve · shift lever · cover disc · circlip · ratchet wheel · grease · assembly tool For reversible ratchet 863HP 	234875
<ul style="list-style-type: none"> • Replacement set for ratchet wheel with safety lock 6.3 = 1/4" ■ consisting of: assembly tool · cover plate · ratchet wheel with safety lock · circlip · cover disc · shift lever · spring sleeve · ball · compression spring · pawl · grease For HAZET reversible ratchet 863HPS as well as for retrofitting HAZET reversible ratchet 863HP (reduction to maximum 100Nm peak load) 	241262
<ul style="list-style-type: none"> • Replacement set for bit ratchet wheel ○ 6.3 = 1/4" consisting of: assembly tool · cover plate · bit ratchet wheel · circlip · cover disc · shift lever · spring sleeve · ball · compression spring · pawl · grease For reversible ratchet 863HPB 	241279
<ul style="list-style-type: none"> • Replacement set for ratchet wheel ○ 6.3 = 1/4" consisting of: ratchet wheel · pawl · shift lever · screws · ball · compression spring For HAZET reversible ratchet 863BGL · 863BKC · 863BK · 863Mbit · 2264 	015917

866 U 1/4" Spin type speeder

Made in Germany



- With locking ball
- HAZET 2-component handle
- Surface: matt chrome-plated
- DIN 3122, ISO 3315



HAZET No.	l mm	EAN-No. 4000896+
866 U	134	056453



Hand tools

6.3 1/4" Range of sockets



866 1/4" Spin type speeder with T-handle

- With locking ball
- 2-component T-handle
- Surface: matt chrome-plated

6.3 1/4"

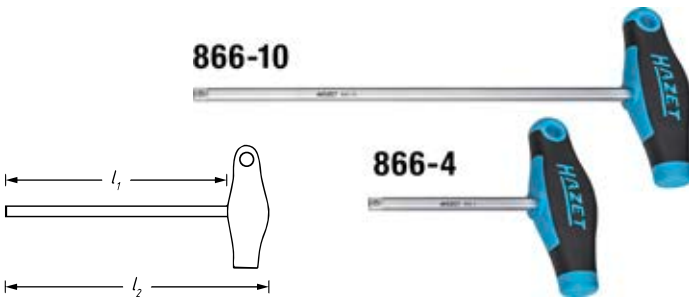

HAZET No.	l ₁ mm	l ₂ mm	EAN-No. 4000896+
866-4	100	134	242979
866-10	262	295	241842

865 1/4" Sliding T-handle

Made in Germany

- With locking ball
- Surface: chrome-plated, polished
- DIN 3122, ISO 3315

6.3 1/4"



HAZET No.	l mm	EAN-No. 4000896+
865	115	038718

850 1/4" Socket · hexagon

Made in Germany

- With knurling
- Surface: chrome-plated, polished
- DIN 3124, ISO 2725-1

6.3 1/4"

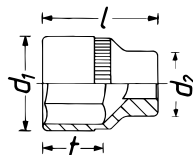

¹⁾ Not according to DIN

HAZET No.	l mm	d ₁ mm	d ₂ mm	f mm	EAN-No. 4000896+
850-3 ¹⁾	25	6.2	11	3.2	057221
850-4	25	6.8	11	3.7	036370
850-4.5	25	7.4	11	4.2	036387
850-5	25	8.1	11	4.1	036400
850-5.5	25	8.7	11	4.6	036417
850-6	25	9.3	11	5.1	036479
850-7	25	10.9	11.5	5.5	036516
850-8	25	12.1	12.5	6.5	036547
850-9	25	13.4	12.5	7.5	036585
850-10	25	14.6	12.5	7.3	036202
850-11	25	15.5	14	8.3	036240
850-12	25	17	15	9.3	036271
850-13	25	18	15	9.3	036301
850-14	25	19.5	16	10.8	036349

850 SmartRail · Flexible plastic plug-in rail

Made in Germany

- Magnetic underside ensures grip on all ferrous surfaces, e.g. on tool trolleys, tool walls, machines, lifting platforms and in metal drawers

6.3 1/4" E

- HAZET SmartRail – Developed and produced „Made in Germany“
- Easy to clean
- Durable, robust twist lock for a tight fit and instant access
- More securely fixed when locked: turn socket left to remove
- Robust metal lug for hanging
- With 1/4" square sockets

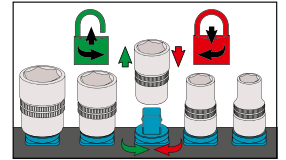

850 · 6.3 1/4" E
5.5 · 6 · 7 · 8 · 10 · 11 · 13



HAZET No.	l mm	EAN-No. 4000896+
850-SR/7	245	250776

850 A 1/4" Socket · hexagon

Made in Germany

- American dimensions
- With knurling
- Surface: chrome-plated, polished

6.3 1/4"

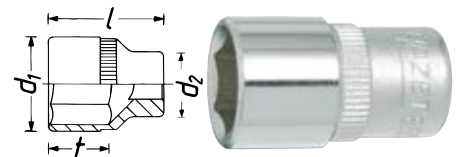

HAZET No.	l mm	d ₁ mm	d ₂ mm	f mm	EAN-No. 4000896+
850 A-3/16	25	8	11	4.2	037490
850 A-7/32	25	8.5	11	4.6	037537
850 A-1/4	25	9.5	11	5.1	037476
850 A-9/32	25	10.5	11.5	5.6	037551
850 A-5/16	25	11.5	12.5	6.3	037513
850 A-11/32	25	13	11.5	7.3	037483
850 A-3/8	25	14	12.5	7.3	037506
850 A-7/16	25	15.5	14	8.3	037520
850 A-1/2	25	18	15	9.3	037469
850 A-9/16	25	19.5	16	10.8	037544

850 A SmartRail · Flexible plastic plug-in rail

Made in Germany

- Magnetic underside ensures grip on all ferrous surfaces, e.g. on tool trolleys, tool walls, machines, lifting platforms and in metal drawers

6.3 1/4" E

- HAZET SmartRail – Developed and produced „Made in Germany“
- Easy to clean
- Durable, robust twist lock for a tight fit and instant access
- More securely fixed when locked: turn socket left to remove
- Robust metal lug for hanging
- With 1/4" square sockets

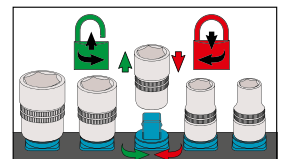

850 A · 6.3 1/4" E
3/16 · 1/4 · 5/16 · 3/8 · 7/16 · 1/2 · 9/16



HAZET No.	l mm	EAN-No. 4000896+
850 A-SR/7	245	250752



850 LG 1/4" Socket · hexagon

Made in Germany

- Long design
- With knurling
- Surface: chrome-plated
- DIN 3124, ISO 2725-1

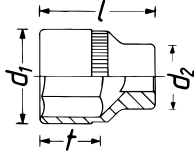
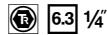

HAZET No.	l mm	d ₁ mm	d ₂ mm	t mm	EAN-No. 4000896+
850 LG- 4	50	6.9	11	4	037643
850 LG- 5	50	8.2	11	4.2	037650
850 LG- 5.5	50	8.8	11	5	037667
850 LG- 6	50	9.4	11	5.5	037674
850 LG- 7	50	11	11	6	037681
850 LG- 8	50	12	12	8	037698
850 LG- 9	50	13	13	8	037704
850 LG-10	50	14.5	14.5	9.2	037599
850 LG-11	50	15.5	15.5	10.7	037605
850 LG-12	50	17	17	12.2	037612
850 LG-13	50	18	18	12.2	037629

850 LG SmartRail · Flexible plastic plug-in rail

Made in Germany

- Magnetic underside ensures grip on all ferrous surfaces, e.g. on tool trolleys, tool walls, machines, lifting platforms and in metal drawers

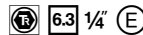

- HAZET SmartRail – Developed and produced „Made in Germany“
- Easy to clean
- Durable, robust twist lock for a tight fit and instant access
- More securely fixed when locked: turn socket left to remove
- Robust metal lug for hanging
- With 1/4" square sockets

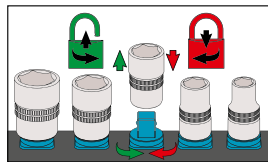

850 LG • • 1/4
5.5 • 6 • 7 • 8 • 10 • 12 • 13



HAZET No.	l mm		EAN-No. 4000896+
850 LG-SR/7	245	7	250691

850 TZ 1/4" Socket · 12-point

Made in Germany

- Operation of the screws at the timing chain cover on e.g. VW 1.2 I TSI engines

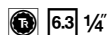

- Long design
- With knurling
- Surface: chrome-plated
- DIN 3124, ISO 2725-1

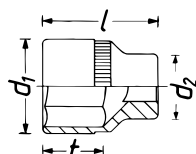

HAZET No.	l mm	d ₁ mm	d ₂ mm	t mm	EAN-No. 4000896+
850 TZ-8	50	12.2	12.2	8	177646

850 E 1/4" Socket · TORX®

Made in Germany

- With knurling
- Surface: chrome-plated, polished

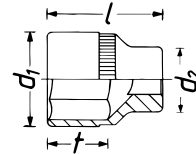
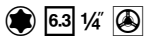

HAZET No.	s	l mm	d ₁ mm	d ₂ mm		EAN-No. 4000896+
850-E 4	E4	25	5.6	11	3.86	036653
850-E 5	E5	25	6.7	11	4.75	036684
850-E 6	E6	25	8	11	5.74	036714
850-E 7	E7	25	9.6	11	6.22	036745
850-E 8	E8	25	10.5	11.5	7.52	036776
850-E 10	E10	25	13	12	9.42	036615
850-E 11	E11	25	14	12.5	10.08	036646
850-E 12	E12	25	14.9	12.5	11.17	188598

850 LG-GE 1/4" Socket · TORX®

Made in Germany

- Socket and extension permanently connected
- With hinge – for working in areas with restricted access and for getting around obstructive edges
- Surface: chrome-plated, polished

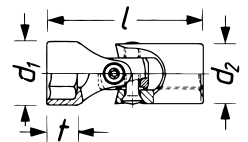
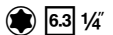

HAZET No.	s	l mm	d ₁ mm	d ₂ mm		EAN-No. 4000896+
850 LG-GE 10	E10	150	12	13.5	9.42	223572

850 E SmartRail · Flexible plastic plug-in rail

Made in Germany

- Magnetic underside ensures grip on all ferrous surfaces, e.g. on tool trolleys, tool walls, machines, lifting platforms and in metal drawers

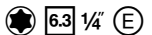

- HAZET SmartRail – Developed and produced „Made in Germany“
- Easy to clean
- Durable, robust twist lock for a tight fit and instant access
- More securely fixed when locked: turn socket left to remove
- Robust metal lug for hanging
- With 1/4" square sockets

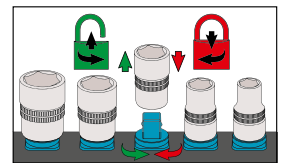

850 E • • 1/4
E5 • E6 • E7 • E8 • E10 • E11 • E12

HAZET No.	l mm		EAN-No. 4000896+
850 E-SR/7	245	7	250714



Hand tools

6.3 1/4" Range of sockets



TiN coating

TiN

Why choose TiN (Titanium Nitride) coating?

- A special coating process for extremely hard TiN coating guarantees high adhesive strength and wear resistance of the coating
- Particularly suitable for continuous load, e. g. for industrial applications in industry and trade
- Higher wear protection guarantees a longer lifetime
- Perfect fitting accuracy due to optimum coating thickness
- Optimized corrosion protection

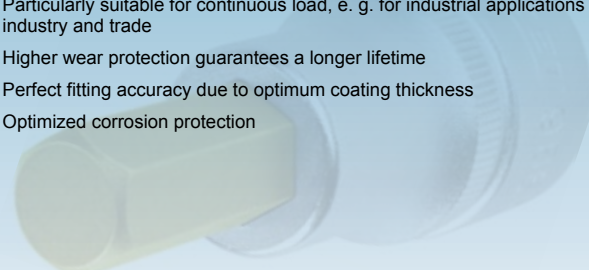

TiN coated screwdriver sockets

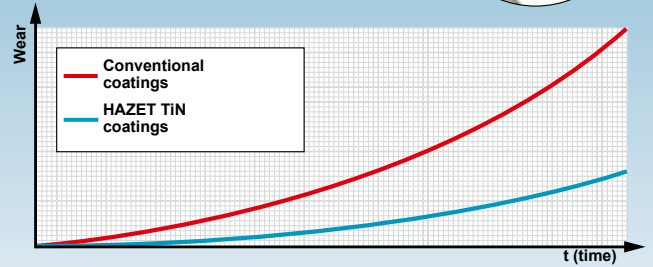
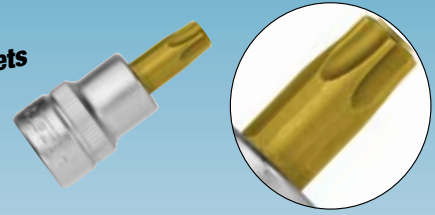

960 MGT Magnetic insert · for sockets

- Universal application in metric 6-point and 12-point sockets s 10 to 19 mm
- Sockets made of plastic with integrated magnet
- Powerful retention force
- Reusable
- 10-piece set, for metric sockets s10 · 11 · 12 · 13 · 14 · 15 · 16 · 17 · 18 · 19 mm

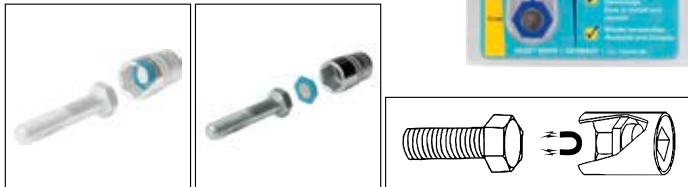

HAZET No.	EAN-No. 4000896+
960 MGT	097661

8501 1/4" Screwdriver socket

- Made in Germany
- Surface: TiN coated
- DIN 7422

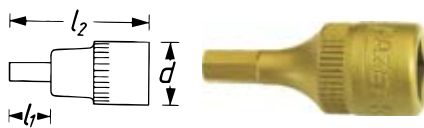

HAZET No.	S mm	l ₁ mm	l ₂ mm	d mm	EAN-No. 4000896+
8501-2.5	2.5	6.5	28	12	036837
8501-3	3	6.5	28	12	036851
8501-4	4	6.5	28	12	036875
8501-5	5	6.5	28	12	036899
8501-6	6	6.5	28	12	036912
8501-7	7	6.5	28	12	210398
8501-8	8	6.5	28	12	036936

8501 KK 1/4" Screwdriver socket

- Made in Germany
- Long design
- With ball-head

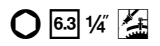

HAZET No.	S mm	l ₁ mm	l ₂ mm	d mm	EAN-No. 4000896+
8501 KK-4	4	60	80	12	157839

8502 1/4" Screwdriver socket · TORX®

- Made in Germany
- With knurling
- Surface: TiN coated

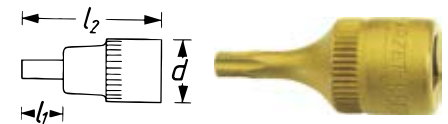

HAZET No.	S	l ₁ mm	l ₂ mm	d mm	mm	EAN-No. 4000896+
8502-T 8	T8	3.5	28	12	2.31	037124
8502-T 9	T9	3.5	28	12	2.50	037148
8502-T 10	T10	3.8	28	12	2.74	036967
8502-T 15	T15	4	28	12	3.27	036981
8502-T 20	T20	4	28	12	3.86	037001
8502-T 25	T25	4.5	28	12	4.43	037025
8502-T 27	T27	4.5	28	12	4.99	037049
8502-T 30	T30	5	28	12	5.52	037063
8502-T 40	T40	2	28	12	6.65	037100





8500 SmartRail · Flexible plastic plug-in rail

Made in Germany



• Magnetic underside ensures grip on all ferrous surfaces, e.g. on tool trolleys, tool walls, machines, lifting platforms and in metal drawers

- HAZET SmartRail – Developed and produced „Made in Germany“
- Easy to clean
- Durable, robust twist lock for a tight fit and instant access
- More securely fixed when locked: turn socket left to remove
- Robust metal lug for hanging
- With 1/4" square sockets
- Surface: TIN coated

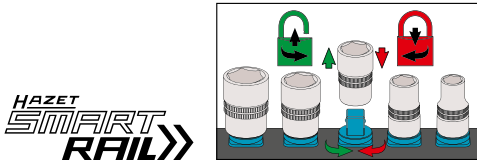

8501 • • 1/4"
3 • 4 • 5 • 6

8502 • • 1/4"
T20 • T25 • T30

HAZET No.	l mm		EAN-No. 4000896+
8500-SR/7	245	7	250738

8502LGTH 1/4" Screwdriver socket · TORX®

Made in Germany



• With knurling

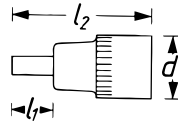

HAZET No.	s	l ₁ mm	l ₂ mm	d mm	EAN-No. 4000896+
8502LG-T30H	T30H	194	213	12	246076

• Long, thin blade for areas with difficult access – it is not necessary to combine different tools

8503 1/4" Screwdriver socket

Made in Germany



- With knurling
- Surface: TIN coated
- Tip according to ISO 2380-1

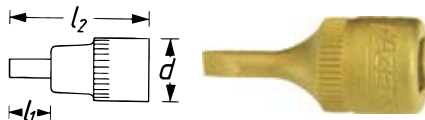

HAZET No.	l ₁ mm	l ₂ mm	d mm	EAN-No. 4000896+
8503-0.6 x 3.5	16	28	12	037162
8503-0.8 x 4	16	28	12	037186
8503-1 x 5.5	16	28	12	037247
8503-1.2 x 8	16	28	12	037209
8503-1.6 x 10	16	28	12	037223

8506 1/4" Screwdriver socket

Made in Germany



- With knurling
- Surface: TIN coated
- Tip according to ISO 8764-1

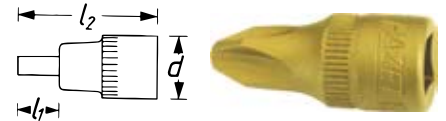

HAZET No.	s	l ₁ mm	l ₂ mm	d mm	EAN-No. 4000896+
8506-PH 1	PH1	16	28	12	037285
8506-PH 2	PH2	16	28	12	037308
8506-PH 3	PH3	16	28	12	037322
8506-PH 4	PH4	16	28	12	037346

8507 1/4" Screwdriver socket

Made in Germany



- With knurling
- Surface: TIN coated
- Tip according to ISO 8764-1

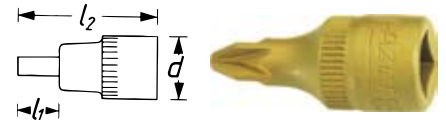

HAZET No.	s	l ₁ mm	l ₂ mm	d mm	EAN-No. 4000896+
8507-PZ 1	PZ1	16	28	12	037360
8507-PZ 2	PZ2	16	28	12	037377
8507-PZ 3	PZ3	16	28	12	037384

858 1/4" → 3/8" Adapter

Made in Germany

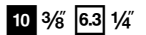

- With locking ball
- Surface: chrome-plated
- DIN 3123, ISO 3316



HAZET No.	l mm	EAN-No. 4000896+
858-1	26.5	038480

• Amplifier input 6.3 = 1/4" → output 10 = 3/8"

2250 Adapter

Made in Germany

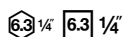

- Inside square and inside hexagon sockets
- With locking spring to securely hold the bits
- Surface: chrome-plated



HAZET No.	l mm	EAN-No. 4000896+
2250-1	23.5	015443

• 6.3 = 1/4" → 6.3 = 1/4"



Hand tools

6.3 1/4" Range of sockets



869 1/4"→1/4" Universal joint

Made in Germany

- With hinge – for working in areas with restricted access and for getting around obstructive edges
- With locking ball
- Surface: chrome-plated
- DIN 3123, ISO 3316

6.3 1/4" 6.3 1/4"



HAZET No.	l mm	EAN-No. 4000896+
869	36.5	038824

867 1/4"→1/4" Extension

Made in Germany

- With locking ball
- Surface: chrome-plated, polished
- DIN 3123, ISO 3316

6.3 1/4" 6.3 1/4"



HAZET No.	l mm	EAN-No. 4000896+
867-1	25	038732
867-2	55	038749
867-4	101.5	038770

868 1/4"→1/4" Extension

Made in Germany

- With locking ball
- Surface: chrome-plated, polished
- DIN 3123, ISO 3316

6.3 1/4" 6.3 1/4"



¹⁾ Length not according to DIN/ISO

HAZET No.	l mm	EAN-No. 4000896+
868	147	038794
868-16 ¹⁾	402	076727

871 1/4"→1/4" Wobble extension

Made in Germany

- Spherical, conical outside square
- Swivel angle to each side 8°
- By attaching a socket until its end stop is reached, the wobble extension may also be used as a rigid connection
- With locking ball
- Surface: chrome-plated, polished

6.3 1/4" 6.3 1/4"

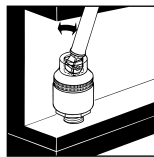

HAZET No.	l mm	EAN-No. 4000896+
871-1	25	038855
871-4	101.5	038879

870 1/4"→1/4" Extension · flexible

Made in Germany

- Flexible shaft enables operation around troublesome edges and fast working even in areas with restricted access
- With locking ball

6.3 1/4" 6.3 1/4"



HAZET No.	l mm	EAN-No. 4000896+
870	150	038848

8508 S 1/4" Impact adapter

Made in Germany

- ISO 1173-A 5.5
- Holds power screwdriver sockets with □ drive 6.3 = 1/4"
- Use in power screwdrivers, e.g. AEG, Bosch, Metabo
- With locking pin retaining
- DIN 3121, ISO 1173 A5,5

6.3 1/4" 6.3 1/4"



HAZET No.	l mm	EAN-No. 4000896+
8508 S-1	50	037391

8508 S 1/4"→1/4" Impact adapter

Made in Germany

- ISO 1173-E 6.3 (1/4")
- With locking pin retaining
- DIN 3121, ISO 1173 E6,3 (1/4")

6.3 1/4" 6.3 1/4"



HAZET No.	l mm	EAN-No. 4000896+
8508 S-3	50	037414
8508 S-4	100	037421





10 3/8 Range of sockets

880 Socket set

Made in Germany

- Plastic box 165-L (1/3)
- Safety-Insert-System, 2-component soft foam insert. Insert also suitable for HAZET Assistant



1/3				
-----	--	--	--	--



880 • 10 3/8 • E
10 • 11 • 12 • 13
14 • 15 • 16 • 17
18 • 19 • 21 • 22

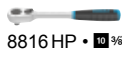

8816 HP • 10 3/8

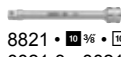

8821 • 10 3/8 • E
8821-3 • 8821-6 • 8821-10



8820 • 10 3/8 • E

HAZET No.	L x W x H mm		EAN-No. 4000896+
880/17	355x235x65	17	168361

880 N Socket set

Made in Germany

- Plastic box 165-L (1/3)
- Safety-Insert-System, 2-component soft foam insert. Insert also suitable for HAZET Assistant



1/3				
-----	--	--	--	--



880 • 10 3/8 • E
8 • 10 • 11 • 12 • 13 • 14
15 • 17 • 19 • 21 • 22

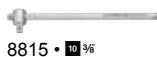

8815 • 10 3/8



8820 • 10 3/8 • E

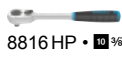

8816 HP • 10 3/8

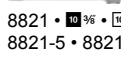

8821 • 10 3/8 • E
8821-5 • 8821-10

HAZET No.	L x W x H mm		EAN-No. 4000896+
880 N-1	355x235x65	16	040926

880 Socket set

Made in Germany

- Plastic box 165-L (1/3)
- Safety-Insert-System, 2-component soft foam insert. Insert also suitable for HAZET Assistant



1/3				
-----	--	--	--	--



880 • 10 3/8 • E
6 • 7 • 8 • 9 • 10
11 • 12 • 13 • 14 • 15
16 • 17 • 18 • 19 • 20
21 • 22

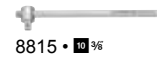

8815 • 10 3/8



8820 • 10 3/8 • E

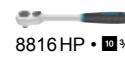

8816 HP • 10 3/8

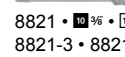

8821 • 10 3/8 • E
8821-3 • 8821-6

HAZET No.	L x W x H mm		EAN-No. 4000896+
880-2	355x235x65	22	039036

882 Socket set

Made in Germany

- Combination set with 6.3 = 1/4" and 10 = 3/8" sockets and bits 6.3 = 1/4"



10 3/8 6.3 1/4 6.3 1/4 E

- Plastic box 165-L (1/3)
- Safety-Insert-System, 2-component soft foam insert. Insert also suitable for HAZET Assistant



1/3				
-----	--	--	--	--



850 • 10 3/8 • E
4 • 4.5 • 5 • 5.5
6 • 7 • 8 • 9
10 • 11 • 12 • 13



863 HP • 10 3/8



866 U • 10 3/8



867-4 • 6.3 1/4 • 6.3 1/4



869 • 6.3 1/4 • 6.3 1/4



880 • 10 3/8 • E
10 • 11 • 12 • 13
14 • 15 • 16 • 17
18 • 19 • 21 • 22



2204 N • 10 3/8 • E
3 • 4 • 5 • 6 • 8



2208 N • 10 3/8 • E
0.5x4 • 0.6x4.5
0.8x5.5 • 1x6



2215 N • 10 3/8 • E
PH 1 • PH 2



2216 N • 10 3/8 • E
PZ 1 • PZ 2



2250-1 • 10 3/8 • E
2250-2 • 10 3/8 • E



8816 HP • 10 3/8



8820 • 10 3/8 • E



8821-6 • 10 3/8 • E

HAZET No.	L x W x H mm		EAN-No. 4000896+
882	355x235x65	46	042289



Hand tools

10 3/8" Range of sockets



882 Socket set

Made in Germany

- Plastic box 165-L (1/3)
- Safety-Insert-System, 2-component soft foam insert. Insert also suitable for HAZET Assistant



1/3			
-----	--	--	--



850 • • 1/4
6 • 7 • 8 • 9 • 10 • 13

850 E • • 1/4
E6 • E7 • E8 • E10

863 HP • 1/4

866 U • 1/4

867-4 • 1/4 • 1/4

869 • 1/4 • 1/4

880 • • 3/8
11 • 12 • 13 • 14 • 15 • 16
17 • 18 • 19 • 21 • 22

880 E • • 3/8
E11 • E12 • E14

8816 HP • 3/8

8820 • 3/8 • 3/8

8821-6 • 3/8 • 3/8

2204 N • • 1/4
4 • 5 • 6 • 8

2223 N • • 1/4
T10 • T15 • T20 • T25
T27 • T30 • T40

2224 • • 1/4
T45 • T50

2250-1 • 1/4 • 1/4
2250-3 • 1/4 • 3/8

HAZET No.	L x W x H mm		EAN-No. 4000896+
882-1	355x235x65	46	100361

885 N Socket set

Made in Germany

- Screwdriver sockets, CVD-Titanium Nitride (TIN) coated
- Plastic box 165-L (1/3)
- Safety-Insert-System, 2-component soft foam insert. Insert also suitable for HAZET Assistant



1/3			
-----	--	--	--



880 • • 3/8
6 • 7 • 8 • 9 • 10 • 11
12 • 13 • 14 • 15 • 16 • 17
18 • 19 • 21 • 22

8801 • • 3/8
4 • 5 • 6 • 8

8803 • • 3/8
1 x 5.5 • 1.2 x 8 • 1.6 x 10

8806 • • 3/8
PH1 • PH2 • PH3

8815 • 3/8

8816 HP • 3/8

8820 • 3/8 • 3/8

8821 • 3/8 • 3/8
8821-3 • 8821-5 • 8821-10

HAZET No.	L x W x H mm		EAN-No. 4000896+
885 N	355x235x65	32	042593

880 ZN Socket set

Made in Germany

- 12-point sockets
- Plastic box 165-L (1/3)
- Safety-Insert-System, 2-component soft foam insert. Insert also suitable for HAZET Assistant



1/3			
-----	--	--	--



880 • • 3/8
8

880 Z • • 3/8
10 • 11 • 12 • 13 • 14
15 • 17 • 19 • 21 • 22

8815 • 3/8

8816 HP • 3/8

8820 • 3/8 • 3/8

8821 • 3/8 • 3/8
8821-5 • 8821-10

HAZET No.	L x W x H mm		EAN-No. 4000896+
880 ZN-1	355x235x65	16	041992

888 ZN Socket set

Made in Germany

- 12-point sockets
- Screwdriver sockets, CVD titanium nitride (TIN) coated
- Sheet metal box (HAZET blue)
- 2-component soft foam insert



880 • • 3/8
6 • 7 • 8

880 Z • • 3/8
9 • 10 • 11 • 12 • 13
14 • 15 • 16 • 17 • 18
19 • 20 • 21 • 22

880 TZ • • 3/8
9 • 10 • 11 • 12 • 13
14 • 15 • 16 • 17 • 18
19 • 20 • 21 • 22

8801 • • 3/8
3 • 4 • 5 • 6 • 7
8 • 9 • 10 • 12

8803 • • 3/8
1 x 5.5 • 1.2 x 8 • 1.6 x 10

8806 • • 3/8
PH2 • PH3 • PH4

8812 U • 3/8
8814 • 3/8

8815 • 3/8

8816 HP • 3/8

8820 • 3/8 • 3/8

8821 • 3/8 • 3/8
8821-3 • 8821-6
8821-8 • 8821-12

8830 • 3/8 • 3/8
8858-2 • 1/4 • 3/8

HAZET No.	L x W x H mm		EAN-No. 4000896+
888 ZN	578x235x88	58	042654



880 LG Socket set

Made in Germany

- Easy installation: 2 bore holes, e.g. for wall fixation
- Holding clamps adapted to the drive size
- Surface: chrome-plated, polished



HAZET No.	l mm		EAN-No. 4000896+
• 10 6-point sockets • Long design 880 LG • •	10 • 11 • 12 • 13 • 14 • 15 • 16 • 17 • 18 • 19		
880 LG/10 H	240	10	040865
• 10 12-point sockets 880 TZ • •	10 • 11 • 12 • 13 • 14 • 15 • 16 • 17 • 18 • 19		
880 TZ/10 H	240	10	041831
• 10 6-point universal joint sockets 880 G • •	10 • 11 • 12 • 13 • 14 • 15 • 16 • 17 • 18 • 19		
880 G/10 H	240	10	040612
• 8 screwdriver sockets for inside hexagon screws 8801 • •	3 • 4 • 5 • 6 • 7 • 8 • 9 • 10		
8801/8 H	240	8	039463
8802 T • •	T 15 • T 20 • T 25 • T 27 • T 30 • T 40 • T 45 • T 50		
8802 T/8 H	240	8	039784
• Empty, with 16 retaining clamps • Suitable for sockets 880 880 •			
880 HL	430	-	040650

8816 3/8" Reversible ratchet

Made in Germany

- Number of teeth: 30 (Opening angle 12°)
- With locking ball
- HAZET 2-component handle
- Surface: chrome-plated, polished
- DIN 3122, ISO 3315

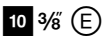

HAZET No.	l mm	EAN-No. 4000896+
8816 P	199	042203

8816 3/8" Reversible ratchet · with hinge

Made in Germany

- Ratchet head can be swivelled > 180°
- Short design
- Number of teeth: 30 (Opening angle 12°)
- With hinge – for working in areas with restricted access and for getting around obstructive edges
- With locking ball
- HAZET 2-component handle
- Surface: chrome-plated, polished
- DIN 3122, ISO 3315



¹⁾ Length non-standard

HAZET No.	l mm	EAN-No. 4000896+
8816 GK ¹⁾	218	042142

8816 3/8" Reversible ratchet · with hinge

Made in Germany

- Ratchet head can be swivelled > 180°
- Long design
- Number of teeth: 30 (Opening angle 12°)
- With hinge – for working in areas with restricted access and for getting around obstructive edges
- With locking ball
- HAZET 2-component handle
- Surface: chrome-plated, polished
- DIN 3122, ISO 3315

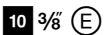

¹⁾ Length non-standard

HAZET No.	l mm	EAN-No. 4000896+
8816 G ¹⁾	276	042104



Hand tools

10 3/8" Range of sockets



8816 3/8" Reversible ratchet · fine-tooth

Made in Germany

10 3/8" (E)

- A lot more power than with ratchets with the same dimensions
- Locking function of the lever prevents unwanted switching
- Increased service life thanks to the use of state-of-the-art lubricants in the ratchet mechanism
- Strict production tolerances prevent dirt from getting in
- HAZET internal quality standards guarantee loading capacity far beyond the standard requirements
- High-quality, easy to clean, corrosion-resistant
- Integrated suspension option in the handle
- VPA tested, static torque according to DIN 3122: 400 Nm (DIN 202 Nm)
- Number of teeth: 90 (Opening angle 4°)
- With locking ball
- HAZET 2-component handle
- Surface: chrome-plated
- DIN 3122, ISO 3315



YouTube Clip

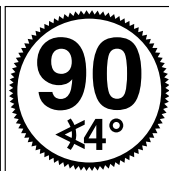
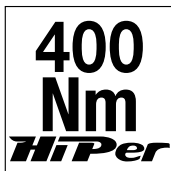

HAZET No.	l mm	EAN-No. 4000896+
8816 HP	200	235063

Made in Germany

10 3/8" (E)

- A lot more power than with ratchets of the same dimensions
- Latching function of the shift lever provides protection against unwanted switching
- Increased service life thanks to the use of state-of-the-art lubricants in the ratchet mechanism
- Strict production tolerances prevent dirt from getting in
- HAZET internal quality standards guarantee loading capacity far beyond the standard requirements
- High-quality, easy to clean, corrosion-resistant
- Integrated suspension option in the handle
- VPA tested, static torque according to DIN 3122: 340 Nm (DIN 202 Nm)
- Quick-release safety lock
- Sockets are securely locked in place
- Attached tools can easily be released by pressing the button with just one hand
- Number of teeth: 90 (Opening angle 4°)
- With locking ball
- HAZET 2-component handle
- Surface: chrome-plated
- DIN 3122, ISO 3315

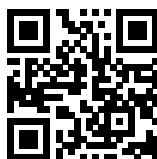

YouTube Clip

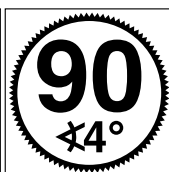

HAZET No.	l mm	EAN-No. 4000896+
8816 HPS	200	237241

Wear? – No problem!

- HAZET tools are manufactured to the highest quality. During long intensive loading there is a certain level of wear even for high-quality tools.
- For this reason, there are spare parts and replacement sets available for many of our tools.



Please also see our spare parts shop
www.hazet.de/ersatzteil-shop

Cost-saving – Sustainable – Resource-saving!
For long-term pleasure with your HAZET tools

8816 Replacement set

Made in Germany

(E)

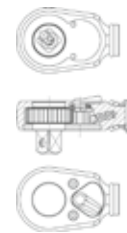

HAZET No.	EAN-No. 4000896+
<ul style="list-style-type: none"> • Replacement set for ratchet wheel 10 = 3/8" ■ consisting of: pawl · compression spring · ball · spring sleeve · shift lever · cover disc · circlip · ratchet wheel · grease · assembly tool For reversible ratchet 8816HP 	
8816HP/11	239221
<ul style="list-style-type: none"> • Replacement set for ratchet wheel with safety lock 10 = 3/8" ■ consisting of: assembly tool · cover plate · ratchet wheel with safety lock · circlip · cover disc · shift lever · spring sleeve · ball · compression spring · pawl · grease For HAZET reversible ratchet 8816HPS as well as for retrofitting HAZET reversible ratchet 8816HP (reduction to maximum 340Nm peak load) 	
8816HPS/11	241248
<ul style="list-style-type: none"> • Replacement set for shift lever consisting of: shift lever · screws · ball · compression spring · pawl For HAZET reversible ratchet 8816G · 8816GK · 8816P · 8816S · 8816ST · 916K · 2264-1 For HAZET torque wrench 5110-2CT · 5120-2CT · 5110-3CT · 5111-3CT · 5120-3CT · 6110CT · 6110-1CT · 6111-1CT · 6114-1CT · 6115-1CT · 6402-1 · 6402-1S · 6408-1 	
8816P/6	144617
<ul style="list-style-type: none"> • Replacement set for ratchet wheel 10 = 3/8" ■ consisting of: ratchet wheel · pawl · shift lever · screws · ball · compression spring For HAZET reversible ratchet 8816G · 8816GK · 8816P · 8816ST For HAZET torque wrench 5110-2CT · 5110-3CT · 5111-3CT · 6110CT · 6110-1CT · 6111-1CT · 6114-1CT · 6115-1CT · 6402-1 	
8816P/7N	042234
<ul style="list-style-type: none"> • Replacement set for ratchet wheel with safety lock 10 = 3/8" ■ consisting of: Ratchet wheel with safety lock · pawl · shift lever · screws · ball · compression spring For HAZET reversible ratchets 8816S · 6402-1S as well as for retrofitting HAZET reversible ratchets 8816P · 8816G · 8816GK · 8816ST · 6110CT · 6110-1CT · 6111-1CT · 6114-1CT · 6115-1CT · 6402-1 	
8816S/7	048465
<ul style="list-style-type: none"> • Plastic handle For HAZET 8814 · 8816P · 8816F · 8816G · 8816GK · 2593Lg-17 	
8816KG-02	042166
<ul style="list-style-type: none"> • Replacement set for hinge connection consisting of: screw and lock washer For HAZET flexible handle 8814 and HAZET reversible ratchet 8816G · 8816GK 	
8816G-013	042111



8814 3/8" Flexible handle

Made in Germany

10 3/8" E

- With hinge – for working in areas with restricted access and for getting around obstructive edges
- With locking ball
- Ergonomically shaped HAZET 2-component handle
- Surface: chrome-plated
- DIN 3122, ISO 3315



HAZET No.	l mm	EAN-No. 4000896+
8814	250	042036

8812 U 3/8" Spin type speeder

Made in Germany

10 3/8"

- With locking ball
- HAZET 2-component handle
- Surface: chrome-plated



HAZET No.	l mm	EAN-No. 4000896+
8812U	137	067688

8815 3/8" Sliding T-handle

Made in Germany

10 3/8"

- With locking ball
- Surface: chrome-plated, polished
- DIN 3122, ISO 3315



HAZET No.	l mm	EAN-No. 4000896+
8815	198	042067

880 3/8" Socket · hexagon

Made in Germany

10 3/8"

- With knurling
- Surface: chrome-plated, polished
- DIN 3124, ISO 2725-1

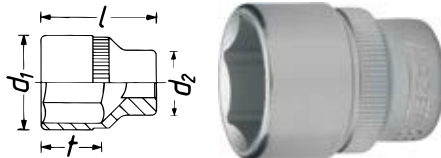

¹⁾ Not according to DIN

HAZET No.	l mm	d ₁ mm	d ₂ mm	f mm	EAN-No. 4000896+
880-6 ¹⁾	24	10	17	6.2	039104
880-7	24	10.5	17	6.2	039111
880-8	24	11.8	17	6.2	039128
880-9	24	13	17	6.2	039135
880-10	25	14.4	17	7.2	038893
880-11	26	15.8	17.5	8.2	038916
880-12	27	17	18.5	9.2	038923
880-13	27.5	18.4	17	9.7	038930
880-14	29.5	19.5	17.5	11.7	038947
880-15	29.5	20.9	18	11.7	038954
880-16	29.5	22.1	18	11.7	038961
880-17	29.5	23.3	18.5	11.7	038978
880-18	31.5	24.8	19	13.5	038992
880-19	31.5	25.8	19.5	13.5	039005
880-20	31.5	26.8	21	13.5	039043
880-21	31.5	28.3	22.5	13	039050
880-22	34	29.6	23.5	16	039067

880 LG 3/8" Socket · hexagon

Made in Germany

10 3/8"

- Long design
- With knurling
- Surface: chrome-plated, polished
- DIN 3124, ISO 2725-1



HAZET No.	l mm	d ₁ mm	d ₂ mm	f mm	EAN-No. 4000896+
880 LG- 8	54	12.1	17	7	052257
880 LG- 9	54	13	17	10	040858
880 LG-10	54	14.4	17	10	040698
880 LG-11	54	15.8	17.2	11	040704
880 LG-12	54	17	18.5	11	040711
880 LG-13	54	18.4	18.5	12	040728
880 LG-14	54	19.5	19.5	15	040759
880 LG-15	60	20.8	19.5	15	040766
880 LG-16	60	21.8	18.5	16	040773
880 LG-17	60	23	18.5	16	040780
880 LG-18	66	24.4	20	20	040797
880 LG-19	66	25.5	20	20	040803
880 LG-20	70	26.6	21	22	040810
880 LG-21	70	28	22	22	040834
880 LG-22	70	29.6	21	22	040841

880 Z 3/8" Socket · 12-point

Made in Germany

10 3/8"

- With knurling
- Surface: chrome-plated, polished
- DIN 3124, ISO 2725-1

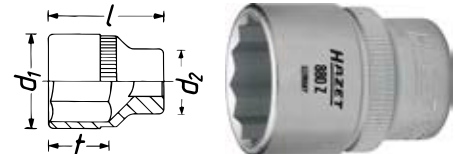

HAZET No.	l mm	d ₁ mm	d ₂ mm	f mm	EAN-No. 4000896+
880 Z- 9	24	13	17	6.2	041985
880 Z-10	25	14.4	17	7.2	041848
880 Z-11	26	15.8	17.5	8.2	041855
880 Z-12	27	17	18.5	9.2	041862
880 Z-13	27.5	18.4	17	9.7	041879
880 Z-14	29.5	19.6	17.5	11.7	041893
880 Z-15	29.5	20.9	18	11.7	041909
880 Z-16	29.5	22.1	18	11.7	041916
880 Z-17	29.5	23.3	18.5	11.7	041923
880 Z-18	31.5	24.6	19	13.5	041930
880 Z-19	31.5	25.8	19.5	13.5	041947
880 Z-20	31.5	26.8	20	13.5	041954
880 Z-21	31.5	28.3	22.5	13	041961
880 Z-22	34	29.6	23.5	15.5	041978





Hand tools

10 3/8" Range of sockets



880 A 3/8" Socket · 12-point

- Made in Germany
- American dimensions
- With knurling
- Surface: chrome-plated, polished

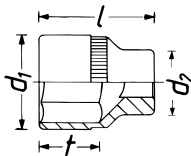
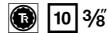

1) With 6-point

HAZET No.	l mm	d ₁ mm	d ₂ mm	EAN-No. 4000896+
880 A-1/4 ¹⁾	24	10	17	040056
880 A-5/16 ¹⁾	24	11.8	17	040094
880 AZ-3/8	25	13.8	17	040360
880 AZ-7/16	26	15.8	17.5	040384
880 AZ-1/2	27.5	18.7	17	040292
880 AZ-9/16	29.5	20.1	17.5	040407
880 AZ-19/32	29.5	21.1	18	040339
880 AZ-5/8	29.5	22.1	18	040377
880 AZ-11/16	29.5	23.8	18.5	040308
880 AZ-3/4	31.5	25.8	19.5	040353
880 AZ-25/32	31.5	26.8	21	040346
880 AZ-13/16	32	28.3	22.5	040315
880 AZ-7/8	34	30.3	23.5	040391
880 AZ-15/16	36.5	32.3	23.5	040322

880 TZ 3/8" Socket · 12-point

- Made in Germany
- Long design
- With knurling
- Surface: chrome-plated, polished
- DIN 3124, ISO 2725-1

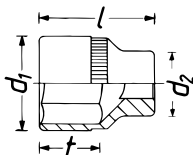
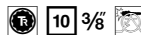

HAZET No.	l mm	d ₁ mm	d ₂ mm	t mm	EAN-No. 4000896+
880 TZ- 9	54	13	17	10	041824
880 TZ-10	54	14.4	17	10	041602
880 TZ-11	54	15.8	17.2	11	041626
880 TZ-12	54	17	18.5	12.3	041633
880 TZ-13	54	18.4	18.5	12	041664
880 TZ-14	54	19.5	19.5	15	041688
880 TZ-15	60	20.8	19.5	15	041701
880 TZ-16	60	21.8	18.5	16	041718
880 TZ-17	60	23	18.5	16	041725
880 TZ-18	66	24.4	20	20	041749
880 TZ-19	66	25.5	20	20	041756
880 TZ-20	70	26.6	21	22	041763
880 TZ-21	70	28	22	22	041794
880 TZ-22	70	29.6	21	22	041800

880 G 3/8" Universal joint socket · hexagon

- Made in Germany
- With hinge – for working in areas with restricted access and for getting around obstructive edges
- Surface: chrome-plated, polished

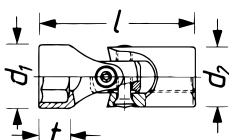
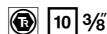

880 G 3/8" Universal joint socket · hexagon

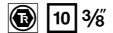

HAZET No.	l mm	d ₁ mm	d ₂ mm	t mm	EAN-No. 4000896+
880 G-10	43	13.8	19	6.8	040414
880 G-11	43	15	19	6.8	040438
880 G-12	44	16.6	19	7.3	040445
880 G-13	44	17.8	19	7.3	040452
880 G-14	45	19	19	9.3	040469
880 G-15	45	20.4	19	9.3	040476
880 G-16	46	22	19	9.2	040483
880 G-17	46	22.8	19	9.2	040490
880 G-18	47	24.5	19	10.2	040506
880 G-19	48	25.2	19	11.2	040513

880 GZ 3/8" Universal joint socket · 12-point

- Made in Germany
- With hinge – for working in areas with restricted access and for getting around obstructive edges
- With locking ball
- Surface: chrome-plated, polished

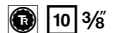

YouTube Clip

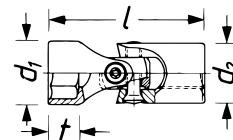

HAZET No.	l mm	d ₁ mm	d ₂ mm	t mm	EAN-No. 4000896+
880 G-Z 16	45.8	22	19	10	203734
880 G-Z 18	46.8	24.5	19	11	203529

848 Z Box-end wrench · 12-point · open

- Made in Germany
- Crowfoot Wrenches
- For union nuts and tube connections
- Square socket

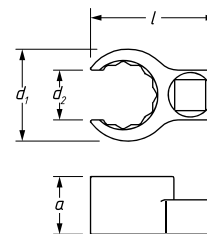
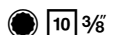

HAZET No.	l mm	d ₁ mm	d ₂ mm	a mm	mm	EAN-No. 4000896+
848 Z-17	40.9	27.5	14.5	18	□ 10 = 3/8"	079094
848 Z-18	41.7	29	15	19	□ 10 = 3/8"	079100
848 Z-19	41.9	30	16	19	□ 10 = 3/8"	079117
848 Z-21	46	32	16.5	19	□ 10 = 3/8"	079124
848 Z-22	46.5	33.5	17.5	19.5	□ 10 = 3/8"	079131
848 Z-24	50	36.5	18.5	20	□ 10 = 3/8"	079148
848 Z-27	53.7	40.5	20.5	22	□ 10 = 3/8"	079162
848 Z-30	62.4	46.5	25	23	□ 12.5 = 1/2"	079179
848 Z-32	63.7	48.5	24.5	23	□ 12.5 = 1/2"	079186
848 Z-36	67.1	52.5	27.5	24.5	□ 12.5 = 1/2"	079193
848 Z-41	74.1	58.5	31	24.5	□ 12.5 = 1/2"	079216
848 Z-46	77.7	64.5	35.5	26.5	□ 12.5 = 1/2"	079223



960 MGT Magnetic insert · for sockets

- Universal application in metric 6-point and 12-point sockets s 10 to 19 mm
- Sockets made of plastic with integrated magnet
- Powerful retention force
- Reusable
- 10-piece set, for metric sockets s 10 · 11 · 12 · 13 · 14 · 15 · 16 · 17 · 18 · 19 mm

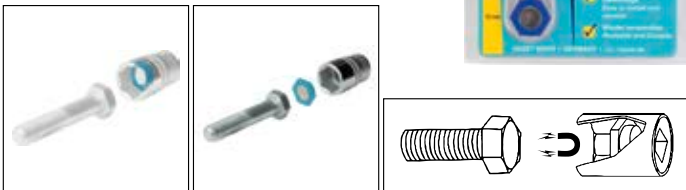

HAZET No.	EAN-No. 4000896+
960 MGT	097661

880 MGT 3/8" Spark plug socket

- **Made in Germany**
- With permanent magnet
- Long design
- American dimensions
- Surface: chrome-plated, polished

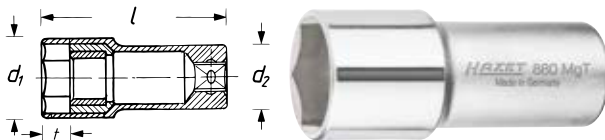

HAZET No.	S mm	S" $\frac{1}{16}$	l mm	d ₁ mm	d ₂ mm	t mm	EAN-No. 4000896+
880 MGT	20.8	$\frac{13}{16}$	64	27.4	22.5	9	040872
880 A MGT	16	$\frac{5}{8}$	64	21.6	21.6	9	040247

880 MGT 3/8" Spark plug socket

- **Made in Germany**
- With permanent magnet
- Outside hexagon: 17 mm
- For motorcycles, e.g. HONDA · YAMAHA · SUZUKI · KAWASAKI etc.
- Long design
- Surface: chrome-plated, polished

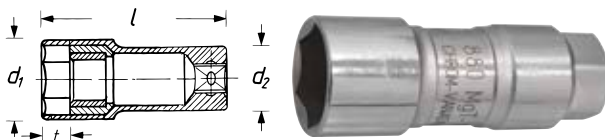

HAZET No.	S mm	l mm	d ₁ mm	d ₂ mm	t mm	EAN-No. 4000896+
880 MGT-18	18	62	23.5	22.8	9.6	040889

880 KF 3/8" Spark plug socket

- **Made in Germany**
- The fixing clamp reduces the risk of insulator damage
- Fixing clamp to hold the spark plug
- Long design
- American dimensions
- Surface: chrome-plated, polished

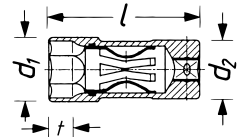

HAZET No.	S mm	S" $\frac{1}{16}$	l mm	d ₁ mm	d ₂ mm	t mm	EAN-No. 4000896+
880 KF	20.8	$\frac{13}{16}$	64	27.4	25	10	040674
880 A KF	16	$\frac{5}{8}$	64	21.6	21.6	10	040131

HAZET No.	S mm	S" $\frac{1}{16}$	l mm	d ₁ mm	d ₂ mm	t mm	EAN-No. 4000896+
4766	16	$\frac{5}{8}$	97	21.4	18	10	049295
4766-1	16	$\frac{5}{8}$	270	21.4	18	10	048991
4766-2	14		64	18	17.3	10	087655
4766-3	14		154	19.1	18	10	199976

880 KF Fixing clamp

- **Made in Germany**
- American dimensions



HAZET No.	EAN-No. 4000896+
• Fixing clamp for HAZET spark plug wrench 880KF · 900KF · 4767KF	
880 KF-01	050123
• Fixing clamp for HAZET spark plug wrench 880A KF · 900A KF · 4766 · 4766-1 · 4767A KF	
880 A KF-01	050130

Fixing clamp information

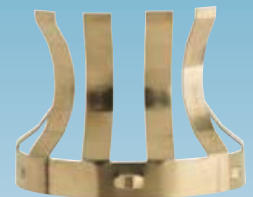
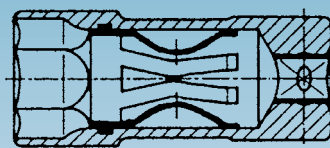

- Stainless and insensitive to heat
- Largest possible clearance of insulator
- 6 spring elements – firm hold of the spark plug
- Damping of transverse motion



Hand tools

10 3/8" Range of sockets



880 E 3/8" Socket · TORX®

Made in Germany

- With knurling
- Surface: chrome-plated, polished

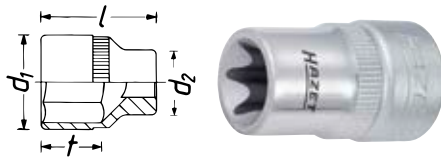
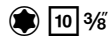

HAZET No.	s	l mm	d ₁ mm	d ₂ mm	mm	EAN-No. 4000896+
880-E 5	E5	28	7	17	4.75	039258
880-E 6	E6	28	8	17	5.74	039272
880-E 7	E7	28	9	17	6.22	039296
880-E 8	E8	28	10.5	17	7.52	039319
880-E 10	E10	28	13	17	9.42	039159
880-E 11	E11	28	14	17	10.08	039180
880-E 12	E12	28	14.9	17	11.17	039197
880-E 14	E14	28	16.5	18.5	12.90	039227

880 LG-E 3/8" Socket · TORX®

Made in Germany

- Long design
- Surface: chrome-plated, polished

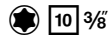

HAZET No.	s	l mm	d ₁ mm	d ₂ mm	mm	EAN-No. 4000896+
880 LG-E 8	E8	65	10.5	17	7.52	053070
880 LG-E 10	E10	65	13	17	9.42	053087
880 LG-E 12	E12	65	14.9	17	11.17	053100
880 LG-E 14	E14	65	16.5	18.5	12.90	053117

880 G-E 3/8" Socket · TORX®

Made in Germany

- With hinge – for working in areas with restricted access and for getting around obstructive edges
- Surface: chrome-plated, polished

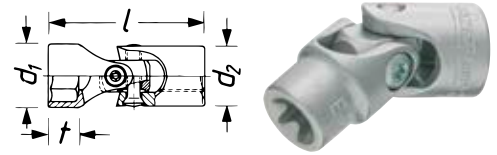
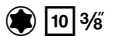

HAZET No.	s	l mm	d ₁ mm	d ₂ mm	mm	EAN-No. 4000896+
880 G-E 8	E8	43	11.5	19	7.52	040599
880 G-E 10	E10	44	13.8	19	9.42	040537
880 G-E 12	E12	46	16	19	11.17	040551
880 G-E 14	E14	48	17.8	19	12.90	040575

880 G-E Socket set · TORX®

Made in Germany

- With hinge – for working in areas with restricted access and for getting around obstructive edges
- Surface: chrome-plated, polished

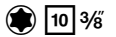

880 G-E • 10 3/8"
E8 • E10 • E12 • E14

HAZET No.	mm	EAN-No. 4000896+
880 G-E/4	4	040520

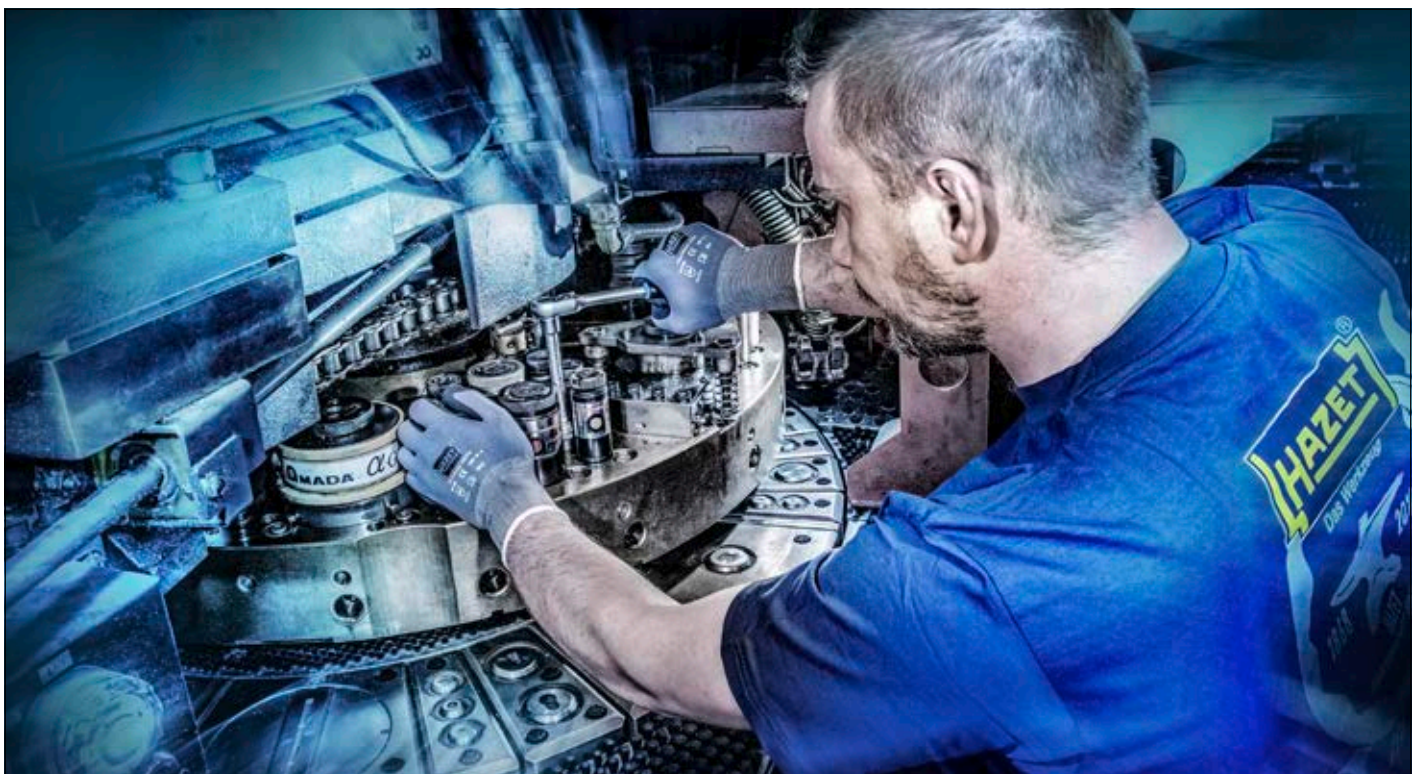



TiN coating

TiN

Why choose TiN (Titanium Nitride) coating?

- A special coating process for extremely hard TiN coating guarantees high adhesive strength and wear resistance of the coating
- Particularly suitable for continuous load, e. g. for industrial applications in industry and trade
- Higher wear protection guarantees a longer lifetime
- Perfect fitting accuracy due to optimum coating thickness
- Optimized corrosion protection

TiN coated screwdriver sockets

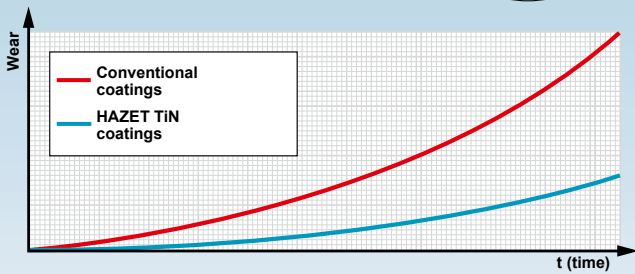
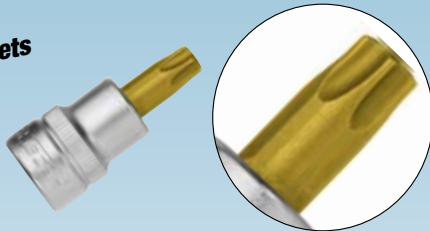

8801 K 3/8" Screwdriver socket

Made in Germany

- Extra short design
- With knurling
- Surface: TiN coated
- DIN 7422

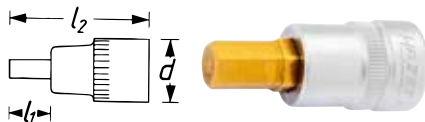
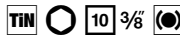

¹⁾ Not according to DIN

HAZET No.	S mm	l ₁ mm	l ₂ mm	d mm	EAN-No. 4000896+
8801 K- 3	3	17	43.5	17	053582
8801 K- 4 ¹⁾	4	17	43.5	17	053599
8801 K- 5	5	17	43.5	17	053605
8801 K- 6	6	17	43.5	17	053612
8801 K- 7	7	17	43.5	19	053629
8801 K- 8	8	17	43.5	19	053636
8801 K- 9 ¹⁾	9	17	43.5	19	053643
8801 K-10	10	17	43.5	19	053650

8801 3/8" Screwdriver socket

Made in Germany

- Short design
- With knurling
- Surface: TiN coated
- DIN 7422

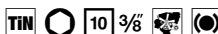

8801 3/8" Screwdriver socket

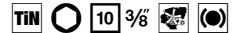

- ¹⁾ Not according to DIN
- ²⁾ With offset blade

HAZET No.	S mm	l ₁ mm	l ₂ mm	d mm	EAN-No. 4000896+
8801-3 ^{1) 2)}	3	23.5	50	17	039364
8801-4 ²⁾	4	28.5	55	17	039371
8801-5 ²⁾	5	33.5	60	17	039388
8801-6	6	38.5	65	17	039395
8801-7 ²⁾	7	43.5	70	19	039401
8801-8	8	48.5	75	19	039425
8801-9 ^{1) 2)}	9	52.5	80	19	039432
8801-10	10	57.5	85	19	039340
8801-11	11	60	87.5	19	166299
8801-12 ¹⁾	12	62.5	90	19	039357

HAZET No.	S mm	l ₁ mm	l ₂ mm	EAN-No. 4000896+
2584 LG-1 A	6	332	359	252817
2584-8	8	6.6	24	149438
2784-1	7	6.6	24	148530

8801 Screwdriver socket set

Made in Germany

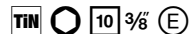

- Short design
- With knurling
- Plastic box 165-S (1/9)
- Safety-Insert-System, 2-component soft foam insert. Insert also suitable for HAZET Assistant
- Surface: TiN coated
- DIN 7422



1/9				
-----	--	--	--	--

8801 • O • 10 3/8
4 • 5 • 6 • 7 • 8 • 10

HAZET No.	L x W x H mm	□	EAN-No. 4000896+
8801/6	185x153x52	6	186853

8801 A 3/8" Screwdriver socket

Made in Germany



- Short design
- American dimensions
- With knurling
- Surface: TiN coated



¹⁾ With offset blade

HAZET No.	l ₁ mm	l ₂ mm	d mm	EAN-No. 4000896+
8801 A-1/8 ¹⁾	23.5	50	17	039487
8801 A-5/32 ¹⁾	28.5	55	17	039524
8801 A-3/16 ¹⁾	33.5	60	17	039494
8801 A-7/32 ¹⁾	38.5	65	17	039531
8801 A-1/4 ¹⁾	43.5	70	19	039470
8801 A-5/16	48.5	75	19	039517
8801 A-3/8 ¹⁾	52.5	80	19	039500



Hand tools

10 3/8" Range of sockets



8801 KK 3/8" Screwdriver socket

Made in Germany

- Long design
- With ball-head
- With knurling
- Surface: TIN coated

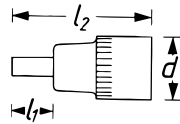

HAZET No.	S	l ₁ mm	l ₂ mm	d mm	EAN-No. 4000896+
8801 KK- 5	5	89.5	116	17	039586
8801 KK- 6	6	89.5	116	17	039593
8801 KK- 7	7	89.5	116	19	039609
8801 KK- 8	8	89.5	116	19	039616
8801 KK-10	10	88.5	116	19	039579

8802 3/8" Screwdriver socket · TORX®

Made in Germany

- Short design
- With knurling
- Surface: TIN coated

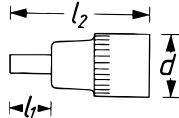
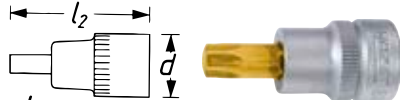

HAZET No.	S	l ₁ mm	l ₂ mm	d mm	mm	EAN-No. 4000896+
8802-T 15	T15	17	43.5	19	3.27	039647
8802-T 20	T20	17	43.5	19	3.86	039654
8802-T 25	T25	17	43.5	19	4.43	039661
8802-T 27	T27	17	43.5	19	4.99	039678
8802-T 30	T30	17	43.5	19	5.52	039685
8802-T 40	T40	17	43.5	19	6.65	039708
8802-T 45	T45	17	43.5	19	7.82	039722
8802-T 50	T50	17	44.5	19	8.83	039753

8803 3/8" Screwdriver socket

Made in Germany

- Medium length design
- With knurling
- Surface: TIN coated
- DIN ISO 2380-1

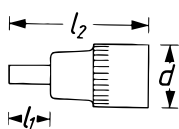

HAZET No.	l ₁ mm	l ₂ mm	d mm	EAN-No. 4000896+
8803-1 x 5.5	48.5	75	17	039814
8803-1.2 x 8	53.5	80	19	039791
8803-1.6 x 10	62.5	90	19	039807

8806 3/8" Screwdriver socket

Made in Germany

- Short design
- With knurling
- Surface: TIN coated
- Tip ISO 8764-1

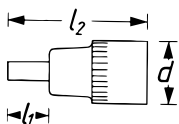
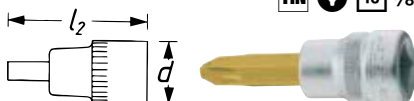

HAZET No.	S	l ₁ mm	l ₂ mm	d mm	EAN-No. 4000896+
8806-PH 1	PH1	23.5	50	17	039845
8806-PH 2	PH2	23.5	50	17	039852
8806-PH 3	PH3	28.5	55	19	039869
8806-PH 4	PH4	32.5	60	19	039876

8808 3/8" Screwdriver socket

Made in Germany

- Short design
- With knurling
- Surface: TIN coated
- DIN 2324, DIN 2325

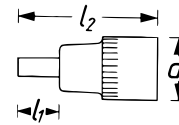
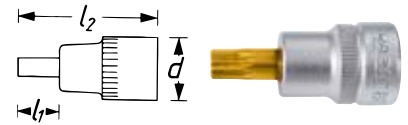

HAZET No.	S	l ₁ mm	l ₂ mm	d mm	EAN-No. 4000896+
8808- 5	M5	13.5	40	19	039982
8808- 6	M6	13.5	40	19	039999
8808- 8	M8	14.5	41	19	040001
8808-10	M10	14.5	42	19	039975

2250 Adapter

Made in Germany

- Inside square and inside hexagon sockets
- With locking spring to securely hold the bits
- Surface: chrome-plated



HAZET No.	l mm	EAN-No. 4000896+
• □ 10 = 3/8" → ○ 6.3 = 1/4"		
2250-2	30	015450
• □ 10 = 3/8" → ○ 8 = 5/16"		
2250-3	31	015474

8808 LG 3/8" Screwdriver socket

Made in Germany

- Long design
- With knurling
- Surface: TIN coated
- DIN 2324, DIN 2325

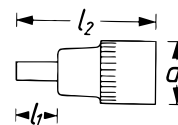

HAZET No.	S	l ₁ mm	l ₂ mm	d mm	EAN-No. 4000896+
8808 LG- 6	M6	62.3	89	19	204946
8808 LG- 8	M8	61.5	88	19	040025
8808 LG-10	M10	61.5	89	19	040018

8858 Adapter

Made in Germany

- With locking ball
- Surface: chrome-plated
- DIN 3123, ISO 3316



HAZET No.	l mm	EAN-No. 4000896+
• Amplifier □ input 10 = 3/8" → ■ output 12.5 = 1/2"		
8858-1	36	042562
• Reducer □ input 10 = 3/8" → ■ output 6.3 = 1/4"		
8858-2	26	042579



8820 3/8" → 3/8" Universal joint

Made in Germany

- With hinge – for working in areas with restricted access and for getting around obstructive edges
- With locking ball
- Surface: chrome-plated, head polished
- DIN 3123, ISO 3316

10 3/8" 10 3/8"



HAZET No.	l mm	EAN-No. 4000896+
8820	46.5	042296

8822 3/8" → 3/8" Wobble extension

Made in Germany

- Spherical, conical outside square
- Swivel angle to each side 8°

10 3/8" 10 3/8"

- By attaching a socket until its end stop is reached, the wobble extension may also be used as a rigid connection
- With locking ball
- Surface: chrome-plated, polished

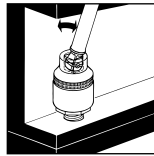

HAZET No.	l mm	EAN-No. 4000896+
8822- 1	36	042418
8822- 3	74	042432
8822-10	254	042425

8830 3/8" → 3/8" Extension · flexible

Made in Germany

- Flexible shaft enables operation around troublesome edges and fast working even in areas with restricted access
- With locking ball

10 3/8" 10 3/8"



HAZET No.	l mm	EAN-No. 4000896+
8830	210	042487

8821 3/8" → 3/8" Extension

Made in Germany

- With locking ball
- Surface: chrome-plated, head polished
- DIN 3123, ISO 3316

10 3/8" 10 3/8"



¹⁾ Length not according to DIN

HAZET No.	l mm	EAN-No. 4000896+
8821- 1 ¹⁾	36	042302
8821- 3	74	042357
8821- 5	126	042364
8821- 6 ¹⁾	150	042371
8821- 8 ¹⁾	202	042388
8821-10	254	042319
8821-12 ¹⁾	304	042326
8821-20 ¹⁾	508	042333
8821-28 ¹⁾	711	042340

880 SE 3/8" Impact socket · TORX®

Made in Germany

- With borehole for locking pin or safety spring and groove for O-ring
- Surface: phosphatized, oiled

10 3/8" E

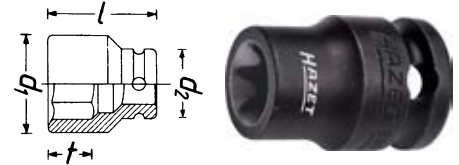

HAZET No.	s	l mm	d ₁ mm	d ₂ mm	mm	EAN-No. 4000896+
880 S-E 10	E10	28	14	19	9.42	041237
880 S-E 12	E12	28	15.9	19	11.17	041251

8807 S Impact adapter

Made in Germany

- Drive with borehole for locking pin retaining and groove for O-ring, output with locking pin retaining
- Surface: phosphatized, oiled

6.3 1/4" 12.5 1/2" 10 3/8" E



HAZET No.	l mm	d mm	EAN-No. 4000896+
• Reducer □ input 10 = 3/8" → ■ output 6.3 = 1/4"			
8807 S	28	22	039937
• Amplifier □ input 10 = 3/8" → ■ output 12.5 = 1/2"			
8807 S-1	35.5	22	039951

8808 S 5/16" → 3/8" Impact adapter

Made in Germany

- Fixation of power screwdriver sockets with □ drive 10 = 3/8"
- With locking pin retaining
- Surface: steel grey, oiled

10 3/8" 8 5/16"



HAZET No.	l mm	EAN-No. 4000896+
• Adapter ● 8 = 5/16" → ■ 10 = 3/8"		
8808 S-1	75	040032

880 S Safety spring

Made in Germany

- For machine-operated sockets in accordance with DIN 3129

10 3/8"



HAZET No.	mm	EAN-No. 4000896+
• Safety spring for sockets □ 10 = 3/8" 6 – 12 mm, E5 – E14		
880 S-HF 612	∅ 16.6x1.2	041428
• Safety spring for sockets □ 10 = 3/8" 13 – 19 mm, extensions · universal joints · adapters		
880 S-HF 1319	∅ 18.0x1.2	041411



Hand tools

125 1/2 Range of sockets



125 1/2 Range of sockets

900 Socket set

Made in Germany



- Plastic box 165-L (1/3)
- Safety-Insert-System, 2-component soft foam insert. Insert also suitable for HAZET Assistant



1/3			
-----	--	--	--



900 • 125 1/2
10 • 11 • 12 • 13 • 14
15 • 16 • 17 • 18 • 19
20 • 21 • 22 • 23 • 24
26 • 27 • 28 • 30 • 32



915 • 125 1/2



917-5 • 125 1/2 • 125 1/2



918-10 • 125 1/2 • 125 1/2

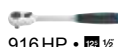

916 HP • 125 1/2



920 • 125 1/2 • 125 1/2

HAZET No.	L x W x H mm		EAN-No. 4000896+
900	355x235x65	25	042685

906 Socket set

Made in Germany



- Plastic box 165-L (1/3)
- Safety-Insert-System, 2-component soft foam insert. Insert also suitable for HAZET Assistant



1/3			
-----	--	--	--



900 • 125 1/2
10 • 11 • 12 • 13 • 14
15 • 17 • 19 • 22 • 24
27 • 30 • 32



915 • 125 1/2



917-5 • 125 1/2 • 125 1/2



916 HP • 125 1/2



918-10 • 125 1/2 • 125 1/2

HAZET No.	L x W x H mm		EAN-No. 4000896+
906	355x235x65	17	045891

953 HP Socket set

Made in Germany



- Plastic box 165-L (1/3)
- Safety-Insert-System, 2-component soft foam insert. Insert also suitable for HAZET Assistant



1/3			
-----	--	--	--



850 • 125 1/2 • 125 1/2
5 • 6 • 7 • 8 • 9
10 • 11 • 12 • 13



900 • 125 1/2
10 • 11 • 12 • 13 • 14
15 • 16 • 17 • 18 • 19
21 • 22 • 24 • 27



863 HP • 125 1/2

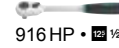

916 HP • 125 1/2

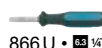

866 U • 125 1/2

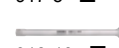

917-5 • 125 1/2 • 125 1/2

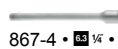

867-4 • 125 1/2 • 125 1/2



2204 N • 125 1/2 • 125 1/2
2 • 3 • 4 • 5 • 6



2208 N • 125 1/2 • 125 1/2
0.5x4 • 0.6x4.5 • 0.8x5.5



2215 N • 125 1/2 • 125 1/2
PH1 • PH2



2216 N • 125 1/2 • 125 1/2
PZ1 • PZ2



2223 N • 125 1/2 • 125 1/2
T10 • T15 • T20
T25 • T30



2250-1 • 125 1/2 • 125 1/2

HAZET No.	L x W x H mm		EAN-No. 4000896+
953 HP	355x235x65	47	215188

954 N Socket set

Made in Germany



- Additionally with screwdriver sockets coated with CVD titanium nitride (TIN), bits and adapter
- Plastic box 165-L (1/3)
- Safety-Insert-System, 2-component soft foam insert. Insert also suitable for HAZET Assistant



1/3			
-----	--	--	--



900 • 125 1/2
10 • 11 • 12 • 13 • 14
15 • 17 • 19 • 20 • 21
22 • 23 • 24 • 26 • 27
28 • 30 • 32



917-5 • 125 1/2 • 125 1/2



2217 • 125 1/2 • 125 1/2
PH1 • PH2 • PH3 • PH4



918-10 • 125 1/2 • 125 1/2



2218 • 125 1/2 • 125 1/2
PZ1 • PZ2 • PZ3 • PZ4



920 • 125 1/2 • 125 1/2



2224 • 125 1/2 • 125 1/2
T27 • T30 • T40
T45 • T50



915 • 125 1/2



986 • 125 1/2
5 • 6 • 7 • 8 • 10 • 12 • 14



2250-5 • 125 1/2 • 125 1/2

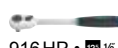

916 HP • 125 1/2

HAZET No.	L x W x H mm		EAN-No. 4000896+
954 N	355x235x65	44	046621



905 Socket set

Made in Germany

- Sheet metal box (HAZET blue)
- 2-component soft foam insert

HiPer inside 12⁵ 1/2



- | | | |
|------------------------|---------------------|----------------------|
| 900 • • 1/2 | 914-15 • 1/2 | 918-10 • 1/2 • 1/2 |
| 8 • 9 • 10 • 11 • 12 | 915 • 1/2 | 920 • 1/2 • 1/2 |
| 13 • 14 • 15 • 16 • 17 | 916 HP • 1/2 | 980 • 1/2 |
| 18 • 19 • 20 • 21 • 22 | 917-5 • 1/2 • 1/2 | 2 x 13 |
| 23 • 24 • 25 • 26 • 27 | | |
| 28 • 30 • 32 | | |

HAZET No.	L x W x H mm		EAN-No. 4000896+
905	435x215x62	30	045846

900 Z Socket set

Made in Germany

- With 12-point sockets
- Plastic box 165-L (1/3)
- Safety-Insert-System, 2-component soft foam insert. Insert also suitable for HAZET Assistant

HiPer inside 12⁵ 1/2



- | | | |
|------------------------|---------------|----------------------|
| 900 Z • • 1/2 | 915 • 1/2 | 917-5 • 1/2 • 1/2 |
| 10 • 11 • 12 • 13 • 14 | 916 HP • 1/2 | 918-10 • 1/2 • 1/2 |
| 15 • 16 • 17 • 18 • 19 | | 920 • 1/2 • 1/2 |
| 20 • 21 • 22 • 23 • 24 | | |
| 26 • 27 • 28 • 30 • 32 | | |

HAZET No.	L x W x H mm		EAN-No. 4000896+
900 Z	355x235x65	25	045440

900 AZ Socket set

Made in Germany

- With 12-point sockets
- **American dimensions**
- Plastic box 165-L (1/3)
- Safety-Insert-System, 2-component soft foam insert. Insert also suitable for HAZET Assistant

HiPer inside 12⁵ 1/2



1/3			
-----	--	--	--

- | | | |
|-----------------------------------|---------------|----------------------|
| 900 AZ • • 1/2 | 915 • 1/2 | 917-5 • 1/2 • 1/2 |
| 3/8 • 7/16 • 1/2 • 9/16 • 19/32 | 916 HP • 1/2 | 918-10 • 1/2 • 1/2 |
| 5/8 • 11/16 • 3/4 • 25/32 • 13/16 | | 920 • 1/2 • 1/2 |
| 7/8 • 15/16 • 31/32 • 1 • 1.1/16 | | |
| 1.1/8 • 1.3/16 • 1.1/4 | | |

HAZET No.	L x W x H mm		EAN-No. 4000896+
900 AZ	355x235x65	23	043569

932 Socket set

Made in Germany

- Plastic box 165-L (1/3)
- Safety-Insert-System, 2-component soft foam insert. Insert also suitable for HAZET Assistant

HiPer inside 12⁵ 1/2



1/3			
-----	--	--	--

- | | | |
|------------------------|---------------------|----------------------|
| 900 • • 1/2 | 916 HP • 1/2 | 918-10 • 1/2 • 1/2 |
| 10 • 11 • 12 • 13 • 14 | 917-5 • 1/2 • 1/2 | 920 • 1/2 • 1/2 |
| 15 • 16 • 17 • 18 • 19 | | |
| 21 • 22 • 24 • 27 | | |

HAZET No.	L x W x H mm		EAN-No. 4000896+
932/18	355x235x65	18	168378

900 HL Socket rail

- Easy installation: 2 bore holes, e.g. for wall fixation
- Holding clamps adapted to the drive size
- Clear arrangement – sockets are always ready to hand
- Made of metal
- Empty, with 16 holding clamps suitable for sockets of 900 series



HAZET No.	l mm	EAN-No. 4000896+
900 HL	430	043842



Hand tools

125 1/2 Range of sockets



900 SR SmartRail · Flexible plastic plug-in rail

Made in Germany

125 1/2

• Magnetic underside ensures grip on all ferrous surfaces, e.g. on tool trolleys, tool walls, machines, lifting platforms and in metal drawers

- HAZET SmartRail – Developed and produced „Made in Germany“
- Easy to clean
- Durable, robust twist lock for a tight fit and instant access
- More securely fixed when locked: turn socket left to remove
- Robust metal lug for hanging
- With 1/2" square sockets

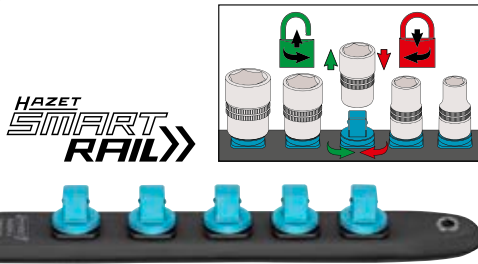

HAZET No.	L x W x H mm	l mm	EAN-No. 4000896+
• Empty, with 5x 1/2" square sockets			
900 SR-5	245x37.4x29.2	245	244508
• Empty, with 8x 1/2" square sockets			
900 SR-8	365x37.4x29.2	365	244515

916 1/2" Reversible ratchet · fine-tooth

Made in Germany

125 1/2

• A lot more power than with ratchets with the same dimensions

- Locking function of the lever prevents unwanted switching
- Increased service life thanks to the use of state-of-the-art lubricants in the ratchet mechanism
- Strict production tolerances prevent dirt from getting in
- HAZET internal quality standards guarantee loading capacity far beyond the standard requirements
- High-quality, easy to clean, corrosion-resistant
- Integrated suspension option in the handle
- VPA tested, static torque according to DIN 3122: 1000 Nm
- Number of teeth: 90 (Opening angle 4°)
- With locking ball
- HAZET 2-component handle
- Surface: chrome-plated
- DIN 3122, ISO 3315



HiPer
HIGH PERFORMANCE
THE ORIGINAL
MADE IN GERMANY



1000 Nm
HiPer

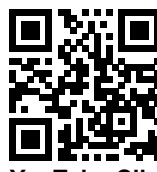
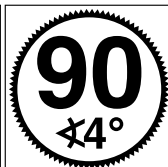

YouTube Clip

HAZET No.	l mm	EAN-No. 4000896+
916 HP	275	213894

916 1/2" Reversible ratchet

Made in Germany

125 1/2

- Number of teeth: 32 (Opening angle 11.25°)
- With locking ball
- HAZET 2-component handle
- Surface: chrome-plated, polished
- DIN 3122, ISO 3315



HAZET No.	l mm	EAN-No. 4000896+
916 SP	275	046317

916 1/2" Reversible ratchet · long · with hinge joint

Made in Germany

125 1/2

• Ratchet head can be swivelled > 180°

- Long design
- Number of teeth: 32 (Opening angle 11.25°)
- With hinge – for working in areas with restricted access and for getting around obstructive edges
- With locking ball
- HAZET 2-component handle
- Surface: chrome-plated, polished
- DIN 3122, ISO 3315



HAZET No.	l mm	b mm	EAN-No. 4000896+
916 GL	511	40	202485

916 1/2" Reversible ratchet · short

Made in Germany

125 1/2

- Only 199 mm short, in compact design of a 10 3/16" ratchet
- **Maximum torque: 300 Nm**
- Short design
- Number of teeth: 30 (Opening angle 12°)
- With locking ball
- HAZET 2-component handle
- Surface: chrome-plated, polished
- DIN 3122, ISO 3315



HAZET No.	l mm	EAN-No. 4000896+
916 K	199	155736



916 1/2" Reversible ratchet · fine-tooth · long

Made in Germany

• A lot more power for ratchets with the same dimensions

12⁵ 1/2 (E)

- Locking function of the lever prevents unwanted switching
- Increased service life thanks to the use of state-of-the-art lubricants in the ratchet mechanism
- Strict production tolerances prevent dirt from getting in
- HAZET internal quality standards guarantee loading capacity far beyond the standard requirements
- High-quality, easy to clean, corrosion-resistant
- Integrated suspension option in the handle
- VPA tested, static torque according to DIN 3122: 1000 Nm
- Long design
- Number of teeth: 90 (Opening angle 4°)
- With locking ball
- HAZET 2-component handle
- Surface: chrome-plated
- Similar to DIN 3122, Similar to ISO 3315

916 1/2" Reversible ratchet · fine-tooth · extendable

Made in Germany

• A lot more power for ratchets with the same dimensions

12⁵ 1/2 (E)

- Locking function of the lever prevents unwanted switching
- Increased service life thanks to the use of state-of-the-art lubricants in the ratchet mechanism
- Strict production tolerances prevent dirt from getting in
- HAZET internal quality standards guarantee loading capacity far beyond the standard requirements
- High-quality, easy to clean, corrosion-resistant
- Integrated suspension option in the handle
- VPA tested, static torque according to DIN 3122: 1000 Nm
- **Extra long design**
- Number of teeth: 90 (Opening angle 4°)
- With locking ball
- HAZET 2-component handle
- Surface: chrome-plated
- Similar to DIN 3122, Similar to ISO 3315
- Continuously adjustable from 414 to 614 mm (without pre-fixed detent points)
- Easy fixation with knurled clamping nut
- Twist protected handle ensures optimum force transmission without slipping



HiPer
HIGH PERFORMANCE
THE ORIGINAL
MADE IN GERMANY

HiPer
HIGH PERFORMANCE
THE ORIGINAL
MADE IN GERMANY

1000 Nm
HiPer

90
4°



1000 Nm
HiPer

90
4°



HAZET No.	l mm	EAN-No. 4000896+
916 HPL	415	219209

HAZET No.	l ₁ mm	l ₂ mm	EAN-No. 4000896+
916 HPLg	414	614	233076





Hand tools

12⁵ 1/2 Range of sockets



916 1/2" Reversible ratchet · fine-tooth · short

Made in Germany

12⁵ 1/2

• A lot more power for ratchets with the same dimensions

- Locking function of the lever prevents unwanted switching
- Increased service life thanks to the use of state-of-the-art lubricants in the ratchet mechanism
- Strict production tolerances prevent dirt from getting in
- HAZET internal quality standards guarantee loading capacity far beyond the standard requirements
- High-quality, easy to clean, corrosion-resistant
- Integrated suspension option in the handle
- VPA tested, static torque according to DIN 3122: 400 Nm
- Short design
- Number of teeth: 90 (Opening angle 4°)
- With locking ball
- HAZET 2-component handle
- Surface: chrome-plated
- Similar to DIN 3122, Similar to ISO 3315



HAZET No.	l mm	EAN-No. 4000896+
916HPK	200	244379

916 1/2" Reversible ratchet · fine-tooth

Made in Germany

12⁵ 1/2 (E)

• A lot more power than with ratchets with the same dimensions

- Latching function of the shift lever provides protection against unwanted switching
- Increased service life thanks to the use of state-of-the-art lubricants in the ratchet mechanism
- Strict production tolerances prevent dirt from getting in
- HAZET internal quality standards guarantee loading capacity far beyond the standard requirements
- High-quality, easy to clean, corrosion-resistant
- Integrated suspension option in the handle
- VPA tested, static torque according to DIN 3122: 850 Nm
- Quick-release safety lock
- Sockets are securely locked in place
- Attached tools can easily be released by pressing the button with just one hand
- Number of teeth: 90 (Opening angle 4°)
- With locking ball
- HAZET 2-component handle
- Surface: chrome-plated
- DIN 3122, ISO 3315



HiPer
HIGH PERFORMANCE
THE ORIGINAL
MADE IN GERMANY



YouTube Clip



HAZET No.	l mm	EAN-No. 4000896+
916HPS	275	237258

Wear? – No problem!

- HAZET tools are manufactured to the highest quality. During long intensive loading there is a certain level of wear even for high-quality tools.
- For this reason, there are spare parts and replacement sets available for many of our tools.



Please also see our spare parts shop
www.hazet.de/ersatzteil-shop

Cost-saving – Sustainable – Resource-saving!
For long-term pleasure with your HAZET tools

916 Replacement set

Made in Germany

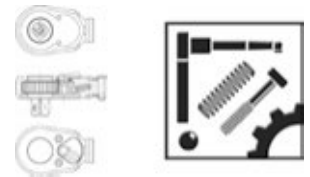

HAZET No.	EAN-No. 4000896+
<ul style="list-style-type: none"> • Replacement set for ratchet wheel 12.5 = 1/2" ■ consisting of: pawl · compression spring · ball · spring sleeve · shift lever · cover disc · circlip · ratchet wheel · grease · assembly tool For reversible ratchets 916HP · 916HPS · 916HPL · 916HPLg 	
916HP/10	218981
<ul style="list-style-type: none"> • Replacement set for ratchet wheel with safety lock 12 = 1/2" ■ consisting of: assembly tool · ratchet wheel with safety lock · circlip · cover disc · shift lever · spring sleeve · ball · compression spring · pawl · grease For HAZET reversible ratchet 916HPS as well as for retrofitting HAZET reversible ratchets 916HP · 916HPL · 916HPLg (reduction to maximum 850Nm peak load) 	
916HPS/10	241255
<ul style="list-style-type: none"> • Replacement set for ratchet wheel with safety lock 12.5 = 1/2" ■ consisting of: Shift lever · 2 screws · ball · compression spring · ratchet wheel with safety lock · pawl For HAZET reversible ratchet 916S as well as for retrofitting HAZET reversible ratchets 916SP · 916GK · 916L · 916ST 	
916S/7	046300
<ul style="list-style-type: none"> • Replacement set for shift lever 12.5 = 1/2" ■ consisting of: shift lever · 2 screws · ball and compression spring and pawl For HAZET reversible ratchet 916S · 916SP · 916GK · 916LG · 916L · 916GL · 916ST and beam puller 1774-1 	
916SP/6	144624
<ul style="list-style-type: none"> • Replacement set for ratchet wheel 12.5 = 1/2" ■ consisting of: shift lever · screws · ball · compression spring · ratchet wheel and pawl For HAZET reversible ratchet 916SP · 916GK · 916Lg · 916L · 916GL · 916ST 	
916SP/7-1	046348
<ul style="list-style-type: none"> • Replacement set for ratchet wheel 12.5 = 1/2" ■ consisting of: shift lever · screws · ball · ratchet wheel and pawl For HAZET reversible ratchet 916K 	
916K/7	155743

914 1/2" Flexible handle

Made in Germany

12⁵ 1/2 (E)

- With hinge – for working in areas with restricted access and for getting around obstructive edges
- With locking ball
- HAZET 2-component handle
- Surface: chrome-plated
- DIN 3122, ISO 3315



¹⁾ Length not according to DIN

HAZET No.	l mm	EAN-No. 4000896+
914-15	396	046027
914-18¹⁾	472	046041



915 1/2" Sliding T-handle

Made in Germany

- With locking ball
- Surface: chrome-plated, polished
- DIN 3122, ISO 3315

12⁵ 1/2



HAZET No.	l mm	EAN-No. 4000896+
915	298	046072

900 1/2" Socket · hexagon

Made in Germany

- With knurling
- Surface: chrome-plated, polished
- DIN 3124, ISO 2725-1

12⁵ 1/2

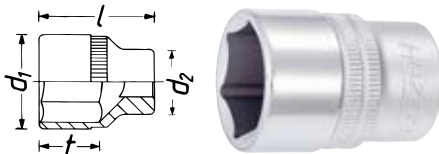

¹⁾ Not according to DIN

HAZET No.	l mm	d ₁ mm	d ₂ mm	f mm	EAN-No. 4000896+
900- 8	38	12	22	7.8	042968
900- 9 ¹⁾	38	13.5	22	8.8	042975
900-10	38	14.9	22	10.8	042715
900-11	38	16.4	22	10.8	042722
900-12	38	17.5	22	11.3	042739
900-13	38	18.8	22	11.3	042746
900-14	38	20.3	22.5	11.8	042753
900-15	38	21.5	23.2	11.8	042760
900-16	38	22.7	23.6	12.2	042777
900-17	38	24.1	22	12.7	042784
900-18	38	25.4	22.4	14.2	042791
900-19	38	26.6	23	14.2	042807
900-20	38	27.8	24	14.2	042821
900-21	38	29	25	14.1	042838
900-22	41.5	30.4	26	17.6	042845
900-23 ¹⁾	41.5	31.4	26	17.6	042869
900-24	44	32.6	26	18.2	042876
900-25 ¹⁾	44	33.9	26	17.9	042883
900-26 ¹⁾	44	35.1	24	17.8	042890
900-27	46	36.2	25	19.7	042906
900-28 ¹⁾	47	37.5	26	20.6	042913
900-29 ¹⁾	50	38.7	27	23.4	042920
900-30	50	40.1	28	23.3	042937
900-32	50	42.3	28	23	042944
900-34	52	46	28	23.3	042951
900-36 ¹⁾	57	49	28	25.6	192519

900 SmartRail · Flexible plastic plug-in rail

Made in Germany

- Magnetic underside ensures grip on all ferrous surfaces, e.g. on tool trolleys, tool walls, machines, lifting platforms and in metal drawers

12⁵ 1/2

- HAZET SmartRail – Developed and produced „Made in Germany“
- Easy to clean
- Durable, robust twist lock for a tight fit and instant access
- More securely fixed when locked: turn socket left to remove
- Robust metal lug for hanging
- With 1/2" square sockets

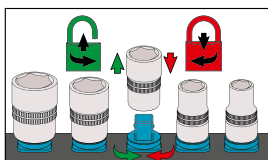

HAZET SMART RAIL

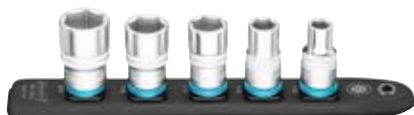

900 SmartRail · Flexible plastic plug-in rail

12⁵ 1/2

HAZET No.	l mm	Socket	EAN-No. 4000896+
900 • 12 ⁵ 1/2			
10 • 13 • 17 • 19 • 22			
900-SR/5	245	5	245239
900 • 12 ⁵ 1/2			
10 • 13 • 16 • 17 • 18 • 19 • 22 • 24			
900-SR/8	365	8	245369

900LG 1/2" Socket · hexagon

Made in Germany

- Long design
- With knurling
- Surface: chrome-plated, polished
- DIN 3124, ISO 2725-1

12⁵ 1/2



HAZET No.	l mm	d ₁ mm	d ₂ mm	f mm	EAN-No. 4000896+
900LG-10	85	14.9	22	10	053438
900LG-12	85	17.5	22	12.3	043873
900LG-13	85	18.8	22	13.3	043880
900LG-14	85	19.9	22.5	14.2	043897
900LG-15	85	21.5	23.2	15.2	043903
900LG-16	85	22.7	23.6	16	043910
900LG-17	85	24.1	23.6	19	043927
900LG-18	85	24.6	23.6	19	043934
900LG-19	85	28.5	26	19	043941
900LG-21	85	28.6	24.5	19	043965
900LG-22	85	30.4	25	22	043972
900LG-24	85	32.6	27.5	25	043989
900LG-27	85	36.3	30	28	044009
900LG-30	85	40.1	33	31	044016
900LG-32	85	42.5	35	34.2	049660

900LG SmartRail · Flexible plastic plug-in rail

Made in Germany

- Magnetic underside ensures grip on all ferrous surfaces, e.g. on tool trolleys, tool walls, machines, lifting platforms and in metal drawers

12⁵ 1/2

- HAZET SmartRail – Developed and produced „Made in Germany“
- Easy to clean
- Durable, robust twist lock for a tight fit and instant access
- More securely fixed when locked: turn socket left to remove
- Robust metal lug for hanging
- With 1/2" square sockets

HAZET SMART RAIL

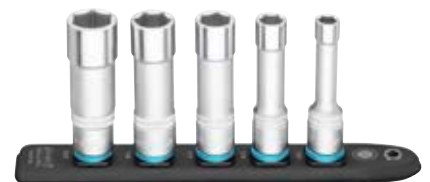
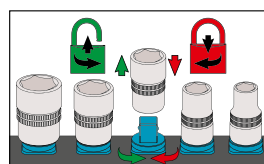

HAZET No.	l mm	Socket	EAN-No. 4000896+
900LG • 12 ⁵ 1/2			
10 • 13 • 17 • 19 • 22			
900LG-SR/5	245	5	245246



Hand tools

12⁵ 1/2 Range of sockets



900 Z 1/2" Socket · 12-point

Made in Germany

- With knurling
- Surface: chrome-plated, polished
- DIN 3124, ISO 2725-1

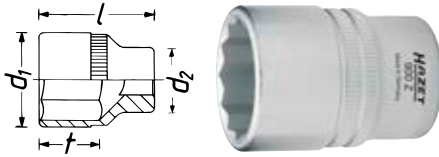
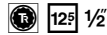

900 AZ 1/2" Socket · 12-point

Made in Germany

- American dimensions
- With knurling
- Surface: chrome-plated, polished

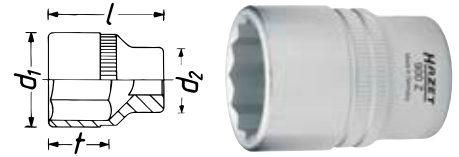
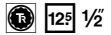

¹⁾ Not according to DIN

HAZET No.	l mm	d ₁ mm	d ₂ mm	f mm	EAN-No. 4000896+
900 Z- 8	38	12	22	7.5	045686
900 Z- 9 ¹⁾	38	13.5	22	8.5	045693
900 Z-10	38	14.9	22	10.5	045457
900 Z-11	38	16.4	22	10.5	045464
900 Z-12	38	17.5	22	11	045471
900 Z-13	38	18.8	22	11	045488
900 Z-14	38	20.3	22.5	11.5	045495
900 Z-15	38	21.5	23.2	11.5	045501
900 Z-16	38	22.7	23.6	12.5	045518
900 Z-17	38	24.1	22	12.5	045525
900 Z-18	38	25.4	22.4	14	045532
900 Z-19	38	26.6	23	14	045549
900 Z-20	38	27.8	24	14	045556
900 Z-21	38	29	25	14	045563
900 Z-22	41.5	30.4	25	17.5	045570
900 Z-23 ¹⁾	41.5	31.4	26	17.5	045587
900 Z-24	44	32.6	26	20	045594
900 Z-25 ¹⁾	44	33.9	26.5	20	045600
900 Z-26 ¹⁾	44	35.1	24	20	045617
900 Z-27	46	36.2	25	21	045624
900 Z-28 ¹⁾	47	37.5	26	22	045631
900 Z-30	50	40.1	28	25	045655
900 Z-32 ¹⁾	50	42.3	28	24	045662
900 Z-33 ¹⁾	50	43.6	28	24	045679
900 Z-34 ¹⁾	52	46	28	23.3	144792
900 Z-36 ¹⁾	57	49	28	25.6	192502

HAZET No.	l mm	d ₁ mm	d ₂ mm	f mm	EAN-No. 4000896+
900 AZ-3/8	38	14.5	22	10.5	043699
900 AZ-7/16	38	16.4	22	10.5	043729
900 AZ-1/2	38	18.3	22	11	043620
900 AZ-9/16	38	20.5	22.5	11.5	043743
900 AZ-19/32	38	21.5	23.2	11.5	043668
900 AZ-5/8	38	22.7	23.6	12.5	043712
900 AZ-11/16	38	24.6	22	12.5	043637
900 AZ-3/4	38	26.8	23	14	043682
900 AZ-25/32	38	27.8	24	14	043675
900 AZ-13/16	38	28.6	25	14	043644
900 AZ-7/8	41.5	30.4	26	17.5	043736
900 AZ-15/16	44	32.6	26	20	043651
900 AZ-31/32	44	33.4	24.6	20	043705
900 AZ-1	44	34.6	24.8	20	043576
900 AZ-1.1/16	46	36.3	25	21	043583
900 AZ-1.1/8	47	38.2	26.5	22	043606
900 AZ-1.3/16	50	40.1	28	25	043613
900 AZ-1.1/4	50	42.3	28	24	043590

900 TZ 1/2" Socket · 12-point

Made in Germany

- Long design
- With knurling
- Surface: chrome-plated, polished
- DIN 3124, ISO 2725-1

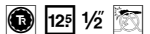

¹⁾ With rubber ply for spark plugs / not according to DIN

HAZET No.	l mm	d ₁ mm	d ₂ mm	f mm	EAN-No. 4000896+
900 TZ-10	85	14.9	22	10	053452
900 TZ-11	85	16.4	22	11.5	053445
900 TZ-12	85	17.5	22	12.3	045242
900 TZ-13	85	18.8	22	13.3	045259
900 TZ-14	85	19.9	22.5	15.2	045266
900 TZ-15	85	21.5	23.2	15.2	045273
900 TZ-16	85	22.7	23.6	16	045280
900 TZ-17	85	24.1	23.6	19	045297
900 TZ-18	85	24.6	23.6	19	045310
900 TZ-19	85	26.8	26	19	045334
900 TZ-20.8-13/16 ¹⁾	85	28.5	24.5	19	045341
900 TZ-21	85	28.6	24.5	19	045358
900 TZ-22	85	30.4	25	22	045365
900 TZ-24	85	32.6	27.5	25	045389
900 TZ-27	85	36.3	30	28	045419
900 TZ-30	85	40.1	33	31	045426

900 Z SmartRail · Flexible plastic plug-in rail

Made in Germany

- Magnetic underside ensures grip on all ferrous surfaces, e.g. on tool trolleys, tool walls, machines, lifting platforms and in metal drawers

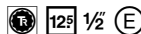

- HAZET SmartRail – Developed and produced „Made in Germany“
- Easy to clean
- Durable, robust twist lock for a tight fit and instant access
- More securely fixed when locked: turn socket left to remove
- Robust metal lug for hanging
- With 1/2" square sockets



HAZET No.	l mm	□	EAN-No. 4000896+
900 Z • 12 • 1/2			
10 • 13 • 17 • 19 • 22			
900 Z-SR/5	245	5	245291



900 MGT 1/2" Spark plug socket

Made in Germany

- Magnetic bit retention
- American dimensions
- Surface: chrome-plated, polished

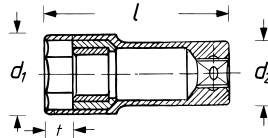
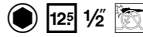

HAZET No.	S mm	S"	l mm	d ₁ mm	d ₂ mm	t mm	EAN-No. 4000896+
900 MGT	20.8	13/16	68	27.4	23.5	9	044023
900 A MGT	16	5/8	71	22.5	22.5	8.5	043491

900 KF 1/2" Spark plug socket

Made in Germany

- The fixing clamp reduces the risk of insulator damage
- Fixing clamp to hold the spark plug
- American dimensions
- Surface: chrome-plated, polished

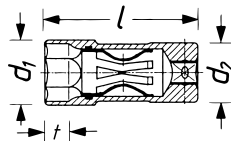
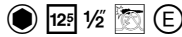

HAZET No.	S mm	S"	l mm	d ₁ mm	d ₂ mm	t mm	EAN-No. 4000896+
900 KF	20.8	13/16	71	27.4	25	10	043859
900 A KF	16	5/8	71	22.5	22.5	10	043408

Fixing clamp information

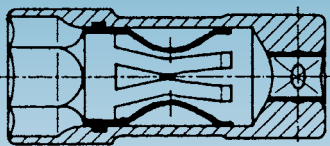

- Stainless and insensitive to heat
- Largest possible clearance of insulator
- 6 spring elements – firm hold of the spark plug
- Damping of transverse motion

880 KF Fixing clamp

Made in Germany

- American dimensions



880 KF Fixing clamp

HAZET No.

EAN-No. 4000896+

- Fixing clamp for HAZET spark plug wrench 880KF · 900KF · 4767KF
880 KF-01 050123
- Fixing clamp for HAZET spark plug wrench 880A KF · 900A KF · 4766 · 4766-1 · 4767A KF
880 A KF-01 050130

848 Z Box-end wrench · 12-point · open

Made in Germany

- Crowfoot wrenches
- For union nuts and tube connections
- Square socket

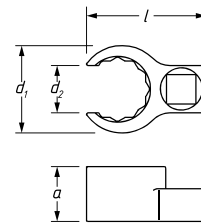

HAZET No.	l mm	d ₁ mm	d ₂ mm	a mm	mm	EAN-No. 4000896+
848 Z-17	40.9	27.5	14.5	18	□ 10 = 3/8"	079094
848 Z-18	41.7	29	15	19	□ 10 = 3/8"	079100
848 Z-19	41.9	30	16	19	□ 10 = 3/8"	079117
848 Z-21	46	32	16.5	19	□ 10 = 3/8"	079124
848 Z-22	46.5	33.5	17.5	19.5	□ 10 = 3/8"	079131
848 Z-24	50	36.5	18.5	20	□ 10 = 3/8"	079148
848 Z-27	53.7	40.5	20.5	22	□ 10 = 3/8"	079162
848 Z-30	62.4	46.5	25	23	□ 12.5 = 1/2"	079179
848 Z-32	63.7	48.5	24.5	23	□ 12.5 = 1/2"	079186
848 Z-36	67.1	52.5	27.5	24.5	□ 12.5 = 1/2"	079193
848 Z-41	74.1	58.5	31	24.5	□ 12.5 = 1/2"	079216
848 Z-46	77.7	64.5	35.5	26.5	□ 12.5 = 1/2"	079223

960 MGT Magnetic insert · for sockets

- Universal application in metric 6-point and 12-point sockets ≤ 10 to 19 mm

- Sockets made of plastic with integrated magnet
- Powerful retention force
- Reusable
- 10-piece set, for metric sockets
≤ 10 · 11 · 12 · 13 · 14 · 15 · 16 · 17 · 18 · 19 mm

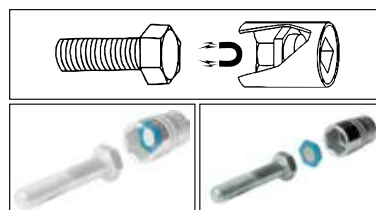

HAZET No.

EAN-No. 4000896+

960 MGT

097661



Hand tools

125 1/2 Range of sockets



900 E 1/2" Socket · TORX®

Made in Germany

- With knurling
- Surface: chrome-plated, polished

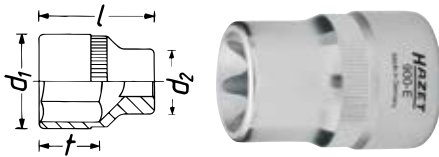
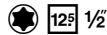

HAZET No.	s	l mm	d ₁ mm	d ₂ mm	mm	EAN-No. 4000896+
900-E 10	E10	38	13.3	22	9.42	042982
900-E 11	E11	38	14	22	10.08	043002
900-E 12	E12	38	14.9	22	11.17	043019
900-E 14	E14	38	16.7	22	12.90	043033
900-E 16	E16	38	19	22	14.76	043057
900-E 18	E18	38	21	27	16.70	043071
900-E 20	E20	38	23.5	27	18.49	043095
900-E 24	E24	41.2	28.5	27	22.16	043118

900 1/2" Socket set · TORX®

Made in Germany

- With knurling
- Safety-Insert-System, 2-component soft foam insert. Insert also suitable for HAZET Assistant
- Surface: chrome-plated, polished

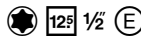

900 E • 125 1/2
E 10 • E 12 • E 14 • E 16 • E 18



HAZET No.	L x W mm	mm	EAN-No. 4000896+
900-E/5	172x50	5	129331

900 E SmartRail · Flexible plastic plug-in rail

Made in Germany

- Magnetic underside ensures grip on all ferrous surfaces, e.g. on tool trolleys, tool walls, machines, lifting platforms and in metal drawers

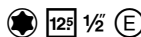

- HAZET SmartRail – Developed and produced „Made in Germany“
- Easy to clean
- Durable, robust twist lock for a tight fit and instant access
- More securely fixed when locked: turn socket left to remove
- Robust metal lug for hanging
- With 1/2" square sockets

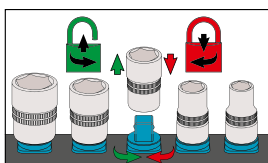

HAZET SMART RAIL



HAZET No.	l mm	mm	EAN-No. 4000896+
900 E • 125 1/2 E 12 • E 14 • E 16 • E 18 • E 20	245	5	245314
900 E • 125 1/2 E 10 • E 11 • E 12 • E 14 • E 16 • E 18 • E 20 • E 24	365	8	245383

980 1/2" Screwdriver socket

Made in Germany

- Surface: chrome-plated

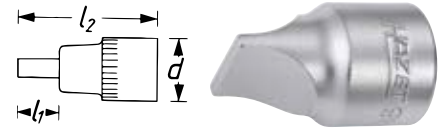

HAZET No.	l ₁ mm	l ₂ mm	d mm	EAN-No. 4000896+
980-2 x 13	21	38	22	046737
980-3 x 19	20	38	23.7	046744

985 1/2" Screwdriver socket

Made in Germany

- Extra short design
- With knurling
- DIN 7422

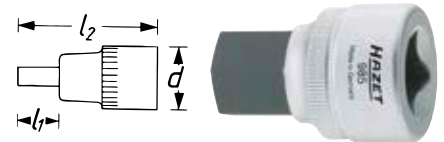

¹⁾ Not according to DIN

HAZET No.	s mm	l ₁ mm	l ₂ mm	d mm	EAN-No. 4000896+
985- 5 ¹⁾	5	5	38	23	046836
985- 6	6	6	38	23	046843
985- 8	8	8	38	23	046850
985-10	10	10	40	25	046775
985-12	12	12	40	25	046782
985-14	14	14	40	25	046799
985-17 ¹⁾	17	17	42	28	046805
985-19 ¹⁾	19	19	42	28	046812

985 Screwdriver socket set

Made in Germany

- Extra short design
- With knurling
- Plastic box 165-L (1/3)
- 2-component soft foam insert
- DIN 7422



1/3			
-----	--	--	--



985 • 125 1/2
5 • 6 • 8 • 10
12 • 14 • 17 • 19



915 • 125 1/2

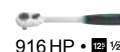

916 HP • 125 1/2



917-5 • 125 1/2 • 125 1/2

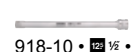

918-10 • 125 1/2 • 125 1/2

HAZET No.	mm	EAN-No. 4000896+
985	12	046768



TiN coating



Why choose TiN (Titanium Nitride) coating?

- A special coating process for extremely hard TiN coating guarantees high adhesive strength and wear resistance of the coating
- Particularly suitable for continuous load, e. g. for industrial applications in industry and trade
- Higher wear protection guarantees a longer lifetime
- Perfect fitting accuracy due to optimum coating thickness
- Optimized corrosion protection

TiN coated screwdriver sockets

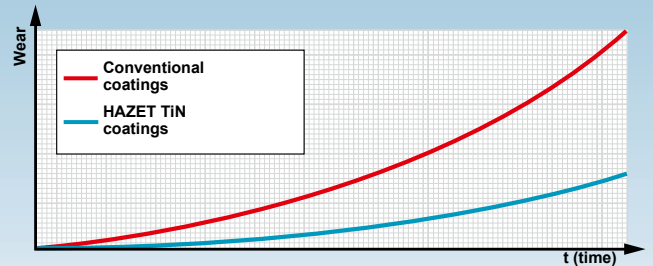
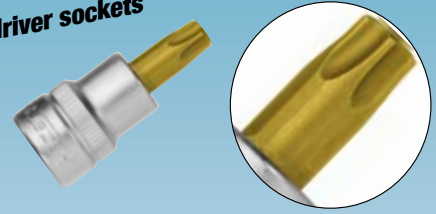

986 1/2" Screwdriver socket

Made in Germany

- Short design
- With knurling
- Surface: TiN coated
- DIN 7422

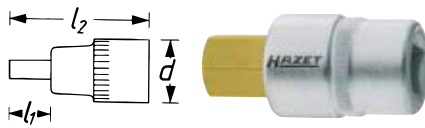
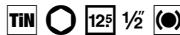

¹⁾ Not according to DIN

HAZET No.	S mm	l ₁ mm	l ₂ mm	d mm	EAN-No. 4000896+
986- 4 ¹⁾	4	22	60	23	046928
986- 5 ¹⁾	5	22	60	23	046935
986- 6	6	22	60	23	046942
986- 7	7	22	60	23	046959
986- 8	8	22	60	23	046973
986- 9	9	22	60	23	146734
986-10	10	22	60	23	046874
986-12	12	22	60	24.6	046881
986-14	14	22	60	24.6	046898
986-17 ¹⁾	17	20	60	28.5	046904
986-19 ¹⁾	19	20	60	31.5	046911
986-22 ¹⁾	22	20.5	60	28	082865

986 SmartRail · Flexible plastic plug-in rail

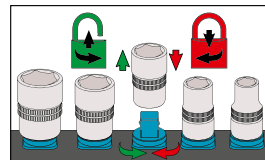
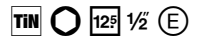

HAZET No.	l mm	Icon	EAN-No. 4000896+
986 · O · 12 ⁵ 1/2	6 · 7 · 8 · 9 · 10 · 12 · 14 · 17		
986-SR/8	365	8	245390
986 · O · 12 ⁵ 1/2	12 · 14 · 17 · 19 · 22		
986 G-SR/5	245	5	245338
986 · O · 12 ⁵ 1/2	5 · 6 · 7 · 8 · 10		
986 K-SR/5	245	5	245321

986 L 1/2" Screwdriver socket

Made in Germany

- Long design
- With knurling
- Surface: TiN coated
- DIN 7422



HAZET No.	S mm	l ₁ mm	l ₂ mm	d mm	EAN-No. 4000896+
986 L- 4	4	62	100	23	232635
986 L- 5	5	62	100	23	232628
986 L- 6	6	62	100	23	232611
986 L- 7	7	62	100	23	232604
986 L- 8	8	62	100	23	232598
986 L- 9	9	62	100	23	232581
986 L-10	10	62	100	23	232574
986 L-11	11	62	100	23	232567
986 L-12	12	62	100	23	232550
986 L-14	14	62	100	23	232543

986 SmartRail · Flexible plastic plug-in rail

Made in Germany

- Magnetic underside ensures grip on all ferrous surfaces, e.g. on tool trolleys, tool walls, machines, lifting platforms and in metal drawers

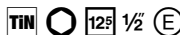

- HAZET SmartRail – Developed and produced „Made in Germany“
- Easy to clean
- Durable, robust twist lock for a tight fit and instant access
- More securely fixed when locked: turn socket left to remove
- Robust metal lug for hanging
- With 1/2" square sockets
- Surface: TiN coated





Hand tools

125 1/2 Range of sockets



986 SL 1/2" Screwdriver socket

Made in Germany

- Extra long design
- With knurling
- Surface: TIN coated
- DIN 7422

TIN 125 1/2

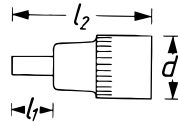

HAZET No.	S mm	l ₁ mm	l ₂ mm	d mm	EAN-No. 4000896+
986 SL- 4	4	102	140	23	232291
986 SL- 5	5	102	140	23	232376
986 SL- 6	6	102	140	23	232369
986 SL- 7	7	102	140	23	232352
986 SL- 8	8	102	140	23	232345
986 SL- 9	9	102	140	23	232338
986 SL-10	10	102	140	23	232321
986 SL-11	11	102	140	23	232314
986 SL-12	12	102	140	23	232536
986 SL-14	14	102	140	23	232307

986 A 1/2" Screwdriver socket

Made in Germany

- Short design
- American dimensions
- With knurling
- Surface: TIN coated

TIN 125 1/2

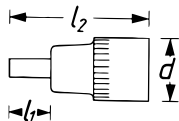
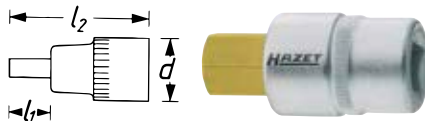

HAZET No.	l ₁ mm	l ₂ mm	d mm	EAN-No. 4000896+
986 A-5/32	14	52	23	047048
986 A-3/16	14	52	23	047017
986 A-7/32	14	52	23	047062
986 A-1/4	14	52	23	047000
986 A-5/16	14	52	23	047031
986 A-3/8	14	52	23	047024
986 A-7/16	14	52	23	047055
986 A-1/2	14	52	23	046997

HAZET No.	S mm	l ₁ mm	l ₂ mm	EAN-No. 4000896+
2584-1	6	210	248	017058

986 KK 1/2" Screwdriver socket

Made in Germany

- Especially for working in areas with restricted access (e.g. engine compartment)
- Long design
- With ball-head
- With knurling
- Surface: TIN coated

TIN 125 1/2

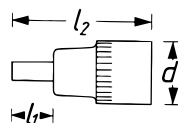

HAZET No.	S mm	l ₁ mm	l ₂ mm	d mm	EAN-No. 4000896+
986 KK- 5	5	102	140	23	052103
986 KK- 6	6	102	140	23	050666
986 KK- 7	7	102	140	23	052110
986 KK- 8	8	102	140	23	052127
986 KK-10	10	102	140	23	052134
986 KK-12	12	102	140	24.6	052141

986 Screwdriver socket set

Made in Germany

- Short design
- With knurling
- Plastic box 165-S (1/9)
- Safety-Insert-System, 2-component soft foam insert. Insert also suitable for HAZET Assistant
- Surface: TIN coated
- DIN 7422

TIN 125 1/2 (E)



1/9				

986 • O • 1/2
5 • 6 • 7 • 8 • 10
12 • 14 • 17 • 19

HAZET No.	L x W x H mm		EAN-No. 4000896+
986/9	185x153x52	9	051564

Made in Germany

- Short design
- With knurling
- Plastic box 165-S (1/9)
- Safety-Insert-System, 2-component soft foam insert. Insert also suitable for HAZET Assistant
- Surface: TIN coated
- DIN 7422

TIN 125 1/2 (E)



1/9				

986 • O • 1/2
5 • 6 • 7 • 8 • 9
10 • 12 • 14 • 17

HAZET No.	L x W x H mm		EAN-No. 4000896+
986/9 N	185x153x52	9	193530

Made in Germany

- With ball-head
- With knurling
- Plastic box 165-L (1/3)
- Safety-Insert-System, 2-component soft foam insert. Insert also suitable for HAZET Assistant
- Surface: TIN coated
- DIN 7422

TIN 125 1/2 (E)



1/3				

986 • O • 1/2
5 • 6 • 7 • 8 • 10 • 12 • 14 • 17 • 19

986 KK • O • 1/2
6 • 7 • 8 • 10

HAZET No.	L x W x H mm		EAN-No. 4000896+
986/13	355x235x65	13	168330



986 Screwdriver socket set

Made in Germany

- Short design
- With knurling
- Safety-Insert-System, 2-component soft foam insert. Insert also suitable for HAZET Assistant
- Surface: TIN coated

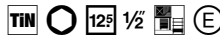

1/9			
-----	--	--	--

986 • O • 125 1/2
5 • 6 • 7 • 8 • 10



HAZET No.	L x W mm		EAN-No. 4000896+
163-215/5	172x114	5	168217

Made in Germany

- With ball-head
- With knurling
- Safety-Insert-System, 2-component soft foam insert. Insert also suitable for HAZET Assistant
- Surface: TIN coated

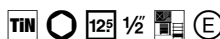

1/3			
-----	--	--	--



986 • O • 125 1/2
5 • 6 • 7 • 8 • 10 • 12 • 14 • 17 • 19

986 KK • O • 125 1/2
6 • 7 • 8 • 10

HAZET No.	L x W mm		EAN-No. 4000896+
163-220/13	342x172	13	168286

990 1/2" Screwdriver socket

Made in Germany

- Short design
- With knurling
- Surface: TIN coated

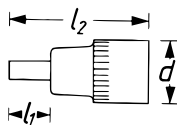

HAZET No.	S	l ₁ mm	l ₂ mm	d mm	EAN-No. 4000896+
990- 5	M5	14	52	23	047307
990- 6	M6	14	52	23	047314
990- 8	M8	15	53	23	047321
990-10	M10	15	53	23	047253
990-12	M12	17	55	23	047277
990-14	M14	20	58	24.6	047284
990-16	M16	22	60	24.6	047291
990-18	M18	45	85	26	108916

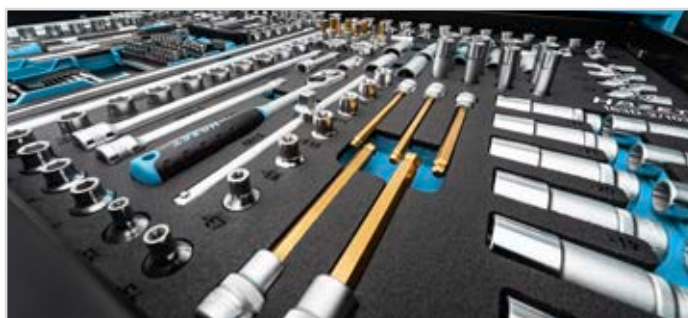

990 SmartRail · Flexible plastic plug-in rail

Made in Germany

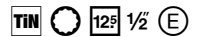

- Magnetic underside ensures grip on all ferrous surfaces, e.g. on tool trolleys, tool walls, machines, lifting platforms and in metal drawers

- HAZET SmartRail – Developed and produced „Made in Germany“
- Easy to clean
- Durable, robust twist lock for a tight fit and instant access
- More securely fixed when locked: turn socket left to remove
- Robust metal lug for hanging
- With 1/2" square sockets
- Surface: TIN coated

HAZET SMART RAIL

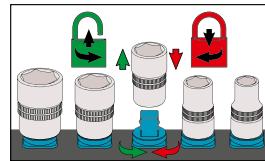

HAZET No.	l mm		EAN-No. 4000896+
990 • O • 125 1/2 M6 • M8 • M10 • M12 • M14			
990-SR/5	245	5	245284
990 • O • 125 1/2 M5 • M6 • M8 • M10 • M12 • M14 • M16 • M18			
990-SR/8	365	8	245352

990 LG 1/2" Screwdriver socket

Made in Germany



- Long design
- With knurling
- Surface: TIN coated

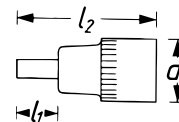

HAZET No.	S	l ₁ mm	l ₂ mm	d mm	EAN-No. 4000896+
990 LG- 6	M6	62	100	23	056248
990 LG- 8	M8	62	100	23	047352
990 LG- 9	M9	62	100	23	103140
990 LG-10	M10	62	100	23	047338
990 LG-12	M12	62	100	23	047345
990 LG-14	M14	62	100	23	065240

HAZET No.	S	l ₁ mm	l ₂ mm	d mm	EAN-No. 4000896+
2751	M10	100	140	23	017508

990 SLG 1/2" Screwdriver socket

Made in Germany

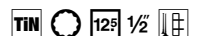

- Extra long design
- With knurling
- Surface: TIN coated

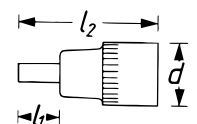

HAZET No.	S	l ₁ mm	l ₂ mm	d mm	EAN-No. 4000896+
990 SLg-10	M10	82	120	23	047369
990 SLg-12	M12	102	140	23	047376



Hand tools

12⁵ 1/2 Range of sockets



990 Screwdriver socket set

Made in Germany

- With knurling
- Plastic box 165-L (1/3)
- Safety-Insert-System, 2-component soft foam insert. Insert also suitable for HAZET Assistant
- Surface: TIN coated

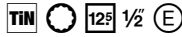

1/3			
-----	--	--	--



990 • \odot • $\frac{12}{5}$
M 8 • M 10 • M 12
M 14 • M 16 • M 18



990 LG • \odot • $\frac{12}{5}$
M 8 • M 14



990 SLG • \odot • $\frac{12}{5}$
M 10 • M 12

HAZET No.	L x W x H mm		EAN-No. 4000896+
990/10	355x235x65	10	168347

991 1/2" Screwdriver socket

Made in Germany

- Short design
- With knurling
- Surface: TIN coated

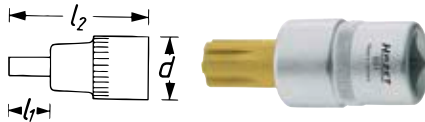

HAZET No.	S	l ₁ mm	l ₂ mm	d mm	EAN-No. 4000896+
991- 6	M6	25	63	23	047451
991- 7	M7	25	63	23	132799
991- 8	M8	25	63	23	047468
991- 9	M9	25	63	23	132812
991-10	M10	25	63	23	047406
991-12	M12	25	63	23	047413
991-14	M14	25	63	24.6	047420

992 1/2" Screwdriver socket • TORX®

Made in Germany

- Short design
- With knurling
- Surface: TIN coated

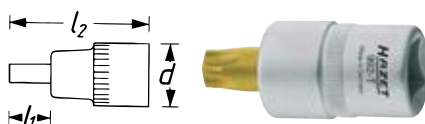

HAZET No.	S	l ₁ mm	l ₂ mm	d mm	mm	EAN-No. 4000896+
992-T20	T20	17	55	23	3.86	047475
992-T25	T25	17	55	23	4.43	047482
992-T27	T27	17	55	23	4.99	047499
992-T30	T30	17	55	23	5.52	047505
992-T40	T40	17	55	23	6.65	047512
992-T45	T45	17	55	23	7.82	047529
992-T50	T50	17	55	23	8.83	047543
992-T55	T55	18	56	24.6	11.22	047574
992-T60	T60	18	56	24.6	13.25	047598

992 Screwdriver socket set • TORX®

Made in Germany

- Short design
- With knurling
- Plastic box 165-S (1/9)
- Safety-Insert-System, 2-component soft foam insert. Insert also suitable for HAZET Assistant
- Surface: TIN coated

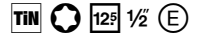

1/9			
-----	--	--	--

992 • \odot • $\frac{12}{5}$
T 20 • T 25 • T 27
T 30 • T 40 • T 45
T 50 • T 55 • T 60

HAZET No.	L x W x H mm		EAN-No. 4000896+
992/9	185x153x52	9	051540

992 T Screwdriver socket set • TORX®

Made in Germany

- With knurling
- Safety-Insert-System, 2-component soft foam insert. Insert also suitable for HAZET Assistant
- Surface: TIN coated

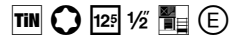

1/9			
-----	--	--	--

992 • \odot • $\frac{12}{5}$
T 20 • T 25 • T 27
T 30 • T 40 • T 45
T 50 • T 55 • T 60

HAZET No.	L x W mm		EAN-No. 4000896+
163-271/9	172x114	9	181056

992 H 1/2" Screwdriver socket • TORX®

Made in Germany

- Face side hole
- Short design
- With knurling
- Surface: TIN coated

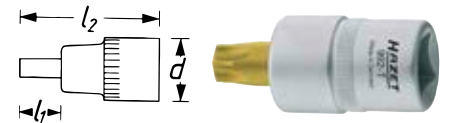

HAZET No.	S	l ₁ mm	l ₂ mm	d mm	mm	EAN-No. 4000896+
992-T 30 H	T30H	17	55	23	5.52	050857
992-T 40 H	T40H	17	55	23	6.65	050864
992-T 45 H	T45H	17	55	23	7.82	050871
992-T 50 H	T50H	17	55	23	8.83	050888
992-T 55 H	T55H	18	56	23	11.22	050895





992 T SmartRail · Flexible plastic plug-in rail

Made in Germany



• Magnetic underside ensures grip on all ferrous surfaces, e.g. on tool trolleys, tool walls, machines, lifting platforms and in metal drawers

- HAZET SmartRail – Developed and produced „Made in Germany“
- Easy to clean
- Durable, robust twist lock for a tight fit and instant access
- More securely fixed when locked: turn socket left to remove
- Robust metal lug for hanging
- With 1/2" square sockets
- Surface: TIN coated



HAZET No.	l mm		EAN-No. 4000896+
992 T · · 1/2			
T30 · T40 · T45 · T50 · T55			
992 T-SR/5	245	5	245307
992 T · · 1/2			
T20 · T25 · T30 · T40 · T45 · T50 · T55 · T60			
992 T-SR/8	365	8	245376

992 LG 1/2" Screwdriver socket · TORX®

Made in Germany



- Long design
- With knurling
- Surface: TIN coated



HAZET No.	s	l ₁ mm	l ₂ mm	d mm		EAN-No. 4000896+
992 LG-T50	T50	62	100	23	8.83	103133
992 LG-T55	T55	57	96	23.3	11.22	057337
992 LG-T60	T60	45	83	23	13.25	100590
992 LG-T70	T70	67	105	24.6	15.54	047611

992 SLG 1/2" Screwdriver socket · TORX®

Made in Germany

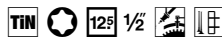

- Extra long design
- Surface: TIN coated

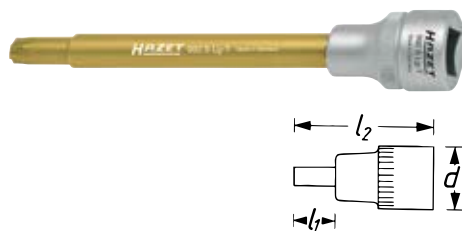

HAZET No.	s	l ₁ mm	l ₂ mm	d mm		EAN-No. 4000896+
992 SLg-T30	T30	100	138	23	5.52	179183
992 SLg-T40	T40	100	138	23	6.65	103539
992 SLg-T45	T45	100	138	23	7.82	047635
992 SLg-T50	T50	100	138	23	8.83	103454
992 SLg-T55	T55	102	138	23	11.22	047642

163 Screwdriver socket set

Made in Germany

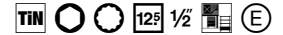

- Safety-Insert-System, 2-component soft foam insert. Insert also suitable for HAZET Assistant
- Surface: TIN coated



2/3			
-----	--	--	--

986 · · 1/2	990 · · 1/2	990 SLG · · 1/2
5 · 6 · 7 · 8 · 10	M 8 · M 10 · M 12	M 10 · M 12
12 · 14 · 17 · 19	M 14 · M 16 · M 18	
986 KK · · 1/2	990 LG · · 1/2	
6 · 7 · 8 · 10	M 8 · M 14	

HAZET No.	L x W mm		EAN-No. 4000896+
163-119/23	344x342	23	153510

Made in Germany



- Safety-Insert-System, 2-component soft foam insert. Insert also suitable for HAZET Assistant
- Surface: TIN coated



2/3			
-----	--	--	--

986 · · 1/2	990 · · 1/2	991 · · 1/2	992 · · 1/2
4 · 5 · 6 · 7	M 5 · M 6 · M 8	M 6 · M 7 · M 8	T20 · T25 · T27
8 · 9 · 10 · 12	M 10 · M 12 · M 14	M 9 · M 10 · M 12	T30 · T40 · T45
17 · 19 · 22	M 16 · M 18	M 14	T50 · T55 · T60

HAZET No.	L x W mm		EAN-No. 4000896+
163-407/35	344x342	35	199990

958 Adapter

Made in Germany



- With locking pin retaining
- Surface: chrome-plated
- DIN 3123, ISO 3316



HAZET No.	l mm	EAN-No. 4000896+
• Amplifier input 12.5 = 1/2" → output 20 = 3/4"		
958-1	50	046676
• Reducer input 12.5 = 1/2" → output 10 = 3/8"		
958-2	36	046683



Hand tools

125 1/2 Range of sockets



958 N Adapter set

Made in Germany

- 1 adapter each
- Plastic box 165-S (1/9)
- Safety-Insert-System, 2-component soft foam insert. Insert also suitable for HAZET Assistent

6.3 1/4 10 3/8 125 1/2 20 3/4 6.3 1/4
10 3/8 125 1/2 20 3/4 (E)



1/9			
-----	--	--	--

858-1 • 10 3/8 • 6.3 1/4
8858-1 • 125 1/2 • 10 3/8
8858-2 • 6.3 1/4 • 10 3/8
958-1 • 20 3/4 • 125 1/2
958-2 • 10 3/8 • 125 1/2
1058-2 • 125 1/2 • 20 3/4

HAZET No.	L x W x H mm		EAN-No. 4000896+
958 N/6	185x153x52	6	168316

163 Adapter set

Made in Germany

- Safety-Insert-System, 2-component soft foam insert. Insert also suitable for HAZET Assistent

6.3 1/4 10 3/8 125 1/2 20 3/4 6.3 1/4
10 3/8 125 1/2 20 3/4 (E)



1/9			
-----	--	--	--

858-1 • 10 3/8 • 6.3 1/4
8858-1 • 125 1/2 • 10 3/8
8858-2 • 6.3 1/4 • 10 3/8
958-1 • 20 3/4 • 125 1/2
958-2 • 10 3/8 • 125 1/2
1058-2 • 125 1/2 • 20 3/4

HAZET No.	L x W mm		EAN-No. 4000896+
163-217/6	172x114	6	168231

2250 Adapter

Made in Germany

- Inside square and inside hexagon sockets
- With locking spring to securely hold the bits
- Surface: chrome-plated

6.3 1/4 8 5/16 125 1/2



HAZET No.	l mm	EAN-No. 4000896+
□ 12.5 = 1/2" → ○ 6.3 = 1/4"		
2250-4	35	015504
□ 12.5 = 1/2" → ○ 8 = 5/16"		
2250-5	36	015511

920 1/2"→1/2" Universal joint

Made in Germany

- With hinge – for working in areas with restricted access and for getting around obstructive edges
- With locking ball
- Surface: chrome-plated, polished
- DIN 3123, ISO 3316

125 1/2 125 1/2



HAZET No.	l mm	EAN-No. 4000896+
920	70	046515

917 1/2"→1/2" Extension

Made in Germany

- With locking ball
- Surface: chrome-plated, head polished
- DIN 3123, ISO 3316

125 1/2 125 1/2



¹⁾ Length not according to DIN

HAZET No.	l mm	EAN-No. 4000896+
917-1 ¹⁾	45	046362
917-3	76	046379
917-5	123	046386

918 1/2"→1/2" Extension

Made in Germany

- With locking ball
- Surface: chrome-plated, head polished
- DIN 3123, ISO 3316

125 1/2 125 1/2



¹⁾ Length not according to DIN

HAZET No.	l mm	EAN-No. 4000896+
918-10	248	046416
918-23 ¹⁾	575	046423

919 1/2"→1/2" Wobble extension

Made in Germany

- Spherical, tapered outside square
- Angular movement to each side 12.5°

125 1/2 125 1/2

- By attaching a socket until its end stop is reached, the wobble extension may also be used as a rigid connection
- With locking ball
- Surface: chrome-plated, polished

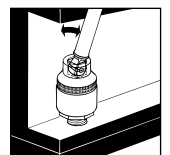

HAZET No.	l mm	EAN-No. 4000896+
919- 1	46	046447
919- 5	123	046461
919-10	248	046454



958-28 1/2" → 3/8" Adapter extension

Made in Germany

- For operating deeply located screws, e.g. on gearboxes
- With locking ball
- Surface: chrome-plated

10 3/8 12.5 1/2



HAZET No.	l mm	EAN-No. 4000896+
• Reducer □ input 12.5 = 1/2" → ■ output 10 = 3/8"		
958-28	700	046706

900 S Impact socket set

Made in Germany

- Sheet metal box (HAZET blue)
- 2-component soft foam insert

12.5 1/2 E



900 S • 12.5 1/2
13 • 14 • 16 • 17 • 18
19 • 21 • 22 • 24 • 27

900 SLG • 12.5 1/2
13 • 16 • 17 • 18 • 19
21 • 22 • 24 • 27

9006 S • 12.5 1/2 • 12.5 1/2

900 S • 12.5 1/2
900 S-HF 1530
900 S-HF 814

9005 S-5 • 12.5 1/2 • 12.5 1/2

HAZET No.	L x W x H mm	□	EAN-No. 4000896+
900 S	435x215x62	23	057153

900 S 1/2" Impact socket · hexagon

Made in Germany

- With borehole for locking pin or safety spring and groove for O-ring
- Surface: phosphatized, oiled
- DIN 3129, ISO 2725-2

12.5 1/2 E

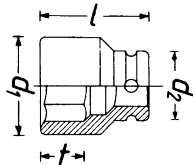

¹⁾ Not according to DIN

HAZET No.	l mm	d ₁ mm	d ₂ mm	t mm	EAN-No. 4000896+
900 S-13	38	20.8	25	10	044146
900 S-14	38	22.1	25	10	044177
900 S-15	38	23.5	30	11	044191
900 S-16	38	24.8	30	11	044214
900 S-17	38	26.2	30	12	044238
900 S-18	38	27.5	30	12	044283

900 S 1/2" Impact socket · hexagon

12.5 1/2 E

HAZET No.	l mm	d ₁ mm	d ₂ mm	t mm	EAN-No. 4000896+
900 S-19	40	28.8	30	15	044306
900 S-21	40	31.3	30	15	044368
900 S-22	40	32.5	30	15	044382
900 S-24	44	35	30	17.5	044429
900 S-25 ¹⁾	44	36.3	30	18.5	044450
900 S-27	45	38.8	30	19.5	044498
900 S-30	50	42	30	23.3	073207
900 S-32 ¹⁾	50	44	30	23	073184

900 S SmartRail · Flexible plastic plug-in rail

Made in Germany

- Magnetic underside ensures grip on all ferrous surfaces, e.g. on tool trolleys, tool walls, machines, lifting platforms and in metal drawers

12.5 1/2 E

- HAZET SmartRail – Developed and produced „Made in Germany“
- Easy to clean
- Durable, robust twist lock for a tight fit and instant access
- More securely fixed when locked: turn socket left to remove
- Robust metal lug for hanging
- With 1/2" square sockets

HAZET SMART RAIL

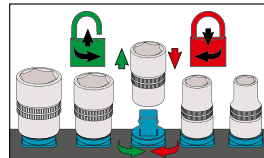

HAZET No.	l mm	□	EAN-No. 4000896+
900 S • 12.5 1/2 13 • 17 • 19 • 22 • 24			
900 S-SR/5	245	5	245260
900 S • 12.5 1/2 13 • 17 • 18 • 19 • 21 • 22 • 24 • 27			
900 S-SR/8	365	8	245345

900 SK 1/2" Impact socket set

Made in Germany

- Particularly suitable together with short impact wrenches e.g. HAZET 9012ATT · 9012A-1 · 9012M · 9012M-1 · 9012MT

12.5 1/2 E

- Extra short design
- With borehole for locking pin or safety spring and groove for O-ring
- Surface: phosphatized, oiled
- DIN 3129, ISO 2725-2



900 SK • 12.5 1/2
13 • 17 • 19 • 21



HAZET No.	l mm	□	EAN-No. 4000896+
900 SK/4	29	4	201785



Hand tools

125 1/2 Range of sockets



900 SK 1/2" Impact socket set

Made in Germany

Particularly suitable together with short impact wrenches e.g. HAZET 9012ATT · 9012A-1 · 9012M · 9012M-1 · 9012MT

Extra short design

- With borehole for locking pin or safety spring and groove for O-ring
- Surface: phosphatized, oiled
- DIN 3129, ISO 2725-2



1/9				
-----	--	--	--	--



900 SK · 1/2" · 13 · 14 · 15 · 16 · 17 · 18 · 19 · 21 · 22 · 24

HAZET No.		EAN-No. 4000896+
900 SK/10	10	246434

900 SK 1/2" Impact socket · hexagon

Made in Germany

Extra short design

- With borehole for locking pin or safety spring and groove for O-ring
- Surface: phosphatized, oiled
- DIN 3129, ISO 2725-2

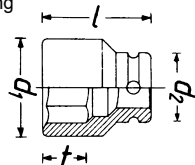

HAZET No.	l mm	d ₁ mm	d ₂ mm	t mm	EAN-No. 4000896+
900 SK-13	29	20.8	25	7	201747
900 SK-14	29	22.1	25	7	246380
900 SK-15	29	23.5	30	7.2	246373
900 SK-16	29	24.8	30	7.2	246397
900 SK-17	29	26.2	30	7.2	201754
900 SK-18	29	27.5	30	8.7	246403
900 SK-19	29	28.8	30	11	201761
900 SK-21	29	31.3	30	11.5	201778
900 SK-22	29	32.5	30	12.3	246410
900 SK-24	29	35	30	12.2	246427

900 SLG 1/2" Impact socket · hexagon

Made in Germany

- Long design
- With borehole for locking pin or safety spring and groove for O-ring
- Surface: phosphatized, oiled
- DIN 3129, ISO 2725-2

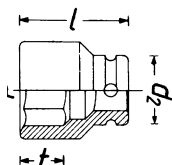

900 SLG 1/2" Impact socket · hexagon

Reinforced design, with deep hexagon profile for wheel nuts/bolts

HAZET No.	l mm	d ₁ mm	d ₂ mm	t mm	EAN-No. 4000896+
900 SLg-13	85	20.8	25	13	044764
900 SLg-15	85	23.5	30	18	104277
900 SLg-16	85	24.8	30	16	044788
900 SLg-17	85	26.2	30	18.5	044801
900 SLg-18	85	27.5	30	19	044825
900 SLg-19	85	28.8	30	19.5	044849
900 SLg-21 ¹⁾	85	31.3	30	17.5	044863
900 SLg-22	85	32.5	30	22	044887
900 SLg-24	85	35	30	19.5	044917
900 SLg-27	85	38.8	30	29	044931

900 SLG6 1/2" Impact socket · hexagon

Made in Germany

Operation via impact adapter e.g. HAZET 1003S-1 or nut-drivers ≤ 24 mm enables high force transmission thanks to optimal 20 mm = 3/4" drive

- For operating wheel bolts/nuts on small commercial vehicle transporters e.g. FIAT Ducato · PEUGEOT Jumper
- Long design
- With borehole for locking pin or safety spring and groove for O-ring
- DIN 3129, ISO 2725-2



HAZET No.	l mm	d ₁ mm	d ₂ mm	t mm	EAN-No. 4000896+
900 SLg6-24	85	35	26.9	25	232789

900 SLG 1/2" Impact socket · hexagon

Made in Germany

- Releasing tool can be used on both sides on **FORD** models
- If the chrome cover is missing or damaged, the wheel nut can no longer be operated with the normal socket
- Solution: Two double sockets instead of four single sockets
- Operation with **917S-3**
- Surface: phosphatized, oiled
- Square according to DIN 3120
- Releasing tool, can be used on both sides, e.g. on **FORD** models B-Max · C-Max · EcoSport · Fiesta · Focus · Grand C-Max · KA · Kuga · Mondeo · Puma · Ranger · Tourneo · Transit **Volvo** V40 · C30
- ≤ 18 mm (=d₁) for use without chrome cover
- ≤ 20 mm (=d₂) for use with damaged / deformed chrome cover



HAZET No.	l mm	d ₁ mm	d ₂ mm	t mm	EAN-No. 4000896+
900 SLg-18x20	50	27.5	29	17	241934



900 SLG 1/2" Impact socket · hexagon

Made in Germany

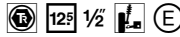

- Releasing tool can be used on both sides on **FORD** models
- If the chrome cover is missing or damaged, the wheel nut can no longer be operated with the normal socket
- Solution: Two double sockets instead of four single sockets
- Operation with **917S-3**
- Surface: phosphatized, oiled
- Square according to DIN 3120
- **Releasing tool**, can be used on both sides, e.g. on **FORD** models S-Max · Galaxy · Transit · Tourneo Connect · Tourneo Custom · Mustang
- $s \leq 20$ mm (=d1) for use without chrome cover
- $s \leq 22$ mm (=d2) for use with damaged / deformed chrome cover

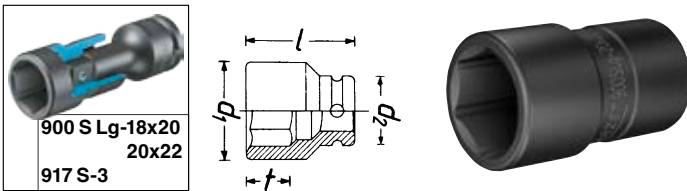

HAZET No.	l mm	d ₁ mm	d ₂ mm	f mm	EAN-No. 4000896+
900 SLG-20 x 22	53	29	32.5	17	246236

Made in Germany

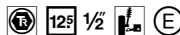

- Releasing tool can be used on both sides on **FORD** models
- If the chrome cover is missing or damaged, the wheel nut can no longer be operated with the normal socket
- Solution: Two double sockets instead of four single sockets
- Operation with **917S-3**
- Surface: phosphatized, oiled
- Square according to DIN 3120
- **3-piece set including extension 917S-3** for example for **FORD** models B-Max · C-Max · EcoSport · Fiesta · Focus · Grand C-Max · KA · Kuga · Mondeo · Puma · Ranger · Tourneo · Transit · S-Max · Galaxy · Transit · Tourneo Connect · Tourneo Custom · Mustang

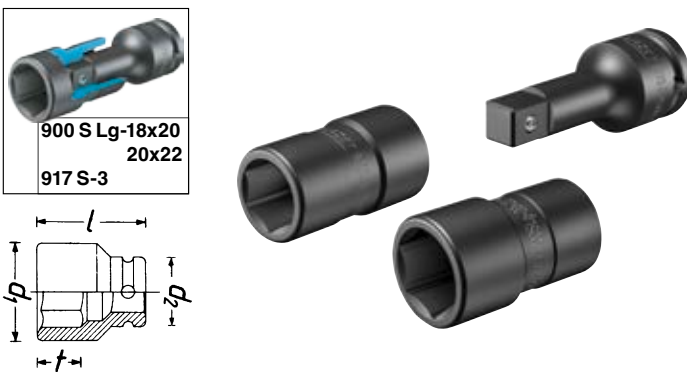

HAZET No.	l mm	EAN-No. 4000896+
900 SLG-1822/3	3	246274



900 SLG SmartRail · Flexible plastic plug-in rail

Made in Germany

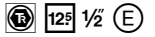

- **Magnetic underside ensures grip on all ferrous surfaces, e.g. on tool trolleys, tool walls, machines, lifting platforms and in metal drawers**
- HAZET SmartRail – Developed and produced „Made in Germany“
- Easy to clean
- Durable, robust twist lock for a tight fit and instant access
- More securely fixed when locked: turn socket left to remove
- Robust metal lug for hanging
- With 1/2" square sockets



HAZET No.	l mm	□	EAN-No. 4000896+
900 SLG · 12 ⁵ 1/2 · 13 · 17 · 19 · 22 · 24			
900 SLG-SR/5	245	5	245277

9005 S 1/2" → 1/2" Impact extension

Made in Germany



- Especially for 900SLG-18x20 · 900SLG-20x22
- With borehole for locking pin or safety spring and groove for O-ring, With locking ball
- Surface: phosphatized, oiled



HAZET No.	l mm	EAN-No. 4000896+
917S-3	75	241927

901 SLG 1/2" Impact socket · hexagon

Made in Germany

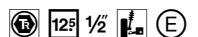

- Especially for wheel mounting or dismounting
- Extra slim style
- Long design
- With borehole for locking pin or safety spring and groove for O-ring
- Surface: phosphatized, oiled
- DIN 3129, ISO 2725-2

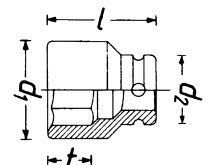

HAZET No.	l mm	d ₁ mm	d ₂ mm	f mm	EAN-No. 4000896+
901 SLG-17	85	25.7	30	18.5	045723
901 SLG-19	85	28.2	30	19	045747
901 SLG-21	85	29.5	30	19.5	118304



Hand tools

125 1/2 Range of sockets



902 SLG 1/2" Impact socket · hexagon

Made in Germany

• Plastic insert to protect the surface of the wheel bolts

- Extra slim style
- Long design
- With borehole for locking pin or safety spring and groove for O-ring
- DIN 3129, ISO 2725-2

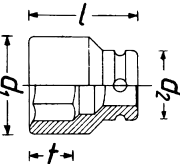

HAZET No.	l mm	d ₁ mm	d ₂ mm	f mm	EAN-No. 4000896+
902 SLg-17	85	25.7	30	18	045778

903 SLG 1/2" Impact socket · hexagon

Made in Germany

• Plastic insert to protect the surface of the wheel bolts
• Additionally with outside plastic sleeve (replaceable) to protect the rims when screwing the wheel bolts

- Colour-coded plastic sleeve facilitates finding the correct size
- Long design
- With borehole for locking pin or safety spring and groove for O-ring
- Surface: phosphatized, oiled



YouTube Clip

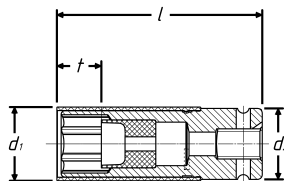

HAZET No.	l mm	d ₁ mm	d ₂ mm	f mm	EAN-No. 4000896+
• Particularly for Smart For Two • Grey plastic sleeve (non-rotatable) 903 SLg-15	85	26	30	14	072231
• Optimised contours for deeper rim holes in e.g. AUDI S-Line, AMG, OZ etc. • Plastic sleeve blue (rotatable) 903 SLg-17	85	28.4	30	14	045822
• Yellow plastic sleeve (rotatable) 903 SLg-19	85	30.8	30	18	045839
• Especially for alloy rims for TESLA, TOYOTA, MAZDA and KIA and SMART For-Four • Optimised plastic insert, internal, for holding the cap nuts and for use of the entire profile length • Red plastic sleeve (rotatable) 903 SLg-21	85	31.5	30	17	055135
• Especially for aluminium rims on OPEL Insignia • Green plastic sleeve (non-rotatable) Without plastic insert 903 SLg-22	85	30.5	30	22	155453

903 SLG SmartRail · Flexible plastic plug-in rail

Made in Germany

• Magnetic underside ensures grip on all ferrous surfaces, e.g. on tool trolleys, tool walls, machines, lifting platforms and in metal drawers

- HAZET SmartRail – Developed and produced „Made in Germany“
- Easy to clean
- Durable, robust twist lock for a tight fit and instant access
- More securely fixed when locked: turn socket left to remove
- Robust metal lug for hanging
- With 1/2" square sockets

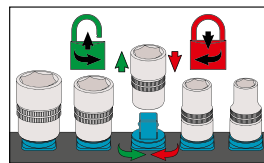

HAZET No.	l mm	□	EAN-No. 4000896+
903 SLG · □ · □ · 125 1/2 19 · 17			
903 SLg-SR/5	245	5	245253

903 SPC 1/2" Impact socket set

Made in Germany

• Plastic insert to protect the surface of the wheel bolts
• Outside plastic sleeve (replaceable) to protect the rims when screwing the wheel bolts

- Colour-coded plastic sleeve, for quickly finding the correct size
- Wrench sizes 17 · 19 · 21 mm
- Long design
- With borehole for locking pin or safety spring and groove for O-ring



903 SLG · □ · □ · 125 1/2
17 · 19 · 21



HAZET No.	□	EAN-No. 4000896+
903 SPC/3	3	128754

903 SLG 1/2" Impact socket set

Made in Germany

• 3 sockets each in a practical storage box
• Surface: phosphatized, oiled



YouTube Clip

HAZET No.	l mm	□	EAN-No. 4000896+
903SLG-17 (3x)			
903 SLg-17/3	85	3	191697
903SLG-19 (3x)			
903 SLg-19/3	85	3	191734



903 SLG6 1/2" Impact socket · hexagon

Made in Germany

• Operation via impact adapter e.g. HAZET 1003S-1 or nut-drivers ≤ 24 mm enables high force transmission thanks to optimal 20 mm = $3/4$ " drive

- Hexagon on the socket wrench insert enables adaptation to 20 mm = $3/4$ " drive
- **Rotating outside plastic sleeve** (replaceable) to protect the rims when screwing the wheel bolts
- Colour-coded plastic sleeve facilitates finding the correct size
- **Plastic insert** to protect the surface of the wheel bolts
- Long design
- With borehole for locking pin or safety spring and groove for O-ring
- DIN 3129, ISO 2725-2

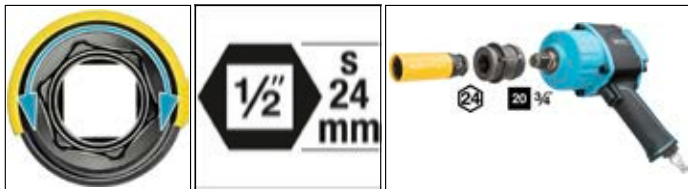
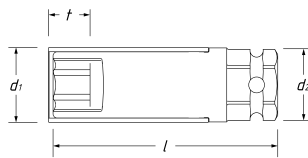

HAZET No.	l mm	d ₁ mm	d ₂ mm	t mm	EAN-No. 4000896+
• Plastic sleeve blue					
903 SLg 6-17	85	28.4	27	14	223596
• Plastic sleeve yellow					
903 SLg 6-19	85	30.8	27	18	223589

903 SLG6 1/2" Impact socket set

Made in Germany

• Operation via impact adapter e.g. HAZET 1003S-1 or nut-drivers ≤ 24 mm enables high force transmission thanks to optimal 20 mm = $3/4$ " drive

- Hexagon on the socket wrench insert enables adaptation to 20 mm = $3/4$ " drive
- **Rotating outside plastic sleeve** (replaceable) to protect the rims when screwing the wheel bolts
- Colour-coded plastic sleeve facilitates finding the correct size
- **Plastic insert** to protect the surface of the wheel bolts
- Long design
- With borehole for locking pin or safety spring and groove for O-ring
- DIN 3129, ISO 2725-2

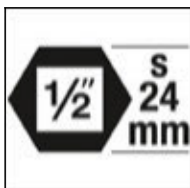

903 SLG6 · 125 1/2 · 17 · 19

1000 S · 20 3/4
1000 S-G 1736
1000 S-H 1736

1003 S-1 · 20 3/4

HAZET No.	5	EAN-No. 4000896+
903 SLg 6/5	5	223602

904 SLG 1/2" Impact socket · hexagon · extra long

Made in Germany

• **Plastic insert** to protect the surface of the wheel bolts

- Safe distance from fender when screwing closed with HAZET torque wrench – no extension necessary
- Outside plastic sleeve (rotatable) to protect the rim
- **Extra long design**
- With borehole for locking pin or safety spring and groove for O-ring

125 1/2

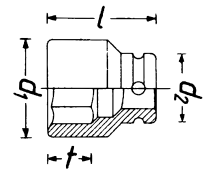
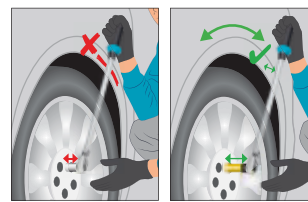

HAZET No.	l mm	d ₁ mm	d ₂ mm	t mm	EAN-No. 4000896+
Especially for wheel mounting and dismounting on AMG rims and/or alloy sports rims with deeply located wheel bolts					
904 SLg-17	130	28.3	30	18.3	100576
Particularly suitable for wheel mounting and assembly on SUVs e.g. PORSCHE Cayenne, Macan, AUDI Q7, Q5, VW Touareg					
904 SLg-19	130	30.8	30	18	203710

905 SLG 1/2" Impact socket · hybrid special profile

Made in Germany

• **Optimised external contour** for better protection of deep rim holes

- Application: Especially for wheel mounting and dismounting of **light-alloy rims for hybrid wheel bolts in all new MERCEDES-BENZ vehicles**
- **Plastic insert** to protect the surface of the wheel bolts
- **Rotating outside plastic sleeve** to protect the rims when screwing the wheel bolts – no aluminium corrosion through prevention of scratches
- Long design
- With borehole for locking pin or safety spring and groove for O-ring
- On e.g. **MERCEDES-BENZ** C-Class type 204, 204X · E-Class type 211, 212, 207 · SLK type 172 · M-Class type 164, 166 · S-Class type 221, 222 · CL-Class type 216

125 1/2

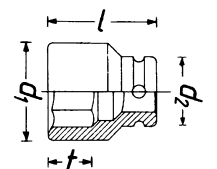

HAZET No.	l mm	d ₁ mm	d ₂ mm	t mm	EAN-No. 4000896+
905 SLg-17	86	28.4	30	18	198795



Hand tools

125 1/2 Range of sockets



905 SLG 1/2" Impact socket · special profile

Made in Germany

- Plastic insert to protect the surface of the wheel bolts
- Rotating outside plastic sleeve to protect the rims when screwing the wheel bolts – no aluminium corrosion through prevention of scratches

- Long design
- With borehole for locking pin or safety spring and groove for O-ring
- Wheel nuts with special profile ≤ 21 mm on **HYUNDAI** i30, Tucson and **KIA**

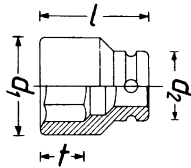

HAZET No.	l mm	d ₁ mm	d ₂ mm	t mm	EAN-No. 4000896+
905 SLg-21	86.8	31	30	19.8	201624

900 SLG Plastic sleeve

Made in Germany

HAZET No.	EAN-No. 4000896+
• Plastic sleeve blue · for 903SLg-17	
903 SLg-017	045808
• Plastic sleeve yellow · for 903SLg-19	
903 SLg-019	045815
• Plastic sleeve red · for 903SLg-21	
903 SLg-021	055692
• Plastic sleeve green · for 903SLg-22	
903 SLg-022	155255
• Plastic sleeve white · for 904SLg-17	
904 SLg-017	203352
• Plastic sleeve yellow · for 904SLg-19	
904 SLg-019	205523
• Plastic sleeve white · for 905SLg-17	
905 SLg-017	203833
• Plastic sleeve orange · for 905SLg-21	
905 SLg-021	203345

900 SZ 1/2" Impact socket set

Made in Germany

- Surface: phosphatized, oiled
- DIN 3129, ISO 2725-2



HAZET No.	EAN-No. 4000896+
900 SZ/4	156375

900 SZ 1/2" Impact socket · 12-point

Made in Germany

- With borehole for locking pin or safety spring and groove for O-ring
- Surface: phosphatized, oiled
- DIN 3129, ISO 2725-2

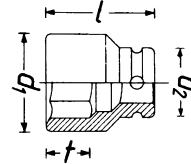

HAZET No.	l mm	d ₁ mm	d ₂ mm	t mm	EAN-No. 4000896+
900 SZ-12	38	19.5	25	6.8	061785
900 SZ-13	38	20.8	25	6.8	061792
900 SZ-14	38	22.1	25	9.3	061808
900 SZ-15	38	23.5	30	9.3	061815
900 SZ-16	38	24.8	30	9.2	061822
900 SZ-17	38	26.2	30	9.2	061839
900 SZ-18	38	27.5	30	10.7	061846
900 SZ-19	40	28.8	30	11.6	061853
900 SZ-21	40	30	31.3	11.7	075362
900 SZ-22	40	30	32.5	11.7	075379
900 SZ-24	44	35	30	17.5	115556
900 SZ-27	45	38.8	30	17.9	115822
900 SZ-30	50	42	30	23.3	086573
900 SZ-32	50	44.5	30	22.2	115921
900 SZ-34	55	47.5	30	22.2	116034
900 SZ-36	60	50	30	25	100132

HAZET No.	s mm	l mm	d ₁ mm	d ₂ mm	t mm	EAN-No. 4000896+
3047-36	36	60	47	30	25	190683

900 SZ6 1/2" Impact socket · 12-point

Made in Germany

- Operation via impact adapter e.g. HAZET 1003S-1 or nut-drivers ≤ 24 mm enables high force transmission thanks to optimal 20 mm = 3/4" drive

- Hexagon on the socket wrench insert enables adaptation to 20 mm = 3/4" drive
- Short design
- With borehole for locking pin or safety spring and groove for O-ring
- 2-component soft foam insert
- Surface: phosphatized, oiled
- Similar to DIN 3129, ISO 2725-2



HAZET No.	EAN-No. 4000896+
900 SZ6/11	225378



900 SZ6 1/2" Impact socket · 12-point

Made in Germany

• Operation via impact adapter e.g. HAZET 1003S-1 or nut-drivers ≤ 24 mm enables high force transmission thanks to optimal 20 mm = $\frac{3}{4}$ " drive

- Hexagon on the socket wrench insert enables adaptation to 20 mm = $\frac{3}{4}$ " drive
- Short design
- With borehole for locking pin or safety spring and groove for O-ring
- Surface: phosphatized, oiled
- Similar to DIN 3129, ISO 2725-2

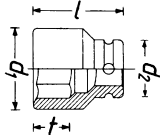
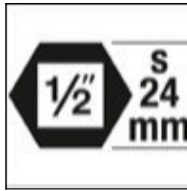

HAZET No.	l mm	d ₁ mm	d ₂ mm	t mm	EAN-No. 4000896+
• Operation of the crankshaft bolt connection to DACIA · FORD · INFINITI · SUZUKI · MERCEDES-BENZ · NISSAN · OPEL/VAUXHALL · RENAULT · Volvo					
900 SZ 6-18	40	30	27	10.7	246267
900 SZ 6-19	40	30.5	27	11.6	225293
900 SZ 6-21	40	32.5	27	11.7	225309
900 SZ 6-22	40	32.5	27	11.7	225316
900 SZ 6-24	44	36	27	17.5	225323
900 SZ 6-27	45	40	27	17.9	225330
900 SZ 6-30	50	43	27	23.3	225347
900 SZ 6-32	50	45	27	22.2	225354
• Axle shaft nut operation on – BMW 3 series · 5 series · 7 series · Z3 · M3 · VW Polo model year 2001 → · SEAT Ibiza model year 2002 → – VW Golf Plus 1.9 TDi model year 2005 → · Polo 5					
• Hub screw connection on the front axle RENAULT Twingo 3 and SMART (453) Fortwo / Forfour model year 2014 →					
900 SZ 6-36	60	50	27	25	225361

900 S-E 1/2" Impact socket · TORX®

Made in Germany

- With borehole for locking pin or safety spring and groove for O-ring
- Surface: phosphatized, oiled

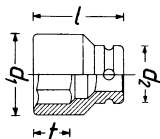

HAZET No.	s	l mm	d ₁ mm	d ₂ mm	mm	EAN-No. 4000896+
900 S-E 10	E10	38	14	25	9.42	044542
900 S-E 12	E12	38	15.9	25	11.17	044566
900 S-E 14	E14	38	17.7	25	12.90	044580
900 S-E 16	E16	38	20	25	14.76	044603
900 S-E 18	E18	38	22	30	16.70	044627
900 S-E 20	E20	38	24.5	30	18.49	044641
900 S-E 24	E24	41.2	30	30	22.16	044665

985 S 1/2" Impact screwdriver socket

Made in Germany

- Drive optionally with $\square 12.5$ mm = $\frac{1}{2}$ " or $\bullet 24$ mm,
- Optionally with adapter HAZET 1003S-1
- Short design
- With borehole for locking pin or safety spring and groove for O-ring
- Surface: phosphatized, oiled



985 S 1/2" Impact screwdriver socket

12⁵ 1/2 (E)

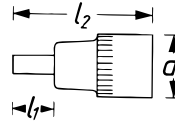

HAZET No.	S mm	l ₁ mm	l ₂ mm	EAN-No. 4000896+
985 S-14	14	9	45	211968
985 S-17	17	11	45	211975
985 S-19	19	13	45	211982
985 S-22	22	20.5	45	218219
985 S-24	24	–	45	218226

Made in Germany

- Drive optionally with $\square 12.5$ mm = $\frac{1}{2}$ " or $\bullet 24$ mm,
- Optionally with adapter HAZET 1003S-1
- Long design
- With borehole for locking pin or safety spring and groove for O-ring
- Surface: phosphatized, oiled

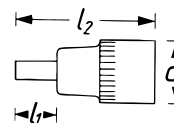
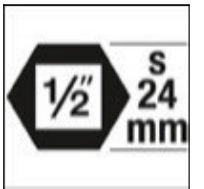

HAZET No.	S mm	l ₁ mm	l ₂ mm	EAN-No. 4000896+
985 S-14 LG	14	9	75	211999
985 S-17 LG	17	11	75	212002
985 S-19 LG	19	13	75	212019

Made in Germany

- $\square 20$ = $\frac{3}{4}$ " drive allows transmission of high separation forces

- Drive optionally with $\square 12.5$ mm = $\frac{1}{2}$ " or $\bullet 24$ mm,
- Optionally with adapter HAZET 1003S-1
- With borehole for locking pin or safety spring and groove for O-ring
- Surface: phosphatized, oiled
- Contents:
s 14, 17, 19 mm in short and long style
1 adapter 20 = $\frac{3}{4}$ " on s 24 mm
2 locking pins
2 O-rings



Video



985 S · $\square 12.5$ mm
14 · 17 · 19

1000 S · $\square 12.5$ mm
1000 S-G 1736
1000 S-H 1736

985 S · $\square 12.5$ mm
14 · 17 · 19

1003 S-1 · $\square 12.5$ mm



HAZET No.		EAN-No. 4000896+
985 S/11	11	211951



Hand tools

125 1/2 Range of sockets



990 S 1/2" Impact screwdriver socket

Made in Germany

- Choice of □ drive 12.5 = 1/2" or ● 24 mm
- Short design
- With borehole for locking pin or safety spring and groove for O-ring
- Surface: phosphatized, oiled

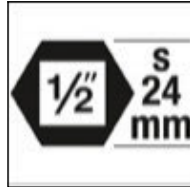
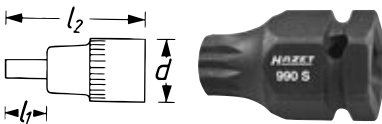
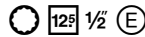

HAZET No.	S	l ₁ mm	l ₂ mm	EAN-No. 4000896+
VW Passat 3C rear brake carrier screw connection and front shock absorber screw connection, VW T4 lower supporting joint. Holding up the shock absorber in VW Golf 5, 6, Polo 9N, 9N2, AUDI A3 type 8P, TT and SEAT León				
990 S-14	M14	4	43	160846
Brake system, camshaft drive wheel and rear brake callipers e.g. VW Touareg and Phaeton				
990 S-16	M16	5	43	160853
Installation and removal of the wheel bearing / hub unit e.g. VW Touran, model year 2004 →, AUDI A3, model year 2004 →, Golf 5 and identical ŠKODA				
990 S-18	M18	6	43	160860

Made in Germany

- Choice of □ drive 12.5 = 1/2" or ● 24 mm
- Long design
- With borehole for locking pin or safety spring and groove for O-ring
- Surface: phosphatized, oiled

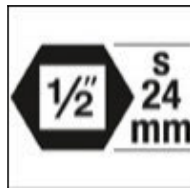
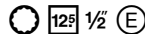

HAZET No.	S	l ₁ mm	l ₂ mm	EAN-No. 4000896+
Rear brake carrier screw connection and front shock absorber connection VW Passat 3C Flywheel MB 541-542-904 Holding up the shock absorber in VW Golf 5, 6, Polo 9N, 9N2, AUDI A3 type 8P, TT, SEAT León				
990 S-14 LG	M14	39.7	75	161003
Brake system, camshaft drive wheel and rear brake callipers e.g. VW T5 model year 2004 → 2.5 TDI engine code: AXD, BNZ, Touareg model year 2003 → engine code: BAC, BPE and Phaeton, Atego flywheel.				
990 S-16 LG	M16	40.6	75	161010
Chassis and for installation and removal of the wheel bearing/ hub unit e.g. VW Touran, model year 2004 →, AUDI A3, model year 2004, Golf 5 and identical ŠKODA				
990 S-18 LG	M18	41.1	75	161027

990 S 3/4" 1/2" Impact screwdriver socket set

Made in Germany

- 20 = 3/4" drive allows transmission of high separation forces



- Choice of □ drive 12.5 = 1/2" or ● 24 mm
- With borehole for locking pin or safety spring and groove for O-ring
- Safety-Insert-System, 2-component soft foam insert. Insert also suitable for HAZET Assistant
- Surface: phosphatized, oiled
- Installation and removal of the wheel bearing / hub unit
- For e.g. AUDI A3 model year 2004 →, VW Touran model year 2004 →, Golf 5 model year 2003 →, ŠKODA Octavia model year 2008 →, SEAT León model year 2005 →
- 990S-14: VW Passat 3C rear brake carrier screw connection and front shock absorber screw connection, VW T4 lower supporting joint.
Holding up the shock absorber in VW Golf 5, 6, Polo 9N, 9N2, AUDI A3 type 8P, TT and SEAT León
- 990S-16: brake system, camshaft drive wheel and rear brake callipers e.g. VW Touareg and Phaeton
- 990S-18 Installation and removal of the wheel bearing / hub unit e.g. VW Touran, model year 2004 →, AUDI A3, model year 2004 →, Golf 5 and identical ŠKODA
- 990S-14LG: rear brake carrier screw connection and front shock absorber connection VW Passat 3C
Flywheel MB 541-542-904
- Holding up the shock absorber in VW Golf 5, 6, Polo 9N, 9N2, AUDI A3 type 8P, TT, SEAT León
- 990S-16LG: brake system, camshaft drive wheel and rear brake callipers e.g. VW T5 model year 2004 → 2.5 TDI engine code: AXD, BNZ, Touareg model year 2003 → engine code: BAC, BPE and Phaeton, Atego flywheel
- 990S-18LG: chassis and for installation and removal of the wheel bearing/hub unit e.g. VW Touran, model year 2004 →, AUDI A3, model year 2004, Golf 5 and identical ŠKODA

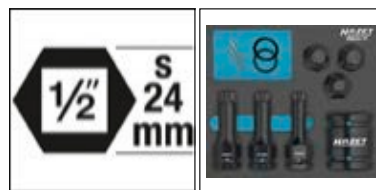

Video



HAZET No.		EAN-No. 4000896+
990 S/11	11	162406





995 S 1/2" Impact screwdriver socket · TORX®

Made in Germany

- Short design
- With borehole for locking pin or safety spring and groove for O-ring
- Surface: phosphatized, oiled

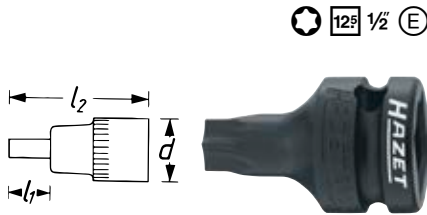

HAZET No.	S	l ₁ mm	l ₂ mm	d mm	⌀ mm	EAN-No. 4000896+
995 S-T30	T30	21.4	40	25.1	5.52	047666
995 S-T40	T40	21.1	40	25.1	6.65	047680
995 S-T45	T45	21.1	40	25.1	7.82	057597
995 S-T50	T50	22.4	40	25.1	8.83	047703
995 S-T55	T55	22.4	40	25.1	11.22	047727
995 S-T60	T60	22.1	40	25.1	13.25	047741

9007 S Impact adapter

Made in Germany

- With borehole for locking pin or safety spring and groove for O-ring
- Surface: phosphatized, oiled
- DIN 3121



HAZET No.	l mm	EAN-No. 4000896+
• Reducer □ input 12.5 = 1/2" → ■ output 10 = 3/8"		
9007 S	37	072545
• Amplifier □ input 12.5 = 1/2" → ■ output 20 = 3/4"		
9007 S-1	49	043217

9006 S 1/2" → 1/2" Impact ball joint

Made in Germany

- With hinge – for working in areas with restricted access and for getting around obstructive edges
- With borehole for locking pin or safety spring and groove for O-ring
- Surface: burnished, oiled
- DIN 3121



HAZET No.	l mm	EAN-No. 4000896+
• Angular movement 25°		
9006 S	69	043170

9005 S 1/2" → 1/2" Impact extension

Made in Germany

- With borehole for locking pin or safety spring and groove for O-ring
- Surface: phosphatized, oiled
- DIN 3121



HAZET No.	l mm	EAN-No. 4000896+
9005 S-5	130	043163

900 S O-ring and connecting pin

Made in Germany



HAZET No.	mm	EAN-No. 4000896+
• O-ring for sockets □ 12.5 = 1/2" 8 – 14 mm, 13 mm long style, E10 – E16, T30 – T60		
900 S-G 1014	∅ 19x4	044689
• O-ring for sockets □ 12.5 = 1/2" 15 – 36 mm, 16 – 27 mm long style, E18 – E24, extensions, universal joints, adapters		
900 S-G 1527	∅ 24x4	044696
• Connecting pin for sockets □ 12.5 = 1/2" 8 – 14 mm 13 mm long style · E10 – E16 T 30 – T60		
900 S-H 1014	∅ 3x20	044702
• Connecting pin for sockets □ 12.5 = 1/2" 15 – 36 mm · 16 – 27 mm long style E18 – E24 extensions · universal joints · connectors		
900 S-H 1527	∅ 3x26	044719

900 S Safety spring

Made in Germany

- For machine-operated sockets in accordance with DIN 3129



HAZET No.	mm	EAN-No. 4000896+
• Safety spring for sockets □ 12.5 = 1/2" 8 – 14 mm · E10 – E16 For 900S		
900 S-HF 814	∅ 21x1.5	044733
• Safety spring for sockets □ 12.5 = 1/2" 15 – 36 mm · E18 – E24 extensions · universal joints · adapters		
900 S-HF 1530	∅ 25x1.5	044726

9005 S 1/2" → 1/2" Impact extension

Made in Germany

- Especially for 900SLG-18x20 · 900SLG-20x22
- With borehole for locking pin or safety spring and groove for O-ring, With locking ball
- Surface: phosphatized, oiled



HAZET No.	l mm	EAN-No. 4000896+
917 S-3	75	241927



Hand tools

20 3/4" Range of sockets



20 3/4" Range of sockets

1000 Socket set

Made in Germany

- Sheet metal box (HAZET blue)
- 2-component soft foam insert

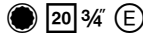

1000 • ● • 20 3/4"
22 • 24 • 27 • 30 • 32
36 • 38 • 41 • 46 • 50

1014



1015-1 • 20 3/4"



1016 • 20 3/4"



1017-8 • 20 3/4" • 20 3/4"



1018 • 20 3/4" • 20 3/4"

HAZET No.	L x W x H mm		EAN-No. 4000896+
1000	578x235x88	15	000616

1002 Socket set

Made in Germany

- Sheet metal box (HAZET blue)
- 2-component soft foam insert

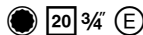

1000 • ● • 20 3/4"
22 • 24 • 27 • 30
32 • 36 • 38 • 41
46 • 50 • 55 • 60

1014



1015-1 • 20 3/4"



1016 • 20 3/4"



1017-8 • 20 3/4" • 20 3/4"



1018 • 20 3/4" • 20 3/4"



1021 • 20 3/4" • 20 3/4"

HAZET No.	L x W x H mm		EAN-No. 4000896+
1002	578x235x88	18	001736

1000Z Socket set

Made in Germany

- With 12-point sockets
- Sheet metal box (HAZET blue)
- 2-component soft foam insert

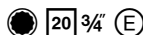

1000Z Socket set

Made in Germany

- With 12-point sockets
- Sheet metal box (HAZET blue)
- 2-component soft foam insert

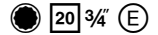

1000Z • ● • 20 3/4"
22 • 24 • 27 • 30 • 32
36 • 38 • 41 • 46 • 50

1014



1015-1 • 20 3/4"



1016 • 20 3/4"



1017-8 • 20 3/4" • 20 3/4"



1018 • 20 3/4" • 20 3/4"

HAZET No.	L x W x H mm		EAN-No. 4000896+
1000Z	578x235x88	15	001477

1002Z Socket set

Made in Germany

- With 12-point sockets
- Sheet metal box (HAZET blue)
- 2-component soft foam insert

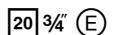

1000Z • ● • 20 3/4"
22 • 24 • 27 • 30 • 32
36 • 38 • 41 • 46 • 50



1000 • ● • 20 3/4"
55 • 60

1014



1015-1 • 20 3/4"



1016 • 20 3/4"

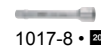

1017-8 • 20 3/4" • 20 3/4"



1018 • 20 3/4" • 20 3/4"



1021 • 20 3/4" • 20 3/4"

HAZET No.	L x W x H mm		EAN-No. 4000896+
1002Z	578x235x88	18	001743

1000AZ Socket set

Made in Germany

- With 12-point sockets
- American dimensions
- Sheet metal box (HAZET blue)
- 2-component soft foam insert

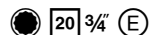

1000AZ • ● • 20 3/4"
7/8 • 15/16 • 1 • 1 1/16
1 1/8 • 1 3/16 • 1 1/4 • 1 5/16
1 3/8 • 1 7/16 • 1 1/2 • 1 5/8
1 3/4 • 1 13/16 • 1 7/8 • 2

1014



1015-1 • 20 3/4"

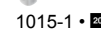

1016 • 20 3/4"



1017-8 • 20 3/4" • 20 3/4"



1018 • 20 3/4" • 20 3/4"

HAZET No.	L x W x H mm		EAN-No. 4000896+
1000AZ	578x235x88	21	000982



1016 3/4" Reversible ratchet head

Made in Germany

20 3/4" (E)

- Number of teeth: 32 (Opening angle 11.25°)
- Shank with bolt for locking pin retaining, output with locking pin retaining
- Surface: chrome-plated
- DIN 3122, ISO 3315



HAZET No.	l mm	EAN-No. 4000896+
1016	165	001941

Wear? – No problem!

- HAZET tools are manufactured to the **highest quality**. During long intensive loading there is a certain level of wear even for high-quality tools.
- For this reason, there are spare parts and replacement sets available for many of our tools.

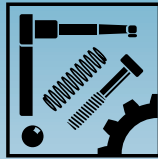

Please also see our spare parts shop
www.hazet.de/ersatzteil-shop

Cost-saving – Sustainable – Resource-saving!
For long-term pleasure with your HAZET tools

1016 Replacement set

Made in Germany

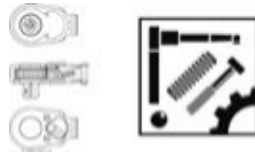

HAZET No.	EAN-No. 4000896+
<ul style="list-style-type: none"> • Replacement set for shift lever consisting of: shift lever · screws · ball · compression spring For HAZET reversible ratchet 1016 · 1016/2 For HAZET torque wrench 5143-3CT · 5145-3CT · 6132-1CT · 6143CT · 6143-1CT · 6144CT · 6144-1CT · 6145CT · 6145-1CT · 6146-1CT 	001972
<ul style="list-style-type: none"> • Replacement set for ratchet wheel 20 3/4" consisting of: ratchet wheel · pawl · shift lever · screws · ball · compression spring For HAZET reversible ratchet 1016 · 1016/2 For HAZET torque wrench 5145-3CT · 6132-1CT · 6143CT · 6143-1CT · 6144CT · 6144-1CT · 6145CT · 6145-1CT · 6146-1CT 	001989

1016 3/4" Reversible ratchet head · with handle bar

Made in Germany

20 3/4" (E)

- Number of teeth: 32 (Opening angle 11.25°)
- Shank with bolt for locking pin retaining, output with locking pin retaining
- Surface: chrome-plated, polished



HAZET No.	l mm	EAN-No. 4000896+
1016/2	620	001965

1015 Sliding head · with handle bar

Made in Germany

20 3/4"

- Handle bar HAZET 1014 and sliding head 1015-1
- With locking pin retaining
- Surface: chrome-plated, polished
- DIN 3122



HAZET No.	l mm	EAN-No. 4000896+
1015/2	500	001927

1015 Sliding head

Made in Germany

20 3/4"

- For handle bar HAZET 1014 or 1014 P
- With locking pin retaining
- Surface: chrome-plated, polished
- DIN 3122



HAZET No.	l mm	EAN-No. 4000896+
1015-1	60	001910

1014 Handle bar

Made in Germany

- For sliding head HAZET 1015-1 or ratchet head HAZET 1016
- With ball and locking pin retaining
- Surface: chrome-plated
- DIN 3122



HAZET No.	l mm	EAN-No. 4000896+
1014	500	001897

1000 3/4" Socket · hexagon

Made in Germany

20 3/4" (E)

- Short design
- With knurling
- With bolt for locking pin retaining
- Surface: chrome-plated, polished
- DIN 3124, ISO 2725-1

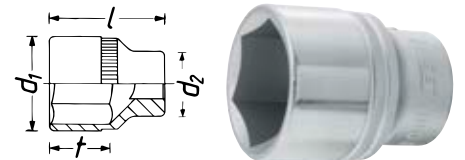

¹⁾ Not according to DIN

HAZET No.	l mm	d ₁ mm	d ₂ mm	t mm	EAN-No. 4000896+
1000-19 ¹⁾	52	28	33.2	14.5	000623
1000-21	52	31	33.2	14	000647
1000-22	52	32	33.2	14	000654
1000-24	52	34	36	16.5	000661
1000-27	54	38	35	19.3	000678
1000-30	55	42	36	21.5	000692
1000-32	58	44.5	36	24	000708
1000-33	59	46	36	24.5	000715
1000-34	60	47.5	36	25.5	000722
1000-36	61.5	49.5	38	26.5	000746
1000-38 ¹⁾	65	52.5	39	29	000760
1000-41	68.5	55.5	39	32	000784
1000-42 ¹⁾	70	57.5	41	32	000791
1000-46	73	62	44	34	000807
1000-50	76	67	45	37.1	000814
1000-55 ¹⁾	82	73.5	45	40.8	000821
1000-60 ¹⁾	88	80	45	44.9	000838



Hand tools

20 3/4" Range of sockets



1000 Z 3/4" Socket · 12-point

Made in Germany

- Short design
- With knurling
- With bolt for locking pin retaining
- Surface: chrome-plated, polished
- DIN 3124, ISO 2725-1

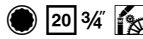
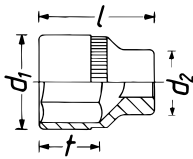

1) Not according to DIN

HAZET No.	l mm	d ₁ mm	d ₂ mm	f mm	EAN-No. 4000896+
1000 Z-22	52	32	33.2	13.5	001507
1000 Z-24	52	34	36	16	001521
1000 Z-27	54	38	35	18.8	001552
1000 Z-30	55	42	36	21	001583
1000 Z-32	58	44.5	36	23.4	001590
1000 Z-34	60	47.5	36	24.8	001613
1000 Z-35 ¹⁾	61.5	48.5	35.5	25.8	001620
1000 Z-36	61.5	49.5	36	25.7	001637
1000 Z-38 ¹⁾	65	52.5	38	28.3	001644
1000 Z-41	68.5	55.5	39	31.2	001651
1000 Z-46	73	62	44	34	001675
1000 Z-50	76	67	45	37.1	001699
1000 Z-55	82	73.5	45	40.8	001712

1000AZ 3/4" Socket · 12-point

Made in Germany

- Short design
- **American dimensions**
- With knurling
- With bolt for locking pin retaining
- Surface: chrome-plated, polished

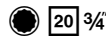
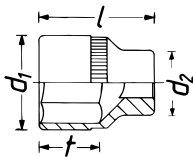

HAZET No.	l mm	d ₁ mm	d ₂ mm	f mm	EAN-No. 4000896+
1000 AZ-7/8	52	32	33.2	13.5	001170
1000 AZ-15/16	52	34	36	16.9	001132
1000 AZ-1	52	36.5	33.2	16.9	000999
1000 AZ-1.1/16	54	38	35	18.8	001002
1000 AZ-1.1/8	55	40	36	20.8	001033
1000 AZ-1.3/16	55	42	36	21	001064
1000 AZ-1.1/4	58	44.5	36	23.4	001026
1000 AZ-1.5/16	59	46	36	23.9	001095
1000 AZ-1.3/8	61.5	48.5	36	25.8	001088
1000 AZ-1.7/16	63	50	36	27.2	001118
1000 AZ-1.1/2	65	52.5	38	28.6	001019
1000 AZ-1.5/8	68.5	55.5	39	31.2	001101
1000 AZ-1.3/4	72	60	41	33.6	001071
1000 AZ-1.13/16	73	62	44	34	001057
1000 AZ-1.7/8	73	64	45	35	001125
1000 AZ-2	78	68	45	38.7	001149

1010 3/4" Screwdriver socket

Made in Germany

- Short design
- With knurling
- With bolt for locking pin retaining
- Surface: chrome-plated, tips burnished
- DIN 7422

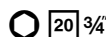
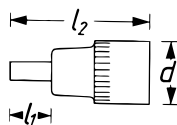

HAZET No.	s mm	l ₁ mm	l ₂ mm	d mm	EAN-No. 4000896+
1010-14	14	16.7	54.5	36	001842
1010-17	17	19.7	54.5	36	001859
1010-19	19	21.7	56.5	36	001866
1010-22	22	24.7	56.5	36	001873

2784 3/4" Brake calliper screwdriver socket

Made in Germany

- Drive allows transmission of high separation forces

- Controlled screw tightening with the torque value required by the manufacturer (follow manufacturer's instructions) e.g. with torque wrench HAZET 6144-1CT
- With knurling
- With bolt for locking pin retaining

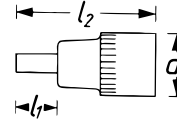

HAZET No.	s mm	l ₁ mm	l ₂ mm	d mm	EAN-No. 4000896+
2784-14	14	60	112	33.2	155583

TiN coating

TiN

Why choose TiN (Titanium Nitride) coating?

- A special coating process for extremely hard TiN coating guarantees high adhesive strength and wear resistance of the coating
- Particularly suitable for continuous load, e.g. for industrial applications in industry and trade
- Higher wear protection guarantees a longer lifetime
- Perfect fitting accuracy due to optimum coating thickness
- Optimized corrosion protection

TiN coated screwdriver sockets

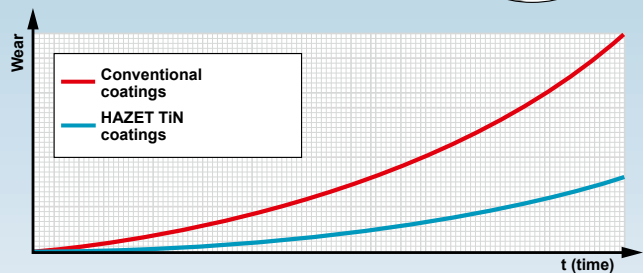
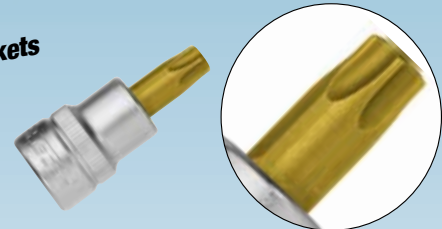

1012 3/4" Screwdriver socket · TORX®

Made in Germany

- Short design
- With knurling
- With bolt for locking pin retaining
- Surface: TiN coated

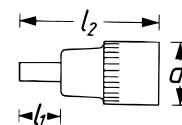

HAZET No.	s	l ₁ mm	l ₂ mm	d mm	⌀ mm	EAN-No. 4000896+
1012-T 60	T60	28	80	33.2	13.25	087488
1012-T 70	T70	28	80	33.2	15.54	087495
1012-T 80	T80	28	80	33.2	17.59	087501
1012-T 90	T90	28	80	33.2	19.95	087518
1012-T 100	T100	28	80	33.2	22.15	087525



1058 Adapter

Made in Germany

- With bolt for locking pin retaining
- Surface: chrome-plated
- DIN 3123, ISO 3316

TIN 25 1" 12.5 1/2" 20 3/4" E



HAZET No.	l mm	EAN-No. 4000896+
• Amplifier □ input 20 = 3/4" → ■ output 25 = 1"		
• Locking pin retaining		
1058-1	60.6	002061
• Reducer □ input 20 = 3/4" → ■ output 12.5 = 1/2"		
• Locking ball		
• Replaceable square 1058-02A		
1058-2	52.3	002078
• Insert square for HAZET adapter 1058-2		
1058-02A	28	233557

1021 3/4" → 3/4" Universal joint

Made in Germany

- With hinge – for working in areas with restricted access and for getting around obstructive edges
- Drive with bolt for locking pin retaining, output with locking pin retaining
- Surface: chrome-plated
- DIN 3123, ISO 3316

20 3/4" 20 3/4" E



HAZET No.	l mm	EAN-No. 4000896+
1021	105	002054

1017 3/4" → 3/4" Extension

Made in Germany

- Drive with bolt for locking pin retaining, output with locking pin retaining
- Surface: chrome-plated, polished

20 3/4" 20 3/4" E



¹⁾ DIN 3123, ISO 3316

HAZET No.	l mm	EAN-No. 4000896+
1017-3	75	001996
1017-8¹⁾	200	002016

1018 3/4" → 3/4" Extension

Made in Germany

- Drive with bolt for locking pin retaining, output with locking pin retaining
- DIN 3123, ISO 3316

20 3/4" 20 3/4" E



HAZET No.	l mm	EAN-No. 4000896+
1018	400	002030

1000 S 3/4" Impact socket · hexagon

Made in Germany

- For high loading
- Short design
- With borehole for locking pin or safety spring and groove for O-ring
- Surface: phosphatized, oiled
- DIN 3129, ISO 2725-2

20 3/4" E

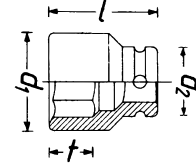

¹⁾ Not according to DIN

HAZET No.	l mm	d ₁ mm	d ₂ mm	t mm	EAN-No. 4000896+
1000 S-19¹⁾	48	32	44	13	001231
1000 S-22	50	36.5	44	16	001248
1000 S-24	50	39.5	44	17	001255
1000 S-27	51	43.5	44	19	001262
1000 S-28¹⁾	54	45	44	19	001279
1000 S-30	54	47.4	44	21	001293
1000 S-32	54	49.9	44	21	001309
1000 S-33¹⁾	54	51.5	44	16	001316
1000 S-34	54	52.4	44	16.8	001323
1000 S-36	57	54.9	44	23	001330

1000 SLG 3/4" Impact socket · hexagon

Made in Germany

- Long design
- With borehole for locking pin or safety spring and groove for O-ring
- Surface: phosphatized, oiled
- DIN 3129, ISO 2725-2

20 3/4" E

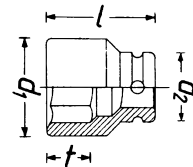

¹⁾ Not according to DIN

HAZET No.	l mm	d ₁ mm	d ₂ mm	t mm	EAN-No. 4000896+
1000 SLg-24	100	39.5	44	17	001392
1000 SLg-27	100	43.5	44	19	001408
1000 SLg-30	100	47.5	44	21	001422
1000 SLg-32	100	50	44	21	001439
1000 SLg-33¹⁾	100	51.5	44	21	001446
1000 SLg-36	100	55	44	23	001460

1004 S 3/4" Impact socket · hexagon

Made in Germany

- E.g. for **deeply located wheel nuts and bolts** on commercial vehicles
- **Extra long design**
- With borehole for locking pin or safety spring and groove for O-ring
- Surface: phosphatized, oiled
- DIN 3129, ISO 2725-2

20 3/4" E

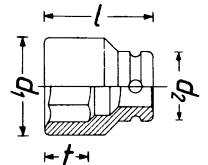

¹⁾ Not according to DIN

HAZET No.	l mm	d ₁ mm	d ₂ mm	t mm	EAN-No. 4000896+
1004 S-32	400	48	44	32	055784
1004 S-33¹⁾	400	48	44	32	055791



Hand tools

20 3/4" Range of sockets



2850 3/4" Impact socket · TORX®

Made in Germany

• Operation of cylinder head bolts

- Reinforced design
- Long design
- With borehole for locking pin or safety spring and groove for O-ring
- Surface: phosphatized, oiled

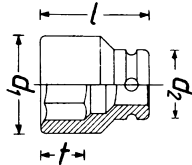

HAZET No.	s	l mm	d ₁ mm	d ₂ mm	mm	t mm	EAN-No. 4000896+
2850-E20	E20	110	25	44	18.49	15	079681
2850-E24	E24	110	30	44	22.16	17.5	146758

1003 S Impact adapter

Made in Germany

12⁵ 1/2"

- With borehole for locking pin or safety spring and groove for O-ring
- Surface: phosphatized, oiled
- ● Input 24 mm – ■ output 12.5 = 1/2"



HAZET No.	l mm	EAN-No. 4000896+
1003 S-07	44	215409

Made in Germany

20 3/4" E

• Operation of impact screwdriver sockets
900SZ6 · 903SZ6 · 985S · 990S · 1003S-07

- Surface: phosphatized, oiled
- □ Input 20 = 3/4" → ○ output 24 mm



HAZET No.	l mm	d mm	EAN-No. 4000896+
1003 S-1	54	44	161034

1007 S Impact adapter

Made in Germany

12⁵ 1/2" 25 1" 20 3/4" E

- With borehole for locking pin or safety spring and groove for O-ring
- Surface: phosphatized, oiled
- DIN 3121



HAZET No.	l mm	EAN-No. 4000896+
• Reducer □ input 20 = 3/4" → ■ output 12.5 = 1/2"		
1007 S-1	56	001804
• Amplifier □ input 20 = 3/4" → ■ output 25 = 1"		
1007 S-2	65	001828

1007 S Impact adapter

Made in Germany

12⁵ 1/2" 20 3/4" E

- Replaceable plug-in blades
● 24 mm – ■ drive 12.5 = 1/2"

- With borehole for locking pin or safety spring and groove for O-ring
- Surface: phosphatized, oiled
- Adapter / reducer for □ input 20 = 3/4" → ■ output 12.5 = 1/2"



HAZET No.	EAN-No. 4000896+
1007 S-7/4	215416

1006 S 3/4" → 3/4" Impact ball joint

Made in Germany

20 3/4" 20 3/4" E

- With hinge – for working in areas with restricted access and for getting around obstructive edges
- With borehole for locking pin or safety spring and groove for O-ring
- Surface: burnished, oiled
- DIN 3121



HAZET No.	l mm	EAN-No. 4000896+
1006 S	99	001781

1005 S 3/4" → 3/4" Impact extension

Made in Germany

20 3/4" 20 3/4" E

- With borehole for locking pin or safety spring and groove for O-ring
- Surface: phosphatized, oiled
- DIN 3121



HAZET No.	l mm	EAN-No. 4000896+
1005 S- 7	175	001774
1005 S-13	330	001767

1000 S O-ring and connecting pin

Made in Germany

20 3/4"



HAZET No.	mm	EAN-No. 4000896+
• O-ring for all connections □ 20 = 3/4" e.g. 2784-T 60/4 · 990 S/11		
1000 S-G 1736	∅ 36x5	001354
• Connecting pin for all connections □ 20 = 3/4" e.g. 2784-T 60/4 · 990 S/11		
1000 S-H 1736	∅ 4x36	001361



25 1" Range of sockets

1100Z Socket set

Made in Germany

- With 12-point sockets
- Sheet metal box (HAZET blue)

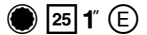

HAZET No.	L x W x H mm	□	EAN-No. 4000896+
1100Z	759x305x115	17	002504

1116 1" Reversible ratchet head

Made in Germany

- Number of teeth: 32 (Opening angle 11.25°)
- Shank with bolt for locking pin retaining, output with locking pin retaining
- Surface: chrome-plated
- DIN 3122, ISO 3315



HAZET No.	l mm	EAN-No. 4000896+
1116	195	003198

1116 1" Reversible ratchet head with handle bar

Made in Germany

- Number of teeth: 32 (Opening angle 11.25°)
- Shank with bolt for locking pin retaining, output with locking pin retaining
- Surface: chrome-plated, polished
- DIN 3122

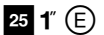

HAZET No.	l mm	□	EAN-No. 4000896+
1116/2	824	2	003211

Wear? – No problem!

- HAZET tools are manufactured to the **highest quality**. During long intensive loading there is a certain level of wear even for high-quality tools.
- For this reason, there are spare parts and replacement sets available for many of our tools.

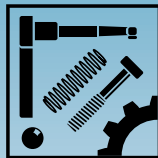

Please also see our spare parts shop
www.hazet.de/ersatzteil-shop

Cost-saving – Sustainable – Resource-saving!
For long-term pleasure with your HAZET tools

1116 Replacement set

Made in Germany



HAZET No.	EAN-No. 4000896+
1116/6	003228
1116/8N	003235

• **Replacement set for shift lever** consisting of:
shift lever · screws · ball · compression spring
For HAZET reversible ratchet 1116
For HAZET torque wrench 6150-1CT · 6160-1CT · 6170-1CT · 7250-2 sTAC · 7250-5 sTAC

• **Replacement set for ratchet wheel 25 = 1" ■** consisting of:
shift lever · screws · ball · compression spring · pawl · ratchet wheel
For HAZET reversible ratchet 1116
For HAZET torque wrench 6160-1CT · 6170-1CT

1115 Sliding head with handle bar

Made in Germany

- With locking pin retaining
- Surface: chrome-plated, polished
- DIN 3122



HAZET No.	l mm	□	EAN-No. 4000896+
1115/2	700	2	003181

1115 Sliding head

Made in Germany

- For handle bar HAZET 1114
- With locking pin retaining
- Surface: chrome-plated, polished
- DIN 3122



HAZET No.	l mm	EAN-No. 4000896+
1115-1	80	003167

1114 Handle bar

Made in Germany

- For sliding head HAZET 1115-1 or ratchet head HAZET 1116
- With ball and locking pin retaining
- Surface: chrome-plated
- DIN 3122



HAZET No.	l mm	EAN-No. 4000896+
1114	700	003150



Hand tools

25 1" Range of sockets



1100Z 1" Socket · 12-point

Made in Germany

- Short design
- With knurling
- With bolt for locking pin retaining
- Surface: chrome-plated, polished
- DIN 3124, ISO 2725-1

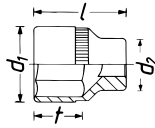

25 1"

1) Not according to DIN

HAZET No.	l mm	d ₁ mm	d ₂ mm	t mm	EAN-No. 4000896+
1100Z-32 ¹⁾	60	48	46	22	002511
1100Z-36 ¹⁾	67	52	48	28.5	002528
1100Z-41	68	57	48	29.5	002535
1100Z-46	72	62	48	32	002542
1100Z-50	74	68	48	35	002559
1100Z-55	78	74	48	36.5	002566
1100Z-60	83	80	48	40.5	002573
1100Z-65	86	88	60	43.5	002580
1100Z-70	89	96	60	46.5	002603
1100Z-75	92	102	60	49.5	002610
1100Z-80	94	108.5	60	52.5	002627

1158 1" → 3/4" Adapter

Made in Germany

- Drive with bolt for locking pin retaining, output with locking pin retaining
- Surface: chrome-plated
- DIN 3123, ISO 3316
- Reducer □ input 25 = 1" → ■ output 20 = 3/4"



20 3/4 25 1"

HAZET No.	l mm	EAN-No. 4000896+
1158-2	70	003297

1121 1" → 1" Universal joint

Made in Germany

- With hinge – for working in areas with restricted access and for getting around obstructive edges
- Drive with bolt for locking pin retaining, output with locking pin retaining
- Surface: chrome-plated



25 1" 25 1"

HAZET No.	l mm	EAN-No. 4000896+
1121	144	003273

1117 1" → 1" Extension

Made in Germany

- Drive with bolt for locking pin retaining, output with locking pin retaining
- Surface: chrome-plated, polished
- DIN 3123, ISO 3316



25 1" 25 1"

HAZET No.	l mm	EAN-No. 4000896+
1117- 8	200	003259
1117-16	400	003242

1100S 1" Impact socket · hexagon

Made in Germany

- For high loading
- Short design
- With borehole for locking pin or safety spring and groove for O-ring
- Surface: phosphatized, oiled
- DIN 3129, ISO 2725-2

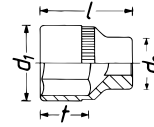

25 1" E

1) Not according to DIN

HAZET No.	l mm	d ₁ mm	d ₂ mm	t mm	EAN-No. 4000896+
1100S-24	58	41.5	54	17	002207
1100S-27	60	45	54	19	002214
1100S-30	62	49	54	21	002221
1100S-32	63	51.5	54	21	002238
1100S-33 ¹⁾	63	52.5	54	21	002252
1100S-34	63	53.5	54	22	002269
1100S-36	67	56.5	54	23	002276
1100S-41	70	63	54	26	002290
1100S-46	76	69.5	54	28	002320
1100S-50	82	74.5	54	30	002344
1100S-55	87	81	54	32	002351
1100S-60	91	87	54	34	002375

1100SLG 1" Impact socket · hexagon

Made in Germany

- Long design
- With borehole for locking pin or safety spring and groove for O-ring
- Surface: phosphatized, oiled
- DIN 3129, ISO 2725-2

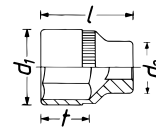

25 1" E

HAZET No.	l mm	d ₁ mm	d ₂ mm	t mm	EAN-No. 4000896+
1100SLg-24	110	41.5	54	17	002405
1100SLg-27	110	45	54	19	002412
1100SLg-30	110	49	54	21	002429
1100SLg-32	110	51.5	54	21	002436
1100SLg-33	110	52.5	54	21	002443
1100SLg-36	110	56.5	54	23	002467
1100SLg-38	110	59	54	24	002474
1100SLg-41	110	63	54	26	002481
1100SLg-46	110	69.5	54	28	002498

1104S 1" Impact socket · hexagon

Made in Germany

- E.g. for deeply located wheel nuts and bolts on commercial vehicles
- Extra long design
- With borehole for locking pin or safety spring and groove for O-ring
- Surface: phosphatized, oiled
- DIN 3129, ISO 2725-2

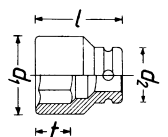

25 1" E

HAZET No.	l mm	d ₁ mm	d ₂ mm	t mm	EAN-No. 4000896+
1104S-32	270	48.5	54	30.5	002665



1107 S 1" → 3/4" Impact adapter

Made in Germany

- With borehole for locking pin or safety spring and groove for O-ring
- Surface: phosphatized, oiled
- DIN 3121

20 3/4" 25 1" E



HAZET No.	l mm	EAN-No. 4000896+
• Reducer □ input 25 = 1" → ■ output 20 = 3/4"		
1107 S	70	002733

1106 S 1" → 1" Impact ball joint

Made in Germany

- With hinge – for working in areas with restricted access and for getting around obstructive edges
- With borehole for locking pin or safety spring and groove for O-ring
- Surface: burnished, oiled
- DIN 3121

25 1" 25 1" E



HAZET No.	l mm	EAN-No. 4000896+
1106 S	125	002719

1105 S 1" → 1" Impact extension

Made in Germany

- With borehole for locking pin or safety spring and groove for O-ring
- Surface: phosphatized, oiled
- DIN 3121

25 1" 25 1" E



HAZET No.	l mm	EAN-No. 4000896+
1105 S- 7	180	002702
1105 S-13	330	002696

1100 S O-ring and connecting pin

Made in Germany

25 1" 25 1" E



HAZET No.	mm	EAN-No. 4000896+
• O-ring for all connections □ 25 = 1"		
1100 S-G 2260	∅ 45x7	002382
• Connecting pin for all connections □ 25 = 1"		
1100 S-H 2260	∅ 5x45	002399

TORX® Tools

1557 Tool set · TORX®

Made in Germany

6.3 1/4" 10 3/8" 125 1/2" E

- Plastic box 165-S (1/9)
- Safety-Insert-System, 2-component soft foam insert. Insert also suitable for HAZET Assistant



1/9				



850 E • 6.3 • 1/4" E 4 • E 5 • E 6



880 E • 6.3 • 10 3/8" E 8 • E 10 • E 12



900 E • 6.3 • 125 1/2" E 14 • E 18 • E 20

HAZET No.	L x W x H mm		EAN-No. 4000896+
1557/9	185x153x52	9	003907

Made in Germany

TIN 6.3 1/4" 10 3/8" 125 1/2" E

- Plastic box 165-S (1/9)
- Safety-Insert-System, 2-component soft foam insert. Insert also suitable for HAZET Assistant
- Surface: TIN coated



1/9				



8502 • 6.3 • 1/4" T 8 • T 10 • T 15



8802 • 6.3 • 10 3/8" T 20 • T 25 • T 30



992 • 6.3 • 125 1/2" T 40 • T 50 • T 55 • T 60

HAZET No.	L x W x H mm		EAN-No. 4000896+
1557/10	185x153x52	10	003716

Made in Germany

HiPer inside TIN 10 3/8" E

- Plastic box 165-L (1/3)
- Safety-Insert-System, 2-component soft foam insert. Insert also suitable for HAZET Assistant
- Surface: TIN coated



1/3				



880 E • 6.3 • 10 3/8" E 5 • E 6 • E 7 E 8 • E 10 • E 11 E 12 • E 14



8802 • 6.3 • 10 3/8" T 15 • T 20 • T 25 T 27 • T 30 • T 40 T 45 • T 50



8816 HP • 10 3/8"



8820 • 10 3/8" • 10 3/8"



8815 • 10 3/8"

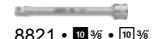

8821 • 10 3/8" • 10 3/8"

8821-3 • 8821-6

HAZET No.	L x W x H mm		EAN-No. 4000896+
1557/21	355x235x65	21	003822



Hand tools

TORX® Tools



1557 Tool set · TORX®

- Equipped with 2 bits of each size
- Plastic box 165-S (1/9)
- Safety-Insert-System, 2-component soft foam insert.
Insert also suitable for HAZET Assistant



1/9				
-----	--	--	--	--



2223N • •
T 6 • T 7 • T 8 • T 9
T 10 • T 15 • T 20 • T 25
T 27 • T 30

2250-1 • •
2250-2 • •
2250-3 • •
2250-5 • •



2224 • •
T 40 • T 45 • T 50 • T 55

HAZET No.	L x W x H mm		EAN-No. 4000896+
1557/32	185x153x52	32	003860

- Plastic box 165-L (1/3)
- Safety-Insert-System, 2-component soft foam insert.
Insert also suitable for HAZET Assistant



1/3				
-----	--	--	--	--



609 •
E 6, E 8 • E 10, E 12
E 14, E 18
E 20, E 24

880E • •
E 10 • E 11
E 12 • E 14

992 • •
T 50 • T 55 • T 60

2223N • •
T 7H • T 8H
T 9H • T 10H
T 15H • T 20H
T 25H • T 27H
T 30H • T 40H

803-T •
T 6 • T 7 • T 8
T 9 • T 10 • T 15
T 20 • T 25 • T 27
T 30

8802 • •
T 40 • T 45

2115 •
T 6 • T 7 • T 8
T 9 • T 10 • T 15
T 20 • T 25 • T 27
T 30 • T 40

2223LG • •
T 25

850E • •
E 4 • E 5 • E 6
E 7 • E 8

900E • •
E 16 • E 18
E 20 • E 24

2223N • •
T 6

2250-1 • •
2250-2 • •
863HPB •

HAZET No.	L x W x H mm		EAN-No. 4000896+
1557/58	355x235x65	58	003884

Made in Germany

- Plastic box 165-L (1/3)
- Safety-Insert-System, 2-component soft foam insert.
Insert also suitable for HAZET Assistant

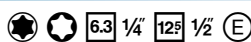

1/3				
-----	--	--	--	--



1557 Tool set · TORX®

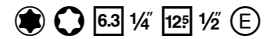

850E • •
E 5 • E 6 • E 7 • E 8
E 10 • E 11 • E 12

900E • •
E 12 • E 14 • E 16
E 18 • E 20 • E 24

992SLG • •
T 30 • T 40 • T 45 • T 50

8502 • •
T 8 • T 9 • T 10
T 15 • T 20 • T 25
T 27 • T 30 • T 40

992 • •
T 20 • T 25 • T 27
T 30 • T 40 • T 45
T 50 • T 55 • T 60

HAZET No.	L x W x H mm		EAN-No. 4000896+
1557/35	355x235x65	35	239887

163 Tool set · TORX®

Made in Germany

- Safety-Insert-System, 2-component soft foam insert.
Insert also suitable for HAZET Assistant
- Surface: TIN coated

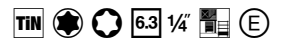

850E • •
E 4 • E 5 • E 6 • E 7
E 8 • E 10 • E 11

8502 • •
T 10 • T 15 • T 20 • T 25
T 27 • T 30 • T 40

HAZET No.	L x W mm		EAN-No. 4000896+
163-251/14	172x50	14	178063

Made in Germany

- Safety-Insert-System, 2-component soft foam insert.
Insert also suitable for HAZET Assistant
- Surface: TIN coated

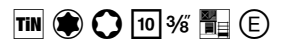

880E • •
E 8 • E 10 • E 12 • E 14

8802 • •
T 25 • T 30 • T 40 • T 45 • T 50

HAZET No.	L x W mm		EAN-No. 4000896+
163-252/9	172x50	9	178070

Made in Germany

- Safety-Insert-System, 2-component soft foam insert.
Insert also suitable for HAZET Assistant

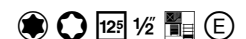

900E • •
E 10 • E 12 • E 14
E 16 • E 18 • E 20

992 • •
T 30 • T 40 • T 45
T 50 • T 55 • T 60

HAZET No.	L x W mm		EAN-No. 4000896+
163-245/12	172x114	12	178049



Screwdrivers / Bits



HEXAnamic® screwdriver with 3-component handle [802]	⊖ ⊕ ⚙ ⚙	204–205
Screwdriver with 2-component handle, short form [801 N K]	⊖ ⊕	205
Screwdriver with impact cap, with 3-component handle [810 U]	⊖ ⊕	205–206
Screwdriver with 3-component handle [810]	⊖ ⊕ ⚙	206–207
trinamic® screwdriver with 1-component handle [803]	⊖ ⊕ ⚙ ⚙	207–208
Screwdriver with protective insulation, 2-component handle [810]	⊖ ⊕ ⚙	279
Electronic screwdriver [805]	⊖ ⊕ ⚙	209
Nut-driver [426 / 428]	⦿	209–210
Screwdriver with 2-component T-handle [828]	○ ⚙	210–211
Offset screwdriver [819 / 2100 – 2116]	⊕ ○ ⚙	212–213
6.3 1/4 Screwdriver bit sets [863 / 2200 / 2240]	⊖ ⊕ ⚙ ○ ⚙ ⚙	217–222
6.3 1/4 Bits [2208 – 2225]	⊖ ⊕ ⚙ ○ ⚙ ⚙ ⚙	222–224
6.3 1/4 Operating tools and adapters for bits [810 / 863 / 2264 – 2265]		224–177
8 5/16 Screwdriver bit sets [2272]	⊖ ⊕ ○ ⚙	227
8 5/16 Bits [2210 – 2212]	⊖ ⊕ ⚙ ○ ⚙ ⚙	227
8 5/16 Operating tools and connectors for screwdriver bits [2250 – 2272]		227



Hand tools

Screwdrivers / Bits



HAZET HEXAnamic® screwdriver 802

Anatomically shaped screwdrivers according to the latest developments in ergonomic research



- ① Grey tips for **optimal corrosion protection** and **perfect hold** of the blade in the screw head
- ② **Integrated hex bolster**
For use with wrench to transfer higher torques
- ③ **Component no. 1 (hard):** Blade firmly fixed to the handle
- ④ **Component no. 3 (soft):**
For exceptional slide-off protection at axial contact pressure
- ⑤ **Component no. 2 (hard):**
Stability against external impact
- ⑥ With **offset hexagon** at the front of the handle:
• **Slide-off protection**
• **Anti-roll protection**
- ⑦ Well-sized **spinning area**
- ⑧ **Non-slipping** even with greasy hands
- ⑨ Ergonomically shaped for perfect contact between hand and screwdriver
- ⑩ **6 deepened gripping areas** for high power transmission
- ⑪ **Imprinted screw profile** for finding the right screwdriver fast – at any time!

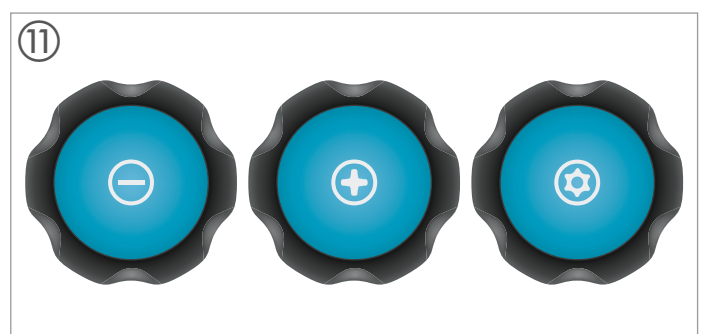
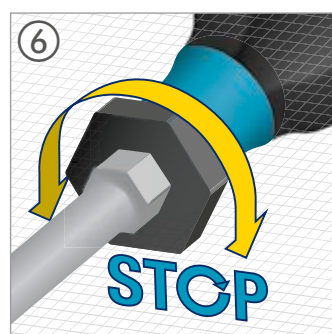
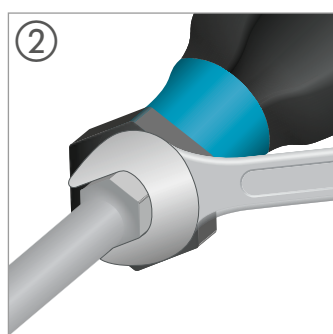



HAZET handle design 802

Optimally adapted to the screw sizes

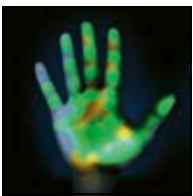
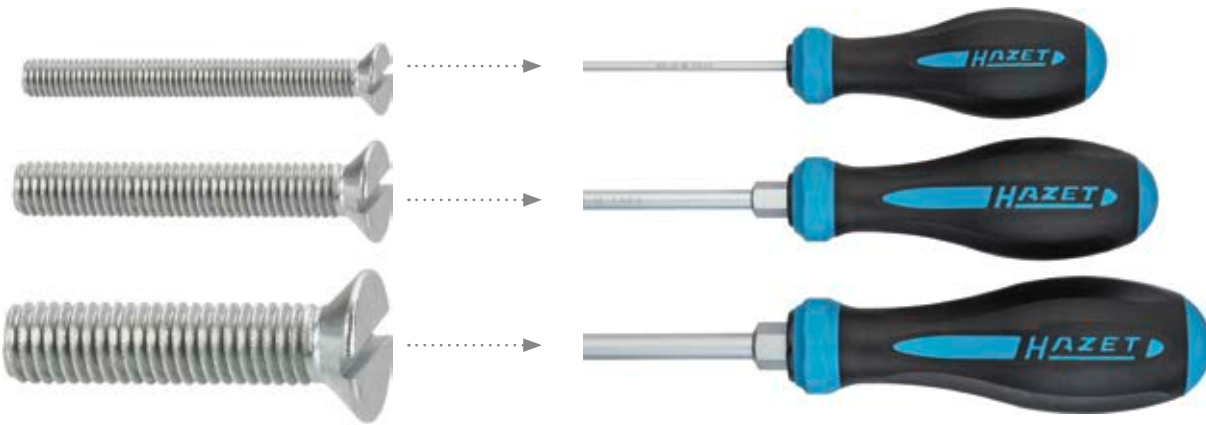

HEXAnamic® handle = low pressure



Conventional handle = high pressure

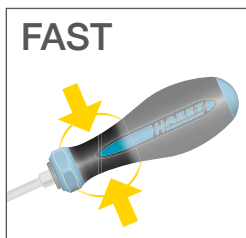
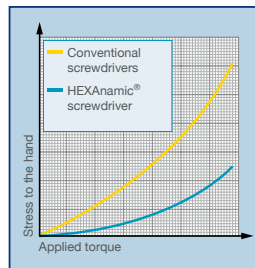

HAZET design elements for spinning

- Well-sized slim spinning area at the end of the handle guarantees fast turning
- Optimal for fast and sensitive screw fitting

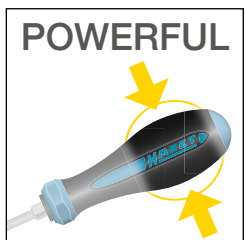

HAZET design elements for powerful effect when working with screws

- 6 deepened hand-friendly gripping areas for high power transmission
- Ergonomically shaped handle for perfect contact between hand and screwdriver
- Also suited for continuous operation thanks to user-friendly design
- Strong slide-off protection for safe work and high tightening torque for contact pressure

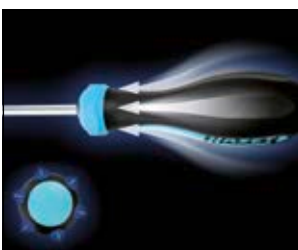



HAZET Screwdrivers 810

The new economical screwdriver

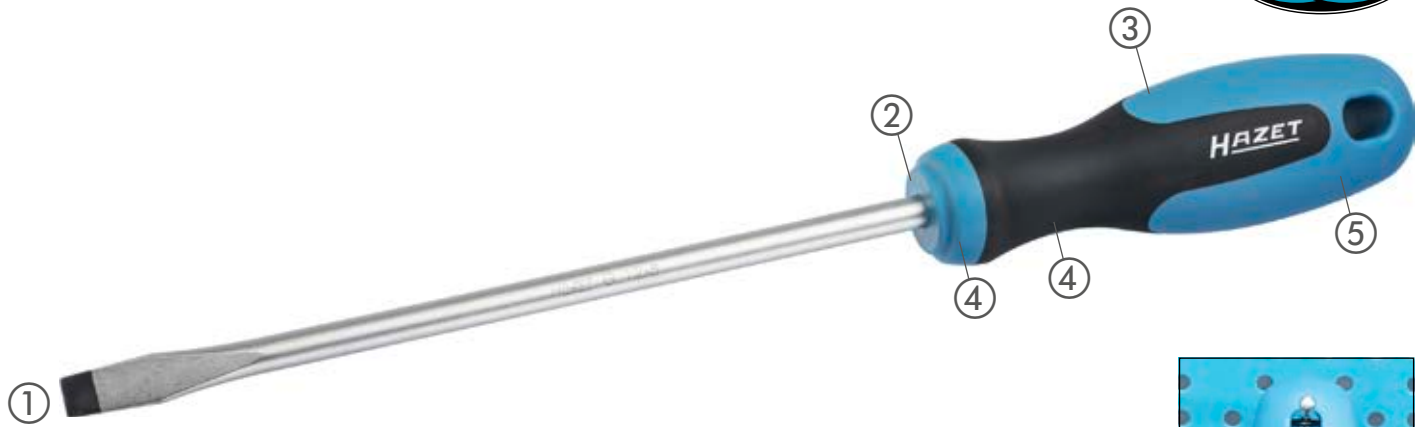

① Black coated tip for **optimal corrosion protection** and **perfect hold** of the blade in the screw head

② • Slide-off protection
• Anti-roll protection



③ The HAZET **3-component handle** always ensures optimum power and grip. The softer, non-slipping components allow for a secure hold. The distinct slide-off zones ensure power through perfect friction locking.

④ Hard component

⑤ Soft component





HAZET screwdriver 810 U with impact cap

For screwing and more!

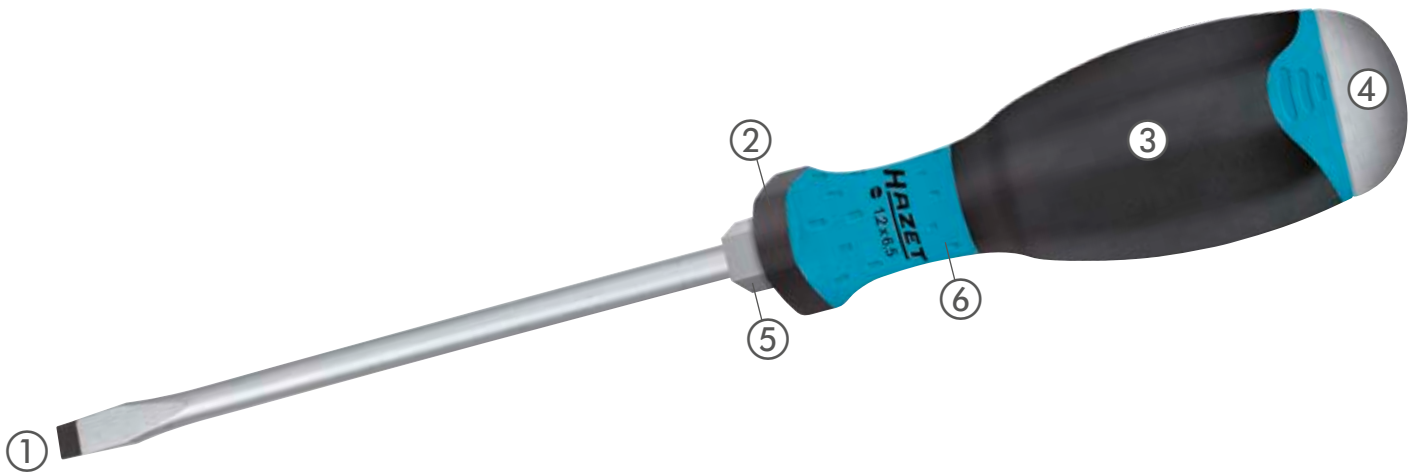

① Black coated tip for **optimal corrosion protection** and **perfect hold** of the blade in the screw head

② • Slide-off protection
• Anti-roll protection



③ The HAZET **3-component handle** always ensures optimum power and grip. The softer, non-slipping components allow for a secure hold. The distinct slide-off zones ensure power with perfect friction locking.



④ **Integrated steel cap** increases the service life of the handle and reduces the risk of chipping. For loosening jammed screws and for smaller chiseling jobs
Note: Always wear safety glasses for safety reasons!

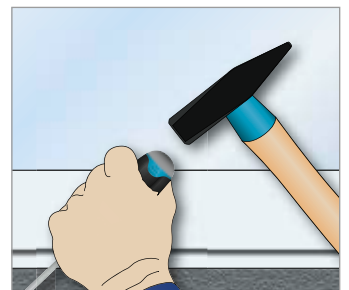

⑤ Hex bolster for use with a wrench to transfer higher torques.

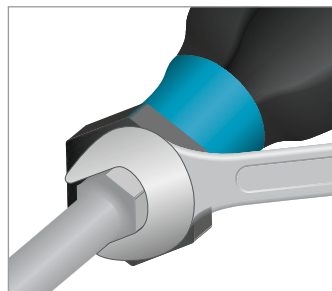

⑥ Well suited for continuous operation thanks to the ergonomically shaped handle that provides the perfect contact between your hand and the screwdriver.

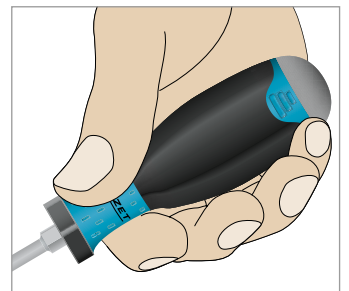



Hand tools

Screwdrivers / Bits



HAZET trinamic® Screwdrivers 803

Synthesis of steel and plastic



① Black coated tip for **optimal corrosion protection** and **perfect hold** of the blade in the screw head

② trinamic® shape:
• Slide-off protection
• Anti-roll protection



③ **Non-slipping** even with greasy hands

④ **Upset and pressed hex bolster** enables power transfer that is many times higher when using an open-end wrench

⑤ Narrow shape with spinning area

⑥ trinamic®
1-component handle, ergonomically shaped and extremely resilient





Different HAZET handle designs

FAST

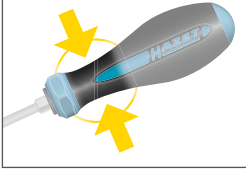

Well-sized spinning area

- Allows for safe and fast turning between thumbs and index finger
- Optimal guidance with slight widening to the offset hexagon as slide-off protection
- Ergonomically shaped handle for a perfect friction connection across all components

POWERFUL



HAZET 3-component handle for a perfect friction connection

- Maximum friction connection with ergonomic 3-component handle
- Firm grip using entire fist around the handle possible
- Suited for continuous operation as the highly ergonomic development means there are no elements that cause pain when turning screws



Screwdriver with 2-component handle, short design



HEXAnamic® with 3-component handle



Screwdriver with impact cap, with 3-component handle



Screwdriver with 3-component handle



trinamic® screwdriver with 1-component handle



Electronic screwdriver



Clip screwdriver



Do you know?



High performance and durability

- Blade made from the best chrome-vanadium molybdenum steels is toughened throughout
- **Precise fitting into screw head**
- Blade tip produces with high precision and also burnished
- Permanent protection from corrosion
- Chrome-plated surface offers perfect protection from rust
- **Finding the right screwdriver fast**
- Imprinted screw profile makes it easier for the mechanic to always find the right grip
- **Suitable for continuous operation**
- Ergonomic handle prevents pressure marks and painful swelling

Additional advantage in work safety

- Recessed hexagon roll protection prevents unintended sliding-off and provides additional slip-off protection for safe working

The HAZET 3-component handle ensures optimum power and grip thanks to its combination of materials

- Non-slip components enable safe holding and distinct slide-off zones provide power with the perfect friction connection

HAZET offers the following specific blades for slotted screws:

- Wedge-shaped blade tip for workshop applications
→ well suited for all work with screws
- In accordance with ISO 2380-1 Form A, ISO 2380-2:2004

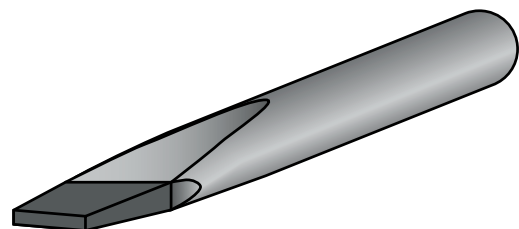

- Narrow, parallel blade tip for electrician applications
→ well suited for screws located deep inside screw shaft, e.g. in power sockets and insulating screw joints
- In accordance with ISO 2380-1 Form B

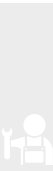
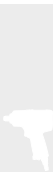
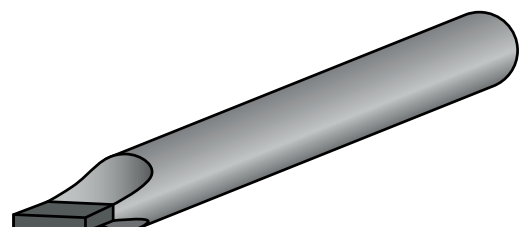



802 HEXAnamic® screwdriver

- Round blade
- Non-slip HAZET 3-component handle – allows high power transmission
- Surface: chrome-plated
- ISO 2380-1 Form A, ISO 2380-2:2004

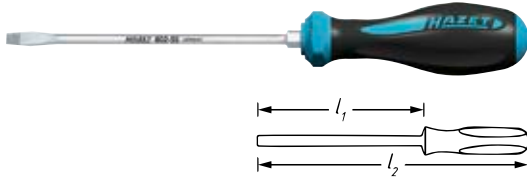

¹⁾ Blade with hex bolster for use with a wrench, allows application of high separation forces

HAZET No.	l_1 mm	l_2 mm	mm	$\frac{b}{d}$ mm	b mm	EAN-No. 4000896+
802-30	80	179	–	0.6	3.5	144785
802-40	100	199	–	0.8	4	144808
802-55 ¹⁾	125	239	8	1	5.5	144815
802-65 ¹⁾	150	264	10	1.2	6.5	144822
802-80 ¹⁾	150	279	13	1.2	8	144839
802-100 ¹⁾	175	304	13	1.6	10	144846
802-120 ¹⁾	200	329	16	2	12	144853

802-PH HEXAnamic® screwdriver

- Round blade
- Non-slip HAZET 3-component handle – allows high power transmission
- ISO 8764-1:2004, ISO 8764-2:2004

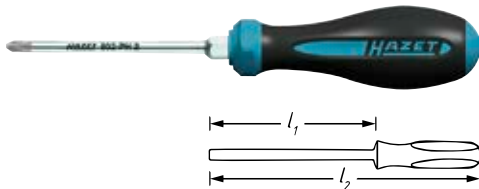

¹⁾ Blade with hex bolster for use with a wrench, allows application of high separation forces

HAZET No.	l_1 mm	l_2 mm	mm	EAN-No. 4000896+
802-PH 0	60	159	–	144860
802-PH 1	80	194	–	144884
802-PH 2	100	214	–	144907
802-PH 3 ¹⁾	150	279	13	144921

802-PZ HEXAnamic® screwdriver

- Round blade
- Non-slip HAZET 3-component handle – allows high power transmission
- ISO 8764-1:2004, ISO 8764-2:2004

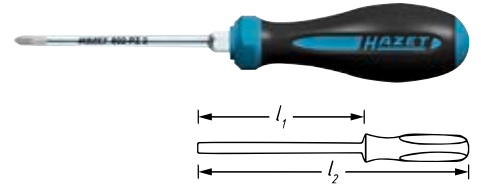

¹⁾ Blade with hex bolster for use with a wrench, allows application of high separation forces

HAZET No.	l_1 mm	l_2 mm	mm	EAN-No. 4000896+
802-PZ 0	60	159	–	145058
802-PZ 1	80	194	–	145065
802-PZ 2	100	214	–	145072
802-PZ 3 ¹⁾	150	279	13	145089

802-TH HEXAnamic® screwdriver

- Round blade
- Non-slip HAZET 3-component handle – allows high power transmission

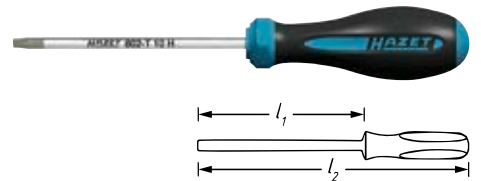

HAZET No.	l_1 mm	l_2 mm	mm	EAN-No. 4000896+
802-T 8 H	60	159	2.31	145102
802-T 9 H	60	159	2.50	145119
802-T 10 H	80	179	2.74	145126
802-T 15 H	80	179	3.27	145133
802-T 20 H	100	214	3.86	145140
802-T 25 H	100	214	4.43	145164
802-T 27 H	115	214	4.99	145171
802-T 30 H	115	229	5.52	145188
802-T 40 H	130	259	6.65	145195
802-T 45 H	130	259	7.82	145201

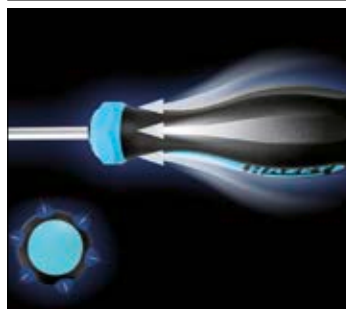



Hand tools

Screwdrivers / Bits



801 NK Screwdriver

- Short design
- Round blade
- Ergonomically shaped HAZET 2-component handle

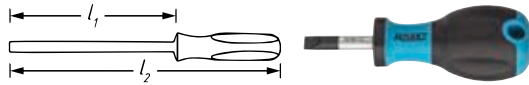

HAZET No.	l_1 mm	l_2 mm	$\frac{\phi}{4}$ mm	b mm	EAN-No. 4000896+
801 NK-35	25	89	0.6	3.5	209897
801 NK-55	25	89	1	5.5	209873
801 NK-80	25	89	1.2	8	209903

801 NK-PH Screwdriver

- Short design
- Round blade
- Ergonomically shaped HAZET 2-component handle

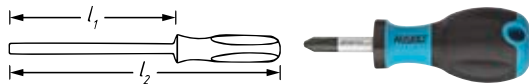

HAZET No.	l_1 mm	l_2 mm	EAN-No. 4000896+
801 NK-PH1	25	89	209910
801 NK-PH2	25	89	209880

802 HEXAnamic® screwdriver set

- Non-slip HAZET 3-component handle – allows high power transmission
- Surface: chrome-plated



802 • 0.8x4 • 1x5.5 • 1.2x6.5

802-PH • PH1 • PH2

HAZET No.	$\frac{\phi}{4}$ mm	EAN-No. 4000896+
802/5	5	147359

- Non-slip HAZET 3-component handle – allows high power transmission



802 • 0.6x3.5 • 0.8x4
1x5.5 • 1.2x6.5
1.2x8 • 1.6x10

802-PH • PH1 • PH2

801NK-PH • PH2

801NK • 1x5.5

HAZET No.	$\frac{\phi}{4}$ mm	EAN-No. 4000896+
802/10	10	145577

802 HEXAnamic® screwdriver set

- Safety-Insert-System, 2-component soft foam insert. Insert also suitable for HAZET Assistant
- Non-slip HAZET 3-component handle – allows high power transmission

HAZET No.	$\frac{\phi}{4}$ mm	EAN-No. 4000896+
802-TH/7	7	145607

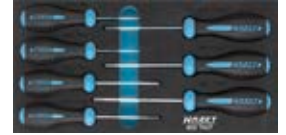

802-TH • T8H • T9H • T10H • T15H • T20H • T25H • T30H

HAZET No.	$L \times W$ mm	$\frac{\phi}{4}$ mm	EAN-No. 4000896+
802-TH/7	342x172	7	145607

- Safety-Insert-System, 2-component soft foam insert. Insert also suitable for HAZET Assistant

HAZET No.	$\frac{\phi}{4}$ mm	EAN-No. 4000896+
802 • 0.8x4 • 1x5.5 • 1.2x6.5 • 1.2x8	5	147359

802 • 0.8x4 • 1x5.5 • 1.2x6.5 • 1.2x8

802-PH • PH1 • PH2

HAZET No.	$L \times W$ mm	$\frac{\phi}{4}$ mm	EAN-No. 4000896+
163-184/6	342x172	6	161461

802 TH HEXAnamic® screwdriver set

- Safety-Insert-System, 2-component soft foam insert. Insert also suitable for HAZET Assistant

HAZET No.	$\frac{\phi}{4}$ mm	EAN-No. 4000896+
802-TH • T10H • T15H • T20H • T25H • T30H	7	145607

HAZET No.	$L \times W$ mm	$\frac{\phi}{4}$ mm	EAN-No. 4000896+
163-185/5	342x172	5	161478

810 U Screwdriver · with impact cap

- Blade with hex bolster for use with a wrench, allows application of high separation forces

- Round blade
- Non-slip HAZET 3-component handle – allows high power transmission
- Surface: blade matt chrome-plated, tip burnished

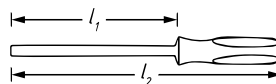

HAZET No.	l_1 mm	l_2 mm	ϕ mm	$\frac{\phi}{4}$ mm	b mm	EAN-No. 4000896+
810 U-45	75	175	8	0.8	4.5	200504
810 U-55	100	200	8	1	5.5	200511
810 U-70	125	225	10	1.2	7	200528



810 U-PH Screwdriver · with impact cap

- Blade with hex bolster for use with a wrench, allows application of high separation forces
- Round blade
- Non-slip HAZET 3-component handle – allows high power transmission
- Surface: blade matt chrome-plated, tip burnished



HAZET No.	l_1 mm	l_2 mm	mm	EAN-No. 4000896+
810 U-PH1	80	180	8	200498
810 U-PH2	100	210	10	200481
810 U-PH3	150	260	13	200474

810 U Screwdriver set · with impact cap

- Blade with hex bolster for use with a wrench, allows application of high separation forces
- Round blade
- Non-slip HAZET 3-component handle – allows high power transmission
- Surface: blade matt chrome-plated, tip burnished



810 U · · 0.8x4.5 · 1x5.5 · 1.2x7

810 U-PH · · PH1 · PH2

HAZET No.		EAN-No. 4000896+
810 U-1/5	5	179572

- Blade with hex bolster for use with a wrench, allows application of high separation forces
- Round blade
- Safety-Insert-System, 2-component soft foam insert. Insert also suitable for HAZET Assistant
- Non-slip HAZET 3-component handle – allows high power transmission

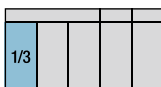
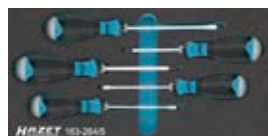

810 U · · 0.8x4.5 · 1x5.5 · 1.2x7

810 U-PH · · PH1 · PH2

HAZET No.	$L \times W$ mm		EAN-No. 4000896+
163-264/5	342x172	5	180592

810 U Screwdriver set

- Round blade
 - Safety-Insert-System, 2-component soft foam insert. Insert also suitable for HAZET Assistant
 - Non-slip HAZET 3-component handle – allows high power transmission
- For HAZET Assistant with drawer depth of 398 mm:
173 · 179 · 179N · 179NX · 179W · 179NW · 179BIG-1 · 179XL · 179NXL · 179XXL · 179NXXL · 179AXXL · 179TXXL · 180



810 U · · 0.8x4.5 · 1x5.5 · 1.2x7

810 U-PH · · PH1 · PH2 · PH3

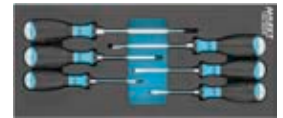
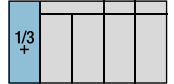

HAZET No.	$L \times W$ mm		EAN-No. 4000896+
163-522/6	392x172	6	218660

810 Screwdriver

- Hanging hole in handle

- Round blade
- Non-slip HAZET 3-component handle – allows high power transmission
- Surface: blade matt chrome-plated, tip burnished

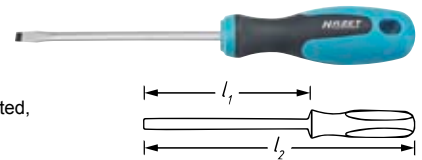

HAZET No.	l_1 mm	l_2 mm	$\frac{b}{d}$ mm	b mm	EAN-No. 4000896+
810-25	75	160	0.4	2.5	206919
810-30	80	165	0.5	3	205127
810-40	100	185	0.8	4	205134
810-55	125	230	1	5.5	205141
810-65	150	265	1.2	6.5	205158

810-PH Screwdriver

- Hanging hole in handle

- Round blade
- Non-slip HAZET 3-component handle – allows high power transmission
- Surface: blade matt chrome-plated, tip burnished

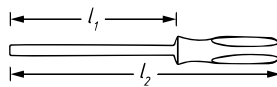

HAZET No.	l_1 mm	l_2 mm	EAN-No. 4000896+
810-PH0	60	145	206926
810-PH1	80	185	205165
810-PH2	100	215	205172

810-PZ Screwdriver

- Hanging hole in handle

- Round blade
- Non-slip HAZET 3-component handle – allows high power transmission
- Surface: blade matt chrome-plated, tip burnished

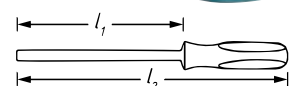

HAZET No.	l_1 mm	l_2 mm	EAN-No. 4000896+
810-PZ1	80	185	221813
810-PZ2	100	215	221806



Hand tools

Screwdrivers / Bits



810-T Screwdriver

- Hanging hole in handle
- Round blade
- Non-slip HAZET 3-component handle – allows high power transmission
- Surface: blade matt chrome-plated, tip burnished

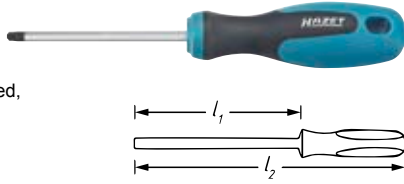

HAZET No.	l_1 mm	l_2 mm	mm	EAN-No. 4000896+
810-T10	80	165	2.74	205189
810-T15	80	165	3.27	205196
810-T20	100	185	3.86	205202
810-T25	100	205	4.43	205219
810-T27	115	220	4.99	205226
810-T30	115	230	5.52	205233

810 Screwdriver set

- Hanging hole in handle
- Non-slip HAZET 3-component handle – allows high power transmission
- Surface: blade matt chrome-plated, tip burnished



810 •
 0.5x3 • 0.8x4 • 1x5.5 • 1.2x6.5

810-PH •
 PH1 • PH2

HAZET No.		EAN-No. 4000896+
810/6	6	058808

810 PZ Screwdriver set

- Hanging hole in handle
- Non-slip HAZET 3-component handle – allows high power transmission
- Surface: blade matt chrome-plated, tip burnished



810 •
 0.5x3 • 0.8x4 • 1x5.5 • 1.2x6.5

810-PZ •
 PZ1 • PZ2

HAZET No.		EAN-No. 4000896+
810/6PZ	6	217984

810 T Screwdriver set

- Hanging hole in handle
- Non-slip HAZET 3-component handle – allows high power transmission
- Surface: blade matt chrome-plated, tip burnished



YouTube Clip

810-T •
 T10 • T15 • T20 • T25 • T27 • T30

HAZET No.		EAN-No. 4000896+
810 T/6	6	204304

810 TSPC Screwdriver set • TORX®

- Safety-Insert-System, 2-component soft foam insert. Insert also suitable for HAZET Assistant



810-T •
 T10 • T15 • T20
 T25 • T27 • T30



HAZET No.	L x W mm		EAN-No. 4000896+
163-266/6	342x172	6	180615

803 Screwdriver trinamic®

- Round blade
- Ergonomically shaped 1-component trinamic handle
- Surface: chrome-plated, tips burnished

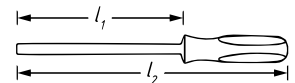

- 1) Specification I1 outside ISO 2380-2
- 2) Blade with hex bolster for use with a wrench, allows application of high separation forces

HAZET No.	l_1 mm	l_2 mm	mm	mm	b mm	EAN-No. 4000896+
803- 20 ¹⁾	63	143	–	0.4	2	077434
803- 25	75	155	–	0.4	2.5	077441
803- 30 ¹⁾	80	160	–	0.5	3	077458
803- 35	100	193	–	0.6	3.5	077465
803- 40	100	193	–	0.8	4	077472
803- 55	125	218	–	1	5.5	077489
803 S-55 ²⁾	125	235	8	1	5.5	089109
803- 65	150	260	–	1.2	6.5	077496
803- 80 ²⁾	150	272	13	1.2	8	077502
803-100 ²⁾	175	309	13	1.6	10	077519
803-120 ²⁾	200	334	16	2	12	077526
803-140 ²⁾	250	384	16	2.5	14	077533



803 LG Screwdriver trinamic®

- For deeply located screw connections
- **Extra long design**
- Round blade
- Ergonomically shaped 1-component trinamic handle

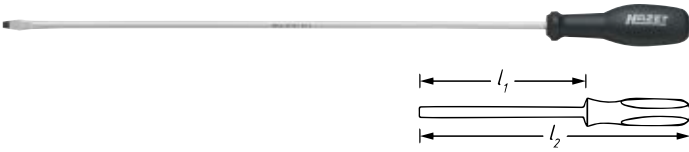

HAZET No.	l_1 mm	l_2 mm	$\frac{b}{d}$ mm	b mm	EAN-No. 4000896+
803 LG-55	410	520	1	5.5	077540

803-PH Screwdriver trinamic®

- Round blade
- Ergonomically shaped 1-component trinamic handle
- DIN ISO 8764-2, ISO 8764-2

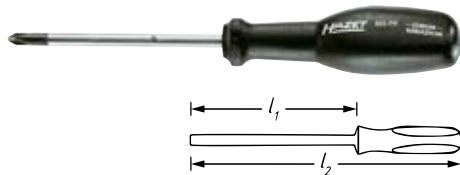

¹⁾ Blade with hex bolster for use with a wrench, allows application of high separation forces

HAZET No.	l_1 mm	l_2 mm	mm	EAN-No. 4000896+
803-PH 0	60	140	-	077557
803-PH 1	80	173	-	077564
803-PH 2	100	210	-	077571
803-PH 3 ¹⁾	150	272	13	077588
803-PH 4 ¹⁾	200	334	16	077595

803 LG-PH Screwdriver trinamic®

- **Extra long design**
- Round blade
- Ergonomically shaped 1-component trinamic handle

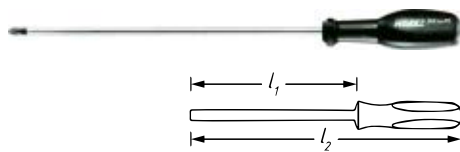

HAZET No.	l_1 mm	l_2 mm	EAN-No. 4000896+
803 LG-PH 1	250	343	077601
803 LG-PH 2	250	360	077618

803-PZ Screwdriver trinamic®

- Marking ring blue
- Round blade
- Ergonomically shaped 1-component trinamic handle

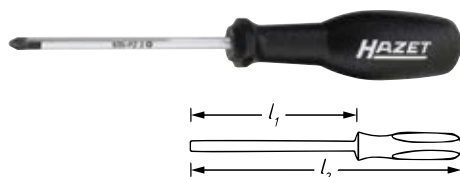

HAZET No.	l_1 mm	l_2 mm	EAN-No. 4000896+
803-PZ 1	80	173	077632
803-PZ 2	100	210	077649

803-T Screwdriver trinamic®

- **Made in Germany**
- Round blade
- Ergonomically shaped 1-component trinamic handle

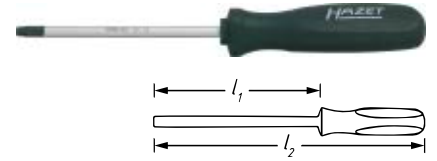

HAZET No.	l_1 mm	l_2 mm	mm	EAN-No. 4000896+
803-T 6	48	112	1.67	077670
803-T 7	48	112	1.99	077687
803-T 8	55	127	2.31	077694
803-T 9	55	127	2.50	077700
803-T 10	70	150	2.74	077717
803-T 15	70	150	3.27	077724
803-T 20	84	175	3.86	077731
803-T 25	84	175	4.43	077748
803-T 27	99	200	4.99	077755
803-T 30	99	200	5.52	077762
803-T 40	99	217	6.65	086214

803 LG-T Screwdriver trinamic®

- Application e.g. at the dashboard, car body, engine compartment as well as industry applications
- Long design
- Round blade
- Ergonomically shaped 1-component trinamic handle

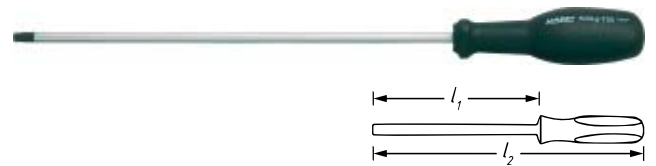

HAZET No.	l_1 mm	l_2 mm	mm	EAN-No. 4000896+
803 LG-T 15	250	330	3.27	087785
803 LG-T 20	250	343	3.86	087792
803 LG-T 25	250	345	4.43	087808
803 LG-T 30	250	360	5.52	087815

Screwdriver for electricians

See chapter Tools with protective insulation / Tools for electricians page 279



803 Screwdriver set

- Safety-Insert-System, 2-component soft foam insert. Insert also suitable for HAZET Assistant



2/3		
-----	--	--

- 801 NK • 1 x 5.5
- 803 • 0.4 x 2.5 • 0.5 x 3 • 0.6 x 3.5 • 0.8 x 4 • 1.2 x 6.5 • 1.2 x 8
- 801 NK-PH • PH 2
- 803-PZ • PZ 1 • PZ 2
- 803-PH • PH 1 • PH 2 • PH 3

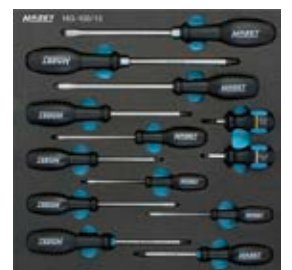

HAZET No.	L x W mm	mm	EAN-No. 4000896+
163-100/13	344x342	13	145713



Hand tools

Screwdrivers / Bits



805 C Clip screwdriver

Made in Germany

The versatile screwdriver for everyday use – always ready to hand

- With fibre-reinforced scraper for damage-free removal of stickers etc.
- Clip for holding, e.g. in breast or sleeve pocket
- Rotating clip – for improved handling
- Round blade
- Plastic handle
- Surface: blade chrome-plated

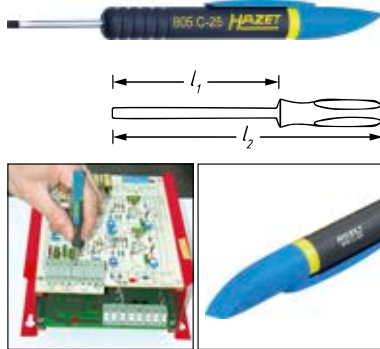

HAZET No.	l_1 mm	l_2 mm	$\frac{b}{d}$ mm	b mm	EAN-No. 4000896+
805 C-25	30	130	0.4	2.5	089123

805 Electronic screwdriver

- For smallest screws
- With revolving head
- Firm grip thanks to recessed handle
- Round blade
- 2-component handle
- Surface: tip burnished



HAZET No.	l_1 mm	l_2 mm	$\frac{b}{d}$ mm	b mm	EAN-No. 4000896+
805-02	60	153	0.4	2	032594
805-025	75	168	0.4	2.5	032600
805-03	75	168	0.5	3	032617

805 Electronic screwdriver set

- Plastic box
- 2-component handle
- \ominus 0.3 x 1.5 · 0.4 x 2 · 0.4 x 2.5 · 0.5 x 3
- \oplus PH00 · PH0 · PH1



HAZET No.	L x W x H mm		EAN-No. 4000896+
805/7	205 x 125 x 20	7	032655

808 Electronic screwdriver set

- Plastic box
- 2-component handle
- \odot T5 · T6 · T7 · T8 · T9 · T10 · T15



808 Electronic screwdriver set

HAZET No.	L x W x H mm		EAN-No. 4000896+
808/7	205 x 125 x 20	7	055050

805 Electronic screwdriver set

- Safety-Insert-System, 2-component soft foam insert. Insert also suitable for HAZET Assistant

1/3 +			

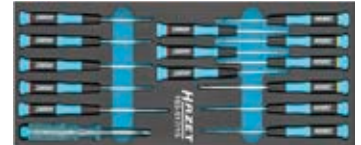

HAZET No.	L x W mm		EAN-No. 4000896+
163-517/15	392 x 172	15	218745

For HAZET Assistant with drawer depth of 398 mm:
173 · 179 · 179N · 179NX · 179W · 179NW · 179BIG-1 · 179XL · 179NXL · 179XXL · 179NXXL · 179AXXL · 179TXXL · 180

805 · \ominus , \oplus , \odot

805/7 · 808/7 · 0.5 x 2.8

163-517/15 392x172 15 218745

839 Phase tester

Made in Germany

- 220 – 250 V
- Slotted blade, concave ground
- With clip
- Defective glow tube not replaceable according to VDE
- Round blade
- Plastic handle
- Surface: with protective insulation
- DIN VDE 06800-6

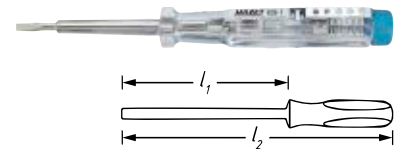

HAZET No.	l_1 mm	l_2 mm	$\frac{b}{d}$ mm	b mm	EAN-No. 4000896+
839-1	65	145	0.5	2.8	035670

426 Nut-driver · flexible

Made in Germany

- Blade shape: Flexible
- Ergonomically shaped 1-component trinamic handle

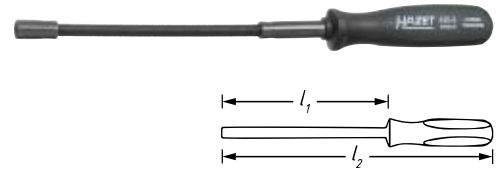

HAZET No.	l_1 mm	l_2 mm	EAN-No. 4000896+
426- 5	190	300	019243
426- 6	190	300	019250
426- 7	190	300	019267
426- 8	190	300	019274
426-10	190	300	019236



428 Nut-driver · with T-handle

Made in Germany

- Short design
- Ergonomically shaped HAZET 2-component T-handle
- Surface: chrome-plated

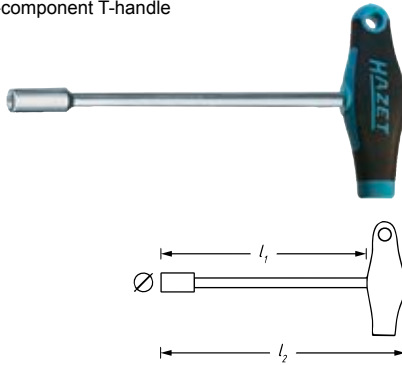

HAZET No.	l_1 mm	l_2 mm	\varnothing mm	EAN-No. 4000896+
• Calibrating the radar head of the Adaptive Cruise Control (ACC) in e.g. AUDI and VW vehicles				
428- 3.5	230	256	7.2	218509
428- 6	230	256	9	019397
428- 7	230	256	11	019410
428- 8	230	264	12	019427
428-10	230	264	14	019281
428-11	230	264	16	019304
428-12	230	264	17	019328
428-13	230	264	18	019335

428 Nut-driver set · with T-handle

Made in Germany

- Safety-Insert-System, 2-component soft foam insert. Insert also suitable for HAZET Assistant
- 2-component T-handle

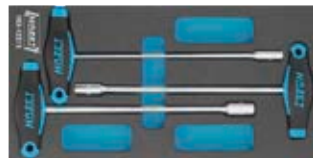

HAZET No.	$L \times W$ mm	\varnothing mm	EAN-No. 4000896+
163-122/3	342x172	3	153534

428 LG Nut-driver · with T-handle

Made in Germany

- Long design
- Ergonomically shaped HAZET 2-component T-handle
- Surface: chrome-plated

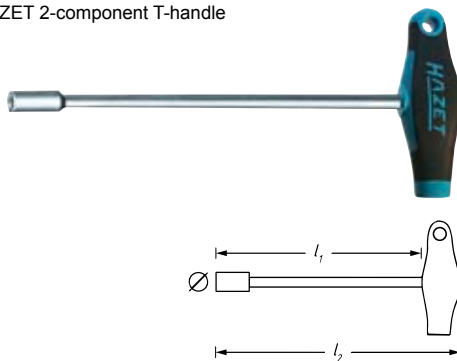

HAZET No.	l_1 mm	l_2 mm	\varnothing mm	EAN-No. 4000896+
428 LG- 8	350	384	12	019601
428 LG-10	350	384	14	019526
428 LG-13	350	384	18	019557

828 Screwdriver · with T-handle

- 6-point blade
- Ergonomically shaped HAZET 2-component T-handle
- Surface: chrome-plated, tips burnished

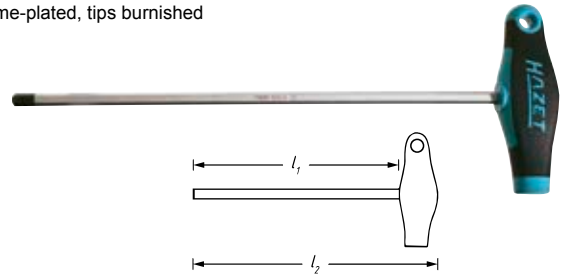

HAZET No.	S mm	l_1 mm	l_2 mm	EAN-No. 4000896+
828- 2	2	100	118	034123
828- 2.5	2.5	100	118	034130
828- 3	3	150	168	034161
828- 4	4	150	176	034192
828- 5	5	200	226	034222
828- 6	6	200	234	034246
828- 7	7	200	234	210060
828- 8	8	200	234	034260
828-10	10	200	234	034109

828 LG Screwdriver · with T-handle

- 6-point blade
- Ergonomically shaped HAZET 2-component T-handle
- Surface: chrome-plated, tips burnished

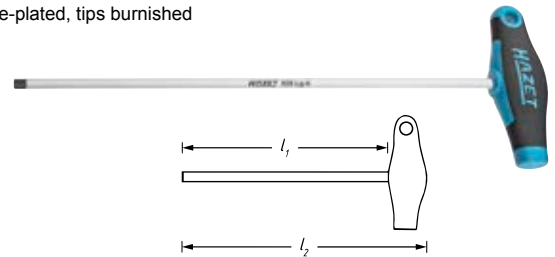

HAZET No.	S mm	l_1 mm	l_2 mm	EAN-No. 4000896+
828 LG-6	6	300	334	226672

828-T Screwdriver · with T-handle

- Round blade
- Ergonomically shaped HAZET 2-component T-handle
- Surface: chrome-plated, tips burnished

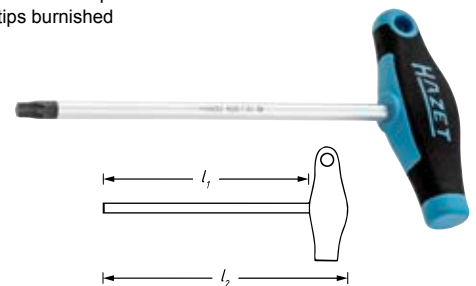

HAZET No.	l_1 mm	l_2 mm	\varnothing mm	EAN-No. 4000896+
828-T 6	80	98	1.67	034451
828-T 7	80	98	1.99	034468
828-T 8	80	98	2.31	034475
828-T 9	80	98	2.50	034482
828-T 10	100	126	2.74	034291
828-T 15	100	126	3.27	034307
828-T 20	100	126	3.86	034321
828-T 25	110	136	4.43	034345
828-T 27	120	146	4.99	034376
828-T 30	130	156	5.52	034383
828-T 40	130	164	6.65	034413
828-T 45	130	164	7.82	034420



Hand tools

Screwdrivers / Bits



828 Screwdriver set · with T-handle

- Safety-Insert-System, 2-component soft foam insert. Insert also suitable for HAZET Assistant
- 2-component T-handle



1/3				
-----	--	--	--	--



828-T ·
T6 · T7 · T8 · T9 · T10 · T15 · T20 · T25 · T30

HAZET No.	L x W mm		EAN-No. 4000896+
163-182/9	342x172	9	162352

828 LG-T Screwdriver · with T-handle

Made in Germany

- Extra long design
- Round blade
- Ergonomically shaped HAZET 2-component T-handle
- Surface: chrome-plated, tips burnished

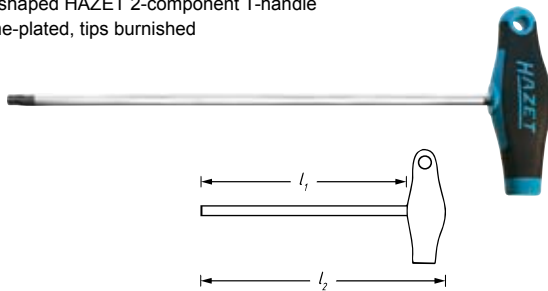

HAZET No.	l ₁ mm	l ₂ mm	mm	EAN-No. 4000896+
828 LG-T 20	200	226	3.86	139941
828 LG-T 30	290	316	5.52	116638
828 LG-T 40	290	325	6.65	235360

829 KK Screwdriver · with T-handle

- 6-point blade
- With ball-head
- Ergonomically shaped HAZET 2-component T-handle
- Surface: chrome-plated, tips burnished

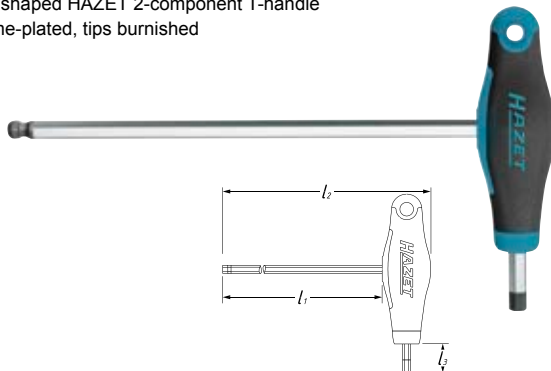

HAZET No.	S mm	l ₁ mm	l ₂ mm	l ₃ mm	EAN-No. 4000896+
829 KK-2	2	100	118	15	232895
829 KK-2.5	2.5	100	118	15	232901
829 KK-3	3	150	168	15	232918
829 KK-4	4	150	176	20	232925
829 KK-5	5	200	226	20	233038
829 KK-6	6	200	234	25	233045
829 KK-8	8	200	234	25	233052

829 KK Screwdriver set · with T-handle

- 6-point blade
- With ball-head
- Ergonomically shaped HAZET 2-component T-handle
- Surface: chrome-plated, tips burnished



829 KK ·
2 · 2.5 · 3 · 4 · 5 · 6 · 8

HAZET No.		EAN-No. 4000896+
829 KK/7	7	232888

829 KKT Screwdriver · with T-handle

- Round blade
- With ball-head
- Ergonomically shaped HAZET 2-component T-handle
- Surface: chrome-plated, tips burnished

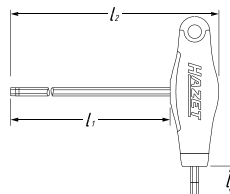

HAZET No.	l ₁ mm	l ₂ mm	l ₃ mm	mm	EAN-No. 4000896+
829 KKT-T 9	80	98	15	2.50	233069
829 KKT-T 10	80	98	15	2.74	233137
829 KKT-T 15	100	126	20	3.27	233144
829 KKT-T 20	100	126	20	3.86	233168
829 KKT-T 25	110	136	20	4.43	233175
829 KKT-T 30	130	156	20	5.52	233182
829 KKT-T 40	130	164	25	6.65	233199

829 KKT Screwdriver set · with T-handle

- Round blade
- With ball-head
- Ergonomically shaped HAZET 2-component T-handle
- Surface: chrome-plated, tips burnished



829 KKT ·
T9 · T10 · T15 · T20
T25 · T30 · T40

HAZET No.		EAN-No. 4000896+
829 KKT/7	7	233014



2100 Offset screwdriver

- Surface: nickel-plated
- DIN ISO 2936

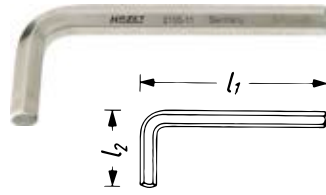

1) Not according to DIN

HAZET No.	S mm	l ₁ mm	l ₂ mm	EAN-No. 4000896+
2100-015	1.5	46.5	15.5	011261
2100-02	2	52	18	011278
2100-025	2.5	58.5	20.5	011285
2100-03	3	66	23	011308
2100-04	4	74	29	011322
2100-05	5	85	33	011346
2100-06	6	96	38	011353
2100-07	7	102	41	011360
2100-08	8	108	44	011377
2100-09 ¹⁾	9	119	47	011391
2100-10	10	122	50	011407
2100-11 ¹⁾	11	130	53	011414
2100-12	12	137	57	011421
2100-14	14	154	70	011445
2100-17	17	177	80	011452
2100-19	19	199	89	011469
2100-22	22	222	102	011476
2100-24	24	248	114	011483
2100-27	27	277	127	011490

2100 Offset screwdriver set

- Plastic tool holder
- Surface: nickel-plated
- DIN ISO 2936



HAZET No.	EAN-No. 4000896+
2100 • ○ 3 • 4 • 5 • 6 • 8 • 10	
2100/6H	011551

- With ring
- Surface: nickel-plated
- DIN ISO 2936



HAZET No.	EAN-No. 4000896+
Metric dimensions 2100 • ○ 2 • 2.5 • 3 • 4 • 5 • 6 • 8	
2100/7R	011599
American dimensions 2100A • ○ 5/16	
2100A/7R	011773

2100 Offset screwdriver set

- Plastic roll
- Surface: nickel-plated
- DIN ISO 2936



HAZET No.	EAN-No. 4000896+
Metric dimensions 2100 • ○ 2 • 3 • 4 • 5 • 6 • 7 • 8 • 9 • 10 • 12	
2100/10P	011506
Metric dimensions 2100 • ○ 2 • 3 • 4 • 5 • 6 • 7 • 8 • 9 • 10 • 12 • 14 • 17 • 19 • 22	
2100/14P	011537
American dimensions 2100A • ○ 5/64 • 3/32 • 1/8 • 5/32 • 3/16 • 7/32 • 1/4 • 5/16 • 3/8 • 1/2 • 9/16 • 5/8 • 3/4	
2100A/13P	011766

- Plastic hinged tool holder
- Surface: nickel-plated
- DIN ISO 2936

s 2.5 • 3 • 4 • 5 • 6 • 8



HAZET No.	EAN-No. 4000896+
2100/6 KH	072590

2105LG Offset screwdriver

- Ball head end = swivel range 20°
- Extra long design
- With ball-head
- Surface: nickel-plated

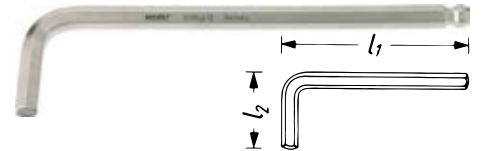
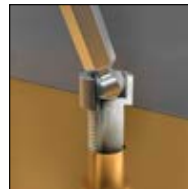

HAZET No.	S mm	l ₁ mm	l ₂ mm	EAN-No. 4000896+
2105LG-015	1.5	91.5	15.5	011896
2105LG-02	2	102	18	011902
2105LG-025	2.5	114.5	20.5	011919
2105LG-03	3	129	23	011926
2105LG-04	4	144	29	011933
2105LG-05	5	165	33	011940
2105LG-06	6	186	38	011957
2105LG-07	7	197	41	011964
2105LG-08	8	208	44	011971
2105LG-10	10	234	50	011988
2105LG-12	12	262	57	011995



Hand tools

Screwdrivers / Bits



2105LG Offset screwdriver set

- Extra long design
- With ball-head
- Plastic tool holder
- Surface: nickel-plated



HAZET No.	Icon	EAN-No. 4000896+
2105LG • O		
1.5 • 2 • 2.5 • 3 • 4 • 5 • 6 • 8 • 10		
2105LG/9H	9	012015
Ø 0.05 • 1/16 • 5/64 • 3/32 • 1/8 • 5/32 • 3/16 • 7/32 • 1/4 • 5/16		
2105ALG • O	-	
2105ALG/10H	10	083749

2115 Offset screwdriver

Germany Made in Germany

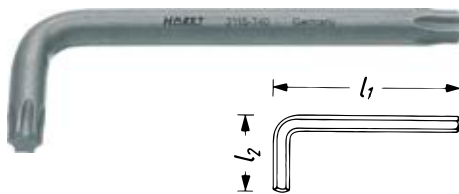

HAZET No.	l ₁ mm	l ₂ mm	Icon	EAN-No. 4000896+
2115-T 6	44.5	18.5	1.67	012220
2115-T 7	50.5	18.5	1.99	012244
2115-T 8	51	19	2.31	012251
2115-T 9	51	19	2.50	012268
2115-T 10	54	20	2.74	012121
2115-T 15	57.5	21.5	3.27	012138
2115-T 20	61	23	3.86	012145
2115-T 25	64.5	24.5	4.43	012152
2115-T 27	69.5	26.5	4.99	012169
2115-T 30	76	30	5.52	012176
2115-T 40	83	33	6.65	012183
2115-T 45	91	37	7.82	012190
2115-T 50	104	41	8.83	012206
2115-T 55	120	47	11.22	012213
2115-T 60	134	52	13.25	012237

2115 Offset screwdriver set

- With ring



2115 Offset screwdriver set



HAZET No.	Icon	EAN-No. 4000896+
2115 • O		
T 8 • T 10 • T 15 • T 20 • T 25 • T 30 • T 40		
2115-T/7R	7	012114

- Plastic roll



HAZET No.	Icon	EAN-No. 4000896+
2115 • O		
T 7 • T 8 • T 9 • T 10 • T 15 • T 25 • T 27 • T 30 • T 40 • T 45 • T 50 • T 55 • T 60		
2115-T/13P	13	012107

- Plastic hinged tool holder
- O T 9 • T 10 • T 15 • T 20 • T 25 • T 27 • T 30 • T 40



HAZET No.	Icon	EAN-No. 4000896+
2115/8 KH	8	072583

2116LG Offset screwdriver set

Germany Made in Germany

- With ball-head
- Plastic tool holder
- O T 9 • T 10 • T 15 • T 20 • T 25 • T 27 • T 30 • T 40



HAZET No.	Icon	EAN-No. 4000896+
2116LG/8H	8	051519



At a glance

The HAZET bit range

6.3 1/4"		Profile	
	Screwdriver bit Slot		2208 N 0,4 x 1,5 – 1,2 x 8
	Screwdriver bit Phillips-Recess PH		2215 N PH1 – PH3
	Screwdriver bit Phillips-Recess PH		2215 N S Lg PH1 – PH3
	Screwdriver bit Phillips-Recess PZ (Pozidriv)		2216 N PZ1 – PZ3
	Screwdriver bit Phillips-Recess PZ (Pozidriv)		2216 N S Lg PZ1 – PZ3
	Screwdriver bit Inside TORX [®]		2223 N T6 – T40
	Screwdriver bit Inside TORX [®]		2223 N S Lg T10 – T40
	Screwdriver bit Inside TORX [®]		2223 Lg-T 25 T25 · T30
	Screwdriver bit Tamper TORX [®]		2223 NH T7H – T40H
	Screwdriver bit Inside hexagon		2204 N 2 – 8
	Screwdriver bit Inside hexagon		2204 N S Lg 3 – 8
	Screwdriver bit Internal serration (XZN)		2211 M4 · M5
	Screwdriver bit Inside 5-star bits with pin		2225 10H – 40H
8 5/16"		Profile	
	Screwdriver bit Slot		2210 0,8 x 5,5 – 2 x 12
	Screwdriver bit Phillips-Recess PH		2217 PH1 – PH4
	Screwdriver bit Phillips-Recess PZ (Pozidriv)		2218 PZ1 – PZ4
	Screwdriver bit Inside TORX [®]		2224 T25 – T55
	Screwdriver bit Inside TORX [®]		2224 S Lg T30 – T50
	Screwdriver bit Inside hexagon		2206 5 – 10
	Screwdriver bit Internal serration (XZN)		2212 M6 – M10



HAZET range of screwdriver bits

Screwdriver bits for every situation

The HAZET Colorcode

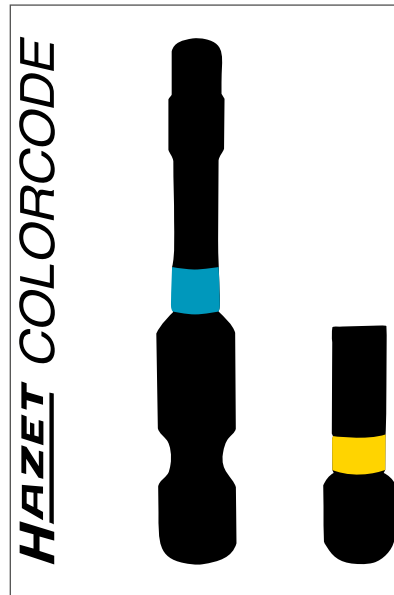
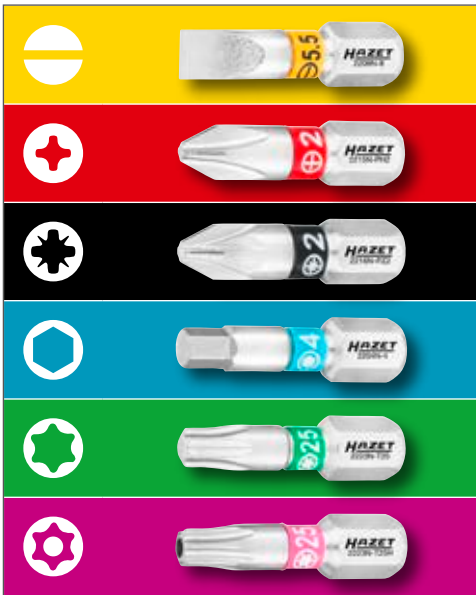



Optimised torsion zone

for best power transmission on the profile / screw

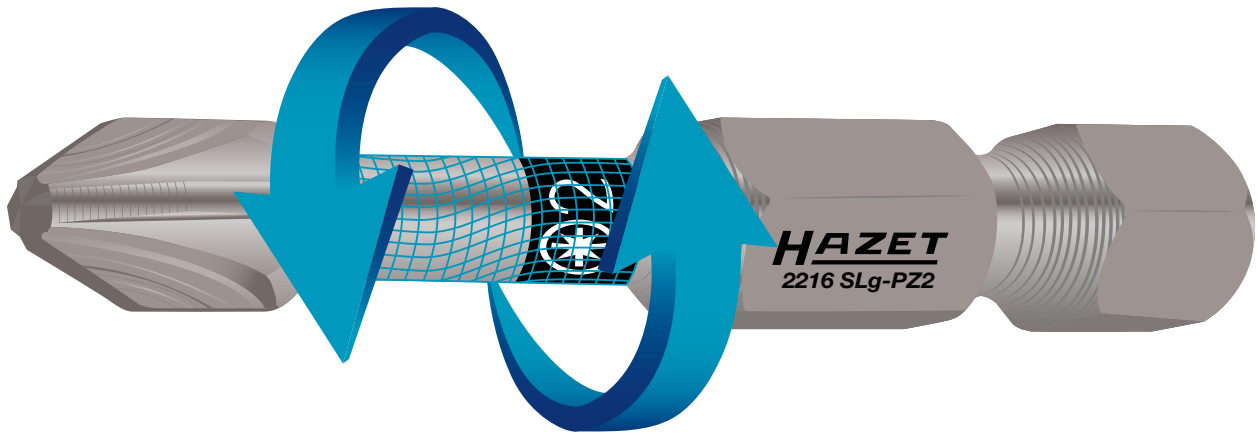

Specially hardened material

prevents the risk of premature breakage to the screwdriver bit



Extra long service life

due to perfectly coordinated geometries

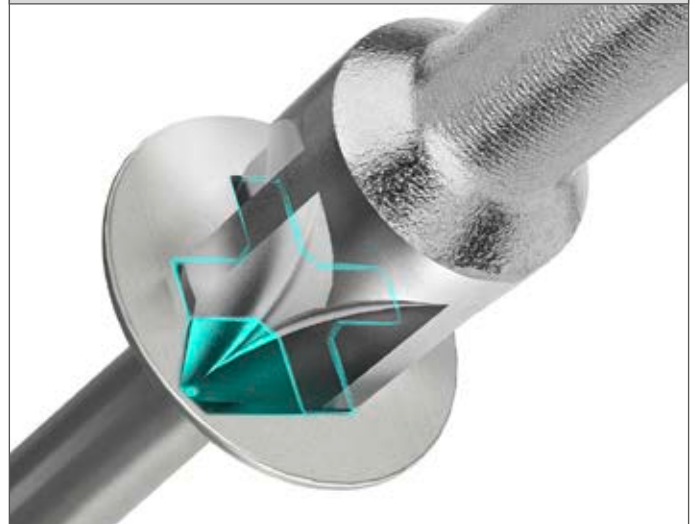

Manual and impact operation

equally suitable
(also for impact wrenches)



Guarantees finding

the profile quickly due to distinctive HAZET
colour coding (Colorcode) on the screwdriver bit

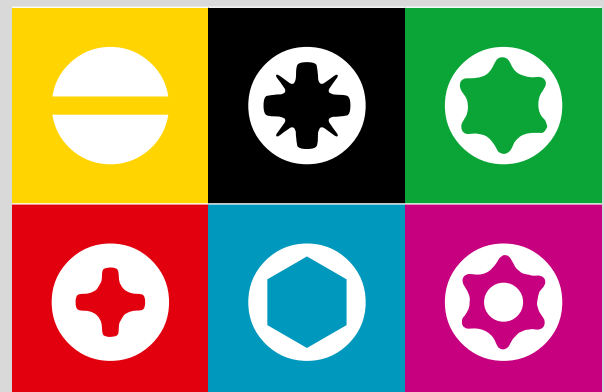



Hand tools

Screwdrivers / Bits



2200 Socket set

- Plastic box 165-S (1/9)
- Safety-Insert-System, 2-component soft foam insert. Insert also suitable for HAZET Assistent



1/9			
-----	--	--	--



- | | | |
|--|---|-------------------------|
| <p>850 • • 1/4</p> <p>5 • 5.5 • 6 • 7</p> <p>8 • 9 • 10 • 11</p> <p>12 • 13 • 14</p> | <p>2215 N • • 1/4</p> <p>PH1 • PH2</p> | <p>2239-3 • • 1/4</p> |
| <p>2204 N • • 1/4</p> <p>2 • 2.5 • 3 • 4 • 5 • 6 • 8</p> | <p>2216 N • • 1/4</p> <p>PZ1 • PZ2</p> | <p>863 HPB • 1/4</p> |
| <p>2208 N • • 1/4</p> <p>0.5x4 • 0.6x4.5</p> <p>1.2x6.5 • 0.8x5.5</p> | <p>2223 N • • 1/4</p> <p>T10H • T15H • T20H</p> <p>T25H • T30H • T40H</p> | <p>2304 N • • 1/4</p> |
| <p>2238-1 • • 1/4</p> | | |

HAZET No.	L x W x H mm		EAN-No. 4000896+
2200/36	185x153x52	36	063734

2240 N Screwdriver bit set

- Long-lasting bits clamp for firm and secure hold and quick access
- Clear labelling of the individual bit versions and sizes
- Optimal utilisation of the available storage space with small dimensions
- Specially developed hinge design enables the bit box to be set up at right angles (90°) and in a fully open position (180°). Allowing for a better overview and faster access for the user
- Plastic box



- | | | |
|--|---|--|
| <p>2204 N • • 1/4</p> <p>3 • 4 • 5 • 6</p> | <p>2216 N • • 1/4</p> <p>PZ1 • PZ2 • PZ3</p> | <p>2223 N • • 1/4</p> <p>T20H • T30H</p> |
| <p>2208 N • • 1/4</p> <p>0.6x4.5 • 0.8x5.5 • 1x6</p> | <p>2223 N • • 1/4</p> <p>T10 • T15 • T20 • T25</p> <p>T27 • T30 • T40</p> | <p>2239 N-6 • • 1/4</p> |
| <p>2215 N • • 1/4</p> <p>PH1 • PH2 • PH3</p> | | |

HAZET No.	L x W x H mm		EAN-No. 4000896+
2240 N/36	125x85x40	36	187614

2240 N Screwdriver bit set

- Long-lasting bits clamp for firm and secure hold and quick access
- Clear labelling of the individual bit versions and sizes
- Optimal utilisation of the available storage space with small dimensions
- Specially developed hinge design enables the bit box to be set up at right angles (90°) and in a fully open position (180°). Allowing for a better overview and faster access for the user
- Plastic box
- Staggered arrangement of the bits (interleaved) ensures tremendous space saving in the top and bottom of the bit box



- | | | | |
|---|--|---|--|
| <p>2204 N • • 1/4</p> <p>2 • 2.5 • 3 • 4 • 5</p> <p>6</p> | <p>2215 N • • 1/4</p> <p>PH1 • PH2 • PH3</p> | <p>2223 N • • 1/4</p> <p>T 6 • T 7 • T 8</p> <p>T 9 • T10 • T15</p> <p>T20 • T25 • T27</p> <p>T30 • T40</p> | <p>2223 N • • 1/4</p> <p>T10H • T15H</p> <p>T20H • T25H</p> <p>T27H • T30H</p> |
| <p>2208 N • • 1/4</p> <p>0.5x4 • 0.6x4.5</p> <p>0.8x5.5 • 1x6</p> | <p>2216 N • • 1/4</p> <p>PZ1 • PZ2 • PZ3</p> | | <p>2239 N-6 • • 1/4</p> |

HAZET No.	L x W x H mm		EAN-No. 4000896+
2240 N/51	125x85x40	51	187607





2200 SmartCase screwdriver bit set

- HAZET SmartCase – be smart – In any case**
- Developed and produced „Made in Germany“
 - Innovative concept of a compact, foldable tool set
 - Easy to clean material and pleasant surface feel
 - Combines the advantages of a slim and light soft surface (black) with the durability of a hard-shell tool box
 - Durable, robust tool holder – no tools rolling around or rattling
 - Magnetic fastener – quick to open and wear-free
 - Stable and easily accessible tool storage
 - Maximum number of tools in the smallest space for the best overview
 - Optimal overview and easy removal of the tool – can be folded flat or – similar to a tablet case – can be stood up
 - Including bit for 0.4 x 1.5 mm slot profile, for e.g. glasses repair
 - 33 bits 25 mm long · 12 bits 50 mm long



HAZET SMART CASE

DESIGNED & PRODUCED IN GERMANY

- | | | | |
|--------------------------------|--------------------------------------|-------------------|--|
| 810BHK · | 2208 N · | 2216 N · | 2223 N · |
| | 0.5x4 · 0.6x4.5
0.8x5.5 · 1.2x6.5 | PZ1 · PZ2 · PZ3 | T 6 · T 7 · T 8
T 9 · T10 · T15
T20 · T25 · T27
T30 · T40 |
| 2239N-6 · | 2208 NSLG · | 2216 NSLG · | 2223 NSLG · |
| | 0.8x5.5 | PZ1 · PZ2 | T20 · T25 · T30 |
| 2304 N · | 2215 N · | 2204 N · | 2223 N · |
| | PH1 · PH2 · PH3 | 2 · 3 · 4 · 5 · 6 | T10H · T15H
T20H · T25H
T27H · T30H
T40H |
| 2100 · | 2215 NSLG · | 2204 NSLG · | |
| 1.5 · 2 · 2.5 · 3
4 · 5 · 6 | PH1 · PH2 | 3 · 4 · 5 · 6 | |

HAZET No.	L x W x H mm		EAN-No. 4000896+
2200 SC-1	130x118x50	69	239252

2200 SmartCase socket set

- HAZET SmartCase – be smart – In any case**
- Developed and produced „Made in Germany“
 - Innovative concept of a compact, foldable tool set
 - Easy to clean material and pleasant surface feel
 - Combines the advantages of a slim and light soft surface (black) with the durability of a hard-shell tool box
 - Durable, robust tool holder – no tools rolling around or rattling
 - Magnetic fastener – quick to open and wear-free
 - Stable and easily accessible tool storage
 - Maximum number of tools in the smallest space for the best overview
 - Optimal overview and easy removal of the tool – can be folded flat or – similar to a tablet case – can be stood up
 - 21 bits 25 mm long · 12 bits 50 mm long



DESIGNED & PRODUCED IN GERMANY

2200 SmartCase socket set

- HAZET SMART CASE**
- | | | | |
|--|----------------------------|---|-----------------|
| 863HPB · | 2208 N · | 2215 NSLG · | 2204 NSLG · |
| | 0.5x4 · 0.6x4.5
1.2x6.5 | PH1 · PH2 | 3 · 4 · 5 · 6 |
| 850 · | 2216 N · | 2223 N · | |
| 4 · 5 · 5.5 · 6
7 · 8 · 9 · 10
11 · 12 · 13 · 14 | PZ1 · PZ2 · PZ3 | T10 · T15 · T20
T25 · T27 · T30
T40 | |
| 867-4 · | 2208 NSLG · | 2216 NSLG · | 2223 NSLG · |
| | 0.8x5.5 | PZ1 · PZ2 | T20 · T25 · T30 |
| 2304 N · | 2215 N · | 2204 N · | |
| | PH1 · PH2 · PH3 | 2 · 3 · 4 · 5 · 6 | |

HAZET No.	L x W x H mm		EAN-No. 4000896+
2200 SC-2	130x118x50	50	239603

2200 SmartCase screwdriver bit set

- HAZET SmartCase – be smart – In any case**
- Developed and produced „Made in Germany“
 - Innovative concept of a compact, foldable tool set
 - Easy to clean material and pleasant surface feel
 - Combines the advantages of a slim and light soft surface (black) with the durability of a hard-shell tool box
 - Durable, robust tool holder – no tools rolling around or rattling
 - Magnetic fastener – quick to open and wear-free
 - Stable and easily accessible tool storage
 - Maximum number of tools in the smallest space for the best overview
 - Optimal overview and easy removal of the tool – can be folded flat or – similar to a tablet case – can be stood up
 - 42 bits 25 mm long · 19 bits 50 mm long



HAZET SMART CASE

- | | | |
|---|-----------------|--|
| 2204 N · | 2215 N · | 2223 N · |
| 2 · 2.5 · 3 · 4 · 5 · 6 · 7 · 8 | PH1 · PH2 · PH3 | T 6 · T 7 · T 8 · T 9
T10 · T15 · T20 · T25
T27 · T30 · T40 |
| 2204 NSLG · | 2215 NSLG · | 2223 N · |
| 3 · 4 · 5 · 6 | PH1 · PH2 | T 7H · T 8H · T 9H
T10H · T15H · T20H
T25H · T27H · T30H
T40H |
| 2208 N · | 2216 N · | 2223 NSLG · |
| 0.4x1.5 · 0.5x4 · 0.6x4.5
0.8x5.5 · 1x6 · 1.2x6.5
1.2x8 | PZ1 · PZ2 · PZ3 | T20 · T25 · T30 |
| 2208 NSLG · | 2216 NSLG · | 2304 N · |
| 0.8x5.5 | PZ1 · PZ2 | |

HAZET No.	L x W x H mm		EAN-No. 4000896+
2200 SC-3	130x118x50	96	244522



Hand tools

Screwdrivers / Bits



2200 SmartCase screwdriver bit set

HAZET SmartCase – be smart – In any case

- Developed and produced „Made in Germany“
- Innovative concept of a compact, foldable tool set
- Easy to clean material and pleasant surface feel
- Combines the advantages of a slim and light soft surface (black) with the durability of a hard-shell tool box
- Durable, robust tool holder – no tools rolling around or rattling
- Magnetic fastener – quick to open and wear-free
- Stable and easily accessible tool storage
- Maximum number of tools in the smallest space for the best overview
- Optimal overview and easy removal of the tool – can be folded flat or – similar to a tablet case – can be stood up
- 31 bits 25 mm long · 12 bits 50 mm long · 12 bits 89 mm extra long



2200 SmartCase socket set

HAZET SmartCase – be smart – In any case

- Developed and produced „Made in Germany“
- Innovative concept of a compact, foldable tool set
- Easy to clean material and pleasant surface feel
- Combines the advantages of a slim and light soft surface (black) with the durability of a hard-shell tool box
- Durable, robust tool holder – no tools rolling around or rattling
- Magnetic fastener – quick to open and wear-free
- Stable and easily accessible tool storage
- Maximum number of tools in the smallest space for the best overview
- Optimal overview and easy removal of the tool – can be folded flat or – similar to a tablet case – can be stood up
- 15 bits 25 mm long · 12 bits 50 mm long · 12 bits 89 mm extra long



HAZET
**SMART
CASE**



HAZET
**SMART
CASE**

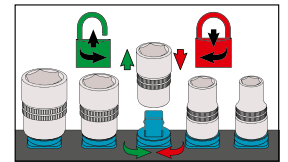

810 BHK

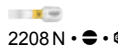

2208 N
0.4x1.5 · 0.6x4.5
1.2x6.5

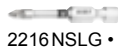

2216 NSLG
PZ2



863 HPB

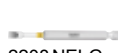

2208 NELG
0.8x5.5

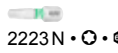

2223 N
T 6 · T 7 · T 8 · T 9
T 10 · T 15 · T 20 · T 25
T 27 · T 30 · T 40



2100 · O
1.5 · 2 · 2.5 · 3 · 4 · 5 · 6



2208 NSLG
0.8x5.5

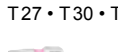

2223 N
T 10H · T 15H · T 20H
T 25H · T 27H · T 30H
T 40H

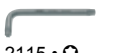

2115 · O
T 10 · T 15 · T 20
T 25 · T 30 · T 40

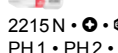

2215 N
PH1 · PH2 · PH3

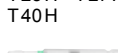

2223 NELG
T 20 · T 25 · T 30

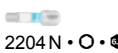

2204 N
3 · 4 · 5 · 6



2215 NELG
PH1 · PH2

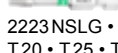

2223 NSLG
T 20 · T 25 · T 30

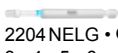

2204 NELG
3 · 4 · 5 · 6

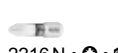

2215 NSLG
PH2

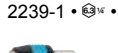

2239-1
2239 N-6

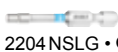

2204 NSLG
3 · 4



2216 N
PZ1 · PZ2 · PZ3



2239 N-6
2304 N



810 BHK

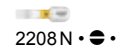

2208 N
0.4x1.5

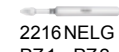

2216 NELG
PZ1 · PZ2



850
5.5 · 6 · 7 · 8
10 · 11 · 12 · 13

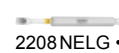

2208 NELG
0.8x5.5

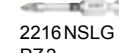

2216 NSLG
PZ2



863 HPB



2208 NSLG
0.8x5.5

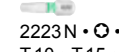

2223 N
T 10 · T 15 · T 20
T 25 · T 30 · T 40

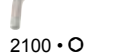

2100 · O
1.5 · 2 · 2.5 · 3 · 4 · 5 · 6

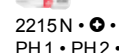

2215 N
PH1 · PH2 · PH3

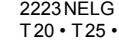

2223 NELG
T 20 · T 25 · T 30

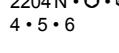

2204 N
4 · 5 · 6

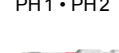

2215 NELG
PH1 · PH2



2223 NSLG
T 20 · T 25 · T 30

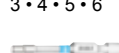

2204 NELG
3 · 4 · 5 · 6

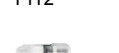

2215 NSLG
PH2

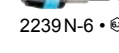

2239-1
2239 N-6

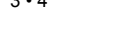

2204 NSLG
3 · 4

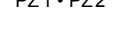

2216 N
PZ1 · PZ2

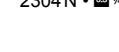

2304 N

HAZET No.	L x W x H mm		EAN-No. 4000896+
2200 SC-31	210x118x50	73	244539

HAZET No.	L x W x H mm		EAN-No. 4000896+
2200 SC-32	210x118x50	59	244546



2300 SmartHolder tool holder

- Handy tool holder, tool set – for craftsmen or for home DIY – a perfect supplement to the tool case
- Extremely convenient and compact to store the maximum number of tools in minimal space while offering the best overview
- HAZET SmartHolder – Developed and produced „Made in Germany“
- Stable and easily accessible tool storage
- Easy to clean
- Screwdriver bit magazine with kickstand set up using the button on the side
- Bit strips push away against each other – all bits are easy to remove
- Tool storage with bit holder – set up by simply pulling on one of the two tools
- When closed, all parts are always safely locked in place – it's impossible for parts to fall out. To remove, turn the socket and pull it out upwards
- Redesigned mini solid steel fine-tooth reversible ratchet - 60 teeth - 6° operating angle for working in restricted spaces
- Bit holder (length: 80 mm) with magnet for securing bits
- 18 bits 25 mm long · 11 bits 50 mm long
- Bit adapter
- 6 sockets

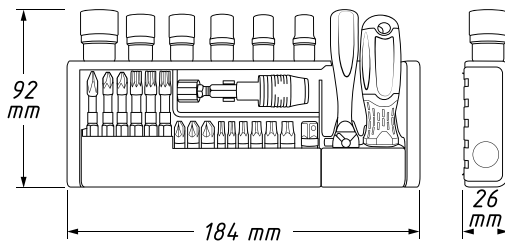

reddot winner 2023



HAZET SMART HOLDER

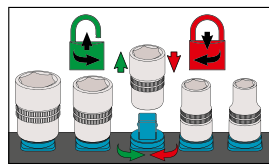

810BMK •



850 • • 5.5 • 7 • 8 • 10 • 12 • 13



863MB •



2204N • • 3 • 4 • 5 • 6 • 8



2204NSLG • • 3 • 4 • 5 • 6

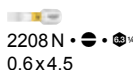

2208N • • 0.6x4.5



2208NSLG • • 0.8x5.5

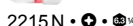

2215N • • PH1 • PH2 • PH3



2215NSLG • • PH2



2216N • • PZ1 • PZ2 • PZ3



2216NSLG • • PZ1 • PZ2



2223N • • T10 • T15 • T20 T25 • T30 • T40



2223NSLG • • T20 • T25 • T30



2239N-6 • •



2304N • •

2304 SmartHolder tool holder

- Handy tool holder, tool set – for craftsmen or for home DIY – a perfect supplement to the tool case
- Extremely convenient and compact to store the maximum number of tools in minimal space while offering the best overview
- HAZET SmartHolder – Developed and produced „Made in Germany“
- Stable and easily accessible tool storage
- Easy to clean
- Screwdriver bit magazine with kickstand set up using the button on the side
- Bit strips push away against each other – all bits are easy to remove
- Tool storage with bit holder – set up by simply pulling on one of the two tools
- When closed, all parts are always safely locked in place – it's impossible for parts to fall out



HAZET SMART HOLDER



2204N • • 3 • 4 • 5 • 6

2208N • • 0.5x4 • 1.2x6.5

2215N • • PH1 • PH2 • PH3

2223N • • T10 • T15 • T20 T25 • T27 • T30 T40

HAZET No.

2304 SH-1



16

EAN-No.

4000896+

250677



HAZET No.	L x W x H mm		EAN-No. 4000896+
2300 SH-1	184x92x26	39	246588



Hand tools

Screwdrivers / Bits



2304 SmartHolder tool holder

- Handy tool holder, tool set – for craftsmen or for home DIY – a perfect supplement to the tool case
- Extremely convenient and compact to store the maximum number of tools in minimal space while offering the best overview
- HAZET SmartHolder – Developed and produced „Made in Germany“
- Stable and easily accessible tool storage
- Easy to clean
- Screwdriver bit magazine with kickstand set up using the button on the side
- Bit strips push away against each other – all bits are easy to remove
- Tool storage with bit holder – set up by simply pulling on one of the two tools
- When closed, all parts are always safely locked in place – it's impossible for parts to fall out

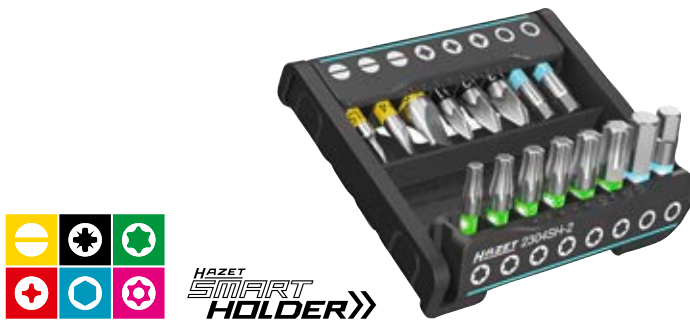

2204 N • O •	2204 NSLG • O •
3 • 4 • 5 • 6	3 • 4 • 5
2208 N • •	2215 NSLG • •
1.2x6.5 • 0.4x1.5	PH 1 • PH 2
0.5x4	
PZ 1 • PZ 2 • PZ 3	2223 NSLG • •
	T 20 • T 25
T 10 • T 15 • T 20	
T 25 • T 30 • T 40	

HAZET No.		EAN-No. 4000896+
2304 SH-2	16	250653

2304 SmartHolder tool holder

- Handy tool holder, tool set – for craftsmen or for home DIY – a perfect supplement to the tool case
- Extremely convenient and compact to store the maximum number of tools in minimal space while offering the best overview
- HAZET SmartHolder – Developed and produced „Made in Germany“
- Stable and easily accessible tool storage
- Easy to clean
- Screwdriver bit magazine with kickstand set up using the button on the side
- Bit strips push away against each other – all bits are easy to remove
- Tool storage with bit holder – set up by simply pulling on one of the two tools
- When closed, all parts are always safely locked in place – it's impossible for parts to fall out

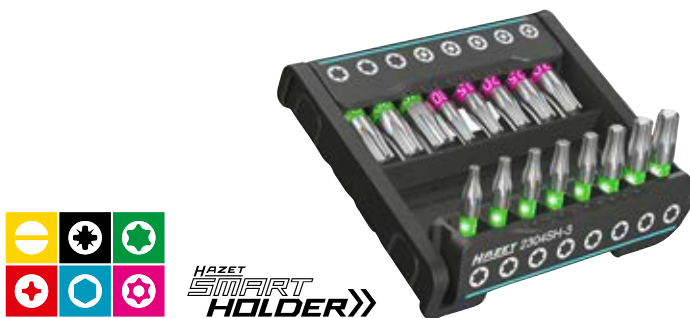

2223 N • •	2223 N • •
T 6 • T 7 • T 8 • T 9 • T 10 • T 15	T 10H • T 15H • T 20H • T 25H • T 30H
T 20 • T 25 • T 27 • T 30 • T 40	

HAZET No.		EAN-No. 4000896+
2304 SH-3	16	250639

2304 SmartHolder tool holder

- Handy tool holder, tool set – for craftsmen or for home DIY – a perfect supplement to the tool case
- Extremely convenient and compact to store the maximum number of tools in minimal space while offering the best overview
- HAZET SmartHolder – Developed and produced „Made in Germany“
- Stable and easily accessible tool storage
- Easy to clean
- Screwdriver bit magazine with kickstand set up using the button on the side
- Bit strips push away against each other – all bits are easy to remove
- Tool storage with bit holder – set up by simply pulling on one of the two tools
- When closed, all parts are always safely locked in place – it's impossible for parts to fall out



2204 NSLG • O •	2215 NSLG • •	2223 NSLG • •
3 • 4 • 5	PH 1 • PH 2	T 20 • T 25

HAZET No.		EAN-No. 4000896+
2304 SH-11	8	250615

2304 SmartHolder tool holder

- Handy tool holder, tool set – for craftsmen or for home DIY – a perfect supplement to the tool case
- Extremely convenient and compact to store the maximum number of tools in minimal space while offering the best overview
- HAZET SmartHolder – Developed and produced „Made in Germany“
- Stable and easily accessible tool storage
- Easy to clean
- Screwdriver bit magazine with kickstand set up using the button on the side
- Bit strips push away against each other – all bits are easy to remove
- Tool storage with bit holder – set up by simply pulling on one of the two tools
- When closed, all parts are always safely locked in place – it's impossible for parts to fall out



2204 NSLG O •	2208 NSLG •	2216 NSLG •	2223 NSLG •
4 • 5 • 6	0.8x5.5	PZ 1 • PZ 2	T 20 • T 25

HAZET No.		EAN-No. 4000896+
2304 SH-12	8	250592



2304 SmartHolder tool holder

- Handy tool holder, tool set – for craftsmen or for home DIY – a perfect supplement to the tool case
- Extremely convenient and compact to store the maximum number of tools in minimal space while offering the best overview
- HAZET SmartHolder – Developed and produced „Made in Germany“
- Stable and easily accessible tool storage
- Easy to clean
- Screwdriver bit magazine with kickstand set up using the button on the side
- Bit strips push away against each other – all bits are easy to remove
- Tool storage with bit holder – set up by simply pulling on one of the two tools
- When closed, all parts are always safely locked in place – it's impossible for parts to fall out



HAZET SMART HOLDER

2223 NSLG • •

T20 • T25 • T30

HAZET No.		EAN-No. 4000896+
2304SH-13	8	250578

2208 Bit

- Hexagon drive ISO 1173 C6.3 (1/4"), ISO 2351-1 C6,3



HAZET No.	l mm	$\frac{d}{b}$ mm	b mm		EAN-No. 4000896+
2208 N-2/3	25	0.4	1.5	3	238309
2208 N-4/3	25	0.5	4	3	238316
2208 N-6/3	25	0.6	4.5	3	238323
2208 N-8/3	25	0.8	5.5	3	238330
2208 N-9/3	25	1	6	3	238347
2208 N-10/3	25	1.2	6.5	3	238354
2208 N-11/3	25	1.2	8	3	238361

2208 NELG Bit

- Extra long design
- Hexagon drive ISO 1173 C6.3 (1/4"), ISO 2351-1 C6,3



HAZET No.	l mm	$\frac{d}{b}$ mm	b mm	EAN-No. 4000896+
2208 NELG-8	89	0.8	5.5	244119

2215 Bit

- Hexagon drive ISO 1173 C6.3 (1/4"), ISO 2351-2 C6,3



HAZET No.	l mm		EAN-No. 4000896+
2215 N-PH1/3	25	3	238378
2215 N-PH2/3	25	3	238385
2215 N-PH3/3	25	3	238392

2215 SLG Bit

- Long design
- Hexagon drive ISO 1173 C6.3 (1/4"), ISO 2351-2 C6,3



HAZET No.	l mm		EAN-No. 4000896+
2215 NSLg-PH1/3	50	3	239009
2215 NSLg-PH2/3	50	3	239016
2215 NSLg-PH3/3	50	3	239023

2215 NELG Bit

- Extra long design
- Hexagon drive ISO 1173 C6.3 (1/4"), ISO 2351-2 C6,3



HAZET No.	l mm	EAN-No. 4000896+
2215 NELg-PH1	89	244041
2215 NELg-PH2	89	244058

2216 Bit

- Hexagon drive similar to ISO 1173 C6.3 (1/4")



HAZET No.	l mm		EAN-No. 4000896+
2216 N-PZ1/3	25	3	238408
2216 N-PZ2/3	25	3	238415
2216 N-PZ3/3	25	3	238422

2216 SLG Bit

- Long design
- Hexagon drive similar to ISO 1173 C6.3 (1/4")



HAZET No.	l mm		EAN-No. 4000896+
2216 NSLg-PZ1/3	50	3	239030
2216 NSLg-PZ2/3	50	3	239047
2216 NSLg-PZ3/3	50	3	239054



Hand tools

Screwdrivers / Bits



2216NELG Bit

- Extra long design
- Hexagon drive similar to ISO 1173 C6.3 (1/4")



HAZET No.	l mm	EAN-No. 4000896+
2216NELg-PZ1	89	244065
2216NELg-PZ2	89	244072

2223 Bit

- Hexagon drive ISO 1173 C6.3 (1/4")



HAZET No.	l mm	Ø mm	Profile	EAN-No. 4000896+
2223 N-T 6/3	25	1.67	3	238439
2223 N-T 7/3	25	1.99	3	238446
2223 N-T 8/3	25	2.31	3	238453
2223 N-T 9/3	25	2.50	3	238460
2223 N-T 10/3	25	2.74	3	238477
2223 N-T 15/3	25	3.27	3	238484
2223 N-T 20/3	25	3.86	3	238491
2223 N-T 25/3	25	4.43	3	238507
2223 N-T 27/3	25	4.99	3	238514
2223 N-T 30/3	25	5.52	3	238521
2223 N-T 40/3	25	6.65	3	238538

2223SLG Bit

- Long design
- Hexagon drive ISO 1173 C6.3 (1/4")



HAZET No.	l mm	Ø mm	Profile	EAN-No. 4000896+
2223 NSLg-T 10/3	50	2.74	3	239115
2223 NSLg-T 15/3	50	3.27	3	239122
2223 NSLg-T 20/3	50	3.86	3	239139
2223 NSLg-T 25/3	50	4.43	3	239146
2223 NSLg-T 27/3	50	4.99	3	239153
2223 NSLg-T 30/3	50	5.52	3	239160
2223 NSLg-T 40/3	50	6.65	3	239177

2223NELG Bit

- Extra long design
- Hexagon drive ISO 1173 C6.3 (1/4")



HAZET No.	l mm	Ø mm	EAN-No. 4000896+
2223 NELg-T20	89	3.86	244089
2223 NELg-T25	89	4.43	244096
2223 NELg-T30	89	5.52	244102

2223LG Bit

Germany **Made in Germany**

- Long design
- Hexagon drive similar to ISO 1173 C6.3 (1/4")



HAZET No.	l mm	Ø mm	EAN-No. 4000896+
2223 LG-T25	65	4.43	015061

2223LG Bit

Germany **Made in Germany**

- Long design
- Hexagon drive similar to ISO 1173 C6.3 (1/4")
- Round blade
- For all MERCEDES-BENZ passenger cars model year → 2011 with bolted air bag unit



HAZET No.	l mm	Ø mm	EAN-No. 4000896+
2223 LG-T 30	70	5.52	015092

2223 Bit

- Hexagon drive ISO 1173 C6.3 (1/4")



HAZET No.	l mm	Ø mm	Profile	EAN-No. 4000896+
2223 N-T 7 H/3	25	1.99	3	238545
2223 N-T 8 H/3	25	2.31	3	238552
2223 N-T 9 H/3	25	2.50	3	238569
2223 N-T 10 H/3	25	2.74	3	238576
2223 N-T 15 H/3	25	3.27	3	238583
2223 N-T 20 H/3	25	3.86	3	238590
2223 N-T 25 H/3	25	4.43	3	238613
2223 N-T 27 H/3	25	4.99	3	238606
2223 N-T 30 H/3	25	5.52	3	238620
2223 N-T 40 H/3	25	6.65	3	238637

2204 Bit

- Hexagon drive ISO 1173 C6.3 (1/4"), ISO 2351-3 C6,3



HAZET No.	S mm	l mm	Profile	EAN-No. 4000896+
2204 N-2/3	2	25	3	238224
2204 N-2.5/3	2.5	25	3	238231
2204 N-3/3	3	25	3	238248
2204 N-4/3	4	25	3	238255
2204 N-5/3	5	25	3	238262
2204 N-6/3	6	25	3	238279
2204 N-7/3	7	25	3	238286
2204 N-8/3	8	25	3	238293

2204SLG Bit

- Long design
- Hexagon drive ISO 1173 C6.3 (1/4"), ISO 2351-3 C6,3



HAZET No.	S mm	l mm	Profile	EAN-No. 4000896+
2204 NSLg-3/3	3	50	3	239061
2204 NSLg-4/3	4	50	3	239078
2204 NSLg-5/3	5	50	3	239085
2204 NSLg-6/3	6	50	3	239092
2204 NSLg-8/3	8	50	3	239108



2204 NELG Bit

- Extra long design
- Hexagon drive ISO 1173 C6.3 (1/4"), ISO 2351-3 C6,3



HAZET No.	S mm	l mm	EAN-No. 4000896+
2204 NELg-3	3	89	243990
2204 NELg-4	4	89	244003
2204 NELg-5	5	89	244010
2204 NELg-6	6	89	244027

2211 Bit

- **Made in Germany**
- DIN 65254, Hexagon drive ISO 1173 C6.3 (1/4")



HAZET No.	l mm	EAN-No. 4000896+
2211-4	25	056392
2211-5	25	056408

2225 5-star bit

- **Made in Germany**
- Operation of inside 5-star screws with pin
- Hexagon drive ISO 1173 C6.3 (1/4")



HAZET No.	l mm	EAN-No. 4000896+
2225-10 H	25	097043
2225-15 H	25	097050
2225-20 H	25	097067
2225-25 H	25	097074
2225-27 H	25	097081
2225-30 H	25	097098
2225-40 H	25	097104

863-Bit 1/4" Reversible ratchet for screwdriver bits · fine-tooth

- **Made in Germany**
- A lot more power than with ratchets with the same dimensions

- Latching function of the shift lever provides protection against unwanted switching
- Increased service life thanks to the use of state-of-the-art lubricants in the ratchet mechanism
- Strict production tolerances prevent dirt from getting in
- HAZET internal quality standards guarantee loading capacity far beyond the standard requirements
- Chrome-plated surface: High-quality, easy to clean, corrosion resistant
- Integrated suspension option in the handle
- VPA tested, static torque according to DIN 3122: 120 Nm (DIN: 62 Nm)
- Number of teeth: 90 (Opening angle 4°)
- With locking spring to securely hold the bits
- HAZET 2-component handle
- Surface: chrome-plated

HiPer
HIGH PERFORMANCE
THE ORIGINAL
MADE IN GERMANY



863-Bit 1/4" Reversible ratchet for screwdriver bits · fine-tooth



HAZET No.	l mm	EAN-No. 4000896+
863 HPB	116	235346

863-Bit 1/4" Reversible ratchet · solid steel · for bits

- **Made in Germany**
- 90 mm short design

- Number of teeth: 60 (Opening angle 6°)
- With locking spring to securely hold the bits
- Surface: chrome-plated



HAZET No.	l mm	EAN-No. 4000896+
863 MB	90	212187

Wear? – No problem!

- HAZET tools are manufactured to the highest quality. During long intensive loading there is a certain level of wear even for high-quality tools.
- For this reason, there are spare parts and replacement sets available for many of our tools.



Please also see our spare parts shop
www.hazet.de/ersatzteil-shop

Cost-saving – Sustainable – Resource-saving!
For long-term pleasure with your HAZET tools

863 Replacement set

- **Made in Germany**

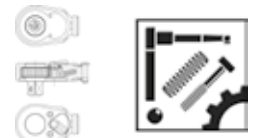

HAZET No.	EAN-No. 4000896+
<ul style="list-style-type: none"> • Replacement set for shift lever consisting of: shift lever · pawl · screws · ball · compression spring For HAZET reversible ratchet 863K · 863 · 863G · 863P · 863PC · 863Q · 863S · 863ST · 863BGL · 863BKC · 863BK · 863MC · 863Mbit · 2264 	144600
<ul style="list-style-type: none"> • Replacement set for bit ratchet wheel $\odot 6.3 = 1/4"$ consisting of: assembly tool · cover plate · bit ratchet wheel · circlip · cover disc · shift lever · spring sleeve · ball · compression spring · pawl · grease For reversible ratchet 863HPB 	241279
<ul style="list-style-type: none"> • Replacement set for ratchet wheel $\odot 6.3 = 1/4"$ consisting of: ratchet wheel · pawl · shift lever · screws · ball · compression spring For HAZET reversible ratchet 863BGL · 863BKC · 863BK · 863Mbit · 2264 	015917



Hand tools

Screwdrivers / Bits



810 BH Bit holder

• Versatile and flexible for home and workshop



- The perfect addition to HAZET bit sets
- Special design prevents unwanted rolling away
- With bayonet fitting for a secure hold of bits
- Non-slip HAZET 3-component handle – allows high power transmission

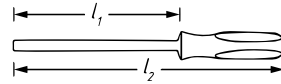

HAZET No.	l_1 mm	l_2 mm	EAN-No. 4000896+
810 BH	22.5	132.5	217175

810 BHK Bit holder

• Versatile and flexible for home and workshop



- The perfect addition to HAZET bit sets
- Special design prevents unwanted rolling away
- Screwdriver bits can be accommodated without operating the sleeve – screwdriver bit can also be inserted in locked state
- The screwdriver bit is removed simply pushing it forward – quick bit change with only one hand
- Strong permanent magnet to hold the screwdriver bits securely in place
- With bayonet fitting for a secure hold of bits
- Non-slip HAZET 3-component handle – allows high power transmission

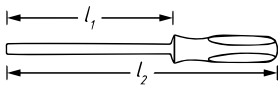

HAZET No.	l_1 mm	l_2 mm	EAN-No. 4000896+
810 BHK	28.5	98.2	237579

810 BMK Bit holder

• With magnet for a secure hold of bits

• 2-component handle

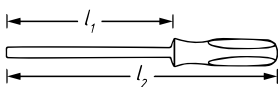

HAZET No.	l_2 mm	EAN-No. 4000896+
810 BMK	80	246090



810 SPC Bit holder

- 6-point blade
- With magnet for a secure hold of bits
- Non-slip HAZET 3-component handle – allows high power transmission
- Surface: matt chrome-plated

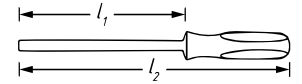

HAZET No.	l_1 mm	l_2 mm	EAN-No. 4000896+
810 SPC-6.3	100	210	165827

810 R Ratcheting bit screwdriver

• Integrated storage handle



- Ratchet function is convertible or for use as normal screwdriver
- Bit magazine easy to open by pressing a button in combination with pulling
- Comfortable to hold, offers effective impact
- Length: 170 mm (closed, without extension)
- Extension: 80 mm

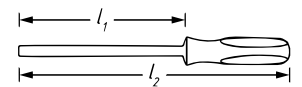

2208 N • • • •	2216 N • • •	2223 N • • •
0.5x4 • 1.2x6.5	PZ1 • PZ2	T15 • T20 • T25
2215 N • • •	2204 N • • •	
PH1 • PH2	4 • 5 • 6	

HAZET No.	l_1 mm	l_2 mm		EAN-No. 4000896+
810 R-3	170	250	13	239658

• Integrated storage handle



- Ratchet function is convertible or for use as normal screwdriver
- Bit magazine easy to open by pressing a button in combination with pulling
- Comfortable to hold, offers effective impact
- Length: 170 mm (closed, without extension)
- Extension: 80 mm

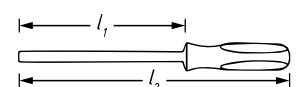

2208 N • • • •	2215 N • • •	2204 N • • •	2223 N • • •
0.8x5.5	PH1 • PH2	3 • 4 • 5 • 6	T15 • T20 • T25 T27 • T30

HAZET No.	l_1 mm	l_2 mm		EAN-No. 4000896+
810 R-4	170	250	13	239665



866 BH Bit holder

- Bit holders with magnets for securely holding the screwdriver bits
- Flexible length adjustment for universal application
- Telescopic in 10 mm detent points
Blade length from handle: 205 – 358 mm
- 6-fold locking ball on the bayonet fitting for high pressure absorption
- Telescopic tube made from stainless steel
- 6-fold locking ball
- Magnetic force: 1000 g
- With magnet for a secure hold of bits
- Ergonomically shaped HAZET 2-component T-handle

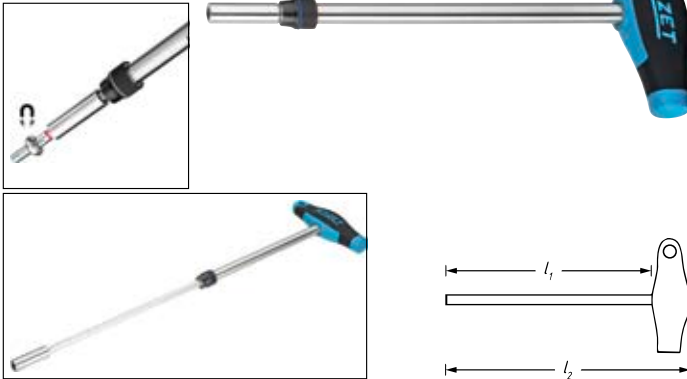

HAZET No.	l ₁ mm	l ₂ mm	EAN-No. 4000896+
866 BH-14			249336

- Bit holders with magnets for securely holding the screwdriver bits
- Flexible use due to two bit holding options in only one tool
- Two location notches for screwdriver bits
- Magnetic force: 1000 g each
- With magnet for a secure hold of bits
- Ergonomically shaped HAZET 2-component T-handle



HAZET No.	l ₁ mm	l ₂ mm	EAN-No. 4000896+
866 BH-4	7.5	63	249329

2255 Bit holder

- **Made in Germany**
- Flexible
- Plastic handle

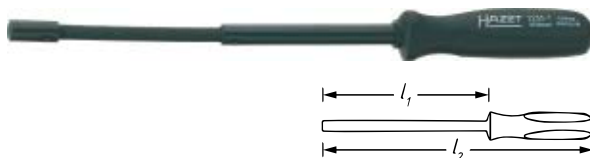

HAZET No.	l ₁ mm	l ₂ mm	EAN-No. 4000896+
2255-1	200	310	050079

2265 Reversible ratchet for bits

- For screwdriver bits with drive $\varnothing 6.3 = 1/4"$, and $\varnothing 8 = 5/16"$
- Surface: bright chrome-plated
- Straight design



HAZET No.	l mm	EAN-No. 4000896+
2265-1	140	079636

2239 Adapter

- **Made in Germany**
- Stainless steel socket
- Hexagon drive burnished
- With magnet for a secure hold of bits
- DIN 7427-B, ISO 1173
- For power screwdrivers
 - E 6.3 mm → $\varnothing D 6.3 = 1/4"$
e.g. AEG, Atlas Copco, Black & Decker, Bosch



HAZET No.	l mm	EAN-No. 4000896+
2239-3	75	015399

- Stainless steel socket
- Hexagon drive burnished
- With magnet for a secure hold of bits
- DIN 7427-B, ISO 1173



HAZET No.	l mm	EAN-No. 4000896+
2239-50	50	246717

- Screwdriver bits can be accommodated without operating the sleeve – screwdriver bit can also be inserted in locked state
- The screwdriver bit is removed simply pushing it forward – quick bit change with only one hand
- Strong permanent magnet to hold the screwdriver bits securely in place
- Hexagon drive burnished
- With bayonet fitting for a secure hold of bits
- DIN 7427-B, ISO 1173



HAZET No.	l mm	EAN-No. 4000896+
2239 N-6	60	238934





Hand tools

Screwdrivers / Bits



2239 Adapter

- Extra-long shank for deep-lying screw connections in narrow working areas
- Magnetic force: 1000 g each
- With magnet for a secure hold of bits

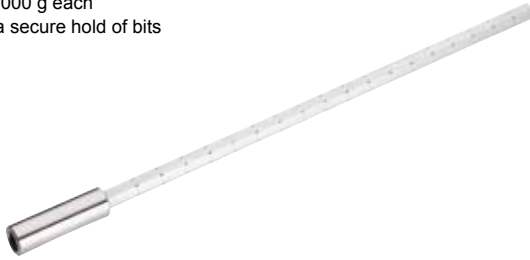

HAZET No.	l mm	EAN-No. 4000896+
2239-9	212	249343

2304 Adapter

- With locking ball
- Surface: phosphatized, oiled



HAZET No.	l mm	EAN-No. 4000896+
• Adapter = 1/4" → = 1/4"		
2304 N	25	238071
• Adapter = 3/8" → = 1/2"		
2311	38	016068

2238 Adapter

- **Made in Germany**
- For the connection of sockets = 1/4" (DIN 3120 – A 6.3) and operating tools with drive = 1/4", (ISO 1173-E 6.3)
- With locking ball
- Surface: burnished, oiled



HAZET No.	l mm	EAN-No. 4000896+
2238-1	50	063741

2250 Adapter

- **Made in Germany**
- Inside square and inside hexagon sockets
- With locking spring to securely hold the bits
- Surface: chrome-plated



HAZET No.	l mm	EAN-No. 4000896+
• = 1/4" → = 1/4"		
2250-1	23.5	015443
• = 3/8" → = 1/4"		
2250-2	30	015450
• = 1/2" → = 1/4"		
2250-4	35	015504

2272 Impact bit screwdriver set

- Impact operation of tight screw connections
- Up to 80 Nm loosening and tightening torque
- Switchable (right- and left-hand threads)
- Pretension impact screwdriver by rotating the handle left (loosening or right-hand thread) or right (tightening or left-hand thread) before every impact. Hit the head section of the impact screwdriver with a 300 g hammer
- No electricity, compressed air or other resources needed
- Plastic box 165-S (1/9)
- Safety-Insert-System, 2-component soft foam insert. Insert also suitable for HAZET Assistant



1/9				

2206 • •	2217 • •	2272 •
5 • 6 • 8 • 10	PH2 • PH3 • PH4	
2210 • •	2224 • •	
0.8x5.5 • 1x5.5 • 1.2x6.5	T30 • T40 • T45 • T50	
1.6x8 • 2x12		

HAZET No.	L x W x H mm		EAN-No. 4000896+
2272/23 N	185x153x52	23	192687

2210 Bit

- **Made in Germany**
- Hexagon drive ISO 1173 C8 (5/16"), ISO 2351-1 C8



HAZET No.	l mm		b mm	EAN-No. 4000896+
2210- 8	41	0.8	5.5	014477
2210- 9	41	1	5.5	014484
2210-10	41	1.2	6.5	014422
2210-12	41	1.6	8	014446
2210-14	41	2	12	014460

2217 Bit

- **Made in Germany**
- Hexagon drive ISO 1173 C8 (5/16"), ISO 2351-2 C8



1) Reinforced design

HAZET No.	l mm	EAN-No. 4000896+
2217-PH 1	32	014651
2217-PH 2	32	014668
2217-PH 3	32	014682
2217-PH 4 ¹⁾	38	014699



2218 Bit

Made in Germany

- Hexagon drive similar to ISO 1173 C8 (5/16")



¹⁾ Reinforced design

HAZET No.	l mm	EAN-No. 4000896+
2218-PZ1	32	014705
2218-PZ2	32	014712
2218-PZ3	32	014729
2218-PZ4 ¹⁾	38	014736

2224 Bit

Made in Germany

- Hexagon drive ISO 1173 C8 (5/16")



HAZET No.	l mm	Ø mm	EAN-No. 4000896+
2224-T25	35	4.43	015115
2224-T27	35	4.99	015122
2224-T30	35	5.52	015139
2224-T40	35	6.65	015160
2224-T45	35	7.82	015177
2224-T50	35	8.83	015184
2224-T55	35	11.22	015191

2224 SLG Bit

Made in Germany

- Long design
- Hexagon drive ISO 1173 C8 (5/16")



HAZET No.	l mm	Ø mm	EAN-No. 4000896+
2224 S Lg-T30	100	5.52	015245
2224 S Lg-T40	100	6.65	015252
2224 S Lg-T45	100	7.82	015269
2224 S Lg-T50	100	8.83	015283

2206 Bit

Made in Germany

- Hexagon drive ISO 1173 C8 (5/16"), ISO 2351-3 C8



¹⁾ Not according to ISO 2351-3

HAZET No.	S mm	l mm	EAN-No. 4000896+
2206-5	5	30	014262
2206-6	6	30	014279
2206-7	7	30	151349
2206-8	8	30	014286
2206-10 ¹⁾	10	30	014255

2212 Bit

Made in Germany

- DIN 65254, Hexagon drive ISO 1173 C8 (5/16")



HAZET No.	l mm	EAN-No. 4000896+
2212- 6	32	056415
2212- 8	32	056422
2212-10	32	056439

2272 Impact bit screwdriver

- Impact operation of tight screw connections
- Up to 80 Nm loosening and tightening torque
- Switchable (right- and left-hand threads)
- Pretension impact screwdriver by rotating the handle left (loosening or right-hand thread) or right (tightening or left-hand thread) before every impact. Hit the head section of the impact screwdriver with a 300 g hammer
- No electricity, compressed air or other resources needed



HAZET No.	l mm	EAN-No. 4000896+
2272	165	015979

8808 S 5/16" → 3/8" Impact adapter

Made in Germany

- Fixation of impact sockets with □ drive 10 = 3/8"
- With locking pin retaining
- Surface: steel grey, oiled



HAZET No.	l mm	EAN-No. 4000896+
8808 S-1	75	040032

2250 Adapter

Made in Germany

- Inside square and inside hexagon sockets
- With locking spring to securely hold the bits
- Surface: chrome-plated

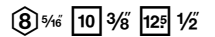

HAZET No.	l mm	EAN-No. 4000896+
2250-3	31	015474
2250-5	36	015511





Hand tools

Pliers



Pliers



Combination pliers [1850] / Heavy-duty combination pliers [1851]		232
Diagonal cutters [1802 – 1804]		232–233
Flat nose pliers / snipe nose pliers [1841]		233
End cutting / tower pincers [1810]		234
Universal pliers [760] / Swedish pattern wrench [2183]		234–235
Circlip pliers [1845 / 1846 / 1847]		235–238
Grip pliers [752 – 758]		239–240
Hose clamp pliers [798]		240–243
Pliers with protective insulation [759 VDE / 1816 VDE – 1860 VDE]		280–281
Crimping pliers [4656 / 4658]		282
Spark plug socket pliers [1849] / Glow plug socket pliers [4760]		412/416
Piston ring pliers [790]		418
Valve stem seal ring pliers [791 / 2991]		418–419
Fuel line pliers [4501]		421
Flexible hose clamp [4590]		422
Brake spring pliers [796 / 797]		447
Clamp pliers [1847]		463
Balance weight pliers [665]		467
Sheet metal profile snips [1961]/ Flange tool [1932] / Sheet metal punch [1964]		476–477
Hand riveting tool [1963]		477





The surface of the HAZET pliers

Top quality for a long service life

Bright chrome-plated



- Resistant to tarnishing
- Resistant to air, water, diluted acids and most alkalis
- Protection against corrosion and wear
- Elegant appearance

Polished and sand-blasted



- Non-glaring
- Increased scratch resistance, therefore longer service life

The handles

Ergonomically shaped



① Maximum safety with slip protection

② 2-component handle – excellent touch and feel with hard and soft zones distributed throughout

③ Ergonomically shaped – therefore free of fatigue in continuous operation

The wire classes

Cutting values according to DIN ISO 5744:

Material examples	Wire hardness	Tensile strength N/mm ²		
	Medium-hard	approx. 800	Nail, wire pin	
	Hard wire	approx. 1600	Steel wire, cable fibre	
	Piano wire	approx. 2300	Spring steel wire	



Hand tools

Pliers



Pictogram key

	For flat material on pliers
	For round material on pliers
	Centre cutter
	Flush cutter
	Round-nose pliers

	Flat nose pliers
	Snipe nose pliers
	Inside lockrings
	Outside lockrings

Small HAZET pliers basics

Joint types

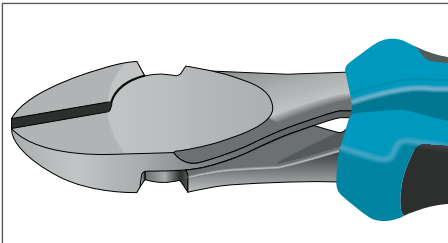
**Lay-on slip joint:**

Here the two halves of the pliers sit on top of each other without special elaboration.

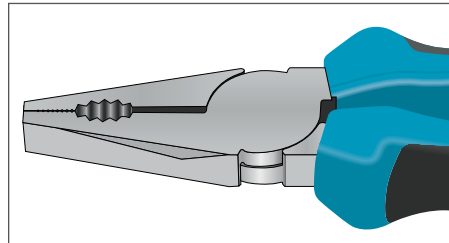
**Lap joint:**

Here each shank of the pliers is wrought as far as half way inside the joint area in such a way that both shanks sit optimally inside each other

**Box joint:**

Here one half of the pliers shank is slotted so that the other half can be pushed through with an exact fit. Advantage: with the two-sided mounting of the joint bolt and the double guidance of the pliers' inside shank, this joint connection can withhold high loads.

Jaw forms



Flat



Snipe nose

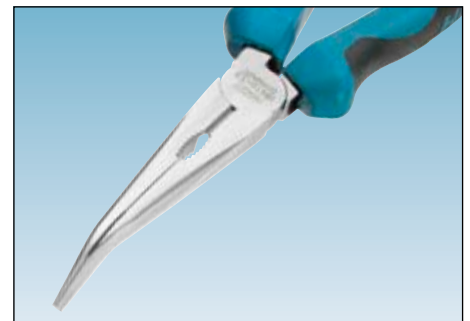

Obtusely curved

Gripping area

- Chequered in accordance with DIN ISO 5742





Pliers

1850 Combination pliers

Made in Germany

- Induction-hardened cutting edges with grind
- Cutting edge hardness: 60 HRC
- Ergonomically shaped HAZET 2-component plastic handle covers (blue/black)
- Surface: bright chrome-plated
- DIN ISO 5746



HAZET No.	l mm	Rm N/mm ² ○ 800	Rm N/mm ² ● 1600	EAN-No. 4000896+
1850-22	170	3	2	007141
1850-33	190	3.2	2.2	007165

1850 M Combination pliers

Made in Germany

- Induction-hardened cutting edges with grind
- Cutting edge hardness: 60 HRC
- Ergonomically shaped HAZET 2-component plastic handle covers (blue/black)
- Surface: polished, blasted
- DIN ISO 5746



HAZET No.	l mm	Rm N/mm ² ○ 800	Rm N/mm ² ● 1600	EAN-No. 4000896+
1850 M-22	160	2.5	1.8	145034
1850 M-33	180	2.8	2.5	144747

1851 Heavy-duty combination pliers

Made in Germany

- **Optimum leverage ratio due to small distance between joint and cutting edges**

- Induction-hardened cutting edges with grind
- Cutting edge hardness: 64 HRC
- Ergonomically shaped HAZET 2-component plastic handle covers (blue/black)
- Surface: chrome-plated, head high gloss
- DIN ISO 5746



HAZET No.	l mm	Rm N/mm ² ○ 800	Rm N/mm ² ● 1600	Rm N/mm ² ● 2300	EAN-No. 4000896+
1851-44	210	3.8	2.7	2.2	055081

1851 M Heavy-duty combination pliers

Made in Germany

- **Optimum leverage ratio due to small distance between joint and cutting edges**

- Induction-hardened cutting edges with grind
- Cutting edge hardness: 64 HRC
- Ergonomically shaped HAZET 2-component plastic handle covers (blue/black)
- Surface: polished, blasted
- DIN ISO 5746



HAZET No.	l mm	Rm N/mm ² ○ 800	Rm N/mm ² ● 1600	Rm N/mm ² ● 2300	EAN-No. 4000896+
1851 M-44	200	3.8	2.7	2.2	144914

1803 Diagonal cutter

Made in Germany

- Easy motion joint free of clearance
- Lap joint
- Induction-hardened cutting edges with grind
- Cutting edge hardness: 62 HRC
- Ergonomically shaped HAZET 2-component plastic handle covers (blue/black)
- Surface: bright chrome-plated
- DIN ISO 5749



HAZET No.	l mm	Rm N/mm ² ○ 800	Rm N/mm ² ● 1600	EAN-No. 4000896+
1803-11	145	2.5	1.8	093854
1803-22	165	2.8	2	006106

1803 M Diagonal cutter

Made in Germany

- Easy motion joint free of clearance
- Lap joint
- Induction-hardened cutting edges with grind
- Cutting edge hardness: 62 HRC
- Ergonomically shaped HAZET 2-component plastic handle covers (blue/black)
- Surface: polished, blasted
- DIN ISO 5749



HAZET No.	l mm	Rm N/mm ² ○ 800	Rm N/mm ² ● 1600	EAN-No. 4000896+
1803 M-11	145	2.5	1.8	145218
1803 M-22	165	2.8	2	144945
1803 M-33	180	3	2.5	145225

1802 Heavy-duty diagonal cutter

Made in Germany

- **Optimum leverage ratio due to small distance between joint and cutting edges**

- Forged design
- Easy motion joint free of clearance
- Lay-on slip joint
- Induction-hardened cutting edges with grind
- Cutting edge hardness: 64 HRC
- Ergonomically shaped HAZET 2-component plastic handle covers (blue/black)
- Surface: bright chrome-plated
- DIN ISO 5749



HAZET No.	l mm	Rm N/mm ² ○ 800	Rm N/mm ² ● 1600	Rm N/mm ² ● 2300	EAN-No. 4000896+
1802-11	160	3.5	2.5	2	006038
1802-22	180	3.8	2.7	2.2	006052
1802-33	200	4.2	3	2.5	006076

1802 M Heavy-duty diagonal cutter

Made in Germany

- **Optimum leverage ratio due to small distance between joint and cutting edges**

- Forged design
- Easy motion joint free of clearance
- Lay-on slip joint
- Induction-hardened cutting edges with grind
- Cutting edge hardness: 64 HRC
- Ergonomically shaped HAZET 2-component plastic handle covers (blue/black)
- Surface: polished, blasted
- DIN ISO 5749



HAZET No.	l mm	Rm N/mm ² ○ 800	Rm N/mm ² ● 1600	Rm N/mm ² ● 2300	EAN-No. 4000896+
1802 M-11	160	3.5	2.5	2	144730
1802 M-22	180	3.8	2.7	2.2	144525
1802 M-33	200	4.2	3	2.5	144938



Hand tools

Pliers



1804 N High-leverage diagonal cutter

Made in Germany

- Performance class H (piano wire, hardened steel wire)
- Leverage **reduces force expenditure by 40%**
- Opening spring and locking
- Induction-hardened cutting edges with grind
- Cutting edge hardness: 64 HRC
- Handles with dip coating
- DIN ISO 5747



HAZET No.	l / mm	Rm N/mm ² ○ 800	Rm N/mm ² ● 1600	Rm N/mm ² ● 2300	EAN-No. 4000896+
1804 N-2	160	3	2.7	2.2	086276

Pliers, with protective insulation

See chapter Tools with protective insulation / Tools for electricians page 280



1841 A Snipe nose pliers

Made in Germany

- Flat round shape, induction-hardened cutting edges
- Straight design
- Cutting edge hardness: 60 HRC
- Ergonomically shaped HAZET 2-component plastic handle covers (blue/black)
- Surface: bright chrome-plated
- DIN ISO 5745



HAZET No.	l / mm	Rm N/mm ² ○ 800	Rm N/mm ² ● 1600	EAN-No. 4000896+
1841 A-22	165	2.5	1.6	006366
1841 A-33	205	2.8	1.8	006380

1841 MA Snipe nose pliers

Made in Germany

- Flat round shape, induction-hardened cutting edges
- Straight design
- Cutting edge hardness: 60 HRC
- Ergonomically shaped HAZET 2-component plastic handle covers (blue/black)
- Surface: polished, blasted
- DIN ISO 5745



HAZET No.	l / mm	Rm N/mm ² ○ 800	Rm N/mm ² ● 1600	EAN-No. 4000896+
1841 MA-11	145	2.3	1.6	145232
1841 MA-22	165	2.5	1.6	144754
1841 MA-33	205	2.8	1.8	144877

1841 B Snipe nose pliers

Made in Germany

- Flat round shape, induction-hardened cutting edges
- Curved design (45°)
- Cutting edge hardness: 60 HRC
- Ergonomically shaped HAZET 2-component plastic handle covers (blue/black)
- Surface: bright chrome-plated
- DIN ISO 5745



HAZET No.	l / mm	Rm N/mm ² ○ 800	Rm N/mm ² ● 1600	EAN-No. 4000896+
1841 B-33	200	2.8	1.8	006434

1841 MB Snipe nose pliers

Made in Germany

- Flat round shape, induction-hardened cutting edges
- Curved design (45°)
- Cutting edge hardness: 60 HRC
- Ergonomically shaped HAZET 2-component plastic handle covers (blue/black)
- Surface: polished, blasted
- DIN ISO 5745



HAZET No.	l / mm	Rm N/mm ² ○ 800	Rm N/mm ² ● 1600	EAN-No. 4000896+
1841 MB-33	200	2.8	1.8	144891

1841 A Snipe nose pliers

Made in Germany

• Extra long style

- Flat round shape
- Straight design
- Handles with dip coating



HAZET No.	l / mm	EAN-No. 4000896+
1841 A-280	280	051489
1841 B-280	280	051694

1816 Flat nose pliers

Made in Germany

- Flat form
- Straight design
- Ergonomically shaped HAZET 2-component plastic handle covers (blue/black)
- Surface: bright chrome-plated
- Functional dimensions according to DIN ISO 5745



HAZET No.	l / mm	EAN-No. 4000896+
1816-22	160	006274

Made in Germany

• Particularly flat shape for use in very confined spaces

- Flat form
- Straight design
- Handles with dip coating



HAZET No.	l / mm	EAN-No. 4000896+
1816 K-1	135	232949



1849 Spark plug socket pliers

Made in Germany

- Especially suitable for hot terminals

- Application: **Installing and removing spark plug sockets**
- Side cutter
- Ergonomically shaped HAZET 2-component plastic handle covers (blue/black)
- Surface: chrome-plated



HAZET No.	l mm	EAN-No. 4000896+
1849	195	007080

Made in Germany

- Safe application due to milled jaw profile

- Application: **Installing and removing straight spark plug sockets**
- Especially on **MERCEDES-BENZ**
- Ergonomically shaped HAZET 2-component plastic handle covers (blue/black)
- Surface: chrome-plated



HAZET No.	l mm	EAN-No. 4000896+
1849-1	200	128037

Made in Germany

- Long style provides a better safety distance to the hot engine

- Application: **Installing and removing straight spark plug sockets**
- Especially for **low-lying spark plug sockets**, e.g. on **AUDI V6** and **V8** engines · **JAGUAR** 12-cylinder
- Ergonomically shaped HAZET 2-component plastic handle covers (blue/black)
- Surface: chrome-plated



HAZET No.	l mm	EAN-No. 4000896+
1849-2	290	007103

Made in Germany

- Especially suitable for hot terminals

- Application: **Installing and removing spark plug sockets**
- Long style
- Ergonomically shaped HAZET 2-component plastic handle covers (blue/black)
- Surface: chrome-plated



HAZET No.	l mm	EAN-No. 4000896+
1849-3	265	055098

1810 End cutting/ tower pliers

Made in Germany

- Cutting edge hardness: 61 HRC
- DIN ISO 9242



HAZET No.	l mm	Rm N/mm ² ○ 800	Rm N/mm ² ● 1600	EAN-No. 4000896+
1810-250	250	3.5	2	006236

760 N Universal pliers

Made in Germany

- **Relief-milled** guide flutes
- Jaws induction hardened
- Fluted lay-on slip joint
- Surface: chrome-plated
- DIN ISO 8976

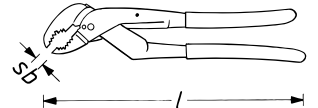

HAZET No.	l mm	sb mm	sb mm	EAN-No. 4000896+
760 N-4	415	110	120	030538

760 Universal pliers

Made in Germany

- **With quick-adjust lever: "Fits all your needs – ...it all depends on the right lever"**

- Comfortable quick adjustment thanks to **tip/step lever function**
- **Adjustment without re-gripping** – one-hand actuation possible
- A maximum clamping range of up to 50 mm width across flats makes these HAZET pliers some of the largest in their class
- The integral clamping protection prevents injuries (e.g. crushing)
- Handles with dip coating
- DIN ISO 8976

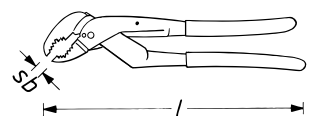

YouTube Clip



* not available in the USA

HAZET No.	l mm	sb mm	sb mm	EAN-No. 4000896+
760-2*	260	50	50	188451



Hand tools

Pliers



2183 Swedish pattern wrench

- Swedish pattern
- Self-locking, safe and firm grip even of smooth tubes due to 3-point tensioning
- Application on nuts and tubes, 25 mm = 1" – 37 mm = 1.½" – 50 mm = 2"
- Handles with double-T-section profile
- Slim, S-shaped jaws, 45° angle
- Induction-hardened teeth offset against direction of rotation
- Forged design
- Surface: powder coated, polished jaws
- DIN 5234

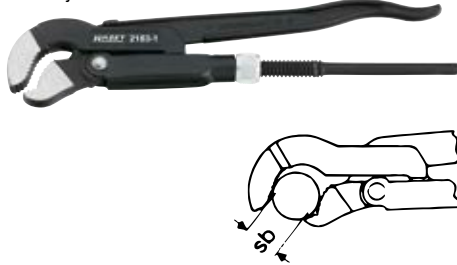

HAZET No.	l mm	sb mm	EAN-No. 4000896+
2183-1.5	416	46	013753
2183-2	535	65	013760

1845A Circlip pliers

- **Made in Germany**
- Safe and fast working
- Firm hold on the safety ring thanks to precise, conical and relief-ground jaws (phosphatized)
- Solid plastic body
 - Extremely resilient metal core extends far into the pliers' shanks
 - Light-weight – ergonomically shaped
- Readjusting spring
- Twist-safe, tips are welded to the solid metal core
- Straight design (form A)
- For outside lockrings
- DIN 5254



HAZET No.	l mm	mm	mm	EAN-No. 4000896+
1845A- 3	140	3–10	0.9	048663
1845A-10	140	10–25	1.3	048670
1845A-19	180	19–60	1.8	048687

1845 B Circlip pliers

- **Made in Germany**
- Safe and fast working
- Firm hold on the safety ring thanks to precise, conical and relief-ground jaws (phosphatized)
- Solid plastic body
 - Extremely resilient metal core extends far into the pliers' shanks
 - Light-weight – ergonomically shaped
- Readjusting spring
- Twist-safe, tips are welded to the solid metal core
- Tips bent 90° (form B)
- For outside lockrings



HAZET No.	l mm	mm	mm	EAN-No. 4000896+
1845B- 3	130	3–10	0.9	048694
1845B-10	130	10–25	1.3	048700
1845B-19	172	19–60	1.8	048717

1845 C Circlip pliers

- **Made in Germany**
- Safe and fast working
- Firm hold on the safety ring thanks to precise, conical and relief-ground jaws (phosphatized)
- Solid plastic body
 - Extremely resilient metal core extends far into the pliers' shanks
 - Light-weight – ergonomically shaped
- Readjusting spring
- Twist-safe, tips are welded to the solid metal core
- Straight design (from C)
- For inside lockrings
- DIN 5256



HAZET No.	l mm	mm	mm	EAN-No. 4000896+
1845C- 8	140	8–11	0.9	048724
1845C-12	140	12–25	1.3	048731
1845C-19	180	19–60	1.8	048748





1845D Circlip pliers

Made in Germany

- Safe and fast working
- Firm hold on the safety ring thanks to precise, conical and relief-ground jaws (phosphatized)
- Solid plastic body
 - Extremely resilient metal core extends far into the pliers' shanks
 - Light-weight – ergonomically shaped
- Readjusting spring
- Twist-safe, tips are welded to the solid metal core
- Tips bent 90° (form D)
- For inside lockrings



HAZET No.	l mm	Ø mm	≡ mm	EAN-No. 4000896+
1845D-8	133	8–11	0.9	048755
1845D-12	133	12–25	1.3	048762
1845D-19	170	19–60	1.8	048779

1845 Circlip pliers set

Made in Germany

- Safe and fast working
- Firm hold on the safety ring thanks to precise, conical and relief-ground jaws (phosphatized)
- Solid plastic body
 - Extremely resilient metal core extends far into the pliers' shanks
 - Light-weight – ergonomically shaped
- Readjusting spring
- Twist-safe, tips are welded to the solid metal core
- DIN 5254



1845A 1845A-10 • 1845A-19	1845C 1845C-8 • 1845C-19	1845D 1845D-8 • 1845D-19

1845B
1845B-10 • 1845B-19

HAZET No.	≡	EAN-No. 4000896+
1845/8	8	048656

1845 Circlip pliers set

Made in Germany

- Safe and fast working
- Firm hold on the safety ring thanks to precise, conical and relief-ground jaws (phosphatized)
- Solid plastic body
 - Extremely resilient metal core extends far into the pliers' shanks
 - Light-weight – ergonomically shaped
- Readjusting spring
- Twist-safe, tips are welded to the solid metal core
- DIN 5254, DIN 5256



1845A-19	1845B-19	1845C-19	1845D-19

HAZET No.	≡	EAN-No. 4000896+
1845/4	4	184132

Made in Germany

- Safety-Insert-System, 2-component soft foam insert. Insert also suitable for HAZET Assistant
- DIN 5254



1/3			
-----	--	--	--



1845A-19	1845B-19	1845C-19	1845D-19

HAZET No.	L x W mm	≡	EAN-No. 4000896+
163-124/4	342x172	4	153602

1846A Circlip pliers

Made in Germany

- Cylindrical tips worked out in optimal angle
- Exactly defined, extra stable cone tips
- Safe fit of the lockring
- Electrothermic hardening and tempering
- Straight design (from C)
- For inside lockrings
- Surface: chrome-plated, tip steel grey
- DIN 5256 form C



HAZET No.	l mm	Ø mm	≡ mm	EAN-No. 4000896+
1846A-0	139	8–13	0.9	006793
1846A-1	140	12–25	1.3	006809
1846A-2	180	19–60	1.8	006816
1846A-3	225	40–100	2.3	006823
1846A-4	310	85–140	3.2	006830



Hand tools

Pliers



1846 A Circlip pliers

Made in Germany

• Quick-releasing locking mechanism for holding the respective removal or installation position



- Shanks made of sheet steel
- Tips tempered, screwed, replaceable
- Straight design (from C)
- For inside lockrings
- Surface: powder coated



HAZET No.	l mm	Ø mm	mm	EAN-No. 4000896+
• Straight jaws for inside lockrings (bore holes)				
1846 A-5	545	122–300	3.5	081271
• Replacement tips · straight For 1846 a-5				
1846 A-05/2	–	–	–	081288
• Conversion tips · bent at 90° To convert the pliers 1846 a-5				
1846 B-05/2	–	–	–	081318

1846 B Circlip pliers

Made in Germany

- Tips bent 90° (form D)
- For inside lockrings
- Surface: chrome-plated, tip steel grey
- DIN 5256 form D



HAZET No.	l mm	Ø mm	mm	EAN-No. 4000896+
1846 B-0	139	8–13	0.9	006847
1846 B-1	140	10–25	1.3	006854
1846 B-2	180	19–60	1.8	006861
1846 B-3	225	40–100	2.3	006878
1846 B-4	310	85–165	3.2	006885

Made in Germany

• Long, 90° angled tips



- Jaws curved 90°
- Ergonomically shaped HAZET 2-component plastic handle covers (blue/black)
- Surface: chrome-plated



HAZET No.	l mm	Ø mm	mm	EAN-No. 4000896+
1846 B-1.6	195	12–30	1.5	061457

1846 C Circlip pliers

Made in Germany

- Straight design (form A)
- For outside lockrings
- Surface: chrome-plated, tip steel grey
- DIN 5254 form A



HAZET No.	l mm	Ø mm	mm	EAN-No. 4000896+
1846 C-0	139	3–10	0.9	006892
1846 C-1	140	10–25	1.3	006908
1846 C-2	180	19–60	1.8	006915
1846 C-3	225	40–100	2.3	006922
1846 C-4	310	85–140	3.2	006939

Made in Germany

- Shanks made of sheet steel
- Tips tempered, screwed, replaceable
- Straight design (form A)
- For outside lockrings
- Surface: powder coated



HAZET No.	l mm	Ø mm	mm	EAN-No. 4000896+
• Straight jaws for outside lockrings (shafts)				
1846 C-5	538	122–300	3.5	081332
• Replacement tips · straight For 1846 c-5				
1846 C-05/2	–	–	–	081349
• Conversion tips · bent at 90° To convert the pliers 1846 c-5				
1846 D-05/2	–	–	–	081370

1846 D Circlip pliers

Made in Germany

- Tips bent 90° (form B)
- For outside lockrings
- Surface: chrome-plated, tip steel grey
- DIN 5254 form B



HAZET No.	l mm	Ø mm	mm	EAN-No. 4000896+
1846 D-0	139	3–10	0.9	006946
1846 D-1	140	10–25	1.3	006953
1846 D-2	180	19–60	1.8	006960
1846 D-3	225	40–100	2.3	006977
1846 D-4	310	85–140	3.2	006984



1847 Circlip pliers

Made in Germany

- Jaws bent 90°, tips chequered
- For outside lockrings
- Surface: chrome-plated



HAZET No.	l mm	EAN-No. 4000896+
1847-2	200	007011

Made in Germany

- For homocinetic joint or drive shaft
- Jaws bent 10°, tips chequered
- For outside lockrings
- Surface: chrome-plated



HAZET No.	l mm	EAN-No. 4000896+
1847-3	200	007028

Made in Germany

- Jaws bent 30°
- Surface: chrome-plated



HAZET No.	l mm	EAN-No. 4000896+
1847-6	200	050468

Made in Germany

- Jaws bent 30°
- Surface: chrome-plated



HAZET No.	l mm	EAN-No. 4000896+
1847-61	200	058761

1847 Circlip pliers set

Made in Germany

- **Easy, damage-free assembly of the drive shaft joint: damage to the serration of joint and shaft is avoided with internal circlip during assembly of the drive shaft joint**



- Easy fixing of the locking pliers with the circlip
- The pliers automatically slip down when striking the joint
- Safe work without damage to the bellows
- For drive shafts from all manufacturers
- One-hand operation of the pliers
- No other tools needed

Application tip:

- Insert appropriate half shells (shaft diameter) in pliers
- Place pliers on serration with pre-assembled circlip and clamp
- Pre-positioning of the hinge due to conical shape of the pliers makes it easier to introduce the serration without damage
- Suitable for almost all vehicles commonly registered in Europe
- Plastic box 165-L (1/3)
- Safety-Insert-System, 2-component soft foam insert. Insert also suitable for HAZET Assistant

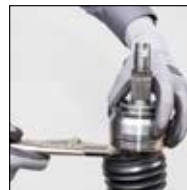

1/3			
-----	--	--	--



YouTube Clip



1847-12



1847-122/2



1847-124/2



1847-126/2



1847-121/2



1847-123/2



1847-125/2



1847-127/2

HAZET No.	L x W x H mm	□	EAN-No. 4000896+
1847-12/15	355x235x65	15	221288

1847 Components

Made in Germany



HAZET No.	EAN-No. 4000896+
• Circlip pliers	
1847-12	222117
• Half shell pair (∅ 19 mm)	
1847-121/2	221295
• Half shell pair (∅ 21.4 mm)	
1847-122/2	221301
• Half shell pair (∅ 22.3 – 23 mm)	
1847-123/2	221318
• Half shell pair (∅ 23.8 – 24.6 mm)	
1847-124/2	221325
• Half shell pair (∅ 26.2 – 26.9 mm)	
1847-125/2	221332
• Half shell pair (∅ 28.5 – 29.2 mm)	
1847-126/2	221349
• Half shell pair (∅ 30 mm)	
1847-127/2	221356



Hand tools

Pliers



1847 Supplementary set

Made in Germany

- Half shell pair (∅ 32.8 mm)
- Supplement for 1847-12/15
- Easy, damage-free installation of the drive shaft joint VW T5 · T6
- Correct, centred insertion of the circlip, e.g. when mounting the hinge on the drive shaft
- Exact fit, safe storage in the circlip pliers set 1847-12/15 with supplied soft foam insert

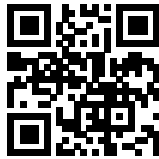

YouTube Clip

HAZET No.	EAN-No. 4000896+
1847-128/2	242009

757 Grip pliers

Made in Germany

- Half-round jaws
- Quick-release lever
- Wirecutter
- Surface: nickel-plated

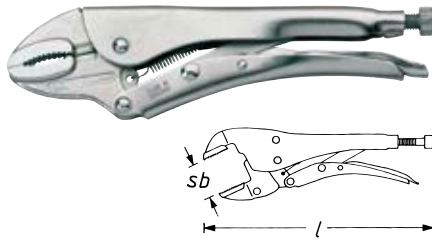

HAZET No.	l mm	sb mm	EAN-No. 4000896+
757- 5	140	30	062300
757- 7	180	35	030347
757-10	250	50	030293
757-12	300	65	030323

753 Grip pliers

Made in Germany

- For small round parts and bulky work pieces
- Parallel grip jaws – clamping function
- One-sided prismatic groove
- Long guide pin
- Quick-release lever
- Surface: nickel-plated

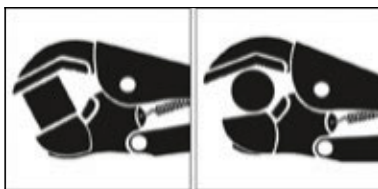
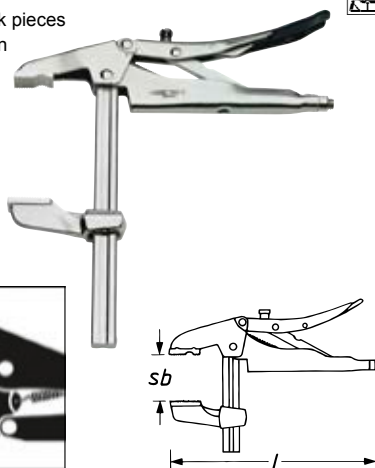

HAZET No.	l mm	sb mm	EAN-No. 4000896+
753-2	260	200	030231

753 Grip pliers

Made in Germany

- Straight jaws – for flat material
- Quick-release lever
- Surface: nickel-plated

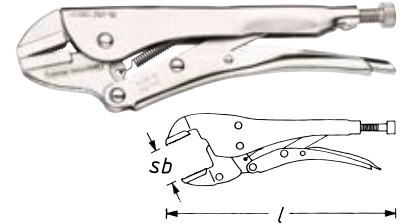

HAZET No.	l mm	sb mm	EAN-No. 4000896+
753-10	250	40	030200

Made in Germany

- Combined jaw shape
- With a swivelling jaw
- For flat and asymmetrical material
- Surface: nickel-plated

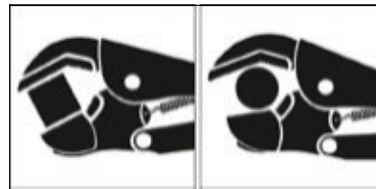
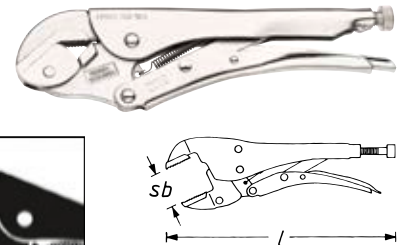

HAZET No.	l mm	sb mm	sb mm	EAN-No. 4000896+
753-10S	250	45	16–45	030217

758 Grip pliers

Made in Germany

- Malleable iron jaws – heat-resistant
- resistant to welding bead deposits

- Application: For flat and square materials
- Welding end to end
- Quick-release lever
- Jaw angle 90°
- Surface: nickel-plated

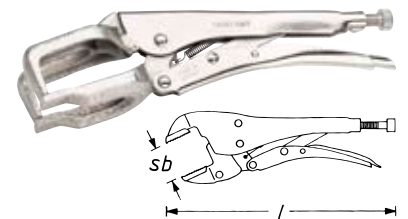

HAZET No.	l mm	sb mm	EAN-No. 4000896+
758-1	280	70	030361

Made in Germany

- Quick-release lever
- Surface: nickel-plated



HAZET No.	l mm	sb mm	f ₁ mm	f ₂ mm	EAN-No. 4000896+
758-2	280	90	85–95	55–77	030378



755 Grip pliers · self-adjusting

- One-hand operation and automatic adjustment
- Variable adjustment of jaw pressure
- Easy and safe release – the jaws are locked until the release lever is pressed
- Cam mechanism – allows automatic adjusting of the pliers to any size when applying a constant jaw pressure
- Wirecutter
- Anti-slip surface

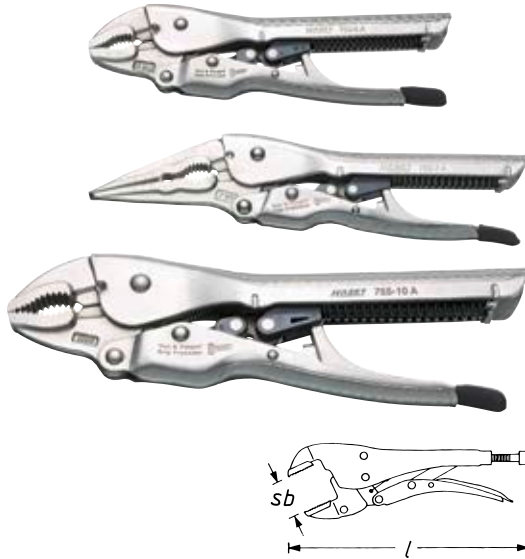

HAZET No.	l mm	sb mm	EAN-No. 4000896+
755- 6 A	161	0–32	126569
755- 7 A	192	0–44	126576
755-10 A	230	0–44	126590

752 Grip pliers

- Especially suitable for working with curves due to the slim design
- Gripping power works in axial direction
- Quick-release lever
- Surface: bright nickel-plated
- For working on U-beams and weld seams in the fold

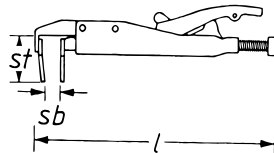
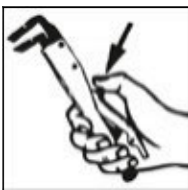

HAZET No.	l mm	sb mm	b mm	fi mm	EAN-No. 4000896+
752-2	205	15	18	18	030125

798 Hose clamp pliers

Made in Germany



- Application: Simple hose clamps, e.g. on washing machines
- **Rotating jaws** – for areas with restricted access
- Surface: chrome-plated



HAZET No.	l mm	sb mm	EAN-No. 4000896+
798	206	40	031832

Made in Germany



- **Locking device, adjustable jaw opening**

- Application: Simple hose clamps
- **Rotating jaws** – for areas with restricted access
- Surface: chrome-plated



HAZET No.	l mm	sb mm	EAN-No. 4000896+
798-1	285	45	031900

798 Clic hose clamp pliers

Made in Germany



- Application: Reusable CLIC type hose clips on fuel lines
- On e.g. **VW · AUDI · OPEL · PEUGEOT und ALFA ROMEO**
- Open and close easily by turning the pliers by 180°
- Fixed jaws, bent 90°

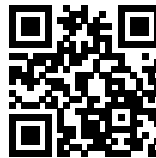

YouTube Clip



HAZET No.	l mm	sb mm	EAN-No. 4000896+
798-2	175	20	051397



Hand tools

Pliers



798 Clic hose clamp pliers

Made in Germany

- Application: Operating reusable **CLIC** hose clips
- **AUDI · VW · OPEL/VAUXHALL · PEUGEOT · SMART** and **MERCEDES-BENZ**
- Open and close easily by turning the pliers by 180°
- **Rotating jaws** – for areas with restricted access
- Surface: nickel-plated



YouTube Clip

HAZET No.	l mm	sb mm	EAN-No. 4000896+
798-3	206	35	102433

798 Hose clamp pliers

Made in Germany

- Application: Self-gripping spring band hose clamps
- **Rotating jaws** – for areas with restricted access



HAZET No.	l mm	sb mm	EAN-No. 4000896+
798-4	205	35	031948

Made in Germany

- Application: **Spring band hose clamps** e.g. on **VW · AUDI · OPEL/VAUXHALL**
- **Rotating jaws** – for areas with restricted access



YouTube Clip

HAZET No.	l mm	sb mm	EAN-No. 4000896+
798-5	210	40	031955

798 Hose clamp pliers

- Application: **Spring band hose clamps** **12 and 15 mm** width, 13 – 22 mm Ø
- **Rotating safety jaws**



YouTube Clip

HAZET No.	l mm	sb mm	EAN-No. 4000896+
798-6	235	39	031962

Made in Germany

- **Self-adjusting joint** allows easy working even on spring band hose clamps with large diameter



- Application: **Self-gripping spring band hose clamps, 12 and 15 mm** width
- With locking device
- Self-adjusting joint
- **Rotating safety jaws**
- Handles with dip coating



HAZET No.	l mm	sb mm	EAN-No. 4000896+
798-8	290	45	076697

Made in Germany

- **With locking device**



- Application: Especially for spring band hose clamps **12 and 15 mm** width e.g. cooling and heating system
- **Rotating jaws, bent 110°** – for areas with restricted access
- Handles with dip coating



YouTube Clip

HAZET No.	l mm	sb mm	EAN-No. 4000896+
798-9	250	60	072163



798 Hose clamp pliers

- **Made in Germany**
- **With locking device**



- Application: Spring band hose clamps – especially for 12 mm and 15 mm wide spring band hose clamps e.g. on OPEL/VAUXHALL · VW · FORD · RENAULT · FIAT · PEUGEOT · CITROËN · PORSCHE · ALFA-ROMEO · MERCEDES-BENZ · SMART
- Adjustable jaw opening
- Fixed jaws



HAZET No.	l mm	sb mm	EAN-No. 4000896+
798-10	320	90	031917

- **Made in Germany**
- **With locking device**



- Application: Self-gripping spring band hose clamps
- Adjustable jaw opening
- Handles with dip coating



HAZET No.	l mm	sb mm	EAN-No. 4000896+
798-12	320	80	031931

- **Made in Germany**



- For use in areas with restricted access where the clamp cannot be reached straight forwardly
- Application: Operating spring band hose clamps whose three ends fit tightly on the hose, e.g. on tank aeration lines and fuel lines on VW · AUDI · SEAT · ŠKODA
- Rotating jaws – for areas with restricted access

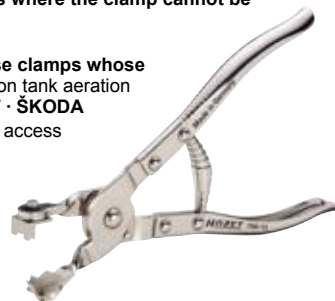

YouTube Clip

HAZET No.	l mm	sb mm	EAN-No. 4000896+
798-13	192	27	155248

798 Hose clamp pliers

- **Made in Germany**



- Application: Operation of spring band hose clamps whose three ends fit tightly on the hose
- For e.g. on fuel lines and tank ventilation lines on VW · AUDI · SEAT · ŠKODA
- Surface: nickel-plated



HAZET No.	l mm	sb mm	EAN-No. 4000896+
798-14	177	20	109128

- **Made in Germany**



- Bowden cable (610 mm) enables application in areas with restricted access where the direct use of pliers is not possible

- Application: Operation of self-gripping spring band and space-saving hose clamps sb 7 – 60 mm Ø, e.g. on the cooling and heating systems
- One-hand operation thanks to automatic toothed fixing device
- Sliding guide device with integrated tension spring and adjustable reversible plate
- Handles with dip coating



HAZET No.	l mm	sb mm	EAN-No. 4000896+
798-15 A	875	7–60	097258
• Bowden cable · complete			
Bowden cable · coating · 2 headless screws · spring for 798-15A			
798-0151 A	–	–	097753
• Bowden cable for 798-15A and B			
798-0152 A	–	–	097760
• Sliding guide device for 798-15A and B			
798-0153 A	–	–	097784



Hand tools

Pliers



798 Hose clamp pliers

Made in Germany



Particularly suitable for areas with restricted access where the direct application of pliers is not possible

- Application: Operating self-gripping spring band and space-saving hose clamps on the cooling and heating system
- Plastic-coated, semi-flexible Bowden cable
- The Bowden cable enables working without a guiding hand
- Sliding guide device with integrated tension spring and adjustable reversible plate
- One-hand operation thanks to automatic toothed fixing device
- Handles with dip coating

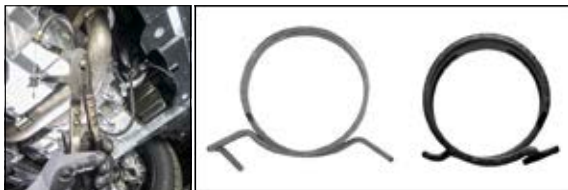

HAZET No.	l mm	sb mm	EAN-No. 4000896+
798-15 B	875	7-60	117727
• Flexible hose for 798-15B			
798-0150 B	-	-	142439
• Bowden cable for 798-15A and B			
798-0152 A	-	-	097760
• Sliding guide device for 798-15A and B			
798-0153 A	-	-	097784

Made in Germany



Reinforced bowden cable and sliding guide device

- Application: Special clamp with parallel clamp ends e.g. at the charge-air cooler connection on VW Passat · T5 · T6
- Bowden cable enables application in areas with restricted access
- Toothed fixing device and one-hand operation
- Fixing device is released by pressure lever
- Handles with dip coating



798 Hose clamp pliers



HAZET No.	l mm	sb mm	EAN-No. 4000896+
798-16	875	3-50	149032
• Bowden cable for 798-16			
798-0162	-	-	149056
• Sliding guide device for 798-16			
798-0163	-	-	149063

Made in Germany



- Application: Operation of self-gripping space-saving hose clamps on coolant and fuel hoses in the entire vehicle area, in particular on VW · AUDI · SEAT · ŠKODA
- Rotating jaws – for areas with restricted access



YouTube Clip

HAZET No.	l mm	sb mm	EAN-No. 4000896+
798-17	210	40	186068

798 Hose clamp pliers set

Made in Germany



- Safety-Insert-System, 2-component soft foam insert. Insert also suitable for HAZET Assistant

1/3			
-----	--	--	--



HAZET No.	L x W mm		EAN-No. 4000896+
798			
798-3 · 798-13 · 798-17			
163-425/3	342x172	3	202614





HAZET hammer

More safety at work!

BluGuard:



Lower end of handle painted black. Optimises grip

Ergonomically shaped Hickory handle

Steel handle protection sleeve highest level of protection against handle breakage in the case of faults

HAZET Hickory
2140-50
MADE IN GERMANY

Peen and face
The cut of the two ends of the hammer are defined in DIN 1193. The face (the flat end) is even and chamfered all the way round. The peen runs evenly round and is bevelled at the sides

Embossed DIN 1041 and weight specification

Flush finish of ring wedge and hammer eye

Wedge



Higher flexibility strength thanks to surrounding angled stabilising band

Steel handle protection sleeve: extra safety from HAZET

- Highest level of protection against handle breakage in the case of faults
- Higher flexibility strength thanks to surrounding angled stabilising band
- HAZET steel handle protection sleeve guarantees maximum protection in the case of faults



BluGuard: HAZET steel handle protection sleeve after failures:

- No deformations → just small scratches
- Exact firm fit



Handle without steel handle protection sleeve:

- Extremely noticeable handle damage
- Shortened service life and high risk of handle breakage

BluGuard:

Made in Germany



Hand tools

Hammers / Chisels / Centre punches



Roofing hammer



Plastic soft-faced hammer



Machinist's hammer
BluGuard:



Rubber hammer



Club hammer
BluGuard:



Sledge hammer



Plastic hammer

Hickory handles guarantee a high level of safety – why?

- Three to four times greater resilience safety compared with standard handles made from ash
- Long-fibre wood structure: even when damaged the handle is still held together, this guarantees significantly greater safety in the case of breakage
- Hammer heads will not fly off when the wooden handle is old
- Reduces vibration, extremely resistant to bending and durable



Hickory handle



Ash handle

Thanks to its long fibres, hickory wood holds the handle together even after breakages.



2140 BluGuard Engineer's hammer

Made in Germany

- Quality range A
- **Steel handle protection sleeve – extra safety from HAZET**
 - Highest level of protection against handle breakage in the case of faults
 - Higher flexibility strength thanks to surrounding angled stabilising band
 - HAZET steel handle protection sleeve guarantees maximum protection in the case of faults
- Hickory handle
- With handle protection sleeve
- DIN 1041



BluGuard



HAZET No.		l mm	EAN-No. 4000896+
2140- 20	200 g	280	196135
2140- 30	300 g	300	196142
2140- 40	400 g	310	196159
2140- 50	500 g	320	196166
2140- 80	800 g	350	196173
2140-100	1000 g	360	196180

2138 Roofing hammer

Made in Germany

- Application at construction sites of various trades, e.g. carpentry, bricklaying or roofing companies
- Magnetic nail holder allows for work in places that can only be accessed with an outstretched arm or overhead
- Roughened track/roughened striking surface stop the hammer from slipping when hammering in nails
- Handle made of grippable, non-slip plastic
- Steel tube handle



HAZET No.		EAN-No. 4000896+
2138-600	600 g	246311



2142 BluGuard club hammer

Made in Germany

- **Steel handle protection sleeve – extra safety from HAZET**
 - Highest level of protection against handle breakage in the case of faults
 - Higher flexibility strength thanks to surrounding angled stabilising band
 - HAZET steel handle protection sleeve guarantees maximum protection in the case of faults
- Hickory handle
- With handle protection sleeve
- DIN 6475



BluGuard



HAZET No.		l mm	EAN-No. 4000896+
2142-1	1000 g	260	196227
2142-2	1250 g	260	196234
2142-3	1500 g	280	196241
2142-4	2000 g	300	196258

2139 Sledge hammer

Made in Germany

- Particularly safe thanks to double wedge (1 ring wedge + 1 wooden wedge)
- Hickory handle
- DIN 1042



HAZET No.		l mm	EAN-No. 4000896+
2139-1	3000 g	600	196197
2139-2	5000 g	800	196203

1953 Plastic hammer · non-rebound

Made in Germany

- **Non-rebound:** due to steel ball filling in the centre part of the hammer head and precisely matched material of the impact heads
- Replaceable hammer heads made of polyurethane, non-spalling and non-crumbling
- Gentle and careful working
- Abrasion-proof, long service-life
- PVC handle, resistant to oil and gasoline

Ⓔ



HAZET No.	l mm	Ø mm	l mm	EAN-No. 4000896+
1953 N-30	295	30	110	227075
1953 N-35	300	35	110	227068
1953 N-40	305	40	115	227051
1953 N-50	315	50	120	227044
1953 N-60	335	60	145	227037



Hand tools

Hammers / Chisels / Centre punches



1953 Spare head

Made in Germany

- Polyurethane, non-splintering and non-crumbling
- Cramp worn-out head in a vice and twist to remove.
- Use a hammer to bump on new heads



HAZET No.	Ø mm	EAN-No. 4000896+
Spare heads (pair) for HAZET plastic soft-faced hammer 1953N-30		
1953 N-030	30	227167
Spare heads (pair) for HAZET plastic soft-faced hammer 1953N-35		
1953 N-035	35	227150
Spare heads (pair) for HAZET plastic soft-faced hammer 1953N-40		
1953 N-040	40	227792
Spare heads (pair) for HAZET plastic soft-faced hammer 1953N-50		
1953 N-050	50	227785
Spare heads (pair) for HAZET plastic soft-faced hammer 1953N-60		
1953 N-060	60	227778

1952 Plastic soft-faced hammer · low rebound

Made in Germany

- Replaceable Desmopan® heads with low rebound
- Joint-protecting, ergonomic handle
- Zinc-cast centre part with protective guide bush for the handle
- Ash handle



HAZET No.	l mm	Ø mm	EAN-No. 4000896+
1952-28	269	28	008506
1952-35	290	35	008520
1952-40	317	40	008544
1952-50	342	50	008551

1952 Spare head

Made in Germany

- Made of tough Desmopan® material
- To remove worn-out heads, turn forcefully to the left
- Knock on new head without turning using a hammer or by pressing



HAZET No.	Ø mm	EAN-No. 4000896+
Spare heads · pair for HAZET plastic soft-faced hammer 1952-28		
1952-028	28	008391
Spare heads · pair for HAZET plastic soft-faced hammer 1952-35		
1952-035	35	008414
Spare heads · pair for HAZET plastic soft-faced hammer 1952-40		
1952-040	40	008438
Spare heads · pair for HAZET plastic soft-faced hammer 1952-50		
1952-050	50	008452

2143 Rubber hammer

Made in Germany

- Made from tough hard rubber (90 shore), non-elastic, with strong impact
- Ash handle
- DIN 5128



HAZET No.	g	l mm	Ø mm	EAN-No. 4000896+
2143	225	320	54 mm x 90 mm	012794
2143-1	520	340	64 mm x 113 mm	196265

1951 Plastic soft-faced hammer · low rebound

Made in Germany

- Heads made from impact-resistant cellulose acetate
- Low rebound
- Ash handle



HAZET No.	l mm	Ø mm	EAN-No. 4000896+
1951-27	265	27	196326
1951-32	280	32	196333
1951-40	320	40	196357

2132 Hand axe

- Easy penetration into the wood due to specially polished cutting edge (lamella grinding technique)
- Non-slip end of the handle

- Tool head and wooden handle with triple safety wedging (2132-600 with double wedging)
- High-grade C60 tool steel (2135-3000: C45 tool steel)
- Original USA hickory handle, ergonomically shaped
- Anti-slip convenient handle
- Universal application in gardening and forestry work
- Length (handle): 360 mm
- Can also be used as a kitchen cleaver



HAZET No.	EAN-No. 4000896+
2132-600	231140

2133 Wood axe

- Easy penetration into the wood due to specially polished cutting edge (lamella grinding technique)
- Non-slip end of the handle

- Tool head and wooden handle with triple safety wedging (2132-600 with double wedging)
- High-grade C60 tool steel (2135-3000: C45 tool steel)
- Original USA hickory handle, ergonomically shaped
- Anti-slip convenient handle
- Length (handle): 700 mm
- Impact protection sleeve to increase the service life in case of mishits



HAZET No.	EAN-No. 4000896+
2133-1250	231133



2134 Riving axe

- Easy penetration into the wood due to specially polished cutting edge (lamella grinding technique)
- Non-slip end of the handle
- Tool head and wooden handle with triple safety wedging (2132-600 with double wedging)
- High-grade C60 tool steel (2135-3000: C45 tool steel)
- Original USA hickory handle, ergonomically shaped
- Anti-slip convenient handle
- High splitting effect due to optimised head shape
- Hollow forged spreading wedges prevent the axe from jamming in the wood
- Length (handle): 500 mm
- Impact protection sleeve to increase the service life in case of mishits
- Cutting protection made of synthetic leather



HAZET No.	EAN-No. 4000896+
2134-1250	229529

2135 Sledgehammer

- Easy penetration into the wood due to specially polished cutting edge (lamella grinding technique)
- Non-slip end of the handle
- Tool head and wooden handle with triple safety wedging (2132-600 with double wedging)
- High-grade C60 tool steel (2135-3000: C45 tool steel)
- Original USA hickory handle, ergonomically shaped
- Anti-slip convenient handle
- Forged turning tappet to easily pull or turn pieces of wood
- Length (handle): 900 mm
- Impact protection sleeve to increase the service life in case of mishits
- Cutting protection made of synthetic leather



HAZET No.	EAN-No. 4000896+
2135-3000	231157

730 Flat chisel

- Made in Germany
- Forged design
- Consistently hardened as per DIN (54-58 HRC)
- Impact head tempered as per DIN (38-46 HRC)
- Blades ground
Regrinding without rehardening
- Flattened oval shaft
- Surface: immersion-lacquered
- DIN 6453



HAZET No.	l mm	± mm	EAN-No. 4000896+
730-2	125	15	029563
730-3	150	18	029570
730-5	175	21	029594
730-6	200	24	029600
730-7	250	25	029617
730-8	300	26	029624

730 HS Hand guard

• Made in Germany



HAZET No.	EAN-No. 4000896+
730 HS	029631

731 Flat chisel

• Made in Germany

- Forged design
- Consistently hardened as per DIN (54-58 HRC)
- Impact head tempered as per DIN (38-46 HRC)
- Blades ground
Regrinding without rehardening
- Octagonal shaft
- Surface: immersion-lacquered



HAZET No.	l mm	± mm	EAN-No. 4000896+
731-2	125	11	029648
731-5	150	15	029655

740 Cape chisel

• Made in Germany

- Forged design
- Consistently hardened as per DIN (54-58 HRC)
- Impact head tempered as per DIN (38-46 HRC)
- Blades ground
Regrinding without rehardening
- Flattened oval shaft
- Surface: immersion-lacquered
- DIN 6451



HAZET No.	l mm	± mm	EAN-No. 4000896+
740-3	150	6	029679

741 Cape chisel

• Made in Germany

- Forged design
- Consistently hardened as per DIN (54-58 HRC)
- Impact head tempered as per DIN (38-46 HRC)
- Blades ground
Regrinding without rehardening
- Octagonal shaft
- Surface: immersion-lacquered



HAZET No.	l mm	± mm	EAN-No. 4000896+
741-1	125	4	029709



Hand tools

Hammers / Chisels / Centre punches



745 Drift punch

Made in Germany

- Octagonal shaft
- Surface: matt black
- DIN 6458



HAZET No.	l mm	Ø mm	EAN-No. 4000896+
745-2	120	2	029723
745-3	120	3	029730

745A Drift punch

Made in Germany

- Heavy design (D)
- Octagonal shaft



HAZET No.	l mm	Ø mm	EAN-No. 4000896+
745A-2	120	2	029778
745A-3	120	3	029785
745A-4	120	4	029792
745A-5	120	5	029808
745A-6	120	6	029815

746 Centre punch

Made in Germany

- Octagonal shaft
- DIN 7250



HAZET No.	l mm	Ø mm	± mm	EAN-No. 4000896+
746-1	120	4	10	029846
746-2	120	5	13	029853

750 Chisel · drift punch · centre punch set

Made in Germany



HAZET No.	Quantity	EAN-No. 4000896+
750 731-2 · 731-5 · 741-1 · 745-3 · 745A-4 · 746-1	6	030026
750 730-3 · 730-6 · 740-3 · 745-2 · 745A-4 · 746-2	6	030033

747 Centre punch · self-punching

• Infinitely adjustable impact force from 3 to 30 kg



- Tough punch tip (replaceable)
- High durability
- The impact force is applied by simply pressing down the upper part
- Knurled handle



HAZET No.	l mm	EAN-No. 4000896+
747-1	135	051434
747-02	-	051380

748A Drift pin

Made in Germany

- Octagonal shaft
- DIN 6450 form C



¹⁾ Long design

HAZET No.	l mm	Ø mm	EAN-No. 4000896+
748A-2	115	2	029884
748A-3	125	3	029891
748B-2	150	2	029907
748B-3	150	3	029914
748B-4	150	4	029921
748B-5	150	5	029938
748B-6	150	6	029945
748B-8	150	8	029952
748C-6 ¹⁾	180	6	029976
748C-8 ¹⁾	200	8	029983
748C-10 ¹⁾	200	10	029969

748LGB Drift pin

Made in Germany

- Long style



HAZET No.	l mm	Ø mm	EAN-No. 4000896+
748LGB-3	175	3	100040
748LGB-4	175	4	029990

751 Drift pin set

Made in Germany



HAZET No.	Quantity	EAN-No. 4000896+
751 748A-2 · 748A-3 · 748B-4 · 748B-5 · 748C-6 · 748C-8	6	030088
751 748B-2 · 748B-3 · 748B-4 · 748B-5 · 748B-6 · 748B-8	6	030095



751 KHS Drift pin · short

Made in Germany

- Short design with hand guard
- 2-component handle with hand guard



HAZET No.	l_1 mm	l_2 mm	Ø mm	EAN-No. 4000896+
751 KHS-3	10	109	3	159987
751 KHS-4	10	109	4	159994

751 HS Drift pin set

Made in Germany

- Ergonomically shaped 2-component handle ensures:
 - Significantly reduced risk of injury
 - Damping effect (less stress to the hand from impacts)
 - Secure hold

Contents:

- 5 3 · 4 · 5 · 6 · 8 mm
- 2-component handle with hand guard
- DIN 6450 form C
- Hand guard length: 75 mm



HAZET No.	l_1 mm	l_2 mm		EAN-No. 4000896+
751 HS/5	75	150	5	148257

751 LHS Drift pin set · long

Made in Germany

- Ergonomically shaped 2-component handle ensures:
 - Significantly reduced risk of injury
 - Damping effect (less stress to the hand from impacts)
 - Secure hold

Contents:

- 5 3 · 4 · 5 · 6 · 8 mm
- 2-component handle with hand guard
- DIN 6450 form C
- Hand guard length: 85 mm



HAZET No.	l_1 mm	l_2 mm		EAN-No. 4000896+
751 LHS/5	90	175	5	205530

2534 Brass mandrel

Made in Germany



HAZET No.	l mm	Ø mm	EAN-No. 4000896+
2534	200	20	016365

2164 Pry bar set

- Flat and bevelled tips allow application in areas with restricted access
- Solid square blades guarantee high power transmission

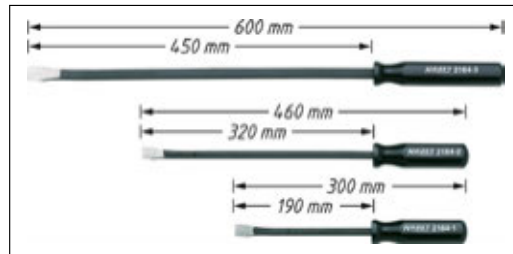

HAZET No.		EAN-No. 4000896+
2164/3	3	080281

2165 Pry bar

Made in Germany

- Surface: bright nickel-plated



HAZET No.	l mm	EAN-No. 4000896+
2165-1	400	013302
2165-2	400	013319
2165-3	400	013326

2166 Commercial vehicle double-handed pry bar

- Shock-resistant, ergonomic plastic handle allows two-hand operation
- Hexagon blade passes through the handle
- Solid impact head for high loads
- Hardened and tempered



HAZET No.	l mm	EAN-No. 4000896+
2166-4	1116	161072



3-arm HAZET puller

Easy application due to new quick pulling system



- ① Precisely manufactured head permits a fast and accurate application
- ② Maintenance-free encapsulated mechanics
- ③ High-quality steel and thermo-chemical treatment provide the highest spindle pressure load and hook tensile load
- ④ Flexible, interchangeable spindle tip provides various application possibilities

Made in Germany

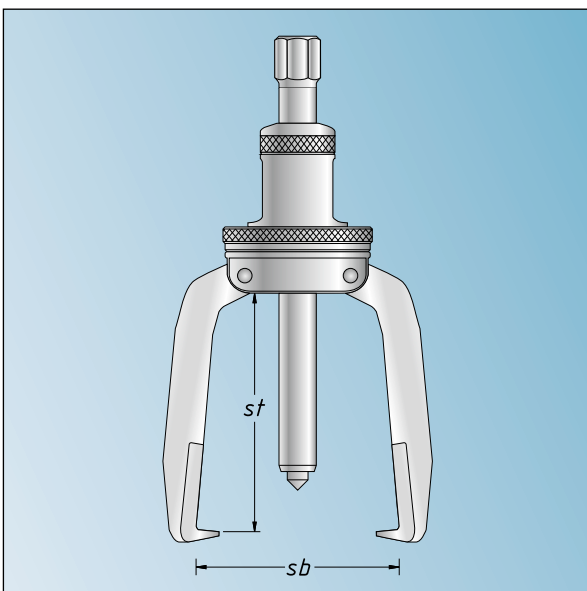

A simple rotary motion opens the hook and automatically encloses the part to be pulled off, even for vertical application (no readjustment necessary)





2-arm HAZET puller

With quick-clamping device

- For quickly and safely pulling ball bearings, pulleys, sprockets, etc.

- ① Solid all-steel bridge
- ② „One-nut“ fixing allows fast and simple adjusting
- ③ To be used as **internal and external puller** by inverting the hooks
- ④ Forged arms

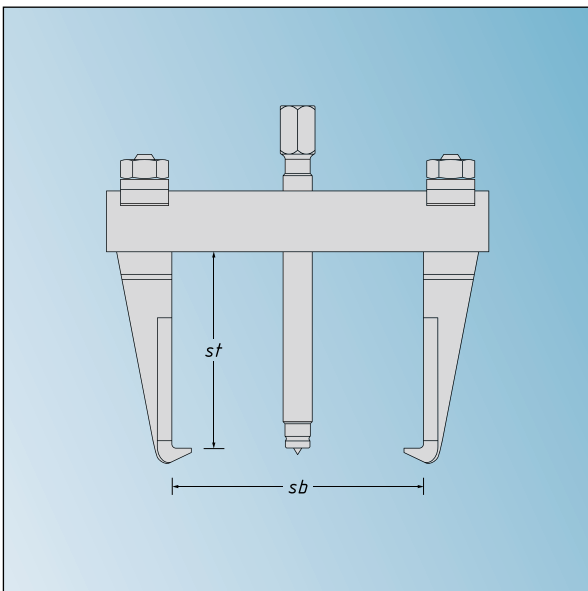



HAZET puller basics

Always find the correct puller

HAZET external pullers

The most common pulling procedure is external pulling, i.e. the component to be pulled off (ball bearing, pulley, sprocket, etc.) is gripped from the outside and pulled off. The actual pulling off procedure then occurs by operating a spindle.

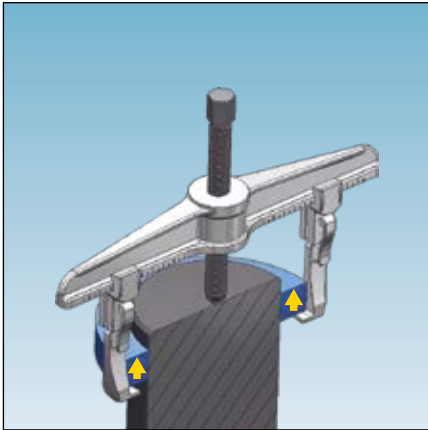

Standard design HAZET external pullers



HAZET external pullers with long puller hooks

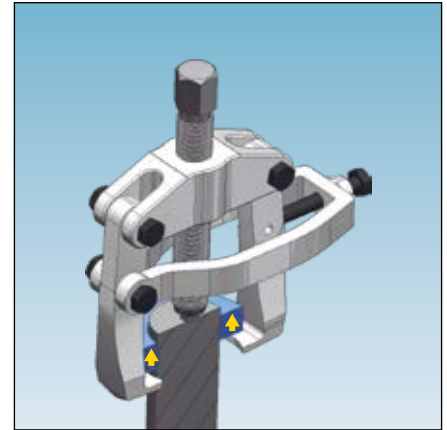

HAZET external puller with lateral tension clamp

HAZET external pullers can also be used as internal pullers

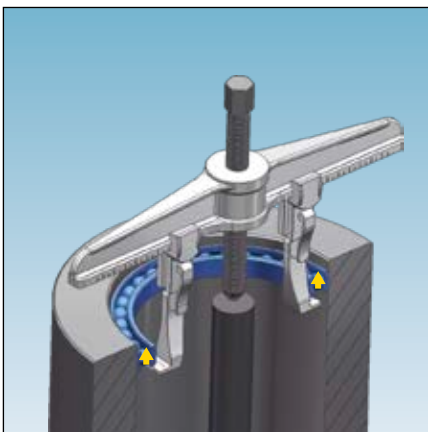

Pullers can also be used as internal pullers by simply turning the puller hook on the crossbar. A shaft in the centre of the component is required for this, against which the spindle supports itself.

HAZET internal pullers

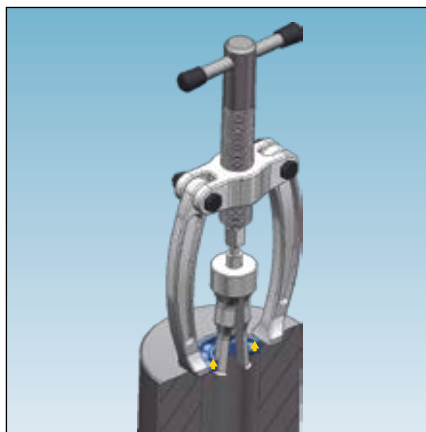

For this application, internal pullers and counter stays are normally used.

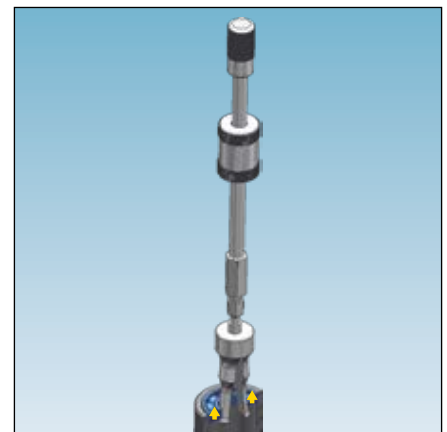

If there is insufficient space, the counter stay should be dispensed with and a sliding hammer should be used.

Puller application examples with specialty tools

- In industry, for motor vehicle and commercial vehicle components
- Pitman arm
- Ball joints, ball bearings, washers, wheels
- Sprockets, cogs



Puller basics

Always find the correct puller

HAZET separators and pullers

If it is not possible to use a standard external puller, e.g. with overlaying parts, it is possible to use the so-called separation puller

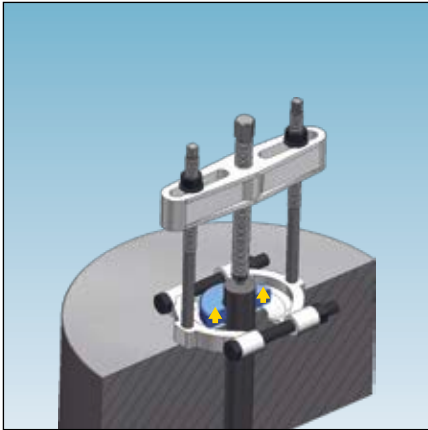

For this application, a separating device and a pulling device are normally used in combination.

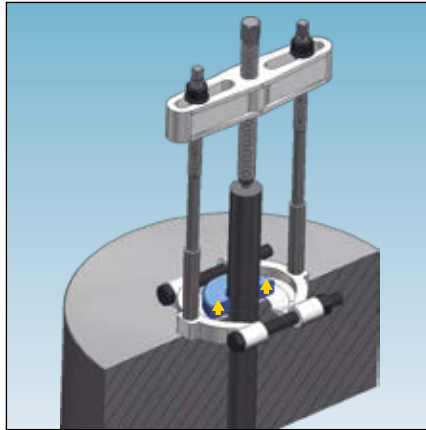

To pull longer shafts, it is also possible to extend the pulling device.

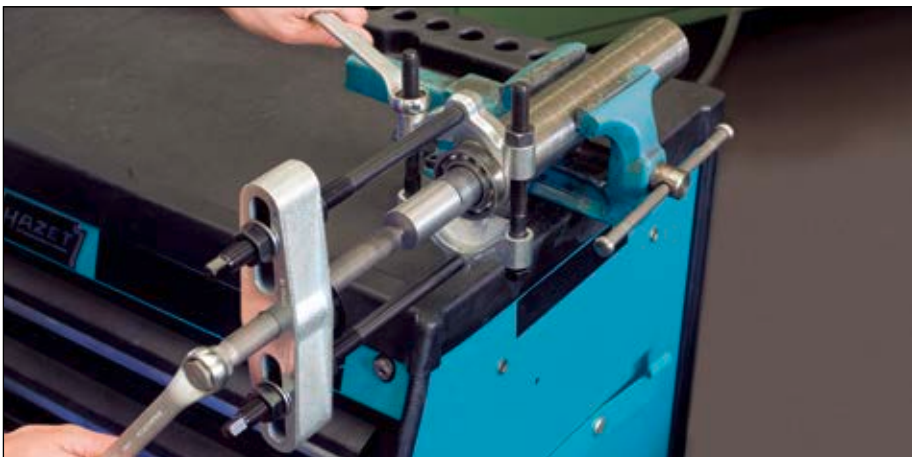

HAZET bearing extractor

If the bearings are located on a shaft and in a housing, HAZET bearing extractors are used.

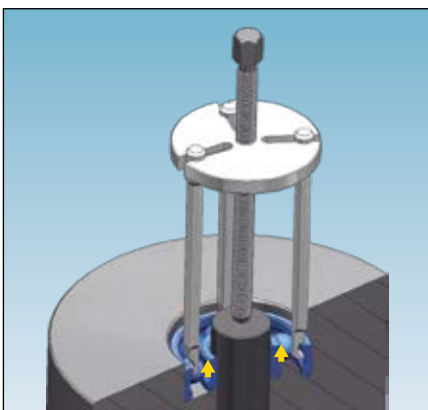

With HAZET No.1778-3/40 the bearing cage is operated on

Industrial bearings





Hand tools

Puller, 2-arm



Puller, 2-arm

1750 Quick-clamping puller · 2-arm

- Quick adjustment thanks to „one-nut“ fixation per arm
- Quick and easy installation
- Forged arms
- High strength and rigidity for safe work
- Solid all-steel bridge

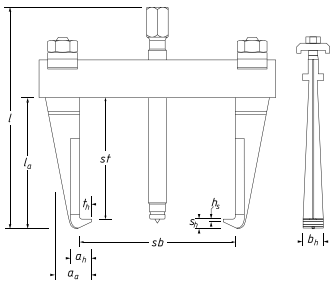

HAZET No.	bh mm	sh mm	th mm	hs mm	Max. t.	sb mm	st mm	EAN-No. 4000896+
1750-9	12	6	8	2	2	100	80	249923
1750-11	12	6	8	2	2	135	80	249947
1750-14	15	7.5	8	2.5	2	135	135	249961
1750-19	26	11.5	17	4	10	185	160	249985
1750-26	28	12	17	4	10	260	220	250028
1750-34	36	15	18.5	5	20	345	260	250042
1750-44	36	15	18.5	5	20	440	260	250134

1750 Quick-clamping puller · 2-arm

- Quick adjustment thanks to „one-nut“ fixation per arm
- Quick and easy installation
- Forged arms
- High strength and rigidity for safe work
- Solid all-steel bridge
- 5-piece set in display stand



1750
1750-9 · 1750-11 · 1750-14 · 1750-19 · 1750-26



HAZET No.	EAN-No. 4000896+
1750/5	251476

1787 S Puller set · 2-arm

Made in Germany

- Slim hooks
- “3 in 1”
- 6 slender forged hooks in 3 pairs of different lengths
- For working in areas with restricted access

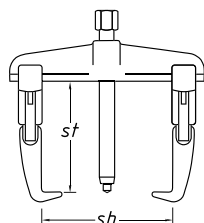

1787 S Puller set · 2-arm

HAZET No.	sb mm	st mm	EAN-No. 4000896+
1787 S-1	130	100-200-250	133222

- Spindle M14 x 1.5 x 140 mm
- Maximum 3 tonnes
- 2 hooks each 1786S-100 -200 -250 mm long

1783 Universal puller · 2-arm

Made in Germany

- Puller hooks can be used from both sides; hooks with one narrow side for areas with restricted access

- Application: Removing sprockets and ball bearings
- Automatic gripping of the puller hooks
- 2-arm design
- Surface: galvanised

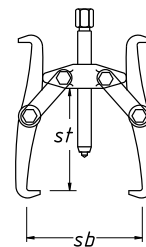

HAZET No.	Max. t.	sb mm	st mm	Spindle	EAN-No. 4000896+
1783-22	5	220	170	M 18 x 1.5 x 170 mm	136063

1792 Fan puller · 2-arm · adjustable

Made in Germany

- 2-arm design
- Very slender hooks with 3 clamping depth adjustments
- Rugged and drop-forged design

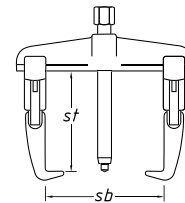

HAZET No.	Max. t.	sb mm	st mm	Spindle	EAN-No. 4000896+
1792-1	2	150	200	M 14 x 1.5 x 155 mm	147830

1776 Pitman arm puller · 2-arm

Made in Germany

- For ball bearings, toothed wheels, pinions, pitman arms and similar
- The clamp clip is used for pressing the puller jaws on the parts to be extracted
- Surface: galvanised

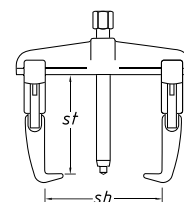

HAZET No.	sb mm	st mm	Spindle	EAN-No. 4000896+
1776-100	90	100	M 18 x 1.5 x 130 mm	135950



Puller, 3-arm

1785 Puller · 3-arm

Made in Germany

- **Easy application due to quick pulling system**
- Precisely manufactured head allowing quick and accurate application
- High-quality steel and thermo-chemical treatment providing a high pressure capacity of the spindle and a high tensile capacity of the hooks
- Flexible, interchangeable spindle tip provides various application possibilities
- Hooks open by simple rotation and enclose automatically the part to be pulled out, even for vertical application (no readjustment necessary)
- Encapsulated mechanics, maintenance-free

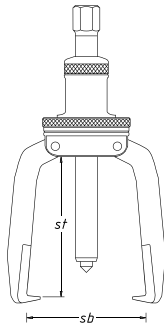

HAZET No.	Max. t.	sb mm	st mm	Spindle	EAN-No. 4000896+
1785-150	6.5	150	130	G 1/2" x 250 mm	133154
1785-250	6.5	250	250	G 1/2" x 350 mm	133161

1786 S Puller set · 3-arm

Made in Germany

- **Slim hooks**
- "3 in 1"
- 9 slender **forged hooks** in 3 pairs of different lengths
- For working in areas with restricted access
- 3-arm design, 3 hooks each
- Provides uniform load distribution, safe gripping and centred pulling action

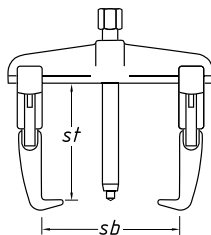

HAZET No.	sb mm	st mm	EAN-No. 4000896+
1786 S-1	130	100-200-250	133246

• Spindle M14 x 1.5 x 140 mm
 • Maximum 3 tonnes
 • 3 hooks each 1786S-100 -200 -250 mm long
 • Optional use with 300 mm puller hook 1786S-300

1786 S Puller set · 3-arm

Made in Germany

- **With 9 hooks**
- Professional set for all current clamping widths and depths (100–250 mm)
- Plastic box
- Soft foam insert



HAZET No.	sb mm	st mm		EAN-No. 4000896+
• Puller set, contents: 1786-01 1786-2 · 3 1786S-100 (3x) · 1786S-200 (3x) · 1786S-250 (3x)				
1786 S/12	120	100-200-250	12	133888

1789 Universal puller · 3-arm

Made in Germany

- **Puller hooks can be used from both sides; hooks with one narrow side for areas with restricted access**

- Application: Removing sprockets and ball bearings
- Automatic gripping of the puller hooks
- **3-arm design**
- Surface: galvanised



HAZET No.	Max. t.	sb mm	st mm	Spindle	EAN-No. 4000896+
1789-9	3	90	80	M 14 x 1.5 x 125 mm	147427
1789-16	5	160	130	M 18 x 1.5 x 170 mm	136070
1789-22	5	220	170	M 18 x 1.5 x 170 mm	136087
1789-32	12	320	260	G 1/2" x 350 mm	147731
1789-40	12	400	320	G 1/2" x 350 mm	147748

Puller st components

1787 F Puller hook · with quick-clamping device

Made in Germany

- Per piece
- For pullers 1786F and 1787F



HAZET No.	st mm	EAN-No. 4000896+
• For 1786F-13 • 1787F-9 · 13		
1787 F-0913	100	136117
• For 1786F-16 · 20 • 1787F-16 · 20		
1787 F-1620	150	136124
• For 1786F-25 • 1787F-25 · 35 • 1787-52		
1787 F-2552	200	136131



Hand tools

Separator



1787 Puller hook · without quick-clamping device

- Made in Germany
- Per piece



HAZET No.	s† mm		EAN-No. 4000896+
Puller hook (200 mm) For 1786F-25 · 1787F-25 · 35 · 1787-52			
1787-2552	200	-	136148
Puller hook without quick-clamping device For 1786F-13 · 1787F-9 · 13			
1787 LG-0913	200	-	136155
For 1786F-16 · 20 · 1787F-16 · 20			
1787 LG-1620	300	-	136162
For 1786F-25 · 1787F-25 · 35 · 1787-52			
1787 LG-2552	305	-	136179
1787 LG-2552/4	406	4	136186
1787 LG-2552/5	504	5	136193

1786 S Puller hooks · slim

- Made in Germany
- Per piece
- For pullers 1786S-1 and 1786S-2 as well as 1787S-1 and 1787S-2



HAZET No.	s† mm	EAN-No. 4000896+
Puller hook (100 mm) For HAZET 1786S-1 · 1787S-1 · 1786S/12		
1786 S-100	100	134762
Puller hook (150 mm) For HAZET 1786S-1 · 1787S-1 · 1786S/12		
1786 S-150	150	134816
Puller hook (200 mm) For HAZET 1786S-1 · 1787S-1 · 1786S/12		
1786 S-200	200	134779
Puller hook (220 mm) For HAZET 1786S-1 · 1787S-1 · 1786S/12		
1786 S-220	220	134823
Puller hook (300 mm) For HAZET 1786S-1 · 1787S-1 · 1786S/12		
1786 S-300	300	134830

Separator

1775 N Separator

- Made in Germany
- The separator is closed by operating the nuts on the stud bolts
- Surface: galvanised/burnished



HAZET No.	∅ mm	M	EAN-No. 4000896+
1775 N-75	12-75	M10	134540
1775 N-115	22-115	M14x1.5	134656

1775 N Extension

- Made in Germany
- Per pair
- Surface: burnished, oiled
- For 1775N-12 and -16



HAZET No.	l mm	M	EAN-No. 4000896+
1775 N-012	100	M10	134366

1775 N Separator and puller set

- Made in Germany
- For very confined spaces and tightly adjusted bearings
- Separators and pullers with extension
- The tension bolts are screwed into the threaded holes of the separation jaws together with the separators
- The separator is closed by evenly operating the nuts on the stud bolts
- Sheet metal box (HAZET blue)



HAZET No.	sb mm		EAN-No. 4000896+
1775 N 1775 N-75 · 1775 N-012			
1775 N/4	60-165	4	133208
1775 N 1775 N-115			
1775 N-1/4	70-215	4	133215

1780 Removal and assembly fork

- Made in Germany
- Proven and economical system



- Application: Wedge-shaped fork end allows fast operation of push rod and steering tie rod ends, pitman arms and other parts of the steering
- Easy to handle
- Shock absorber removal and other separation work
- Application possible in confined spaces
- Sturdy forged design

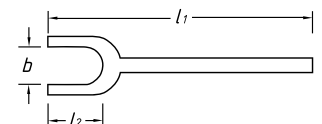

HAZET No.	l1 mm	l2 mm	b mm	EAN-No. 4000896+
1780-23	340	80	23	133352
1780-29	350	80	29	133376



Internal extractor

1788 N Internal extractor

Made in Germany

- Application: Extracting ball bearings, outer rings and bushings
- To be used with counter stays 1788N-835 and 1788N-4570



¹⁾ Reinforced bond – easy and safe extraction of needle bearings, ball bearings and brass sleeves

HAZET No.	∅ mm	M	EAN-No. 4000896+
1788 N-12 ¹⁾	12–14	M10	147694
1788 N-14 ¹⁾	14–19	M10	147700
1788 N-15	12–15	M10	134861
1788 N-19	15–19	M10	134878
1788 N-25	19–25	M10	134885
1788 N-30	25–30	M10	134892
1788 N-35	30–35	M10	134915
1788 N-45	35–45	M14x1.5	134502
1788 N-55	45–55	M14x1.5	136209
1788 N-70	55–70	M14x1.5	136216

1788 N Counter stay

Made in Germany

- For internal extractors HAZET 1788N-12 to 1788N-70
- Surface: chrome-plated



HAZET No.	Spindle	EAN-No. 4000896+
• For internal extractors 1788N-12 up to 35		
1788 N- 835	M 10 mm	134854
• For internal extractors 1788N-45 up to 55		
1788 N-4570	M 14x1.5 mm	134908

1788 N Internal extractor set

Made in Germany

- Extracting ball bearings, outer rings and bushings
- Internal extractor and counter stay
- Sheet metal box (HAZET blue)



1788 N Internal extractor set

HAZET No.		EAN-No. 4000896+
1788 N		
1788 N-835 • 1788 N-4570 • 1788 N-15 • 1788 N-19		
1788 N-25 • 1788 N-30 • 1788 N-35 • 1788 N-45		
1788 N/8	8	133185
1788 N		
1788 N-835 • 1788 N-4570 • 1788 N-15 • 1788 N-19 • 1788 N-25		
1788 N-30 • 1788 N-35 • 1788 N-45 • 1788 N-55 • 1788 N-70		
1788 N/10	10	147939

1788 T Internal extractor set

Made in Germany

- **Titanium-nitrided surface** extra hard and wear-resistant
- For tightly-packed ball bearings, rings, bushings and shaft seals Simmer®
- Flexible material
- Absolutely precise manufacturing accuracy providing a higher power transfer
- High ease of use
- **Only 4** Internal Extractors allow to cover the range from 5 to 36 mm
- To be used sliding hammer or counter stay
- Well-composed set
- Hard and wear-resistant titanium nitrided surfaces providing a better and heat-resistant surface protection
- **Application:**
- Insert internal extractor into bearing and screw in spindle
- The sharp shells press behind the part to be removed
- Place sliding hammer or counter stay in position
- Plastic box



HAZET No.	M	l mm		EAN-No. 4000896+
• Internal extractor set, contents:				
1788T-1 • 1788T-8.5				
1788T-15 • 24 • 36				
1788 T/5	–	–	5	133666
• Impact extractor (sliding hammer – sliding weight 200 g) with coupler thread M10				
• Removal of caps with inside thread, ball bearings, washers etc.				
• To be used with stud bolt set 1788T-1/6 and internal extractors 1788N-15 to 35				
• Also together with injector extractor 4797-5				
1788 T-1	M10	226	–	134304

1788 T Stud bolt set

Made in Germany

- Application: Removing different caps with inside thread
- **6-piece set**, • stud bolts with M10 coupler thread, contents: 1 piece each threaded insert M4, M5, M6, M8, M10, M12
- Use with sliding hammer 1788T-1



HAZET No.		EAN-No. 4000896+
1788 T-1/6	6	141647



Hand tools

Internal extractor



1788 T Impact extractor

Made in Germany

- Application: For disassembly of tight common rail injectors **without** removing the cylinder head



HAZET No.	M	l mm	EAN-No. 4000896+
1788 T-1	M10	226	134304
4797-5	-	174	176137

Easy removal of injectors together with impact extractor e.g. **HAZET 1788 T-1**

- Impact extractor (sliding hammer – sliding weight 200 g) with coupler thread M10
- Removal of caps with inside thread, ball bearings, washers etc.
- To be used with stud bolt set 1788T-1/6 and internal extractors 1788N-15 to 35
- Also together with injector extractor 4797-5

• **Injector claw** with inside thread M10x1.5 mm

- MAN Engines D08 · D20 · D26 · D28
- Suited to the very limited space conditions in the cylinder head
- Due to the tool's claw, the injector in the upper part may be gripped without causing damage

1774 Beam puller

Made in Germany

- Drop forged, tempered hooks

- Application: Tensioning, pulling, pressing of timbers
- Beam puller**
- Galvanized hooks, chrome-plated ratchet
- Ergonomic design – with reversible ratchet
- Smooth running acme thread TR 16x5
- Span: 115 mm
- Total width: 440 mm
- Length of ratchet: 275 mm



HAZET No.	EAN-No. 4000896+
1774-1	180578

1778 Ball bearing extractor set

Made in Germany

- Considerably easier application than existing systems on the market providing more efficiency and productivity
- Application: Removal of ball bearings mounted on shafts and located in housings
- For more than 40 standard ball bearings up to size 6311
- User-friendly device prevents the puller hooks from falling off
- 100% power transmission due to self-gripping closure
- 40-piece set**
- For ball bearing 6000 to 6407

Bearing	Hook	Receptacle
6000	1778-10	1778-3
6001	1778-10	1778-2
6002	1778-10	1778-1
6003	1778-10	1778-2
6004	1778-30	1778-1
6005	1778-30	1778-1
6006	1778-30	1778-1
6007	1778-40	1778-1
6008	1778-40	1778-1
6009	1778-40	1778-1
6010	1778-40	1778-1
6200	1778-10	1778-2
6201	1778-20	1778-3
6202	1778-20	1778-2
6203	1778-30	1778-2
6204	1778-40	1778-2
6205	1778-40	1778-1
6300	1778-30	1778-1
6301	1778-40	1778-1
6302	1778-40	1778-3
6303	1778-40	1778-3
6304	1778-40	1778-3

Bearing	Hook	Receptacle
6011	1778-50	1778-4
6012	1778-50	1778-4
6206	1778-50	1778-4
6207	1778-50	1778-4
6208	1778-60	1778-4
6209	1778-60	1778-4
6210	1778-60	1778-4
6211	1778-60	1778-4
6212	1778-70	1778-4
6213	1778-70	1778-6
6305	1778-60	1778-6
6306	1778-60	1778-5
6307	1778-60	1778-5
6308	1778-70	1778-5
6309	1778-70	1778-5
6310	1778-70	1778-5+1778-8
6311	1778-70	1778-5+1778-9
6403	1778-60	1778-4
6404	1778-70	1778-4
6405	1778-70	1778-6
6406	1778-70	1778-6
6407	1778-60	1778-6+1778-7



Note: this table serves as an orientation aid when selecting the extractor parts and does not claim to be correct and/or complete

HAZET No.	40	EAN-No. 4000896+
1778-3/40		133697

Ball joint puller tools can be found under
Specialty Tools → Chassis → Wheel Bearing / Wheel Hub from page 458



Grinding, separation and cutting

2128 Twist drill bits in case

- **Save time and energy:** The HSS twist drills enable rapid drilling with less contact force than conventional drills
- Powerful, precision-ground twist drills made of high performance HS steel (HSS)
- Self-centring drill bit with taper surface grinding according to DIN 1412 · 118° point angle · perfect centring without centre punch or wandering
- Two cutting edges and two spiral grooves remove the chip quickly and extend the use life
- Long use life (service life), excellent wear resistance thanks to robust core thickness and emphasised hardness (surface finish) for the working area
- Cylindrical shaft (shaft diameter corresponds to drill diameter) · Diameter tolerance h 8 · Highest precision (increased concentric accuracy)
- 25-piece, \varnothing 1 – 13 mm increasing by 0.5 mm: 1 drill each x \varnothing 1.0 · 1.5 · 2.0 · 2.5 · 3.0 · 3.5 · 4.0 · 4.5 · 5.0 · 5.5 · 6.0 · 6.5 · 7.0 · 7.5 · 8.0 · 8.5 · 9.0 · 9.5 · 10.0 · 10.5 · 11.0 · 11.5 · 12.0 · 12.5 · 13.0 mm
- Right hand cutting
- DIN 338



HAZET No.	EAN-No. 4000896+
2128 N-1	218844

1967 Welding spot drill

- **Made in Germany**
- Self-cutting centring tip resharpenable

- High performance, high-speed steel, blued



HAZET No.	l mm	\varnothing mm	EAN-No. 4000896+
1967-70	74	7	009343
1967-80	79	8	009350
1967-90	79	9	009367

1967 Welding spot drill

- **Made in Germany**

- Suitable for drills
- 7 mm hexagon shank prevents slippage in drill chuck
- Replaceable cutting crown (right-hand thread) made of high-speed steel (oiled)
- Cutting crown for use at both ends
- With screw for gauge depth adjustment (*)



HAZET No.	l mm	\varnothing mm	EAN-No. 4000896+
1967	70	11	009312
Spare cutting crowns, set of 5, for 1967			
1967-01/5	–	–	211319
• Tip for HAZET welding spot drill 1967			
1967-02	–	–	009336

2150 Marking tool

- Surface: burnished, oiled



HAZET No.	l mm	EAN-No. 4000896+
2150	240	013012

- Special steel for long-lasting use
- With fastening clip



HAZET No.	l mm	EAN-No. 4000896+
2150-1	150	144129

2119 Half-round file

- **Made in Germany**
- Teeth (cut): 2 = medium
- Plastic handle
- DIN 7261 form E

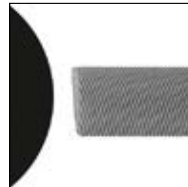

HAZET No.	l mm	EAN-No. 4000896+
2119- 8	200	012398
2119-10	250	012381

2120 Round file

- **Made in Germany**
- Teeth (cut): 2 = medium
- DIN 7261 form F

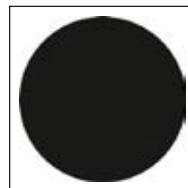

HAZET No.	l mm	EAN-No. 4000896+
2120- 8	200	012411
2120-10	250	012404



2123 Three square file

- Made in Germany**
- Teeth (cut): 2 = medium
- DIN 7261 form C

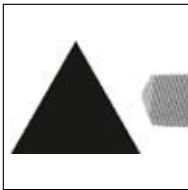

HAZET No.	l mm	EAN-No. 4000896+
2123- 8	200	012473
2123-10	250	012466

2122 Flat hand file

- Made in Germany**
- Teeth (cut): 2 = medium
- DIN 7261 form A



HAZET No.	l mm	EAN-No. 4000896+
2122- 8	200	012435
2122-10	250	012428

4968 Brake calliper file

- Made in Germany**
- One-sided cut prevents damage to the dust boot at the brake piston
- 12 mm wide
- Blunt scraper on the face side for removing rough residues
- Cut of the file: coarse bevel cut on one side
- Plastic handle

Video



HAZET No.	l1 mm	l2 mm	EAN-No. 4000896+
4968-1	150	260	084739

- Made in Germany**
- Extra slim style (width 10 mm), suitable for Japanese vehicles
- Blunt scraper on the face side for removing rough residues

Video



4968 Brake calliper file

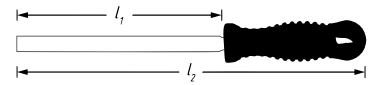

HAZET No.	l1 mm	l2 mm	EAN-No. 4000896+
4968-5	155	265	129379

- Made in Germany**
- Extra slim design

Video



- Square brake calliper file
- Very good service life
- 10 x 10 mm
- Plastic handle with hanging hole

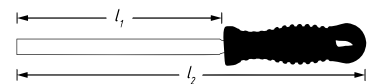

HAZET No.	l1 mm	l2 mm	EAN-No. 4000896+
4968-6	155	265	218431

824 Blunt scraper

- Made in Germany**
- 824 long blade
- 824-1 short blade
- Surface: galvanised

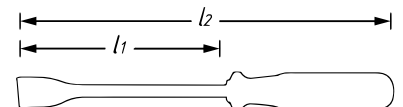

HAZET No.	l1 mm	l2 mm	mm	b mm	EAN-No. 4000896+
824	150	270	0.5	23	033881
824-1	55	165	0.5	23	033898

824-6 Painter's spatula

- Made in Germany**
- Flexible, milled blade

- Application: For the removal of wallpaper residue or adhesive from surfaces · filling cable slots or installation boxes with plaster · covering transitions on plasterboard walls
- Blade width: 60 mm
- Lacquered, flat handle with hanging hole



HAZET No.	EAN-No. 4000896+
824-6	247608



825 Blunt scraper

- Replaceable hard-metal tip



HAZET No.	l_1 mm	l_2 mm	$\frac{b}{l_1}$ mm	b mm	EAN-No. 4000896+
825-25	267	397	2	25	033959
• Hard-metal tip for 825-25					
825-025	-	-	-	25	033928

821 Hollow three-square scraper

Made in Germany

- Tips ground

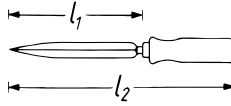

HAZET No.	l_1 mm	l_2 mm	EAN-No. 4000896+
821-1	150	260	033683
821-2	200	315	033690

823 Fine three-square scraper

Made in Germany

- Protective coating made of viscoplastic and impact-resistant plastic material



- With protection cap



HAZET No.	l_1 mm	l_2 mm	EAN-No. 4000896+
823	25	148	033874

822 Angle scraper

- Replaceable HSS bimetal turning blades



- Scraping sealing residues, e.g. at the cylinder head
- Scraping cable channels in Ytong blocks
- Environmentally friendly work:
 - no formation of dust
 - no generation of noise
 - no production of chlorine or dioxin gas (as it occurs e.g. when burning residues)
- Surface: chrome-plated



HAZET No.	l mm	b mm	EAN-No. 4000896+
• Handle only with blade 822-01 (flat)			
822	260	20	033713
• Spare blade set for 822 5 pieces per set			
822-01/5	-	-	033720

1980 N Hack saw

- With saw blade tensioning end screw
- With 1 saw blade 24 teeth/inch
- For 300 mm saw blades
- DIN 6494 form A



HAZET No.	$L \times W \times H$ mm	l mm	EAN-No. 4000896+
1980 N	-	390	009824
Saw blade			
• 24 teeth/inch			
• 300 mm long			
• One-sided			
• Fully hardened and elastic			
1980 B-2	300x0.63x12.5	300	009817

1981 Small hack saw

Made in Germany

- For saw blades 150 mm
- With 1 saw blade made of chrome-alloyed tool steel
- Number of teeth/inch: 32 (1 inch = 25.4 mm)
- Handle made of glass fiber reinforced plastic
- Special purpose steel St 2 K 40



HAZET No.	l mm	EAN-No. 4000896+
1981	252	009831
• Saw blade for 1981, made of chrome-alloyed tool steel		
• Number of teeth/inch: 32 (1 inch = 25.4 mm)		
1981-01	150	009848

2158 Universal shears

- Ergonomic design allows one-hand operation of the locking device



- Blades: rust-resistant stainless steel
- Locking device
- Additionally with round cutter for wire stripping (1 or 1.5 mm²)
- Wire guide for cutting lashing wire up to 2.5 mm \varnothing
- HAZET 2-component handle



HAZET No.	l mm	EAN-No. 4000896+
2158	194	057856

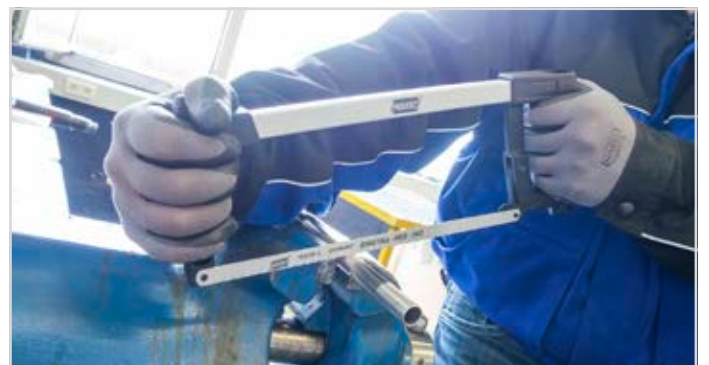



Hand tools

Grinding, separation and cutting



2157 Universal knife

- Multipurpose knife
- **Spare blades deposit**
- One snap-off, straight and hook blade each
- **Housing made of fibre-glass reinforced plastic**
- One-hand operation for blade insertion and locking
- Blade is securely locked

(E)



HAZET No.	l mm	EAN-No. 4000896+
2157	167	013203
• Snap-off blades , e.g. for trimming knife 2157 · 7 break-away parts 100x18 mm set of 10 pieces		
2157-04	–	013210
• Trapezoid blades with 2 holes · e.g. for universal knife 2157 set of 10 pieces		
2157-05	–	013227
• Hook blades · e.g. for universal knife 2157 · set of 10 pieces		
2157-06	–	013234

2157 Jack-knife

- Quick blade replacement
- Including 5 spare blades
- Comfortable handle made of impact resistant ABS
- Blade magazine with safety lock
- Thumb cushion enables joint-protecting working
- Folded length: 100 mm

(E)



HAZET No.	l mm	EAN-No. 4000896+
2157-1	159.9	147236
• Trapezoid blades with 3 holes · e.g. for 2157-1 set with 10 pieces		
2157-07	–	150977



2157 Mini utility knife

- Quick blade changing
- Blade fastener
- Convenient handle made of ABS
- Release lever for comfortable blade closing
- Blade magazine with safety lock
- With 5 spare blades
- Length in hinged position: 57 mm

(E)



HAZET No.	l mm	EAN-No. 4000896+
2157-2	100	164318
• Spare trapezoid blades for HAZET mini utility knife 2157-2 Set of 10 pieces		
2157-08	–	166022

2157 Jack-knife

- **Blade lock in the opened position –the knife is prevented from snapping shut unexpectedly**

- Aluminium grip with moulded handle
- High-quality stainless steel blade
- Lightweight and easy to handle
- Practical belt clip
- Length in hinged position 115 mm



HAZET No.	l ₁ mm	l ₂ mm	EAN-No. 4000896+
2157-3	86	201	231089

2180 Tube cutter

- **4 guide rollers for optimum hold on the pipe whilst cutting**

(E)

- Integrated NOGA deburring blade, can be pulled out completely
- Quick change system allows the cutting wheel to be changed quickly without tools
- Including 2 cutting wheels (2180N-021): one installed in head and one in rotary knob cap
- Steel supported spindle for better sliding
- Body made of magnesium die-cast
- Slide and turn knob made of zinc die-cast



HAZET No.	l mm	Ø mm	EAN-No. 4000896+
2180 N-2	145	6–35	198986
• Spare cutter wheel for 2180N-2 and 2181N-1			
2180 N-021	–	–	198993



4682 Chain tube cutter

- Easy adjustment due to thumb screw during cutting process

- Application: **Cutting of pipes**, e.g. made of steel (not stainless steel) up to 2.5 mm wall thickness and 75 mm \varnothing
- Extended cutting diameters are achieved by using extension chain HAZET 4682-01
- Little effort, fixed with **Grip technique**
- Surface: nickel-plated



HAZET No.	l mm	\varnothing mm	EAN-No. 4000896+
4682	255	15-75	022168
• Spare chain for 4682			
4682-01	-	-	022175
• Replacement set · 9 pieces for repairing the cutting chain 4682-01 For 4682			
4682-01/9	-	-	057214

- Easy adjustment due to thumb screw during cutting process

- Application: **Cutting pipes** made of galvanized steel, copper, PVC and aluminium up to a wall thickness of 6 mm and 115 mm \varnothing
- 15 cutting wheels made of alloyed steel
- Surface: nickel-plated



HAZET No.	l mm	\varnothing mm	EAN-No. 4000896+
4682-1	315	20-115	149384
• Spare chain for 4682-1			
4682-03	-	-	149421

2181 Small tube cutter

- Cutting aluminium, copper and thin-walled metal tubes

- „Instant Change System (ICS)“ allows the cutting wheel to be changed quickly without tools
- Steel supported spindle for better sliding
- Significantly reduced work radius
- Including 1 cutting wheel (2180N-021)
- Ergonomic rotary knob for optimum handling
- Body, carriage and rotary knob made from die-cast zinc
- Surface: lacquered



HAZET No.	l mm	\varnothing mm	EAN-No. 4000896+
2181 N-1	52	3-16	198979
• Spare cutter wheel for 2180N-2 and 2181N-1			
2180 N-021	-	-	198993

2130 Wire brush

- **Made in Germany**

- Wear-resistant wire bristles

- 4 rows
- Trim size: 25 mm
- Wooden body
- Suspension hole



HAZET No.	l mm	EAN-No. 4000896+
2130	290	012510

- 4 rows
- V2A bristles
- Wooden body
- Suspension hole



HAZET No.	l mm	EAN-No. 4000896+
2130-1	280	012527

2131 Spark plug brush

- **Made in Germany**

- Special corrugated brass wire bristles

- Application: **Cleaning electrodes and contacts on spark plugs**
- 3 rows
- Trim size: 15 mm
- Wooden body



HAZET No.	l mm	EAN-No. 4000896+
2131	150	012541

4968 Brake calliper brush

- **Made in Germany**

- Slim design

- Application: Removing stubborn brake dust and dirt from the disc brake calliper
- Plastic handle with suspension hole



HAZET No.	l mm	EAN-No. 4000896+
4968-2	225	084821

4968 Brass brake calliper brush

- **Made in Germany**

- Soft brass bristles facilitate damage-free cleaning

- Application: Cleaning **aluminium brake callipers**
- Slim design – allows working in areas with restricted access
- Plastic handle with suspension hole



HAZET No.	l mm	EAN-No. 4000896+
4968-3	225	089147



Thread repair

840 Screw extractor

- Ground



HAZET No.	Ø mm	M	EAN-No. 4000896+
840-1	2	4	035687
840-2	3-3.5	6-7	035694
840-3	4-4.5	8-10	035700
840-4	6-7	12-14	035717
840-5	8-9	14-18	035724

840 Screw extractor set

- Plastic box



HAZET No.		EAN-No. 4000896+
• Screw extractor set, contents: 840-1 · 2 · 3 · 4 · 5		
840/5	5	035762
• Screw extractor set, contents: 840-1 · 2 · 3 · 4 · 5 · 6 · 7 · 8		
840/8	8	035786

841 Stud extractor set

- Plastic box
- Surface: burnished, oiled

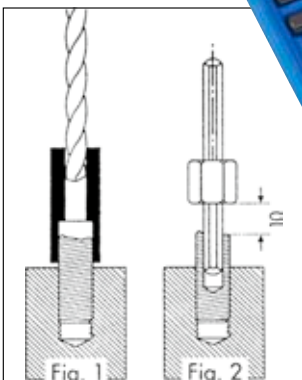

841 Stud extractor set

HAZET No.		EAN-No. 4000896+
25 pieces, in plastic box		
841/25	25	060993
• Union nuts For 841/25		
841-01	-	074433
841-02	-	074440
841-03	-	074457
841-04	-	074464
841-05	-	074471
• Tapping sleeves For 841/25		
841-06	-	074488
841-07	-	074495
841-08	-	074501
841-09	-	074518
841-010	-	074525
841-012	-	074549
841-013	-	074556
841-014	-	074563
841-015	-	074570
• Stud extractor For 841/25		
841-016	-	074587
841-017	-	074594
841-018	-	074600
841-019	-	074617
841-020	-	074624

Tapping sleeve	Drill Ø mm	Union nut	Stud extractor	Suitable for	
841-06	4	841-01	841-016	M 5	3/16"
841-07	4		841-016	M 6	9/32" 1/4"
841-08	4		841-016	M 7	9/32"
841-09	4		841-016	M 8	5/16"
841-010	5	841-02	841-017	M 8	5/16"
841-011	5		841-017	M 9	11/32"
841-012	5		841-017	M10	3/8"
841-013	6	841-03	841-018	M11	7/16"
841-014	7,5	841-04	841-019	M12	15/32"
841-015	8,5	841-05	841-020	M14	9/16"

844 Stud bolt extractor

Made in Germany

- For installing and removing stud bolts and set screws with right-hand or left-hand thread without damage
- □ Drive 12.5 = 1/2" or ≤ 21 mm outside hexagon
- Surface: chrome-plated, polished

12.5 1/2"



HAZET No.	l mm	Ø mm	□ mm	EAN-No. 4000896+
844- 6	65	23	6	035823
844- 7	65	23	7	035830
844- 8	65	23	8	035847
844-10	75	27	10	035809
844-12	75	27	12	035816



844 Stud extractor set

Made in Germany

- Plastic box 165-S (1/9)
- Safety-Insert-System, 2-component soft foam insert. Insert also suitable for HAZET Assistant
- Surface: chrome-plated, polished

125 1/2 E

1/9					
-----	--	--	--	--	--



844 • 125 1/2

844-6 • 844-7 • 844-8 • 844-10 • 844-12



HAZET No.	L x W x H mm		EAN-No. 4000896+
844/5	185x153x52	5	035878

842AG Universal thread repair tool

• For thread diameters 4–13 mm ($\frac{5}{32}$ " – $\frac{1}{2}$ ")

- Application: Repairs right-hand and left-hand threads (observe direction of rotation)
All forms of metric and non-metric threads (60° flank measurement)
- Quick fixation due to adjusting screw
- Blade automatically adapts to any thread pitch within range



HAZET No.	M	EAN-No. 4000896+
842AG-1	4–13 mm / $\frac{5}{32}$ " – $\frac{1}{2}$ "	140718

• For thread diameters 16–38 mm ($\frac{5}{8}$ " – $1\frac{1}{2}$ ")

- Application: Trimming right-hand and left-hand threads (observe direction of rotation)
all forms of metric and non-metric threads (60° flank measurement)
- Quick fixation due to adjusting screw
- Blade automatically adapts to any thread pitch within range



HAZET No.	M	EAN-No. 4000896+
842AG-3	16–38 mm / $\frac{5}{8}$ " – $1\frac{1}{2}$ "	149230

842AIG Universal thread repair tool kit

• For outside thread 4–13 mm ($\frac{5}{16}$ " – $\frac{1}{2}$ ") and inside thread 5–12 mm ($\frac{13}{64}$ " – $\frac{1}{2}$ ")

- Application: Repairing right-hand and left-hand threads (all forms of metric and non-metric threads)
- Simple and quick fixation due to knurled screw
- Also for aluminium threads
- 1 tool for outside threads
- 2 tools for inside threads
- Protective covers for aluminium threads



HAZET No.		EAN-No. 4000896+
842AIG-1/4	4	153428

842N Thread repair set

- Thread reinforcement of materials presenting a low shearing resistance. Application in machine construction, automotive engineering, electrical and medical engineering, for example
- Chrome-nickel stainless steel provides good inside threads resisting the influences of weathering and corrosion
- Plastic box

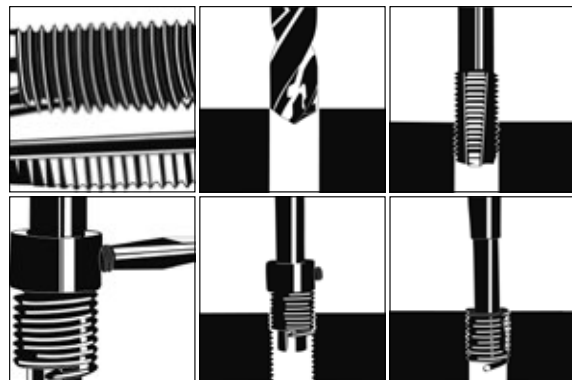

HAZET No.		EAN-No. 4000896+
-----------	--	------------------

- **118-piece set** · M6 to M14
- M14 especially for spark plug thread
- Contents:
 - 25 threaded inserts each
 - M6 x 1 mm x 9 mm
 - M8 x 1.25 mm x 12 mm
 - M10 x 1.5 mm x 15.0 mm
 - 10 threaded inserts M12 x 1.75 mm x 18 mm
 - 5 threaded inserts each
 - M14 x 1.25 mm x 8.4 mm
 - M14 x 1.25 mm x 12.4 mm
 - M14 x 1.25 mm x 16.4 mm
- 4 twist drills, 5 thread cutters, 5 assembly tools, 4 pin breaking tools

842N-614/118	118	167272
--------------	-----	--------



849 Tap and die set

Made in Germany

• High performance thread cutter made of HSS steel

- Application: Problem-free **rethreading** even in areas with restricted access
- Operation with reversible ratchet
- Plastic box 165-L (1/3)
- Safety-Insert-System, 2-component soft foam insert. Insert also suitable for HAZET Assistant
- Tap and die set, contents:
849IG-M3 · M4 · M5 · M6 · M8 · M10 · M12
849AG-M3 · M4 · M5 · M6 · M8 · M10 · M12
849IG-6.3 · 8
849AG-6.3 · 10
2100-025 · 2250-1 · 3



Ⓔ

1/3				
-----	--	--	--	--

HAZET No.	L x W x H mm		EAN-No. 4000896+
849	355x235x65	21	035984

849 IG COMPONENTS

Made in Germany

- Surface: nickel-plated
- DIN ISO 2936

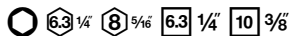

HAZET No.	l mm	l ₁ mm	l ₂ mm	M	EAN-No. 4000896+
• Tap for inside thread					
849 IG-M3	-	-	-	M3x0.5	036127
849 IG-M4	-	-	-	M4x0.7	036134
849 IG-M5	-	-	-	M5x0.8	036141
849 IG-M6	-	-	-	M6x1.0	036158
849 IG-M8	-	-	-	M8x1.25	036165
849 IG-M10	-	-	-	M10x1.5	036103
849 IG-M12	-	-	-	M12x1.75	036110
• Dies for male threads					
849 AG-M3	-	-	-	M3x0.5	036035
849 AG-M4	-	-	-	M4x0.7	036042
849 AG-M5	-	-	-	M5x0.8	036059
849 AG-M6	-	-	-	M6x1.0	036066
849 AG-M8	-	-	-	M8x1.25	036073
849 AG-M10	-	-	-	M10x1.5	036011
849 AG-M12	-	-	-	M12x1.75	036028
• Collet chuck					
• ● 6.3 = 1/4", for tap 849IG-M3 to M6 (together with connector 2250-1)					
849 IG-6.3	-	-	-	-	036080
• Collet chuck					
• ● 8 = 5/16", for tap 849IG-M8 to M12 (together with connector 2250-3)					
849 IG-8	-	-	-	-	036097
• Holder					
• Outer Ø 32 mm Inside Ø 25 mm					
• □ Drive 6.3 = 1/4", for dies 849AG-M3 to M6 (25 mm Ø)					
849 AG-6.3	64	-	-	-	036004
• Holder					
• Outer Ø 32 mm Inside Ø 25 mm					
• □ Drive 10 = 3/8", for dies 849AG-M8 to M12 (25 mm Ø)					
849 AG-10	68	-	-	-	035991
• Offset screwdriver					
2100-025	-	58.5	20.5	-	011285
• □ 6.3 = 1/4" → ○ 6.3 = 1/4"					
2250-1	23.5	-	-	-	015443
• □ 10 = 3/8" → ○ 8 = 5/16"					
2250-3	31	-	-	-	015474

2126 Thread restorer

- Application: Restoring damaged outside or inside threads
- Surface: nickel-plated
- Pitches from 0.8 to 3.0 mm



HAZET No.	l mm	EAN-No. 4000896+
2126	230	012497

847 Nut splitter · mechanical

Made in Germany

Ⓔ



HAZET No.	Ø mm	EAN-No. 4000896+
For nuts M6–M10		
• Splitting tight nuts of the quality ranges 5 and 6		
847-0410 A	M6–M10	139903
For nuts M10–M16		
• Splitting tight nuts of the quality ranges 5 and 6		
847-1027 A	M10–M16	139910
• Spare chisel for mechanical · HAZET nut splitters 847-0410A and 1027A		
847-10 A	-	144150



Measurement

2154 N Measuring tape

- Euro-Standard II
- Belt clip
- Extra large tape reduces flexure
- Lockable using slide button with integrated slide control
- Special hook (end of blade) for accurate interior and exterior measurements
- Shock-absorbing two-component plastic housing
- High-quality spring allows that the blade is automatically pulled in
- Tough coating protects from corrosion and wear
- Double measurement markings (on upper and lower edges)

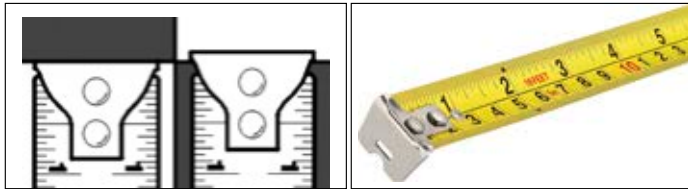

HAZET No.	l mm	b mm	EAN-No. 4000896+
2154 N-2	2000	16	143924
2154 N-3	3000	16	143931
2154 N-5	5000	19	143948

Made in Germany

- For inside and outside measurements
- Euro-Standard II
- 2 m
- Solid ABS-plastic housing, 76x56 mm



HAZET No.	l mm	EAN-No. 4000896+
2154-2	2000	013159

2154 Folding ruler

„Folding rule“

- A must-have for any building site, in any workshop, for handicrafts or in the household
- Carefully selected beech wood ensures special hardness and strength
- Internal hinges for continuous scaling
- Highly abrasion-resistant, dirt-repellent and moisture-proof protective coating
- Hardened, non-wearing internal steel spring hinges for long service life
- Scale: mm/cm 2-piece, printed on both sides
- 10 links
- EC accuracy class III
- Link thickness: 3.2 mm
- Black, lacquered



HAZET No.	l mm	EAN-No. 4000896+
2154-200	2000	247332

2152 Multimeter

- For trade, industry, do-it-yourselfers as well as car, commercial vehicle and agricultural workshops
- Including measuring tips for clipping into the protective cover
- Including temperature probe from -20°C to 200°C
- DC voltage: 0 - 600 V
- AC voltage: 0 - 600 V
- Direct current: 0 - 10 A
- Alternating current: 0 - 10 A
- Resistance: 0 - 60 MOhm
- Diode test
- During the continuity test, the integrated buzzer signals continuity below 50 Ohm
- Frequency: 0 - 10 MHz
- Duty cycle
- Capacitance measurement: 0 - 60 MOhm
- Automatic switch-off
- Backlight
- Data hold
- True RMS
- CAT III 600 V
- Including 2x AA batteries
- Easy operation thanks to clearly arranged control panel and large illuminated LCD display (all data quickly readable)
- Very short response times ensure rapid display of measurement results
- Optimal device alignment thanks to the stand on the housing
- Protective cover protects multimeter against damage from being dropped



HAZET No.	EAN-No. 4000896+
2152-600	246762

2154 Spirit level

- Anodized spirit level with high measuring accuracy from 1 mm/m (0.057°)
- Better readability in low light thanks to a fluorescent liquid in the block level
- High measuring accuracy in horizontal and vertical positions
- Shatterproof acrylic glass block levels
- Level installation is unaffected by temperature, allowing for measurements from -20°C to +50°C
- Antistatic level liquid
- Extremely strong aluminium profile with 590 g/m profile weight
- Acrylic glass block level with 30-year guarantee against leaking



HAZET No.	l mm	EAN-No. 4000896+
2154-40	400	246694
2154-80	800	246700



2154 Precision vernier calliper

Made in Germany

- Measuring range: up to 150 mm
- Depth gauge
- mm and inch increments
- Vernier 0.05 mm and 1/128"
- Fixing screw
- In pocket
- Made of stainless steel
- DIN 862



HAZET No.	l mm	EAN-No. 4000896+
2154-10	234	013142

2154 Vernier calliper · digital

- Measuring range: up to 150 mm
- Depth gauge
- Reversible from mm to inch
- With interface RS 232 C for data processing
- On/off switch
- Including battery
- Made of stainless steel
- Plastic box
- DIN 862



HAZET No.	l mm	EAN-No. 4000896+
2154 N-20	234	127696

2155 N Precision micrometer

- Clamp ring and ratchet stop
- Spindle hidden inside, ground and hardened, adjustable
- Insulating plates
- Carbide tipped measuring surface
- Pitch: 0.5 mm reading: 0.01 mm
- Wooden box
- DIN 863-3
- Measuring range 0–25 mm



HAZET No.	EAN-No. 4000896+
2155 N-25	127702

2155 Dial gauge



2155-65



2155 Dial gauge

HAZET No.	EAN-No. 4000896+
2155-60	144303

Magnetic dial gauge stand

- Magnetic base with prism support (e.g. for shafts)
- On/Off switch for magnetic force
- Dial gauge holder for 4.5 mm and 8 mm shaft
- Horizontal rod for fine adjustment and articulation

2155-60	144303
---------	--------

Mechanical dial gauge

- Scale graduation: 0.01 mm
- Measuring range: 8 mm
- 1 needle rotation: 1 mm
- Rotary and lockable scale
- Target area can be limited by two needles
- Clamping shaft: Ø 8 mm
- Dial gauge Ø 40 mm

2155-65	144501
---------	--------

2145 Precision knife-edge straightedge

Made in Germany

• Measuring edge hardened

- Application: Inspecting the evenness (flatness) of surfaces, e.g. cylinder head
- Ground and lapped
- Antirust
- Non-glaring
- Insulating handle
- In artificial leather case
- DIN 874-2



HAZET No.	l mm	EAN-No. 4000896+
2145-500	500	073146

2147 Feeler gauge

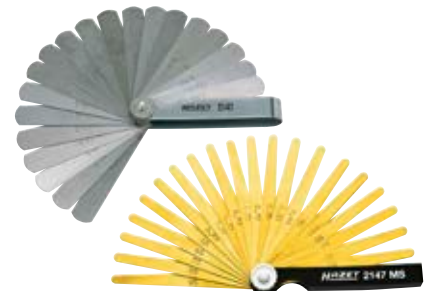

HAZET No.	l mm	mm	EAN-No. 4000896+
2147	106	0.05–1.0	012824

- mm dimensions = feeler gauge set D
- 20 pieces, increasing by 0.05–1.0 mm
- Stainless steel
- Length of blades (bore hole – tip): 69.73 mm
- Radius on the tip 15 mm
- Checking the **electrode distance in spark plugs**

2147	106	0.05–1.0	012824
------	-----	----------	--------

- Brass – non-magnetic –
- Setting e.g. sensors on **ABS**
- Checking the electrode distance of **platinum spark plugs**
- 20 pieces, increasing by 0.05–1.0 mm
- Checking the **electrode distance in spark plugs**

2147 MS	106	0.05–1.0	057603
---------	-----	----------	--------



Tools with protective insulation / Tools for electricians



Assortment, with protective insulation

274–276

Wrenches with protective insulation

275

Sockets with protective insulation

276–278

Screwdrivers with protective insulation

278–280

Pliers with protective insulation

280–282

Tools for electricians

282–282

Torque wrenches with protective insulation

283





Tools with protective insulation

For safe application up to 1000 volts

What are 1000 V tools?

- Tools with protective insulation have a special protective insulation and must be tested according to IEC 60900.
- The standard also prescribes the marking with the manufacturer name, model and article no. and year of manufacture. Tools with protective insulation are identified by the „Double triangle“ logo and the 1000 V specification.
- All requirements stipulated in the DIN ISO for the torque, forces and hardness, for example, must be complied with.

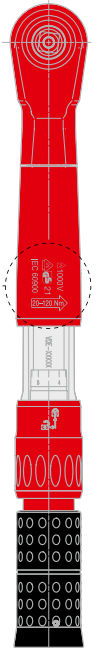
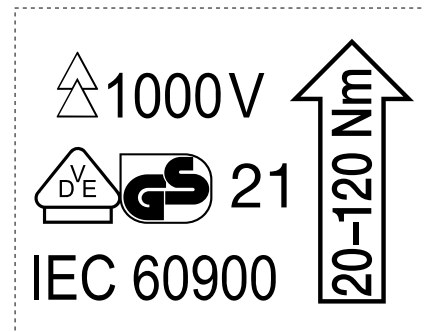

Special HAZET 1000 V protective insulation

- HAZET tools with protective insulation normally have a two-tone multilayer safety insulation, i.e. a red layer on the outside and a yellow layer on the inside. This design supports the building regulation BGV A3 (VBG-4)
- The insulation must not exhibit any visual damage. If the inner yellow insulation layer is visible anywhere, the tool must be disposed of immediately, since there is a risk of electric shock. It is no longer possible and extremely dangerous to work with the power connected.
- Tools with protective insulation whose insulation has been technically sprayed on only have a single layer of red insulation. For safety reasons, the user should therefore check that the insulation is intact before starting work with the power connected to guarantee their safety.

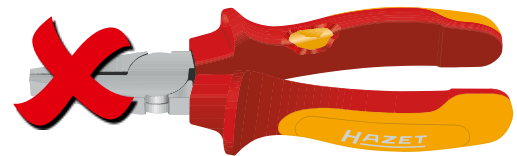
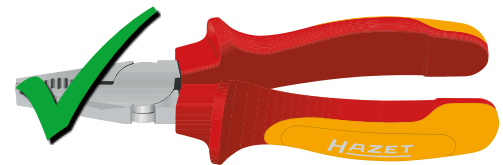

Things to know before working with 1000 V tools

Here are some safety precautions for your own protection and safety:

- All work under electrical voltage must only be carried out by trained specialist personnel
- Only tools and equipment that have the „Double triangle“ and 1000 V icon on them (see also building regulation BGV A3) are permitted
- Every time before starting work, the insulation must be checked for damage
- Dispose of damaged tools or ensure that they are NO LONGER used for work under voltage
- Comply with regulations from professional associations, etc. and/or power supply companies
- HAZET 1000 V tools ensure safe and risk-free work up to 1000 V AC (alternating voltage) and 1500 V (direct voltage)



Exemplary examples of VDE tests

on the model of a HAZET torque wrench with protective insulation

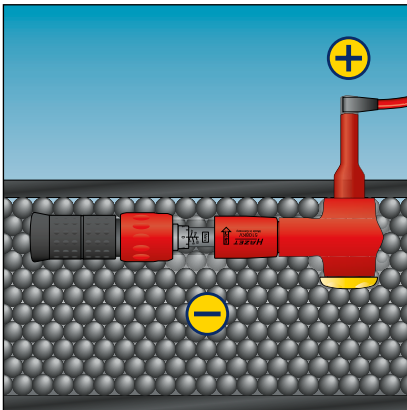

Electrical test [type testing]

No breakdowns or arcing may occur in the vicinity of the insulation after 48 hours of moisture-proof storage with a 3-minute measurement under 10,000 V.

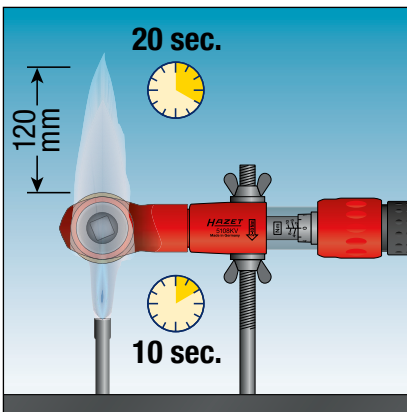

Burn test [type testing]:

After 10 seconds in a flame, the insulation must not prove to be „easily combustible“.

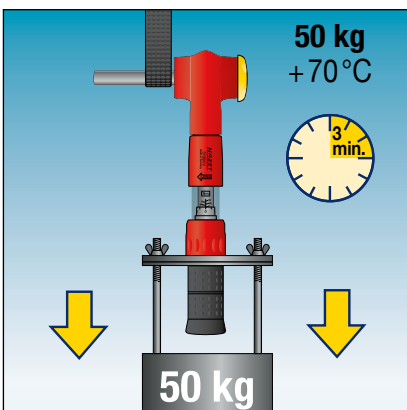

Test for adhesion:

The insulation must not come loose or slacken when under a tensile load for 3 minutes with 500 N after 168 hours in a climatic chamber at +70°C.

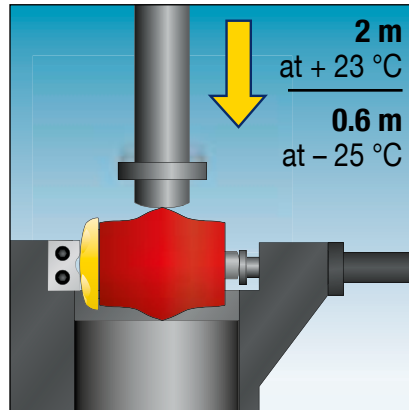

Cold impact test [type testing]:

With a retention time of 2 hours at an ambient temperature of -25 °C, the insulation must not present any cracks or other damage during targeted shocks and impacts (falling height 0.6 m).

Impact test at the ambient temperature:

At an ambient temperature of 23 °C, the insulation must not present any cracks or other damage after targeted shocks and impacts (falling height 2 m)

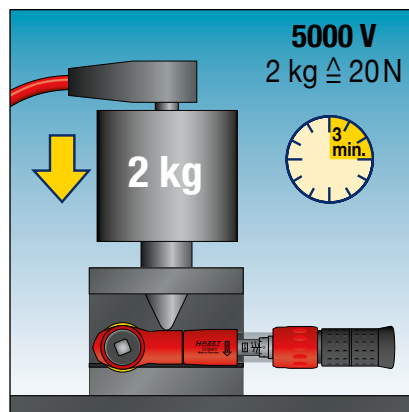

Pressure test [type testing]:

After being stored for 2 hours at a temperature of 70 °C, with a pressure load of 20 N and a 3-minute measurement under 5,000 V, there must be no punctures or arcing in the insulation.



Hand tools

Tools with protective insulation / Tools for electricians



0-20 Tool assortment · with protective insulation

- Tool assortment for electricians
- IEC 60900:2018



- | | | |
|---------------------------|-------------|------------|
| 810VDE • | 1816VDE-22 | 1850VDE-22 |
| 0.4x2.5 • 0.6x3.5 • 0.8x4 | | |
| 810VDE-PH • | 1826VDE-22 | |
| PH1 • PH2 | | 1862N |
| | 1841AVDE-22 | |
| 839 • | | 2154N-3 |
| 0.5x2.8 | 1841BVDE-33 | |
| | | |
| 1803VDE-33 | | |

HAZET No.		EAN-No. 4000896+
0-20/14	14	192526



0-179 Tool assortment · with protective insulation

- Safety-Insert-System, 2-component soft foam insert. Insert also suitable for HAZET Assistant
- IEC 60900:2018
- Tool assortment
- In soft foam insert Safety-Insert-System



- | | | |
|-----------------|------------------------|-----------------------|
| | 810VDE-PH • | 8801K-KV • |
| | PH1 • PH2 • PH3 | 5 • 6 |
| | | 8802KV • |
| 163-226/4 | 450KV • | T10 • T15 • T20 |
| | 163-542/18 | T25 • T27 • T30 |
| 759N-2VDE | | T40 • T45 • T50 |
| | 450KV • | 8802KV-LG • |
| 1803VDE-22 | 7 • 8 • 9 • 10 • 11 | T10 • T15 • T20 • T25 |
| | 12 • 13 • 14 • 15 • 16 | T30 • T40 • T45 • T50 |
| 1841BVDE-33 | 17 • 18 • 19 • 22 • 24 | 8808LgKV • |
| | 27 • 30 • 32 | M8 • M10 • M12 |
| 1850VDE-22 | | 8816KV • |
| | 880KV • | 8821KV • |
| 163-229/7 | 163-545/41 | 8821KV-3 • 8821KV-5 |
| | | 163-172X50 |
| 810VDE • | 880KV • | |
| 0.4x2.5 • 0.5x3 | 6 • 7 • 8 • 9 • 10 | |
| 0.6x3.5 • 0.8x4 | 11 • 12 • 13 • 14 • 16 | |
| | 17 • 18 • 19 • 20 • 22 | |

HAZET No.		EAN-No. 4000896+
0-179/70 KV	70	235575



150 Tool set · with protective insulation

• In HAZET L-Boxx – all tools ready to hand

- Produced according to current DIN specifications – optimal protection and highest level of safety thanks to constant quality control
- Recess for retrofitting with 3/8" torque wrench · with protective insulation 5109KV (5 – 25 Nm)
- Surface: with protective insulation
- IEC 60900:2018



450KV • ●
13 · 17 · 19



810VDE-PH • ●
PH1 · PH2



1802VDE-22



630KV • ●
13 · 17 · 19



880KV • ● • □ 3/8
13 · 14 · 16 · 17 · 19



1804VDE-33



810VDE • ●
0.4x2.5 · 0.8x4



8816KV • □ 3/8



1816VDE-22



8821KV-5 • □ 3/8 • □ 3/8



1850VDE-44

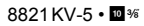

8821KV-5 • □ 3/8 • □ 3/8



2156VDE-2

HAZET No.	L x W x H mm	l mm		EAN-No. 4000896+
150/27	445x358x152	445	27	245550

150 Tool set · with protective insulation

• In HAZET L-Boxx – all tools ready to hand

- Operation of live components such as batteries, capacitors or distributors
- The use of two extensions with protective insulation enables simple and safe installation and removal of e.g. the battery
- Highest level of safety through constant quality control of the tools
- For electric lorries from e.g. **MERCEDES-BENZ · MAN · DAF · RENAULT · SCANIA · Volvo** as well as electric city buses such as e.g. **MERCEDES-BENZ · MAN · VDL · IVECO · SOLARIS · Volvo · SCANIA · BYD · SILEO · LIKKER · COBUS · MELLOR · KARSAN · IRIZAR · EBUSCO · TEMSA · EURABUS · EASYMILE · NAVJA · LOCAL MOTORS · HEULIEZ**
- Surface: with protective insulation
- IEC 60900:2018



196V-10/5



810VDE • ●
0.4x2.5 · 0.5x3
0.6x3.5 · 0.8x4



1802VDE-22



196V-20/5



810VDE-PH • ●
PH1 · PH2 · PH3



1804VDE-33



450KV • ●
13 · 17 · 19



900KV • ● • □ 1/2
13 · 14 · 15 · 16 · 17 · 19



1816VDE-22



630KV • ●
13 · 17 · 19



916KV • □ 1/2



1841BVDE-33



917/918KV • □ 1/2 • □ 1/2
917KV-5 · 918KV-10



1850VDE-44

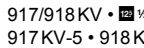

917KV-5 · 918KV-10



1860VDE-11



917KV-5 · 918KV-10



2156VDE-2

HAZET No.	L x W x H mm	l mm		EAN-No. 4000896+
150/39	445x358x152	445	39	239641



Hand tools

Tools with protective insulation / Tools for electricians



2152 Multimeter

- For trade, industry, do-it-yourselfers as well as car, commercial vehicle and agricultural workshops
- Including measuring tips for clipping into the protective cover
- Including temperature probe from -20°C to 200°C
- DC voltage: 0 - 600 V
- AC voltage: 0 - 600 V
- Direct current: 0 - 10 A
- Alternating current: 0 - 10 A
- Resistance: 0 - 60 MOhm
- Diode test
- During the continuity test, the integrated buzzer signals continuity below 50 Ohm
- Frequency: 0 - 10 MHz
- Duty cycle
- Capacitance measurement: 0 - 60 MOhm
- Automatic switch-off
- Backlight
- Data hold
- True RMS
- CAT III 600 V
- Including 2x AA batteries
- Easy operation thanks to clearly arranged control panel and large illuminated LCD display (all data quickly readable)
- Very short response times ensure rapid display of measurement results
- Optimal device alignment thanks to the stand on the housing
- Protective cover protects multimeter against damage from being dropped



HAZET No.	EAN-No. 4000896+
2152-600	246762

150 High-voltage tool set · with protective insulation

- In trolley case
- Joint development with one of the leading car manufacturers and in accordance with the German TÜV SÜD
- Surface: with protective insulation
- IEC 60900:2018



150 High-voltage tool set · with protective insulation



- 196 V-10/5
- 196 V-20/5
- 200-1
- 200-2
- 200-3
- 759N-2VDE
- 810 VDE · ⚡
0.4x2.5 · 0.5x3
0.6x3.5 · 0.8x4
- 810 VDE-PH · ⚡
PH1 · PH2 · PH3
- 810 VDE-T · ⚡
T20 · T25 · T30
- 880 KV · ⚡ · 10 3/8
- 6 · 7 · 8 · 9 · 10
11 · 12 · 13 · 14 · 16
17 · 18 · 19 · 20 · 22
- 8808 LgKV · ⚡ · 10 3/8
M8 · M10 · M12
- 8816 KV · ⚡ · 10 3/8
- 8821 KV · ⚡ · 10 3/8 · 10 1/2
- 8821 KV-3 · 8821 KV-5
- 1802 VDE-22
- 1804 VDE-33
- 1816 VDE-22
- 1841 BVDE-33
- 1850 VDE-44
- 2156 VDE-2

HAZET No.		EAN-No. 4000896+
150/52	52	247578

450 KV Single open-end wrench · with protective insulation

Made in Germany

- Slim head
- Shank with sturdy HAZET double-T-profile
- Head set at: 15°
- Surface: with protective insulation
- IEC 60900:2018

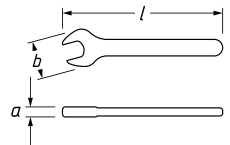

HAZET No.	l mm	a mm	b mm	EAN-No. 4000896+
450 KV- 7	88	6.2	19.3	231409
450 KV- 8	103	6.7	20.3	231416
450 KV- 9	108	6.7	22.9	231423
450 KV-10	113	7.2	25.1	231256
450 KV-11	123	7.6	27.3	231263
450 KV-12	133	7.7	29.2	231270
450 KV-13	143	8.5	31.1	231287
450 KV-14	153	8.7	32.9	231294
450 KV-15	166	10.4	35.8	231300
450 KV-16	171	10.4	37.9	231317
450 KV-17	171	10.9	39.8	231324
450 KV-18	181	11.4	41.8	231331
450 KV-19	186	11.4	43.8	231348
450 KV-22	211	11.9	50	231355
450 KV-24	238	13.3	54.3	231362
450 KV-27	258	13.6	60.2	231379
450 KV-30	278	14.6	66.7	231386
450 KV-32	298	14.6	70	231393



450 KV Open-end wrench set · with protective insulation

Made in Germany

- Surface: with protective insulation
- IEC 60900:2018

For HAZET *Assistant* with drawer depth of 398 mm:

173 · 179 · 179N · 179NX · 179W · 179NW · 179BIG-1 · 179XL · 179NXL · 179XXL · 179NXXL · 179AXXL · 179TXXL · 180

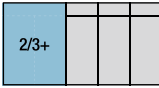

450 KV · ●

7 · 8 · 9 · 10 · 11 · 12 · 13 · 14 · 15 · 16 · 17 · 18 · 19 · 22 · 24 · 27 · 30 · 32

HAZET No.	L x W mm	□	EAN-No. 4000896+
163-542/18	392x344	18	223626

630 KV Single box-end wrench · with protective insulation

Made in Germany

- Deep offset
- Heads thin-walled
- Surface: with protective insulation
- IEC 60900:2018

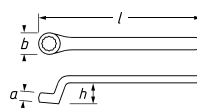

HAZET No.	l mm	h mm	a mm	b mm	EAN-No. 4000896+
630 KV- 7	152	15.5	6.4	13.6	231584
630 KV- 8	164	18	6.8	13.8	231591
630 KV- 9	164	18	7.3	15.5	231607
630 KV-10	172	20.5	7.6	17.5	231430
630 KV-11	178	20.5	8.7	19	231447
630 KV-12	193	22	8.7	20.5	231454
630 KV-13	198	22	9.3	22	231461
630 KV-14	209	23.5	10	23.5	231478
630 KV-15	214	24	11	24	231485
630 KV-16	217	26.5	11	27.5	231492
630 KV-17	223	26.5	11	27.5	231508
630 KV-18	234	28.5	11.5	30	231515
630 KV-19	234	28.5	11.5	31	231522
630 KV-22	263	30	13	35.5	231539
630 KV-24	280	31	13	38	231546
630 KV-27	295	32	14	42	231553
630 KV-30	305	33	16	46	231560
630 KV-32	312	34	16	48	231577

630 KV Box-end wrench set · with protective insulation

Made in Germany

- Surface: with protective insulation
- IEC 60900:2018

For HAZET *Assistant* with drawer depth of 398 mm:

173 · 179 · 179N · 179NX · 179W · 179NW · 179BIG-1 · 179XL · 179NXL · 179XXL · 179NXXL · 179AXXL · 179TXXL · 180



630 KV Box-end wrench set · with protective insulation

Made in Germany

- Surface: with protective insulation
- IEC 60900:2018

For HAZET *Assistant* with drawer depth of 398 mm:

173 · 179 · 179N · 179NX · 179W · 179NW · 179BIG-1 · 179XL · 179NXL · 179XXL · 179NXXL · 179AXXL · 179TXXL · 180



630 KV · ●

7 · 8 · 9 · 10 · 11 · 12 · 13 · 14 · 15 · 16 · 17 · 18 · 19 · 22 · 24 · 27 · 30 · 32

HAZET No.	L x W mm	□	EAN-No. 4000896+
163-543/18	392x344	18	223831

880 KV Socket set · with protective insulation

- Surface: with protective insulation
- IEC 60900:2018

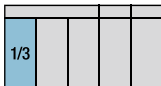
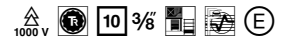

880 KV · ●

6 · 7 · 8 · 9 · 10 · 11 · 12 · 13 · 14 · 16 · 17 · 18 · 19 · 20 · 22

8816 KV · ●

8821 KV · ●

8821 KV-3 · 8821 KV-5

HAZET No.	L x W mm	□	EAN-No. 4000896+
163-580/18	342x172	18	235520

- Surface: with protective insulation
- IEC 60900:2018

For HAZET *Assistant* with drawer depth of 398 mm:

173 · 179 · 179N · 179NX · 179W · 179NW · 179BIG-1 · 179XL · 179NXL · 179XXL · 179NXXL · 179AXXL · 179TXXL · 180

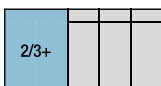

880 KV · ●

6 · 7 · 8 · 9 · 10 · 11 · 12 · 13 · 14 · 16 · 17 · 18 · 19 · 20 · 22

8802 KV · ●

T10 · T15 · T20 · T25 · T27 · T30 · T40 · T45 · T50

8808 LgKV · ●

M8 · M10 · M12

8801 K-KV · ●

5 · 6

8802 KV-LG · ●

T10 · T15 · T20 · T25 · T30 · T40 · T45 · T50

8816 KV · ●

8821 KV · ●

8821 KV-3 · 8821 KV-5

HAZET No.	L x W mm	□	EAN-No. 4000896+
163-545/41	392x344	41	223855



Hand tools

Tools with protective insulation / Tools for electricians



880 KV 3/8" Socket · hexagon

Made in Germany

- Short design
- Surface: with protective insulation
- IEC 60900:2018

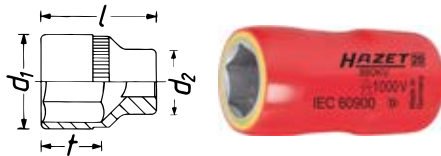

HAZET No.	l mm	d ₁ mm	d ₂ mm	t mm	EAN-No. 4000896+
880 KV- 6	40	14	23	6.5	231959
880 KV- 7	40	15	23	6.5	231966
880 KV- 8	40	16	23	6.5	231973
880 KV- 9	40	17.5	23	6.5	231980
880 KV-10	41	18.5	23	7.3	231843
880 KV-11	42	20	23	8.4	231850
880 KV-12	43	21	23	9.3	231867
880 KV-13	43.5	22.5	23	9.8	231874
880 KV-14	45.5	23.5	23	11.8	231881
880 KV-16	45.5	26	23	11.7	231898
880 KV-17	45.5	27.5	23	11.7	231904
880 KV-18	47.5	28.5	23	13.7	231911
880 KV-19	47.5	30	23	13.7	231928
880 KV-20	47.5	31	23	13.7	231935
880 KV-22	50	33.5	23	15.6	231942

8801 K-KV 3/8" Screwdriver socket

Made in Germany

- Short design
- Surface: with protective insulation
- IEC 60900:2018

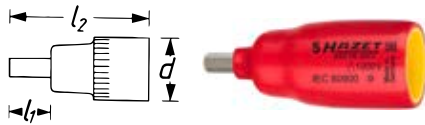

HAZET No.	l ₁ mm	l ₂ mm	d mm	EAN-No. 4000896+
8801 K-5KV	12.5	60	23	231614
8801 K-6KV	12.5	60	23	231621

8802 KV 3/8" Screwdriver socket

Made in Germany

- Short design
- Surface: with protective insulation
- IEC 60900:2018

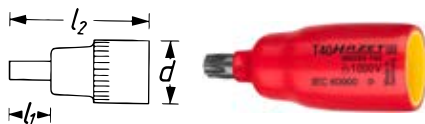
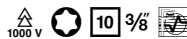

HAZET No.	s	l ₁ mm	l ₂ mm	d mm	⌀ mm	EAN-No. 4000896+
8802 KV-T 10	T10	12.5	59.5	23	2.74	231720
8802 KV-T 15	T15	12.5	59.5	23	3.27	231737
8802 KV-T 20	T20	12.5	59.5	23	3.86	231744
8802 KV-T 25	T25	12.5	59.5	23	4.43	231751
8802 KV-T 27	T27	12.5	59.5	23	4.99	231768
8802 KV-T 30	T30	12.5	59.5	23	5.52	231775
8802 KV-T 40	T40	12.5	59.5	23	6.65	231782
8802 KV-T 45	T45	12.5	59.5	23	7.82	231799
8802 KV-T 50	T50	12.5	60.5	23	8.83	231805

8802 KV-LG 3/8" Screwdriver socket

Made in Germany

- Long design
- Surface: with protective insulation
- IEC 60900:2018

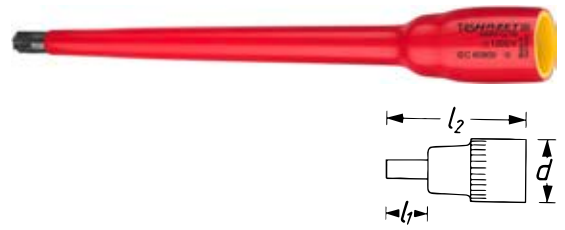
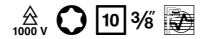

HAZET No.	s	l ₁ mm	l ₂ mm	d mm	⌀ mm	EAN-No. 4000896+
8802 KV-LG-T 10	T10	153	187	23	2.74	231638
8802 KV-LG-T 15	T15	153	187	23	3.27	231645
8802 KV-LG-T 20	T20	153	187	23	3.86	231652
8802 KV-LG-T 25	T25	153	187	23	4.43	231669
8802 KV-LG-T 27	T27	153	187	23	4.99	231676
8802 KV-LG-T 30	T30	153	187	23	5.52	231683
8802 KV-LG-T 40	T40	153	187	23	6.65	231690
8802 KV-LG-T 45	T45	153	187	23	7.82	231706
8802 KV-LG-T 50	T50	153	187	23	8.83	231713

8808 LgKV 3/8" Screwdriver socket

Made in Germany

- Long design
- Surface: with protective insulation
- IEC 60900:2018

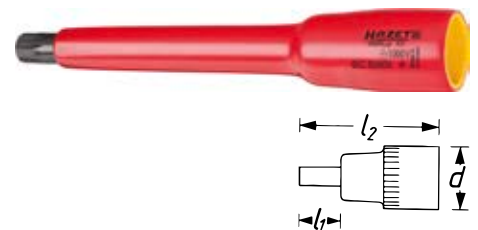
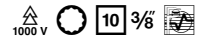

HAZET No.	s	l ₁ mm	l ₂ mm	d mm	EAN-No. 4000896+
8808 LG- 8 KV	M8	100	145.5	23	231836
8808 LG-10 KV	M10	100	144.5	23	231812
8808 LG-12 KV	M12	100	145.3	23	231829

8821 KV 3/8" → 3/8" Extension · with protective insulation

Made in Germany

- With locking ball
- Surface: with protective insulation
- IEC 60900:2018

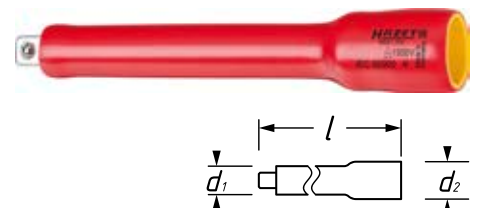
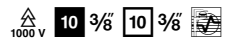

HAZET No.	l mm	d ₁ mm	d ₂ mm	EAN-No. 4000896+
8821 KV-3	90	17.5	23	231997
8821 KV-5	142	17.5	23	232000



900 KV Socket set · with protective insulation

- Surface: with protective insulation
- IEC 60900:2018

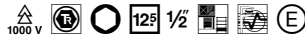

For HAZET Assistant with drawer depth of 398 mm:
 173 · 179 · 179N · 179NX · 179W · 179NW · 179BIG-1 · 179XL · 179NXL · 179XXL · 179NXXL · 179AXXL · 179TXXL · 180



2/3+			
------	--	--	--



900KV · · · · · · · · · · · · · · · · · ·



986LGKV · · · · ·



917/918KV · · · · ·



916KV ·

HAZET No.	L x W mm		EAN-No. 4000896+
163-544/26	392x344	26	223848

900 KV 1/2" Socket · hexagon · with protective insulation

Made in Germany

- Surface: with protective insulation
- IEC 60900:2018

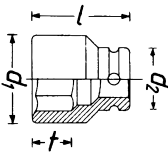
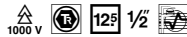

HAZET No.	l mm	d ₁ mm	d ₂ mm	t mm	EAN-No. 4000896+
900KV-10	54	19.5	27	10.8	232017
900KV-11	54	20.5	27	10.8	232024
900KV-12	54	22	27	11.3	232031
900KV-13	54	23	27	11.3	232048
900KV-14	54	24.5	27	11.8	232055
900KV-15	54	25.5	27	11.8	232062
900KV-16	54	27	27	12.2	232079
900KV-17	54	28	27	12.7	232086
900KV-18	54	29.5	27	14.2	232093
900KV-19	54	30.5	27	14.2	232109
900KV-20	54	32	27	14.2	232116
900KV-22	57.5	34.5	27	17.6	232123
900KV-23	57.5	35.5	27	17.6	232130
900KV-24	60	36.5	27	18.1	232147
900KV-26	60	39	27	17.8	232154
900KV-27	62	40	27	19.7	232161
900KV-30	66	44	27	23.3	232178
900KV-32	66	46.5	27	23	232185

900 KV 1/2" Socket · hexagon · long · with protective insulation

Made in Germany

- Surface: with protective insulation
- IEC 60900:2018

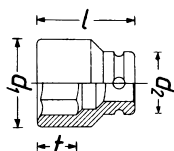
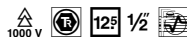

HAZET No.	l mm	d ₁ mm	d ₂ mm	t mm	EAN-No. 4000896+
900LG-10KV	101	27	18.9	16	237180
900LG-12KV	101	27	21.5	16	237173

986LGKV 1/2" Screwdriver socket · with protective insulation

Made in Germany

- Long design
- Surface: with protective insulation
- IEC 60900:2018

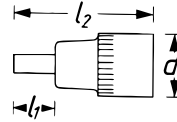
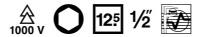

HAZET No.	l ₁ mm	l ₂ mm	d mm	EAN-No. 4000896+
986LG- 4KV	102	156	27	232222
986LG- 5KV	102	156	27	232239
986LG- 6KV	102	156	27	232246
986LG- 8KV	102	156	27	232253
986LG-10KV	102	156	27	232215

917/918KV 1/2" → 1/2" Extension · with protective insulation

Made in Germany

- With locking ball
- Surface: with protective insulation
- IEC 60900:2018

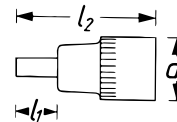
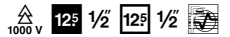

HAZET No.	l mm	EAN-No. 4000896+
917KV- 5	140	232192
918KV-10	264	232208

804VDE Screwdriver set · with protective insulation

Made in Germany

- All screwdrivers 10,000 volts individually tested, safe working guaranteed up to 1000 volts



- Round blade
- Plastic box 165-L (1/3)
- Safety-Insert-System, 2-component soft foam insert. Insert also suitable for HAZET Assistant
- Ergonomically shaped HAZET 2-component handle (red/yellow)
- Surface: with protective insulation
- IEC 60900:2018

- 2.5x0.4 · 3.0x0.5 · 3.5x0.6 · 4.0x0.8 · 5.5x1.0 · 6.5x1.2 mm
- PH1 · PH2
- PZ2
- T10 · T15 · T20

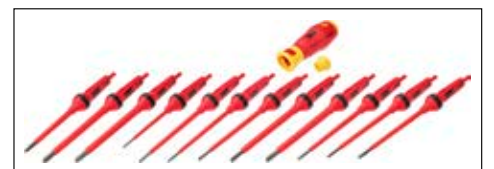

HAZET No.		EAN-No. 4000896+
804VDE/14	14	133000



Hand tools

Tools with protective insulation / Tools for electricians



810 VDE Screwdriver set · with protective insulation

- IEC 60900:2018
- Voltmeter, 220–250 V according to VDE 0680



810 VDE • 0.4x2.5 • 0.6x3.5 • 0.8x4



810 VDE-PH • PH1 • PH2

839 • 0.5x2.8

HAZET No.	□	EAN-No. 4000896+
810/6VDE	6	179329

- Safety-Insert-System, 2-component soft foam insert. Insert also suitable for HAZET Assistent
- Surface: with protective insulation
- IEC 60900:2018



1/3			
-----	--	--	--



810 VDE • 0.4x2.5 • 0.5x3 • 0.6x3.5 • 0.8x4



810 VDE-PH • PH1 • PH2 • PH3

HAZET No.	L x W mm	□	EAN-No. 4000896+
163-229/7	342x172	7	177844

- Surface: with protective insulation
- IEC 60900:2018



2/3			
-----	--	--	--

810 VDE • 0.4x2.5 • 0.5x3 • 0.6x3.5 • 0.8x4



810 VDE-PH • PH1 • PH2 • PH3

839 • 0.5x2.8



810 VDE-T • T20 • T25 • T30

2156 VDE-2

HAZET No.	L x W mm	□	EAN-No. 4000896+
163-546/12	344x342	12	223619

810 VDE Screwdriver for electricians · with protective insulation

- Round blade
- Ergonomically shaped HAZET 2-component handle (red/yellow)
- Surface: tip burnished, with protective insulation
- IEC 60900:2018



HAZET No.	l ₁ mm	l ₂ mm	⌀ mm	b mm	EAN-No. 4000896+
810 VDE-25	75	155	0.4	2.5	174089
810 VDE-30	100	180	0.5	3	174355
810 VDE-35	100	190	0.6	3.5	174362
810 VDE-40	100	190	0.8	4	174379

810 VDE-PH Screwdriver for electricians · with protective insulation

- Round blade
- Ergonomically shaped HAZET 2-component handle (red/yellow)
- Surface: tip burnished, with protective insulation
- IEC 60900:2018

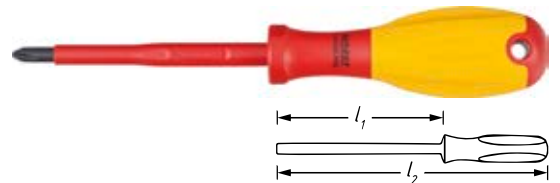

HAZET No.	l ₁ mm	l ₂ mm	EAN-No. 4000896+
810 VDE-PH 1	80	180	174386
810 VDE-PH 2	100	210	174393
810 VDE-PH 3	150	270	174409

810 VDE-T Screwdriver for electricians · with protective insulation

- Round blade
- Ergonomically shaped HAZET 2-component handle (red/yellow)
- Surface: tip burnished, with protective insulation
- IEC 60900:2018

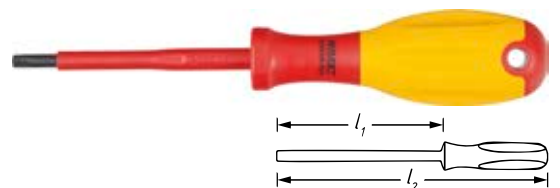

HAZET No.	l ₁ mm	l ₂ mm	⌀ mm	EAN-No. 4000896+
810 VDE-T 20	80	180	3.86	174416
810 VDE-T 25	80	180	4.43	174423
810 VDE-T 30	100	210	5.52	174430



839 Phase tester

Made in Germany

- 220–250 V
- Slotted blade, concave ground
- With clip
- Defective glow tube not replaceable according to VDE
- Round blade
- Plastic handle
- Surface: with protective insulation
- DIN VDE 06800-6

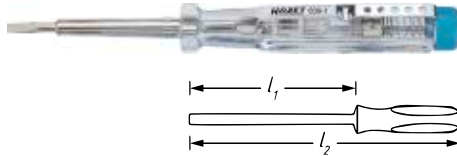

HAZET No.	l_1 mm	l_2 mm	$\frac{b}{d}$ mm	b mm	EAN-No. 4000896+
839-1	65	145	0.5	2.8	035670

163 Pliers set · with protective insulation

Made in Germany

- Safety-Insert-System, 2-component soft foam insert. Insert also suitable for HAZET Assistant
- Surface: with protective insulation
- IEC 60900:2018



1/3				
-----	--	--	--	--



HAZET No.	$L \times W$ mm		EAN-No. 4000896+
163-227/3	342x172	3	177868

Made in Germany

- Safety-Insert-System, 2-component soft foam insert. Insert also suitable for HAZET Assistant
- Surface: with protective insulation
- IEC 60900:2018



1/3				
-----	--	--	--	--



HAZET No.	$L \times W$ mm		EAN-No. 4000896+
163-226/4	342x172	4	177875

1850 VDE Combination pliers · with protective insulation

Made in Germany

- Induction-hardened cutting edges with grind
- Cutting edge hardness: 60 HRC
- Ergonomically shaped HAZET 2-component plastic handle covers (red/yellow)
- Surface: bright chrome-plated, with protective insulation
- IEC 60900:2018, DIN ISO 5746



HAZET No.	l mm	Rm N/mm ² \varnothing 800	Rm N/mm ² \varnothing 1600	EAN-No. 4000896+
1850 VDE-22	160	2.5	1.8	007202
1850 VDE-33	180	2.8	2.5	007219
1850 VDE-44	200	3	2.8	007226

1803 VDE Diagonal cutter · with protective insulation

Made in Germany

- Easy motion joint free of clearance
- Lap joint
- Induction-hardened cutting edges with grind
- Cutting edge hardness: 60 HRC
- Ergonomically shaped HAZET 2-component plastic handle covers (red/yellow)
- Surface: bright chrome-plated, with protective insulation
- IEC 60900:2018, DIN ISO 5749



HAZET No.	l mm	Rm N/mm ² \varnothing 800	Rm N/mm ² \varnothing 1600	EAN-No. 4000896+
1803 VDE-22	160	2.8	2	006137
1803 VDE-33	180	3	2.5	006144

1802 VDE Heavy-duty diagonal cutter · with protective insulation

Made in Germany

- Optimum leverage ratio due to small distance between joint and cutting edges
- Forged design
- Easy motion joint free of clearance
- Lay-on slip joint
- Induction-hardened cutting edges with grind
- Cutting edge hardness: 64 HRC
- Ergonomically shaped HAZET 2-component plastic handle covers (red/yellow)
- Surface: bright chrome-plated, with protective insulation
- IEC 60900:2018, DIN ISO 5749



HAZET No.	l mm	Rm N/mm ² \varnothing 800	Rm N/mm ² \varnothing 1600	Rm N/mm ² \varnothing 2300	EAN-No. 4000896+
1802 VDE-22	180	3.8	2.7	2.2	086382

1804 VDE Cable shears · with protective insulation

Made in Germany

- Twin cutting edge
- Cutting of copper- and aluminium cables without squeezing
- Handles with dip coating
- Surface: with protective insulation
- IEC 60900:2018

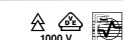

HAZET No.	l mm	EAN-No. 4000896+
1804 VDE-33	208	173631



Hand tools

Tools with protective insulation / Tools for electricians



1841 AVDE Snipe nose pliers · with protective insulation

Made in Germany

- Flat round shape, induction-hardened cutting edges
- Straight design
- Cutting edge hardness: 60 HRC
- Ergonomically shaped HAZET 2-component plastic handle covers (red/yellow)
- Surface: bright chrome-plated, with protective insulation
- IEC 60900:2018, DIN ISO 5745



HAZET No.	l mm	Rm N/mm ² ○ 800	Rm N/mm ² ● 1600	EAN-No. 4000896+
1841 A VDE-22	160	2.5	1.6	006397

1841 BVDE Snipe nose pliers · with protective insulation

Made in Germany

- Flat round shape, induction-hardened cutting edges
- Curved design (45°)
- Cutting edge hardness: 60 HRC
- Ergonomically shaped HAZET 2-component plastic handle covers (red/yellow)
- Surface: bright chrome-plated, with protective insulation
- IEC 60900:2018, DIN ISO 5745



HAZET No.	l mm	Rm N/mm ² ○ 800	Rm N/mm ² ● 1600	EAN-No. 4000896+
1841 B VDE-33	200	2.8	1.8	006441

1816 VDE Flat nose pliers · with protective insulation

Made in Germany

- Long jaws
- Flat form
- Straight design
- Ergonomically shaped HAZET 2-component plastic handle covers (red/yellow)
- Surface: bright chrome-plated, with protective insulation
- IEC 60900:2018, DIN ISO 5745



HAZET No.	l mm	EAN-No. 4000896+
1816 VDE-22	160	006298

1826 VDE Round-nose pliers · with protective insulation

Made in Germany

- Long jaws
- Round shape
- Ergonomically shaped HAZET 2-component plastic handle covers (red/yellow)
- Surface: bright chrome-plated, with protective insulation
- IEC 60900:2018, DIN ISO 5745



HAZET No.	l mm	EAN-No. 4000896+
1826 VDE-22	160	006328

759 N-VDE Universal pliers · with protective insulation

Made in Germany

- Universal pliers
- Jaw and hinge polished
- Box joint
- Ergonomically shaped HAZET 2-component plastic handle covers (red/yellow)
- Surface: with protective insulation
- IEC 60900:2018, DIN ISO 8976



HAZET No.	l mm	sb mm	sb mm	EAN-No. 4000896+
759 N-2VDE	251	30	10-36	174072

1860 VDE Wire stripper · with protective insulation

Made in Germany

- For wire with a cross-section up to 6 mm²
- With adjusting screw and opening spring
- Ergonomically shaped HAZET 2-component plastic handle covers (red/yellow)
- Surface: bright chrome-plated, with protective insulation
- IEC 60900:2018



HAZET No.	l mm	EAN-No. 4000896+
1860 VDE-11	160	007288

1862 Wire stripper · automatic

Made in Germany

- Automatic scanning system, no adjustment to the cable cross-section necessary



- Application: Stripping of flexible cables (stranded wire) and solid conductors \varnothing 0.2 to 6.0 mm² or AWG 24 – 10
- Optimally positioned diagonal cutter up to 2.5 mm²
- Adjustable length stop 6 – 15 mm
- Fastening element at end of handle
- Replaceable blades

Not for work on or near electrically live parts

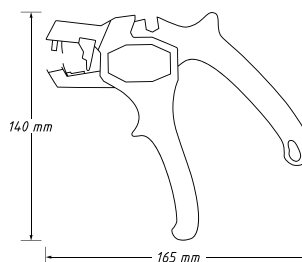

HAZET No.	l mm	EAN-No. 4000896+
1862 N	180	242627



1863 Wire stripper · automatic

- Automatic adjustment to insulation thickness, easy application – perfect result



- Application: Wire stripping of electrical conductors, stranded wires and cables
- For copper and aluminium conductors
- Stripping range PVC-insulated conductors, cross-section 0.2 up to 6 mm²
- Maximum stripping length: 18 mm
- Spring-loaded knife-type blades
- Wire cutter for 4 mm² single-wired and 6 mm² fine-wired



HAZET No.	l mm	EAN-No. 4000896+
1863	205	007325

4656 Crimping pliers

Made in Germany



- Creation of conductor crimp and insulation crimp in one working step

- Intensive insulation crimp with special profile geometry
- Integrated lock with releasing mechanism provides complete crimp
- All stressed parts are specially tempered
- Easy handling
- Profile coding
- Profiles / cross-sectional areas:
red: 0.5–1.0 mm² / AWG 20–16
blue: 1.5–2.5 mm² / AWG 16–14
yellow: 4.0–6.0 mm² / AWG 12–10
- Ergonomic soft grip handles with anti-slip covers
- Surface: burnished, oiled



HAZET No.	l mm	EAN-No. 4000896+
4656-1	220	127351

4658 Crimping pliers

Made in Germany



- For a multitude of non-insulated cable and plug-type connectors
- Integrated lock with release mechanism ensures complete crimping process
- **Less expenditure of force due to an optimal force transmission ratio**
- **Linear crimping** providing consistent rolling of conductor and insulator crimp
- The **insulation stop** allows the positioning of the contact in the crimping profile independent of the type of contact used
- **Change head** for cross sections 0.35–1.5 mm² complete, including basic tool
- 1st profile: 0.35–0.5 mm²
2nd profile: 1.5 mm²
3rd profile: 0.5 – 1.0 mm²
conductor crimp = B-crimp / insulation crimp = O-crimp



HAZET No.	l mm	EAN-No. 4000896+
4658-10	150	129515

2156 Cable knife

- Blade made of stainless steel
- Plastic handle



HAZET No.	l mm	EAN-No. 4000896+
2156	110	013180

2156 VDE Cable stripping knife · with protective insulation

Made in Germany



- With protection cap
- Blade made of stainless steel
- Plastic handle
- IEC 60900:2018



HAZET No.	l mm	EAN-No. 4000896+
2156 VDE-2	180	173549

2158 Universal shears

- Ergonomic design allows one-hand operation of the locking device



- Blades: rust-resistant stainless steel
- Locking device
- Additionally with round cutter for wire stripping (1 or 1.5 mm²)
- Wire guide for cutting lashing wire up to 2.5 mm Ø
- HAZET 2-component handle



HAZET No.	l mm	EAN-No. 4000896+
2158	194	057856

196 VDE Insulating mat

Made in Germany



- For working on high-current parts

- Rubber mat, tested: 50,000 V, according to VDE 0303
- One side smooth and one side anti-slipping, grooved
- Dimensions: 1000 x 1000 x 4.0 mm

Carrier bag design

- Carrying strap removable
- Length: 1000 mm
- Diameter: 160 mm
- Polyester, red



HAZET No.	l mm	EAN-No. 4000896+
196 VDE-8/2	2	174836



Hand tools

Tools with protective insulation / Tools for electricians



5000 KV Torque wrench · with protective insulation · SYSTEM 5000KV (with sliding square) · ± 4% accuracy · 5108KV · ±6% · 2–120 Nm

Made in Germany

- Can be calibrated
- Long service life / high accuracy

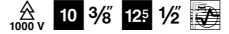

- Option of:
 - Removal
 - Repair (if necessary)
 - Installation
 - Adjustment
 - Calibration
- **Note: adjustment, possible repairs with removal/installation of the KV torque wrench only in the HAZET Service Center**
- Suitable for control of inspection and test equipment
- Sustainable and environmentally sound
- Safety:
 - Haptic (close-gap release)
 - Audible („click“ sound)
- **Right/left release** by plug-in square, thereby tightening at torque setting, both to the right and to the left within the specified tolerance
- Low weight for good handling and fatigue-free work

Product design features

- Slim design in strict accordance with the required insulating properties (material strength/overlaps)
- Smooth transitions on switching and moving parts with ergonomic handle design and calibration notch
- Uniform look even when using other components (e.g. red insulated sockets)
- Attractive colour design of the housing and head with signal colours red/yellow
- Handle colour in black to make a distinction with the colour and to prevent it appearing dirty quickly
- No disturbing projecting parts (e.g. shift lever)

ATTENTION:
Repairs may only be carried out by the HAZET Service Center, as repair works must be followed by a 10,000 V routine test in accordance with IEC 60900

• DIN EN ISO 6789-2:2017, DIN 3120, ISO 1174-1, IEC 60900:2018

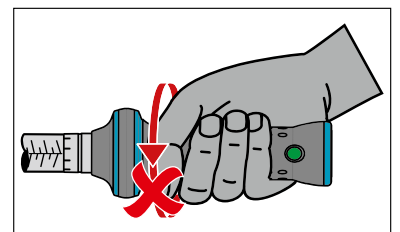

HAZET No.	Output	l mm	Release accuracy tolerance %	Nm	Nm	kg	EAN-No. 4000896+
5108 KV	■ 10 = 3/8"	275	6	2–10	0.2	1.0–5.0	235421
5109 KV	■ 10 = 3/8"	305	4	5–25	0.5	2.1–11.0	235445
5121 KV	■ 12.5 = 1/2"	420	4	20–120	1	6.0–37.4	233397





Torque technology



5000-3 CT	With reversible ratchet	$\pm 3\%$ / 4%	1–800 Nm		308
5000 B-3 CT	Torque wrench for bits	$\pm 3\%$ / 4%	1–25 Nm		310
5200 CT	With insert square	$\pm 3\%$	2.5–200 Nm		310
5000 CLT	With display and reversible ratchet	$\pm 4\%$	20–320 Nm		311
5000 KV	With protective insulation, tested to 1000 V	$\pm 4\%$ / 6%	2 – 120 Nm		283
6000 CT	With reversible ratchet	$\pm 2\%$ / 4%	1–800 Nm		311
6000 CT	Can be disassembled, with reversible ratchet	$\pm 3\%$ / 4%	400–2000 Nm		313
6000 CT	US Standard, with reversible ratchet	$\pm 3\%$	5–600 lbf.ft		314
6200 CT	With insert square	$\pm 2\%$ / 4%	2–500 Nm		315
6000 CT	Torque tool sets				318
7000 sTAC	Electronic, with insert square and reversible ratchet	from $\pm 1\%$ / ± 1 digit / $\pm 1^\circ$	1–1000 Nm		327
6000	Torque screwdriver for bits	$\pm 6\%$ – 15%	0,4–5,4 Nm		322
6000	Torque screwdriver for bits	$\pm 5\%$	0,1–6 Nm		322
6300 CT	With insert square and adjustable fixed value	$\pm 2\%$ / 6%	1–320 Nm		323
	Insert tools				325
	Torque testers and accessories				328



Product overview of HAZET torque wrenches

	HAZET No.	Release accuracy		Measuring range
	5107-3CT	± 4 %	6.3 1/4"	1–9 Nm
	5108-3CT	± 3 %	6.3 1/4"	2.5–25 Nm
	5110-3CT	± 3 %	10 3/8"	10–60 Nm
	5120-3CT	± 3 %	12 ⁵ 1/2"	10–60 Nm
	5111-3CT	± 3 %	10 3/8"	20–120 Nm
	5121-3CT	± 3 %	12 ⁵ 1/2"	20–120 Nm
	5122-3CT	± 3 %	12 ⁵ 1/2"	40–200 Nm
	5123-3CT	± 3 %	12 ⁵ 1/2"	60–320 Nm
	5143-3CT	± 3 %	12 ⁵ 1/2"	100–400 Nm
	5145-3CT	± 3 %	20 3/4"	300–800 Nm
	5107 B-3CT	± 4 %	6.3 1/4"	1–9 Nm
	5108 B-3CT	± 3 %	6.3 1/4"	2.5–25 Nm
	5280-3CT	± 3 %	9 x 12	2,5–25 Nm
	5290-3CT	± 3 %	9 x 12	10–60 Nm
	5292-3CT	± 3 %	14 x 18	40–200 Nm
	5121-2 CLT	± 4 %	12 ⁵ 1/2"	20–120 Nm
	5122-2 CLT	± 4 %	12 ⁵ 1/2"	40–200 Nm
	5123-2 CLT	± 4 %	12 ⁵ 1/2"	60–320 Nm
	5108 KV	± 6 %	10 3/8"	2–10 Nm
	5109 KV	± 4 %	10 3/8"	5–25 Nm
	5121 KV	± 4 %	12 ⁵ 1/2"	20–120 Nm
	6106-1 CT	± 4 %	6.3 1/4"	1–6 Nm
	6108-1 CT	± 2 %	6.3 1/4"	2–10 Nm
	6109-2 CT	± 2 %	6.3 1/4"	4–40 Nm
	6110-1 CT	± 2 %	10 3/8"	5–60 Nm
	6111-1 CT	± 2 %	10 3/8"	20–120 Nm
	6121-1 CT	± 2 %	12 ⁵ 1/2"	20–120 Nm
	6122-1 CT	± 2 %	12 ⁵ 1/2"	40–200 Nm
	6123-1 CT	± 2 %	12 ⁵ 1/2"	60–320 Nm
	6143-1 CT	± 2 %	20 3/4"	100–400 Nm
	6144-1 CT	± 2 %	20 3/4"	200–500 Nm
	6145-1 CT	± 2 %	20 3/4"	300–800 Nm
	6150-1 CT	± 3 %	20 3/4"	400–1000 Nm
	6160-1 CT	± 3 %	25 1"	600–1600 Nm
	6170-1 CT	± 4 %	25 1"	800–2000 Nm
	6114-1 CT	± 3 %	10 3/8"	5–40 lbf.ft
	6115-1 CT	± 3 %	10 3/8"	20–100 lbf.ft
	6127-1 CT	± 3 %	12 ⁵ 1/2"	40–200 lbf.ft
	6128-1 CT	± 3 %	12 ⁵ 1/2"	50–250 lbf.ft
	6132-1 CT	± 3 %	20 3/4"	120–600 lbf.ft



	HAZET No.	Release accuracy		Measuring range
	6280-1 CT	± 2 %	9 x 12	2–10 Nm
	6282-1 CT	± 2 %	9 x 12	4–40 Nm
	6281-2 CT	± 4 %	9 x 12	5–13 Nm
	6290-1 CT*	± 2 %	9 x 12	5–60 Nm
	6291-2 CT	± 2 %	9 x 12	20–120 Nm
	6291-1 CT	± 2 %	14 x 18	20–120 Nm
	6292-1 CT	± 2 %	14 x 18	40–200 Nm
	6293-1 CT	± 2 %	14 x 18	60–320 Nm
	6294-1 CT	± 2 %	14 x 18	100–400 Nm
	6295-1 CT	± 2 %	14 x 18	200–500 Nm
	7280-2 sTAC	± 2 % / 1 digit	9 x 12 6.3 1/4"	1–10 Nm
	7281-2 sTAC	± 2 % / 1 digit	9 x 12 6.3 1/4"	2.5–25 Nm
	7290-2 sTAC	± 1 % / 1 digit	9 x 12 10 3/8"	5–60 Nm
	7291-2 sTAC	± 1 % / 1 digit	9 x 12 10 3/8"	10–100 Nm
	7292-2 sTAC	± 1 % / 1 digit	14 x 18 12.5 1/2"	20–200 Nm
	7294-2 sTAC	± 1 % / 1 digit	14 x 18 20 3/4"	40–400 Nm
	7295-2 sTAC	± 1 % / 1 digit	14 x 18 20 3/4"	65–650 Nm
	7250-2 sTAC	± 1 % / 1 digit	20 3/4"	200–1000 Nm
	7280-5 sTAC	± 2 % / 1 digit	9 x 12 6.3 1/4"	1–10 Nm
	7281-5 sTAC	± 2 % / 1 digit	9 x 12 6.3 1/4"	2.5–25 Nm
	7290-5 sTAC	± 1 % / 1 digit	9 x 12 10 3/8"	5–60 Nm
	7291-5 sTAC	± 1 % / 1 digit	9 x 12 10 3/8"	10–100 Nm
	7292-5 sTAC	± 1 % / 1 digit	14 x 18 12.5 1/2"	20–200 Nm
	7294-5 sTAC	± 1 % / 1 digit	14 x 18 20 3/4"	40–400 Nm
	7295-5 sTAC	± 1 % / 1 digit	14 x 18 20 3/4"	65–650 Nm
	7250-5 sTAC	± 1 % / 1 digit	20 3/4"	200–1000 Nm
		6001-1.4/3	± 15 %	6.3 1/4"
6001-1.5/3		± 10 %	6.3 1/4"	0.6–1.5 Nm
6001-3.0/3		± 6 %	6.3 1/4"	1.5–3 Nm
6001-5.4/3		± 6 %	6.3 1/4"	3–5.4 Nm
	6002 CT	± 5 %	6.3 1/4"	10–120 cNm
	6003 CT	± 5 %	6.3 1/4"	100–600 cNm
	6391-10	± 6 %	9 x 12	1–10 Nm
	6391-12 (V)	± 2 %	9 x 12	2–12 Nm
	6391-25 (V)	± 2 %	9 x 12	2–25 Nm
	6391-35 (V)	± 2 %	9 x 12	15–35 Nm
	6391-50 (V)	± 2 %	9 x 12	5–50 Nm
	6391-85 (V)	± 2 %	9 x 12	15–85 Nm
	6392-200 (V)	± 2 %	14 x 18	50–200 Nm
	6392-320 (V)	± 2 %	14 x 18	60–320 Nm



Pictogram key

<i>b</i>	Width in mm
<i>a</i>	Height in mm
<i>l</i>	Length in mm
<i>s</i>	Wrench size in mm or inches
	TORX ® Size in mm
	Actuating force in kg
	For inside hexagon screws
	For outside hexagon screws
	For inside TORX ® screws

	TRACTION PROFILE 6-point
	TRACTION PROFILE 12-point
	Nominal size 6.3
	Nominal size 10
	Nominal size 12.5
	Nominal size 20
	Nominal size 25
	Inside square
	Outside square

	Inside hexagon
	Outside hexagon
	Insert socket 9 x 12 mm for torque wrenches
	Insert socket 14 x 18 mm for torque wrenches
	Number of teeth
	Rotation angle
	Scale graduation

The HAZET Service Centre



Direct contact and coordination point for services for all of our products

Phone +49(0)2191/792-355
FAX +49(0)2191/792-523
e-mail service-center@hazet.de

- In our specially equipped Service Centre, you can receive the best aftersales service with short response times and the complete HAZET competence.
- In essence, the HAZET Service Centre provides you with the following services:
 - Repair, adjustment, calibration and certification of HAZET torque wrenches
 - All service tasks on HAZET torque wrenches, pneumatic tools, tool trolleys and the rest of the catalogue programme
 - Short response times
 - Contact partner in service matters

HAZET-WERK
 Service-Center
 Guldenerthor Bahnhofsstraße 25 - 29
 42857 Remscheid

1. PDF-Formular vollständig ausfüllen und anschließend ausdrucken
 2. Ausgefülltes Formular für einen Brief einlegen
 3. Brief sorgfältig verpacken, um Transportschäden zu vermeiden
 4. Paket zureichend frankieren an HAZET-WERK • Remscheid verschicken

Frage: Nr. 02191 792-355 • Fax 02191 792-523 • e-mail service-center@hazet.de

Nr. 10000 HAZET-Produktbeschreibung (siehe www.hazet.de)

HAZET-WERK
 Service-Center
 Guldenerthor Bahnhofsstraße 25 - 29
 42857 Remscheid

Lieferadresse Nr.:
 Name:
 Rechnungsempfänger:
 Warenrücksendung an:

Sehr geehrte Damen und Herren,
 anbei erhalten Sie folgende Werkzeuge zur Reklamation:
 Anzahl Artikel-Nr. Seriennummer(n) Reklamationsgrund

Durch HAZET Service-Center auszufüllen
 Eingangsdatum:
 Meldungsnummer

42857 Remscheid, Industriestraße und Priesterweg
 © Die Gesamtwerkzeuge herstellergesamt. Ein der Produkte übernommen. Gesamtwerk, Pneumatische Werkzeuge, Handwerkzeuge, HAZET und Einbauelemente





HAZET – Competence for calibration of torque and rotation angles

Accredited according to DIN EN ISO/IEC 17025 for measured values:

- Torque (DIN EN ISO 6789-2:2017)
- Rotation angle (VDI/VDE 2648 page 2; without item 4.2)

Complies with special demands of ISO/TS 16949 for calibration laboratories

(mandatory requirement for all suppliers of the automotive industry)

HAZET-owned calibration laboratory guarantees optimal technical calibration competence by accreditation

Authorised to issue calibration certificates

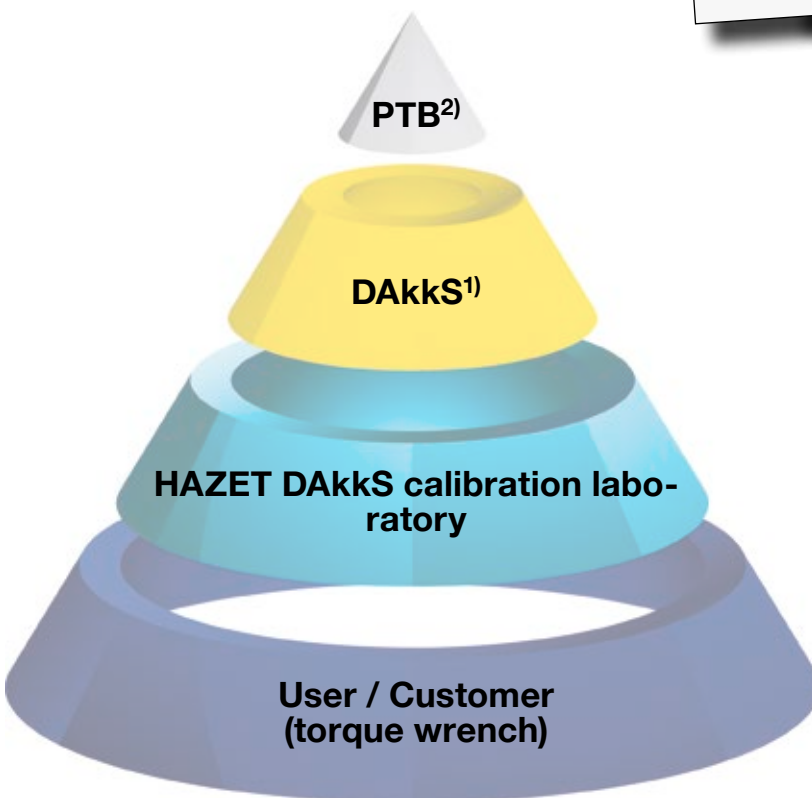
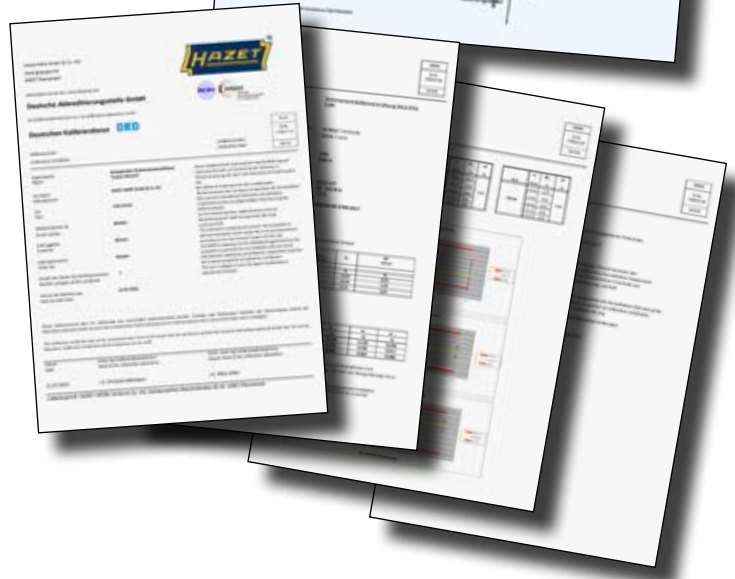

Deutsche Akkreditierungsstelle
D-K-17638-01-00

¹⁾ DAkkS: Deutsche Akkreditierungsstelle GmbH (national accreditation body of the Federal Republic of Germany, Berlin)

²⁾ PTB: Physikalisch Technische Bundesanstalt (PTB is the national metrology institute providing scientific and technical services)



DAkkS calibration laboratory

Competence for calibration of torque and rotation angles

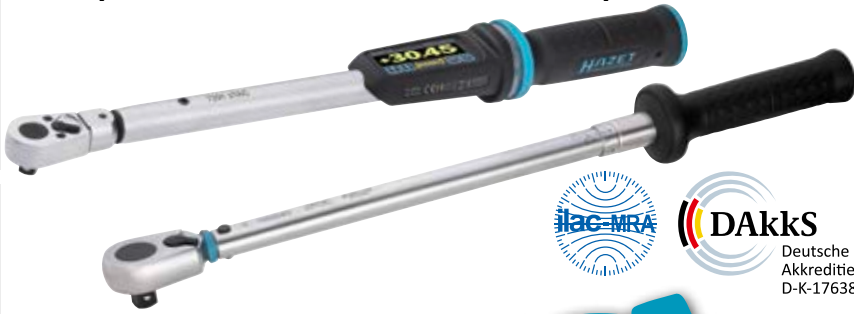

Deutsche
Akkreditierungsstelle
D-K-17638-01-00



Do you know?



- Accredited according to DIN EN ISO/IEC 17025 for measured values:
 - **Torque** (DIN EN ISO 6789-2:2017)
 - **Rotation angle** (VDI/VDE 2648 page 2; without item 4.2)
- Complies with special demands of ISO/TS 16949 for calibration laboratories (mandatory requirement for all suppliers of the automotive industry)
- HAZET-owned calibration laboratory guarantees optimal technical calibration competence by accreditation
- Authorised to issue calibration certificates



Wrenches with DAkkS calibration certificate

5107-3CTCAL	5145-3CTCAL	6108-1CTCAL	6145-1CTCAL	6292-1CTCAL	7294-2eTACCAL
5108-3CTCAL	5280-3CTCAL	6109-2CTCAL	6150-1CTCAL	6293-1CTCAL	7281-2sTACCAL
5110-3CTCAL	5290-3CTCAL	6110-1CTCAL	6160-1CTCAL	6294-1CTCAL	7290-2sTACCAL
5111-3CTCAL	5292-3CTCAL	6111-1CTCAL	6280-1CTCAL	6295-1CTCAL	7291-2sTACCAL
5120-3CTCAL		6121-1CTCAL	6282-1CTCAL	7291-1eTACCAL	7292-2sTACCAL
5121-3CTCAL	5121-2CLTCAL	6122-1CTCAL	6281-2CTCAL	7292-1eTACCAL	7294-2sTACCAL
5122-3CTCAL	5122-2CLTCAL	6123-1CTCAL	6290-1CTCAL	7294-1eTACCAL	7295-2sTACCAL
5123-3CTCAL	5123-2CLTCAL	6143-1CTCAL	6291-2CTCAL	7291-2eTACCAL	7250-2sTACCAL
5143-3CTCAL	6106-1CTCAL	6144-1CTCAL	6291-1CTCAL	7292-2eTACCAL	

- DAkkS calibration for existing wrenches now possible



...with the highest safety for the professional user, especially for:

- Aviation industry
- Automobile industry
- New-energy, wind turbines, offshore wind farms
- Petrochemical industry (oil/gas)

Documented traceability guarantees complete verifiability!



Increased screw connection quality through improvement in the screw tightening

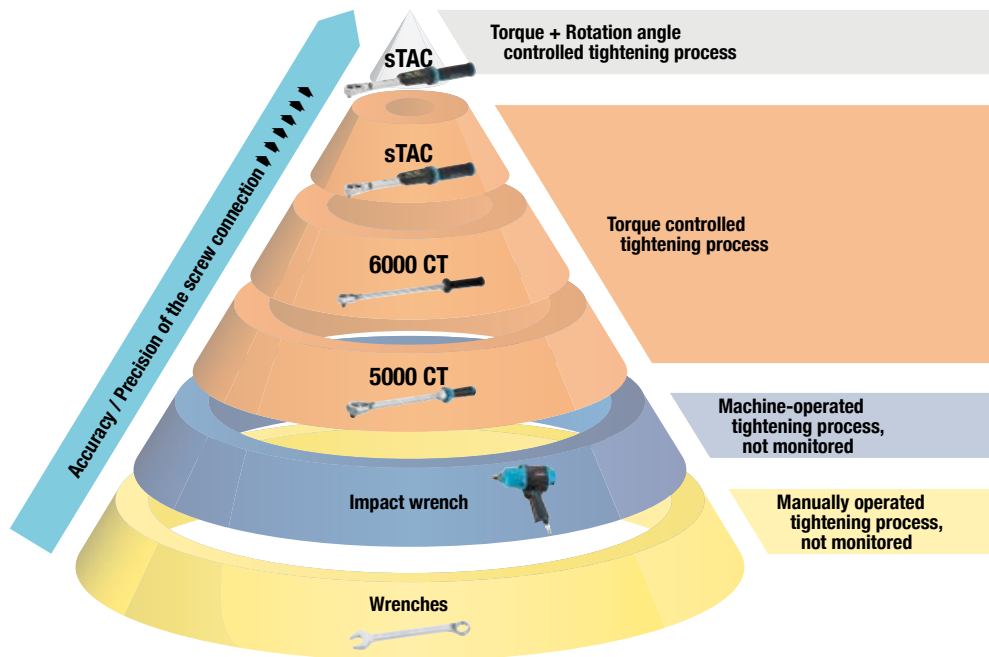

The complete screw connection is only OK (Fig. ③) if the torque and rotation angle are both OK

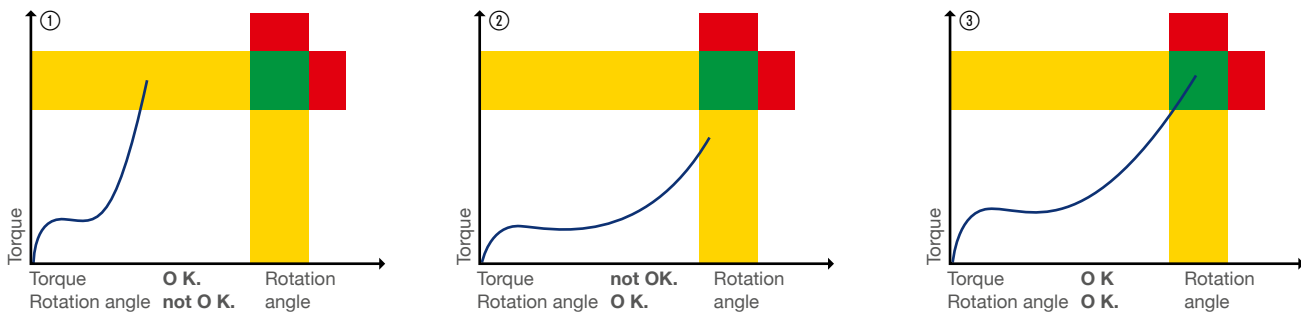

Important: In particular for the joints using threaded fasteners of the category A (according to VDI guideline 2862), e.g. belt, airbag or rotor blades for wind energy plants!

Figure 1:
The torque is reached, but the rotation angle isn't. – Possible causes:

- Use of an incorrect screw that is too long.
- The component to be screwed is too thin, screw or nut is stuck in the end of the thread.
- The head and / or thread friction are too high because the surfaces are too rough and the screw has possibly „jammed“, for example. The coating of the screw is not correct because a screw with a different coating was used or the coating is incomplete. There is not sufficient lubrication or an incorrect lubricant has been used.
- Screw or thread is damaged.
- Thread is incorrectly cut and not deep enough.
- There are chips from the thread cutting in the blind hole.
- A washer or a seal has been forgotten and the screw is in place.

Figure 2:
The rotation angle is reached, but the torque isn't. – Possible causes:

- Use of an incorrect screw that is too short and the thread has been ripped out.
- Use of an incorrect screw with insufficient strength.
- The head and / or thread friction are too low because the screw coating is incorrect. • Use of an incorrect screw.
- Use of an incorrect lubricant.
- The screw or the thread is damaged or the thread has been ripped out.
- Installation of an incorrect seal that is too soft.



STAC

SYSTEM 7000 sTAC

Electronic torque wrench with built-in angle gauge for highly precise screwing applications with Smart technology – Ready for Industry 4.0



Made in Germany

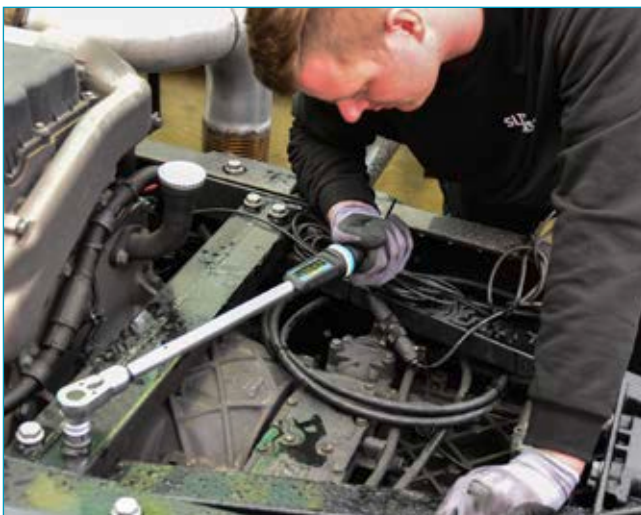



- Torque**
- + Rotation angle**
- = One work step!**

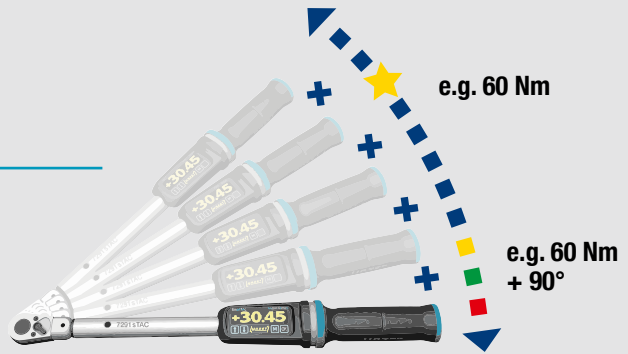

4 times signaling for optimal screwing progress monitoring

Type of signal

2 x Visual
synchronous numerical display
+ 360° LED display



+ Audible

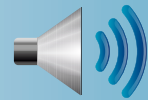
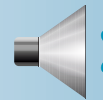
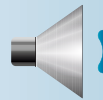

+ Vibration

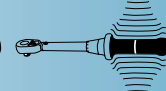
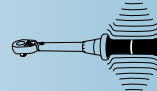
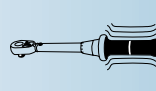

= 4 times proven screwing reliability according to the principle of HAZET!

- Threshold value (pre-warning level)

✓ OK

✗ not OK

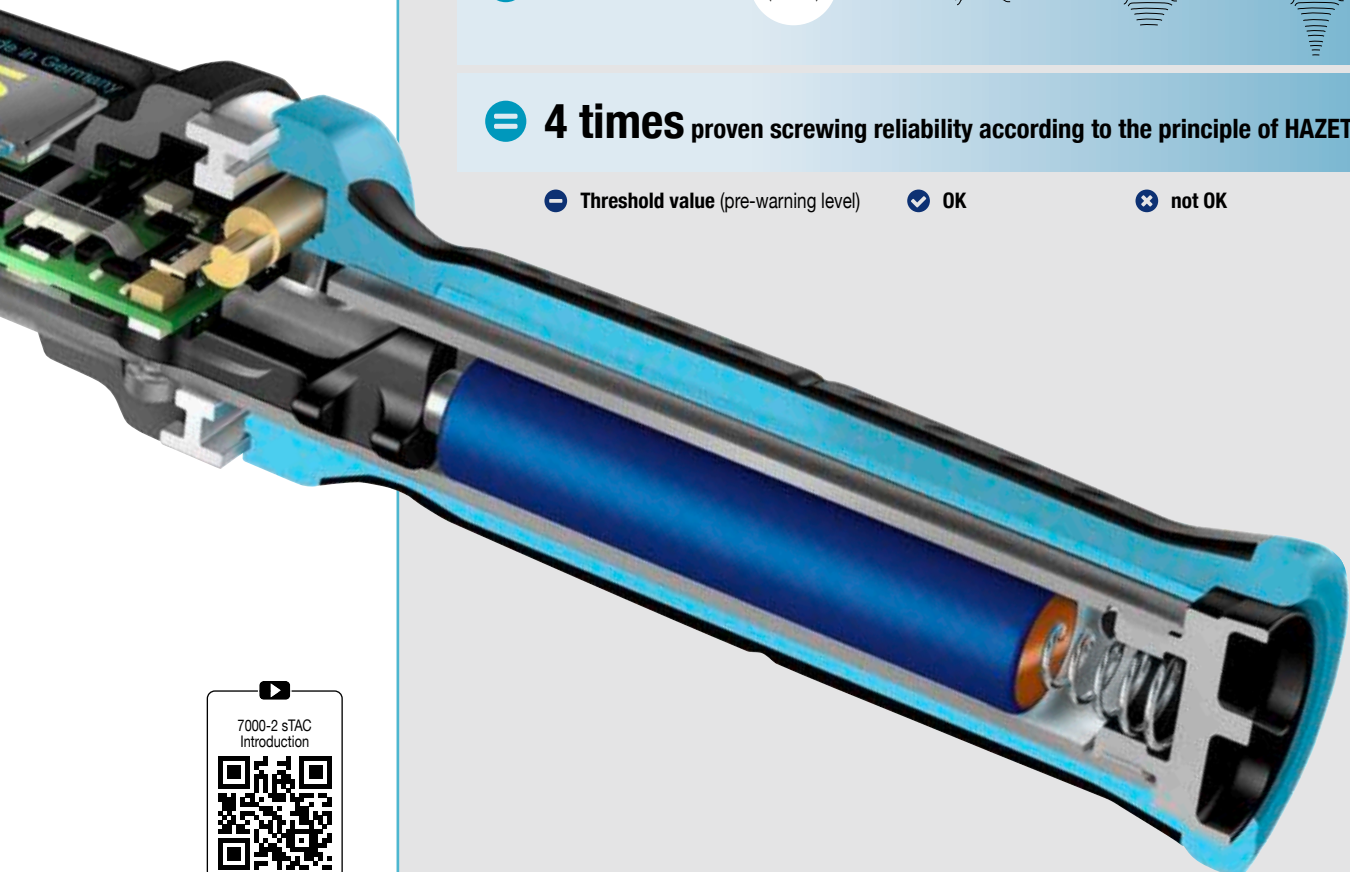



SmartTAC SYSTEM 7000 sTAC

Electronic torque wrench with built-in angle gauge for highly precise screwing applications with Smart technology – Ready for Industry 4.0

HAZET Smart Technology consisting of SmartTAC app and Bluetooth 4.1 Low Energy Interface (product group 7000-2 sTAC – may be subject to national admission restrictions). Easy live data exchange for displaying the bolting process on mobile devices, such as smartphones (Smartwatch) and tablet PCs. USB-C interface for programming torque wrenches with built-in angle gauge and documenting the screwing data via laptop and PC with SmartTAC tool 7910-sTAC.

All sTAC torque wrenches with built-in angle gauges can also be used autonomously, without SmartTAC app.

SmartTAC Apps available for:

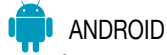



Strong features

- For high-precision screw connections with torque/ rotation angle calling for high accuracy or mandatory documentation, e.g. engine components especially cylinder head bolts, machine construction with increased requirements (including robot technology etc.)
- **Unique ergonomic, user-oriented HAZET design of entire tool for professional use**
- **Protection rating IP 40**, splash-proof display and membrane keyboard
- Tested in accordance with DIN EN ISO 6789-2:2017
- **USB-C interface** for programming torque wrenches with built-in angle gauge and for documenting the screwing data via laptop and PC with SmartTAC tool 7910-sTAC
- Including standard **replaceable Li ion rechargeable battery**, type 14650 / 3.7 Volt, can be charged directly on the tool via USB-C connector
- Including 1 metre USB 3.1 / A-C cable



Ergonomic
HAZET design



IP 40

Splash
-proof



8 sizes for torque ranges of 1 – 1,000 Nm



Made in Germany



Torque wrenches SYSTEM 6000 CT

High-precision premium torque tools – For the highest demands!

- Torque ranges: 1 – 2000 Nm
- Accuracy $\pm 2\%$ of the scale value (in direction of actuation) according to DIN EN ISO 6789-2:2017 (3%: 6150-1 CT · 6160-1 CT / 4%: 6106-1 CT · 6170-1 CT)
- Accuracy $\pm 3\%$ of the scale value according to US standards: 6114-1 CT up to 6132-1 CT
- Tested, with calibration certificate and serial number
- Knob for additionally locking the set value
- Square according to DIN 3120, ISO 1174-1
- Reversible ratchets **6.3** ¼ **10** ⅜ **12.5** ½ **25** 1"
- Ergonomically shaped
- Safety:
 - Haptic (close-gap release)
 - Audible („click“ sound)



User-friendly **HiPer fine-tooth reversible ratchet***

Service friendly (do-it-yourself repair sets for ratchets available)

Optimised blue sealing ring to protect against debris. Improved durability and UV resistance. Service-friendly cover plate on the underside



No risk of losing the square like there is with the wrench



– Safe in safe box with display window! –



Also available with **DAkkS calibration certificate**
...with the highest safety for the professional user, especially for:

- Aviation industry
- Automobile industry
- New-energy, wind turbines, offshore wind farms
- Petrochemical industry (oil/gas)

Documented traceability guarantees complete verifiability!



Quality through and through

Cutaway view of a HAZET torque wrench 6000 CT

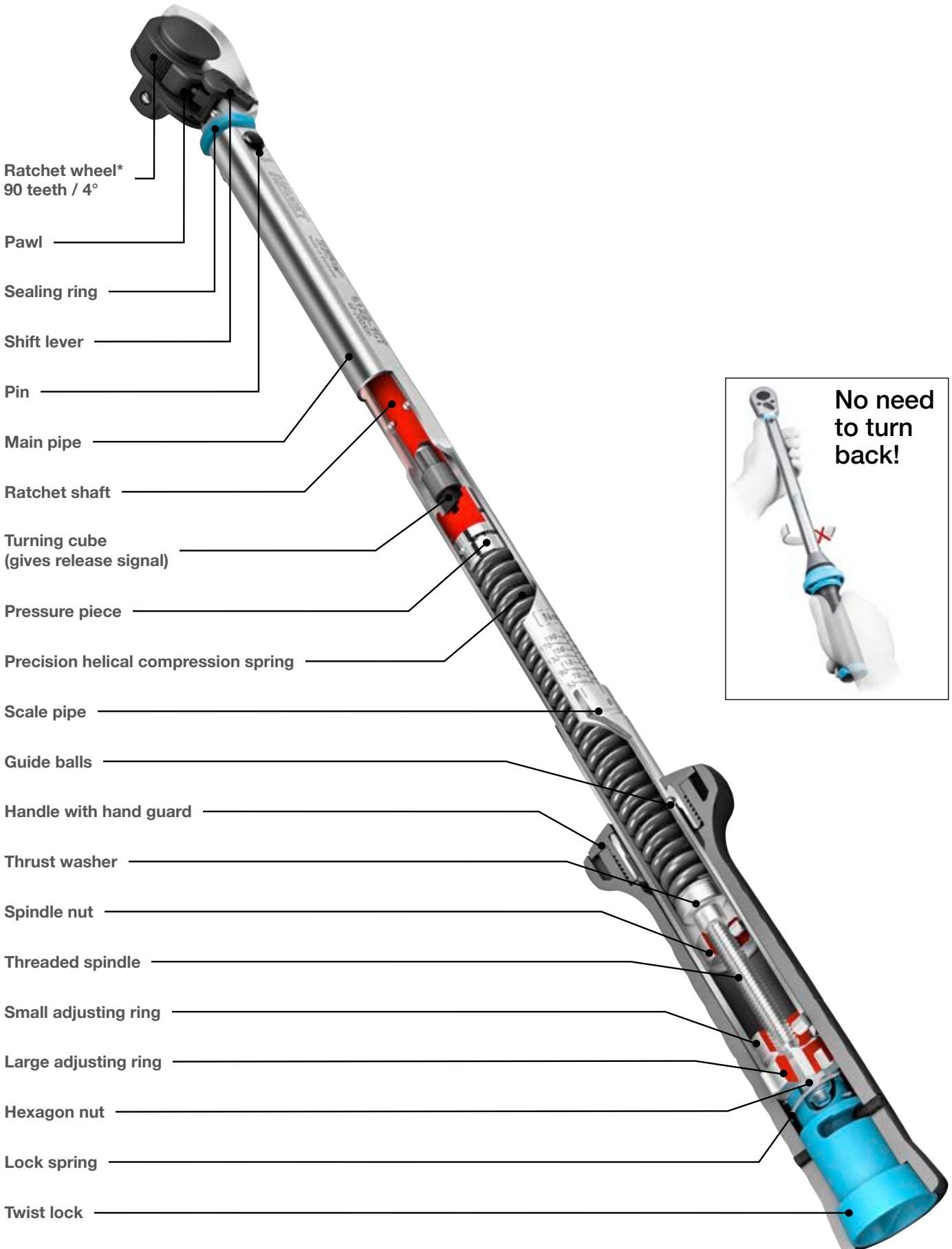



Torque wrenches SYSTEM 5000-3 CT

Our workshop classics – well equipped for the future.

The third generation 5000-3 CT series

- Expanded measuring range of the series through increased market requirements **1 – 800 Nm**
- 15 versions with reversible ratchet: **6.3 1/4" 10 3/8" 12.5 1/2" 20 3/4"** as well as for screwdriver bits **6.3 1/4"**
- **Accuracy ± 3%** of the scale value (in direction of actuation)
(5107-3 CT ± 4% release accuracy tolerance)
- Designed for rough workshop use
- Wider range of applications for controlled screw tightening in tyre service, bicycle, passenger car and commercial vehicle applications as well as various applications in trade and industry.
- Optimised sealing ring to protect optimally against debris
- Tested in accordance with DIN EN ISO 6789-2:2017
- Ratchet repair set for customer-oriented self-assembly enables decades of use
- Adjustment aid with detent points for optimised operator guidance ensures safe and fast adjustment of the desired torque value by turning the handle
- Can be attached to the cable loop through openings on the locking rotary assembly
- Integrated shift lever
- With calibration certificate and serial number
- Delivery in sturdy Hexa plastic box
- HAZET's own Service Centre for best aftersales service

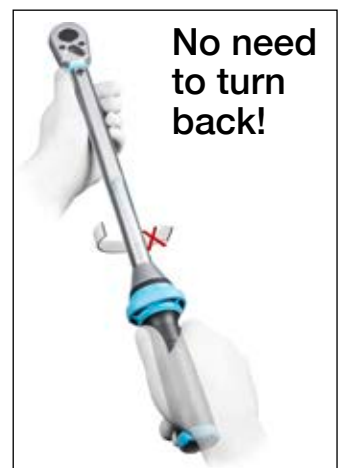
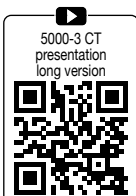
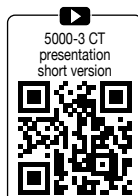



Torque technology



Always the right tool for the right „turn“ at the right „moment“!

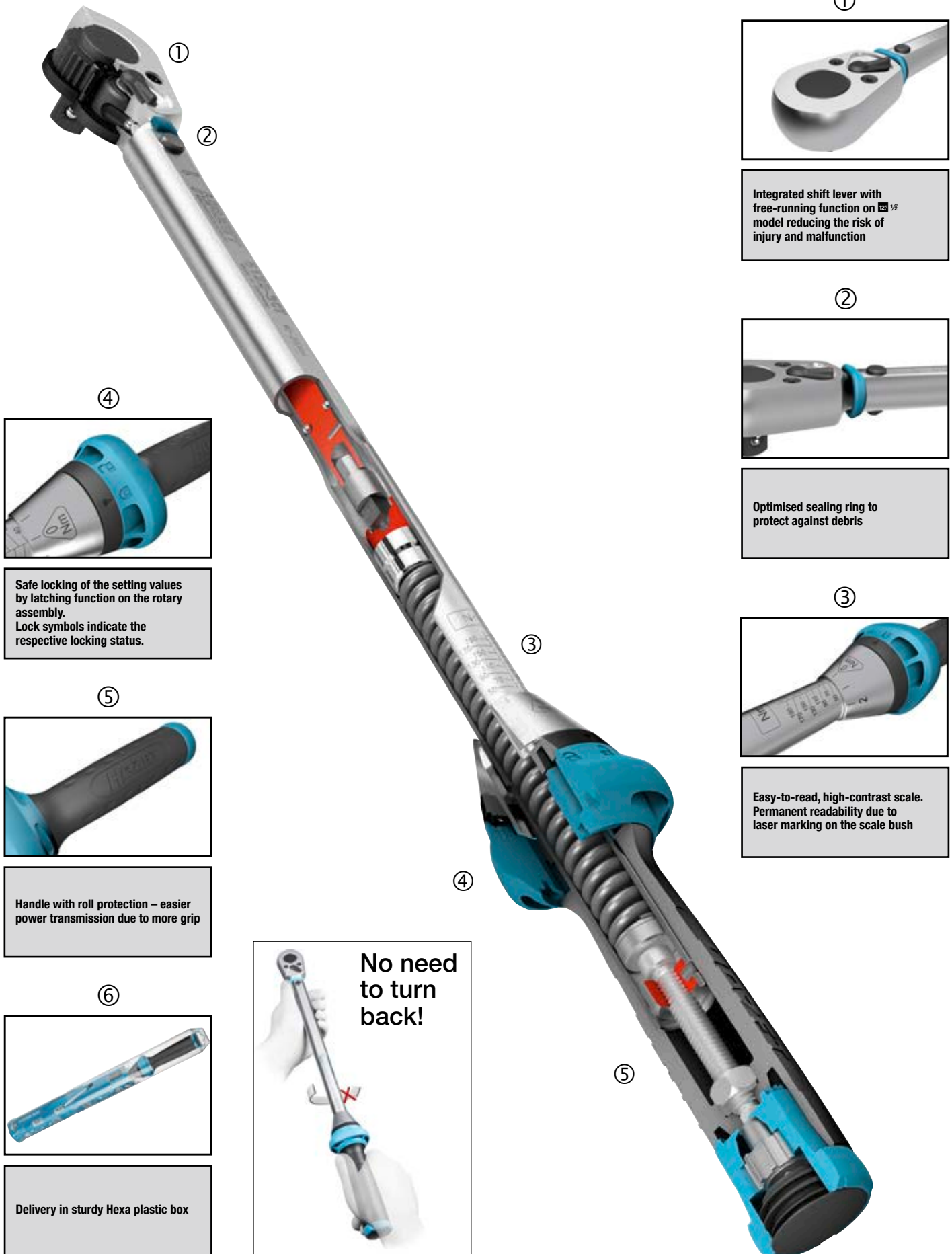

①



Integrated shift lever with free-running function on $\frac{1}{2}$ model reducing the risk of injury and malfunction

②



Optimised sealing ring to protect against debris

③



Easy-to-read, high-contrast scale. Permanent readability due to laser marking on the scale bush

④



Safe locking of the setting values by latching function on the rotary assembly. Lock symbols indicate the respective locking status.

⑤



Handle with roll protection – easier power transmission due to more grip

⑥



Delivery in sturdy Hexa plastic box



No need to turn back!



Insert torque wrenches

Universal in scope – with the best intentions

The use of over 100 insert tools allows any challenge to be mastered!

SYSTEM 5200-3 CT

- Torque ranges: 2.5–200 Nm
- **Accuracy $\pm 3\%$ of scale value**
- Tested in accordance with DIN EN ISO 6789-2:2017
- With calibration certificate and serial number
- Handle of the 5000-3 CT series
 - Detent point for rapid adjustment of the torque value
 - Can be attached to the cable loop
- Insert square 9×12 or 14×18 to hold insert tools

SYSTEM 6200-1 CT

- Torque ranges: 2–500 Nm
- **Accuracy $\pm 2\%$ of scale value**
- Tested in accordance with DIN EN ISO 6789-2:2017
- With calibration certificate and serial number
- All advantages of the 6000 CT series
- Insert square 9×12 or 14×18 to hold insert tools

SYSTEM 6300

- With permanently adjustable value – especially suitable for **application in industrial series production**
- Without adjustment scale
- **Repeat accuracy after 5,000 tightening operations $\pm 2\%$ (6391-10 $\pm 6\%$)**
- Automatic close-gap release – reaching the set value is signaled palpably and audibly
- Adjusting the desired torque value with adjustment wrench 6399 together with torque tester – e.g. HAZET 7901 E, 7902 E or 7903 E. Unauthorised adjustment is thereby prevented
- Torque ranges: 1–320 Nm
- Tested in accordance with DIN EN ISO 6789-2:2017
- With calibration certificate and serial number
- Insert square 9×12 or 14×18 to hold insert tools

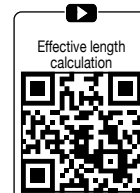



Insert tools



Data for effective length of torque wrenches with (different) insert tool holders

MDE = Torque to be selected

MDV = Prescribed torque

l_j = Standard length adjustment with adjusting tool

l_1 = Effective length of torque wrench

l_2 = Gauge dimension of adjusting tool

l_w = Gauge dimension of extended insert tool holder

$$MDE = \frac{(l_1 + l_2) \times MDV}{l_1 + l_w}$$

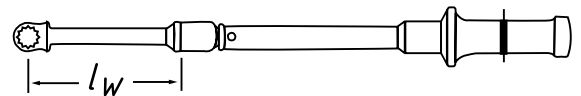
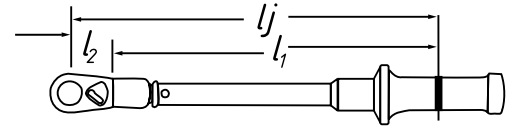

Formula: Torque correction factor for change in effective length

HAZET torque wrenches are adjusted/calibrated with the „ l_2 insert dimensions“. If other insert tools are used, then the formula must be observed.

Dimensions of the various HAZET torque wrenches:

HAZET No.	l_1 mm	Adjusted with HAZET No.	l_2 mm
5280-3 CT	172	6401-1(S)	19,5
5290-3 CT	245	6402-1(S)	30
5292-3 CT	422	6404-1(S)	38,5
6280-1 CT	140	6401-1 (S)	19,5
6281-2 CT	99	6401 N	17,5
6282-1 CT	200	6401-1 (S)	19,5

HAZET No.	l_1 mm	Adjusted with HAZET No.	l_2 mm
6290-1 CT	245	6402-1 (S)	30
6291-1 CT	330	6404-1 (S)	38,5
6291-2 CT	312	6402-1 (S)	30
6292-1 CT	432	6404-1 (S)	38,5
6293-1 CT	547	6404-1 (S)	38,5
6294-1 CT	649.2	6406	44
6295-1 CT	893.2	6406	44

HAZET No.	l_1 mm
6391-10 (V)	102
6391-12 (V)	102
6391-25 (V)	143
6391-35 (V)	143

HAZET No.	l_1 mm
6391- 50 (V)	201
6391- 85 (V)	276
6392-200 (V)	359
6392-320 (V)	589

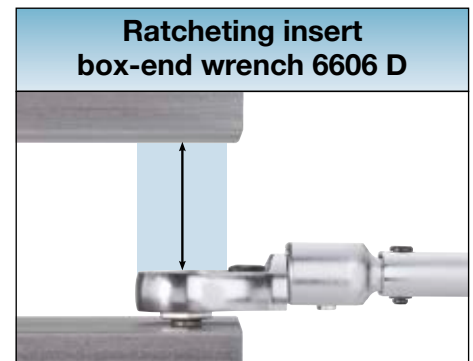
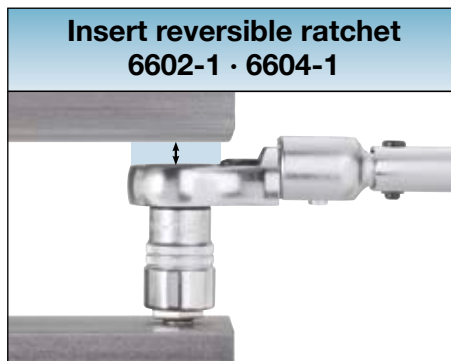
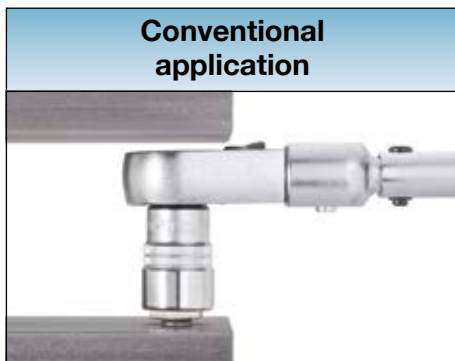

Torque screwdrivers

Fine feeling – for the smallest of torque values

- Application with standard $\frac{6.3}{16}$ bits (e.g. HAZET 2204 to 2225) as well as by using the 2304 adapter with $\frac{6.3}{16}$ sockets
- Torque ranges: 0.1 – 6 Nm
- Accuracy (of scale value) $\pm 5\%$ (6002 CT and 6003 CT) or $\pm 6-15\%$ for 6001 series





Torque wrenches SYSTEM 5000 CLT, Click-Lens type

The „Classic Workshop Tool“, easy to read

- Torque ranges: 20–320 Nm
- Click-Lens-Type (CLT) with value readout in the display guarantees security for the user
- Release accuracy tolerance (in direction of actuation) ± 4% of the scale value according to DIN EN ISO 6789-2:2017
- Torque release
 - palpable – by automatic close-gap release
 - audible – by „click“ sound

With serial number and calibration certificate



12⁵ 1/2

No need to turn back!

③
Hard chrome-plated steel tube – slim, but very sturdy and wear-resistant

⑥
Click-Lens-Type (CLT)

- Safe and exact adjustment of the desired release torque. Optimal and easy reading of the torque value
- Three large digits for an easy-to-read torque setting
- Large convex display (replaceable) prevents reading errors

– Safe in safe box with display window! –

Awarded with the

①
User-friendly reversible ratchet
Service friendly (do-it-yourself repair sets for ratchets available)
No risk of losing the square like there is with the wrench

②
Integrated shift lever with free-running function on 12⁵ 1/2 model reducing the risk of injury and malfunction

④
Ergonomically shaped handle with collar reducing the risk of slipping-off and injury
Safe and fast adjustment of the desired torque value by turning the handle

⑤
Safe locking at the handle



Torque technology



Torque wrenches SYSTEM 5000 KV

With protective insulation – for safe application up to 1000 volts

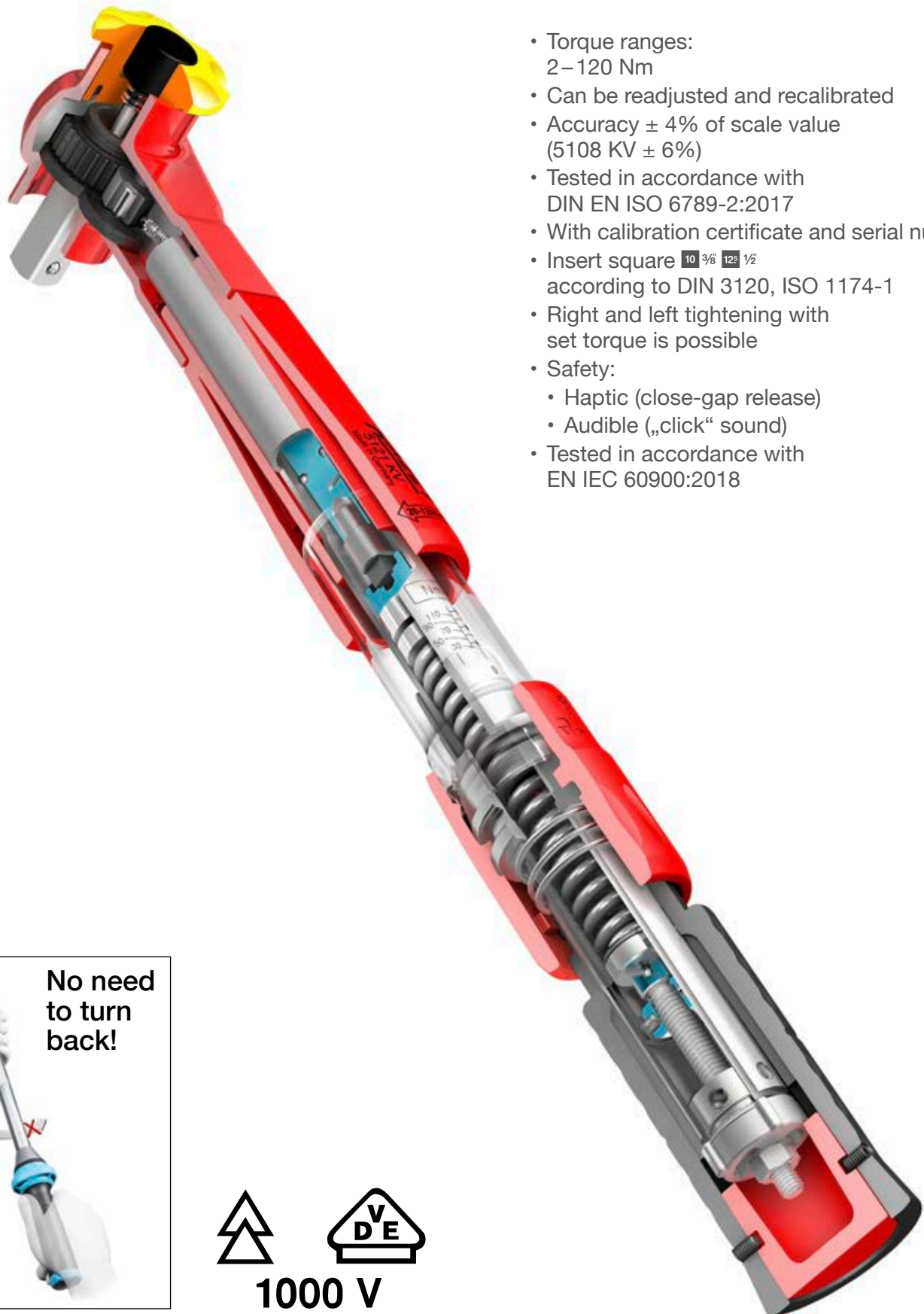

- Torque ranges:
2–120 Nm
- Can be readjusted and recalibrated
- Accuracy $\pm 4\%$ of scale value
(5108 KV $\pm 6\%$)
- Tested in accordance with
DIN EN ISO 6789-2:2017
- With calibration certificate and serial number
- Insert square $10 \frac{3}{8}$ $12 \frac{1}{2}$
according to DIN 3120, ISO 1174-1
- Right and left tightening with
set torque is possible
- Safety:
 - Haptic (close-gap release)
 - Audible („click“ sound)
- Tested in accordance with
EN IEC 60900:2018

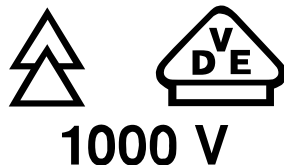

Made in Germany



Conversion

Conversion factors of torque values

Conversion formula:
Given unit x factor = Desired unit

Example:
Conversion from: 20 lbf.ft to Nm
 $20 \times 1.356 = 27.12 \text{ Nm}$

Given unit	Desired unit						
	mNm	cNm	Nm	kpm	ozf.in	lbf.in	lbf.ft
1 mNm	1	0.1	0.001	0.0001	0.142	0.009	0.0007
1 cNm	10	1	0.01	0.001	1.416	0.088	0.007
1 Nm	1000	100	1	0.102	141.6	8.851	0.738
1 kpm	9807	980.7	9.807	1	1389	86.8	7.233
1 ozf.in	7.062	0.706	0.007	0.0007	1	0.0625	0.005
1 lbf.in	113	11.3	0.113	0.0115	16	1	0.083
1 lbf.ft	1356	135.6	1.356	0.138	192	12	1

Design and Function

- In action, a HAZET torque wrench signals when it has reached the set torque
 - audibly by clicking,
 - palpably by automatic close-gap release
- Then the working procedure must be stopped immediately!
- The greater the set torque, the stronger the audible and palpable signals.

Pipes hardened and hard chrome-plated

- Optimised: weight / wall thickness
- Robust and protected surface

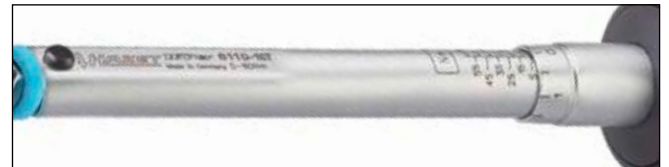

Coding rings application example:

(6132-1 CT – 6170-1 CT and 6294-1 CT – 6295-1 CT)

- **Fast detection of individually set Nm ranges**, e.g. green = always 250 Nm
- **Recognition of particular departments, work areas or people**
e.g. red = maintenance/repair department
- **Fast identification of the various torque wrenches**
e.g. yellow = HAZET 6160-1CT (2 pieces); red = HAZET 6170-1CT (3 pieces)
- **Clear allocation of defined workflows**, e.g. tools marked with red = workflow 1, tools marked with green = workflow 2

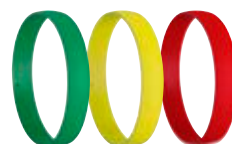

3 coloured coding rings for personalisation or identifying workflows



Torque technology



Functionality of torque wrench handles

(6132-1 CT – 6170-1 CT and 6294-1 CT – 6295-1 CT)

- Unlocking
- Slide the handle forward approximately 8 mm and gently turn it in the desired direction
- After engaging the handle, continue turning it to the desired torque (without pressing)
- Turn the handle back a little bit
- Locking



Twist lock

● = Ready to be set / NOT usable
(Setting not complete)



Twist lock

● = Ready for work / usable



ATTENTION: Twist lock = RED – do not use, unintended torque variation is possible!

Product group	Unlocking	Setting	Locking
5000 VDE	Retracting the locking sleeve	Turn handle until the desired value is reached on the scale	Releasing the locking sleeve
5000-3 CT	Turn rotary assembly to the left	Turn handle until the desired value is reached on the scale	Turn rotary assembly to the right
5000 CLT	Turn lock to the right	Push handle forwards and turn until the desired value is reached in the viewing window	Turn lock to the left
6106-1 CT – 6109-2 CT	Retracting the locking sleeve	Turn handle until the desired value is reached on the scale	Releasing the locking sleeve
6110-1 CT – 6170-1 CT	Turn lock to the right	Push handle forwards and turn until the desired value is reached on the scale	Turn lock to the left
6280-1 CT – 6281-2 CT	Retracting the locking sleeve	Turn handle until the desired value is reached on the scale	Releasing the locking sleeve
6290-1 CT – 6295-1 CT	Turn lock to the right	Push handle forwards and turn until the desired value is reached on the scale	Turn lock to the left

No need to turn back

Continuous long-term tests on the 5000 series and 6000 series of HAZET torque wrenches have demonstrated that turning them back to the smallest scale value is not required

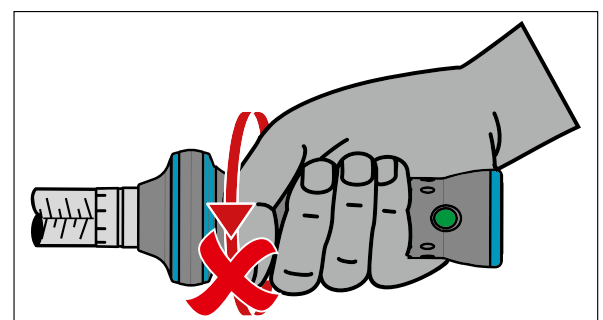



Tightening torque for screws according to strength classes for coarse thread

Thread size	Wrench size	Insert tools			Pre-loading force (kN)						Tightening torque (Nm)					
					Strength class						Strength class					
					4.6	5.6	6.8	8.8	10.9	12.9	4.6	5.6	6.8	8.8	10.9	12.9
M 2x0.40	4	-	-	-	0.338	0.422	0.675	0.901	1.267	1.52	0.13	0.163	0.261	0.348	0.489	0.587
M 3x0.50	5.5	-	-	-	0.845	1.056	1.689	2.253	3.168	3.801	0.48	0.6	0.961	1.281	1.801	2.161
M 4x0.70	7	9x12	-	-	1.463	1.829	2.927	3.902	5.487	6.585	1.115	1.393	2.229	2.972	4.18	5.016
M 5x0.80	8	9x12	-	-	2.395	2.994	4.79	6.387	8.982	10.778	2.261	2.827	4.523	6.03	8.48	10.176
M 6x1.00	10	9x12	-	-	3.379	4.224	6.758	9.011	12.671	15.205	3.843	4.803	7.685	10.247	14.41	17.292
M 8x1.25	13	9x12	14x18	-	6.202	7.753	12.404	16.539	23.258	27.909	9.349	11.686	18.698	24.931	35.059	42.07
M 10x1.50	17	9x12	14x18	-	9.876	12.345	19.752	26.336	37.034	44.441	18.54	23.18	37.09	49.45	69.54	83.44
M 12x1.75	19	9x12	14x18	-	14.4	18	28.801	38.401	54.001	64.801	32.37	40.46	64.74	86.32	121.38	145.66
M 14x2.00	22	-	14x18	-	19.775	24.719	39.551	52.734	74.158	88.989	51.77	64.71	103.54	138.06	194.14	232.97
M 16x2.00	24	-	14x18	-	27.221	34.027	54.443	72.591	102.08	122.497	80.62	100.77	161.24	214.98	302.32	362.78
M 18x2.50	27	-	14x18	-	33.078	41.347	66.155	88.207	124.041	148.85	111.09	138.86	222.17	296.23	416.58	499.89
M 20x2.50	30	-	14x18	-	42.534	53.167	85.067	113.423	159.501	191.401	157.46	196.82	314.91	419.88	590.46	708.55
M 22x2.50	32	-	14x18	21/26	53.175	66.469	106.35	141.8	199.406	239.288	215.1	268.9	430.2	573.7	806.7	968
M 24x3.00	36	-	14x18	21/26	61.248	76.56	122.497	163.329	229.681	275.617	272.1	340.1	544.2	725.6	1020.3	1224.4
M 27x3.00	41	-	14x18	21/26	80.67	100.837	161.339	215.119	302.512	363.014	399.9	499.9	799.9	1066.5	1499.7	1799.7
M 30x3.50	46	-	-	21/26	98.027	122.533	196.054	261.405	367.6	441.12	541.7	677.2	1083.4	1444.6	2031.5	2437.7
M 33x3.50	50	-	-	-	122.241	152.801	244.482	325.976	458.404	550.084	738.5	923.2	1477.1	1969.4	2769.5	3323.4
M 36x4.00	55	-	-	-	143.413	179.266	286.826	382.434	537.798	645.358	948	1185	1896	2528	3555	4265.9
M 39x4.00	60	-	-	-	172.42	215.525	344.839	459.786	646.574	775.888	1229	1536	2457	3276	4607	5529
M 42x4.50	65	-	-	-	197.407	246.758	394.813	526.417	740.275	888.329	1519	1899	3038	4050	5696	6835
M 45x4.50	70	-	-	-	231.206	289.007	462.412	616.549	867.022	1040.426	1898	2373	3796	5062	7118	8541
M 48x5.00	75	-	-	-	280.008	325.01	520.015	693.354	975.029	1170.035	2282	2853	4565	6086	8559	10271
M 52x5.00	80	-	-	-	312.056	390.07	624.112	832.149	1170.209	1404.251	2954	3692	5907	7876	11076	13292
M 56x5.50	85	-	-	-	359.843	449.804	719.689	959.581	1349.411	1619.293	3672	4591	7345	9793	13772	16526
M 60x5.50	90	-	-	-	420.651	525.813	841.301	1121.735	1577.44	1892.928	4582	5728	9164	12219	17183	20619
M 64x6.00	95	-	-	-	475.86	594.825	951.72	1268.96	1784.476	2141.371	5536	6920	11071	14762	20759	24911
M 68x6.00	100	-	-	-	545.427	681.784	1090.855	1454.473	2045.353	2454.423	6720	8400	13440	17919	25199	30239

Tightening torque for screws according to strength classes for fine pitch thread

Thread size	Wrench size	Insert tools			Pre-loading force (kN)						Tightening torque (Nm)					
					Strength class						Strength class					
					4.6	5.6	6.8	8.8	10.9	12.9	4.6	5.6	6.8	8.8	10.9	12.9
M 8x1.00	13	9x12	14x18	-	6.805	8.507	13.611	18.148	25.52	30.624	10.08	12.6	20.15	26.87	37.79	45.35
M 10x1.25	17	9x12	14x18	-	11.418	14.272	22.835	30.447	42.816	51.379	20.83	26.04	41.66	55.55	78.11	93.73
M 12x1.50	19	9x12	14x18	-	15.312	19.14	30.624	40.832	57.42	68.904	34.01	42.51	68.02	90.69	127.54	153.05
M 14x1.50	22	-	14x18	-	21.934	27.418	43.868	58.491	82.253	98.703	56.25	70.32	112.51	150.01	210.96	253.15
M 16x1.50	24	-	14x18	-	29.741	37.177	59.483	79.31	111.53	133.836	86.5	108.12	172.99	230.66	324.36	389.23
M 18x1.50	27	-	14x18	-	38.733	48.417	77.467	103.289	145.25	174.3	125.95	157.44	251.91	335.88	472.33	566.8
M 20x1.50	30	-	14x18	-	48.91	61.138	97.82	130.427	183.413	220.096	175.9	219.8	351.7	468.9	659.4	791.3
M 22x1.50	32	-	14x18	21/26	60.272	75.34	120.543	160.724	226.019	271.223	237.4	296.8	474.8	633.1	890.3	890.3
M 24x2.00	36	-	14x18	21/26	72.818	91.022	145.635	194.18	273.066	327.68	311.8	389.8	623.7	831.6	1169.4	1403.3

The specified tightening torques are guide values
All information subject to change



Adjustment / calibration

- A HAZET torque wrench should be checked and readjusted regularly. This is recommended after approx. 5,000 screw operations (but no later than after twelve months).
- The time gap between test dates is dependent on the frequency of use. A HAZET torque tester is suitable for this.
- If a suitable torque tester with click point detection is not available, we will accept the HAZET torque wrench via your HAZET specialist dealer for inspection and adjustment at the facility.
- After testing and possible adjustment, the torque wrenches and torque testers sent to HAZET are returned to you with a test certificate.



HAZET SERVICE for torque wrenches and pneumatic tools

All HAZET torque tools and pneumatic tools are serviceable! Along with repairs, we offer factory tests through to calibration in our own DAkkS calibration laboratory for torque wrenches in the HAZET Service Center. Your local HAZET partner will be happy to advise you on all the services provided by the HAZET Service Center as well as local on-site services.



SYSTEM 5000 CT

Torque wrench, with protective insulation

See chapter Tools with protective insulation / Tools for electricians page 283



5000-3CT Torque wrench · SYSTEM 5000-3CT (with reversible ratchet) · ±3% accuracy · 5107-3CT 4% · 1–800 Nm

Made in Germany

• User-friendly reversible ratchet

6.3 1/4" 10 3/8" 12.5 1/2" 20 3/4" (E)

- **Accuracy ± 3% of the scale value** (in direction of actuation for right-hand tightening) (5107-3CT ± 4% accuracy of scale value)
- For left-hand tightening, use our torque wrenches with insert tool
- Safety:
 - Haptic (close-gap release)
 - Audible („click“ sound)
- Designed for rough workshop use
- Wide range of applications for controlled screw tightening in tyre service, bicycle, passenger car and commercial vehicle applications as well as various applications in trade and industry
- Optimised sealing ring to protect against debris
- Ratchet repair set for customer-oriented self-assembly enables decades of use
- Handle with better grip for easier power transmission
- Adjustment aid with detent points for optimised operator guidance ensures safe and fast adjustment of the desired torque value by turning the handle
- Safe locking of the setting values by latching function on the rotary assembly
- Rotary assembly in triangular form prevents uncontrolled rolling
- Lock symbols indicate the respective locking status
- Can be attached to the cable loop through openings on the locking rotary assembly
- Easy-to-read, high-contrast scale
- Permanent readability due to laser marking on the scale bush
- Integrated shift lever
 - 5121-3CT – 5123-3CT:** shift lever with idle function
 - reduces risk of injury and malfunction
- With calibration certificate and serial number
- Delivery in sturdy Hexa plastic box
- DIN EN ISO 6789-2:2017, DIN 3120, ISO 1174-1



YouTube clip
Long version



YouTube clip
Short
version

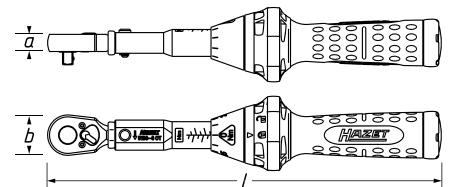





Torque technology

SYSTEM 5000 CT



5000-3 CT Torque wrench · SYSTEM 5000-3CT (with reversible ratchet) · ±3% accuracy · 5107-3CT 4% · 1–800 Nm

6.3 1/4" 10 3/8" 12.5 1/2" 20 3/4" (E)

HAZET No.	Output	l mm	a mm	b mm	Release accuracy tolerance %	Nm	 Nm	 kg	EAN-No. 4000896+
• For working on motorcycles, bicycles and tyre pressure control systems									
5107-3 CT	■ 6.3 = 1/4"	234	10.2	24	4	1–9	0.1	0.6–5.5	218875
• For working on motorcycles and bicycles									
5108-3 CT	■ 6.3 = 1/4"	234	10.2	24	3	2.5–25	0.25	1.4–15.3	218882
5110-3 CT	■ 10 = 3/8"	320	14.5	32	3	10–60	0.5	3.9–25.0	218899
• Extra short design – compact									
• Specifically also for commercial vehicles									
5120-3 CT	■ 12.5 = 1/2"	320	14.5	32	3	10–60	0.5	3.9–25.0	218905
• Slim ratchet head – ideally suited for use on motorcycles									
5111-3 CT	■ 10 = 3/8"	375	14.5	32	3	20–120	1	6.9–43.5	235384
5121-3 CT	■ 12.5 = 1/2"	421	19.6	44	3	20–120	1	6.1–38.0	218912
5122-3 CT	■ 12.5 = 1/2"	519	19.6	44	3	40–200	1	9.4–49.5	219001
5123-3 CT	■ 12.5 = 1/2"	628	19.6	44	3	60–320	2	11.3–62.2	218998
• For applications with high torques									
– Axle central screws in FIAT Ducato · MERCEDES-BENZ Sprinter									
– Wheel bearings in e.g. OPEL/VAUXHALL Movano · PEUGEOT Boxer									
– Bearing blocks in agricultural machinery and gearbox mounts in commercial vehicles									
• Thanks to the possibility of using 12.5 mm (1/2") sockets/extensions, torque-controlled screw connections of 100 to 400 Nm can now also be operated in all manual and industrial production areas, e.g. with threads of M12 to M16 (property class 12.9) or M16 to M24 (property class 5.6) with restricted access, e.g. for flange or machine screw connections									
5143-3 CT	■ 12.5 = 1/2"	790	28.5	64	3	100–400	2.5	14.8–60.3	235407
5145-3 CT	■ 20 = 3/4"	1271	28.5	64	3	300–800	2.5	26.2–71.0	218929
• Torque wrench with DAKS calibration certificate									
5107-3 CT CAL	■ 6.3 = 1/4"	234	10.2	24	4	1–9	0.1	0.6–5.5	243105
5108-3 CT CAL	■ 6.3 = 1/4"	234	10.2	24	3	2.5–25	0.25	1.4–15.3	243129
5110-3 CT CAL	■ 10 = 3/8"	320	14.5	32	3	10–60	0.25	3.9–25.0	243136
5111-3 CT CAL	■ 10 = 3/8"	375	14.5	32	3	20–120	1	6.9–43.5	243143
5120-3 CT CAL	■ 12.5 = 1/2"	320	14.5	32	3	10–60	0.5	3.9–25.0	243150
5121-3 CT CAL	■ 12.5 = 1/2"	421	19.6	44	3	20–120	1	6.1–38.0	243167
5122-3 CT CAL	■ 12.5 = 1/2"	519	19.6	44	3	40–200	1	9.4–49.5	243174
5123-3 CT CAL	■ 12.5 = 1/2"	628	19.6	44	3	60–320	2	11.3–62.2	243181
5143-3 CT CAL	■ 12.5 = 1/2"	790	28.5	64	3	100–400	2.5	14.8–60.3	243198
5145-3 CT CAL	■ 20 = 3/4"	1271	28.5	64	3	300–800	2.5	26.2–71.0	243204

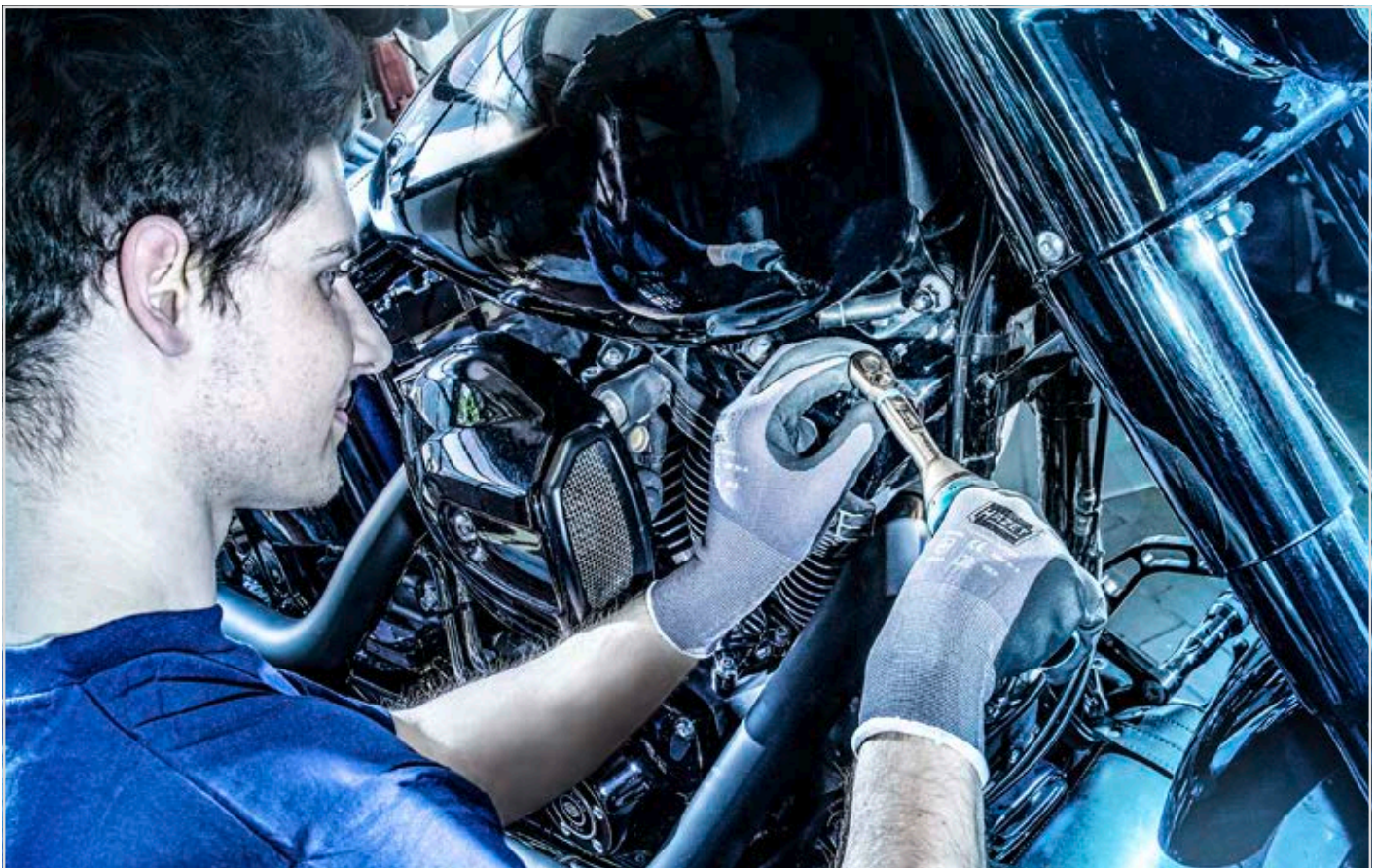



5000 B-3 CT Torque wrench · SYSTEM 5000B-3CT (with reversible ratchet for screwdriver bits) · ±3 / 4% accuracy · 1–25 Nm

Made in Germany

• User-friendly reversible ratchet for bits



- Accuracy ± 3% (5108B-3CT) or 4% (5107B-3CT) of the scale value (in direction of actuation for right-hand tightening)
- Safety:
 - Haptic (close-gap release)
 - Audible („click“ sound)
- Designed for rough workshop use
- Wide range of applications for controlled screw tightening for bicycle, passenger car and commercial vehicle applications as well as various applications in trade and industry
- Optimised sealing ring to protect against debris
- Handle with better grip for easier power transmission
- Adjustment aid with detent points for optimised operator guidance ensures safe and fast adjustment of the desired torque value by turning the handle
- Safe locking of the setting values by latching function on the rotary assembly
- Rotary assembly in triangular form prevents uncontrolled rolling
- Lock symbols indicate the respective locking status
- Can be attached to the cable loop through openings on the locking rotary assembly
- Easy-to-read, high-contrast scale
- Permanent readability due to laser marking on the scale bush
- Integrated shift lever
- With calibration certificate and serial number
- Delivery in sturdy Hexa plastic box
- For e.g. maintenance and service work on the burner flange or the electrodes on compact modules for condensing and combi gas boilers
- For aluminium and carbon parts · plastic attached parts · fairings of motorcycles · scooters · bicycles
- DIN EN ISO 6789-2:2017

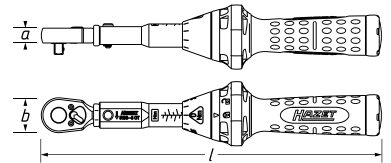
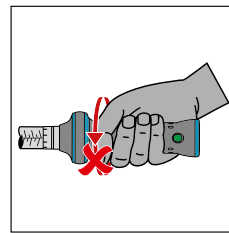

HAZET No.	Output	l mm	a mm	b mm	Release accuracy tolerance %	Nm	Nm	kg	EAN-No. 4000896+
5107 B-3 CT	⊘ 6.3 = 1/4"	234	10.2	24	4	1–9	0.1	0.6–5.5	244584
5108 B-3 CT	⊘ 6.3 = 1/4"	234	10.2	24	3	2.5–25	0.25	1.4–15.3	244591

5200-3 CT Torque wrench · SYSTEM 5200-3CT (with insert square) · ±3% accuracy · 10–200 Nm

Made in Germany

• Plug-and-socket connection to hold insert tools

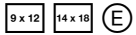

- Accuracy ± 3% of the scale value (in direction of actuation)
Can be used for right-hand and left-hand threads by turning the insert tool
- Safety:
 - Haptic (close-gap release)
 - Audible („click“ sound)
- Designed for rough workshop use
- Wide range of applications for controlled screw tightening in tyre service, bicycle, passenger car and commercial vehicle applications as well as various applications in trade and industry
- Optimised sealing ring to protect against debris
- Handle with better grip for easier power transmission
- Adjustment aid with detent points for optimised operator guidance ensures safe and fast adjustment of the desired torque value by turning the handle
- Safe locking of the setting values by latching function on the rotary assembly
- Rotary assembly in triangular form prevents uncontrolled rolling
- Lock symbols indicate the respective locking status
- Can be attached to the cable loop through openings on the locking rotary assembly
- Easy-to-read, high-contrast scale
- Permanent readability due to laser marking on the scale bush
- With calibration certificate and serial number
- Delivery in sturdy Hexa plastic box
- DIN EN ISO 6789-2:2017

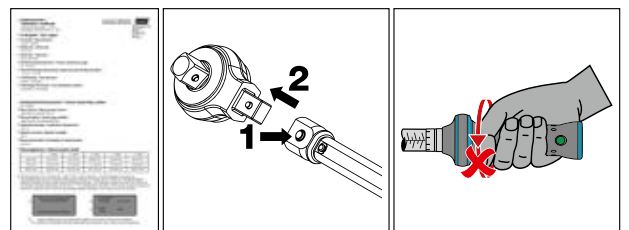
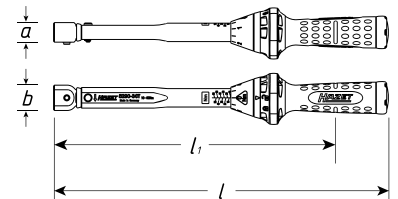

HAZET No.	Output	l mm	l ₁ mm	l ₂ mm	a mm	b mm	Release accuracy tolerance %	Nm	Nm	kg	EAN-No. 4000896+
5280-3 CT	□ 9x12	218	172	19.5	17	22	3	2.5–25	0.25	1.3–14.3	239290
5290-3 CT	□ 9x12	291	245	30	17	22	3	10–60	0.5	3.7–23.4	228904
5292-3 CT	□ 14x18	484	422	38.5	23	30	3	40–200	1	8.9–46.6	228911
• Torque wrench with DAKkS calibration certificate											
5280-3 CT CAL	□ 9x12	218	172	19.5	17	22	3	2.5–25	0.25	1.3–14.3	243211
5290-3 CT CAL	□ 9x12	291	245	30	17	22	3	10–60	0.5	3.7–23.4	243228
5292-3 CT CAL	□ 14x18	484	422	38.5	23	30	3	40–200	1	8.9–46.6	243235



Torque technology

SYSTEM 5000 CLT



SYSTEM 5000 CLT

5000 CLT Torque wrench · SYSTEM 5000CLT · ± 4% accuracy · 20–320 Nm

Made in Germany

• Click-Lens-Type with value readout in the display guarantees security for the user

12.5 1/2" E

- Accuracy ± 4% of the scale value (in direction of actuation for right-hand tightening)
For left-hand tightening, use our torque wrenches with insert tool
- Safety:
 - Haptic (close-gap release)
 - Audible („click“ sound)
- Reversible ratchet
- Easy and safe adjustment of the desired torque value by turning the handle
- Knob for additionally locking the set value
- Three large digits for an easy-to-read torque setting
- With calibration certificate and serial number
- Secure storage in safe box with display window
- Surface: hard chrome plated
- DIN EN ISO 6789-2:2017, DIN 3120, ISO 1174-1

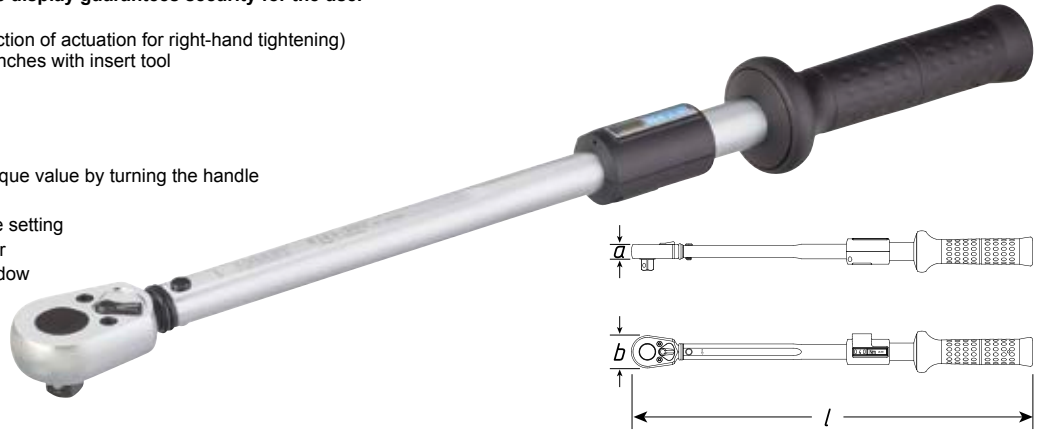

HAZET No.	Output	l mm	a mm	b mm	Release accuracy tolerance %	Nm	Nm		EAN-No. 4000896+
5121-2 CLT	■ 12.5 = 1/2"	435	19.6	44	4	20–120	1	5.9–37.0	104215
5122-2 CLT	■ 12.5 = 1/2"	545	19.6	44	4	40–200	1	9.0–47.4	104192
5123-2 CLT	■ 12.5 = 1/2"	660	19.6	44	4	60–320	2	10.8–59.4	104222
• Torque wrench with DAKS calibration certificate									
5121-2 CLT CAL	■ 12.5 = 1/2"	435	19.6	44	4	20–120	1	5.9–37.0	243242
5122-2 CLT CAL	■ 12.5 = 1/2"	545	19.6	44	4	40–200	1	9.0–47.4	243259
5123-2 CLT CAL	■ 12.5 = 1/2"	660	19.6	44	4	60–320	2	10.8–59.4	243266

SYSTEM 6000 CT

6000-1 CT Torque wrench · SYSTEM 6000CT · ± 2% accuracy · 6106-1CT 4% · 1–40 Nm

Made in Germany

- Safety:
 - Haptic (close-gap release)
 - Audible („click“ sound)
- Easy and safe adjustment of the desired torque value by turning the handle
- Especially slim design thanks to spring-loaded puller sleeve for locking the setting values
- Accuracy ± 2% of the scale value (6106-1CT ± 4%) (in direction of actuation for right-hand tightening)
For left-hand tightening, use our torque wrenches with insert tool
- Application: engines, gearboxes, machinery, industry, model making
- With calibration certificate and serial number
- DIN EN ISO 6789-2:2017, DIN 3120, ISO 1174-1

6.3 1/4" E

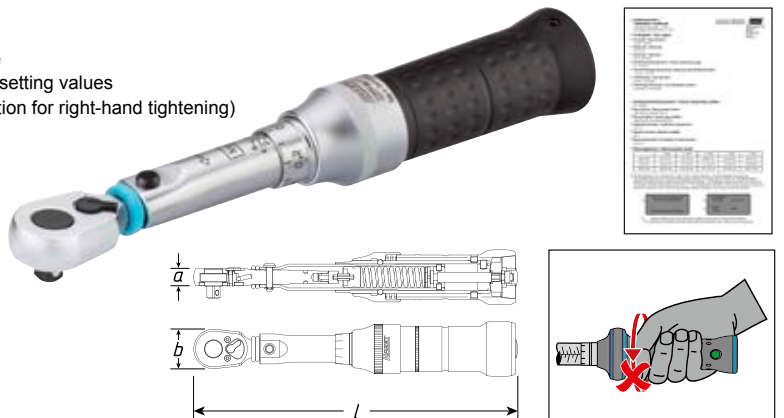

¹⁾ Not according to DIN, as the maximum torque value of the square specified in the standard 6789-1:2017 is exceeded

HAZET No.	Output	l mm	a mm	b mm	Release accuracy tolerance %	Nm	Nm		EAN-No. 4000896+
6106-1 CT	■ 6.3 = 1/4"	197	10.2	24	4	1–6	0.1	0.7–4.4	173167
6108-1 CT	■ 6.3 = 1/4"	198	10.2	24	2	2–10	0.2	1.4–7.3	062218
6109-2 CT ¹⁾	■ 6.3 = 1/4"	256	10.2	24	2	4–40	0.4	2.0–21.4	080564
• Torque wrench with DAKS calibration certificate									
6106-1 CT CAL	■ 6.3 = 1/4"	197	10.2	24	4	1–6	0.1	0.7–4.4	192892
6108-1 CT CAL	■ 6.3 = 1/4"	198	10.2	24	2	2–10	0.2	1.4–7.3	192908
6109-2 CT CAL ¹⁾	■ 6.3 = 1/4"	256	10.2	24	2	4–40	0.4	2.0–21.4	193318



6000-1 CT Torque wrench · SYSTEM 6000CT · ± 2% accuracy · 5–800 Nm

Made in Germany

- **Accuracy ± 2% of the scale value** (in direction of actuation for right-hand tightening)
For left-hand tightening, use our torque wrenches with insert tool
- **HiPer fine-tooth reversible ratchet** in 6121-1CT · 6122-1CT · 6123-1CT (90 teeth · 4° operating angle)
- High-precision premium torque tools – for the highest demands
- **Hard chrome-plated** steel tube – slim, but very sturdy and wear-resistant
- Secure storage in safe box with display window
- Safety:
 - Haptic (close-gap release)
 - Audible („click“ sound)
- User-friendly reversible ratchet
- **Service-friendly** (do-it-yourself repair sets for ratchets available)
- Integrated shift lever
- Easy and safe adjustment of the desired torque value by turning the handle
- Knob for additionally locking the set value
- Ergonomically shaped handle with collar **reduces the risk of slipping-off and injury**
- Accuracy – fine scale graduation
- With calibration certificate and serial number
- Surface: hard chrome plated
- DIN EN ISO 6789-2:2017, DIN 3120, ISO 1174-1

HiPer 10 3/8" 12.5 1/2" 20 3/4" (E)



YouTube Clip

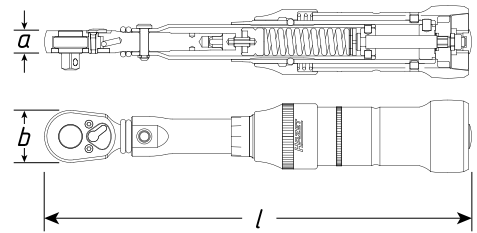

HAZET No.	Output	l mm	a mm	b mm	Release accuracy tolerance %	Nm	Nm		EAN-No. 4000896+
6110-1 CT	■ 10 = 3/8"	335	14.5	32	2	5–60	0.5	1.9–24.7	025022
6111-1 CT	■ 10 = 3/8"	389	14.5	32	2	20–120	1	6.7–42.4	025077
6121-1 CT	■ 12.5 = 1/2"	437	19.6	44	2	20–120	1	6.0–37.4	025220
6122-1 CT	■ 12.5 = 1/2"	547	19.6	44	2	40–200	1	9.0–47.5	025268
6123-1 CT	■ 12.5 = 1/2"	661	19.6	44	2	60–320	2	10.8–59.6	025367
<ul style="list-style-type: none"> • 2-component handle for improved feel • Simplified locking for adjusting the torque value • Viewing window for visual checking of the locking • 4 coloured coding rings (red, yellow, green, black) for markings in the case of personalisation or special workflows 									
6143-1 CT	■ 20 = 3/4"	802	28.5	64	2	100–400	2.5	14.5–59.2	025466
6144-1 CT	■ 20 = 3/4"	1046	28.5	64	2	200–500	2.5	21.6–54.6	025541
6145-1 CT	■ 20 = 3/4"	1283	28.5	64	2	300–800	2.5	25.9–70.2	025565
<ul style="list-style-type: none"> • Torque wrench with DAkKS calibration certificate 									
6110-1 CT CAL	■ 10 = 3/8"	335	14.5	32	2	5–60	0.5	1.9–24.7	192915
6111-1 CT CAL	■ 10 = 3/8"	389	14.5	32	2	20–120	1	6.7–42.4	193011
6121-1 CT CAL	■ 12.5 = 1/2"	435	19.6	44	2	20–120	1	6.0–37.4	193028
6122-1 CT CAL	■ 12.5 = 1/2"	543	19.6	44	2	40–200	1	9.0–47.5	193233
6123-1 CT CAL	■ 12.5 = 1/2"	659	19.6	44	2	60–320	2	10.8–59.6	193240
<ul style="list-style-type: none"> • Torque wrench with DAkKS calibration certificate • 2-component handle for improved feel • Simplified locking for adjusting the torque value • Viewing window for visual checking of the locking • 4 coloured coding rings (red, yellow, green, black) for markings in the case of personalisation or special workflows 									
6143-1 CT CAL	■ 20 = 3/4"	802	28.5	64	2	100–400	2.5	14.5–59.2	192922
6144-1 CT CAL	■ 20 = 3/4"	1046	28.5	64	2	200–500	2.5	21.6–54.6	193035
6145-1 CT CAL	■ 20 = 3/4"	1283	28.5	64	2	300–800	2.5	25.9–70.2	193042



Torque technology

SYSTEM 6000 CT



6000-1 CT Torque wrench · SYSTEM 6000CT · ± 3% accuracy (6170-1CT 4%) · 400–2000 Nm

Made in Germany

• For highest torque values

20 3/4" 25 1" E

- **Accuracy ± 3% of the scale value** (6170-1CT ± 4%) (in direction of actuation for right-hand tightening)
For left-hand tightening, use our torque wrenches with insert tool
- For industrial climbers
- Application on wind turbines, dockyards, in the aviation industry and heavy industry, on commercial vehicles etc.
- To be disassembled in two parts (6170-1CT: three parts) with release tool
- Bag included for safe storage and for carrying or wearing on your back
- Fast screw tightening also possible with ratchet shaft. For torque tightening always use the complete wrench
- Safety:
 - Haptic (close-gap release)
 - Audible („click“ sound)
- **2-component handle** for improved feel
- Simplified locking for adjusting the torque value
- Viewing window for visual checking of the locking
- 4 coloured coding rings (red, yellow, green, black) for markings in the case of personalisation or special workflows
- With calibration certificate and serial number
- DIN EN ISO 6789-2:2017, DIN 3120, ISO 1174-1

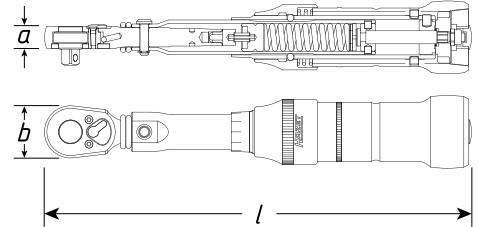

¹⁾ Calibration according to company standards

HAZET No.	Output	l mm	a mm	b mm	Release accuracy tolerance %	Nm	Nm		EAN-No. 4000896+
1000 Nm torque wrench Weight only about 10 kg									
• Actuating force only 590 N (60 kg) at 1000 Nm									
• Length of ratchet shaft: 885 mm, handle: 969 mm									
6150-1CT	■ 20 = 3/4"	1789	36	77	3	400–1000	5	24.2–61.0	141067
1600 Nm torque wrench Weight only about 14 kg									
• Actuating force only 685 N (70 kg) at 1600 Nm									
• Length of ratchet shaft 1316.5 mm, handle 1203 mm									
6160-1CT	■ 25 = 1"	2455	36	77	3	600–1600	5	26.1–70.1	155316
2000 Nm torque wrench Weight only about 18 kg									
• Actuating force only 685 N (70 kg) at 2000 Nm									
• Length of ratchet shaft: 1316.5 mm, middle piece: 644 mm, handle: 1203 mm									
• Calibration according to company standards									
6170-1CT	■ 25 = 1"	3033	36	77	4	800–2000	6	27.9–70.1	177776
• Torque wrench with DAkKS calibration certificate									
6150-1CT CAL¹⁾	■ 20 = 3/4"	1789	36	77	3	400–1000	5	24.2–61.0	193059
6160-1CT CAL¹⁾	■ 25 = 1"	2455	36	77	3	600–1600	5	26.1–70.1	193066



6000-1 CT-US Torque wrench · SYSTEM 6000CT · US-STANDARD · ± 3% accuracy · 5–600 lbf.ft

Made in Germany

- According to US standards
- Scale graduation in lbf.ft
- **Accuracy ± 3% of the scale value**
(in direction of actuation for right-hand tightening)
For left-hand tightening, use our torque wrenches with insert tool
- Safety:
 - Haptic (close-gap release)
 - Audible („click“ sound)
- Easy and safe adjustment of the desired torque value by turning the handle
- **HiPer fine-tooth reversible ratchet** in 6127-1CT (90 teeth · 4° operating angle)
- Knob for additionally locking the set value
- Secure storage in safe box with display window
- With calibration certificate and serial number
- DIN EN ISO 6789-2:2017, DIN 3120, ISO 1174-1

HiPer 10 3/8" 12.5 1/2" 20 3/4" (E)



YouTube Clip

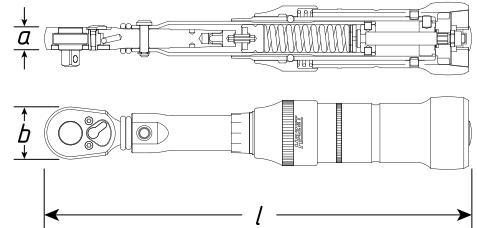

HAZET No.	Output	l mm	a mm	b mm	Release accuracy tolerance %	lbf.ft.	Nm	lbf.ft.	kg	EAN-No. 4000896+
6114-1 CT	■ 10 = 3/8"	333	14.5	32	3	5–40	6.8–54.2	0.5	2.6–21.8	078424
6115-1 CT	■ 10 = 3/8"	390	14.5	32	3	20–100	27.1–135.6	0.5	9.1–48.2	025084
6127-1 CT	■ 12.5 = 1/2"	545	19.6	44	3	40–200	54.2–271.2	1	12.3–64.6	025381
6128-1 CT	■ 12.5 = 1/2"	660	19.6	44	3	50–250	67.8–339	2	12.2–62.6	076116

- **2-component handle** for improved feel
- Simplified locking for adjusting the torque value
- Viewing window for visual checking of the locking
- 4 coloured coding rings (red, yellow, green, black) for markings in the case of personalisation or special workflows

6132-1 CT	■ 20 = 3/4"	1284	28.5	64	3	120–600	162.7–813.5	2	14.0–71.6	078455
-----------	-------------	------	------	----	---	---------	-------------	---	-----------	--------





Torque technology

SYSTEM 6000 CT



6200-1 CT Torque wrench · SYSTEM 6000CT · ± 2% accuracy · 2–40 Nm

Made in Germany

- Plug connection to hold insert tools
- **Accuracy ± 2% of the scale value** (in direction of actuation)
Can be used for right-hand and left-hand threads by turning the insert tool
- Safety:
 - Haptic (close-gap release)
 - Audible („click“ sound)
- With calibration certificate and serial number
- Especially slim design thanks to spring-loaded puller sleeve for locking the setting values
- Easy and safe adjustment of the desired torque value by turning the handle
- DIN EN ISO 6789-2:2017

9 x 12 (E)

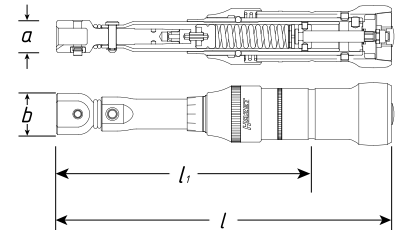
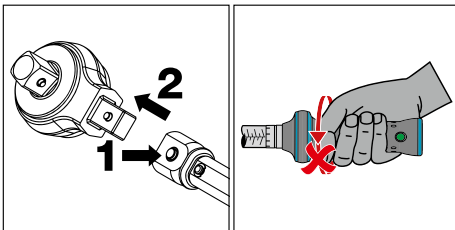

¹⁾ Not according to DIN, as the maximum torque value of the square specified in the standard 6789-1:2017 is exceeded

HAZET No.	Output	l mm	l_1 mm	l_2 mm	a mm	b mm	Release accuracy tolerance %	Nm	Nm	kg	EAN-No. 4000896+
6280-1 CT	□ 9x12	181	141	19.5	17	22	2	2–10	0.2	1.3–6.6	026005
6282-1 CT ¹⁾	□ 9x12	240	200	19.5	17	22	2	4–40	0.4	1.9–19.8	080540
• Torque wrench with DAkkS calibration certificate											
6280-1 CT CAL	□ 9x12	181	141	19.5	17	22	2	2–10	0.2	1.3–6.6	193073
6282-1 CT CAL ¹⁾	□ 9x12	240	200	19.5	17	22	2	4–40	0.4	1.9–19.8	193080

6200-1 CT Torque wrench · SYSTEM 6000CT · ±4% accuracy · 5–13 Nm

Made in Germany

- **Extra short construction for areas with restricted access**
- Plug connection to hold insert tools
- **Accuracy ± 4% of the scale value** (in direction of actuation)
Can be used for right-hand and left-hand threads by turning the insert tool
- Safety:
 - Haptic (close-gap release)
 - Audible („click“ sound)
- With calibration certificate and serial number
- Easy and safe adjustment of the desired torque value by turning the handle
- Surface: hard chrome plated
- DIN EN ISO 6789-2:2017

9 x 12 (E)

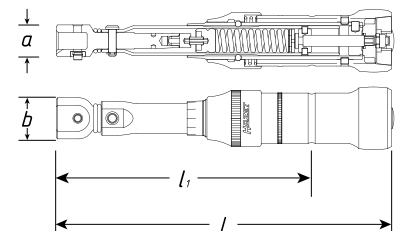
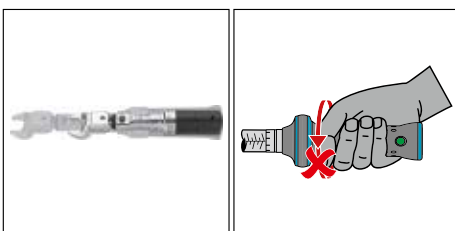

HAZET No.	Output	l mm	l_1 mm	l_2 mm	a mm	b mm	Release accuracy tolerance %	Nm	Nm	kg	EAN-No. 4000896+
6281-2 CT	□ 9x12	125.4	99	17.5	17	22	4	5–13	0.2	4.4–11.8	183326
• Torque wrench with DAkkS calibration certificate											
6281-2 CT CAL	□ 9x12	125.4	99	17.5	17	22	4	5–13	0.2	4.4–11.8	193295



6200-1 CT Torque wrench · SYSTEM 6000CT · ± 2% accuracy · 5–320 Nm

Made in Germany

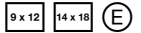

- Plug connection to hold insert tools
- **Accuracy ± 2% of the scale value** (in direction of actuation)
Can be used for right-hand and left-hand threads by turning the insert tool
- Safety:
 - Haptic (close-gap release)
 - Audible („click“ sound)
- With calibration certificate and serial number
- Easy and safe adjustment of the desired torque value by turning the handle
- Secure storage in safe box with display window
- DIN EN ISO 6789-2:2017

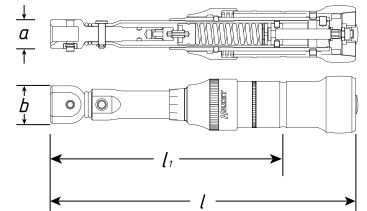
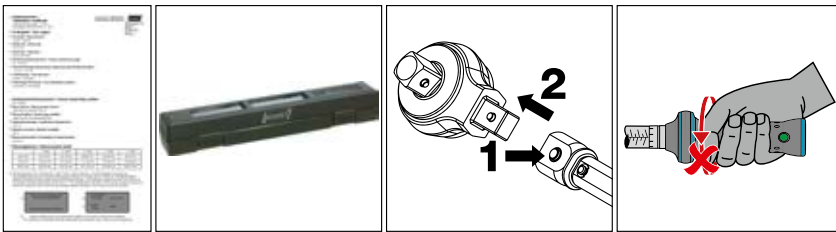

HAZET No.	Output	l mm	l_1 mm	l_2 mm	a mm	b mm	Release accuracy tolerance %	Nm	Nm	Nm	EAN-No. 4000896+
6290-1 CT	<input type="checkbox"/> 9x12	306	252	30	17	22	2	5–60	0.5	1.8–23.1	026043
6291-2 CT	<input type="checkbox"/> 9x12	389	318	30	18	23	2	20–120	1	5.9–36.6	026104
6291-1 CT	<input type="checkbox"/> 14x18	401	330	38.5	23	30	2	20–120	1	5.5–34.5	026074
6292-1 CT	<input type="checkbox"/> 14x18	511	440	38.5	23	30	2	40–200	1	8.5–44.8	026135
6293-1 CT	<input type="checkbox"/> 14x18	625	554	38.5	23	30	2	60–320	2	10.3–56.8	026173
• Torque wrench with DAKKS calibration certificate											
6290-1 CT CAL	<input type="checkbox"/> 9x12	306	252	30	17	22	2	5–60	0.5	1.8–23.1	193097
6291-2 CT CAL	<input type="checkbox"/> 9x12	389	318	30	18	23	2	20–120	1	5.9–36.6	193257
6291-1 CT CAL	<input type="checkbox"/> 14x18	401	330	38.5	23	30	2	20–120	1	5.5–34.5	193264
6292-1 CT CAL	<input type="checkbox"/> 14x18	511	440	38.5	23	30	2	40–200	1	8.5–44.8	193271
6293-1 CT CAL	<input type="checkbox"/> 14x18	625	554	38.5	23	30	2	60–320	2	10.3–56.8	193288

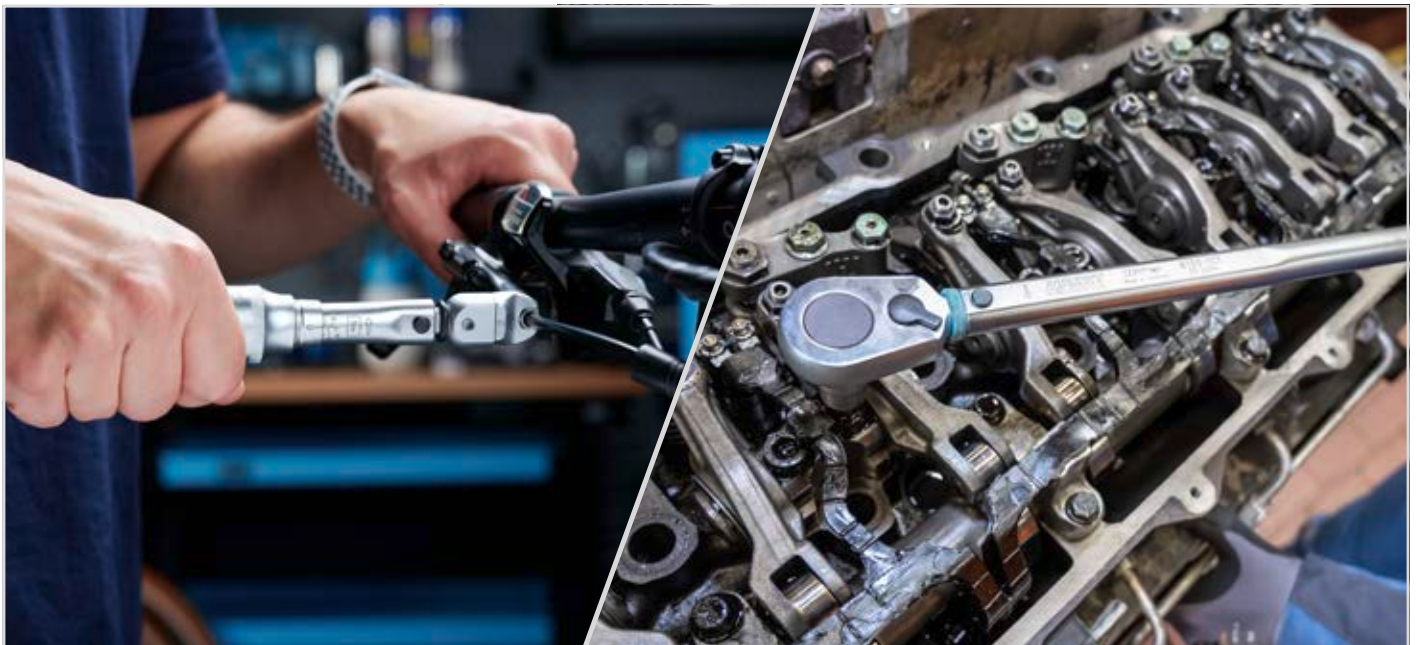



Torque technology

SYSTEM 6000 CT



6200-1 CT Torque wrench · SYSTEM 6000CT · ± 2% accuracy · 100–500 Nm

Made in Germany

- Plug connection to hold insert tools
- **Accuracy ± 2% of the scale value** (in direction of actuation)
Can be used for right-hand and left-hand threads by turning the insert tool
- Safety:
 - Haptic (close-gap release)
 - Audible („click“ sound)
- With calibration certificate and serial number
- Easy and safe adjustment of the desired torque value by turning the handle
- Secure storage in safe box with display window
- **2-component handle** for improved feel
- Simplified locking for adjusting the torque value
- Viewing window for visual checking of the locking
- Knob for additionally locking the set value
- 4 coloured coding rings (red, yellow, green, black) for markings in the case of personalisation or special workflows
- DIN EN ISO 6789-2:2017

14 x 18 (E)

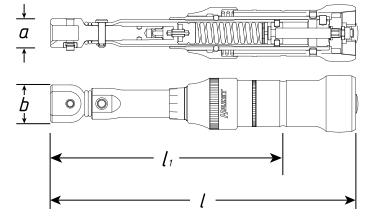

HAZET No.	Output	l mm	l_1 mm	l_2 mm	b mm	Release accuracy tolerance %	Nm			EAN-No. 4000896+
6294-1 CT	<input type="checkbox"/> 14x18	718	649	44	35.5	2	100–400	2.5	14.7–59.9	026197
6295-1 CT	<input type="checkbox"/> 14x18	962	893	44	35.5	2	200–500	2.5	21.8–55.1	026203
• Torque wrench with DAkkS calibration certificate										
6294-1 CT CAL	<input type="checkbox"/> 14x18	718	649	44	35.5	2	100–400	2.5	14.7–59.9	193103
6295-1 CT CAL	<input type="checkbox"/> 14x18	962	893	44	35.5	2	200–500	2.5	21.8–55.1	193110





6290 Torque tool set

Made in Germany

- Sheet metal box (HAZET blue)
- 2-component soft foam insert

9 x 12

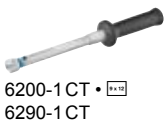

HAZET No.	L x W x H mm		EAN-No. 4000896+
6290-1 CT/29	435x215x62	29	026067

6292 Torque tool set

Made in Germany

- Sheet metal box (HAZET blue)
- 2-component soft foam insert

14 x 18



HAZET No.	L x W x H mm		EAN-No. 4000896+
6292-1 CT/28	578x235x88	28	026166

6400 Insert tool set

Made in Germany

6.3 1/4 10 3/8 125 1/2 14 x 18 9 x 12

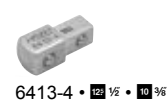

HAZET No.		EAN-No. 4000896+
6400 CD/29	29	233458

Wear? – No problem!

- HAZET tools are manufactured to the **highest quality**. During long intensive loading there is a certain level of wear even for high-quality tools.
- For this reason, there are spare parts and replacement sets available for many of our tools.

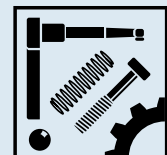

Please also see our spare parts shop
www.hazet.de/ersatzteil-shop

**Cost-saving – Sustainable –
Resource-saving!**
For long-term pleasure with
your HAZET tools



6100 Replacement set

Made in Germany



HAZET No.	EAN-No. 4000896+
<ul style="list-style-type: none"> • Replacement set for twist lock consisting of: twist lock · lock spring and threaded pin For HAZET torque wrenches model year 2014 → 6132-1CT · 6143-1CT · 6144-1CT · 6145-1CT · 6150-1CT · 6160-1CT · 6170-1CT · 6243-1CT · 6244-1CT · 6245-1CT · 6146-1CT · 6246-1CT · 6294-1CT · 6295-1CT · 6296-1CT 	
6144-02/3	192557
<ul style="list-style-type: none"> • Replacement set for shift lever consisting of: shift lever · screws · ball · compression spring For HAZET reversible ratchet 1016 · 1016/2 For HAZET torque wrench 5143-3CT · 5145-3CT · 6132-1CT · 6143CT · 6143-1CT · 6144CT · 6144-1CT · 6145CT · 6145-1CT · 6146-1CT 	
1016/6	001972
<ul style="list-style-type: none"> • Replacement set for ratchet wheel 20 = 3/4" consisting of: ratchet wheel · pawl · shift lever · screws · ball · compression spring For HAZET reversible ratchet 1016 · 1016/2 For HAZET torque wrench 5145-3CT · 6132-1CT · 6143CT · 6143-1CT · 6144CT · 6144-1CT · 6145CT · 6145-1CT · 6146-1CT 	
1016/8N	001989
<ul style="list-style-type: none"> • Replacement set for shift lever consisting of: shift lever · screws · ball · compression spring For HAZET reversible ratchet 1116 For HAZET torque wrench 6150-1CT · 6160-1CT · 6170-1CT · 7250-2 sTAC · 7250-5 sTAC 	
1116/6	003228
<ul style="list-style-type: none"> • Replacement set for ratchet wheel 25 = 1" consisting of: shift lever · screws · ball · compression spring · pawl · ratchet wheel For HAZET reversible ratchet 1116 For HAZET torque wrench 6160-1CT · 6170-1CT 	
1116/8N	003235
<ul style="list-style-type: none"> • Replacement set for shift lever consisting of: shift lever · screws · ball · compression spring · pawl For HAZET reversible ratchet 8816G · 8816GK · 8816P · 8816S · 8816ST · 916K · 2264-1 For HAZET torque wrench 5110-2CT · 5120-2CT · 5110-3CT · 5111-3CT · 5120-3CT · 6110CT · 6110-1CT · 6111-1CT · 6114-1CT · 6115-1CT · 6402-1 · 6402-1S · 6408-1 	
8816 P/6	144617
<ul style="list-style-type: none"> • Replacement set for ratchet wheel 10 = 3/8" consisting of: ratchet wheel · pawl · shift lever · screws · ball · compression spring For HAZET reversible ratchet 8816G · 8816GK · 8816P · 8816ST For HAZET torque wrench 5110-2CT · 5110-3CT · 5111-3CT · 6110CT · 6110-1CT · 6111-1CT · 6114-1CT · 6115-1CT · 6402-1 	
8816 P/7N	042234
<ul style="list-style-type: none"> • Replacement set for shift lever · complete 12.5 = 1/2" consisting of: ratchet wheel · pawl · shift lever · screws · ball · compression spring · spring washer · circlip For HAZET torque wrench 5121-2CT · 5122-2CT · 5123-2CT · 5121-3CT · 5122-3CT · 5123-3CT · 5121-2CLT · 5122-2CLT · 5123-2CLT · 5128-2CLT · 5122ST-1 · 6121CT · 6122CT · 6123CT · 6121-1CT · 6122-1CT · 6123-1CT · 6127-1CT · 6128-1CT · 6722TAC 	
6122/9N	025343
<ul style="list-style-type: none"> • Replacement set for ratchet wheel 12.5 = 1/2" consisting of: ratchet wheel · pawl · shift lever · screws · ball · compression spring For torque wrench HAZET 5120-2CT · 5120-3CT 	
5120/7	235490
<ul style="list-style-type: none"> • Replacement set for ratchet wheel 12.5 = 1/2" consisting of: ratchet wheel · pawl · shift lever · screws · ball · compression spring For torque wrench HAZET 5143-3CT 	
5143/8	237142
<ul style="list-style-type: none"> • Replacement set for ratchet wheel 20 = 3/4" consisting of: ratchet wheel · pawl · shift lever · screws · ball · compression spring For 6150-1CT · 7250-2 sTAC · 7250-5 sTAC 	
6150/8	151431
<ul style="list-style-type: none"> • Replacement set for shift lever consisting of: shift lever · screws · ball · compression spring For HAZET torque wrench 5107-2CT · 5107-3CT · 5108-2CT · 5108-3CT · 6106-1CT · 6108-1CT · 6109-1CT · 6109-2CT · 6401-1 · 6401-1S · 6408 	
6401-1/6	146048

6100 Replacement set

HAZET No.	EAN-No. 4000896+
<ul style="list-style-type: none"> • Replacement set for ratchet wheel 6.3 = 1/4" consisting of: ratchet wheel · pawl · shift lever · screws · ball · compression spring For HAZET torque wrench 5107-2CT · 5107-3CT · 5108-2CT · 5108-3CT · 6106-1CT · 6108-1CT · 6109-1CT · 6109-2CT · 6401-1 	
6401/7	111169
<ul style="list-style-type: none"> • Replacement set for ratchet wheel 6.3 = 1/4" consisting of: ratchet wheel with safety lock · pawl · shift lever · screws · ball · compression spring For 6401-1S as well as for retrofitting insert reversible ratchets 5107-2CT · 5107-3CT · 5108-2CT · 5108-3CT · 6106-1CT · 6108-1CT · 6109-2CT 	
6401-1S/7	111152
<ul style="list-style-type: none"> • Replacement set for shift lever consisting of: shift lever · screws · ball · compression spring · spring washer and circlip For HAZET insert reversible ratchet 6403-1 · 6403-1S · 6404-1 · 6404-1S 	
6403-1/7	070756
<ul style="list-style-type: none"> • Replacement set for ratchet wheel 12.5 = 1/2" consisting of: ratchet wheel · pawl · shift lever · screws · ball · compression spring · spring washer · circlip For 6403-1 · 6404-1 	
6403-1/9	070749
<ul style="list-style-type: none"> • Replacement set for ratchet wheel 12.5 = 1/2" consisting of: ratchet wheel with safety lock · pawl · shift lever · screws · ball · compression spring · spring washer · circlip For 6403-1S · 6404-1S 	
6403-1S/9	070817
<ul style="list-style-type: none"> • Replacement set for twist lock consisting of: lock spring · twist lock with 2 headless screws For HAZET torque wrench 6010-1CT · 6110-1CT · 6114-1CT · 6290-1CT 	
6110-2/7	025053
<ul style="list-style-type: none"> • Replacement set for twist lock consisting of: lock spring · twist lock with 2 headless screws For HAZET torque wrench 5121-2CLT · 5122-2CLT · 5123-2CLT · 5128-2CLT · 6021-1CT · 6022-1CT · 6023-1CT · 6111-1CT · 6115-1CT · 6121-1CT · 6122-1CT · 6123-1CT · 6127-1CT · 6128-1CT · 6291-1CT · 6292-1CT · 6293-1CT · 6722TAC · 6291-2CT 	
6122-2/7	025299
<ul style="list-style-type: none"> • Replacement set for visual signal transmitter consisting of: red button · compression spring · housing · black · pin · screw For HAZET torque wrench 6021-1CT · 6022-1CT · 6023-1CT · 6110CT · 6110-1CT · 6111-1CT · 6114-1CT · 6115-1CT · 6121CT · 6121-1CT · 6122CT · 6122-1CT · 6123CT · 6123-1CT · 6127-1CT · 6128-1CT · 6291-1CT · 6291-2CT · 6290-1CT · 6291CT · 6292-1CT · 6293-1CT 	
6122-2/9	025305
<ul style="list-style-type: none"> • Replacement set for shift lever consisting of: shift lever · screws · ball · compression spring · spring washer · circlip For HAZET torque wrench 5121-2CLT · 5121-2CT · 5121-3CT · 5122-2CLT · 5122-2CT · 5122-3CT · 5122ST-1 · 5123-2CLT · 5123-2CT · 5123-3CT · 5128-2CLT · 6121-1CT · 6121CT · 6122-1CT · 6122CT · 6123-1CT · 6123CT · 6127-1CT · 6128-1CT · 6722TAC 	
6122/7	025329
<ul style="list-style-type: none"> • Reversible ratchet with screw complete replaceable: ■ 20 = 3/4" model year → End 2004 For HAZET torque wrench 6132-1CT · 6143CT · 6143-1CT · 6144CT · 6144-1CT · 6145CT · 6145-1CT · 6146-1CT 	
6143-01	111190
<ul style="list-style-type: none"> • Replacement set for twist lock consisting of: twist lock · lock spring and cylinder screw For HAZET torque wrench model year → 2013 6132-1CT · 6143-1CT · 6144-1CT · 6145-1CT · 6150-1CT · 6160-1CT · 6170-1CT · 6243-1CT · 6244-1CT · 6245-1CT · 6146-1CT · 6246-1CT · 6294-1CT · 6295-1CT · 6296-1CT 	
6144-01/3	025527
<ul style="list-style-type: none"> • Reversible ratchet with screw complete replaceable: ■ 20 = 3/4" model year 2005→ For HAZET torque wrench 5145-3CT · 6132-1CT · 6144CT · 6144-1CT · 6145CT · 6145-1CT · 6146-1CT 	
6145-01	111206



SYSTEM 7000 sTAC

7000 sTAC Torque wrench with built-in angle gauge · electronic · SmartTAC SYSTEM 7000 sTAC · 1–1000 Nm

Made in Germany

• **Smart technology – Ready for Industry 4.0**

• HAZET Smart technology consisting of the SmartTAC app and Bluetooth 4.1 Low Energy interface (product group 7000-2sTAC may be subject to national approval restrictions). Smooth live data exchange for displaying the screwing progress on mobile end devices, such as smartphones (smart watches) and tablet PCs. USB-C interface for programming torque wrenches with built-in angle gauge and documenting the screwing data via laptop and PC with the software SmartTAC tool 7910-sTAC.

- All sTAC torque wrenches with built-in angle gauges can also be used autonomously, without SmartTAC app
- Unique ergonomic, user-oriented HAZET design of entire tool for professional use
- The reduction in size and integration of the PCB into the main pipe results in dimensions that allow for the small torque wrench with built-in angle gauge from 1 Nm
- Protection rating IP 40
- Splash-proof display and membrane keyboard
- USB-C port to directly charge battery when still in tool
- Including standard replaceable Li ion rechargeable battery, type 14650 / 3.7 Volt, can be charged directly on the tool via USB-C connector
- Including 1 metre USB 3.1 / A-C cable

Functions: 7000 sTAC

- Large, high-contrast illuminated, easily readable OLED display, dimmable and 180° rotatable
- Indication of the measuring values in 13 mm font size, including a rating of the screw-joint (OK / not OK)
- Display deviation in right and left torque: from $\pm 1\%$ / ± 1 digit
- Display deviation in right and left rotation angle: $\pm 1\%$ / $\pm 1^\circ$
- Rotation angle range adding: 0 to 999°
- Torque tolerance for OK display (green): adjustable ± 1 to 10%
- Rotation angle tolerance for OK display (green): adjustable 1 to 90°
- Choice of torque measuring units: Nm, lbf ft, lbf in or kgf m
- Lets you select or program the effective length for other insert tools from 0 to 250 m (requirement for correct torque / rotation angle measurements)

- Four signals alert the user during screwing process: audible signal (buzzer), vibration signal, synchronous numerical display, and a 360° LED display with „traffic light function“ that is visible from all around
- Threshold value, pre-warning level: adjustable 50 to 99%
- Adjustable signaling, On/Off audible signal (buzzer) and vibration
- Reset function, restore to factory setting
- Stand-by time: adjustable 1 to 10 minutes
- Indication of battery condition and memory
- Memory capacity, including date and time: up to 3000 measurements
- Offers possibility to program flow charts and sets of parameters: 25 and 25
- 2 control functions: programmable torque control for angle tightening and angle control for torque tightening
- Menu locking against unintentional change, four-digit code is personally selected
- Display of the software version with serial numbers, calibration date and service display / usage counter
- Menu languages: German, English, French, Italian, Chinese
- Programming and evaluation software for laptop and PC 7910-sTAC (at additional cost)
- SmartTAC app for Android and Apple iOS end devices for series 7000-2 sTAC (free download)
- The SmartTAC torque wrenches with built-in angle gauge of the **7000-2 sTAC series with Bluetooth interface** have valid radio approval in all EU countries as well as in Switzerland, Norway, China, India, South Korea, Mexico and Turkey and may be sold there. Other countries on request
- For all other countries without radio licences, we offer the SmartTAC torque wrench with built-in angle gauge of the **7000-5 sTAC series without a Bluetooth interface**. These can be connected to a laptop and PC via a USB port and to the optional programming and evaluation software. It is not possible to use the SmartTAC app for mobile devices due to the lack of a Bluetooth interface
- **With Bluetooth function**
- Tested in accordance with DIN EN ISO 6789-2:2017, VDI / VDE 2648, Sheet 2



SYSTEM 7000 sTAC





Torque technology

SYSTEM 7000 sTAC



7000 STAC Torque wrench with built-in angle gauge · electronic · SmartTAC SYSTEM 7000 sTAC · 1–1000 Nm

HAZET No.	Output	l mm	l ₂ mm	Release accuracy tolerance %	lbf.ft.	Nm		Bluetooth interface	EAN-No. 4000896+
<ul style="list-style-type: none"> Includes insert reversible ratchet 6401-1 ■ 6.3 = 1/4" Length with/without insert tool: 290.5 mm / 260 mm 									
7280-5 STAC	□ 9x12, ■ 6.3 = 1/4"	260	17.5	2	0.75–7.5	1–10	0.5–4.6	✗	223183
7281-5 STAC	□ 9x12, ■ 6.3 = 1/4"	260	19.5	2	1.85–18.5	2.5–25	1.1–11.4	✗	223176
<ul style="list-style-type: none"> Includes insert reversible ratchet 6402-1 ■ 10 = 3/8" Length with/without insert tool: 347 mm / 302 mm 									
7290-5 STAC	□ 9x12, ■ 10 = 3/8"	302	30	1	3.5–44	5–60	1.8–22.2	✗	223169
<ul style="list-style-type: none"> Includes insert reversible ratchet 6402-1 ■ 10 = 3/8" Length with/without insert tool: 428 mm / 383 mm 									
7291-5 STAC	□ 9x12, ■ 10 = 3/8"	383	30	1	7.5–75	10–100	2.9–28.7	✗	223152
<ul style="list-style-type: none"> Includes insert reversible ratchet 6404-1 ■ 12.5 = 1/2" Length with/without insert tool: 578.5 mm / 520 mm 									
7292-5 STAC	□ 14x18, ■ 12.5 = 1/2"	520	38.5	1	15–150	20–200	4.1–40.7	✗	223145
<ul style="list-style-type: none"> Includes insert reversible ratchet 6406 ■ 20 = 3/4" Length with/without insert tool: 1021 mm / 945 mm 									
7294-5 STAC	□ 14x18, ■ 20 = 3/4"	945	44	1	30–300	40–400	4.4–43.8	✗	223138
<ul style="list-style-type: none"> Includes insert reversible ratchet 6406 ■ 20 = 3/4" Length with/without insert tool: 1217 mm / 1141 mm 									
7295-5 STAC	□ 14x18, ■ 20 = 3/4"	1141	44	1	48–480	65–650	5.9–58.7	✗	222926
<ul style="list-style-type: none"> Integrated reversible ratchet ■ 20 = 3/4" 									
7250-5 STAC	■ 20 = 3/4"	1772	–	1	150–750	200–1000	12.2–60.8	✗	222919
<ul style="list-style-type: none"> Includes insert reversible ratchet 6401-1 ■ 6.3 = 1/4" Length with / without insert tool: 290.5 mm / 260 mm 									
7280-2 STAC	□ 9x12, ■ 6.3 = 1/4"	260	17.5	2	0.75–7.5	1–10	0.5–4.6	✓	215294
7281-2 STAC	□ 9x12, ■ 6.3 = 1/4"	260	19.5	2	1.85–18.5	2.5–25	1.1–11.4	✓	215317
<ul style="list-style-type: none"> Includes insert reversible ratchet 6402-1 ■ 10 = 3/8" Length with / without insert tool: 347 mm / 302 mm 									
7290-2 STAC	□ 9x12, ■ 10 = 3/8"	302	30	1	3.5–44	5–60	1.8–22.2	✓	215324
<ul style="list-style-type: none"> Includes insert reversible ratchet 6402-1 ■ 10 = 3/8" Length with / without insert tool: 428 mm / 383 mm 									
7291-2 STAC	□ 9x12, ■ 10 = 3/8"	383	30	1	7.5–75	10–100	2.9–28.7	✓	215430
<ul style="list-style-type: none"> Includes insert reversible ratchet 6404-1 ■ 12.5 = 1/2" Length with / without insert tool: 578.5 mm / 520 mm 									
7292-2 STAC	□ 14x18, ■ 12.5 = 1/2"	520	38.5	1	15–150	20–200	4.1–40.7	✓	215447
<ul style="list-style-type: none"> Includes insert reversible ratchet 6406 ■ 20 = 3/4" Length with / without insert tool: 1021 mm / 945 mm 									
7294-2 STAC	□ 14x18, ■ 20 = 3/4"	945	44	1	30–300	40–400	4.4–43.8	✓	215454
<ul style="list-style-type: none"> Includes insert reversible ratchet 6406 ■ 20 = 3/4" Length with / without insert tool: 1217 mm / 1141 mm 									
7295-2 STAC	□ 14x18, ■ 20 = 3/4"	1141	44	1	48–480	65–650	5.9–58.7	✓	215461
<ul style="list-style-type: none"> Integrated reversible ratchet ■ 20 = 3/4" 									
7250-2 STAC	■ 20 = 3/4"	1772	–	1	150–750	200–1000	12.2–60.8	✓	215478
<ul style="list-style-type: none"> Torque wrench with DAkkS calibration certificate Includes insert reversible ratchet 6401-1 ■ 6.3 = 1/4" Length with/without insert tool: 290.5 mm / 260 mm 									
7281-2 STAC CAL	□ 9x12, ■ 6.3 = 1/4"	260	19.5	2	1.85–18.5	2.5–25	1.1–11.4	✓	220366
<ul style="list-style-type: none"> Torque wrench with DAkkS calibration certificate Includes insert reversible ratchet 6402-1 ■ 10 = 3/8" Length with/without insert tool: 347 mm / 302 mm 									
7290-2 STAC CAL	□ 9x12, ■ 10 = 3/8"	302	30	1	3.5–44	5–60	1.8–22.2	✓	220373
<ul style="list-style-type: none"> Torque wrench with DAkkS calibration certificate Includes insert reversible ratchet 6402-1 ■ 10 = 3/8" Length with/without insert tool: 428 mm / 383 mm 									
7291-2 STAC CAL	□ 9x12, ■ 10 = 3/8"	383	30	1	7.5–75	10–100	2.9–28.7	✓	220380
<ul style="list-style-type: none"> Torque wrench with DAkkS calibration certificate Includes insert reversible ratchet 6404-1 ■ 12.5 = 1/2" Length with/without insert tool: 578.5 mm / 520 mm 									
7292-2 STAC CAL	□ 14x18, ■ 12.5 = 1/2"	520	38.5	1	15–150	20–200	4.1–40.7	✓	220397
<ul style="list-style-type: none"> Torque wrench with DAkkS calibration certificate Includes insert reversible ratchet 6406 ■ 20 = 3/4" Length with/without insert tool: 1021 mm / 945 mm 									
7294-2 STAC CAL	□ 14x18, ■ 20 = 3/4"	945	44	1	30–300	40–400	4.4–43.8	✓	220403
<ul style="list-style-type: none"> Torque wrench with DAkkS calibration certificate Includes insert reversible ratchet 6406 ■ 20 = 3/4" Length with/without insert tool: 1217 mm / 1141 mm 									
7295-2 STAC CAL	□ 14x18, ■ 20 = 3/4"	1141	44	1	48–480	65–650	5.9–58.7	✓	220410
<ul style="list-style-type: none"> Torque wrench with DAkkS calibration certificate Integrated reversible ratchet ■ 20 = 3/4" 									
7250-2 STAC CAL	■ 20 = 3/4"	1772	–	1	150–750	200–1000	12.2–60.8	✓	220342
<ul style="list-style-type: none"> SmartTAC Tool · SmartTAC programming and evaluation software for HAZET torque wrench with built-in angle gauge of the 7000 sTAC series 									
7910-STAC	–	–	–	–	–	–	–	–	221875



Torque screwdrivers

6001 Torque screwdriver · 6001 · 0.4–5.4 Nm

Made in Germany

• For all fittings with low torque e.g. disc brakes on bicycles



- Torque release clearly palpable and audible when torque setting is reached by ratcheting
- Loosening without torque function possible
- Fast and precise setting of torque values with hex-head wrench (HAZET 2100-06, included in delivery)
- Insert tool holder for bits with magnet for all bits with drive or HAZET Adapter 2304 for connecting to HAZET 850 sockets
- Accuracy (tolerance) according to EN ISO 6789
- Contents:
Torque handle with insert tool holder for bits 2239-7, offset screwdriver 2100-06
- Plastic handle



HAZET No.	Output	l mm	Release accuracy tolerance %	Nm		EAN-No. 4000896+
• For all screw connections with low torque e.g. valve cores on tyre pressure control systems						
• For tightening torques from 0.4 to 1.4 Nm						
6001-1.4/3	○ 6.3 = 1/4"	–	15	0.4–1.4	3	190980
• For tightening torque values from 0.6 up to 1.5 Nm						
6001-1.5/3	○ 6.3 = 1/4"	–	10	0.6–1.5	3	141678
• According to VW Service Information e.g. for the fastening screws at the air-filter housing on 1.4 l engine with turbocharger on VW Eos, Golf, Golf Plus and Passat						
6001-3.0/3	○ 6.3 = 1/4"	–	6	1.5–3	3	141685
6001-5.4/3	○ 6.3 = 1/4"	–	6	3–5.4	3	141692
• Adapter ● 6.3 = 1/4" → ■ 6.3 = 1/4"						
2304 N	–	25	–	–	–	238071

6000 CT Torque screwdriver · SYSTEM 6000CT · ± 5% accuracy · 0.1–6 Nm

- Accuracy ± 5% of the scale value (in direction of actuation)
- For bits with 6.3 = 1/4" outside hexagon drive
- Operation of sockets (drive 6.3 = 1/4") with HAZET 2304 adapter
- Plastic handle
- DIN EN ISO 6789

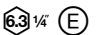

HAZET No.	Output	l mm	Release accuracy tolerance %	Nm	cNm	Nm	EAN-No. 4000896+
6002 CT	○ 6.3 = 1/4"	170	5	0.1–1.2	10–120	0.01	023004
6003 CT	○ 6.3 = 1/4"	230	5	1–6	100–600	0.1	023011
• Adapter ● 6.3 = 1/4" → ■ 6.3 = 1/4"							
2304 N	–	25	–	–	–	–	238071



SYSTEM 6300 CT

- **With lockable torque setting**

- Especially suitable for application in industrial series production

Setting the desired torque value with adjustment wrench 6399 together with HAZET torque tester 7901 E, 7902 E, 7903 E or any other suitable device.

All wrenches of this series (HAZET 6391 to 6392) are without a scale

6300 Torque wrench · ±2% accuracy · 6391-10 6% · 1–12 Nm

Made in Germany

- Particularly easy to use thanks to short design

- Universal application thanks to connection for insert tools

- **Accuracy ± 2% (6391-10: 6%) of the scale value** (in direction of actuation)

Can be used for right-hand and left-hand threads by turning the insert tool

- Plug-and-socket connection to hold insert tools

- **Permanently adjustable value**

- Especially suitable for application in industrial series production

- Adjustment of the desired torque value with adjustment wrench 6399 together with HAZET torque tester 7901E · 7902E · 7903E or any other suitable device.

All wrenches of this series (HAZET 6391-6392) are without a scale

- With calibration certificate and serial number

- DIN EN ISO 6789-2:2017

9 x 12 E

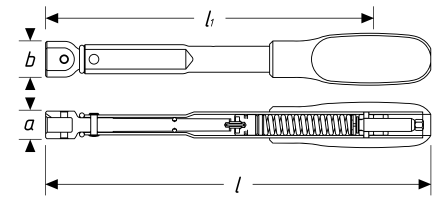

HAZET No.	Output	l mm	l_1 mm	l_2 mm	a mm	b mm	Release accuracy tolerance %	Nm		EAN-No. 4000896+
6391-10	□ 9x12	124	102	19.5	17	22	6	1–10	0.8–8.4	208951
6391-12	□ 9x12	124	102	19.5	17	22	2	2–12	1.7–10.1	027026
• Factory preset triggering value as requested										
6391-12V	□ 9x12	124	102	–	17	22	2	2–12	1.7–10.1	145850

6300 Torque wrench · ±2% accuracy · 2–35 Nm

Made in Germany

- **Accuracy ± 2% (6391-10: 6%) of the scale value** (in direction of actuation)

Can be used for right-hand and left-hand threads by turning the insert tool

- Plug-and-socket connection to hold insert tools

- **Permanently adjustable value**

- Especially suitable for application in industrial series production

- Adjustment of the desired torque value with adjustment wrench 6399 together with HAZET torque tester 7901E · 7902E · 7903E or any other suitable device

- **All wrenches of this series (HAZET 6391-6392) are without a scale**

- With calibration certificate and serial number

- DIN EN ISO 6789-2:2017

9 x 12 E

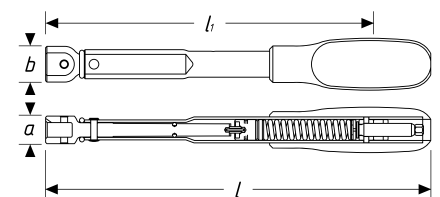

HAZET No.	Output	l mm	l_1 mm	l_2 mm	a mm	b mm	Release accuracy tolerance %	Nm		EAN-No. 4000896+
6391-25	□ 9x12	183	143	30	17	22	2	2–25	1.2–14.7	027040
6391-35	□ 9x12	183	143	30	17	22	2	15–35	8.8–20.6	027057
• Factory preset triggering value as requested										
6391-25V	□ 9x12	183	143	–	17	22	2	2–25	1.2–14.7	145867
6391-35V	□ 9x12	183	143	–	17	22	2	15–35	8.8–20.6	145874





6300 Torque wrench · ±2% accuracy · 5–85 Nm

Made in Germany

- Accuracy ± 2% (6391-10: 6%) of the scale value (in direction of actuation)
Can be used for right-hand and left-hand threads by turning the insert tool
- Plug-and-socket connection to hold insert tools
- **Permanently adjustable value**
- Especially suitable for application in industrial series production
- Adjustment of the desired torque value with adjustment wrench 6399 together with HAZET torque tester 7901E · 7902E · 7903E or any other suitable device
- **All wrenches of this series (HAZET 6391-6392) are without a scale**
- With calibration certificate and serial number
- DIN EN ISO 6789-2:2017

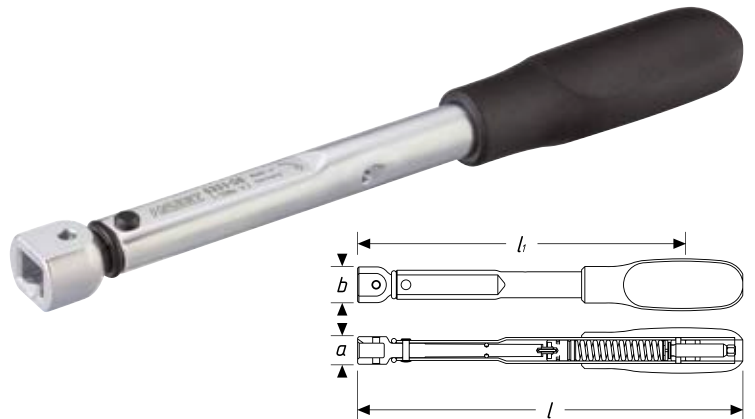
9 x 12 (E)



HAZET No.	Output	l mm	l ₁ mm	l ₂ mm	a mm	b mm	Release accuracy tolerance %	Nm		EAN-No. 4000896+
6391-50	□ 9x12	241	201	30	17	22	2	5–50	2.2–22.1	027064
6391-85	□ 9x12	316	276	30	17	22	2	15–85	5.0–28.3	027071
• Factory preset triggering value as requested										
6391-50 V	□ 9x12	241	201	–	17	22	2	5–50	2.2–22.1	145881
6391-85 V	□ 9x12	316	276	–	17	22	2	15–85	5.0–28.3	145898

6300 Torque wrench · ±2% accuracy · 50–320 Nm

Made in Germany

- Accuracy ± 2% (6391-10: 6%) of the scale value (in direction of actuation)
Can be used for right-hand and left-hand threads by turning the insert tool
- Plug-and-socket connection to hold insert tools
- **Permanently adjustable value**
- Especially suitable for application in industrial series production
- Adjustment of the desired torque value with adjustment wrench 6399 together with HAZET torque tester 7901E · 7902E · 7903E or any other suitable device
- **All wrenches of this series (HAZET 6391-6392) are without a scale**
- With calibration certificate and serial number
- DIN EN ISO 6789-2:2017

14 x 18 (E)

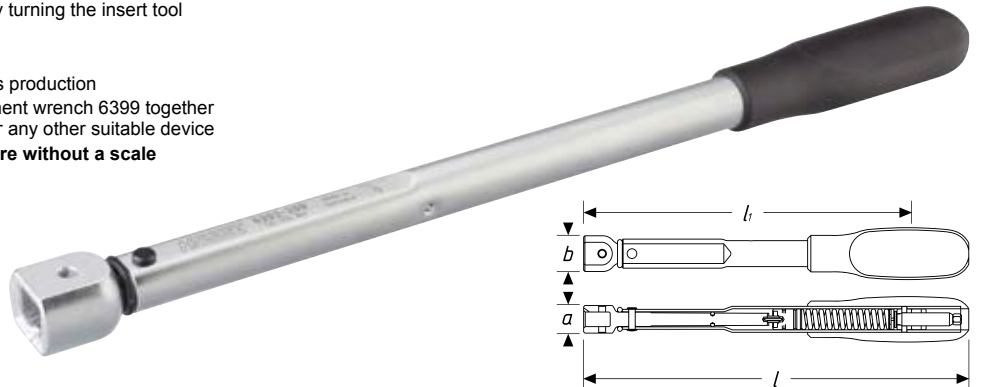

HAZET No.	Output	l mm	l ₁ mm	l ₂ mm	a mm	b mm	Release accuracy tolerance %	Nm		EAN-No. 4000896+
6392-200	□ 14x18	401	359	38.5	23	30	2	50–200	12.8–51.4	027118
6392-320	□ 14x18	631	589	38.5	23	30	2	60–320	9.8–52.0	027125
• Factory preset triggering value as requested										
6392-200 V	□ 14x18	401	359	–	23	30	2	50–200	12.8–51.4	145904
6392-320 V	□ 14x18	631	589	–	23	30	2	60–320	9.8–52.0	145911

6399 Adjustment wrenches

Made in Germany

- For torque wrenches HAZET 6391 to 6392 (V)



HAZET No.	l mm	EAN-No. 4000896+
6399	167	027170



Insert tools

6396 Tool holder

Made in Germany

• Forged from solid steel

9 x 12 14 x 18

- Plug-and-socket connection to accommodate insert tools
- Without any torque function



HAZET No.	Output	l mm	EAN-No. 4000896+
6396	□ 9x12	405	027132
6397	□ 14x18	635	027149

6602 Insert reversible ratchet

Made in Germany

- 40 teeth · operating angle 9°
- Maximum 200 Nm (6602-1) maximum 320 Nm (6604-1)
- Surface: chrome-plated
- DIN 3120, ISO 1174-1

10 3/8 12.5 1/2 14 x 18

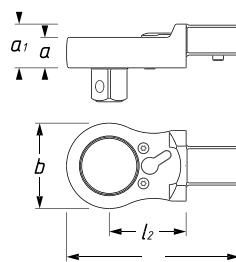

HAZET No.	Drive	Output	l mm	l ₂ mm	a mm	a ₁ mm	b mm	EAN-No. 4000896+
6602-1	■ 14x18	■ 10 = 3/8"	81	36	14.3	20.5	40	179695
6604-1	■ 14x18	■ 12.5 = 1/2"	81	36	14.3	20.5	40	179701

6401-1 Insert reversible ratchet

Made in Germany

6.3 1/4 10 3/8 12.5 1/2 9 x 12 14 x 18 (E)

- 6401-1 20 teeth · operating angle 18° – maximum 40 Nm
- 6402-1 30 teeth · operating angle 12° – maximum 120 Nm
- 6403-1 32 teeth · operating angle 11.25° – maximum 120 Nm
- 6404-1 32 teeth · operating angle 11.25° – maximum 300 Nm

- Drop forged
- Surface: chrome-plated
- DIN 3120, ISO 1174-1

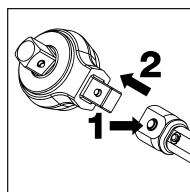

HAZET No.	Drive	Output	l mm	l ₂ mm	a mm	b mm	EAN-No. 4000896+
6401-1	■ 9x12	■ 6.3 = 1/4"	46.5	19.5	9.9	21.8	027439
6402-1	■ 9x12	■ 10 = 3/8"	61	30	15	30	027460
6403-1	■ 9x12	■ 12.5 = 1/2"	74.5	38.5	19.6	40	027521
6404-1	■ 14x18	■ 12.5 = 1/2"	83.5	38.5	19.6	40	027552

6401 Insert reversible ratchet

Made in Germany

- Fine tooth, 72 teeth · Operating angle 5°
- Drop forged
- Surface: chrome-plated
- DIN 3120, ISO 1174-1

6.3 1/4 10 3/8 12.5 1/2

20 3/4 9 x 12 14 x 18

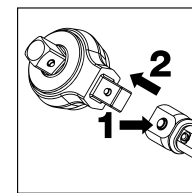
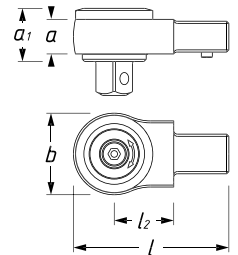

HAZET No.	Drive	Output	l mm	l ₂ mm	a mm	a ₁ mm	b mm	EAN-No. 4000896+
6401 N	■ 9x12	■ 6.3 = 1/4"	46	17.5	11	16.5	25	115204
6402	■ 9x12	■ 10 = 3/8"	58.5	26	14.5	22.7	34.5	027453
6403	■ 9x12	■ 12.5 = 1/2"	58.5	26	14.5	22.5	34.5	027514
6404	■ 14x18	■ 12.5 = 1/2"	70.5	27	15.7	24.1	37	027545
6406	■ 14x18	■ 20 = 3/4"	101	44	24	35.6	64	027576

6401 S Insert reversible ratchet

Made in Germany

• Quick-release safety lock

6.3 1/4 10 3/8 12.5 1/2

9 x 12 14 x 18 (E)

- 6401-1S 20 teeth · operating angle 18°
- 6402-1S 30 teeth · operating angle 12°
- 6403-1S 32 teeth · operating angle 11.25°
- 6404-1S 32 teeth · operating angle 11.25°

- Drop forged
- Surface: chrome-plated
- DIN 3120, ISO 1174-1

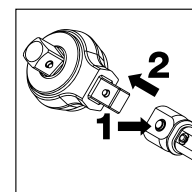
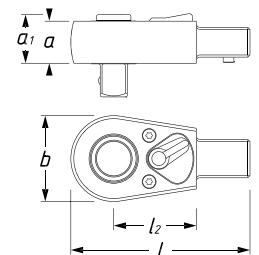

HAZET No.	Drive	Output	l mm	l ₂ mm	a mm	a ₁ mm	b mm	EAN-No. 4000896+
6401-1S	■ 9x12	■ 6.3 = 1/4"	46.5	19.5	9.9	12.2	21.8	027446
6402-1S	■ 9x12	■ 10 = 3/8"	61	30	15	17.2	30	027477
6403-1S	■ 9x12	■ 12.5 = 1/2"	74.5	38.5	19.6	22.7	40	027538
6404-1S	■ 14x18	■ 12.5 = 1/2"	83.5	38.5	19.6	22.7	40	027569



6408 Insert reversible ratchet for bits

Made in Germany

- Screwdriver bit socket
- Drop forged
- Surface: chrome-plated

6.3 1/4" 8 5/16" 9 x 12 E

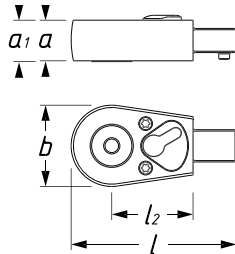
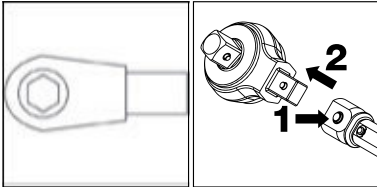

HAZET No.	Drive	Output	l mm	l ₂ mm	a mm	a ₁ mm	b mm	EAN-No. 4000896+
6408	9x12	6.3 = 1/4"	46.5	19.5	9.9	11.7	21.8	027583
6408-1	9x12	8 = 5/16"	61	30	15	15.3	30	027590

Wear? – No problem!

- HAZET tools are manufactured to the highest quality. During long intensive loading there is a certain level of wear even for high-quality tools.
- For this reason, there are spare parts and replacement sets available for many of our tools.

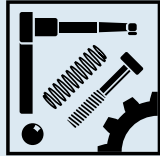

Please also see our spare parts shop
www.hazet.de/ersatzteil-shop

Cost-saving – Sustainable – Resource-saving!
For long-term pleasure with your HAZET tools

8816 Replacement set

Made in Germany

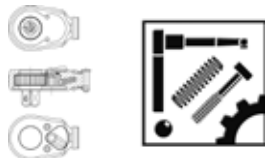

HAZET No.	Drive	Output	l mm	l ₂ mm	a mm	b mm	EAN-No. 4000896+
8816 P/6	10 = 3/8"	10 = 3/8"	43.5	17.5	14	22	027644
8816 P/7 N	10 = 3/8"	12.5 = 1/2"	30.2	-	-	-	048885

8816 Replacement set

HAZET No.	Drive	Output	l mm	l ₂ mm	a mm	b mm	EAN-No. 4000896+
6401-1/6	6.3 = 1/4"	6.3 = 1/4"	46.5	19.5	9.9	11.7	027583
6401-1/7	6.3 = 1/4"	6.3 = 1/4"	46.5	19.5	9.9	11.7	027583
6401-1S/7	6.3 = 1/4"	6.3 = 1/4"	46.5	19.5	9.9	11.7	027583
6403-1/7	6.3 = 1/4"	6.3 = 1/4"	46.5	19.5	9.9	11.7	027583
6403-1/9	6.3 = 1/4"	6.3 = 1/4"	46.5	19.5	9.9	11.7	027583
8816S/7	10 = 3/8"	10 = 3/8"	43.5	17.5	14	22	027644

6413 Insert tool holder with square drives

Made in Germany

10 3/8" 6.3 1/4" 10 3/8" 12.5 1/2" 9 x 12

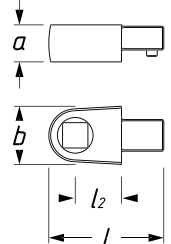
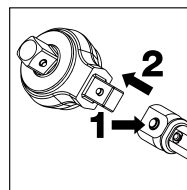

HAZET No.	Drive	Output	l mm	l ₂ mm	a mm	b mm	EAN-No. 4000896+
6413-1	10 = 3/8"	10 = 3/8"	43.5	17.5	14	22	027644
6413-2	6.3 = 1/4"	6.3 = 1/4"	22	-	-	-	048908
6413-3	10 = 3/8"	10 = 3/8"	25	-	-	-	048892
6413-4	10 = 3/8"	12.5 = 1/2"	30.2	-	-	-	048885



Torque technology

Insert tools



6414 Insert square drives

Made in Germany

- Surface: chrome-plated
- DIN 3120, ISO 1174-1

12.5 1/2" 14 x 18

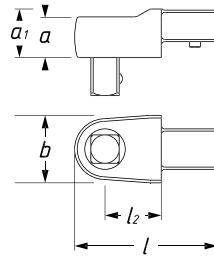
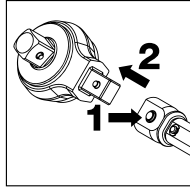

HAZET No.	Drive	Output	l mm	l ₂ mm	a mm	a ₁ mm	b mm	EAN-No. 4000896+
6414	14x18	12.5 = 1/2"	63.5	25	18	21.5	30	027668

6420 Insert tool holder for bits

Made in Germany

- Surface: chrome-plated
- ISO 1173

6.3 1/4" 8 5/16" 9 x 12 14 x 18

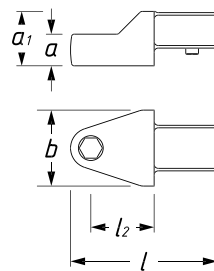
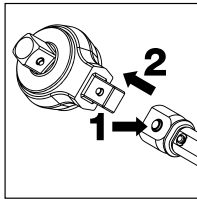

HAZET No.	Drive	Output	l mm	l ₂ mm	a mm	a ₁ mm	b mm	EAN-No. 4000896+
6420 B	9x12	6.3 = 1/4"	40.5	17.5	10	14.5	20	027903
6420 C	9x12	8 = 5/16"	41.5	17.5	12.5	14.5	20	027910
6420 D	14x18	8 = 5/16"	58	25	12.5	21.5	30	027927

6423 Insert adapter

Made in Germany

- Surface: chrome-plated

14 x 18 9 x 12 9 x 12 14 x 18

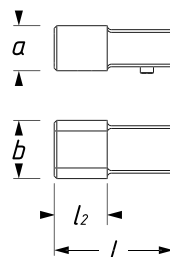
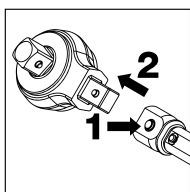

HAZET No.	Drive	Output	l mm	l ₂ mm	a mm	b mm	EAN-No. 4000896+
6423 C	9x12	14x18	50	34	22.9	30	027934
6423 D	14x18	9x12	45	20	17	22	057559

• Amplifier for square insert 9x12 → 14x18

• Reducer for square insert 14x18 → 9x12

6430 Blank-end insert

Made in Germany

- Spring, bolt and cover included in delivery

9 x 12 14 x 18

Caution: when welding-on tools, the release torque values may change. Observe effective lengths (see conversion table on page 301)

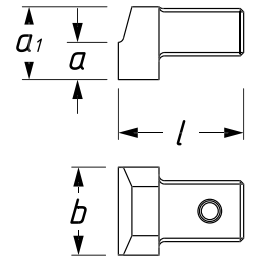
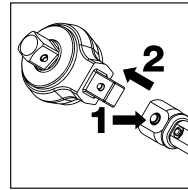

HAZET No.	Drive	l mm	a mm	a ₁ mm	b mm	EAN-No. 4000896+
6430 C	9x12	25	10	14.5	19	027958
6430 D	14x18	38	11	21.5	26	027965

6450 C Insert open-end wrench

Made in Germany

- Surface: chrome-plated

9 x 12

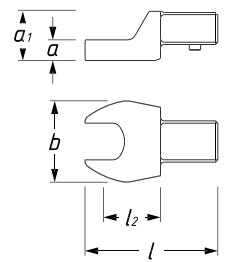
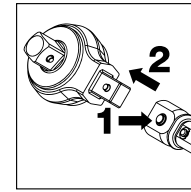

HAZET No.	S mm	Drive	Output	l mm	l ₂ mm	a mm	a ₁ mm	b mm	EAN-No. 4000896+
6450 C-7	7	9x12	●	36.5	17.5	5.5	14.5	20	028429
6450 C-8	8	9x12	●	37	17.5	5.5	14.5	21.5	028436
6450 C-9	9	9x12	●	37.5	17.5	5.5	14.5	23	028443
6450 C-10	10	9x12	●	38	17.5	5.5	14.5	24.5	028320
6450 C-11	11	9x12	●	38.5	17.5	5.5	14.5	26	028337
6450 C-12	12	9x12	●	38.5	17.5	5.5	14.5	27.5	028344
6450 C-13	13	9x12	●	39	17.5	5.5	14.5	29	028351
6450 C-14	14	9x12	●	42	20	7.5	14.5	31	028368
6450 C-15	15	9x12	●	42.5	20	7.5	14.5	33	028375
6450 C-16	16	9x12	●	43	20	7.5	14.5	35	028382
6450 C-17	17	9x12	●	43.5	20	7.5	14.5	37	028399
6450 C-18	18	9x12	●	44	20	7.5	14.5	39	028405
6450 C-19	19	9x12	●	45	20	7.5	14.5	41	028412

6450 D-13	13	14x18	●	56.5	25	7	21.5	30	028450
6450 D-14	14	14x18	●	57	25	7	21.5	32	028467
6450 D-15	15	14x18	●	57.5	25	7	21.5	34	028474
6450 D-16	16	14x18	●	58	25	9	21.5	35.5	028481
6450 D-17	17	14x18	●	58.5	25	9	21.5	37	028498
6450 D-18	18	14x18	●	59	25	9	21.5	39	028504
6450 D-19	19	14x18	●	59.5	25	9	21.5	41	028511
6450 D-21	21	14x18	●	60.5	25	11	21.5	45	028528
6450 D-22	22	14x18	●	61	25	11	21.5	47	028535
6450 D-24	24	14x18	●	62	25	11	21.5	51	028542
6450 D-27	27	14x18	●	68.5	32.5	13	22.5	58.5	028559
6450 D-30	30	14x18	●	70	32.5	13	22.2	63	028566
6450 D-32	32	14x18	●	71.5	32.5	13	22.2	65	028573
6450 D-34	34	14x18	●	73.2	32.5	13	22.2	68.5	050178
6450 D-36	36	14x18	●	70	32.5	13	22.2	67	072507
6450 D-38	38	14x18	●	70	32.5	13	22.2	67	072514
6450 D-41	41	14x18	●	79	40	12.4	22.5	82	028580



6606 D Ratcheting insert box-end wrench

Made in Germany
• Switching function



- 40 teeth · operating angle 9°
- Max.: 320 Nm
- Drop forged
- Deep-set reversing switch prevents unintentional change-over
- Especially for HAZET torque wrenches 6291-1CT – 6293-1CT
- Extra flat design with deep offset allows application in areas with restricted access
- Surface: chrome-plated

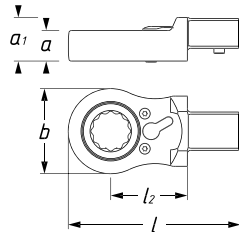

HAZET No.	S mm	Drive	Output	l mm	l ₂ mm	a mm	a ₁ mm	b mm	EAN-No. 4000896+
6606 D-16	16	■ 14x18	●	81	36	14.3	20.5	40	179923
6606 D-17	17	■ 14x18	●	81	36	14.3	20.5	40	179886
6606 D-18	18	■ 14x18	●	81	36	14.3	20.5	40	179893
6606 D-19	19	■ 14x18	●	81	36	14.3	20.5	40	179909
6606 D-21	21	■ 14x18	●	81	36	14.3	20.5	40	179916

6612 C Insert box-end wrench · open

Made in Germany
• Surface: chrome-plated

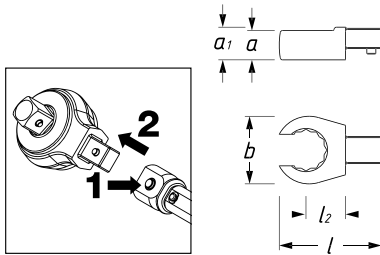

HAZET No.	S mm	Drive	Output	l mm	l ₂ mm	a mm	a ₁ mm	b mm	EAN-No. 4000896+
6612 C-10	10	■ 9x12	●	42.3	17.5	12	14.5	22	028726
6612 C-11	11	■ 9x12	●	42.8	17.5	12	14.5	22.5	028733
6612 C-12	12	■ 9x12	●	43.4	17.5	12	14.5	24	028740

6612 C Insert box-end wrench · open



HAZET No.	S mm	Drive	Output	l mm	l ₂ mm	a mm	a ₁ mm	b mm	EAN-No. 4000896+
6612 C-13	13	■ 9x12	●	43.7	17.5	12	14.5	25	028757
6612 C-14	14	■ 9x12	●	44.4	17.5	13	14.5	27	028764
6612 C-16	16	■ 9x12	●	45.4	17.5	13	14.5	30	028771
6612 C-17	17	■ 9x12	●	45.9	17.5	13	14.5	31.5	028788
6612 C-18	18	■ 9x12	●	46.1	17.5	15	15	33	028795
6612 C-19	19	■ 9x12	●	46.8	17.5	15	15	34.5	028801
6612 C-21	21	■ 9x12	●	48	17.5	15	15	37.5	028818
6612 C-22	22	■ 9x12	●	48.8	17.5	15	15	39	028825

6630 D Insert box-end wrench

Made in Germany
• Surface: chrome-plated

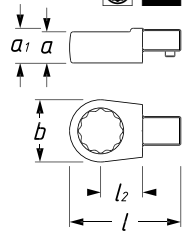
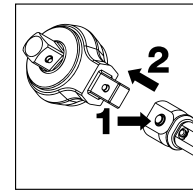

HAZET No.	S mm	Drive	Output	l mm	l ₂ mm	a mm	a ₁ mm	b mm	EAN-No. 4000896+
6630 C- 7	7	■ 9x12	●	40	17.5	8	14.5	20	028955
6630 C- 8	8	■ 9x12	●	40.6	17.5	8	14.5	20	028962
6630 C-10	10	■ 9x12	●	42.1	17.5	8	14.5	20	028832
6630 C-11	11	■ 9x12	●	42.8	17.5	8	14.5	20	028849
6630 C-12	12	■ 9x12	●	43.5	17.5	12	14.5	22	028856
6630 C-13	13	■ 9x12	●	44.3	17.5	12	14.5	22	028863
6630 C-14	14	■ 9x12	●	45	17.5	12	14.5	23	028870
6630 C-15	15	■ 9x12	●	45.5	17.5	12	14.5	24	028887
6630 C-16	16	■ 9x12	●	46.5	17.5	13	14.5	26	028894
6630 C-17	17	■ 9x12	●	47	17.5	13	14.5	27	028900
6630 C-18	18	■ 9x12	●	47.8	17.5	13	14.5	28.5	028917
6630 C-19	19	■ 9x12	●	48.8	17.5	13	14.5	30.5	028924
6630 C-21	21	■ 9x12	●	50	17.5	15	15	33	028931
6630 C-22	22	■ 9x12	●	50.8	17.5	15	15	34.5	028948
6630 D-13	13	■ 14x18	●	60.8	25	12	21.5	30	028979
6630 D-14	14	■ 14x18	●	61.5	25	12	21.5	30	028986
6630 D-15	15	■ 14x18	●	62	25	12	21.5	30	028993
6630 D-16	16	■ 14x18	●	62.9	25	12	21.5	30	029006
6630 D-17	17	■ 14x18	●	63.6	25	12	21.5	30	029013
6630 D-18	18	■ 14x18	●	64.3	25	12	21.5	30	029020
6630 D-19	19	■ 14x18	●	65.3	25	12	21.5	30.5	029037
6630 D-21	21	■ 14x18	●	66.5	25	15	21.5	33	029044
6630 D-22	22	■ 14x18	●	67.3	25	15	21.5	34.5	029051
6630 D-24	24	■ 14x18	●	68.8	25	15	21.5	37.5	029068
6630 D-27	27	■ 14x18	●	76.8	31	17.5	21.5	41.5	029075
6630 D-30	30	■ 14x18	●	78.5	31	17.5	21.5	45	029082
6630 D-32	32	■ 14x18	●	79.8	31	17.5	21.5	47.5	029099
6630 D-34	34	■ 14x18	●	81.3	31	19	21.5	50.5	029105
6630 D-36	36	■ 14x18	●	82.5	31	19	21.5	53	029112
6630 D-41	41	■ 14x18	●	85.5	31	19	21.5	59	029129

Torque testers and accessories

6690 Mechanical angle dial

Made in Germany
• Flexible, magnetic holder for the fixed point



- To be used with operating tools with ■ drive 12.5 = 1/2" (or 20 = 3/4") and tools with □ drive 12.5 = 1/2" (or 20 = 3/4")
- Range 0–360°, graduation 1°, 95 mm Ø



HAZET No.	Drive	Output	EAN-No. 4000896+
6690	□ 12.5 = 1/2"	■ 12.5 = 1/2"	029266



Torque technology

Torque testers and accessories



7900 E Torque tester · electronic · 1.5–30 Nm

- **Simple, intuitive operation**
 - **Giant display with 17 mm large digits**
 - **Traffic light function for evaluation of the measured value PLUS audible signal**
 - **Easy entry** of up to 15 different target values and the respective permissible tolerance in the range of $\pm 1\%$ to $\pm 15\%$
 - **Precision $\pm 1\%$** (maximum display deviation)
 - **Digital readouts** · 3 measurement procedures
 - Automatic click point detection (first peak · click)
 - Peak value measurement (final peak · dial)
 - Tracking measurement / display value (track)
 - **Triple signalling** of the measurement result:
 - Digit display in 17 mm font size
 - Traffic light function for assessing the torque value (yellow = too low · green = OK · red = too high)
 - Audible signal
 - **Robust aluminium housing** for workshop use, surface powder-coated
 - **Large, high-contrast, luminous easy-to-read LCD display with backlighting**
 - **Self-sufficient operation** possible via power bank (5 V · 1 A)
 - Maximum power consumption: 0.5 Wh · energy efficiency level 6
 - **Rapid test function** with auto reset, without target value and tolerance specification, without evaluation
 - **Compatible with HAZET test software** torque testing 7901E-D, micro USB socket for power supply and data transmission
 - **Protection rating IP 40**, splash-proof display and membrane keyboard
 - **10 adjustable menu languages:** German · English · French · Spanish · Italian · Danish · Finnish · Swedish · Norwegian · Portuguese
 - **Included in delivery:**
 - USB power supply 90-264 volts AC at 47–63 Hz Output voltage: 5 V · 1000 mA · USB 2.0 A socket Includes mains plug adapters for EU · UK · USA · AUS
 - Cable (2 m) USB 2.0 A plug – USB 2.0 micro B plug
 - Calibration certificate and quick reference guide (detailed operating instructions online for download)
- Stable mounting on workbench

10 3/8" 6.3 1/4" 10 3/8" 12.5 1/2" E



HAZET No.	Drive	l mm	Nm	EAN-No. 4000896+
<ul style="list-style-type: none"> • Calibrated measuring range in the clockwise direction of rotation (measurements from 1 Nm are possible with a display deviation of approx. $\pm 2\%$) • Fixed external hexagon socket · size 10 mm including adapter $\text{⌀}^{10} \rightarrow \text{⌀}^{10} \frac{3}{8}$ und $\text{⌀}^{10} \rightarrow \text{⌀}^{10} \frac{1}{4}$ • Switchable torque display in Nm · dNm · cNm · kgfm · kgfcm · gfm · lbf.ft · lbf.in · ft.lb · in.lb · ozfin · inoz • Configurable selection of desired units • Fixing material (not included in the scope of delivery): hexagon socket screws ISO 4762 – M6 – 8.8 • Gross weight including plastic case and accessories approx. 2.9 kg 				
7903 E	$\text{⌀} 10 = \frac{3}{8}$, $\square 6.3 = \frac{1}{4}$, $\square 10 = \frac{3}{8}$ "	175	1.5–30	167425
<ul style="list-style-type: none"> • Calibrated measuring range in the clockwise direction of rotation • Fixed internal square socket · 12.5 = $\frac{1}{2}$" • Switchable torque display in Nm · dNm · kgfm · kgfcm · lbf.ft · lbf.in · ft.lb · in.lb • Configurable selection of desired units • Fixing material (not included in the scope of delivery): hexagon socket screws ISO 4762 – M10 – 12.9 • Gross weight including plastic case and accessories approx. 3.9 kg 				
7901 E	$\square 12.5 = \frac{1}{2}$ "	138	10–350	140671
<ul style="list-style-type: none"> • Calibrated measuring range in the clockwise direction of rotation • Fixed external hexagon socket · size 27 mm • Switchable torque display in Nm · kgfm · kgfcm · lbf.ft · lbf.in · ft.lb · in.lb • Configurable selection of desired units • Fixing material (not included in the scope of delivery): hexagon socket screws ISO 4762 – M10 – 12.9 • Gross weight including plastic case and accessories approx. 5.0 kg 				
7902 E	$\text{⌀} 27$ mm	160	50–1100	150229



7900 E Torque testing software

Made in Germany

For the electronic torque testers 7901E · 7902E · 7903E

- Including database (update-friendly) of all current HAZET torque wrenches (whose test values range from 1–1000 Nm) and insert tools
- Optional expansion of the database to include data of other manufacturers, further release torque wrenches (click-type), insert tool holders, measuring ranges, test values, units, tolerances and standards
- Software for creating user-own certificate layouts and optional integration of company logos
- Language tool included. German and English is already available. By means of the language tool, the user creates the operating surface, tables and designation of boxes in any required language
- Internet update function
- Detailed documentation included

System prerequisite

Operating system: Windows 7® / Windows 8® / Windows 10® (64 Bit)

Memory requirement: minimum 50 MB free hard disk memory

Main storage: min. 256 MB

Ports: 1. USB port for software

2. Ports for test devices

COM port (connecting cable included in delivery of the electronic torque test device)

Graphics resolution: minimum 1024x768

Attention:

If the hardware does not have a COM port, the test device can also be connected with an adapter USB to the COM port (RS 232) (not included in delivery)

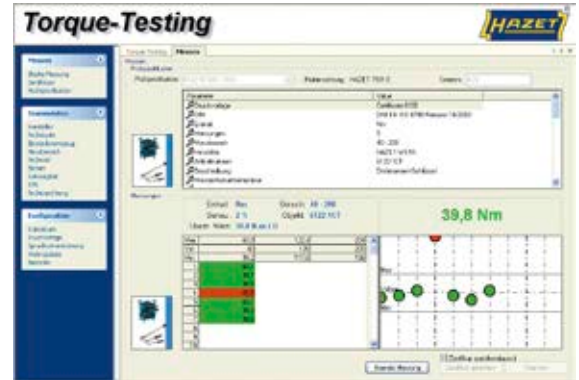

HAZET No.	EAN-No. 4000896+
7901 E-D	148202

7920 E Torque calibration unit

Made in Germany

Modular system thanks to high-quality, replaceable torque sensors

6.3 1/4 10 3/8 12.5 1/2 20 3/4 25 1"

Application: Calibration of indicating and releasing torque wrenches according to DIN EN ISO 6789-1:2017 and -2:2017

Motor-operated torque calibration unit controlled by integrated PC
High-quality torque sensors:

- Replaceable torque sensors in 2 accuracy classes determine the torque range:
 - 0.25% – for indicating and releasing torque wrenches with an accuracy of $\pm 1\%$ (e.g. for product group 7000 sTAC · 7000 eTAC)
 - 0.50% – for indicating and releasing torque wrenches with an accuracy of $\pm 2\%$ (e.g. for product group 6000CT)
- Quick-change system for nominal size sockets 6.3 1/4 10 3/8 12.5 1/2 20 3/4 25 1"
- Automatic sensor recognition
- Extendable arm up to approx. 1.20 m, including height adjustment
- Directions of actuation right/left can be calibrated
- Integrated PC (Windows 10 operating system)
Connection options for monitor, keyboard and mouse (not included in scope of delivery) as well as remote access via remote desktop
- Software included
 - Test stand control
 - Measurement data logging
 - Calibration certificate, declaration of conformity or combination of the two (like HAZET) also with customised company data
 - Parts management – HAZET data pool including all parameters for consideration of uncertainty of measurement
 - Tool management
 - Online update and remote maintenance service
- Dimensions Length: approx. 1140 mm (1680 mm extended) width x height: approx. 570 x 600 mm
- Power supply: 200–250 V / PE-N / 50–60 Hz
- 3 height-adjustable feet for horizontal alignment
- Price on request, delivery time to be coordinated



7920 E-200-1 · -2
7920 E-800-1 · -2



7920 E Torque calibration unit

6.3 1/4" 10 3/8" 12.5 1/2" 20 3/4" 25 1"

HAZET No.	EAN-No. 4000896+
• Torque calibration unit without sensors 7920 E	223756
• Torque sensor for calibration unit 7920E • 1–200 Nm · accuracy class 0.25 % 7920 E-200-1	219230
• Torque sensor for calibration unit 7920E • 1–200 Nm · accuracy class 0.50 % 7920 E-200-2	219247
• Torque sensor for calibration unit 7920E • 60–800 Nm · accuracy class 0.25 % 7920 E-800-1	219254
• Torque sensor for calibration unit 7920E • 60–800 Nm · accuracy class 0.50 % 7920 E-800-2	219223

SP-10 – 30 HAZET SERVICE for torque wrenches and pneumatic tools

Made in Germany



All HAZET torque tools and pneumatic tools are serviceable! Along with repairs, we offer factory tests through to calibration in our own DAkkS calibration laboratory for torque wrenches in the HAZET Service Center. Your local HAZET partner will be happy to advise you on all the services provided by the HAZET Service Center as well as local on-site services.







Impact wrenches

343–348

Air ratchets

349–351

Drilling and grinding machines

352–366

Blind rivet guns

367

Air blow tools

368–370

Tyre inflators and measuring instruments

371

Grease gun, spray gun, air blow and suction gun

372–373

Pneumatic adaptors

374–377

Pneumatic accessories

377–379

Cordless impact wrenches

382–384

Cordless drilling machine / right-angle grinder / reciprocating saw

384–386

Heat guns

387



Pictogram key

	High performance pin clutch mechanism
	Powerful twin hammer striking mechanism
	Single hammer striking mechanism
	Direct hammer striking mechanism
	Twin Turbo technology
	Mini tool
	Output
	Air inlet thread
	Recommended torque
	Max. torque
	Max. loosening torque

	Max. rotation speed, rpm
	Stroke
	Max. rotation speed, rpm Forward/reverse
	Weight (net) [without nipples]
	Pressure hose
	Air requirement
	Working pressure
	Sound pressure level (Lp A)
	Sound power level (Lp W)
	Vibration acceleration
	Screw size

	Collet chuck
	Grinding disc Ø
	Saw stroke
	Cutting capacity: sheet steel
	Cutting capacity: aluminium
	Measuring range (manometer)
	Scale graduation
	Temperature range
	Cold-insulated handle
	Number of pieces in set / assortment

All pneumatic machines are operated with 6.3 bar.

HAZET SERVICE for torque wrenches and pneumatic tools

All HAZET torque tools and pneumatic tools are serviceable! Along with repairs, we offer factory tests through to calibration in our own DAkkS calibration laboratory for torque wrenches in the HAZET Service Center. Your local HAZET partner will be happy to advise you on all the services provided by the HAZET Service Center as well as local on-site services.

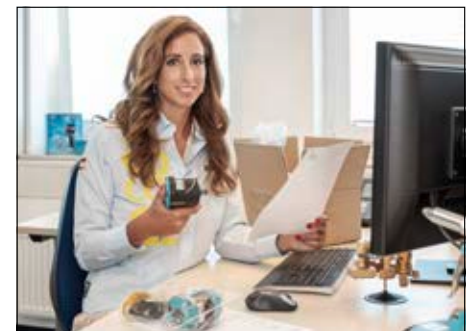

The HAZET Service Centre

Direct contact and coordination point for services for all of our products

+49(0)2191/792-355
 +49(0)2191/792-523
service-center@hazet.de

- In our specially equipped Service Centre, you can receive the best aftersales service with short response times and the complete HAZET competence.

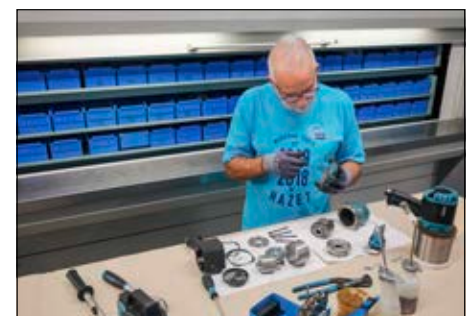



When using pneumatic tools, there are various different parameters to consider to achieve the best possible result.

Our operating instructions contain technical information, e.g. details on working pressure, hose diameter, etc.

These details must be observed at all costs, since they have a considerable impact on the pneumatic tool's performance.

Working pressure

- Reducing the recommended working pressure by 1 bar results in a performance reduction of up to 25%.
- Too narrow or too long a hose reduces the air flow rate and with it the performance of the product.
- A higher than specified working pressure accelerates wear and tear of the tool.

Compressor

- A pneumatic tool is powered by compressed air. A compressor is needed to generate the compressed air. The compressor has to be chosen in such way that it can continuously generate the required amount of compressed air.
- With our pneumatic tools we specify in the operating instructions how much air is needed to achieve the required output. Depending on the model, our impact wrenches require between 70 and 283 litres of compressed air per minute at a working pressure of approx. 6.3 bar.
- Often the specifications on the compressor are stated „without pressure“. This means that when “150 litres per minute” can be found as a specification on a compressor, this is the amount of compressed air produced by the compressor **without** pressure in the tank.
- If the required working pressure increases, the amount of air produced decreases drastically. For the production and storage of 150 litres of compressed air per minute at a working pressure of 6.3 bar, a large workshop compressor is required. An “ordinary household compressor” with a compressed air tank of 25 litres produces an average of 200 litres of compressed air per minute. In doing so, the motor (usually approx. 1.5 kW / 2 PS) works against a pressure of at least 6.3 bar in the compressed air tank. This means that often only an effective potential of one tenth, i.e. approx. 15 litres per minute is left over.
- Therefore it is advisable to align the specifications of the compressor and the tool which is to be used.

Air hose

- The hose diameter and length are both decisive factors for the full performance of the compressed air devices. The **internal** hose diameter should not exceed 10 mm in order to ensure the required air flow rate. The shorter the hose from the compressor to the device is, the lower the friction loss and the full pressure produced by the compressor is available to the device. Please be sure to observe the recommended inner hose diameter specified in the operating instructions.

Maintenance and care

- Clean, dry air and oiling daily are guarantors for your pneumatic devices' long service life
- The long service life of the pneumatic tool is critically dependent on maintenance.
- Note the specifications in the operating instructions regarding storage and maintenance.





TwinTurbo technology by HAZET

Strongest HAZET impact wrench series ever Exclusively at HAZET

- Maximum efficiency due to the ground-breaking „HAZET Twin Turbo technology“ enables high torques with compact design
- Innovative 8-slat air motor with 25% higher impact performance ensures maximum torque
- Long service life and high efficiency in industrial and automotive applications
- Significantly higher performance results in faster loosening of the screw connection during the screwing procedure and is thereby twice as efficient.
- Advantage: time saving, as the work procedure is completed faster, thereby consuming less air = cost savings!

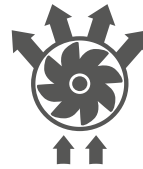

Standard

1 exhaust inlet

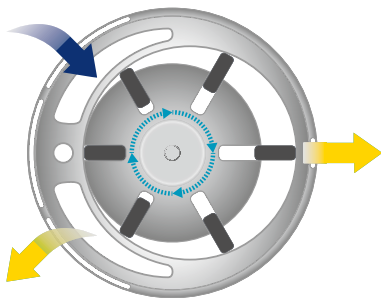

2 exhaust outlets

Twin Turbo

2 exhaust inlets

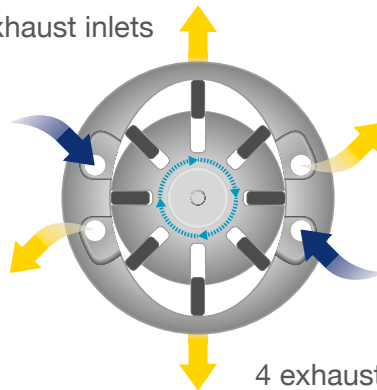

4 exhaust outlets

Range of mini pneumatic tools

- Extremely small and handy
- High reliability and continuous operation
- Includes safety operating lever (except 9023 M-1)
- Innovative 5-slat concept for even more power than conventional drives



Standard:
4 slats

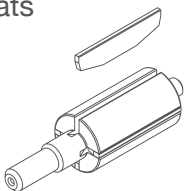

Mini tool:
5 slats

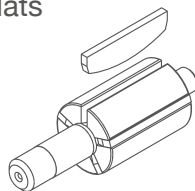



Overview of HAZET impact wrenches

		■	max. Nm	Nm	max. Nm	db (A) LpA	db (A) LpW	l/min.	kg	Striking mechanism	m/s ²
	9011 M	10 3/8"	461	375	461	90.3	101.3	85.2	1.24		7.78
	9012 M	12 5/8"	1100	610	678	97.1	108.1	127	1.242		9.57
	9012 M-1	12 5/8"	1200	610	678	92.2	103.2	127.4	1.27		13.49
	9012 A TT	12 5/8"	550	450	500	90.1	101.1	113	1.3		4.89
	9012 P TT	12 5/8"	550	450	500	92.9	103.9	113	1.1		7.64
	9012 SPC	12 5/8"	850	550	750	92.1	103.1	127.4	2.6		7.42
	9012 EL-SPC	12 5/8"	1700	881	1054	98	109	139	1.98		10.23
	9012 TT	12 5/8"	2200	948	1356	99.7	110.7	147.2	1.6		8.69
	9013 M	20 3/4"	1890	922	1085	104	93	153	2.1		7.47
	9013 Lg TT	20 3/4"	3800	1758	2020	102.5	113.5	243	5.5		9.017
	9013 TT	20 3/4"	4100	1890	2170	99.5	110.5	243.5	4.5		10.69
	9014 TT	25 1"	4100	1898	2170	101.9	112.9	235	4.6		19.11
	9014 Lg TT	25 1"	3850	1627	1762	102.5	113.5	235	5.9		17.31
	9014 PS-1	25 1"	3400	2400	2712	103.5	114.5	283	7.8		15.94
	9014 P-1	25 1"	3400	2400	2712	103.5	114.5	283	8.58		15.94



Overview of HAZET air ratchets

		■	max. Nm	db (A) LpA	db (A) LpW	I/min.	kg	Striking mechanism	m/s ²
	9020-2	6.3 1/4"	35	83	89	180	0.5		3.3
	9020 P-2	6.3 1/4"	40	90	101	72	0.5		3.3
	9023 M-1	6.3 1/4" 10 3/8" 6.3 1/4"	54	82.8	93.8	84	0.48		3.2
	9021-3	10 3/8"	35	83	89	180	0.5		3.3
	9021 P-2	10 3/8"	54	92	103	103	0.5		3.9
	9021 SR-1	10 3/8"	68	82	93	68	0.67		9.84
	9022-2	12 ⁵ 1/2"	70	88	95	180	1.2		8.5
	9022 P-2	12 ⁵ 1/2"	108	99	110	113	1.24		9.1
	9022 P-1	12 ⁵ 1/2"	95	88.3	99.3	77	1.39		3
	9022-360	12 ⁵ 1/2"	120	91.2	102.2	107.6	1.55		4.87
	9022 SR-1	12 ⁵ 1/2"	102	91	98	113	1.28		4.53
	9022 P-X Lg	12 ⁵ 1/2"	94.8	93.7	104.7	99.12	2.1		5.6

High performance pin clutch mechanism

Single hammer striking mechanism

Powerful twin hammer striking mechanism

Direct hammer striking mechanism



Overview of HAZET drilling and grinding machines

		db (A) LpA	db (A) LpW	l/min.	kg	m/s ²
	9030 N-1	88.7	99.7	113	1	2.1
	9030 N-5	85	96	113	1.2	0.5
	9030 P-1	88.4	99.4	113	1.3	1.2
	9032 MK	80.4	86.4	75	0.23	0.8
	9032 M-36	78.7	85.8	43.7	0.38	1.8
	9032 M-53	77.7	78.1	150	0.23	0.37
	9035 G-1	78	90	28.31	0.22	2.5
	9032 N-1	79	85	74	0.4	0.4
	9032 N-5	78	82	74	0.5	0.5
	9032 P-1	87	98	150	0.8	0.46
	9032 Lg-1	81	78	99	0.6	0.5
	9032 M-1	82.4	93.4	84	0.33	1.8
	9032 M-5	81.9	92.9	84	0.48	5.1
	9033-2	88.8	93.8	57	0.9	5.35
	9033 N-4	83.8	94.8	94	0.81	1.88
	9033 N-5	80	93	79	0.64	0.77



Overview of HAZET drilling and grinding machines

		db (A) LpA	db (A) LpW	I/min.	kg	m/s ²
	9033 N-6	79	82	102	1.2	0.8
	9033 N-9	85.76	96.76	91	0.72	2.43
	9033 N-7	85	96	113	2	6.5
	9033 P-8	89.5	100.5	113	1.7	3.65
	9033-10	88	88	114	0.9	1.8
	9033-11/17	75	86	79	0.54	3.11
	9033 M-7	85.8	96.8	84	0.53	1.9
	9033 M-9	83.6	94.4	84	0.6	1.9
	9033 M-11	84.2	95.2	84	0.44	1.8
	9034 P-2	86.7	97.7	99	0.4	6.13
	9035-5	97		170	2.6	8.7
	9035 M-5	87.9	98.8	48.1	0.48	6.9
	9035 H/6	92-105		57-594	2.5	
	9035 V/6	92-105		57-594	2.5	
	9036 N-1	80	87	104	1	1.9
	9036 N-5	80	86	104	1	1.6



Overview of HAZET blind rivet guns

		db (A) LpA	db (A) LpW	l/stroke	kg	m/s ²
	9037 SPC	73		1	1.5	
	9037 N-2			2.64	2.11	

Overview of HAZET air blow tools

		db (A) LpA	db (A) LpW	l/min.	kg	m/s ²
	9040 P-1	84		290	0.105	
	9040 P-2	84		290	0.19	
	9040 P-3	76.8		245	0.1	
	9040 P-4	83.7		235	0.165	
	9040 P-5	78		450	0.095	
	9040-3					
	9040-4	86		330	0.205	
	9040 Lg-3/2			450	0.313	
	9040 T-1	91	102	80	0.163	

Do you know – Li-Ion batteries:

- Do not have any memory effect
- Consist of cells with 3.6 V each
- After full charge they have a higher voltage than 3.6 V i.e. 5 cells with 3.6 V each = 18 V – but after full charge a peak voltage of up to 20 V is possible
- Attention: For a longer lifetime of the battery please store it charged up to 50 to 80 % only
- Have an energy density which is twice as high as nickel cadmium batteries, for example
- Have a nominal voltage three times higher than a nickel metal hydride battery
- Require multiple complete charging cycles to reach full capacity



Overview of HAZET grease gun, spray gun, air blow and suction gun

		db (A) LpA	db (A) LpW	l/min.	kg	m/s ²
	9042 N-1			230	2	
	9042 P-4					
	9043 N-10	92	97	96	0.403	0.4
	9045 P-1			280	0.46	

Overview of HAZET cordless impact wrenches

			max. Nm	Nm	max. Nm	db (A) LpA	db (A) LpW	kg	m/s ²
	9212 SPC-1	12 ⁵ 1/2"	260	200	200	100	111	1.45	14.912
	9212 M-1	12 ⁵ 1/2"	270	220	220	99.6	110.6	1.34	15.4
	9212-3	12 ⁵ 1/2"	700	500	500	99.4	110.4	1.857	20.3
	9212-1000	12 ⁵ 1/2"	1400		1000	101	112	3.64	17.8
	9213-1000	20 3/4"	1400		1000	101	112	3.7	17.8

Overview of HAZET cordless drilling machine / right-angle grinder / reciprocating saw

		Stroke/min.	max. Nm	1	2	db (A) LpA	db (A) LpW	kg	m/s ²
	9230-2		60	0-560	0-1900	68		1.68	79
	9233-7			8000		89		2.28	7.9
	9234-1	9500				86,13	97.13		32,18



Impact wrenches

9011 M 3/8" Impact wrench · extra short

• **Loosening torque: 461 Nm**

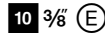

- Exhaust air is guided through the handle downwards
- Reduced vibrations
- Easy handling
- **Extra short – only 92 mm**
- Single hammer striking mechanism
- Air connection inlet: inside thread 12.91 mm (1/4")
- Coupler plug: Nominal size 7.2 (included)
- Recommended torque: 375
- Hose diameter (recommended): 10 mm
- Working pressure (bar): 6.3
- Sound power level: 101.3 db(A) Lp W
- Vibration acceleration: 7.78 m/s²
- Loosening torque (max) determined with screw size M: 13
- Forward and reverse: three-stage (forward), single-stage (reverse)
- Cold insulated handle
- **Extremely compact construction enables working in areas with restricted access**
- One-hand operation for right and left handed operators

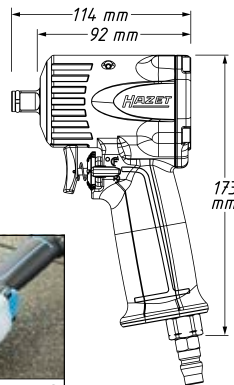

YouTube Clip

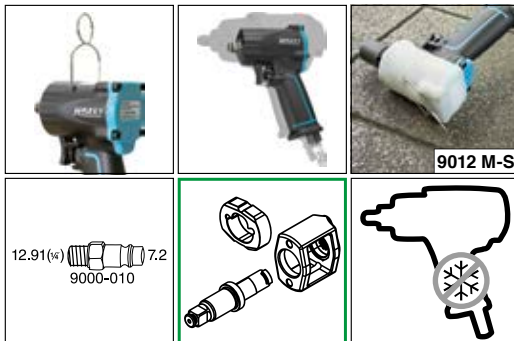

HAZET No.	max. Nm	max. Nm	l/min.	rpm	db(A) LpA	g	EAN-No. 4000896+
9011 M	461	461	85.2	6500	90.3	1240	201570
Silicone protective cover for 9011M and 9012M							
9012 M-S	-	-	-	-	-	-	202232

9012 M 1/2" Impact wrench · extra short

• **Loosening torque: 1100 Nm**

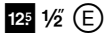

- Exhaust air is guided through the handle downwards
- Reduced vibrations
- Easy handling
- **Extra short – only 92 mm**
- Single hammer striking mechanism
- Air connection inlet: inside thread 12.91 mm (1/4")
- Coupler plug: Nominal size 7.2 (included)
- Recommended torque: 610
- Hose diameter (recommended): 10 mm
- Working pressure (bar): 6.3
- Sound power level: 108.1 db(A) Lp W
- Vibration acceleration: 9.57 m/s²
- Loosening torque (max) determined with screw size M: 16
- Forward and reverse: three-stage (forward), single-stage (reverse)
- Cold insulated handle
- **Extremely compact construction enables working in areas with restricted access**
- One-hand operation for right and left handed operators

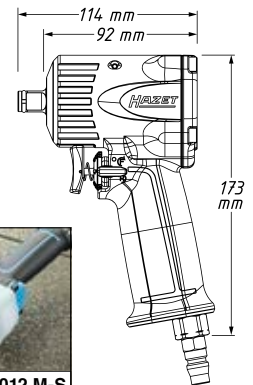

YouTube Clip



HAZET No.	max. Nm	max. Nm	l/min.	rpm	db(A) LpA	g	EAN-No. 4000896+
9012 M	1100	678	127	10000	97.5	1242	188987
Silicone protective cover for 9011M and 9012M							
9012 M-S	-	-	-	-	-	-	202232





9012 M 1/2" Impact wrench · extra short

• **Loosening torque: 1200 Nm**

12.5 1/2 E

- Exhaust air is guided through the handle downwards
- Reduced vibrations
- Easy handling
- **Extra short – only 80 mm**
- Single hammer striking mechanism
- Air connection inlet: inside thread 12.91 mm (1/4")
- Coupler plug: Nominal size 7.2 (included)
- Recommended torque: 610
- Hose diameter (recommended): 10 mm
- Working pressure (bar): 6.3
- Sound power level: 103.2 db(A) Lp W
- Vibration acceleration: 13.49 m/s²
- Loosening torque (max) determined with screw size M: 16
- Forward and reverse: three-stage (forward), single-stage (reverse)
- Cold insulated handle
- One-hand operation for right and left-handed operators

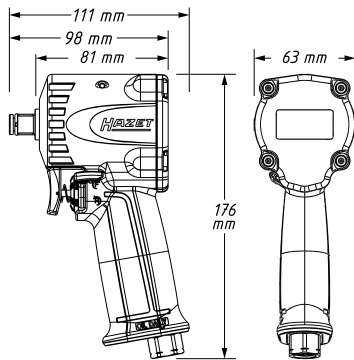

YouTube Clip

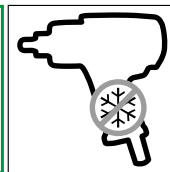
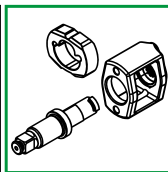
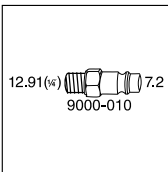

HAZET No.	max. Nm	max. Nm	l/min.	rpm	db (A) LpA	g	EAN-No. 4000896+
9012 M-1	1200	678	127.4	8800	92.2	1270	218356
Silicone protective cover for 9012M-1							
9012 M-1-S	-	-	-	-	-	-	222735

9012 PTT 1/2" Twin Turbo palm impact wrench

• **Loosening torque: 550 Nm**

12.5 1/2 E

- Exhaust air is guided through the handle downwards
- Reduced vibrations
- Easy handling
- Extremely compact
- Low reaction forces
- HAZET Twin Turbo technology
- **Recommended accessories:** Rotary joint 9000-041
- Powerful twin hammer mechanism
- Air connection inlet: inside thread 12.91 mm (1/4")
- Coupler plug: Nominal size 7.2 (included)
- Recommended torque: 450
- Hose diameter (recommended): 10 mm
- Working pressure (bar): 6.3
- Sound power level: 103.9 db(A) Lp W
- Vibration acceleration: 7.64 m/s²
- Loosening torque (max) determined with screw size M: 16
- Forward and reverse: single-stage (right/left)
- Cold insulated handle



9012 PTT 1/2" Twin Turbo palm impact wrench

12.5 1/2 E

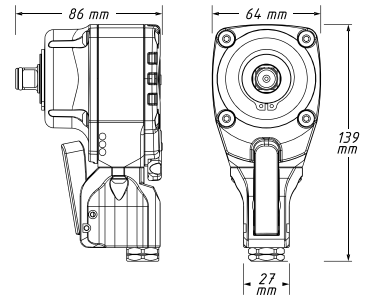

HAZET No.	max. Nm	max. Nm	l/min.	rpm	db (A) LpA	g	EAN-No. 4000896+
9012 PTT	550	500	113	8000	92.9	1100	252732

9012 ATT 1/2" Twin Turbo impact wrench

• **Loosening torque: 550 Nm**

12.5 1/2 E

- Exhaust air is guided through the handle downwards
- Reduced vibrations
- Easy handling
- Handle / trigger adjustable around its own axis for optimal handling allows operation in any position
- Swivel mechanism for extended application range guarantees best accessibility
- Short, compact, angled design – only 70 mm
- One-hand operation for left- and right-handed users
- Powerful twin hammer mechanism
- Air connection inlet: inside thread 12.91 mm (1/4")
- Coupler plug: Nominal size 7.2 (included)
- Recommended torque: 450
- Hose diameter (recommended): 10 mm
- Working pressure (bar): 6.3
- Sound power level: 101.1 db(A) Lp W
- Vibration acceleration: 4.89 m/s²
- Loosening torque (max) determined with screw size M: 16
- Forward and reverse: single-stage (right/left)
- Cold insulated handle

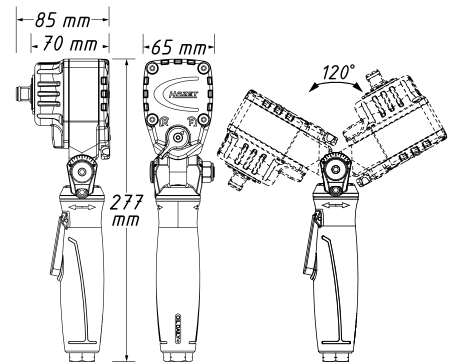

YouTube Clip

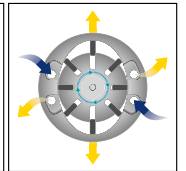
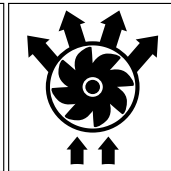
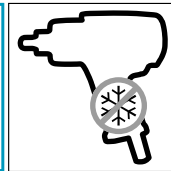
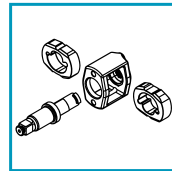
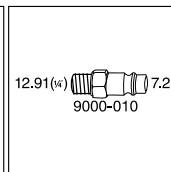

HAZET No.	max. Nm	max. Nm	l/min.	rpm	db (A) LpA	g	EAN-No. 4000896+
9012 ATT	550	500	113	8000	90.1	1300	234738



Pneumatic tools · Cordless tools

Impact wrenches



9012 1/2" Impact wrench

• **Loosening torque: 850 Nm**

12⁵ 1/2 (E)

- Exhaust air is guided through the handle downwards
- Reduced vibrations
- Easy handling
- Powerful pin clutch mechanism
- Air connection inlet: inside thread 12.91 mm (1/4")
- Coupler plug: Nominal size 7.2 (included)
- Recommended torque: 550
- Hose diameter (recommended): 10 mm
- Working pressure (bar): 6.3
- Sound power level: 103.1 db(A) Lp W
- Vibration acceleration: 7.42 m/s²
- Loosening torque (max) determined with screw size M: 16
- Forward and reverse: three-stage (forward), single-stage (reverse)
- Cold insulated handle
- Enhanced power characteristics due to new, specially developed air motor as well as efficient air guide and improved pull-up torque of the air motor
- Specially heat-treated inner parts for minimised wear

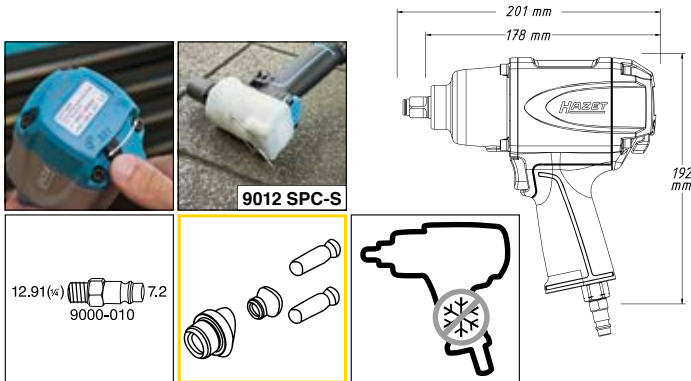

HAZET No.	max. Nm	max. Nm	l/min.	rpm	db (A) LpA	g	EAN-No. 4000896+
9012 SPC	850	750	127.4	7000	92.1	2600	119639
Silicone protective cover for 9012SPC · 9012-1SPC · 9012P-1							
9012 SPC-S	-	-	-	-	-	-	222476

9012 EL-SPC 1/2" Impact wrench

• **Loosening torque: 1700 Nm**

12⁵ 1/2 (E)

- Exhaust air is guided through the handle downwards
- Reduced vibrations
- Easy handling
- Powerful twin hammer mechanism
- Air connection inlet: inside thread 12.91 mm (1/4")
- Coupler plug: Nominal size 7.2 (included)
- Recommended torque: 881
- Hose diameter (recommended): 10 mm
- Working pressure (bar): 6.3
- Sound power level: 109 db(A) Lp W
- Vibration acceleration: 10.23 m/s²
- Loosening torque (max) determined with screw size M: 16
- Forward and reverse: four-stage (counterclockwise rotation), single-stage (clockwise rotation)
- Cold insulated handle
- **One-hand operation by changeover on rear of device**



9012 EL-SPC 1/2" Impact wrench

12⁵ 1/2 (E)

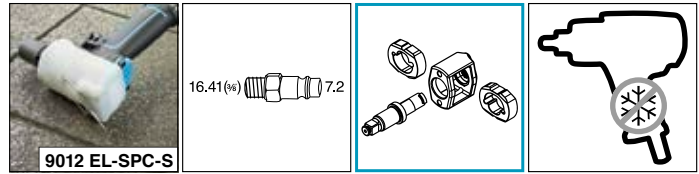

HAZET No.	max. Nm	max. Nm	l/min.	rpm	db (A) LpA	g	EAN-No. 4000896+
9012 EL-SPC	1700	1054	139	8000	98	1980	188444
Silicone protective cover for 9012EL-SPC							
9012 EL-SPC-S	-	-	-	-	-	-	222520

9012 TT 1/2" Twin Turbo impact wrench

• **Loosening torque: 2200 Nm**

12⁵ 1/2 (E)

- Exhaust air is guided through the handle downwards
- Reduced vibrations
- Easy handling
- Short design – only 128 mm
- HAZET Twin Turbo technology – high torques with compact design
- 8-blade air motor with 25% higher impact performance ensures maximum torque
- One-hand operation for right- and left-handed users
- Powerful twin hammer mechanism
- Air connection inlet: inside thread 12.91 mm (1/4")
- Coupler plug: Nominal size 7.2 (included)
- Recommended torque: 948
- Hose diameter (recommended): 10 mm
- Working pressure (bar): 6.3
- Sound power level: 110.7 db(A) Lp W
- Vibration acceleration: 8.69 m/s²
- Loosening torque (max) determined with screw size M: 16
- Forward and reverse: two-stage (forward), single-stage (reverse)
- Cold insulated handle

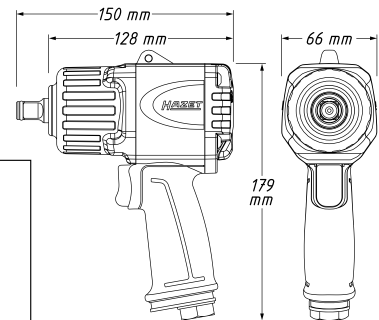

YouTube Clip

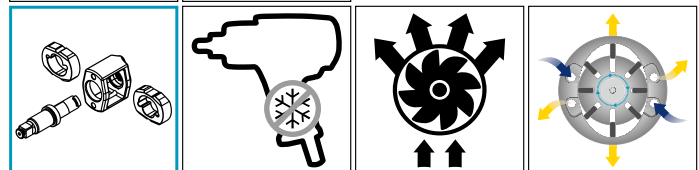
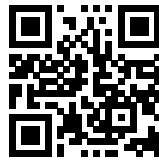

HAZET No.	max. Nm	max. Nm	l/min.	rpm	db (A) LpA	g	EAN-No. 4000896+
9012 TT	2200	1356	147.2	8300	99.7	1600	226924
Low noise hose for noise reduction of the HAZET Turbo Twin impact wrenches 9012MTT · 9012TT							
Spring clamp for fixing the hose to the handle							
9040-012	-	-	-	-	-	-	232987



9013 M 3/4" Impact wrench

• Loosening torque: 1890 Nm

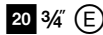

- Exhaust air is guided through the handle downwards
- Reduced vibrations
- Easy handling
- **20 mm (3/4") impact wrench in 12.5 mm (1/2") housing size**
- Powerful twin hammer mechanism
- Air connection inlet: inside thread 16.41 mm (5/8")
- Coupler plug: Nominal size 7.2 (included)
- Recommended torque: 922
- Hose diameter (recommended): 10 mm
- Working pressure (bar): 6.3
- Sound power level: 93 db(A) Lp W
- Vibration acceleration: 7.47 m/s²
- Loosening torque (max) determined with screw size M: 32
- Forward and reverse: three-stage (forward), single-stage (reverse)
- Cold insulated handle



YouTube Clip

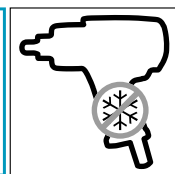
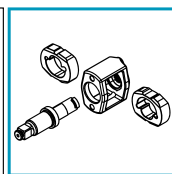
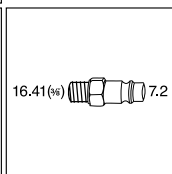
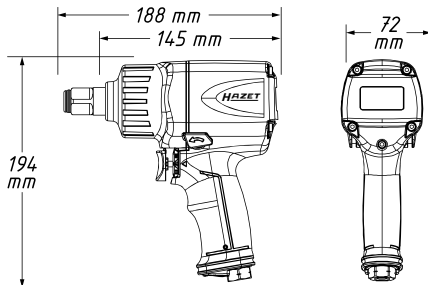

HAZET No.	max. Nm	max. Nm	l/min.	rpm	db(A) LpA	g	EAN-No. 4000896+
9013 M	1890	1085	153	7300	104	2100	212347

9013 TT 3/4" Twin Turbo impact wrench

• Loosening torque: 4100 Nm

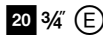

- Exhaust air is guided through the handle downwards
- Reduced vibrations
- Easy handling
- Short design – only 184 mm
- Strongest HAZET impact wrench ever
- Removable handle, 360° adjustable
- HAZET Twin Turbo technology – high torques with compact design
- 8-blade air motor with 25% higher impact performance ensures maximum torque
- One-hand operation for right- and left-handed users
- Powerful twin hammer mechanism
- Air connection inlet: inside thread 16.41 mm (5/8")
- Coupler plug: Nominal size 7.2 (included)
- Recommended torque: 1890
- Hose diameter (recommended): 13 mm
- Working pressure (bar): 6.3
- Sound power level: 110.5 db(A) Lp W
- Vibration acceleration: 10.69 m/s²
- Loosening torque (max) determined with screw size M: 32
- Forward and reverse: two-stage (forward), single-stage (reverse)
- Cold insulated handle



9013 TT 3/4" Twin Turbo impact wrench

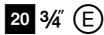

YouTube Clip

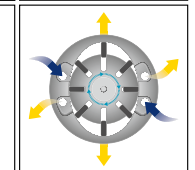
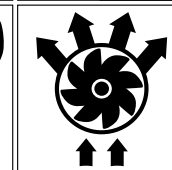
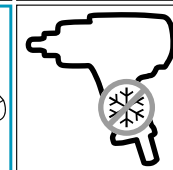
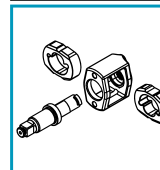
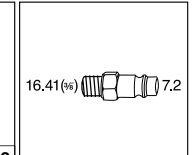
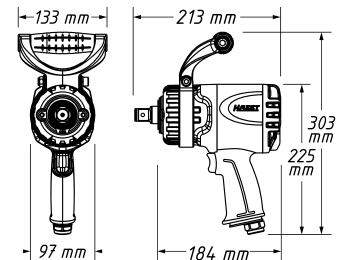
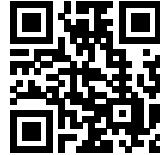

HAZET No.	max. Nm	max. Nm	l/min.	rpm	db(A) LpA	g	EAN-No. 4000896+
9013 TT	4100	2170	243.5	5200	99.5	4500	227143

Low noise hose for noise reduction of the HAZET Turbo Twin impact wrenches 9013TT · 9013Lg TT
Spring clamp for fixing the hose to the handle
9040-013 - - - - - 232994

9013 TT 3/4" Twin Turbo impact wrench · long spindle

• Loosening torque: 3800 Nm

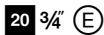

- Exhaust air is guided through the handle downwards
- Reduced vibrations
- Easy handling
- Spindle length 186 mm – for reaching deeply located screw connections
- Strongest HAZET impact wrench ever
- Removable mounting bracket, 360° adjustable
- HAZET Twin Turbo technology – high torques with compact design
- 8-blade air motor with 25% higher impact performance ensures maximum torque
- One-hand operation for right- and left-handed users
- Powerful twin hammer mechanism
- Air connection inlet: inside thread 16.41 mm (5/8")
- Coupler plug: Nominal size 7.2 (included)
- Recommended torque: 1758
- Hose diameter (recommended): 13 mm
- Working pressure (bar): 6.3
- Sound power level: 113.5 db(A) Lp W
- Vibration acceleration: 9.02 m/s²
- Loosening torque (max) determined with screw size M: 32
- Forward and reverse: two-stage (forward), single-stage (reverse)
- Cold insulated handle

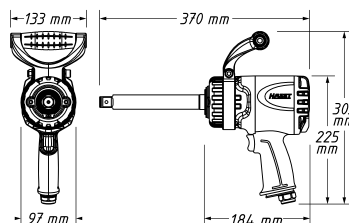



Pneumatic tools · Cordless tools

Impact wrenches



9013 TT 3/4" Twin Turbo impact wrench · long spindle

20 3/4" (E)

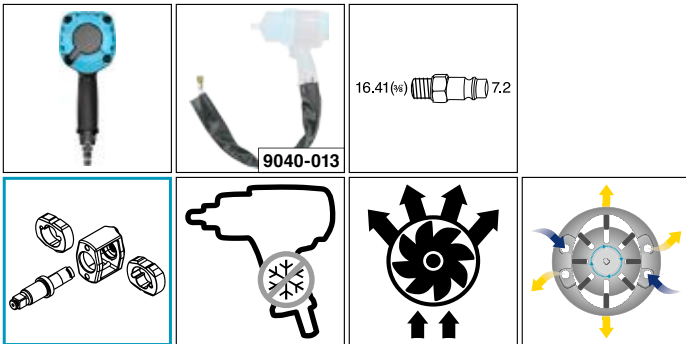

HAZET No.	max. Nm	max. Nm	l/min.	rpm	db(A) LpA	g	EAN-No. 4000896+
9013 LGTT	3800	2020	243	5200	102.5	5500	232277
Low noise hose for noise reduction of the HAZET Turbo Twin impact wrenches 9013TT · 9013Lg TT							
Spring clamp for fixing the hose to the handle							
9040-013	-	-	-	-	-	-	232994

9014 TT 1" Twin Turbo impact wrench

• Loosening torque: 4100 Nm

25 1" (E)

- Exhaust air is guided through the handle downwards
- Reduced vibrations
- Easy handling
- Short, compact design
- One-hand operation for left and right handers
- Removable handle, 360° adjustable
- Connecting socket for low noise hose
- HAZET Twin Turbo technology – high torques with compact design
- 8-blade air motor with 25% higher impact performance ensures maximum torque
- Powerful twin hammer mechanism
- Air connection inlet: inside thread 20.67 mm (1/2")
- Coupler plug: nominal size 10 (included)
- Recommended torque: 1898
- Hose diameter (recommended): 19 mm
- Working pressure (bar): 6.3
- Sound power level: 112.9 db(A) Lp W
- Vibration acceleration: 19.11 m/s²
- Loosening torque (max) determined with screw size M: 32
- Forward and reverse: two-stage (forward), single-stage (reverse)
- Cold insulated handle



9014 TT 1" Twin Turbo impact wrench · long spindle

• Loosening torque: 3850 Nm

25 1" (E)

- Exhaust air is guided through the handle downwards
- Reduced vibrations
- Easy handling
- Short, compact design with 240 mm long spindle
- One-hand operation for left- and right-handed users
- Removable handle, 360° adjustable
- Connecting socket for low noise hose
- HAZET Twin Turbo technology – high torques with compact design
- 8-blade air motor with 25% higher impact performance ensures maximum torque
- Powerful twin hammer mechanism
- Air connection inlet: inside thread 20.67 mm (1/2")
- Coupler plug: nominal size 10 (included)
- Recommended torque: 1627
- Hose diameter (recommended): 19 mm
- Working pressure (bar): 6.3
- Sound power level: 113.5 db(A) Lp W
- Vibration acceleration: 17.31 m/s²
- Loosening torque (max) determined with screw size M: 32
- Forward and reverse: two-stage (forward), single-stage (reverse)
- Cold insulated handle

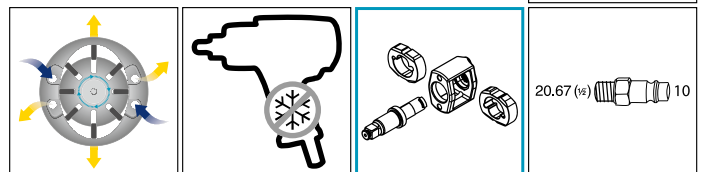
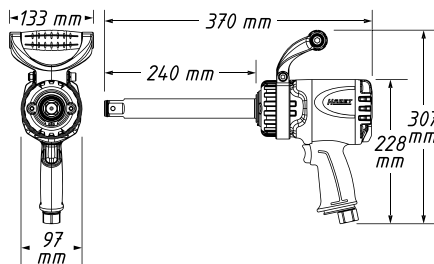
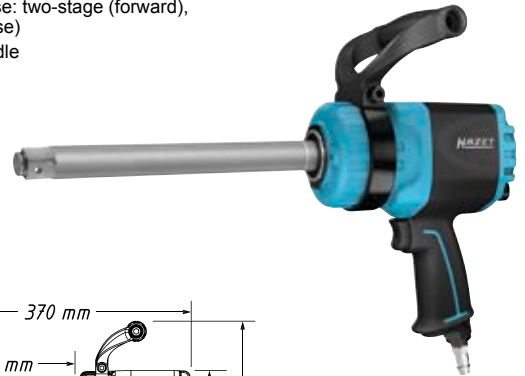

HAZET No.	max. Nm	max. Nm	l/min.	rpm	db(A) LpA	g	EAN-No. 4000896+
9014 LGTT	3850	1762	235	4600	102.5	5900	234677

YouTube Clip

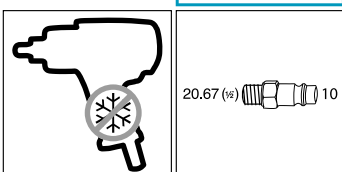
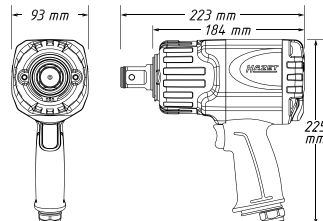
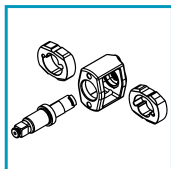

HAZET No.	max. Nm	max. Nm	l/min.	rpm	db(A) LpA	g	EAN-No. 4000896+
9014 TT	4100	2170	235	5200	101.9	4600	234684





9014 P 1" Impact wrench

• Loosening torque: 3400 Nm

25 1" E

- Exhaust air is guided through the handle downwards
- Reduced vibrations
- Easy handling
- Direct hammer striking mechanism
- Air connection inlet: inside thread 20.67 mm (1/2")
- Coupler plug: nominal size 10 (included)
- Recommended torque: 2400
- Hose diameter (recommended): 19 mm
- Working pressure (bar): 6.3
- Sound power level: 114.5 db(A) Lp W
- Vibration acceleration: 15.94 m/s²
- Loosening torque (max) determined with screw size M: 36
- Forward and reverse: three-stage (forward and reverse)
- Cold insulated handle
- Output designed with hole for pinning as well as a nut-driver holder ring
- Operation optimised on both sides for left and right handed users
- One-hand reversing switch
- Extremely powerful tool
- Optimised feel
- Air inlet on the handle at the bottom and rear

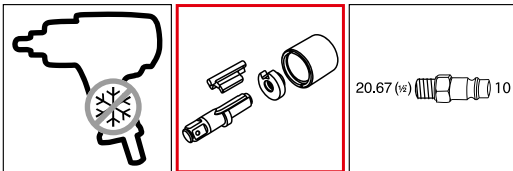
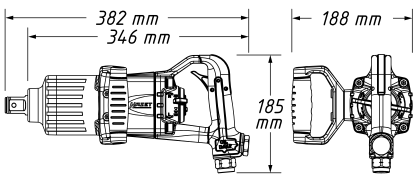

HAZET No.	max Nm	max Nm	l/min.	rpm	db (A) LpA	g	EAN-No. 4000896+
9014 PS-1	3400	2712	283	5500	103.5	7800	222490

9014 P 1" Impact wrench · long spindle

• Loosening torque: 3400 Nm

25 1" E

- Exhaust air is guided through the handle downwards
- Reduced vibrations
- Easy handling
- **Long spindle (240 mm)** for optimal accessibility of wheel bolts
- Direct hammer striking mechanism
- Air connection inlet: inside thread 20.67 mm (1/2")
- Coupler plug: nominal size 10 (included)
- Recommended torque: 2400
- Hose diameter (recommended): 19 mm
- Working pressure (bar): 6.3
- Sound power level: 114.5 db(A) Lp W
- Vibration acceleration: 15.94 m/s²
- Loosening torque (max) determined with screw size M: 36
- Forward and reverse: three-stage (forward and reverse)
- Cold insulated handle
- Output designed with hole for pinning as well as a nut-driver holder ring
- Operation optimised on both sides for left and right handed users
- One-hand reversing switch
- Extremely powerful tool
- Optimised feel
- Air inlet on the handle at the bottom and rear

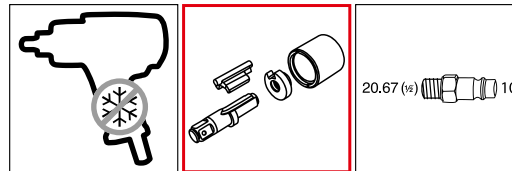
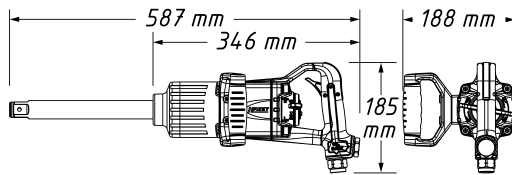
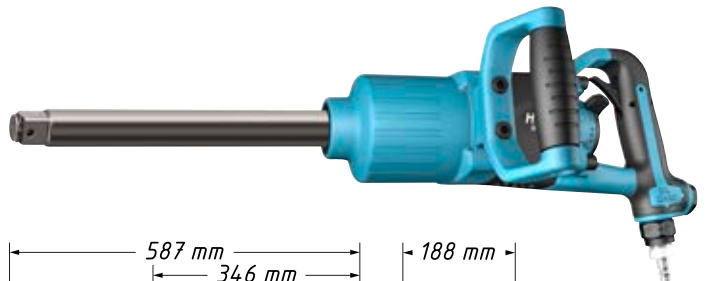

HAZET No.	max Nm	max Nm	l/min.	rpm	db (A) LpA	g	EAN-No. 4000896+
9014 P-1	3400	2712	283	5500	103.5	8580	218332

YouTube Clip

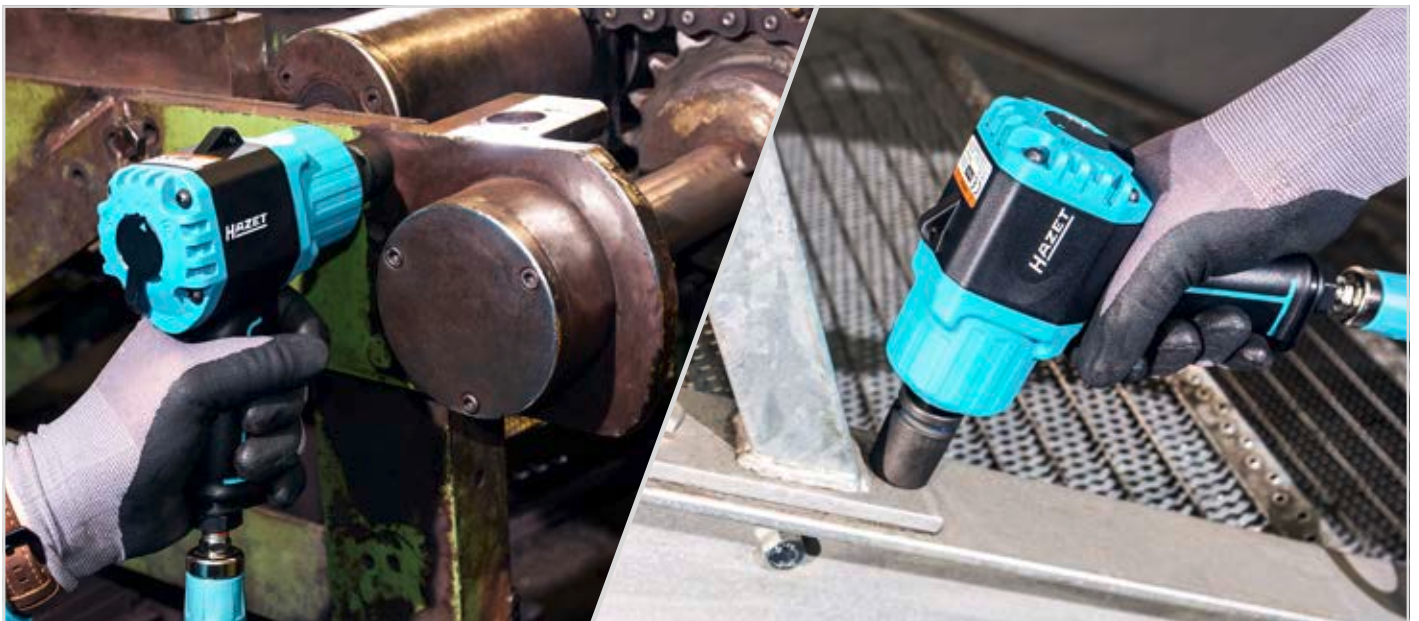



Pneumatic tools · Cordless tools

Air ratchets



Air ratchets

9020 1/4" Air ratchet

- Reduced vibrations
- Air connection inlet: inside thread 12.91 mm (1/4")
- Coupler plug: Nominal size 7.2 (included)
- Working pressure (bar): 6.3
- Sound power level: 89 db(A) Lp W
- Vibration acceleration: 3.30 m/s²
- Forward and reverse: single-stage (right/left)
- Cold insulated handle

6.3 1/4" E

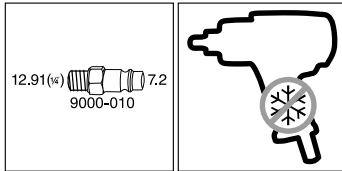
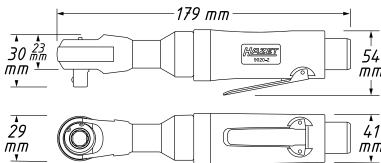

HAZET No.	max. Nm	l/min.	rpm	db (A) LpA	g	EAN-No. 4000896+
9020-2	35	180	170	83	500	109432

9020 1/4" Mini air ratchet

- **Short design**
- **For hand retightening with torque values > 60 Nm**

6.3 1/4" E

- Completely closed head avoids the entry of swarf etc.
- Reduced vibrations
- Air connection inlet: inside thread 12.91 mm (1/4")
- Coupler plug: Nominal size 7.2 (included)
- Hose diameter (recommended): 10 mm
- Working pressure (bar): 6.3
- Sound power level: 101 db(A) Lp W
- Vibration acceleration: 3.30 m/s²
- Forward and reverse: single-stage (right/left)
- Cold insulated handle

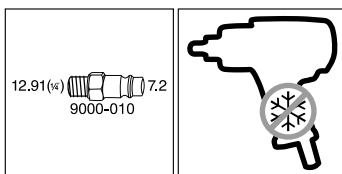
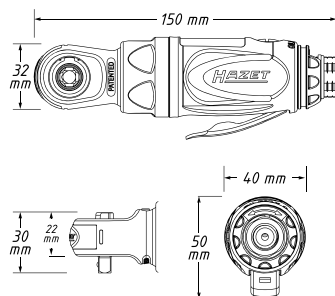

HAZET No.	max. Nm	l/min.	rpm	db (A) LpA	g	EAN-No. 4000896+
9020 P-2	40	72	250	90	500	184323

9023 M 1/4" 3/8" 1/4" Mini multifunctional air ratchet

- Can be used for $\frac{3}{8}$ " $\frac{1}{2}$ " and $\frac{1}{4}$ " by replacing the ratchet heads

6.3 1/4" 10 3/8" 6.3 1/4" E

- Application: With the open 17 mm inside hexagon it is also possible to work on extra long threads
- Short design
- Reduced vibrations
- Exhaust air is guided through the handle
- For manual retightening with torque values 70 Nm
- Air connection inlet: inside thread 12.91 mm (1/4")
- Coupler plug: Nominal size 7.2 (included)
- Hose diameter (recommended): 10 mm
- Working pressure (bar): 6.3
- Sound power level: 93.8 db(A) Lp W
- Vibration acceleration: 3.20 m/s²
- Forward and reverse: single-stage (right/left)
- Cold insulated handle



YouTube Clip



HAZET No.	max. Nm	l/min.	rpm	db (A) LpA	g	EAN-No. 4000896+
-----------	---------	--------	-----	------------	---	------------------

• Contents:						
Push-through ratchet						
Square socket 6.3 mm (1/4 inch)						
Square socket 10 mm (3/8 inch)						
Hexagon screwdriver bit socket 6.3 mm (1/4 inch)						
9023 M-1	54	159	84	400	82.8	480 4 227112
• Square socket 6.3 mm (1/4")						
9023 M-1-020	-	-	-	-	-	- 228225
• Square socket 10 mm (3/8")						
9023 M-1-021	-	-	-	-	-	- 228232
• Hexagon bit socket 6.3 mm (1/4 inch)						
9023 M-1-B	-	-	-	-	-	- 228249

9021 3/8" Air ratchet

- Reduced vibrations
- Air connection inlet: inside thread 12.91 mm (1/4")
- Coupler plug: Nominal size 7.2 (included)
- Working pressure (bar): 6.3
- Sound power level: 89 db(A) Lp W
- Vibration acceleration: 3.30 m/s²
- Forward and reverse: single-stage (right/left)
- Cold insulated handle

10 3/8" E

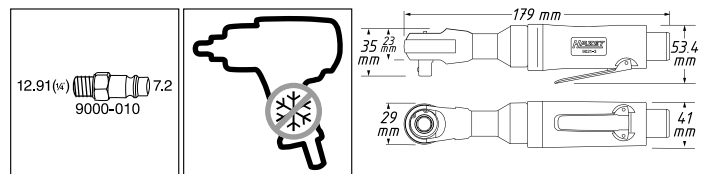

HAZET No.	max. Nm	l/min.	rpm	db (A) LpA	g	EAN-No. 4000896+
9021-3	35	180	170	83	500	116614



9021 3/8" Mini air ratchet

- Short design
- For hand retightening with torque values > 260 Nm

10 3/8" (E)

- Completely closed head avoids the entry of swarf etc.
- Reduced vibrations
- Air connection inlet: inside thread 12.91 mm (1/4")
- Coupler plug: Nominal size 7.2 (included)
- Hose diameter (recommended): 10 mm
- Working pressure (bar): 6.3
- Sound power level: 103 db(A) Lp W
- Vibration acceleration: 3.90 m/s²
- Forward and reverse: single-stage (right/left)
- Cold insulated handle

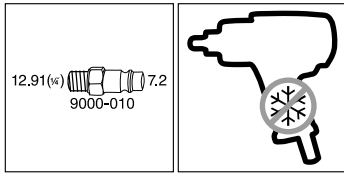
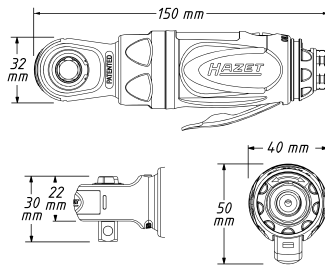

HAZET No.	max. Nm	l/min.	rpm	db (A) LpA	g	EAN-No. 4000896+
9021 P-2	54	103	300	92	500	184545

9022 1/2" Air ratchet

- Reduced vibrations
- Air connection inlet: inside thread 12.91 mm (1/4")
- Coupler plug: Nominal size 7.2 (included)
- Working pressure (bar): 6.3
- Sound power level: 95 db(A) Lp W
- Vibration acceleration: 8.50 m/s²
- Forward and reverse: single-stage (right/left)
- Cold insulated handle

12 1/2" (E)

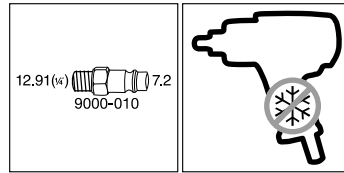
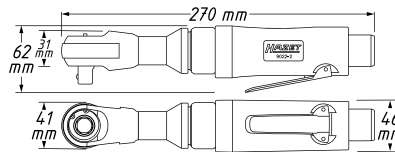

HAZET No.	max. Nm	l/min.	rpm	db (A) LpA	g	EAN-No. 4000896+
9022-2	70	180	160	88	1200	109456

9022 3/8" Impact ratchet

- Maximum occupational safety thanks to reaction-free striking mechanism
- Low-impact
- Rubber ratchet head protective cover to protect against shocks and penetration by dirt

10 3/8" (E)

- Application: Use in constricted spaces
- For hand retightening with torque values: 260 Nm
- Powerful twin hammer mechanism
- Air connection inlet: inside thread 12.91 mm (1/4")
- Coupler plug: Nominal size 7.2 (included)
- Hose diameter (recommended): 10 mm
- Working pressure (bar): 6.3
- Sound power level: 93 db(A) Lp W
- Vibration acceleration: 9.84 m/s²
- Forward and reverse: single-stage (right/left)
- Cold insulated handle

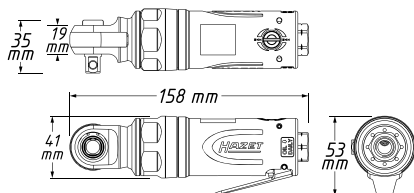

YouTube Clip

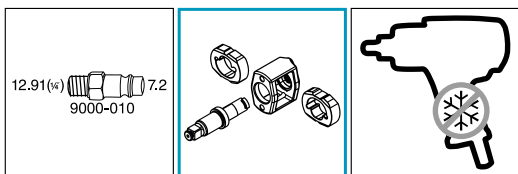

HAZET No.	max. Nm	l/min.	rpm	db (A) LpA	g	EAN-No. 4000896+	
9021 SR-1	68	158	68	500	82	670	218295

9022 1/2" Air ratchet

- For hand retightening with torque values > 400 Nm

12 1/2" (E)

- Completely closed head avoids the entry of swarf etc.
- Reduced vibrations
- Air connection inlet: inside thread 12.91 mm (1/4")
- Coupler plug: Nominal size 7.2 (included)
- Hose diameter (recommended): 10 mm
- Working pressure (bar): 6.3
- Sound power level: 109 db(A) Lp W
- Vibration acceleration: 6.02 m/s²
- Forward and reverse: single-stage (right/left)
- Cold insulated handle

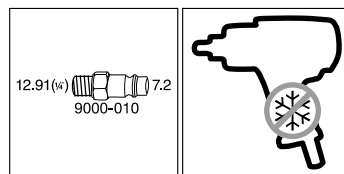
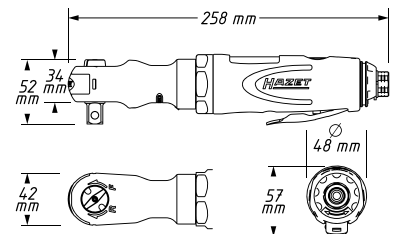

HAZET No.	max. Nm	l/min.	rpm	db (A) LpA	g	EAN-No. 4000896+
9022 P-2	108	113	280	98	1240	184538



Pneumatic tools · Cordless tools

Air ratchets



9022 1/2" High performance air ratchet

• **Sturdy workshop construction – especially suitable for continuous operation in industrial production processes**

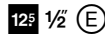

- **Extra-strong head** made of heat-treated special steel
- Sturdy ratchet head suitable for **high permanent stress** (series production and similar)
- Completely closed head avoids the entry of swarf etc.
- **Long service life** and high power rating of the device (long service life = long operational availability)
- For manual retightening with torque values: 350 Nm (competing products approx. 250 Nm)
- Air connection inlet: inside thread 12.91 mm (1/4")
- Coupler plug: Nominal size 7.2 (included)
- Sound power level: 99.3 db(A) Lp W
- Vibration acceleration: 3.00 m/s²
- Forward and reverse: single-stage (right/left)



YouTube Clip

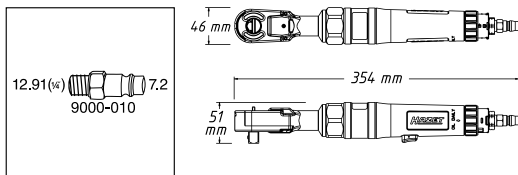

HAZET No.	max. Nm	l/min.	rpm	db(A) LpA	g	EAN-No. 4000896+
9022 P-1	95	77	160	88.3	1390	172269

- **360° rotatable operating lever**
- **30% less noise thanks to the ability to reduce operating noise / Quiet Mode (approx. 10 dB)**
- **Flat head without an interfering edge thanks to the shift lever**
- **Switching between left and right via the adjusting ring on the handle**

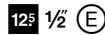

- Application: Operation of screw connections in confined spaces
- Head made of heat-treated special steel
- **Long service life (tool availability)** and equipment load capacity
- Quiet Mode:
 - Sound power level: 92.5 db(A) Lp W
 - Sound pressure level: 81.5 db(A) Lp A
- For manual retightening with torque values: 500 Nm (competing products: approx. 250 Nm)
- Air connection inlet: inside thread 12.91 mm (1/4")
- Coupler plug: Nominal size 7.2 (included)
- Hose diameter (recommended): 10 mm
- Working pressure (bar): 6.3
- Sound power level: 102.2 db(A) Lp W
- Vibration acceleration: 4.87 m/s²
- Forward and reverse: single-stage (right/left)
- Cold insulated handle



YouTube Clip

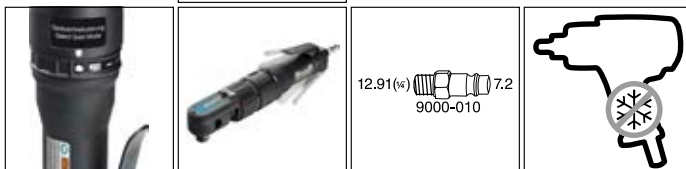
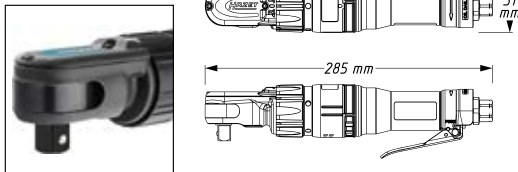

HAZET No.	max. Nm	l/min.	rpm	db(A) LpA	g	EAN-No. 4000896+
9022-360	120	285	107.6	200	91.2	1550 209781

9022 1/2" Impact ratchet

• **High occupational safety thanks to reaction-free striking mechanism**

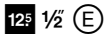

- **Low-impact**
- High torque values – approx. 30% more than standard products
- Rotation speed – approx. 3x higher than standard products
- Suitable for manual retightening with torque values > 270 Nm (competing products with only approx. 250 Nm)
- Powerful pin clutch mechanism
- Air connection inlet: inside thread 12.91 mm (1/4")
- Coupler plug: Nominal size 7.2 (included)
- Hose diameter (recommended): 10 mm
- Working pressure (bar): 6.3
- Sound power level: 98 db(A) Lp W
- Vibration acceleration: 4.53 m/s²
- Forward and reverse: single-stage (right/left)
- Cold insulated handle

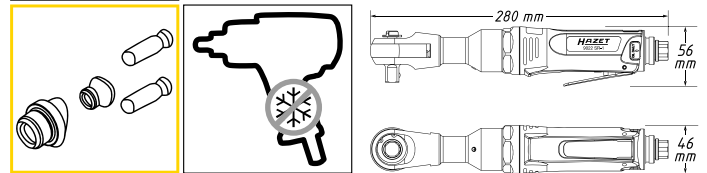
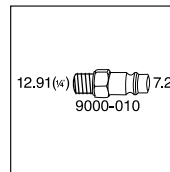

HAZET No.	max. Nm	l/min.	rpm	db(A) LpA	g	EAN-No. 4000896+
9022 SR-1	102	280	113	400	91	1280 170593

9022 1/2" Air ratchet · extra long

• **Reaches even restricted spaces and tolerates high manual retightening forces**

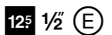

- Application: Slim design, e.g. for the installation and removal of timing chain covers
- For manual retightening with torque values up to 400 Nm
- Reduced vibrations
- Air connection inlet: inside thread 12.91 mm (1/4")
- Coupler plug: Nominal size 7.2 (included)
- Hose diameter (recommended): 10 mm
- Working pressure (bar): 6.3
- Sound power level: 104.7 db(A) Lp W
- Vibration acceleration: 5.60 m/s²
- Forward and reverse: single-stage (right/left)
- Cold insulated handle

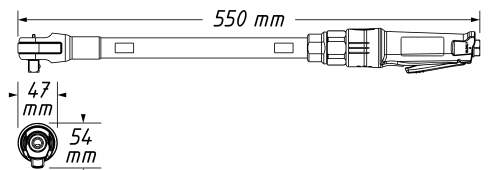

YouTube Clip

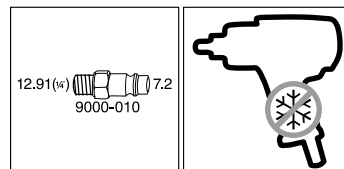
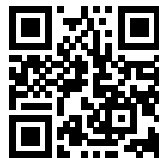

HAZET No.	max. Nm	l/min.	rpm	db(A) LpA	g	EAN-No. 4000896+
9022 P-X Lg	94.8	551	99.12	160	93.7	2100 222513



Drilling and grinding machines

9030 Drilling machine

- Exhaust air is guided downwards through the handle

(E)

- Application: Practical tool especially for car body works and industry
- Quick-clamping drill chuck
- Robust machine housing
- Suitable for continuous operation
- Air connection inlet: inside thread 12.91 mm (1/4")
- Coupler plug: Nominal size 7.2 (included)
- Hose diameter (recommended): 10 mm
- Working pressure (bar): 6.3
- Sound power level: 99.7 db(A) Lp W
- Vibration acceleration: 2.10 m/s²
- Collet chuck: 1 – 10 mm
- Forward and reverse: single-stage (right/left)
- Power in watts: 373 watts
- Cold insulated handle

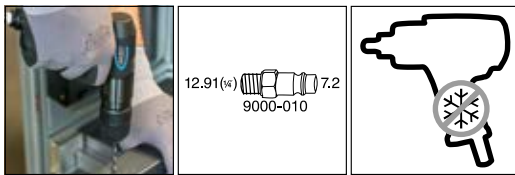
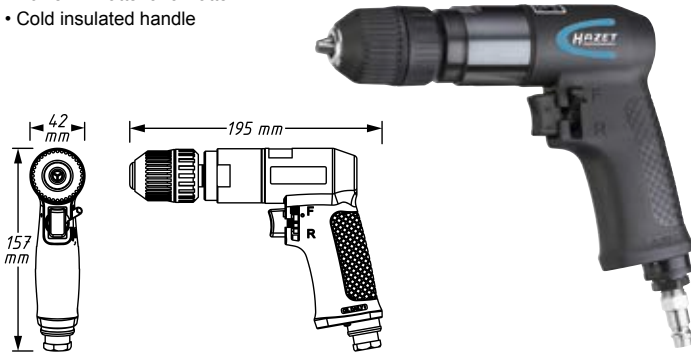

HAZET No.	l/min.	rpm	db (A) LpA	g	EAN-No. 4000896+
9030 N-1	113	2000	88.7	1000	206377

- **Eraser disc** · Removal of decorative strips, foil lettering, adhesive residues from balance weights
- Adapter for socket in 6 mm collet chuck
- Diameter 89 mm
- Thickness 15 mm
- Max. rpm 4000

9030 R-01/2	-	-	-	-	241804
-------------	---	---	---	---	--------

9030 Angle drill

- For working in areas with difficult access

(E)

- Quick-clamping drill chuck
- Exhaust air is guided through the handle backwards
- Air connection inlet: inside thread 12.91 mm (1/4")
- Coupler plug: Nominal size 7.2 (included)
- Hose diameter (recommended): 10 mm
- Working pressure (bar): 6.3
- Sound power level: 96 db(A) Lp W
- Vibration acceleration: 0.50 m/s²
- Collet chuck: 1 – 10 mm
- Forward and reverse: single-stage (right/left)
- Power in watts: 373 watts
- Cold insulated handle



9030 Angle drill

(E)

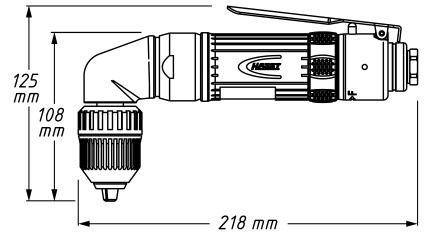
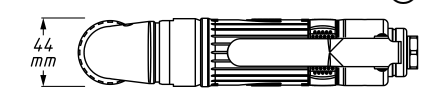
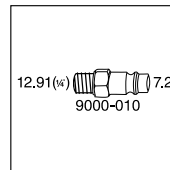

HAZET No.	l/min.	rpm	db (A) LpA	g	EAN-No. 4000896+
9030 N-5	113	1400	85	1200	205554

9030 Drilling machine

- Handy tool with 1–13 mm drill chuck

(E)

- Application: Bodywork and industry
- Exhaust air is guided downwards through the handle
- Quick-clamping drill chuck
- Robust machine housing
- Suitable for continuous operation
- Air connection inlet: inside thread 12.91 mm (1/4")
- Coupler plug: Nominal size 7.2 (included)
- Hose diameter (recommended): 10 mm
- Working pressure (bar): 6.3
- Sound power level: 99.4 db(A) Lp W
- Vibration acceleration: 1.20 m/s²
- Collet chuck: 1 – 13 mm
- Forward and reverse: single-stage (right/left)
- Power in watts: 373 watts
- Cold insulated handle

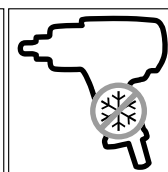
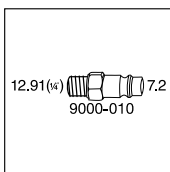
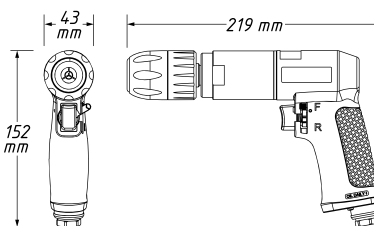

HAZET No.	l/min.	rpm	db (A) LpA	g	EAN-No. 4000896+
9030 P-1	113	800	88.4	1300	212354

- **Eraser disc** · Removal of decorative strips, foil lettering, adhesive residues from balance weights
- Adapter for socket in 6 mm collet chuck
- Diameter 89 mm
- Thickness 15 mm
- Max. rpm 4000

9030 R-01/2	-	-	-	-	241804
-------------	---	---	---	---	--------



Pneumatic tools · Cordless tools

Drilling and grinding machines



9032 Micro die grinder

• Long service life thanks to Kevlar blades

- Application: Precise processing of workpieces even in areas with very restricted access
- Hose length: 1500 mm
- Air connection inlet: inside thread 12.91 mm (1/4")
- Coupler plug: Nominal size 7.2 (included)
- Hose diameter (recommended): 5 mm
- Working pressure (bar): 6.3
- Sound power level: 86.4 db(A) Lp W
- Vibration acceleration: 0.80 m/s²
- Collet chuck: 3 mm
- Power in watts: 190 watts

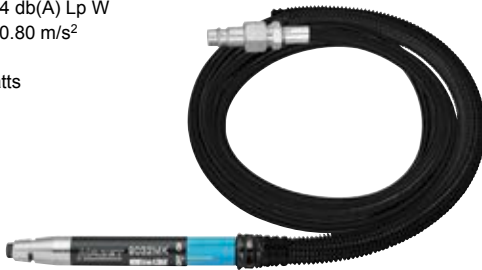

HAZET No.	l/min.	rpm	db(A) LpA	g	□	EAN-No. 4000896+
9032 MK	75	60000	80.4	230	-	248346
<ul style="list-style-type: none"> • Set with 5 different milling cutters (3 mm shaft) in cylindrical, tapered and spherical shape • Head diameter (cylindrical shape): 3 / 6 mm • Head diameter (spherical shape): approx. 3 / 6 mm 						
9032-03/5	-	-	-	-	5	222483

9032 Mini die grinder

• Quiet operation: integrated exhaust hose removes exhaust air from the workpiece and dampens the sound

- Application: Precise work with 3 mm and 6 mm grinding pads even in areas with restricted access
- Slim design
- 6 mm collet chuck with 3 mm adapter to accommodate both grinding pad dimensions
- Tool length: 150 mm
- Tool diameter: 22.2 mm
- Hose length: 1500 mm
- Air connection inlet: inside thread 12.91 mm (1/4")
- Coupler plug: Nominal size 7.2 (included)
- Hose diameter (recommended): 5 mm
- Working pressure (bar): 6.3
- Sound power level: 85.8 db(A) Lp W
- Vibration acceleration: 1.80 m/s²
- Collet chuck: 6 mm
- Power in watts: 224 watts

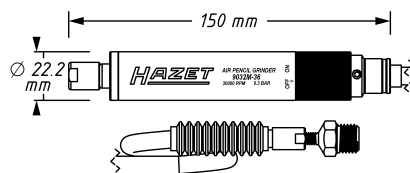
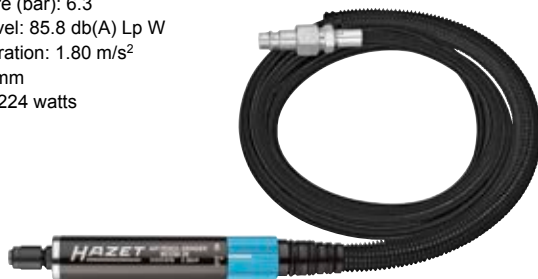

9032 Mini die grinder



HAZET No.	l/min.	rpm	db(A) LpA	g	□	EAN-No. 4000896+
9032 M-36	43.7	30000	78.7	380	-	209606
<ul style="list-style-type: none"> • Set with 5 different milling cutters (3 mm shaft) in cylindrical, tapered and spherical shape • Head diameter (cylindrical shape): 3 / 6 mm • Head diameter (spherical shape): approx. 3 / 6 mm 						
9032-03/5	-	-	-	-	5	222483
<ul style="list-style-type: none"> • Set with 3 different milling cutters (6 mm shaft) in cylindrical, tapered and spherical shape • Head diameter (cylindrical shape): 10 mm • Head diameter (spherical shape): approx. 9 mm 						
9032-06/3	-	-	-	-	3	222667

9032 Micro die grinder · angled

• Long service life thanks to high-quality Kevlar blades

- Application: Precise processing of workpieces even in areas with very restricted access
- Air connection inlet: inside thread 12.91 mm (1/4")
- Coupler plug: Nominal size 7.2 (included)
- Hose diameter (recommended): 10 mm
- Working pressure (bar): 6.3
- Sound power level: 78.1 db(A) Lp W
- Vibration acceleration: 0.37 m/s²
- Collet chuck: 3 mm
- Power in watts: 186.4 watts
- Hose length: 1500 m

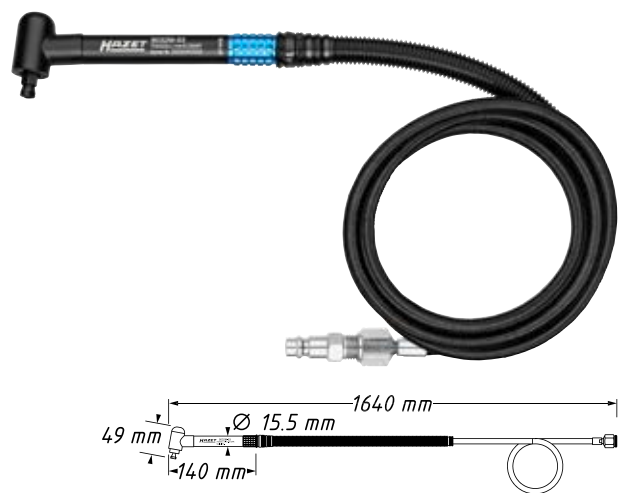

HAZET No.	l/min.	rpm	db(A) LpA	g	□	EAN-No. 4000896+
9032 M-53	150	70000	77.7	230	-	246205
<ul style="list-style-type: none"> • Set with 5 different milling cutters (3 mm shaft) in cylindrical, tapered and spherical shape • Head diameter (cylindrical shape): 3 / 6 mm • Head diameter (spherical shape): approx. 3 / 6 mm 						
9032-03/5	-	-	-	-	5	222483



9032 Die grinder · straight design

- **Lightweight, handy device for grinding, polishing, burnishing and deburring**

• Straight design

- Stepless speed regulation via setting wheel on the top of the device
- 360° exhaust (adjustable)
- Air connection inlet: inside thread 12.91 mm (1/4")
- Coupler plug: Nominal size 7.2 (included)
- Hose diameter (recommended): 10 mm
- Working pressure (bar): 6.3
- Sound power level: 85 db(A) Lp W
- Vibration acceleration: 0.40 m/s²
- Collet chuck: 6 mm
- Power in watts: 224 watts
- Cold insulated handle

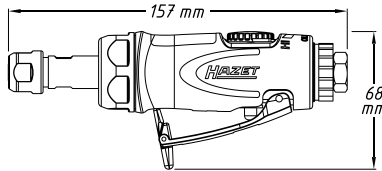

YouTube Clip



HAZET No.	l/min.	rpm	db(A) LpA	g	□	EAN-No. 4000896+
9032 N-1	74	2000–25000	79	400	–	189359
• Collet chuck \varnothing 3 mm						
• For 9032Lg-1 · 9032M · 9032M-1 · 9032M-5 · 9032N-1 · 9032N-5 · 9032P-1						
9032-03 S	–	–	–	–	–	228928
• Set with 3 different milling cutters (6 mm shaft) in cylindrical, tapered and spherical shape						
• Head diameter (cylindrical shape): 10 mm						
• Head diameter (spherical shape): approx. 9 mm						
9032-06/3	–	–	–	–	3	222667

9032 Die grinder · angled

- **Sanding, buffing, polishing and deburring, particularly in areas that are difficult to access**

• Angled design

- Stepless speed regulation via setting wheel on the top of the device
- 360° exhaust (adjustable)
- Air connection inlet: inside thread 12.91 mm (1/4")
- Coupler plug: Nominal size 7.2 (included)
- Hose diameter (recommended): 10 mm
- Working pressure (bar): 6.3
- Sound power level: 82 db(A) Lp W
- Vibration acceleration: 0.50 m/s²
- Collet chuck: 6 mm
- Power in watts: 224 watts
- Cold insulated handle



YouTube Clip

9032 Die grinder · angled

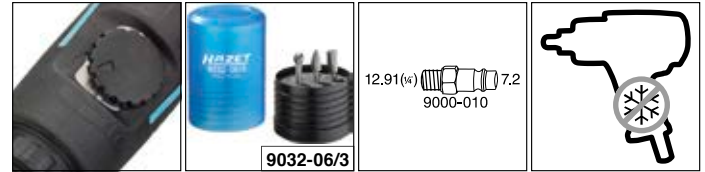
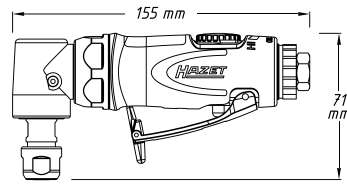

HAZET No.	l/min.	rpm	db(A) LpA	g	□	EAN-No. 4000896+
9032 N-5	74	2000–20000	78	500	–	198788
• Collet chuck \varnothing 3 mm						
• For 9032Lg-1 · 9032M · 9032M-1 · 9032M-5 · 9032N-1 · 9032N-5 · 9032P-1						
9032-03 S	–	–	–	–	–	228928
• Set with 3 different milling cutters (6 mm shaft) in cylindrical, tapered and spherical shape						
• Head diameter (cylindrical shape): 10 mm						
• Head diameter (spherical shape): approx. 9 mm						
9032-06/3	–	–	–	–	3	222667

9032 Die grinder · straight design

- **Extremely powerful device (700 watts)**

- Application: Grinding, polishing, burnishing and deburring

• Straight design

- Air connection inlet: inside thread 12.91 mm (1/4")
- Coupler plug: Nominal size 7.2 (included)
- Hose diameter (recommended): 10 mm
- Working pressure (bar): 6.3
- Sound power level: 98 db(A) Lp W
- Vibration acceleration: 0.46 m/s²
- Collet chuck: 6 mm
- Power in watts: 700 watts
- Cold insulated handle

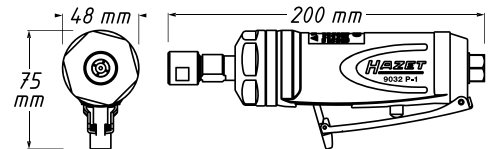

YouTube Clip

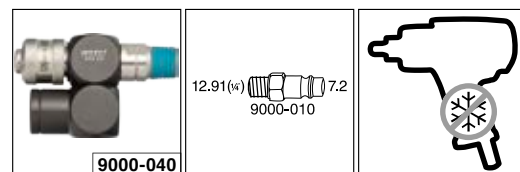

HAZET No.	l/min.	rpm	db(A) LpA	g	□	EAN-No. 4000896+
9032 P-1	150	22000	87	800	–	190508
• Collet chuck \varnothing 3 mm						
• For 9032Lg-1 · 9032M · 9032M-1 · 9032M-5 · 9032N-1 · 9032N-5 · 9032P-1						
9032-03 S	–	–	–	–	–	228928



9032 Die grinder · straight design

(E)

HAZET No.	l/min.	rpm	db(A) LpA	g	□	EAN-No. 4000896+
<ul style="list-style-type: none"> • 360° rotatable hinge on 2 axes • Air flow regulation by means of setting wheel 						
9000-040	-	-	88	-	-	195350
<ul style="list-style-type: none"> • Set with 3 different milling cutters (6 mm shaft) in cylindrical, tapered and spherical shape • Head diameter (cylindrical shape): 10 mm • Head diameter (spherical shape): approx. 9 mm 						
9032-06/3	-	-	-	3	-	222667
<ul style="list-style-type: none"> • Eraser disc · Removal of decorative strips, foil lettering, adhesive residues from balance weights • Adapter for socket in 6 mm collet chuck • Diameter 89 mm • Thickness 15 mm • Max. rpm 4000 						
9030 R-01/2	-	-	-	-	-	241804

9032 Die grinder · straight design · long

(E)

- **Straight, long design for improved handling / guidance**
- Application: Handy device for grinding, polishing, burnishing, deburring
- Stepless speed regulation via setting wheel on top of the device
- Four-jaw chuck
- Wide contact surface of the trigger for easy handling
- Optimised transmission of the trigger provides optimal dosage
- Air connection inlet: inside thread 12.91 mm (1/4")
- Coupler plug: Nominal size 7.2 (included)
- Hose diameter (recommended): 10 mm
- Working pressure (bar): 6.3
- Sound power level: 78 db(A) Lp W
- Vibration acceleration: 0.50 m/s²
- Collet chuck: 6 mm
- Power in watts: 360 watts
- Cold insulated handle

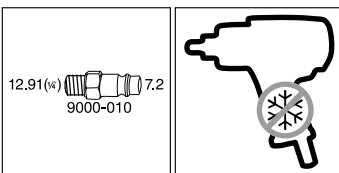
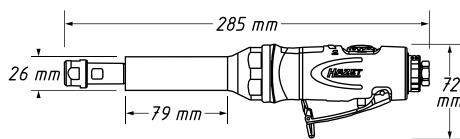

HAZET No.	l/min.	rpm	db(A) LpA	g	□	EAN-No. 4000896+
9032 LG-1	99	2000-22000	81	600	-	209675
<ul style="list-style-type: none"> • Collet chuck ∅ 3 mm • For 9032Lg-1 · 9032M · 9032M-1 · 9032M-5 · 9032N-1 · 9032N-5 · 9032P-1 						
9032-03 S	-	-	-	-	-	228928
<ul style="list-style-type: none"> • Set with 3 different milling cutters (6 mm shaft) in cylindrical, tapered and spherical shape • Head diameter (cylindrical shape): 10 mm • Head diameter (spherical shape): approx. 9 mm 						
9032-06/3	-	-	-	3	-	222667
<ul style="list-style-type: none"> • Eraser disc · Removal of decorative strips, foil lettering, adhesive residues from balance weights • Adapter for socket in 6 mm collet chuck • Diameter 89 mm • Thickness 15 mm • Max. rpm 4000 						
9030 R-01/2	-	-	-	-	-	241804

9032 Mini die grinder · straight design

(E)

- **For working in areas with difficult access**
- Application: Lightweight, handy device for grinding, polishing, burnishing and deburring
- **Straight design**
- Exhaust air is guided through the handle
- Air connection inlet: inside thread 12.91 mm (1/4")
- Coupler plug: Nominal size 7.2 (included)
- Hose diameter (recommended): 10 mm
- Working pressure (bar): 6.3
- Sound power level: 93.4 db(A) Lp W
- Vibration acceleration: 1.80 m/s²
- Collet chuck: 6 mm
- Power in watts: 224 watts
- Cold insulated handle

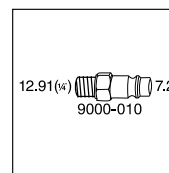
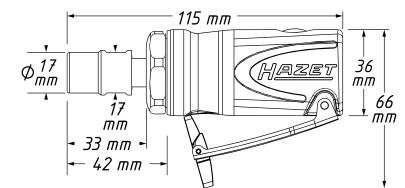

YouTube Clip

HAZET No.	l/min.	rpm	db(A) LpA	g	□	EAN-No. 4000896+
9032 M-1	84	25000	82.4	330	-	227099
<ul style="list-style-type: none"> • Collet chuck ∅ 3 mm • For 9032Lg-1 · 9032M · 9032M-1 · 9032M-5 · 9032N-1 · 9032N-5 · 9032P-1 						
9032-03 S	-	-	-	-	-	228928
<ul style="list-style-type: none"> • Set with 3 different milling cutters (6 mm shaft) in cylindrical, tapered and spherical shape • Head diameter (cylindrical shape): 10 mm • Head diameter (spherical shape): approx. 9 mm 						
9032-06/3	-	-	-	3	-	222667





9032 Mini die grinder · angled

• Heavy-duty multi-bearing gearbox with a 2.5-times longer service life compared to conventional gearboxes (E)

- Application: Lightweight, handy device for grinding, polishing, burnishing and deburring
- **Angled design** for working in tight areas
- Exhaust air is guided through the handle
- Air connection inlet: inside thread 12.91 mm (1/4")
- Coupler plug: Nominal size 7.2 (included)
- Hose diameter (recommended): 10 mm
- Working pressure (bar): 6.3
- Sound power level: 92.9 db(A) Lp W
- Vibration acceleration: 5.10 m/s²
- Collet chuck: 6 mm
- Power in watts: 224 watts
- Cold insulated handle

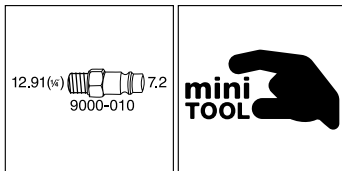
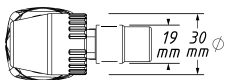
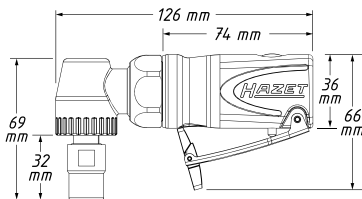

YouTube Clip

HAZET No.	l/min.	rpm	db(A) LpA	g	□	EAN-No. 4000896+
9032 M-5	84	18000	81.9	480	-	227105
• Collet chuck \varnothing 3 mm						
• For 9032Lg-1 · 9032M · 9032M-1 · 9032M-5 · 9032N-1 · 9032N-5 · 9032P-1						
9032-03 S	-	-	-	-	-	228928
• Set with 3 different milling cutters (6 mm shaft) in cylindrical, tapered and spherical shape						
• Head diameter (cylindrical shape): 10 mm						
• Head diameter (spherical shape): approx. 9 mm						
9032-06/3	-	-	-	3	-	222667

9033 Orbital sander

• Dust extraction (E)

- Suction hose (2.0 m) and collection bag included
- Continuous speed regulation
- Low height and light composite housing
- Grinding disc with 15 bore holes, \varnothing 150 mm with hook and loop fastener
- Anti-slip handle
- Air connection inlet: inside thread 12.91 mm (1/4")
- Coupler plug: Nominal size 7.2 (included)
- Working pressure (bar): 6.3
- Sound power level: 93.8 db(A) Lp W
- Vibration acceleration: 5.35 m/s²
- Stroke: 5 mm
- Power in watts: 375 watts

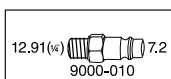
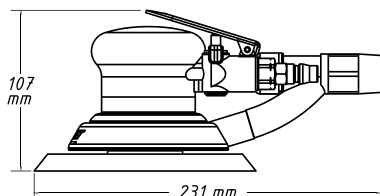

9033 Orbital sander

HAZET No.	l/min.	rpm	db(A) LpA	g	EAN-No. 4000896+
9033-2	57	12000	88.8	900	156337
Grinding pads					
For orbital sander 9033-1 and -2					
6 holes					
For metalworking. \varnothing 150 mm.					
Pack contents 10 pieces					
Grain size 80					
9033-180/10	-	-	-	161	139330
Grain size 100					
9033-1100/10	-	-	-	133	139347
Grain size 120					
9033-1120/10	-	-	-	139	139354
Grain size 150					
9033-1150/10	-	-	-	123	139361
15-hole grinding disc					
For Orbital sander 9033-2					
• Medium hard with fiber-reinforced rear side					
• With hook and loop fastener					
• \varnothing 150 mm with 1/4" thread					
9033-020	-	-	-	170	156351

9033 Belt sanders

• Continuous speed regulation via speed regulator on back of handle (E)

- Application: For narrow surfaces (belt width 10 mm)
- Locking device for quick belt changing
- For abrasive belts 10 x 330 mm
- Automatic belt adjustment
- Fine adjustment of belt
- 360° rotatable belt run
- Belt speed: 1370 m / min
- Incl. hex-head wrench for fine adjustment of the belt and angle setting in the handle
- Air connection inlet: inside thread 12.91 mm (1/4")
- Coupler plug: Nominal size 7.2 (included)
- Hose diameter (recommended): 10 mm
- Working pressure (bar): 6.3
- Sound power level: 94.8 db(A) Lp W
- Vibration acceleration: 1.88 m/s²
- Power in watts: 417.6 watts
- Cold insulated handle

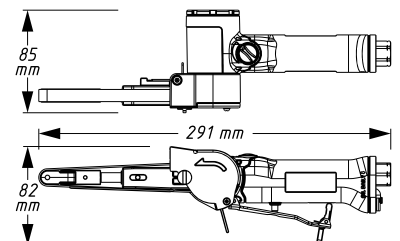
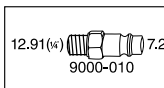

HAZET No.	l/min.	rpm	db(A) LpA	g	EAN-No. 4000896+
9033 N-4	94	19000	83.8	810	210183
Abrasive belts					
For belt sander 9033N-4					
330 x 10 mm. Pack contents 10 pieces.					
Grain size 80					
9033-480/10	-	-	-	39	139101
Grain size 100					
9033-4100/10	-	-	-	35	139118
Grain size 120					
9033-4120/10	-	-	-	32	139125



Pneumatic tools · Cordless tools

Drilling and grinding machines



9033 Mini orbital sander set

• For working in areas with restricted access and repair work



- 36-piece set, contents:
 - 1 orbital sander
 - 2 grinding discs 50 mm (2") and 75 mm (3")
 - 10 grinding pads each, grain size 320 / 400 / 600
 - 1 adjusting wrench
- With hook and loop fastener
- Grinding disc thread: M 6
- Air connection inlet: inside thread 12.91 mm (1/4")
- Coupler plug: Nominal size 7.2 (included)
- Hose diameter (recommended): 10 mm
- Working pressure (bar): 6.3
- Sound power level: 93 db(A) Lp W
- Vibration acceleration: 0.77 m/s²
- Power in watts: 238 watts
- Cold insulated handle

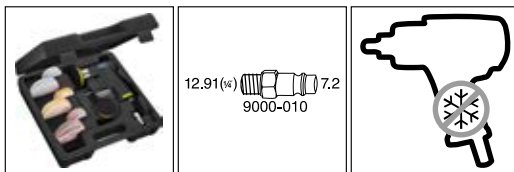
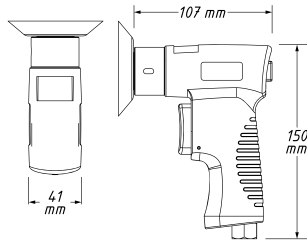

HAZET No.	l/min.	rpm	db (A) LpA	g	EAN-No. 4000896+
9033 N-5	79	15000	80	640	205585
• 10 spare grinding pads, 320 grain size, Ø 50 mm					
9033-5-01/10	–	–	–	10	160525
• 10 spare grinding pads, 400 grain size, Ø 50 mm					
9033-5-02/10	–	–	–	7	160730
• 10 spare grinding pads, 600 grain size, Ø 50 mm					
9033-5-03/10	–	–	–	18	160747
• 10 spare grinding pads, 320 grain size, Ø 75 mm					
9033-5-04/10	–	–	–	21	160754
• 10 spare grinding pads, 400 grain size, Ø 75 mm					
9033-5-05/10	–	–	–	14	160761
• 10 spare grinding pads, 600 grain size, Ø 75 mm					
9033-5-06/10	–	–	–	20	160778

9033 Multi sander

• Multi sander for use with brush belts, strip wheels and foil erasers



- Application: Removal of underseal, sealing compound, rust, corrosion, paint, plastic film, labels as well as for paint stripping
- Continuous speed regulation via speed regulator on back of handle
- 180° adjustable handle
- Spindle size: 9 mm (Hex)
- Delivery without accessories
- Air connection inlet: inside thread 12.91 mm (1/4")
- Coupler plug: Nominal size 7.2 (included)
- Hose diameter (recommended): 10 mm
- Working pressure (bar): 6.3
- Sound power level: 82 db(A) Lp W
- Vibration acceleration: 0.80 m/s²
- Power in watts: 370 watts
- Cold insulated handle

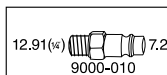

9033 Multi sander

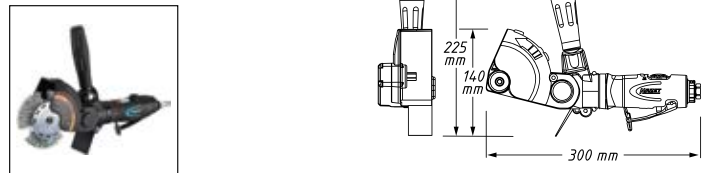

HAZET No.	l/min.	rpm	db (A) LpA	g	EAN-No. 4000896+
9033 N-6	102	4000	79	1200	209743
• 5 foil erasers (lighter design)					
• Adapter 9033-6-010 is required					
9033-6-01/5	–	–	–	1290	160167
• 5 foil erasers (darker version)					
• For water-based paints					
• Adapter 9033-6-010 is required					
9033-6-01 A/5	–	–	–	1280	160228
• 5 brush belts 23 mm wide, coarse, bent tips, hardened					
• Removing underbody protection and sealing putty, as well as paint stripping with rough sand-blasting effect					
• Adapter 9033-6-010 is required					
9033-6-02/5	–	–	–	280	160174
• 5 brush belts 11 mm wide, coarse, bent tips, hardened					
• Removing underbody protection and sealing putty, as well as paint stripping with rough sand-blasting effect					
• Adapter 9033-6-011 is required					
9033-6-03/5	–	–	–	140	160181
• 5 strip wheels					
• Adapter 9033-6-041 or 9033-6-040 is required					
9033-6-04/5	–	–	–	150	160198
• 5 brush belts 11 mm wide, fine, straight tips, hardened					
• Removing paint and rust, without sand-blasting effect					
• Adapter 9033-6-011 is required					
9033-6-05/5	–	–	–	120	160204
• 5 brush belts 23 mm wide, fine, straight tips, hardened					
• Removing paint and rust, without sand-blasting effect					
• Adapter 9033-6-010 is required					
9033-6-06/5	–	–	–	260	160211
• 1 piece adapter, 23 mm wide for brush belts 9033-6-02/5 · 9033-6-06/5 and foil erasers 9033-6-01/5 · 9033-6-01A/5					
9033-6-010	–	–	–	–	213672
• 1 piece adapter, 11 mm wide for brush belts (9033-6-03/5 · 9033-6-05/5)					
9033-6-011	–	–	–	–	213665
• 1 piece adapter for double strip wheels 9033-6-04/5					
9033-6-040	–	–	–	–	213641
• 1 piece adapter for single strip wheels 9033-6-04/5					
9033-6-041	–	–	–	–	213658



9033 Mini polisher set

• For working in areas with restricted access and repair work



- 6-piece set, contents:
 - 1 polisher
 - 1 wet grinding pad, 75 mm Ø
 - 1 hard plastic pad (yellow),
 - 1 soft plastic pad (white),
 - 1 lambskin
 - 1 adjusting wrench
- Grinding disc thread M6
- Air connection inlet: inside thread 12.91 mm (1/4")
- Coupler plug: Nominal size 7.2 (included)
- Hose diameter (recommended): 10 mm
- Working pressure (bar): 6.3
- Sound power level: 96.76 db(A) Lp W
- Vibration acceleration: 2.43 m/s²
- Power in watts: 238 watts
- Cold insulated handle

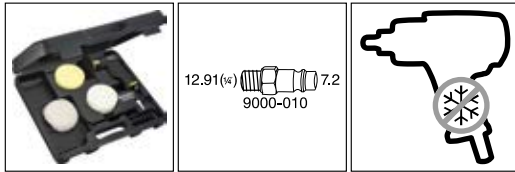
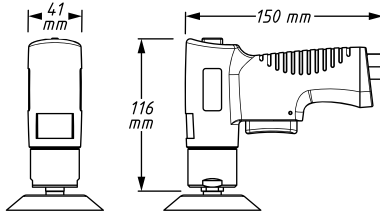

HAZET No.	l/min.	rpm	db(A) LpA	g	EAN-No. 4000896+
9033 N-9	91	3200	85.76	720	205561
• 5 plastic pads yellow hard, foam pad for polishing in the first work step					
9033-9-02/5	-	-	-	50	160556
• 5 plastic pads white soft, for polishing in the second work step					
9033-9-03/5	-	-	-	80	160563
• Lambskin 5 items For 9033-9					
9033-9-04/5	-	-	-	80	160570

9033 Right-angle grinder

- Lateral handle, to be used on left or right side
- Quick adjustment of protection cover without tools
- For grinding discs up to a thickness of 0.8–6 mm
- Spindle thread: M14x2
- For grinding wheels 125x22 mm
- Spindle lock
- Air connection inlet: inside thread 12.91 mm (1/4")
- Coupler plug: Nominal size 7.2 (included)
- Hose diameter (recommended): 10 mm
- Working pressure (bar): 6.3
- Sound power level: 96 db(A) Lp W
- Vibration acceleration: 6.50 m/s²
- Power in watts: 671 watts
- Cold insulated handle

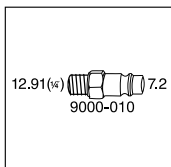

9033 Right-angle grinder

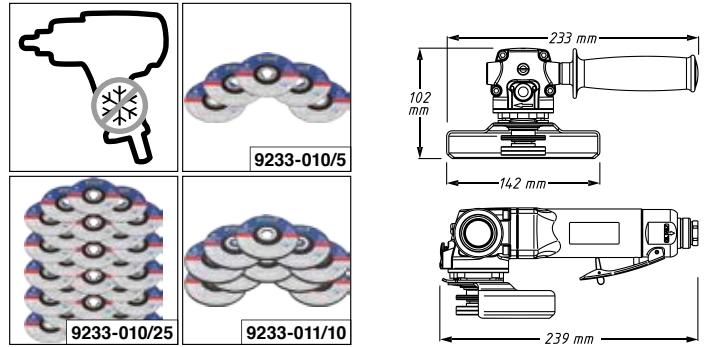

HAZET No.	l/min.	rpm	db(A) LpA	g	EAN-No. 4000896+
9033 N-7	113	12000	85	2000	205547
• 5 cut-off wheels 125 x 1 x 22.23 mm (5 x 0.40 x 7/8")					
• For cordless right-angle grinders 9233-7 · 9233-7/4					
• 41 AS 60 PBF-RCF80					
• Suitable for stainless steel · mild steel · thin-walled sheets · profiles · tubes					
• Standards: DIN EN 12413 and oSa					
• Maximum rotation speed 12200 rpm					
• Maximum cutting speed 80 m/s					
9233-010/5	-	-	-	5	219063
• 25 cut-off wheels 125 x 1 x 22.23 mm (5 x 0.40 x 7/8")					
• For cordless right-angle grinders 9233-7 · 9233-7/4					
• 41 AS 60 PBF-RCF80					
• Suitable for stainless steel · mild steel · thin-walled sheets · profiles · tubes					
• Standards: DIN EN 12413 and oSa					
• Maximum rotation speed 12200 rpm					
• Maximum cutting speed 80 m/s					
9233-010/25	-	-	-	25	219070
• 10 rough grinding wheels 125 x 6 x 22.23 mm (5 x 1/4 x 7/8")					
• For cordless right-angle grinders 9233-7 · 9233-7/4					
• 27 AS 24 O7 BF					
• Also suitable for stainless steel					
• Standards: DIN EN 12413 and oSa					
• Maximum rotation speed 12200 rpm					
• Maximum cutting speed 80 m/s					
9233-011/10	-	-	-	10	219087

9033 Angle grinder

• Extra flat grinding head – only 46 mm



- Application: For working areas with restricted access, suitable for cutting metal sheet and steel
- Especially suitable for application in areas with restricted access, e.g. cutting of exhaust pipe clamps when installed
- Reduced vibrations
- Quick adjustment (without tools) of protective cover
- Pressure key for locking the output (spindle locking) enables easy changing of cut-off wheels
- Diameter of the wheel holder: 10 mm (3/8")
- Including 1 cut-off wheel 100x0.8x9.53 mm
- Screw for fixing the abrasive media: strength class 12.9
- Air connection inlet: inside thread 12.91 mm (1/4")
- Coupler plug: Nominal size 7.2 (included)
- Hose diameter (recommended): 10 mm
- Working pressure (bar): 6.3
- Sound power level: 100.5 db(A) Lp W
- Vibration acceleration: 3.65 m/s²
- Power in watts: 700 watts
- Cold insulated handle



YouTube Clip





Pneumatic tools · Cordless tools

Drilling and grinding machines



9033 Angle grinder

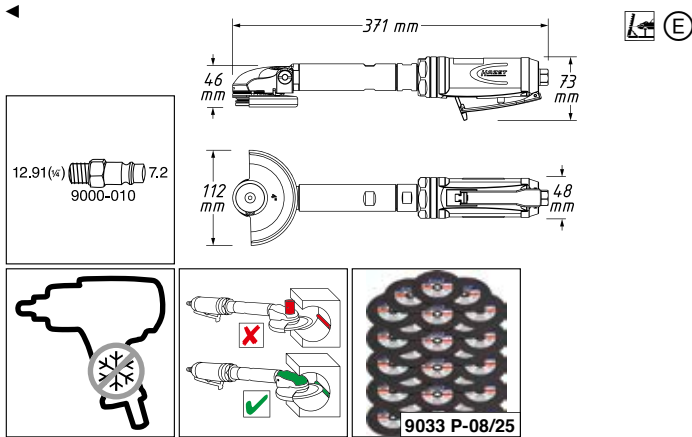

HAZET No.	l/min.	rpm	db(A) LpA	g	■	EAN-No. 4000896+
9033 P-8	113	14000	89.5	1700	-	190515
5 cut-off wheels 100 x 1 x 9.53 mm						
• For angle grinder 9033P-8						
• Standards: EN 12413 and OSA						
• Also suitable for stainless steel						
9033 P-08/5	-	-	-	-	5	201549
25 cut-off wheels 100 x 1 x 9.53 mm						
• For angle grinder 9033P-8						
• Standards: EN 12413 and OSA						
• Also suitable for stainless steel						
9033 P-08/25	-	-	-	-	25	201402

9033 Angle grinder

• Processing of workpieces even in areas with very restricted access (E)

- For cut-off wheels 76 x 2.1 x 10 mm
- Wheel holder: 10 mm
- Continuous speed regulation on the bottom of the device
- Direction of movement (right/left) on the upper side of the device can be selected for controlling the flying sparks as well as for improving the ergonomic working posture
- Including 1 cut-off wheel
- Air connection inlet: inside thread 12.91 mm (1/4")
- Coupler plug: Nominal size 7.2 (included)
- Hose diameter (recommended): 10 mm
- Working pressure (bar): 6.3
- Sound power level: 88 db(A) Lp W
- Vibration acceleration: 1.80 m/s²
- Power in watts: 522 watts
- Cold insulated handle



YouTube Clip

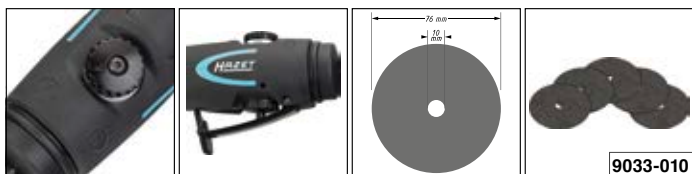
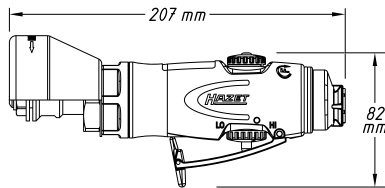

9033 Angle grinder

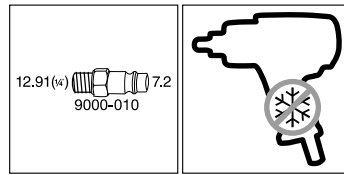

HAZET No.	l/min.	rpm	db(A) LpA	g	■	EAN-No. 4000896+
9033-10	114	2000-18000	88	900	-	196371
5 cut-off wheels 76 x 2.1 x 10.0 mm						
• For angle grinder 9033-10						
• Also suitable for stainless steel						
• Maximum rotation speed 20100 rpm						
• Maximum cutting speed 80 m/s						
9033-010/5	-	-	-	-	5	199969





9033 Bristle grinder set

- Gentle, effective cleaning of surfaces
- Roloc™ quick-change system allows the abrasive media to be changed quickly and easily without needing to use any extra tools



• Application: For using with various grinding media to remove rust, paint, adhesive and sealing residues or to clean metal surfaces and weld seams when using various abrasive media

• Grinding disc thread 1/4 inch–20 UNC

• Dimensions: 112.1 x 152 x 45 mm

• Contents:

- 1 basic unit including air connection nipple
- 1 Roloc® System bristle grinding disc (50 mm Ø)
- 4 violet strip wheels (hard)
- 4 black strip wheels (soft)
- 2 violet high-performance disc bristle grinders (grain size 36)
- 2 green high-performance disc bristle grinders (grain size 50)
- 2 white high-performance disc bristle grinders (grain size 120)
- 1 assembly tool

• Air connection inlet: inside thread 12.91 mm (1/4")

• Coupler plug: Nominal size 7.2 (included)

• Hose diameter (recommended): 10 mm

• Working pressure (bar): 6.3

• Sound power level: 86 db(A) Lp W

• Vibration acceleration: 3.11 m/s²

• Power in watts: 224 watts

• Cold insulated handle



YouTube Clip

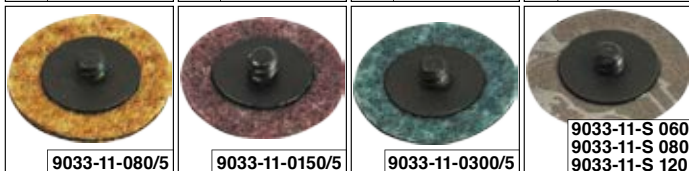
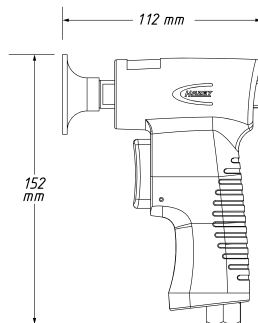

HAZET No.	l/min.	rpm	db (A) LpA	g	W	EAN-No. 4000896+
9033-11/17	79	15000	75	540	17	222575

Bristle grinding disc

For adaptation of abrasive substances such as strip wheel and brush wheels with Roloc® quick-change system

- Roloc® quick-change system for quick, tool-free assembly
- Diameter: 50 mm
- Thread: 1/4"–20 UNC

9033-11-015	-	-	-	-	-	222841
-------------	---	---	---	---	---	--------

9033 Bristle grinder set



HAZET No.	l/min.	rpm	db (A) LpA	g	W	EAN-No. 4000896+
-----------	--------	-----	------------	---	---	------------------

Strip wheel set, 4 pieces

For work on tough surfaces

- Hard variant
- For rust removal, paint stripping, cleaning welding seams, removing severe surface contamination and coatings
- For stainless steel, FE metal, non-ferrous metal, aluminium as well as workpieces such as sheets, pipes, weld seams
- Use on larger surfaces
- High edge strength
- High durability
- Set consisting of 4 discs
- Reinforced Clean + Strip construction
- Tough nylon fibre fleece
- Coarse fibre fleece construction
- Roloc® quick-change system for quick, tool-free assembly
- Diameter: 50.8 mm
- Recommended rpm: 8000–10000
- Max. rpm: 18000

9033-11-020/4	-	-	-	-	-	222834
---------------	---	---	---	---	---	--------

Strip wheel set, 4 pieces

For work on tough surfaces

- Soft variant
- Flexible coarse cleaning disc for universal cleaning applications for use on larger surfaces
- Set consisting of 4 discs
- Reinforced Clean + Strip construction
- Tough nylon fibre fleece
- Open fleece structure
- Roloc® quick-change system for quick, tool-free assembly
- Diameter: 50.8 mm
- Recommended rpm: 8000–10000
- Max. rpm: 18000

9033-11-030/4	-	-	-	-	-	222728
---------------	---	---	---	---	---	--------

Replacement bristle grinder set, purple, 2 pieces

For cleaning and gentle deburring

- Consistent results and cleaning effect throughout the entire service life as no pressure is applied when working
- Roloc® quick-change system for quick, tool-free assembly
- Solid plastic brush offset with ceramic grit
- Adapts to contours and shape of the workpiece
- Bristle length: approx. 16 mm
- Max. rpm: 25000
- Diameter: 50 mm
- Grain size: 36

9033-11-036/2	-	-	-	-	-	222872
---------------	---	---	---	---	---	--------

Replacement bristle grinder set, green, 2 pieces

For cleaning and gentle deburring

- Consistent results and cleaning effect throughout the entire service life as no pressure is applied when working
- Roloc® quick-change system for quick, tool-free assembly
- Solid plastic brush offset with ceramic grit
- Adapts to contours and shape of the workpiece
- Bristle length: approx. 16 mm
- Max. rpm: 25000
- Diameter: 50 mm
- Grain size: 50

9033-11-050/2	-	-	-	-	-	222865
---------------	---	---	---	---	---	--------

Replacement bristle grinder set, white, 2 pieces

For cleaning and gentle deburring

- Consistent results and cleaning effect throughout the entire service life as no pressure is applied when working
- Roloc® quick-change system for quick, tool-free assembly
- Solid plastic brush offset with ceramic grit
- Adapts to contours and shape of the workpiece
- Bristle length: approx. 16 mm
- Max. rpm: 25000
- Diameter: 50 mm
- Grain size: 120

9033-11-0120/2	-	-	-	-	-	222858
----------------	---	---	---	---	---	--------



Pneumatic tools · Cordless tools

Drilling and grinding machines



9033 Mini right-angle grinder

- Heavy-duty multi-bearing gearbox with a 2.5-times longer service life compared to conventional gearboxes
- Application: Handy and light tool for working in areas with difficult access
- For grinding wheels: 50 – 59 mm
- For grinding wheel thickness: 1 – 4 mm
- Adjustable protection cover
- Spindle thread: 5/16 inch 24 UNF
- Exhaust air is guided through the handle
- Air connection inlet: inside thread 12.91 mm (1/4")
- Coupler plug: Nominal size 7.2 (included)
- Hose diameter (recommended): 10 mm
- Working pressure (bar): 6.3
- Sound power level: 96.8 db(A) Lp W
- Vibration acceleration: 1.90 m/s²
- Power in watts: 224 watts
- Cold insulated handle



YouTube Clip

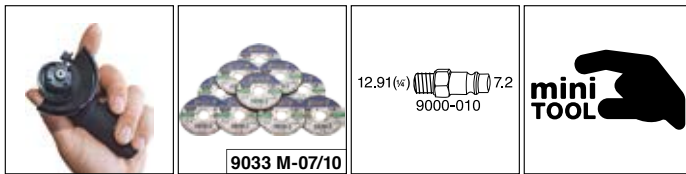
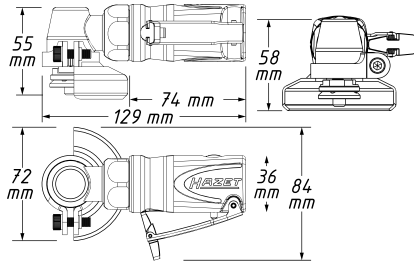

HAZET No.	l/min.	rpm	db(A) LpA	g		EAN-No. 4000896+
9033 M-7	84	18000	85.8	530	-	227242
<ul style="list-style-type: none"> • 10 cut-off wheels 50 x 1 x 10 mm • For steel and stainless steel • Maximum cutting speed 100 m/s 						
9033 M-07/10	-	-	-	-	10	229680



9033 Mini polisher

- Heavy-duty multi-bearing gearbox with a 2.5-times longer service life compared to conventional gearboxes
- Optimised for spot repairs
- Application: For working in areas with difficult access and repair work
- Extremely light, handy tool
- Grinding disc diameter: 50 mm
- Grinding disc thread: 5/16 inch UNF
- Exhaust air is guided through the handle
- Air connection inlet: inside thread 12.91 mm (1/4")
- Coupler plug: Nominal size 7.2 (included)
- Hose diameter (recommended): 10 mm
- Working pressure (bar): 6.3
- Sound power level: 94.4 db(A) Lp W
- Vibration acceleration: 1.90 m/s²
- Power in watts: 224 watts
- Cold insulated handle



YouTube Clip

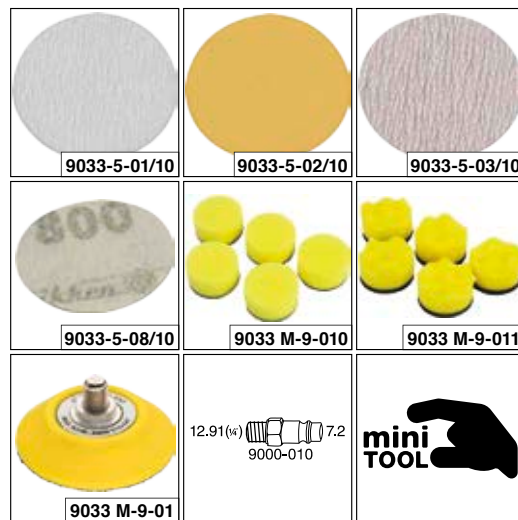
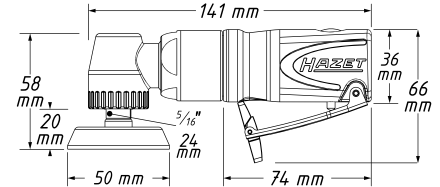

HAZET No.	l/min.	rpm	db(A) LpA	g	EAN-No. 4000896+
9033 M-9	84	4500	83.6	600	227235
<ul style="list-style-type: none"> • 10 spare grinding pads, 320 grain size, Ø 50 mm 					
9033-5-01/10	-	-	-	10	160525
<ul style="list-style-type: none"> • 10 spare grinding pads, 400 grain size, Ø 50 mm 					
9033-5-02/10	-	-	-	7	160730
<ul style="list-style-type: none"> • 10 spare grinding pads, 600 grain size, Ø 50 mm 					
9033-5-03/10	-	-	-	18	160747
<ul style="list-style-type: none"> • 10 spare grinding pads, 800 grain size, Ø 75 mm 					
9033-5-08/10	-	-	-	-	228317
<ul style="list-style-type: none"> • Spare polishing disc, Ø 50 mm 					
9033 M-9-01	-	-	-	-	228362
<ul style="list-style-type: none"> • 5 spare polishing pads, flat, Ø 50 mm 					
9033 M-9-010	-	-	-	-	228324
<ul style="list-style-type: none"> • 5 spare polishing pads, curved, Ø 50 mm 					
9033 M-9-011	-	-	-	-	228331



9033 Mini disc sander · angled

- Heavy-duty multi-bearing gearbox with a 2.5-times longer service life compared to conventional gearboxes
- Optimised for spot repairs
- Application: For processing surfaces even in hard to reach work areas, e.g. for removing rust, stripping paint, removing adhesive and sealing residues, as well as for cleaning/processing surfaces, weld seams, etc. using various abrasive media
- Roloc® quick-change system:
Combine with many abrasive media
Fast, tool-free, easy change of abrasives
- Grinding disc diameter: 50 mm
- Grinding disc thread: 1/4 inch–20 UNF
- Exhaust air is guided through the handle
- Air connection inlet: inside thread 12.91 mm (1/2")
- Coupler plug: Nominal size 7.2 (included)
- Hose diameter (recommended): 10 mm
- Working pressure (bar): 6.3
- Sound power level: 95.2 db(A) LpA
- Vibration acceleration: 1.80 m/s²
- Power in watts: 224 watts
- Cold insulated handle

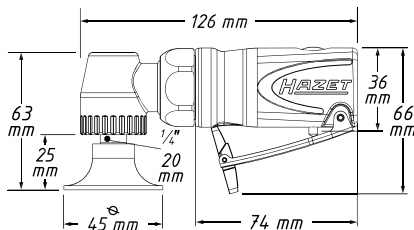

YouTube Clip



HAZET No.	l/min.	rpm	db (A) LpA	g	EAN-No. 4000896+
9033 M-11	84	18000	84.2	440	227129
• 1 piece Replacement grinding disc					
• Roloc® connection with 1/4 inch UNF thread (inside thread)					
9033 M-11-015	-	-	-	-	228355
• 5 pieces Abrasive material, red , Ø 50 mm, 150 grain size					
• Base component: nylon, Abrasive: resin					
• Roloc® connection					
9033-11-0150/5	-	-	-	5	228256

9033 Mini disc sander · angled



HAZET No.	l/min.	rpm	db (A) LpA	g	EAN-No. 4000896+
-----------	--------	-----	------------	---	------------------

Strip wheel set, 4 pieces					
For work on tough surfaces					
• Hard variant					
• For rust removal, paint stripping, cleaning welding seams, removing severe surface contamination and coatings					
• For stainless steel, FE metal, non-ferrous metal, aluminium as well as workpieces such as sheets, pipes, weld seams					
• Use on larger surfaces					
• High edge strength					
• High durability					
• Set consisting of 4 discs					
• Reinforced Clean + Strip construction					
• Tough nylon fibre fleece					
• Coarse fibre fleece construction					
• Roloc® quick-change system for quick, tool-free assembly					
• Diameter: 50.8 mm					
• Recommended rpm: 8000–10000					
• Max. rpm: 18000					
9033-11-020/4	-	-	-	-	222834
• 5 pieces Abrasive material, blue , Ø 50 mm, 300 grain size					
• Base component: nylon, abrasive: resin					
• Roloc® connection					
9033-11-0300/5	-	-	-	5	228263
Strip wheel set, 4 pieces					
For work on tough surfaces					
• Soft variant					
• Flexible coarse cleaning disc for universal cleaning applications for use on larger surfaces					
• Set consisting of 4 discs					
• Reinforced Clean + Strip construction					
• Tough nylon fibre fleece					
• Open fleece structure					
• Roloc® quick-change system for quick, tool-free assembly					
• Diameter: 50.8 mm					
• Recommended rpm: 8000–10000					
• Max. rpm: 18000					
9033-11-030/4	-	-	-	-	222728
Replacement bristle grinder set, purple, 2 pieces					
For cleaning and gentle deburring					
• Consistent results and cleaning effect throughout the entire service life as no pressure is applied when working					
• Roloc® quick-change system for quick, tool-free assembly					
• Solid plastic brush offset with ceramic grit					
• Adapts to contours and shape of the workpiece					
• Bristle length: approx. 16 mm					
• Max. rpm: 25000					
• Diameter: 50 mm					
• Grain size: 36					
9033-11-036/2	-	-	-	-	222872
• 5 pieces Abrasive material, brown , Ø 50 mm, 80 grain size					
• Base component: nylon, Abrasive: resin					
• Roloc® connection					
9033-11-080/5	-	-	-	5	228270
Replacement bristle grinder set, green, 2 pieces					
For cleaning and gentle deburring					
• Consistent results and cleaning effect throughout the entire service life as no pressure is applied when working					
• Roloc® quick-change system for quick, tool-free assembly					
• Solid plastic brush offset with ceramic grit					
• Adapts to contours and shape of the workpiece					
• Bristle length: approx. 16 mm					
• Max. rpm: 25000					
• Diameter: 50 mm					
• Grain size: 50					
9033-11-050/2	-	-	-	-	222865



Pneumatic tools · Cordless tools

Drilling and grinding machines



9033 Mini disc sander · angled



HAZET No.	l/min.	rpm	db(A) LpA	g	EAN-No. 4000896+
-----------	--------	-----	-----------	---	------------------

Replacement bristle grinder set, white, 2 pieces

For cleaning and gentle deburring

- Consistent results and cleaning effect throughout the entire service life as no pressure is applied when working
- Roloc® quick-change system for quick, tool-free assembly
- Solid plastic brush offset with ceramic grit
- Adapts to contours and shape of the workpiece
- Bristle length: approx. 16 mm
- Max. rpm: 25000
- Diameter: 50 mm
- Grain size: 120

9033-11-0120/2	-	-	-	-	222858
----------------	---	---	---	---	--------

- 5 pieces **Grinding pads**, Ø 50 mm, 60 grain size
- Base component: paper, Abrasive: resin, stearic acid metal salt
- Roloc® connection

9033-11-S 060	-	-	-	5	228287
---------------	---	---	---	---	--------

- 5 pieces **Grinding pads**, Ø 50 mm, 80 grain size
- Base component: paper, Abrasive: resin, stearic acid metal salt
- Roloc® connection

9033-11-S 080	-	-	-	5	228294
---------------	---	---	---	---	--------

- 5 pieces **Grinding pads**, Ø 50 mm, 120 grain size
- Base component: paper, Abrasive: resin, stearic acid metal salt
- Roloc® connection

9033-11-S 120	-	-	-	5	228300
---------------	---	---	---	---	--------

9032 Carbide milling pin set · 3 mm

Made in Germany

- Long service life and good cutting performance when used on diverse materials

- For hand-guided or stationary drive machines
- According to DIN 8032

HAZET application tip:

- Use as high speeds as possible
- Contact surface between milling pin and workpiece should not exceed 30 % of the complete milling circumference
- Milling pins with 3 mm shaft
- Working length: approx. 13 mm (cylindrical and cone-shaped)
- Set with 5 different milling cutters (3 mm shaft) in cylindrical, tapered and spherical shape
- Head diameter (cylindrical shape): 3 / 6 mm
- Head diameter (spherical shape): approx. 3 / 6 mm

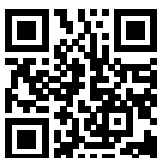

YouTube Clip



9032 Carbide milling pin set · 3 mm

9032-03 KE	9032-03 KU 6	9032-03 ZY 6
------------	--------------	--------------

9032-03 KU 3	9032-03 ZY 3
--------------	--------------

HAZET No.	EAN-No. 4000896+
-----------	------------------

- Set with 5 different milling cutters (3 mm shaft) in cylindrical, tapered and spherical shape
- Head diameter (cylindrical shape): 3 / 6 mm
- Head diameter (spherical shape): approx. 3 / 6 mm

9032-03/5	5	222483
-----------	---	--------

9032-03 KE	-	226771
------------	---	--------

9032-03 KU 3	-	226405
--------------	---	--------

9032-03 KU 6	-	226764
--------------	---	--------

9032-03 ZY 3	-	226788
--------------	---	--------

9032-03 ZY 6	-	226795
--------------	---	--------

9032 Carbide milling pin set · 6 mm

Made in Germany

- Long service life and good cutting performance when used on diverse materials

- For hand-guided or stationary drive machines
- According to DIN 8032

HAZET application tip:

- Use as high speeds as possible
- Contact surface between milling pin and workpiece should not exceed 30 % of the complete milling circumference
- Milling pin with 6 mm shaft
- Working length: approx. 19 mm (cylindrical and cone-shaped)
- Set with 3 different milling cutters (6 mm shaft) in cylindrical, tapered and spherical shape
- Head diameter (cylindrical shape): 10 mm
- Head diameter (spherical shape): approx. 9 mm



YouTube Clip



9032-06 KE	9032-06 KU	9032-06 ZY
------------	------------	------------

HAZET No.	EAN-No. 4000896+
-----------	------------------

- Set with 3 different milling cutters (6 mm shaft) in cylindrical, tapered and spherical shape
- Head diameter (cylindrical shape): 10 mm
- Head diameter (spherical shape): approx. 9 mm

9032-06/3	3	222667
-----------	---	--------

9032-06 KE	-	226825
------------	---	--------

9032-06 KU	-	226801
------------	---	--------

9032-06 ZY	-	226818
------------	---	--------



9035 Engraving pen

• Also for working in areas with restricted access

- Application: Precise and lasting marking (theft protection, installation date, etc.) on workpieces (up to HRC55) · metals · stone · ceramics · plastics
- Sturdy metal housing
- Noise-dampened
- Slim design and optimised haptics
- Anti-kink spring prevents the hose from kinking
- Knurled power control
- Air connection inlet: inside thread 12.91 mm (1/4")
- Coupler plug: Nominal size 7.2 (included)
- Hose diameter (recommended): 10 mm
- Working pressure (bar): 6.3
- Sound power level: 90 db(A) Lp W
- Vibration acceleration: 2.50 m/s²
- Hose length: 1.5 m

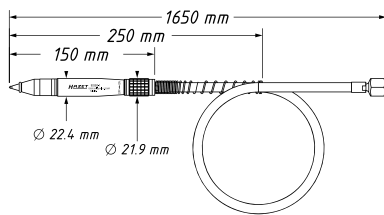

HAZET No.	l mm	l/min.	rpm	db (A) LpA	g	EAN-No. 4000896+
9035 G-1	150	28.31	13000	78	220	246625

9034 P Sabre saw

• Increased efficiency with reduction of weight, air consumption, noise generation and vibration



- Direction of air exhaust adjustable
- Suitable for cutting small radii
- Cutting capacity aluminium: 4 mm
- Cutting capacity sheet steel: 3 mm
- Strokes/min.: 9500
- Particularly suitable for cleaning sensor modules etc., due to file blade socket (included in delivery)

Contents:

- 1 sabre saw
- 3 saw blades, 18 / 24 / 32 teeth each (overall length: 93 mm)
- 1 reciprocating saw blade, 18 teeth (overall length: 153 mm)
- 5 files (overall length: ~135 mm)
- 1 inside hexagon wrench (in the handle)
- Air connection inlet: inside thread 12.91 mm (1/4")
- Coupler plug: Nominal size 7.2 (included)
- Hose diameter (recommended): 10 mm
- Working pressure (bar): 6.3
- Sound power level: 97.7 db(A) Lp W
- Vibration acceleration: 6.13 m/s²
- Saw stroke: 10 mm



9034 P Sabre saw

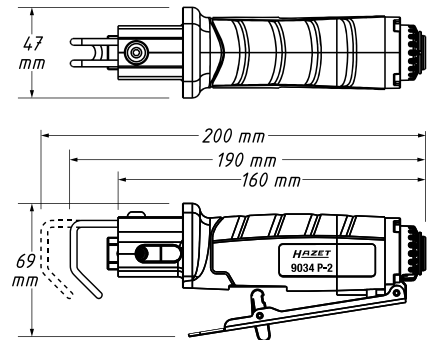

YouTube Clip

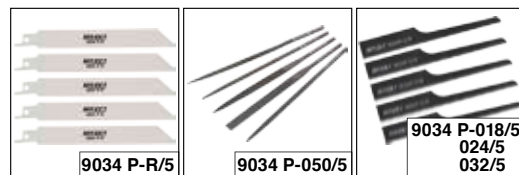

HAZET No.	l mm	l/min.	db (A) LpA	g	EAN-No. 4000896+
9034 P-2	160	99	86.7	400	218288

Reciprocating sabre saw blade for sabre saw

9034P-2 and cordless reciprocating saw 9234

- 5 pieces per package
- 18 teeth/inch, bevelled, corrugated teeth
- For all metals including non-iron pipes, sheets and stainless steel, material thickness 1.5 – 3 mm
- Total length: 153 mm
- Width 19 mm
- Thickness 1 mm
- Bi-metal

9034 P-R/5	153	-	-	175	218318
------------	-----	---	---	-----	--------

File set

For sabre saw 9034 P-2

- 5 pieces per package
- Contents:
 - 1 round file
 - 1 triangular file
 - 1 half-round file
 - 1 flat file
 - 1 square file
- Suitable for numerous materials
- Total length: approx. 135 mm
- Shank diameter: 4 mm

9034 P-050/5	135	-	-	115	218349
--------------	-----	---	---	-----	--------

Saw blades

For sabre saw 9034-1 · 9034P-1 · 9034P-2

- 5 pieces per package
- 93 mm total length
- Socket 1 x 13 mm
- 18 teeth

9034 P-018/5	93	-	-	-	225958
--------------	----	---	---	---	--------

Saw blades

For sabre saw 9034-1 · 9034P-1 · 9034P-2

- 5 pieces per package
- 93 mm total length
- Socket 1 x 13 mm
- 24 teeth

9034 P-024/5	93	-	-	-	225965
--------------	----	---	---	---	--------

Saw blades

For sabre saw 9034-1 · 9034P-1 · 9034P-2

- 5 pieces per package
- 93 mm total length
- Socket 1 x 13 mm
- 32 teeth

9034 P-032/5	93	-	-	-	225989
--------------	----	---	---	---	--------



Pneumatic tools · Cordless tools

Drilling and grinding machines



9035 Needle scaler

Pistol shape



- Adjustable needle cover enables maximum utilisation of needles
- Two-piece housing design for easy maintenance
- 19 needles, \varnothing 3 mm
- 3,200 impacts/min
- Air connection inlet: inside thread 12.91 mm ($\frac{1}{4}$ "
- Coupler plug: Nominal size 7.2 (included)
- Working pressure (bar): 6.3
- Vibration acceleration: 8.70 m/s²
- Cold insulated handle

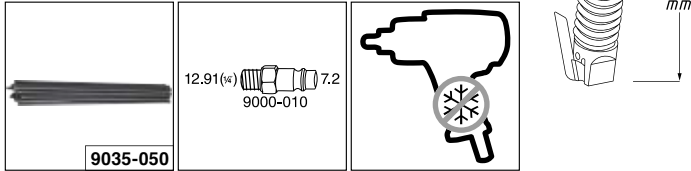
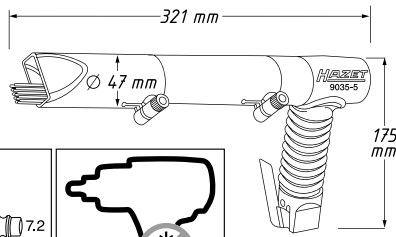

HAZET No.	l/min.	db(A) LpA	g	EAN-No. 4000896+
9035-5	170	97	2600	132355
• Spare needles For needle scaler 9035-5 19 needles, \varnothing 3 mm				
9035-050	-	-	202	139385

9035 Needle scaler

28 mm slim / short pin form and free needles allow you to reach difficult to access areas as well



- 13 thin stainless steel needles (\varnothing 1.3 mm) ensure damage-free processing and highly fine surface structure
- Suitable for processing stainless steel
- 3000 impacts/min
- Safety lever
- Infinite adjustable power
- Air connection inlet: inside thread 12.91 mm ($\frac{1}{4}$ "
- Coupler plug: Nominal size 7.2 (included)
- Working pressure (bar): 6.3
- Sound power level: 98.8 db(A) Lp A
- Vibration acceleration: 6.90 m/s²
- Cold insulated handle

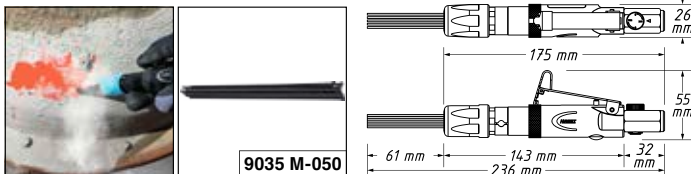

HAZET No.	l/min.	db(A) LpA	g	EAN-No. 4000896+
9035 M-5	235.6	48.1	87.9	232284
• Spare needles (stainless steel) For needle scaler 9035M-5 13 needles, \varnothing 1.3 mm Suitable for processing stainless steel				
9035 M-050	-	-	-	233205

9035 H Chisel hammer set

- Strike rate adjustable in 9 levels up to 2600 strikes/min
- Chisel collet: \varnothing 10 mm
- Shaft collet length: 73 mm
- Plastic case
- Air connection inlet: inside thread 12.91 mm ($\frac{1}{4}$ "
- Coupler plug: Nominal size 7.2 (included)
- Working pressure (bar): 6.3
- Cold insulated handle

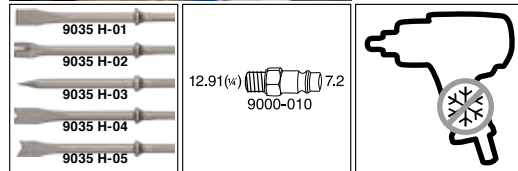
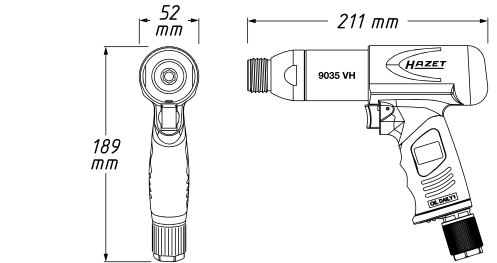

HAZET No.	l/min.	db(A) LpA	g	EAN-No. 4000896+
• Chisel hammer set				
• Air requirement: 57 – 594 l/min				
• Sound pressure level: 92 – 105 dB(A) Lp A				
9035 H/6	-	2500	6	214655
• Combination basic unit with vibration and hammer function				
• Plastic case				
• Air requirement: 57 – 594 l/min				
• Sound pressure level: 92 – 105 dB(A) Lp A				
9035 VH	-	2500	-	214020
• Keyless drill chuck				
• For 9035VH · 9035H/6 · 9035V/5				
9035 VH-01	-	300	-	214242
• Spare chisel set · for 9035H/6				
• Contents: 9035H-01 · 02 · 03 · 04 · 05				
9035 H/5	-	-	5	214006
• Flat chisel				
9035 H-01	175	-	-	214136
• Sheet cutting chisel				
9035 H-02	177.5	-	-	213924
• Pointed chisel				
9035 H-03	174	-	-	214198
• Rivet cutting chisel				
9035 H-04	174	-	-	214143
• Curve cutting chisel				
9035 H-05	176.5	-	-	214525



9035 V Vibration chisel set

- Strike rate adjustable in 9 levels up to 2600 strikes/min
- Chisel collet: \varnothing 10 mm
- Shaft collet length: 73 mm
- Plastic case
- Air connection inlet: inside thread 12.91 mm ($\frac{1}{4}$ ")
- Coupler plug: Nominal size 7.2 (included)
- Working pressure (bar): 6.3
- Cold insulated handle



(E)



YouTube Clip

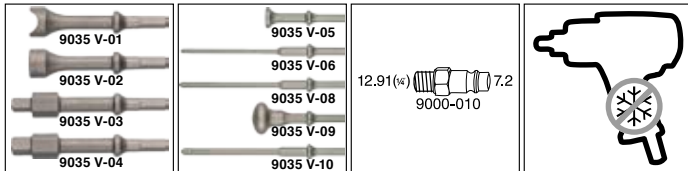
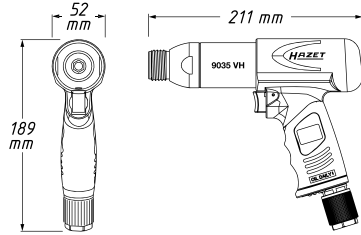

HAZET No.	l mm	g		EAN-No. 4000896+
• Vibration chisel set				
• Air requirement: 57 – 594 l/min				
• Sound pressure level: 92 – 105 dB(A) Lp A				
9035 V/5	–	2500	5	213368
• Combination basic unit with vibration and hammer function				
• Plastic case				
• Air requirement: 57 – 594 l/min				
• Sound pressure level: 92 – 105 dB(A) Lp A				
9035 VH	–	2500	–	214020
• Keyless drill chuck				
• For 9035VH · 9035H/6 · 9035V/5				
9035 VH-01	–	300	–	214242
• Spare chisel set for 9035V/5				
• Contents: 9035V-01 · 02 · 03 · 04				
9035 V/4	–	–	4	214013
• Semi-circular vibration chisel				
9035 V-01	114	–	–	214181
• Circular vibration chisel				
9035 V-02	112	–	–	214174
• Vibration chisel ■ 10 = $\frac{3}{8}$ " / ● s 19 mm				
9035 V-03	127.5	–	–	214167
• Vibration chisel ■ 12.5 = $\frac{1}{2}$ " / ● s 19 mm				
9035 V-04	128	–	–	214150
• Vibration chisel, flat				
• Round shank 10 mm				
• For 9035VH · 9035V/5				
9035 V-05	91.5	–	–	227266
• Vibration drift pin 6 mm				
• Round shank 10 mm				
• For 9035VH · 9035V/5				
9035 V-06	197	–	–	227259
• Vibration drift pin 8 mm				
• Round shank 10 mm				
• For 9035VH · 9035V/5				
9035 V-08	197	–	–	227297
• Curved vibration chisel				
• Round shank 10 mm				
• For 9035VH · 9035V/5				
9035 V-09	110	–	–	227280

9035 V Vibration chisel set

(E)

HAZET No.	l mm	g		EAN-No. 4000896+
• Vibration drift pin 10 mm				
• Round shank 10 mm				
• For 9035VH · 9035V/5				
9035 V-010	197	–	–	227273

9036 Air nibbler

- Continuous speed regulation via speed regulator on back of handle

(E)

- Application: For cutting small radii (min. 4.5 mm). Also suitable for cutting plastic
- Cutting capacity: steel 1.2 mm / aluminium 1.6 mm
- Cutting width: 4.5 mm
- Air connection inlet: inside thread 12.91 mm ($\frac{1}{4}$ ")
- Coupler plug: Nominal size 7.2 (included)
- Hose diameter (recommended): 10 mm
- Working pressure (bar): 6.3
- Sound power level: 87 dB(A) Lp W
- Vibration acceleration: 1.90 m/s²
- Power in watts: 370 watts
- Cold insulated handle

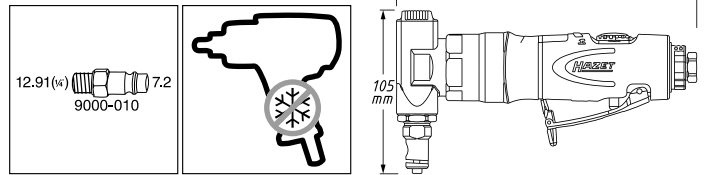

HAZET No.	l/min.	rpm	db (A) LpA	g	EAN-No. 4000896+
9036 N-1	104	2600	80	1000	209668

9036 Metal shear

- Heavy-duty cutting blade for maximum cutting capacity: steel 1.2 mm / aluminium 1.6 mm

(E)

- Application: For straight and contour cuts
- Continuous speed regulation via speed regulator on back of handle
- Vibration damped
- Cutting width: 4.5 mm
- Air connection inlet: inside thread 12.91 mm ($\frac{1}{4}$ ")
- Coupler plug: Nominal size 7.2 (included)
- Hose diameter (recommended): 10 mm
- Working pressure (bar): 6.3
- Sound power level: 86 dB(A) Lp W
- Vibration acceleration: 1.60 m/s²
- Power in watts: 370 watts
- Cold insulated handle

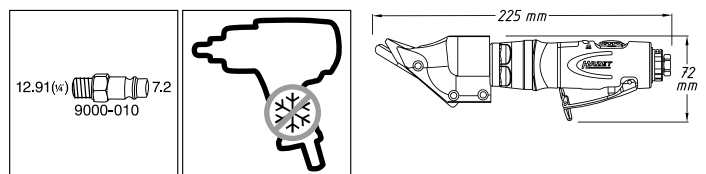

HAZET No.	l/min.	db (A) LpA	g	EAN-No. 4000896+
9036 N-5	104	80	1000	209651



Pneumatic tools · Cordless tools

Blind rivet guns



Blind rivet guns

9037 Blind rivet gun

• **Pneumatic / hydraulic**
Suitable for stainless steel rivets up to 6.4 mm



- Professional riveting, suitable for continuous operation with rivets of up to 6.4 mm made of steel, stainless steel, aluminium and copper
- Possible rivet sizes: 3.0 · 3.2 · 4.0 · 4.8 · 5.0 · 6.0 and 6.4 mm
- 5 nose pieces (one pre-installed)
- Thread size of nose pieces: M10x1.25
- Total stroke: 15.8 mm
- High tractive power: 14700 N
- Particularly low noise level
- Rotary joint for flexible use
- Rivet and nose piece template on the underside of the rivet gun
- Storage of the different nose pieces on the underside of the rivet gun
- Easy oil top ups using special design of the rivet gun
- Includes maintenance set for oil control (oil-supported pressure build-up)
- Air requirement: 2.64 l/stroke
- Air connection inlet: inside thread 12.91 mm (1/4")
- Coupler plug: Nominal size 7.2 (included)
- Hose diameter (recommended): 10 mm
- Working pressure (bar): 6.3
- Cold insulated handle

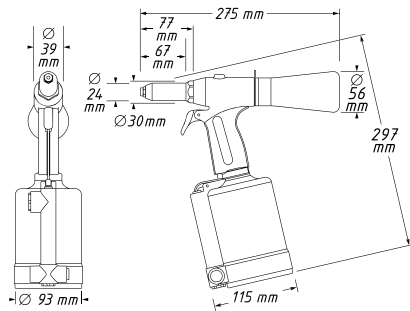
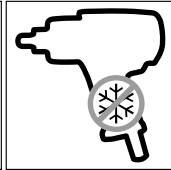
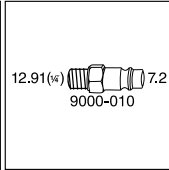

9037 Blind rivet gun

• **Pneumatic / hydraulic**
For blind rivets up to 4.8 mm



- Possible rivet sizes:
Aluminium rivets: 2.4–4.8 mm
Steel rivets: 2.4–4.8 mm
Stainless steel rivets: 2.4–3.2 mm
- 4 nose pieces (one pre-installed): 2.4 · 3.2 · 4 · 4.8 mm
- Total stroke 14 mm
- With sturdy metal housing
- Tractive power: 8700 N
- Coupler plug with rotary joint for flexible operation
- Air requirement: 1 l/stroke
- Air connection inlet: inside thread 12.91 mm (1/4")
- Coupler plug: Nominal size 7.2 (included)
- Working pressure (bar): 6.3

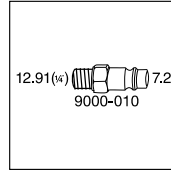
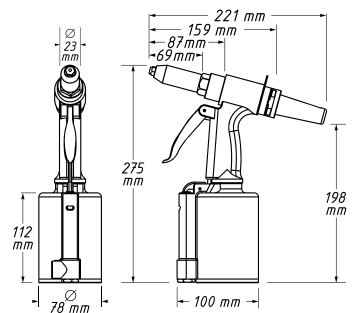

HAZET No.	Weight (g)	EAN-No.
9037 N-2	2110	4000896+ 205578

HAZET No.	Noise (db(A) LpA)	Weight (g)	EAN-No.
9037 SPC	73	1500	4000896+ 150168





Air blow tools

9040 Turbo air blow gun

- Swirl nozzle generates strong air pulse
- Very practical design
- Air connection inlet: inside thread 12.91 mm (1/4")
- Coupler plug: Nominal size 7.2 (included)
- Hose diameter (recommended): 10 mm
- Working pressure (bar): 6.3
- Sound power level: 102 db(A) Lp W
- Max. working pressure [bar]: 12 bar

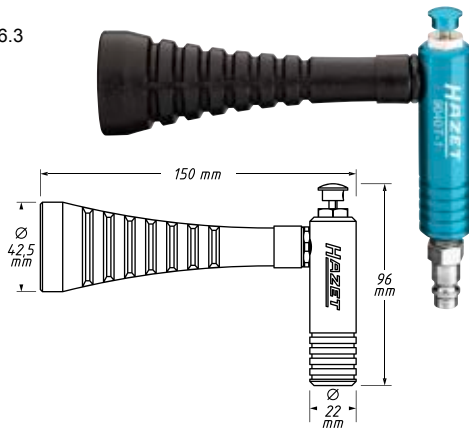

HAZET No.	L x W x H mm	l mm	l/min.	db(A) LpA	g	EAN-No. 4000896+
9040 T-1	150x42.5x96	150	80	91	163	252626

9040 Air blow gun · 100 mm

- Standard nozzle
- Curved tube
- Application: Fast removal of shavings or other foreign objects, especially in areas that are difficult to access
- To be used on machinery, in workshops, for wood work, hobby workshops
- Handle, trigger and valve made of acetal plastic
- Seals and O-rings made of nitrile
- Spring made of hardened spring steel
- Air connection inlet: inside thread 12.91 mm (1/4")
- Coupler plug: Nominal size 7.2 (included)
- Working pressure (bar): 6
- Max. working pressure [bar]: 16 bar
- Pipe Ø: 8 mm
- Blast pipe and shaft made of steel
- 2003/10/CE Max 85 dB
- OSHA 1910.95 (b) Max 90 dB 8 hr
- Temperature range: -10°C – 80°C

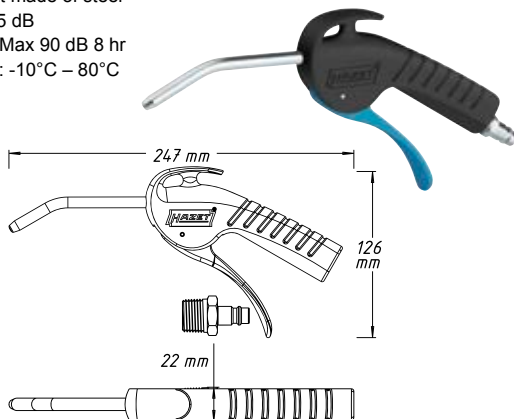

YouTube Clip

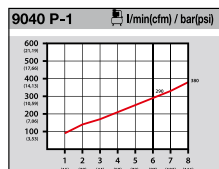
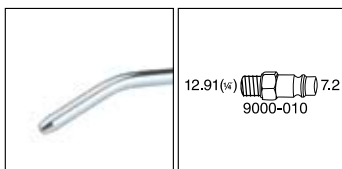

HAZET No.	l mm	l/min.	db(A) LpA	g	EAN-No. 4000896+
9040 P-1	247	290	84	105	209545

9040 Air blow gun · 300 mm

- Long nozzle
- Straight tube
- Application: Fast removal of shavings or other foreign objects, especially in areas that are difficult to access
- To be used on machinery, in workshops, for wood work, hobby workshops
- Handle, trigger and valve made of acetal plastic
- Seals and O-rings made of nitrile
- Spring made of hardened spring steel
- Air connection inlet: inside thread 12.91 mm (1/4")
- Coupler plug: Nominal size 7.2 (included)
- Hose diameter (recommended): 10 mm
- Working pressure (bar): 6
- Max. working pressure [bar]: 16 bar
- Pipe Ø: 8 mm
- Blast pipe and shaft made of steel
- Blast pipe length ~ 280 mm
- 2003/10/CE Max 85 dB
- OSHA 1910.95 (b) Max 90 dB 8 hr
- Temperature range: -10°C – 80°C

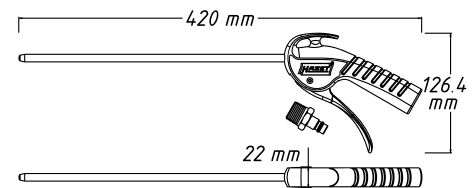

YouTube Clip

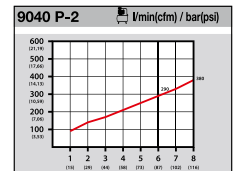

HAZET No.	l mm	l/min.	db(A) LpA	g	EAN-No. 4000896+
9040 P-2	420	290	84	190	209552





Pneumatic tools · Cordless tools

Air blow tools



9040 Air blow gun · 100 mm · quiet · with bent pipe

- Extreme reduction of noise
- Strong blowing force
- Non-blocking

- Application: Fast removal of shavings or other foreign objects, especially in areas that are difficult to access
- To be used on machinery, in workshops, for wood work, hobby workshops
- Handle, trigger and valve made of acetal plastic
- Seals and O-rings made of nitrile
- Spring made of hardened spring steel
- Air connection inlet: inside thread 12.91 mm (1/4")
- Coupler plug: Nominal size 7.2 (included)
- Working pressure (bar): 6
- Max. working pressure [bar]: 12 bar
- Pipe Ø: 8 mm
- Blast pipe and shaft made of steel
- 2003/10/CE Max 85 dB
- OSHA 1910.95 (b) Max 90 dB 8 hr
- OSHA STD 1-13.1, Max 30 PSI if blocked
- Temperature range: -10°C – 80°C



YouTube Clip

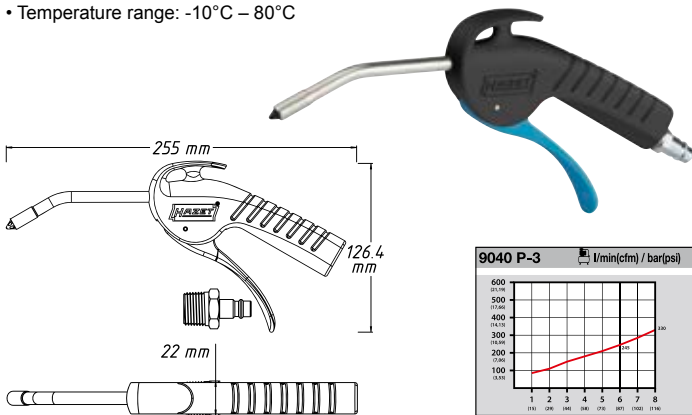

HAZET No.	l mm	l/min.	db(A) LpA	g	EAN-No. 4000896+
9040 P-3	255	245	76.8	100	209644

9040 Air blow gun · 100 mm · with Venturi nozzle and bent pipe

- 100% increase in air outlet quantity thanks to Venturi nozzle
- Extreme blowing force
- Non-blocking

- Application: Fast removal of shavings or other foreign objects, especially in areas that are difficult to access
- To be used on machinery, in workshops, for wood work, hobby workshops
- Handle, trigger and valve made of acetal plastic
- Seals and O-rings made of nitrile
- Spring made of hardened spring steel
- Air connection inlet: inside thread 12.91 mm (1/4")
- Coupler plug: Nominal size 7.2 (included)
- Working pressure (bar): 6
- Max. working pressure [bar]: 16 bar
- Pipe Ø: 8 mm
- Blast pipe and shaft made of anodised steel
- OSHA 1910.95 (b) Max 90 dB 8 hr
- OSHA STD 1-13.1, Max 30 PSI if blocked
- Temperature range: -10°C – 80°C



YouTube Clip

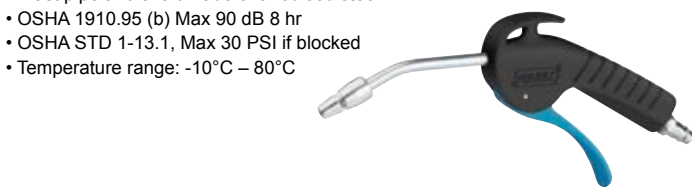

9040 Air blow gun · 100 mm · with Venturi nozzle and bent pipe

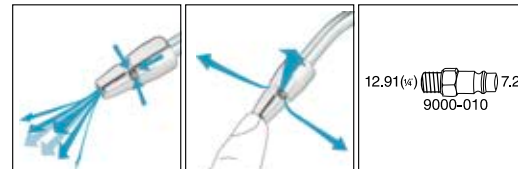
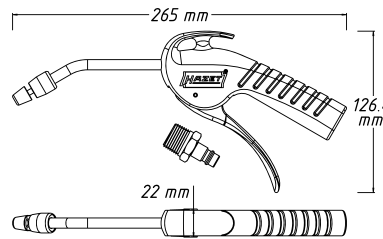

HAZET No.	l mm	l/min.	db(A) LpA	g	EAN-No. 4000896+
9040 P-4	265	235	83.7	165	209569

9040 Air blow gun · quiet · with wide flat nozzle

- Wide flat nozzle for cleaning surfaces
- Considerable blowing force
- Non-blocking

- Application: Fast removal of shavings or other foreign objects, especially in areas that are difficult to access
- To be used on machinery, in workshops, for wood work, hobby workshops
- Handle, trigger and valve made of acetal plastic
- Seals and O-rings made of nitrile
- Spring made of hardened spring steel
- Air connection inlet: inside thread 12.91 mm (1/4")
- Coupler plug: Nominal size 7.2 (included)
- Working pressure (bar): 6
- Max. working pressure [bar]: 8 bar
- 2003/10/CE Max 85 dB
- OSHA 1910.95 (b) Max 90 dB 8 hr
- OSHA STD 1-13.1, Max 30 PSI if blocked
- Temperature range: -10°C – 80°C



YouTube Clip

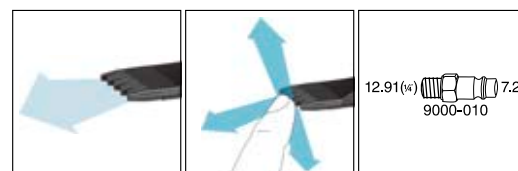
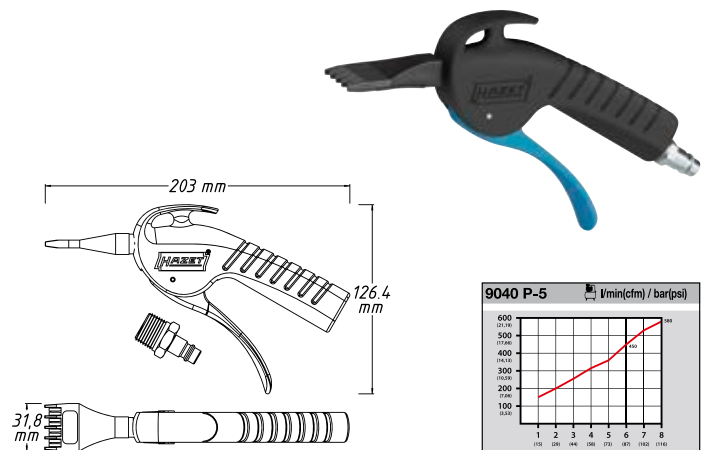

HAZET No.	l mm	l/min.	db(A) LpA	g	EAN-No. 4000896+
9040 P-5	203	450	78	95	209576



9040 2-way air blow gun

- Choice of air supply at tool head or handle
- Application: Fast removal of chips or other foreign objects
- Exchangeable nozzles:
 - Short nozzle for areas with restricted access
 - Long nozzle (112 mm) with safety nozzle tip (scratch protection)
- Maximum pressure: 10 bar
- Pressure regulator
- To be used on machinery, in workshops, for wood work, hobby workshops
- Aluminium housing
- Thread nozzles: 1/8 inch PF 28 (9.728 mm outside Ø / 0.907 mm pitch)
- Air connection inlet: inside thread 12.91 mm (1/4")
- Coupler plug: Nominal size 7.2 (included)
- Working pressure (bar): 6.3
- Anti-slip, cold insulated handle

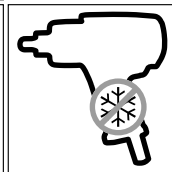

HAZET No.	l/min.	db (A) LpA	g	EAN-No. 4000896+
9040-4	330	86	205	176236

9040 Blow pen

- Practical and compact design with clip for fixation e.g. in pockets
- Turn to adjust air flow
- Nozzle: 3 mm Ø
- Easy handling, clicks directly on air coupling 7.2 mm
- Inlet pressure: 12 bar
- Maximum flow rate: 360 l/min. at 6 bar
- Perbunan seal (NBR)
- Duraluminium housing
- Coupler plug: integrated, nominal size 7.2

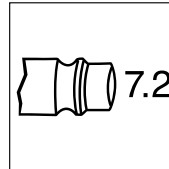

HAZET No.	EAN-No. 4000896+
9040-3	109500



9040 LG Air blow gun · long

- Increased efficiency due to Venturi nozzle (54 mm / 35 gram)
- 90° lateral nozzle (32 mm / 8.4 gram) for cleaning cooling fins



- Application: Cleaning areas with restricted access on vehicles, machinery and agricultural machinery
- Grip area with insulated lance to protect it from cold
- Maximum pressure: 12 bar
- Ergonomic handle
- Air connection inlet: inside thread 12.91 mm (1/4")
- Coupler plug: Nominal size 7.2 (included)
- Hose diameter (recommended): 10 mm
- Working pressure (bar): 6.3
- Cold insulated handle

YouTube Clip

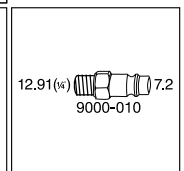
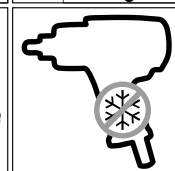

HAZET No.	l mm	l/min.	g		EAN-No. 4000896+
9040 LG-3/2	1085	450	313	2	206339
<ul style="list-style-type: none"> • Venturi nozzle for 9040-4 and 9040LG-3/2 • 100% increase in air outlet quantity thanks to Venturi effect 					
9040 LG-3-01	–	–	–	–	241514
<ul style="list-style-type: none"> • Lateral nozzle for 9040-4 and 9040LG-3/2 • Nozzle enables lateral blow-out, e.g. for cleaning cooling fins and other hard-to-reach areas 					
9040 LG-3-02	–	–	–	–	241521



Tyre inflators and measuring instruments

9041 Tyre inflator

- **Special rubber housing protects manometer against light impacts**

- Measuring tolerance ± 0.3 bar
- Handle with operating lever and discharge knob (for one-hand use)
- Flexible hose (length 400 mm) with plug-in nipple
- Max. pressure: 12 bar
- Handle with integrated suspension hook
- Manometer measuring range: 0 – 12 bar
Graduation: 0.1 bar
- Manometer diameter: 63 mm
- Scale value in bar
- Air connection inlet: inside thread 12.91 mm (1/4")
- Coupler plug: Nominal size 7.2 (included)
- Temperature range: $-10^{\circ}\text{C} - 40^{\circ}\text{C}$

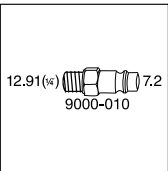
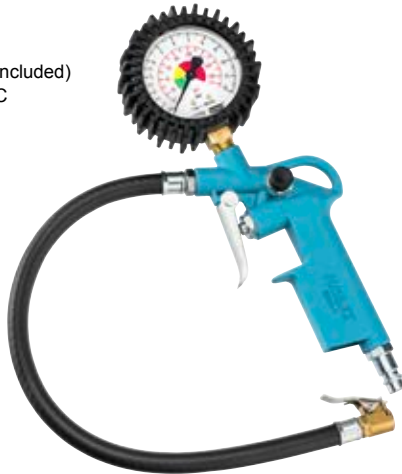

HAZET No.	g	EAN-No.
9041-1	411	4000896+ 147076

9041 Tyre inflator · digital

- **Easy and optimal readability also in poor light conditions**

- Application: Filling tyres and checking the air pressure
- Special rubber housing protects manometer against light impacts
- Handle with operating lever for filling as well as deflating button for one-hand use
- Hose with plug-in nipple
- Handle with integrated suspension hook
- Manometer measuring range: 0–12 bar, graduation: 0.01 bar
- Measuring tolerance: $\pm 1\%$
- Blue lighting of the display
- Flexible tube, length: 400 mm
- Manometer diameter: 63 mm
- Device dimensions: 262x105x40 mm
- Display toggles between bar / PSI / kg/cm²
- Max. pressure: 12 bar
- Power supply: 2x1.5V lithium batteries type AAA
- Air connection inlet: inside thread 12.91 mm (1/4")
- Coupler plug: integrated, nominal size 7.2
- Temperature range: $-20^{\circ}\text{C} - 50^{\circ}\text{C}$



9041 Tyre inflator · digital

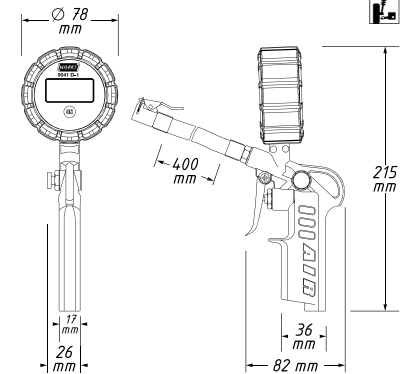

HAZET No.	g	EAN-No.
9041 D-1	385	4000896+ 212378

9041 Tyre inflator · calibrated

- **Calibrated device with optimally readable, large manometer**

- Application: Precise filling of tyres and checking the air pressure
- Measuring tolerance 0–4 bar ± 0.08 bar
Measuring tolerance 4–12 bar ± 0.16 bar
- Special rubber housing protects manometer against light impacts
- Handle with operating lever for filling and deflating (for one-hand use)
- Hose with plug-in nipple
- Handle with integrated suspension hook
- Manometer measuring range: 0–12 bar, graduation: 0.1 bar
- Flexible tube, length: 1000 mm
- Manometer diameter: 80 mm
- Device dimensions: 220x150x90 mm
- Max. pressure: 12 bar
- Air connection inlet: inside thread 12.91 mm (1/4")
- Coupler plug: integrated, nominal size 7.2
- Temperature range: $-20^{\circ}\text{C} - 60^{\circ}\text{C}$

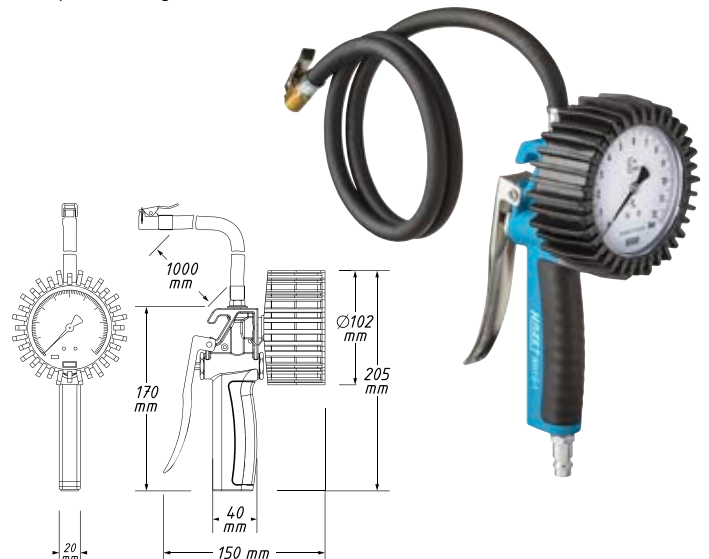

HAZET No.	g	EAN-No.
9041 G-1	585	4000896+ 212385



Grease gun, spray gun, air blow and suction gun

9042 N Grease gun

- 360° adjustable body
- Continuous pumping of grease
- Bleeding valve



- Application: Gun-filling with grease cartridges and loose grease
- Metal tube length: 172 mm
- Nylon hose length: 230 mm
- Filling capacity: 400 ml
- Compaction: 40:1
- Coupler thread metal tube / nylon hose: M10 x 1 (conical)
- Flow rate at working pressure: 3.5 ccm/second
- Air connection inlet: inside thread 12.91 mm (1/4")
- Coupler plug: Nominal size 7.2 (included)
- Working pressure (bar): 6.3

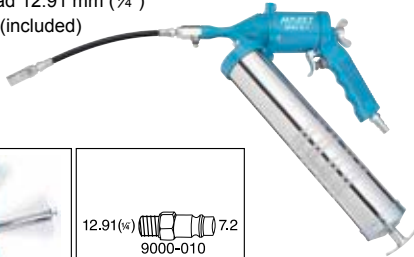

HAZET No.	l/min.	g	EAN-No. 4000896+
9042 N-1	230	2000	176472

9042 Car body gun for underbody protection and cavity sealing

- Easy replacement of nozzle and hose
- Including metal suction pipe
- Fluid throughflow can be easily regulated by removal



- Application: Maintenance and cleaning of passenger cars and other vehicles Suitable for aqueous and oily liquids
- Including nozzle and cavity tube
- Air requirement with nozzle 380 l/min at 8 bar
- Air requirement with nozzle 255 l/min at 6 bar
- Air requirement with cavity tube: 180 l/min at 8 bar
- Air requirement with cavity tube: 165 l/min at 6 bar
- Thread: BSP/NPT
- Incl. cavity tube: 920 mm usable length
- Handle, trigger and valve made of acetal plastic
- Seals and O-rings made of nitrile
- Nozzles made of steel / plastic
- Spring made of hardened spring steel
- Net weight with nozzle 350 gram
- Net weight with cavity tube 338 gram
- Cartridge coupler thread: M 41 x 3
- Air connection inlet: inside thread 12.91 mm (1/4")
- Coupler plug: Nominal size 7.2 (included)
- Working pressure (bar): 6
- Max. working pressure [bar]: 16 bar
- Temperature range: -10°C – 80°C

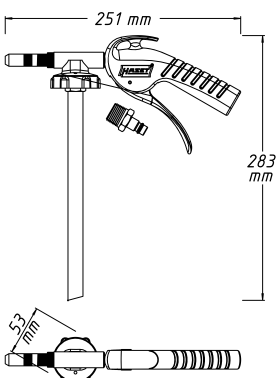

9042 Car body gun for underbody protection and cavity sealing

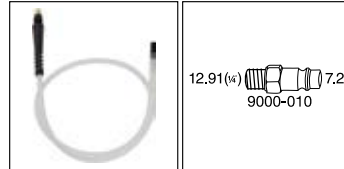

YouTube Clip

HAZET No.	l mm	EAN-No. 4000896+
9042 P-4	251	209613

9043 Air blow and suction gun · switchable

- One-hand reversing switch



- Application: Sucking up dirt into the collection bag as well as for blowing surfaces clean
- Metal housing
- Deflector special bag insert protects the bag against damage, e. g. due to swarfs, by preventing direct impact of the accelerated swarfs
- Vacuum level: 7.5 mmHg
- Air connection inlet: inside thread 12.91 mm (1/4")
- Coupler plug: Nominal size 7.2 (included)
- Hose diameter (recommended): 10 mm
- Working pressure (bar): 6.3
- Sound power level: 97 db(A) Lp W
- Vibration acceleration: 0.40 m/s²
- Max. working pressure [bar]: 10.34 bar



YouTube Clip

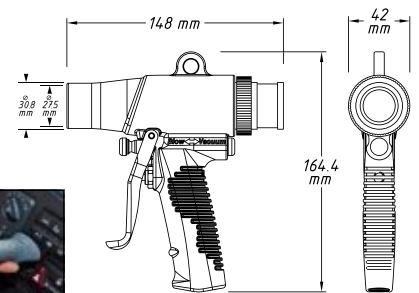

HAZET No.	l/min.	db(A) LpA	g	EAN-No. 4000896+
9043 N-10	96	92	403	198382



Pneumatic tools · Cordless tools

Grease gun, spray gun, air blow and suction gun



9045 Soda spray gun

- Does not damage rubber, glass or plastic parts
- No heating / deformation of sheets during blasting



- Application: Gentle, damage-free and environmentally friendly cleaning and paint stripping with NaHCO₃ (sodium bicarbonate)
- Application fields:
 - Removing graffiti
 - Facade and monument cleaning
 - Removing paint from wooden objects
 - Removing paint on glass surfaces and window frames without causing damage to glass and seals
 - Removing boot coatings, without attacking hull
- 1 preset metal precision nozzle for optimum performance
- 3 high performance wide-jet nozzles
- Refillable container with 1.2 l volume
- Including 1 kg soda blast-cleaning agent
- Handle, trigger and valve made of acetal plastic
- Seals and O-rings made of nitrile
- Spring made of hardened spring steel
- Container made of PEHD
- Air connection inlet: inside thread 12.91 mm (1/4")
- Coupler plug: Nominal size 7.2 (included)
- Working pressure (bar): 6.3



YouTube Clip



9045 P-5 S

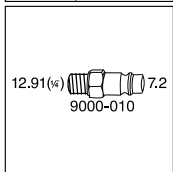

12.91 (1/4) 9000-010 7.2

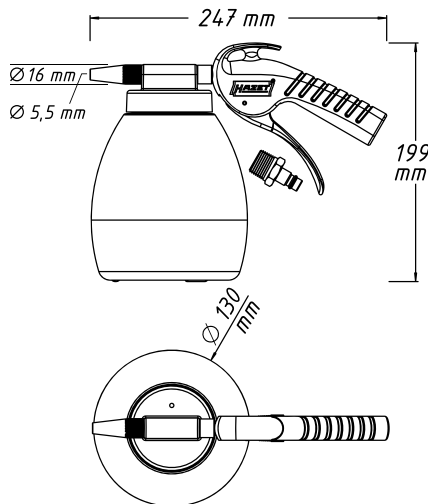

9048 P Wash-gun set

- Cleaning without the use of aggressive chemicals or solvents

- Application: Effective, powerful and solvent-free cleaning of e.g. cooling systems with graded system cleaning nozzle
- No splashback, effective cleaning of machines, units and vehicle parts with jet wash nozzle
- Swivel joint at the water connection, helps to avoid "hose spaghetti"
- Continuous independent regulation of water and compressed air supply
- Washing and system cleaning nozzle included
- No splashback even when cleaning with combined water/compressed air jet at short distance
- Damage-free cleaning thanks to water / air operation
- Quick, easy and gentle cleaning
- High-quality materials
- Including:
 - Water connection variants: 13 mm (1/2") nipple for water coupling (Gardena system compatible) or 20 mm (3/4") GHT thread
 - Graded system cleaning nozzles
 - Jet washing nozzle
- Working pressure (bar) air: 6-10
- Temperature range -10 / +40 °C
- Recommended air hose diameter: 10 mm
- Recommended water hose diameter: 13 mm
- Air connection inlet: inside thread 12.91 mm (1/4")
- Coupler plug: Nominal size 7.2 (included)
- Hose diameter (recommended): 10 mm

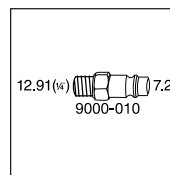
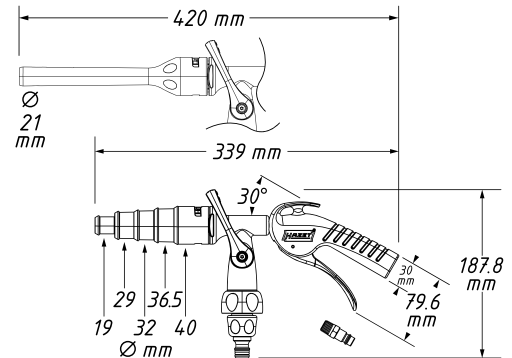

12.91 (1/4) 9000-010 7.2

HAZET No.	l/min.	g	EAN-No. 4000896+
9048 P-2/3	200	400	234608



HAZET No.	l mm	l/min.	g	EAN-No. 4000896+
9045 P-1	247	180	460	209590
9045 P-5 S	-	-	-	210404

- Sodium bicarbonate
- Application
 - Material-friendly removal of paints, contaminants, etc.
 - Stripping of car body parts and cleaning of components
 - careful removal of graffiti as well as for facades and cleaning landmarks
 - Cleaning mouldings and extruder tools
- 5 l canister with carrying handle
- Optimal flow properties
- Angular powder with medium grain size ~ 25 µm³



Pneumatic adaptors

9040 Spiral hose

- High flexible polyurethane hose with length of 7.62 m and 6.35 mm inside \varnothing
- Inside diameter of the hose: 6.35 mm
- Connecting pieces with 360° rotary joints
- Burst pressure according to DIN: 55.1 bar / 800 PSI
- Working pressure: 10 bar
- Air connection inlet: inside thread 12.91 mm (1/4"), coupler plug 7.2 mm type 1 (DE/AT/SI/HU/CN/IN/PT/RU/PL/RO/TR)
- Air connection outlet: outside thread 12.91 mm (1/4"), coupler bushing 7.2 mm type 1
- Coupler plug: Nominal size 7.2 (included)
- Hose length: 7.62 m

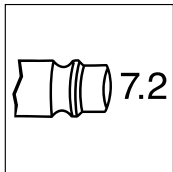

HAZET No.	$\frac{\Delta}{g}$	EAN-No. 4000896+
9040-7	630	153404

9040 Spiral hose

- High flexible polyurethane hose with length of 7.62 m and 10 mm inside \varnothing
- Application: Flexible connection of pneumatic tools
- Inside diameter of the hose: 10 mm
- Connecting pieces with 360° swivel joints
- Burst pressure according to DIN: 60 bar
- Working pressure: 10 bar
- Air inlet thread: 3/8"
- Working length: 50% to 80% of the hose length
- 100% silicone-free EPDM VK60FA
- Maximum flexibility
- Highly abrasion-resistant
- Dimensional stable
- Air connection inlet: outside thread 16.41 mm (3/8")
- Air connection outlet: outside thread 16.41 mm (3/8")
- Hose length: 7.62 m
- Temperature range: -20°C – 60°C

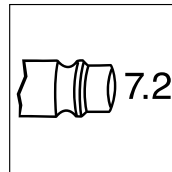

HAZET No.	EAN-No. 4000896+
9040 S-10	212361

9040 Hose reel

- Hose stop with "Stop at any point" function
- Neat winding of the hose thanks to automatic guidance
- Braked winding to prevent risk of accidents
- Application: Automatic hose reel offers tidiness in the workshop – hose not left lying around, thus reducing the risk of accidents
- Inside diameter of the hose: 10 mm
- Suitable for compressed air or water
- Dimensions: 459 x 378 x 205 mm
- Dimensions (packed): 465 x 400 x 220 mm
- Hybrid polymer hose, black
- Length of connection hose: 0.9 m
- Integrated drill template for mounting on cardboard packaging
- Thread BSPT
- Meets all relevant requirements defined in the European Directives for Machinery 2006/42/EC
- Optionally usable with HAZET safety coupling 9000-061
- Closed special plastic case, supplied with rotating metal mounting bracket made for separate installation at the workplace
- Borehole spacing of the mounting bracket: 186 mm
- Air connection inlet: outside thread 16.41 mm (3/8")
- Air connection outlet: outside thread 16.41 mm (3/8")
- Hose length: 15 m
- Max. working pressure [bar]: 20 bar
- Temperature range: -40°C – 60°C



YouTube Clip

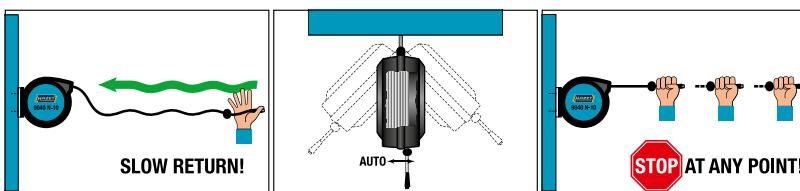
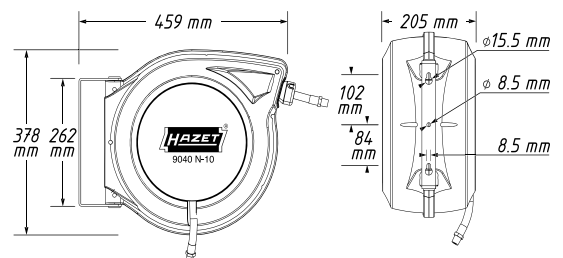

HAZET No.	$\frac{\Delta}{g}$	EAN-No. 4000896+
9040 N-10	6450	206445



9040 Hose reel

- Hose stop at any point with “Stop at any point” function
- Automatic guidance winds the hose neatly
- Braked winding to prevent risk of accidents
- Application: Automatic hose reel offers tidiness in the workshop – hose not left lying around, thus reducing the risk of accidents
- **Inside diameter of the hose: 13 mm (½")**
- Suitable for compressed air or water
- Dimensions: 500 x 418 x 210 mm
- Hybrid polymer hose, black
- Length of connection hose: 1 m
- Integrated drill template for mounting on cardboard packaging
- Meets all relevant requirements defined in the European Directives for Machinery 2006/42/EC
- Closed special plastic case, supplied with rotating metal mounting bracket made for separate installation at the workplace
- Borehole spacing of the mounting bracket: 186 mm
- Air connection inlet: Outside thread 20.96 mm (½")
- Air connection outlet: Outside thread 20.96 mm (½")
- Hose length: 15 m
- Max. working pressure [bar]: 20 bar
- Temperature range: -40°C – 80°C



YouTube Clip



Ⓔ

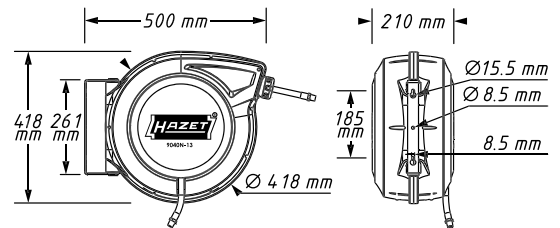
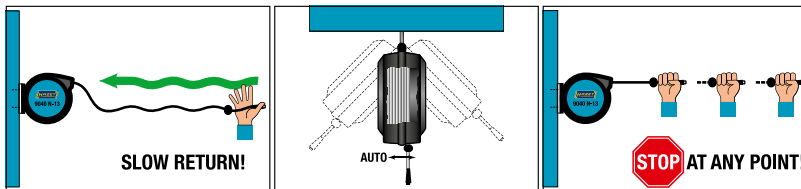

HAZET No.	⚖ g	EAN-No. 4000896+
9040 N-13	9500	214648

9040 Hose reel · open

- Robust steel design with ball-bearing guiding rails
- **Inside diameter of the hose: 10 mm**
- For compressed air
- German air connection nipple for air inlet (9000-015)
- End stop
- Spring return with ratchet locking holders
- Hybrid polymer hose, black
- Integrated roller inlet
- Swivel base – Maximum swivel range: 180°
- Open design against accumulation of dirt
- Visual inspection of the hose
- Length of connection hose: 1 m
- Installation via metal bracket or swivel base (included)
- Drill template on cardboard packaging for easy installation
- Dimensions: 400 x 186 x 522 mm (Including swivel base)
- Can be used with HAZET safety clutch 9000-061
- Air connection inlet: outside thread 16.41 mm (⅝")
- Air connection outlet: outside thread 16.41 mm (⅝")
- Hose length: 20 m
- Max. working pressure [bar]: 12 bar
- Temperature range: -40°C – 60°C

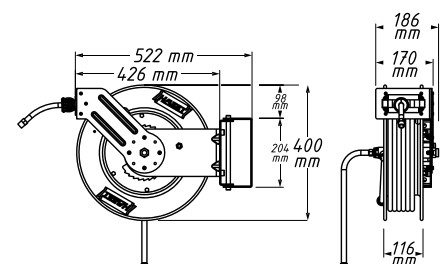

HAZET No.	L x W x H mm	⚖ g	EAN-No. 4000896+
9040 OS-10	400 x 186 x 426	11680	252602



9000-040 Rotary joint · with continuous air flow rate reducer

- Maximum pressure: 16 bar
- Release of the rotating function through compressed air supply, rigid in unpressurised condition
- 12.91 mm / 1/4" thread (inside thread)
- 12.91 mm / 1/4" thread (outside thread)
- Air connection inlet: inside thread 12.91 mm (1/4")
- Air connection outlet: outside thread 12.91 mm (1/4")
- **360° rotatable hinge on 2 axes**
- **Air flow regulation by means of setting wheel**



YouTube Clip



HAZET No.	g	EAN-No. 4000896+
9000-040	88	195350

9000-041 Rotary joint

- **Pneumatic rotary joint can be rotated 360°**
- Sealing material: NBR
- Maximum pressure: 16 bar
- Air connection inlet: inside thread 12.91 mm (1/4")
- Air connection outlet: outside thread 12.91 mm (1/4")
- Surface: nickel-plated
- Temperature range: 0°C – 70°C



YouTube Clip



HAZET No.	g	EAN-No. 4000896+
9000-041	72	204441

9000-010-014 Air inlet nipple set

- **Adaptation of country-specific connection standards to HAZET pneumatic tools**

- 12.91 mm / 1/4" thread
- Steel, nickel-plated
- Design with sealant on the thread
- Air connection inlet: coupler plug 7.2 mm type 1 (DE/AT/SI/HU/CN/IN/PT/RU/PL/RO/TR)
- Air connection outlet: outside thread 12.91 mm (1/4")
- Surface: nickel-plated



9000-011

9000-012



9000-013

9000-014



YouTube Clip

9000-010-014 Air inlet nipple set

HAZET No.	g	Country	EAN-No. 4000896+
9000-010/3	17	Used in Germany (standard), Austria, Slovenia, Hungary, China, India, Portugal, Russia, Poland, Romania, Turkey	195015
9000-011/3	16	Used in Belgium, France, Netherlands, Switzerland	195022
9000-012/3	20	Used in Arab countries, Italy, Spain	195237
9000-013/3	20	Used in Israel / USA	198139
9000-014/3	20	Used in Japan, China, Korea	198160

9000-020 Hose connection nipple set

- **Adaptation of country-specific connections to compressed air hoses**

- Hose clip: 10 mm Ø
- Steel, nickel-plated
- Air connection inlet: coupler plug 7.2 mm type 1 (DE/AT/SI/HU/CN/IN/PT/RU/PL/RO/TR)
- Air connection outlet: hose nipple Ø 10 mm
- Surface: nickel-plated



YouTube Clip



HAZET No.	g	Country	EAN-No. 4000896+
9000-020/3	17	Used in Germany (standard), Austria, Slovenia, Hungary, China, India, Portugal, Russia, Poland, Romania, Turkey	195244

9000-050-080 Safety coupling

- **For all air inlet nipples**



- Safe disconnection of the connection (unwanted disconnection is excluded)
- No risk of injury from hose impact
- Safety coupling depressurizes the connection before decoupling
- Working range: 0 – 20 bar
- One-hand operation
- Little effort during coupling and decoupling
- Omission of loud popping during coupling process
- Easy operation, even with gloves
- Brass, nickel-plated
- Air connection outlet: coupler bushing for type 1, 2, 3, 4
- Surface: nickel-plated

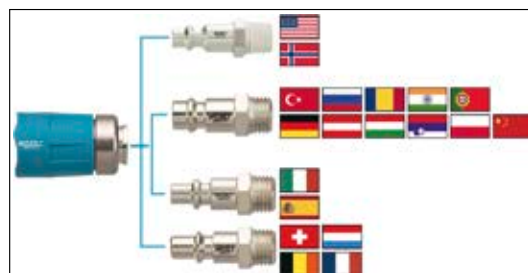



9000-050-080 Safety coupling



YouTube Clip



HAZET No.	Δ± g	EAN-No. 4000896+
<ul style="list-style-type: none"> • Outside thread 12.91 mm / 1/4" • Temperature range: -15°C – 80°C 9000-050	129	195275
<ul style="list-style-type: none"> • Outside thread 16.41 mm / 3/8" • Temperature range: -15°C – 80°C 9000-051	129	195282
<ul style="list-style-type: none"> • Inside thread 12.91 mm / 1/4" • Temperature range: -15°C – 80°C 9000-060	122	195312
<ul style="list-style-type: none"> • Inside thread 16.41 mm / 3/8" • Temperature range: -15°C – 80°C 9000-061	122	195299
<ul style="list-style-type: none"> • Hose nipple: Ø 10 mm • Temperature range: -15°C – 80°C 9000-070	129	195305
<ul style="list-style-type: none"> • Gasket set · for safety couplings 9000-050 · 9000-051 · 9000-060 · 9000-061 · 9000-070 • Easy installation 9000-01/5	–	234691

9000-050-080 Safety coupling

- Only for air inlet nipples 10 mm
- Safe disconnection of the connection (unwanted disconnection is excluded)
- No risk of injury from hose impact
- Safety coupling depressurizes the connection before decoupling
- Working range: 0 – 50 bar
- One-hand operation
- Little effort during coupling and decoupling
- Omission of loud popping during coupling process
- Easy operation, even with gloves
- Hardened steel, galvanized
- Air connection outlet: coupler bushing for type 1, 2, 3, 4
- Surface: nickel-plated

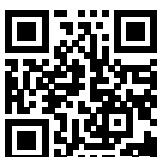

YouTube Clip



HAZET No.	EAN-No. 4000896+
<ul style="list-style-type: none"> • For large 12.5 mm (1/2 inch) cables • Air inlet thread (inside thread) 20.95 mm (1/2") • Temperature range: -10°C – 60°C 9000-062	218936

Pneumatic accessories

2162 Mini grease gun

- Filling capacity: 80 g
- Creates pressure up to 1000 PSI / 69 bar
- Filling with loose grease
- Including lubricating nipple in 50° and 90° versions



HAZET No.	l mm	EAN-No. 4000896+
2162 M	145	185634
<ul style="list-style-type: none"> • Rapid and clean filling of the HAZET 2162M mini grease gun • Improved mechanical stability prevents loss of lubrication performance in vibrating environment • Good water washout resistance • High oxidative stability • High corrosion protection and excellent adhesion on metallic surfaces • Grease cushion 60 ml 		
9300 N-60	–	203406

9012 Silicone protective cover

- Protects the impact wrench housing against damage during tough day-to-day workshop operations
- Semi-transparent protective cover
- Tool-free assembly



HAZET No.	EAN-No. 4000896+
Silicone protective cover for 9012EL-SPC	
9012 EL-SPC-S	222520
Silicone protective cover for 9012M-1	
9012 M-1-S	222735
Silicone protective cover for 9011M and 9012M	
9012 M-S	202232
Silicone protective cover for 9012SPC · 9012-1SPC · 9012P-1	
9012 SPC-S	222476



9070 Mini oiler

• Automatic oiling for extending the service life of your pneumatic tools

- Application: For motor-driven pneumatic tools with air inlet outside thread 12.91 mm (1/4")
- Refillable, filling capacity 28 ml
- Particularly lightweight, compact design
- Threaded insert in the filling nozzle
- Max. air flow: 2612 l/min
- Air connection inlet: outside thread 12.91 mm (1/4")
- Air connection outlet: inside thread 12.91 mm (1/4")
- Max. working pressure [bar]: 10 bar

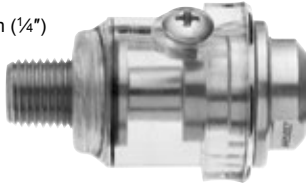

HAZET No.	EAN-No. 4000896+
9070N-1	206407

9000 Compressed air reducer

• Inline pressure regulator for integration in the compressed air line or direct connection to motorised pneumatic equipment

- Max. inlet pressure: 10 bar
- Outlet pressure 6.3 bar
- Max. air flow: 1300 l/min
- Weight including air connection nipple: 140 g
- Including:
 - Adapter from outside thread 12.91 mm (1/4") to outside thread 12.91 mm (1/4") for connecting to the device
 - Air connection nipple 7.2 Type 1 for connection to compressed air coupling
- For safe operation on compressed air lines to 10 bar
- Air connection inlet: inside thread 12.91 mm (1/4")
- Air connection outlet: inside thread 12.91 mm (1/4")

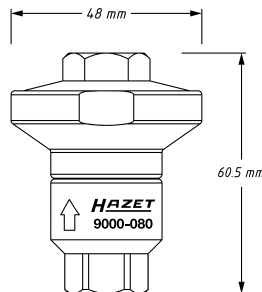

HAZET No.	Δ g	EAN-No. 4000896+
9000-080	100	214709



9070 Maintenance unit

• Dual, consisting of filter-pressure reducer, oil-mist lubricator and manometer

- Connection manometer: 3.2 mm (1/8")
- Max. pressure: 16 bar (1/2" and 3/8") 12 bar (1/4"), Maximum working pressure: 12 bar (1/2" and 3/8") 10 bar (1/4")
- Pressure indication: 0.5–12 bar
- Filter grade: 10 μm
- Recommended lubricant: class F (Sprinter ADVP 22)



HAZET No.	Δ g	EAN-No. 4000896+
9070-2	1380	153343
9070-4	580	153367

9070 Filter-pressure reducer

• Consisting of filter-pressure reducer and manometer

- Connection manometer: 3.2 mm (1/8")
- Max. pressure: 16 bar (1/2" and 3/8") 12 bar (1/4"), Maximum working pressure: 12 bar (1/2" and 3/8") 10 bar (1/4")
- Pressure indication: 0.5–12 bar
- Filter grade: 10 μm
- Capacity filter-pressure reducer: 50 ml



HAZET No.	Δ g	EAN-No. 4000896+
9070-5	890	153374
9070-7	380	153398



Pneumatic tools · Cordless tools

Pneumatic accessories



9400 Special pneumatic tool oil

Made in Germany

- Reduces wear of the air motor
- **Silicon-free** special oil
- Guarantees high performance in daily use
- Extending machine service lives



HAZET No.	g	EAN-No. 4000896+
• Filling capacity: 100 ml • Spout for direct use • With locking cap • Use in engine-driven pneumatic tools such as impact wrenches, grinders etc. 9400-100	11	191390
• Filling capacity: 1000 ml • Transparent filling level indicator • Use in engine-driven pneumatic tools such as impact wrenches, grinders etc. 9400-1000	838	191406

9070 Magnetic holder

- Two strong magnets to hold one impact wrench and four sockets
- Loading capacity: 10 kg

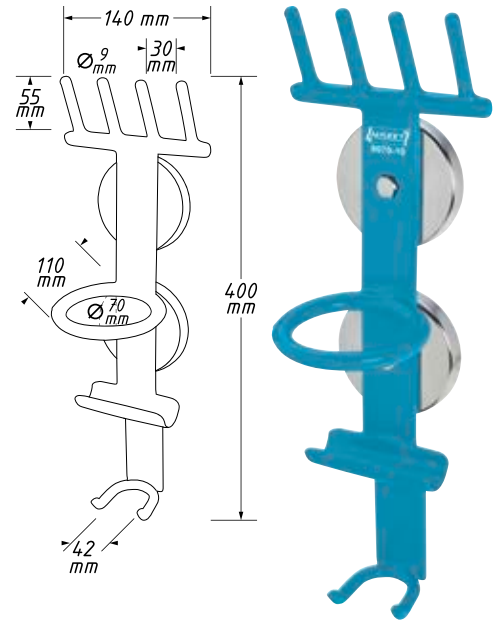
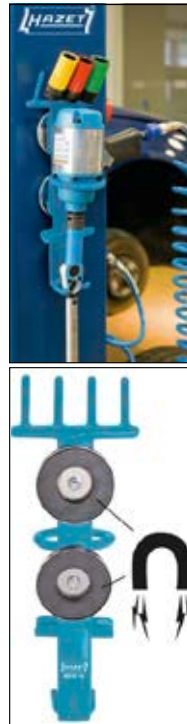

HAZET No.	g	EAN-No. 4000896+
9070-10	1510	158157

9040 D Cable reel

- Hose stop at any point with "Stop at any point" function
- Automatic guidance winds the hose neatly
- Braked winding to prevent risk of accidents

- Including in-line circuit breaker
- 230 V AC
- Only suitable for indoor use
- Cable: H07RN-F 3x2.5 mm²
- Cable length: 20 m
- Connecting cable length: 1.5 m
- Integrated drill template for mounting on cardboard packaging
- Closed special plastic case
- Rotating metal mounting bracket made for separate installation at the workplace
- Borehole spacing of the mounting bracket: 186 mm
- Resilient when wound up with 1600 watts
- Resilient when unwound with 3200 watts
- Meets all relevant requirements defined in the European Directives for Machinery 2006/42/EC
- Type of protection (IP): IP20
- Temperature range: -20°C – 45°C

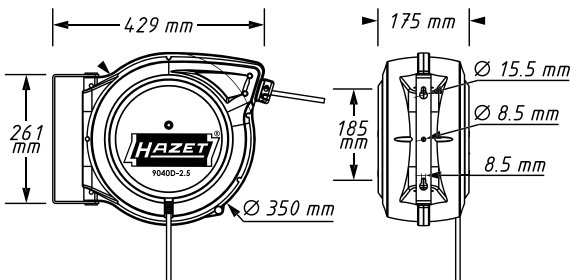

HAZET No.	g	EAN-No. 4000896+
9040 D-2.5	9200	214631



HAZET cordless tool system 18 V

Using battery power for perfect work results!

Cordless tools should be part of any professional workshop's basic equipment. HAZET offers a high-performance cordless tool system in various sets for the two 2 Ah and 5 Ah rechargeable batteries. As well as cordless impact wrenches, this includes a drilling machine and a right-angle grinder. All these tools are available as a **set of 3 pieces** with charger and **a rechargeable battery**, as a **set of 4 pieces** with charger and **two rechargeable batteries** or even just as a **basic unit without accessories** for those who already have the matching HAZET rechargeable batteries.

The respective product details are on the following pages.

9230-2

Cordless drilling machine set

- **Contents** (3-piece set):
 - 1 cordless drill
 - 1 quick charger
 - 1 Li-ion rechargeable battery 18 V, 2.0 Ah
 Delivery in plastic case
- **Optional:**
 - 1 more 2.0 Ah or 5.0 Ah rechargeable battery



9233-7

Right-angle grinder set

- **Contents** (3-piece set):
 - 1 cordless right-angle grinder
 - 1 quick charger
 - 1 Li-ion rechargeable battery 18 V, 5.0 Ah
 Delivery in plastic case
- **Optional:**
 - 1 more 2.0 Ah or 5.0 Ah rechargeable battery
 - Cut-off and rough grinding wheel sets



9212-02

2.0 Ah

9212-03



9234-1

Cordless reciprocating saw set

- **Contents** (3-piece set):
 - 1 cordless reciprocating saw
 - 1 quick charger
 - 1 Li-ion rechargeable battery 18 V, 5.0 Ah
 delivery in HAZET L-Boxx 136 with soft foam insert
- **Optional:**
 - 1 more 2.0 Ah or 5.0 Ah rechargeable battery





Cordless impact wrench sets

- **Contents** (3-piece set):
1 cordless impact wrench
1 quick charger
1 Li-Ion rechargeable battery 18 V, 5.0 Ah or 2.0 Ah
- **Optional:**
1 more 2.0 Ah or 5.0 Ah rechargeable battery



12⁵ 1/2"

9212 SPC-1
260 Nm



12⁵ 1/2"

9212 M-1
270 Nm



12⁵ 1/2"

9212-3
700 Nm



12⁵ 1/2"

9212-1000
1400 Nm



20 3/4"

9213-1000
1400 Nm

Every battery fits every device!

Full HAZET power, full compatibility!

No matter whether 2 or 5 Ah!



9212-05
5.0 Ah





Cordless impact wrenches

9212SPC 1/2" Cordless impact wrench · 18 V

- Illumination of the work area before the output begins to move **125** 1/2 (E)
- Extremely handy tool
- Light weight design
- Amperage without load: 5 A
- Torque acceleration: 200 Nm at 0 – 2700 rpm (0 – 3300 impacts/min)
- Compatible with HAZET rechargeable batteries 9212-02 and 9212-05
- Net weight: 1.06 kg (without rechargeable battery)
- Including belt clip, attachable on both sides, and hand strap
- Total length: 167 mm
- Height: 187 mm
- Width: 65 mm
- Recommended torque: 200
- Sound power level: 111 db(A) Lp W
- Vibration acceleration: 14.91 m/s²
- Loosening torque (max) determined with screw size M: 16

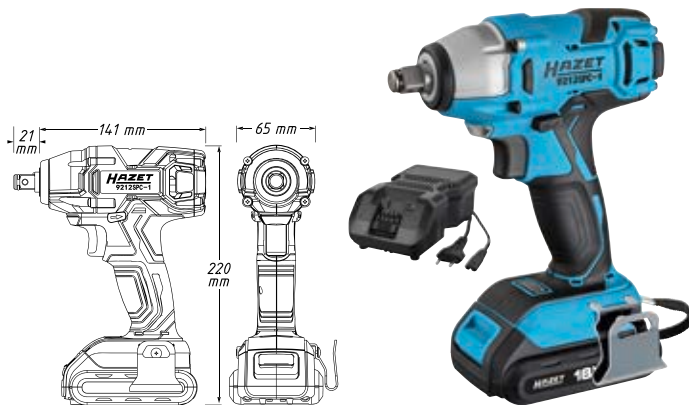

YouTube Clip

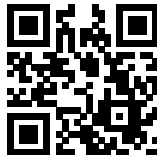

9212M 1/2" Mini cordless impact wrench · 18 V

- High efficiency thanks to brushless motor **125** 1/2 (E)
- Handy, short and lightweight tool
- There are three power stages to choose from for torque acceleration:
 - Stage 1 100 Nm at 0 – 700 rpm (0 – 1200 impacts/min)
 - Stage 2 190 Nm at 0 – 1600 rpm (0 – 2000 impacts/min)
 - Stage 3 220 Nm at 0 – 2500 rpm (0 – 3200 impacts/min)
- Amperage without load: 4.5 A
- **Brushless DC motor (BLDC):**
 - Longer service life, less wear, no need to change the carbon brushes
 - High efficiency and hence less battery consumption
 - More compact motor enables smaller dimensions
- Illumination of the work area before the output begins to move
- Net weight: 0.96 kg (without rechargeable battery)
- Dimensions including rechargeable battery: 228 x 63 x 135 mm
- Including belt clip, attachable on both sides, and hand strap
- Recommended torque: 220
- Sound power level: 110.6 db(A) Lp W
- Vibration acceleration: 15.40 m/s²
- Loosening torque (max) determined with screw size M: 16



YouTube Clip



HAZET No.	max. Nm	max. Nm	rpm	db(A) LpA	g	EAN-No. 4000896+
• 3-piece set · in textile bag: 1 cordless impact wrench 1 quick charger 1 Li-ion rechargeable battery 18 V, 2 Ah						
9212SPC-1	260	200	0–3300	100	1450	3 212439
• 4-piece set · in textile bag: 1 cordless impact wrench 1 quick charger 2 Li-ion rechargeable batteries 18 V, 2 Ah						
9212SPC-1/4	260	200	0–2700	100	–	4 214259
• Basic unit cordless impact wrench (without rechargeable battery, charger, textile bag)						
9212SPC-010	260	200	0–2700	100	1060	– 214273
• Battery pack • Li-ion, 18 V, 2 Ah • Charging time about 35 minutes (in HAZET 9212-03) • For 9212-3 · 9212M-1 · 9212M-1/4 · 9212SPC-1 · 9212SPC-1/4 · 9230-2 · 9230-2/4 · 9233-7 · 9233-7/4						
9212-02	–	–	–	–	390	– 213788
• Battery pack • Li-ion, 18 V, 5 Ah • Charging time about 80 minutes (in HAZET 9212-03) • For 9212-3 · 9212M-1 · 9212M-1/4 · 9212SPC-1 · 9212SPC-1/4 · 9230-2 · 9230-2/4 · 9233-7 · 9233-7/4						
9212-05	–	–	–	–	700	– 210367
• Quick charger • For Li-ion rechargeable battery 9212-02 · 9212-05 • Use in 9212-3 · 9212M-1 · 9212M-1/4 · 9212SPC-1 · 9212SPC-1/4 · 9230-2 · 9230-2/4 · 9233-7 · 9233-7/4						
9212-03	–	–	–	–	660	– 204823

HAZET No.	max. Nm	max. Nm	rpm	db(A) LpA	g	EAN-No. 4000896+
• 3-piece set · in textile bag: 1 cordless impact wrench 1 quick charger 1 Li-ion rechargeable battery 18 V, 2 Ah						
9212M-1	270	220	0–2500	99.6	1340	3 212446
• 4-piece set · in textile bag: 1 cordless impact wrench 1 quick charger 2 Li-ion rechargeable batteries 18 V, 2 Ah						
9212M-1/4	270	220	0–2500	99.6	–	4 214266
• Basic unit mini cordless impact wrench (without rechargeable battery, charger, textile bag)						
9212M-010	270	220	0–2500	99.6	950	– 214280
• Battery pack • Li-ion, 18 V, 2 Ah • Charging time about 35 minutes (in HAZET 9212-03) • For 9212-3 · 9212M-1 · 9212M-1/4 · 9212SPC-1 · 9212SPC-1/4 · 9230-2 · 9230-2/4 · 9233-7 · 9233-7/4						
9212-02	–	–	–	–	390	– 213788
• Battery pack • Li-ion, 18 V, 5 Ah • Charging time about 80 minutes (in HAZET 9212-03) • For 9212-3 · 9212M-1 · 9212M-1/4 · 9212SPC-1 · 9212SPC-1/4 · 9230-2 · 9230-2/4 · 9233-7 · 9233-7/4						
9212-05	–	–	–	–	700	– 210367
• Quick charger • For Li-ion rechargeable battery 9212-02 · 9212-05 • Use in 9212-3 · 9212M-1 · 9212M-1/4 · 9212SPC-1 · 9212SPC-1/4 · 9230-2 · 9230-2/4 · 9233-7 · 9233-7/4						
9212-03	–	–	–	–	660	– 204823



Pneumatic tools · Cordless tools

Cordless impact wrenches



9212-3 1/2" Cordless impact wrench set

• High efficiency thanks to brushless motor

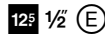

- 18 V, 5 Ah
- There are three power stages to choose from for torque acceleration:
 - Stage 1 80 Nm at 0 – 600 rpm (0 – 1200 impacts/min)
 - Stage 2 300 Nm at 0 – 1400 rpm (0 – 2500 impacts/min)
 - Stage 3 500 Nm at 0 – 2000 rpm (0 – 3400 impacts/min)
- Illumination of the work area before the output begins to move
- Amperage without load: 5.5 A
- Net weight: 1.86 kg (without rechargeable battery)
- Dimensions including rechargeable battery: 204 x 64 x 259 mm
- Including belt clip, attachable on both sides
- **Brushless DC motor (BLDC)**
 - Longer service life, less wear, no need to change the carbon brushes
 - High efficiency and hence less battery consumption
 - More compact motor enables smaller dimensions
- Recommended torque: 500
- Sound power level: 110.4 db(A) Lp W
- Vibration acceleration: 20.30 m/s²
- Loosening torque (max) determined with screw size M: 16
- Forward and reverse: multi-stage (right/left)
- L-Boxx 190 L-136



YouTube Clip

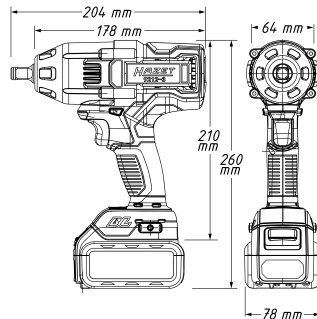

HAZET No.	max. Nm	max. Nm	rpm	db(A) LpA	g	EAN-No. 4000896+
• 3-piece set · in HAZET L-Boxx 136 and soft foam insert: 1 cordless impact wrench 1 quick charger 1 Li-ion rechargeable battery 18 V, 5 Ah						
9212-3 LB/3	700	500	0–2000	99.4	1857	3 244164
• 4-piece set · in HAZET L-Boxx 136 and soft foam insert: 1 cordless impact wrench 1 quick charger 2 Li-ion rechargeable batteries 18 V, 5 Ah						
9212-3 LB/4	700	500	0–2000	99.4	1857	4 244171
• Basic unit cordless impact wrench (without rechargeable battery, charger, case)						
9212-010	700	500	0–2000	99.4	–	– 221790
• Quick charger • For Li-ion rechargeable battery 9212-02 · 9212-05 • Use in 9212-3 · 9212M-1 · 9212M-1/4 · 9212SPC-1 · 9212SPC-1/4 · 9230-2 · 9230-2/4 · 9233-7 · 9233-7/4						
9212-03	–	–	–	–	660	– 204823
• Battery pack • Li-ion, 18 V, 5 Ah • Charging time about 80 minutes (in HAZET 9212-03) • For 9212-3 · 9212M-1 · 9212M-1/4 · 9212SPC-1 · 9212SPC-1/4 · 9230-2 · 9230-2/4 · 9233-7 · 9233-7/4						
9212-05	–	–	–	–	700	– 210367

9212-1000 1/2" Cordless impact wrench

• High efficiency thanks to brushless motor

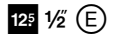

- 18 V, 5 Ah
- Suitable for continuous operation
- Robust machine housing
- There are three power stages to choose from for torque acceleration:
 - Stage 1 180 Nm at 0 – 400 rpm (0 – 800 impacts/min)
 - Stage 2 400 Nm at 0 – 800 rpm (0 – 1600 impacts/min)
 - Stage 3 1000 Nm at 0 – 1800 rpm (0 – 2200 impacts/min)
- Illumination of the work area before the output begins to move
- Compatible with HAZET rechargeable batteries 9212-02 and 9212-05
- Dimensions including rechargeable battery: 278 x 230 x 89.5 mm
- Including belt clip, attachable on both sides
- **Brushless DC motor (BLDC)**
 - Longer service life, less wear, no need to change the carbon brushes
 - High efficiency and hence less battery consumption
 - More compact motor enables smaller dimensions
- Sound power level: 112 db(A) Lp W
- Vibration acceleration: 17.80 m/s²
- Loosening torque (max) determined with screw size M: 24
- Forward and reverse: multi-stage (right/left)



YouTube Clip

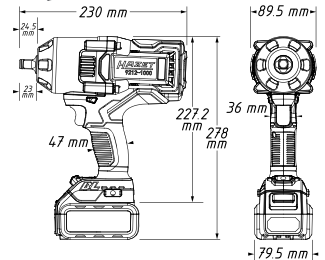

HAZET No.	max. Nm	max. Nm	rpm	db(A) LpA	g	EAN-No. 4000896+
• 4-piece set · in case (weight 2.15 kg): 1 cordless impact wrench 1 quick charger 2 Li-ion batteries 18 V, 5 Ah						
9212-1000/4	1400	1000	0–1800	101	3640	4 222681
• 3-piece set · in HAZET L-Boxx 136 and soft foam insert: 1 cordless impact wrench 1 quick charger 1 Li-ion rechargeable battery 18 V, 5 Ah						
9212-1000 LB/3	1400	1000	0–1800	101	3640	3 249848
• 4-piece set · in HAZET L-Boxx 136 and soft foam insert: 1 cordless impact wrench 1 quick charger 2 Li-ion rechargeable batteries 18 V, 5 Ah						
9212-1000 LB/4	1400	1000	0–1800	101	3640	4 249909
• Basic unit cordless impact wrench (without rechargeable battery, charger, case)						
9212-1000	1400	1000	0–1800	101	3640	– 222711
• Battery pack • Li-ion, 18 V, 2 Ah • Charging time about 35 minutes (in HAZET 9212-03) • For 9212-3 · 9212M-1 · 9212M-1/4 · 9212SPC-1 · 9212SPC-1/4 · 9230-2 · 9230-2/4 · 9233-7 · 9233-7/4						
9212-02	–	–	–	–	390	– 213788
• Battery pack • Li-ion, 18 V, 5 Ah • Charging time about 80 minutes (in HAZET 9212-03) • For 9212-3 · 9212M-1 · 9212M-1/4 · 9212SPC-1 · 9212SPC-1/4 · 9230-2 · 9230-2/4 · 9233-7 · 9233-7/4						
9212-05	–	–	–	–	700	– 210367
• Quick charger • For Li-ion rechargeable battery 9212-02 · 9212-05 • Use in 9212-3 · 9212M-1 · 9212M-1/4 · 9212SPC-1 · 9212SPC-1/4 · 9230-2 · 9230-2/4 · 9233-7 · 9233-7/4						
9212-03	–	–	–	–	660	– 204823



9213-1000 3/4" Cordless impact wrench

- High efficiency thanks to brushless motor

20 3/4" (E)

18 V, 5 Ah

- Suitable for continuous operation
- Robust machine housing
- There are three power stages to choose from for torque acceleration:
 - Stage 1 180 Nm at 0 – 400 rpm (0 – 800 impacts/min)
 - Stage 2 400 Nm at 0 – 800 rpm (0 – 1600 impacts/min)
 - Stage 3 1000 Nm at 0 – 1800 rpm (0 – 2200 impacts/min)
- Illumination of the work area before the output begins to move
- Li-ion rechargeable battery with very low self-discharge (only 2%) compared to a standard NiMH rechargeable battery (15–25%)
- Compatible with HAZET rechargeable batteries 9212-02 and 9212-05
- Battery net weight: 0.66 kg (only sets 9213-1000/3 and 9213-1000/4)
- Battery charger net weight: 0.66 kg (only sets 9213-1000/3 and 9213-1000/4)
- Case net weight: 2.15 kg (only sets 9213-1000/3 and 9213-1000/4)
- Dimensions including rechargeable battery: 278 x 230 x 89.5 mm
- Including belt clip, attachable on both sides
- **Brushless DC motor (BLDC)**
 - Longer service life, less wear, no need to change the carbon brushes
 - High efficiency and hence less battery consumption
 - More compact motor enables smaller dimensions
- Sound power level: 112 db(A) Lp W
- Vibration acceleration: 17.80 m/s²
- Loosening torque (max) determined with screw size M: 24
- Forward and reverse: multi-stage (right/left)

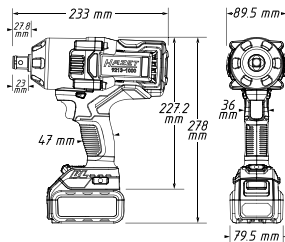

YouTube Clip



HAZET No.	max. Nm	max. Nm	rpm	db (A) LpA	g	EAN-No. 4000896+
• 3-piece set · in case: 1 cordless impact wrench 1 quick charger 1 Li-ion rechargeable battery 18 V, 5 Ah						
9213-1000/3	1400	1000	0–1800	101	3700	3 222704
• 3-piece set · in HAZET L-Boxx 136 and soft foam insert: 1 cordless impact wrench 1 quick charger 1 Li-ion rechargeable battery 18 V, 5 Ah						
9213-1000LB/3	1400	1000	0–1800	101	3700	3 249886
• 4-piece set · in HAZET L-Boxx 136 and soft foam insert: 1 cordless impact wrench 1 quick charger 2 Li-ion rechargeable batteries 18 V, 5 Ah						
9213-1000LB/4	1400	1000	0–1800	101	3700	4 249862
• Basic unit cordless impact wrench (without rechargeable battery, charger, case)						
9213-1000	1400	1000	0–1800	101	3700	– 222698
• Battery pack						
• Li-ion, 18 V, 2 Ah						
• Charging time about 35 minutes (in HAZET 9212-03)						
• For 9212-3 · 9212M-1 · 9212M-1/4 · 9212SPC-1 · 9212SPC-1/4 9230-2 · 9230-2/4 · 9233-7 · 9233-7/4						
9212-02	–	–	–	–	390	– 213788
• Battery pack						
• Li-ion, 18 V, 5 Ah						
• Charging time about 80 minutes (in HAZET 9212-03)						
• For 9212-3 · 9212M-1 · 9212M-1/4 · 9212SPC-1 · 9212SPC-1/4 9230-2 · 9230-2/4 · 9233-7 · 9233-7/4						
9212-05	–	–	–	–	700	– 210367

9213-1000 3/4" Cordless impact wrench

20 3/4" (E)

HAZET No.	max. Nm	max. Nm	rpm	db (A) LpA	g	EAN-No. 4000896+
• Quick charger						
• For Li-ion rechargeable battery 9212-02 · 9212-05						
• Use in 9212-3 · 9212M-1 · 9212M-1/4 · 9212SPC-1 · 9212SPC-1/4 9230-2 · 9230-2/4 · 9233-7 · 9233-7/4						
9212-03	–	–	–	–	660	– 204823

9230 B Cordless screwdriver set

- Charging cable: 1.5 m
- Including holster
- Plastic roll

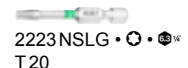
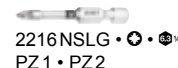
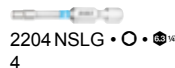

HAZET No.	max. Nm	rpm	g	EAN-No. 4000896+
9230 B-1	4.5	180	7	250820

Cordless drilling machine / right-angle grinder / reciprocating saw

9230 Cordless drill

- High efficiency thanks to brushless motor

(E)

- 18 V, 2 Ah
- Compatible with HAZET rechargeable batteries 9212-02 and 9212-05
- Metal quick-clamping drill chuck 1-13 mm
- Selectable torque settings 15 + 1 drilling
- Revolutions per minute Step 1: 0–560
Revolutions per minute Step 2: 0–1900
- Vibration acceleration screwing: 0.8 m/s²
Vibration acceleration drilling: 2.3 m/s²
- Robust machine housing
- Suitable for continuous operation
- Including belt clip, attachable on both sides
- Weight with battery pack: 1.68 kg (only sets 9230-2 and 9230-2/4)
Weight without battery pack: 1.27 kg
- **Brushless DC motor (BLDC):**
 - Longer service life, less wear, no need to change the carbon brushes
 - Greater efficiency and thus less battery consumption – More compact motor allows for smaller installation dimensions
- Plastic roll



YouTube Clip

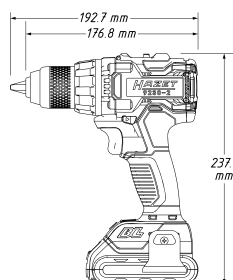



Pneumatic tools · Cordless tools

Cordless drilling machine / right-angle grinder / reciprocating saw



9230 Cordless drill



HAZET No.	\vec{r} Nm	dB(A) LpA	g		EAN-No. 4000896+
• 3-piece set · in textile bag: 1 cordless drill 1 quick charger 1 Li-ion rechargeable battery 18 V, 2 Ah					
9230-2	60	68	-	3	218370
• 4-piece set · in textile bag: 1 cordless drill 1 quick charger 2 Li-ion rechargeable batteries 18 V, 2 Ah					
9230-2/4	60	68	-	4	218967
• Basic unit cordless drill (without rechargeable battery, charger, textile bag)					
9230-010	60	68	-	-	218974
• Battery pack • Li-ion, 18 V, 2 Ah • Charging time about 35 minutes (in HAZET 9212-03) • For 9212-3 · 9212M-1 · 9212M-1/4 · 9212SPC-1 · 9212SPC-1/4 9230-2 · 9230-2/4 · 9233-7 · 9233-7/4					
9212-02	-	-	390	-	213788
• Battery pack • Li-ion, 18 V, 5 Ah • Charging time about 80 minutes (in HAZET 9212-03) • For 9212-3 · 9212M-1 · 9212M-1/4 · 9212SPC-1 · 9212SPC-1/4 9230-2 · 9230-2/4 · 9233-7 · 9233-7/4					
9212-05	-	-	700	-	210367
• Quick charger • For Li-ion rechargeable battery 9212-02 · 9212-05 • Use in 9212-3 · 9212M-1 · 9212M-1/4 · 9212SPC-1 · 9212SPC-1/4 9230-2 · 9230-2/4 · 9233-7 · 9233-7/4					
9212-03	-	-	660	-	204823
• Eraser disc · Removal of decorative strips, foil lettering, adhesive residues from balance weights • Adapter for socket in 6 mm collet chuck • Diameter 89 mm • Thickness 15 mm • Max. rpm 4000					
9030 R-01/2	-	-	-	-	241804

9233 Cordless right-angle grinder



• High efficiency thanks to brushless motor

- Compatible with HAZET rechargeable batteries 9212-02 and 9212-05
- Ergonomic and compact housing design
- Device stops if the speed drops sharply due to canting
- Function against unintentional motor start when changing the battery
- Mesh fabric protects motor from dirt
- Motor stop 2 seconds after switch-off
- Extremely flat head with low angle
- Constant speed even during difficult work
- Soft startup for greater comfort
- Safety lever
- Lateral handle, to be used on left or right side
- Including 1 protective cover each
– for cut-off wheels
– for rough grinding wheels
- Quick adjustment of protection cover without tools
- Spindle thread: M14
- Spindle lock
- Weight with battery: 2.28 kg
(only with sets 9233-7 and 9233-7/4)
- Weight without battery: 1.53 kg
- Vibration acceleration: 7.90 m/s²



YouTube Clip



9233 Cordless right-angle grinder

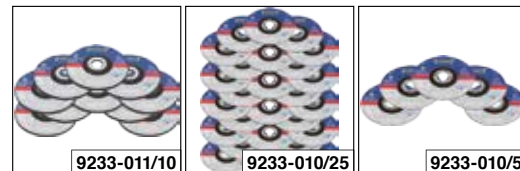
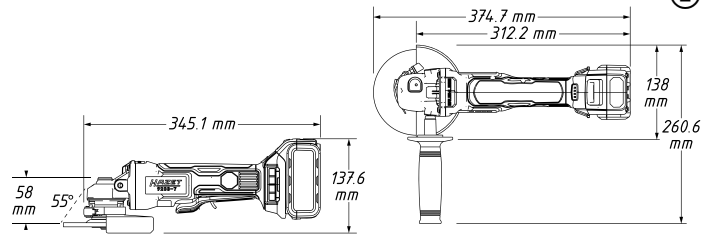

HAZET No.	l mm	rpm	dB(A) LpA	g		EAN-No. 4000896+
• 3-piece set · in case: 1 cordless right-angle grinder 1 quick charger 1 Li-ion rechargeable battery 18 V, 5 Ah						
9233-7	345.1	8000	89	-	3	218325
• 4-piece set · in case: 1 cordless right-angle grinder 1 quick charger 2 Li-ion rechargeable batteries 18 V, 5 Ah						
9233-7/4	345.1	8000	89	-	4	218950
• Basic unit cordless right-angle grinder (without rechargeable battery, charger, case)						
9233-010	345.1	8000	89	-	-	218943
• Battery pack • Li-ion, 18 V, 2 Ah • Charging time about 35 minutes (in HAZET 9212-03) • For 9212-3 · 9212M-1 · 9212M-1/4 · 9212SPC-1 · 9212SPC-1/4 9230-2 · 9230-2/4 · 9233-7 · 9233-7/4						
9212-02	-	-	-	390	-	213788
• Battery pack • Li-ion, 18 V, 5 Ah • Charging time about 80 minutes (in HAZET 9212-03) • For 9212-3 · 9212M-1 · 9212M-1/4 · 9212SPC-1 · 9212SPC-1/4 9230-2 · 9230-2/4 · 9233-7 · 9233-7/4						
9212-05	-	-	-	700	-	210367
• Quick charger • For Li-ion rechargeable battery 9212-02 · 9212-05 • Use in 9212-3 · 9212M-1 · 9212M-1/4 · 9212SPC-1 · 9212SPC-1/4 9230-2 · 9230-2/4 · 9233-7 · 9233-7/4						
9212-03	-	-	-	660	-	204823
5 cut-off wheels 125 x 1 x 22.23 mm (5 x 0.40 x 7/8") • For cordless right-angle grinders 9233-7 · 9233-7/4 • 41 AS 60 PBF-RCF80 • Suitable for stainless steel · mild steel · thin-walled sheets · profiles · tubes • Standards: DIN EN 12413 and oSa • Maximum rotation speed 12200 rpm • Maximum cutting speed 80 m/s						
9233-010/5	-	-	-	-	5	219063
25 cut-off wheels 125 x 1 x 22.23 mm (5 x 0.40 x 7/8") • For cordless right-angle grinders 9233-7 · 9233-7/4 • 41 AS 60 PBF-RCF80 • Suitable for stainless steel · mild steel · thin-walled sheets · profiles · tubes • Standards: DIN EN 12413 and oSa • Maximum rotation speed 12200 rpm • Maximum cutting speed 80 m/s						
9233-010/25	-	-	-	-	25	219070
10 rough grinding wheels 125 x 6 x 22.23 mm (5 x 1/4 x 7/8") • For cordless right-angle grinders 9233-7 · 9233-7/4 • 27 AS 24 O7 BF • Also suitable for stainless steel • Standards: DIN EN 12413 and oSa • Maximum rotation speed 12200 rpm • Maximum cutting speed 80 m/s						
9233-011/10	-	-	-	-	10	219087



9234 Cordless reciprocating saw

- High efficiency thanks to brushless motor
- Compatible with HAZET rechargeable batteries 9212-02 and 9212-05
- Strokes/min.: 9500
- Cutting capacity wood: 200 mm
- Cutting capacity metal: 20 mm
- Tool-free saw blade quick-change system
- Quick adjustment of bars without tools
- Composite housing
- Brushless DC motor (BLDC):
 - Longer service life, less wear, no need to change the carbon brushes
 - Greater efficiency and thus less battery consumption – More compact motor allows for smaller installation dimensions
- Integrated battery status indication (4 LEDs)
- Soft handle for optimum feel
- Can be used for double-walled sheet steel
- Sound power level: 97.13 db(A) Lp W
- Vibration acceleration: 32.18 m/s²
- Saw stroke: 28.5 mm

(E)



9234-010

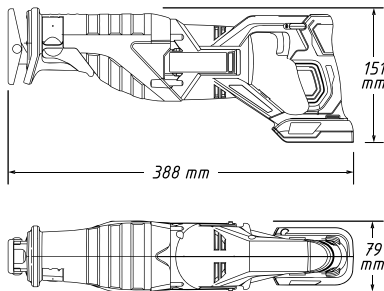

9234 M-150/5



9234 P-150/5



9234 X-150/5



9234 P-225/5



9234 W-225/5



9034 P-R/5

HAZET No.	l mm	rpm	db (A) LpA	g	EAN-No. 4000896+
-----------	------	-----	------------	---	------------------

- **3-piece set** · in HAZET L-Boxx 136 and soft foam insert:
 - 1 cordless reciprocating saw
 - 1 quick charger
 - 1 Li-ion rechargeable battery 18 V, 5 Ah

9234-1 – 3100 86.13 2260 3 234714

- **4-piece set** · in HAZET L-Boxx 136 and soft foam insert:
 - 1 cordless reciprocating saw
 - 1 quick charger
 - 2 Li-ion rechargeable batteries 18 V, 5 Ah

9234-1/4 – 3100 86.13 2260 4 234721

- **Basic unit cordless reciprocating saw** (without rechargeable battery and charger)

9234-010 – 3100 86.13 2260 – 234707

9234 Cordless reciprocating saw

(E)

HAZET No.	l mm	rpm	db (A) LpA	g	EAN-No. 4000896+
-----------	------	-----	------------	---	------------------

- **Battery pack**
- **Li-ion, 18 V, 2 Ah**
- Charging time about 35 minutes (in HAZET 9212-03)
- For 9212-3 · 9212M-1 · 9212M-1/4 · 9212SPC-1 · 9212SPC-1/4 · 9230-2 · 9230-2/4 · 9233-7 · 9233-7/4

9212-02 – – – 390 – 213788

- **Quick charger**
- For Li-ion rechargeable battery 9212-02 · 9212-05
- Use in 9212-3 · 9212M-1 · 9212M-1/4 · 9212SPC-1 · 9212SPC-1/4 · 9230-2 · 9230-2/4 · 9233-7 · 9233-7/4

9212-03 – – – 660 – 204823

- **Battery pack**
- **Li-ion, 18 V, 5 Ah**
- Charging time about 80 minutes (in HAZET 9212-03)
- For 9212-3 · 9212M-1 · 9212M-1/4 · 9212SPC-1 · 9212SPC-1/4 · 9230-2 · 9230-2/4 · 9233-7 · 9233-7/4

9212-05 – – – 700 – 210367

- **5 flexible reciprocating saw blades** for steel and nonferrous metal from 2 – 8 mm
- For cordless reciprocating saw 9234
- Length of serration: 130 mm

9234 M-150/5 150 – – – 5 239382

- **5 flexible reciprocating saw blades** for wood with nails and faster sawing progress in metal 2 – 10 mm
- For cordless reciprocating saw 9234
- Serration for long service life
- Length of serration: 130 mm

9234 P-150/5 150 – – – 5 239405

- **5 flexible reciprocating saw blades** for steel and stainless steel (Inox) from 1.5 – 4 mm
- For cordless reciprocating saw 9234
- Length of serration: 130 mm

9234 X-150/5 225 – – – 5 239597

- **5 flexible reciprocating saw blades** for wood with nails and faster sawing progress in metal 2 – 10 mm
- For cordless reciprocating saw 9234
- Serration for long service life
- Length of serration: 205 mm

9234 P-225/5 225 – – – 5 239412

- **5 reciprocating saw blades** for all wood types, plastics as well as plasterboard 6 – 100 mm
- For cordless reciprocating saw 9234
- Length of serration: 205 mm

9234 W-225/5 150 – – – 5 239429

- **Reciprocating sabre saw blade** for sabre saw 9034P-2 and cordless reciprocating saw 9234
- 5 pieces per package
- 18 teeth/inch, bevelled, corrugated teeth
- For all metals including non-iron pipes, sheets and stainless steel, material thickness 1.5 – 3 mm
- Total length: 153 mm
- Width 19 mm
- Thickness 1 mm
- Bi-metal

9034 P-R/5 153 – – – 175 – 218318

- Internal dimensions (LxWxH): 378x310x101 mm
- Volume: 13.3 l

190 L-136 445 – – – 2200 – 237616





Heat guns

1990 Heat gun

- Power: 2300 watts
- 5 storage functions (air stage / temperature)
- Optimised flow guidance
- Digital temperature control (integrated temperature probe)
- Configurable Power Safety function (eco mode)
 - Eco 1 movement-triggered eco function
 - Eco 2 position-triggered eco function (saves up to 40% energy and reduces the noise level up to 50%)
- Ceramic heating element
- Temperature control concept (Close Loop)
- Soft touch handle area
- Best ergonomics, even distribution of weight
- Standby position (standby key):
 - When the hash key is pressed, the device swivels to the standby function
- Long life engine class: 1 kh
- Temperature range (electronically controlled and continuously adjustable): 80–650°C
- Air volume range (l/min at 20°C: 200–550 l/min), electronically controlled and continuously adjustable
- Complete unit tested for 1000 h
- L-Boxx 190 L-136



1990 N-01



1990 N-020/5

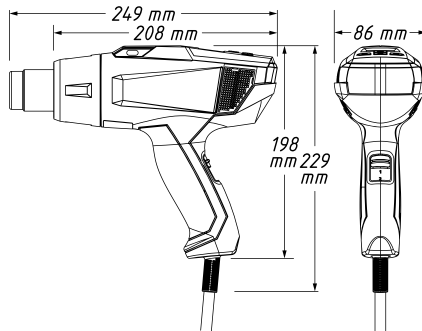

1990 Heat gun

- **Basic design – excellent price-quality ratio**
- Power: **1600 watts**
- 2 air volume ranges: **350 / 500 l/min (two-stage switch)**
- High-quality ceramic heater, optimal device cooling and powerful motor ensure a long service life
- Sucked in air is not blown through the motor – preventing dirt from contaminating the motor
- Optimal, well balanced ergonomics
- Can be placed upright (readiness storage)
- Including heating element protection
- Electronics: Flicker-compliant
- Temperature range: 350°C – 500°C



YouTube Clip



HAZET No.

EAN-No. 4000896+

1990-10

218271



HAZET No.

EAN-No. 4000896+

- **6-piece set** · in HAZET L-Boxx 136 and soft foam insert:
 - Basic unit
 - 4 nozzles (spoon reflector nozzle angled at 90° · solder reflector nozzle · pipe nozzle · wide slot nozzle angled at 15°)
 - Pressure roller 30 mm wide

1990 N/6 6 241378

- **Basic unit heat gun** (without rechargeable battery, charger, L-Boxx)

1990 N-010 – 241088

- **Protective ring** for heat gun 1990N/6 and 1990N-010
- Can be easily inserted into the standard case insert of the L-Boxx when assembled or disassembled

1990 N-01 – 241118

- **Accessories set** · for heat gun 1990N
- Spoon reflector nozzle angled at 90°
- Solder reflector nozzle
- Wide slot nozzle angled at 15°
- Pipe nozzle
- Pressure roller with 30 mm width

1990 N-020/5 – 241101





Diagnostics / Borescope technology

393–395

Lights

396–400

Workshop creepers/seats · Floor mats

401

Lubrication technology

402–405

General workshop tools

406

Safety at work

407



Innovative wireless charging

Charging by placing it on top – wireless charging

Same charging capacity as with conventional charging via cable



No mess of cables

Wireless charging improves safety by eliminating tripping hazards due to various charging cables. Your workshop looks neat and tidy when you get rid of the jumble of cables.

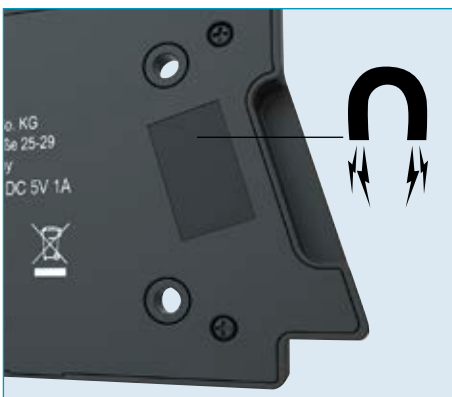

Magnetic holder

The magnetic holder enables flexible positioning on magnetic surfaces. The support base which is attached to the pad is not damaged by screwing or similar.



Self-positioning

The self-positioning feature allows for reliable and easy placement of the lamp. This prevents the lamp from not charging due to misplacement.



Additional charging source

In addition to wireless charging, HAZET charging pads also allow traditional charging. There is a USB port on the bottom of the pad where cables can be plugged in.



First-rate lighting – for first-rate work:

Lighting technology terms



What are lumens?

The higher the „lumen value“, the more light a lamp distributes in all directions. In contrast to the unit lux, the illuminated object is not taken into account. With light bulbs, the light output was still dependent on the power consumption in watts. This has now fundamentally changed, because the HAZET LED technology minimises power consumption and maximises the lumen value!

Good LED light = high CRI value

The higher the „colour rendering index“ value of a lamp, the more natural the colours of the illuminated objects appear to the human eye. The natural light of the sun, which contains all spectral colours and has a maximum RA value of 100, is the reference used. All HAZET LED lights from the new series have a CRI value of at least 85.

IK impact resistance code

This measure indicates the resistance of a plastic housing for electrical equipment. A class IK10 housing can even withstand blows from baseball bats, while a class IK00 housing breaks even when struck with a fist. Housing with a high class can be used in a football hall, for example, or if there is danger of vandalism. The minimum standard of the HAZET LED lamps is IK protection class 7, which means they can withstand a blow with a hammer from a distance of 40 cm.

An overview of IP safety classes

The acronym IP stands for „International Protection“. It is supplemented by a number/letter combination that provides information on the extent to which the product is protected against contact, foreign bodies, dust and water. IP54 means extensive splash water protection as well as dust resistance depending on the diameter of an object. From class 65 onwards, the product is dust-tight and protected against water jets from any angle.

IP digit 1	Protection from...	Protection against contact		
0	No protection	No protection		
1	Foreign objects from	Prevents access with		
2			50.0 mm	Back of the hand
3			12.5 mm	A finger
4			2.5 mm	A tool
5	Dust in harmful quantities	Full protection against contact		
6	Dust-tight			

IP digit 2	Water protection against...
0	No protection
1	Dripping water
2	Falling dripping water when the housing is tilted by up to 15°
3	Falling spray up to 60° from vertical
4	Splashing water on all sides
5	Water jets (nozzle) from any angle
6	Strong jets of water
7	Temporary immersion
8	Permanent immersion
9	Water during high pressure cleaning and steam jet cleaning



		Luminous flux 100%	Operating time 100%	Protection rating (IP)	Protection rating (IK)	Battery / rechargeable battery designation	Power supply	LED technology
	1979 N-71	130 lm	4 h	IP54	IK07	2x 1.5 V Micro / AAA / (L)R03	Battery	SMD
	1979 N-72	200 lm	4.5 h	IP54	IK07	3x 1.5 V Micro / AAA / (L)R03	Battery	SMD
	1979-11	200 lm	2.5 h	IP65	IK09	3.7 V 1050 mAh lithium-ion rechargeable battery	USB cable (USB C)	COB/SMD
	1979 N-82	300 lm	2 h	IP65	IK09	3.7 V 1200 mAh lithium-ion rechargeable battery	USB cable (USB C)	COB/SMD
	1979 N-85	600 lm	3 h	IP65	IK09	3.7 V 2600 mAh lithium-ion rechargeable battery	USB cable (USB C)	COB/SMD
	1979 N-92	1100 lm	3 h	IP65	IK08	3.6 V 4500 mAh lithium-ion rechargeable battery	USB cable (USB C)	COB/SMD
	1979 W-11	200 lm	2.5 h	IP65	IK09	3.7 V 1050 mAh lithium-ion rechargeable battery	Wireless charging	COB/SMD
	1979 W-82	300 lm	2 h	IP65	IK09	3.7 V 1200 mAh lithium-ion rechargeable battery	Wireless charging	COB/SMD
	1979 W-11/3	200 lm	2.5 h	IP65	IK09	3.7 V 1050 mAh lithium-ion rechargeable battery	Wireless charging	COB/SMD
	1979 NW/3	200 lm 300 lm	2 h 2.5 h	IP65 IP65	IK09 IK09	3.7 V 1050 mAh 3.7 V 1200 mAh lithium-ion rechargeable battery	Wireless charging	COB/SMD
	1979 W-85	600 lm	3 h	IP65	IK09	3.7 V 2600 mAh lithium-ion rechargeable battery	Wireless charging	COB/SMD
	1979 W-92	1100 lm	3 h	IP65	IK08	3.6 V 4500 mAh lithium-ion rechargeable battery	Wireless charging	COB/SMD
	1979 W 1/3	300 lm 1100 lm	2 h 3 h	IP65 IP65	IK08 IK09	3.7 V 1200 mAh 3.6 V 4500 mAh lithium-ion rechargeable battery	Wireless charging	COB/SMD
	1979 WP-1						USB cable (USB C)	
	1979 WP-2						USB cable (USB C)	
	1979 FC-60	6000 lm		IP54	IK07		230 V safety plug	SMD



Diagnostics / Borescope technology

1992 Thermal camera

Automatic hot, cold and central point measurement



- Image sensor: Vanadium oxide uncooled focal plane arrays (FPA)
- Refresh rate: 25 Hz
- Thermal sensitivity (Noise Equivalent Temperature Difference, NETD): < 40 mK (0.04° C)
- Measuring accuracy maximum ($\pm 2^\circ \text{C} \cdot \pm 2\%$): Ambient temperatures 15° C – 35° C / Object temperatures above 0° C
- Field of view: 37.2° x 50°
- Record videos
- Visual camera: 3264 × 2448 pixels (8MP)
- Screen size: 3.5 inch LCD touchscreen
- Display resolution is 640 x 480 pixels
- Thermal (or IR) resolution: 256 x 192 pixels
- Temperature measuring range: -20 °C to 400 °C (-4 °F to 752 °F)
- Battery life: up to 4 hours
- Image modes: Thermal · Optical · Fusion · PIP (picture in picture)
- Digital zoom: 1x to 4x
- Storage medium: EMMC 16 GB (included in delivery) · up to 60000 images or 10 hours of video material
- Additional features: LED light · microphone · buzzer
- Hand strap



HAZET No.	L x W x H mm	EAN-No. 4000896+
1992-2	139x85x24	249435

4812 HD probe Ø 4.9 mm, front and side camera

Improved accuracy of detail thanks to HD camera



- Compatible with basic unit 4812-11G and 4812-23G
- Semi-flexible probe enables guidance through cavities
- Front and side camera switchable (0° and 90°)
- Dimmable 5xLED light source for front camera
- Dimmable LED light source for side camera
- Digital interface to basic unit: USB-C
- Viewing angle (FOV): 90°
- Depth of focus (DOV): 10 – 100 mm
- Resolution: HD 1280(H)x720(V) pixels
- Compression format: H264
- Operating temperature: -10°C up to 60 °C
- Probe protection rating: IP67
- Weight: 137 g
- Image format: Jpeg
- Video format: MOV
- Protection rating probe: IP67 (when connected)
- Probe cable: 1 m
- Dimensions: 1121 mm x 18 mm (LxW)

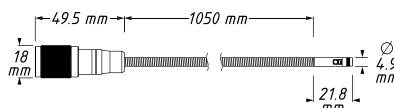
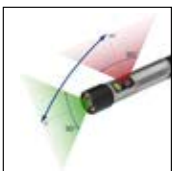

HAZET No.	EAN-No. 4000896+
4812-11 FS	249565

4812 HD video borescope set

Improved accuracy of detail thanks to HD camera

- Light boost and integrated reflection reduction
- Luminous source: 5 dimming LEDs for optimum lighting
- Optional recording in different time loops
- Zoom: 1.5x and 2 x
- Image format (jpg): 1920 x 1080 pixels
- Video format (MP4): 1920 x 1080 pixels
- Mirroring of the camera image
- Negative display of the camera image
- Data transfer: USB-C
- Video output: micro HDMI
- Operating temperature: 10° C up to 50 °C
- Operating humidity of up to 90 % (non-condensing)
- IP protection rating (basic unit): IP54
- USB interface can be used as a power source when no batteries are inserted
- Compatible with HAZET HD probes 4812-11FS and 4812-23AF
- Power source: 4xAA battery
- Weight: 370 grams without batteries
- Dimensions (LxWxH): 276x123x54 mm
- Compact design
- Easy to handle
- Eyelet on the battery compartment for mounting a hand strap (drop guard)
- Thread to hold a tripod screw connection (1/4")
- Reset button
- Auto Power Off function 3-way adjustable
- Record videos (MOV format) and photos (JPEG format)
- Image format: JPG, 1920 x 1080 pixels with optional timestamp
- Video format: MP4, 1920 x 1080 pixels with optional timestamp
- 29 different menu languages can be selected
- Use of the system as a card reader / camera via USB connection to PC PC software download
- **Compatible with HAZET HD probes 4812-11FS and 4812-23AF**
- Plastic box

5-piece set in plastic case:

- Basic unit 4812-11G
- HD probe 4812-11FS
- SD card with 32 GB storage capacity
- Micro HDMI cable (A to D) 1.8 m
- USB-C cable (A to C) 1 m
- USB-C cable (A to C) 1 m



HAZET No.	5	EAN-No. 4000896+
4812-11/5 FS	5	249572



4812 HD touchscreen video borescope set

- Improved accuracy of detail thanks to HD camera
- Touchscreen colour display with Li-Ion battery and magnetic holder
- 127 mm (5 inch) touch display, readable in sunlight
- Display resolution: 800x480 pixels
- 10-level brightness setting (5 + 5 boost)
- Zoom: 3 x
- Recording in 3 different time loops
- Image format (jpg): 1920x1080 pixels
- Video format (MP4): 1920x1080 pixels
- Negative display of the camera image
- Data transfer: USB-C
- HDMI port for video output
- Video output: micro HDMI
- Rechargeable battery: Li-ion battery
- Charging time 3.5 h
- Operating time when fully charged: 4 hours
- Operating temperature: 10°C up to 50 °C
- Operating humidity of up to 90 % (non-condensing)
- IP protection rating (basic unit): IP54
- Built-in microphone
- Compatible with HAZET HD probes 4812-23AF and 4812-11FS
- Weight: 705 g
- Dimensions: 162x128x46 mm
- Compact design
- Easy to handle
- Swivelling magnetic base: 180° adjustable
- Thread to hold a tripod screw connection (1/4") in the magnetic base
- Reset button
- Display of battery capacity
- Auto Power Off in 4 different times optional
- Record videos (MOV format) and photos (JPEG format)
- Image format: JPG, 1920x1080 pixels with optional watermark and timestamp
- Video format: MP4, 1920x1080 pixels with optional watermark, timestamp and audio
- Addition of own logos as watermark possible (160x160 pixels)
- Mirroring of the camera image
- Designation of photos on the touchscreen
- Creating folders on the touchscreen
- DC power adapter: 5 V / 3 A
- Charger: USB charging adapter DC-5 V / 3 A
- 28 menu languages can be selected
- Use of the system as a card reader / camera via USB connection to PC. PC software download
- L-Boxx 190 L-136



HAZET No.		EAN-No. 4000896+
4812-23/5 AF	5	249824

4812 HD swivelling probe 180°, Ø 3.9 mm, front camera

- Improved accuracy of detail thanks to HD camera
- Smaller probe diameter 3.9 mm
- Compatible with basic unit 4812-23G and 4812-11G
- Including control unit to operate articulation, video recording, brightness control
- Bending radius only approx. 35 mm (-30% compared to conventional designs)
- High mobility due to bilateral articulation
- Full swivel up to 180° on both sides enables e.g. a real reverse view onto valves in the cylinder head
- Front camera
- Dimmable 2xLED light source
- Digital interface to basic unit: USB-C
- Viewing angle (FOV): 90°
- Depth of focus (DOF): 10 – 100 mm
- Resolution: HD 1280(H)x720(V) pixels
- Compression format: H264
- Operating temperature: -10°C up to 60 °C
- Probe protection rating: IP67
- Weight: 307 g
- Improved accuracy of detail thanks to HD camera
- Diagnosis of cavities for damage assessment
- Image format: Jpeg
- Video format: MOV
- Protection rating probe: IP67 (when connected)
- Probe cable: 1 m
- Dimensions: 35.4 mm x 51.1 mm 2589 mm (WxHxL)

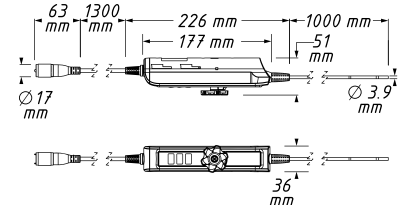

HAZET No.	EAN-No. 4000896+
4812-23 AF	249602

4812 Video borescope

- 4.9 mm Ø micro lens
- Switching function viewing direction 90° + 0°
- Instant replay of video or photos at TFT monitor
- Show and hide date and time easily
- Automatic switch-off to save energy
- Viewing angle: 56°
- Depth of focus: 10–60 mm
- Resolution: QVGA (320x240 pixels)
- Improved connection between probe and housing (metal) adapter for using older probes: 4812-20
- One-hand operation
- 2nd generation probe:**
 - Improved illumination with the 90° function
 - Improved illumination power of LED
 - Simplified application
 - Improved quality of the probe coating
 - Probe protection rating IP 67
- Included in delivery**
 - 1 m probe cable with 4.9 mm Ø micro lens and LED light sources
 - Operating panel
 - Hook including magnet
 - SD card: 4 GB storage capacity
 - 4 xAA batteries
 - Plastic box





4812 Video borescope

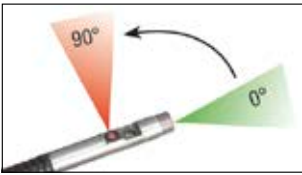

YouTube Clip



HAZET No.		EAN-No. 4000896+
4812-10/4S	4	181742

4812 Probe for video borescope

- For probes with improved connection (4812 N) to be used in conjunction with the operating panels of the sets 4812-10/4S · 4812-1/6 · 4812-1/8
- Viewing angle: 56°
- Depth of focus: 10–60 mm
- Resolution: QVGA (320x240 pixels)
- Probe length: 1000 mm
- Weight: 220 g



HAZET No.	l mm	Ø mm	EAN-No. 4000896+
• 3.9 mm Ø			
• Viewing direction of the camera: straight view (Front-View)			
• Luminous source: 3 dimmable LEDs			
• Temperature range: 0°C – 55°C			
4812N-1F	1000	3.9	187096
• 4.9 mm Ø			
• Visual angle switching function 90° + 0°			
• Dimmable LED			
• Metal connector			
• Probe protection rating IP 67			
• Temperature range: 0°C – 55°C			
4812-16	1000	4.9	181841

2151 Borescope

Made in Germany

- Diaphragm with efficient transmission rate



- Steel tip: 180 mm



YouTube Clip



HAZET No.	l mm	EAN-No. 4000896+
2151	1080	013043
• Ear tips for HAZET stethoscope 2151		
2151-02/2	–	062287

1991 Non-contact infrared thermometer

- For non-contact temperature measurements. Integrated laser pointer



- Wide range application, e.g. automotive sector (radiator/cooling systems, brakes, air conditioning, engines, exhaust systems), chemical and food controls, HVAC/R
- Rapid detection function
- Precise non-contact measurements
- Automatic data holding
- Display of max. temperature, trigger lock
- 9 V block battery (6LR61)
- Backlight LCD display
- Dual laser sighting
- D : S = 12 : 1
- Emissivity digitally adjustable from 0.1 to 1.0
- Set high and low alarms
- In artificial leather pouch with hook-and-loop fastener and belt loop
- Temperature range: -50°C – 550°C



HAZET No.	EAN-No. 4000896+
1991-1	156054

1977 Telescopic inspection mirror set

- Telescopic rod, double hinge joint with tension spring
- Replaceable mirror (clear mirror glass) with 4 mm stainless steel threaded bar
- Mirror won't tarnish as polished "metal mirrors" do
- Mirror glass encased in rugged stainless steel

4-piece set · contents:
Telescopic rod, extension length: 300–740 mm
Round mirror: 30 mm Ø
Round mirror: 50 mm Ø
Rectangular mirror: 65x43 mm



HAZET No.	l ₁ mm	l ₂ mm	EAN-No. 4000896+
1977-2/4	300	740	150144

1975 Pick-up tool with claws

- Flexible
- Surface: chrome-plated



HAZET No.	l mm	EAN-No. 4000896+
1975	540	009725

1976 Magnetic pick-up tool

Made in Germany

- Magnetic bit retention
- Flexible shank
- Plastic handle



HAZET No.	l mm	Ø mm	h P	EAN-No. 4000896+
1976	545	15	4500	009732
1976-1	545	19	7500	009749
1976-2	475	8	1100	009763



Lights

1979 LED penlight

• **Highly efficient reflector system: light yield of up to 130 lumen – range of light up to 75 metres**

- Improved design:
 - approx. 100% brighter
 - approx. 40% longer operating time
- Well-balanced housing proportions
- Surface with a good grip
- Operation of the on/off switch is possible and easy with gloves
- Aluminium housing (black anodised) protects inner parts from the entrance of dust and splash water (IP54)
- 3 watt LED
- Including sales display for a purchase of at least 12 pieces
- Number of batteries: 2 x 1.5 V Micro / AAA / (L)R03
- Power supply: Battery
- LED technology: SMD
- Luminous flux 100%: 130 lm
- Operating time 100%: 4 h
- Range of light: 75 m
- Type of protection (IP): IP54
- Protection rating (IK): IK07



AAA – 1.5 V AAA – 1.5 V	IP 54	130 Lumen 3 W	4 h
----------------------------	-------	-------------------------	-----

HAZET No.	l mm	EAN-No. 4000896+
1979 N-71	139	208470

1979 LED torch light · small design

• **Continuous one-hand focusing enables precise spotlight up to homogeneous floodlight**

- Improved design:
 - Focusability
 - Approx. 33% brighter
- Professional pen light in small design always provides optimal handling through well balanced housing proportions and a surface with good grip
- Stable design protects against dust and splash water (IP54)
- Shock-resistant up to a height of fall of 1 m
- 3 watt LED
- 2 levels of brightness: 30% and 100% (regulation by On / Off switch)
- Range of light at 30%: 100 m
- Operating time at 30% (Energy Saving Mode) up to 13 h
- Luminous flux at 30% (Energy Saving Mode) 80 lumens
- Including practical carrying loop
- Including sales display for a purchase of at least 8 pieces
- Number of batteries: 3 x 1.5 V Micro / AAA / (L)R03
- Power supply: Battery
- LED technology: SMD
- Luminous flux 100%: 200 lm
- Operating time 100%: 4.5 h
- Range of light: 175 m
- Type of protection (IP): IP54
- Protection rating (IK): IK07



1979 LED torch light · small design



100% 200 Lumen 30% 80 Lumen	100% 4.5 h 30% 13 h	IP 54
--	------------------------	-------

HAZET No.	l mm	EAN-No. 4000896+
1979 N-72	135	208487

1979 LED pen light

• **USB-C charging port**

- Small compact LED lamp with high lighting power
- Progressively dimmable – optimal light adjustment
- Simple and quick diagnosis by main light (surface illumination) or top light (punctual illumination) for dialogue reception among other applications
- Should be in any tool bag
- 2-component plastic housing with rubberised surface
- Battery status and state-of-charge display
- Switching on / off as well as switching between top and main light via main button
- Including 100 cm USB-C charging cable
- Battery capacity: 1050 mAh
- Extendable clip holder
- Battery level display
- Top light operating time: 4 h
- Top light luminous flux: 120 lm
- Highly integrated holding magnets on the rear of the housing
- Number of batteries: 1 x 3.7 V 1050 mAh lithium-ion rechargeable battery
- Power supply: USB cable (USB C)
- LED technology: COB/SMD
- Luminous flux 100%: 200 lm
- Operating time 100%: 2.5 h
- Charging time: 2 h
- Type of protection (IP): IP65
- Protection rating (IK): IK09

2.5 h	IP 65
100% 200 Lumen	USB-C

HAZET No.	l mm	EAN-No. 4000896+
1979-11	180	235254





1979 LED pocket light

- **180° adjustable and 8-step lockable base for adjustment of work area illumination**
- 2-component plastic housing with rubberised surface
- Progressively dimmable – optimal light adjustment
- 4-stage battery status and state-of-charge display
- Switching on / off as well as switching between top and main light via main button
- Strong rubberised holding magnet on the underside
- 360° movable retaining hook
- Impact resistance (EN62262): IK09
- **Main light:**
operating time: 2 – 10 h
luminous flux 30 – 300 Lumen
3 Watt COB LED
- **Top light:**
operating time 5 h
Luminous flux: 100 Lumen
- Including 100 cm USB-C charging cable (without USB adapter)
- Possible to charge the battery via a standard USB adapter 5 V maximum 1 A
- Number of batteries: 1 x 3.7 V 1200 mAh
Lithium-ion rechargeable battery
- Power supply: USB cable (USB C)
- LED technology: COB/SMD
- Luminous flux 100%: 300 lm
- Operating time 100%: 2 h
- Charging time: 1.5 h
- Type of protection (IP): IP65
- Protection rating (IK): IK09



YouTube Clip

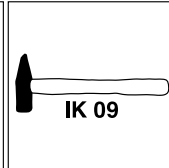
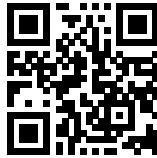

HAZET No.	l mm	EAN-No. 4000896+
1979 N-82	133	227211

1979 LED slim light

- Charging / power supply via USB C port 5 V, maximum 1 A
- Including 100 cm USB-C charging cable (without USB adapter)
- 2-component plastic housing with rubberised surface
- 4-stage battery status and state-of-charge display
- 120° adjustable and 5-step lockable aluminium head for adjustment of work area illumination
- Battery capacity: 4500 mAh (+30% compared to previous model)
- Main light operating time: approx. 3–14 h
- Top light operating time: 11 h
- Main light luminous flux: 110–1100 lm (+10% compared to previous model)
- Top light luminous flux: 150 lm
- Full-surface, homogenous illumination
- Dimmer switch on the rear side of the lamp – optimal light adjustment
- Switching between top and main light via main button
- Strong rubberised holding magnet on the underside
- Fold-out and 360° rotatable hanging hook
- Solid base for good stability even on non-metallic substrates
- Number of batteries: 1 x 3.6 V 4500 mAh
lithium-ion rechargeable battery
- Power supply: USB cable (USB C)
- LED technology: COB/SMD
- Luminous flux 100%: 1100 lm
- Operating time 100%: 3 h
- Charging time: 4.5 h
- Type of protection (IP): IP65
- Protection rating (IK): IK08

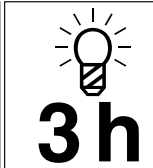
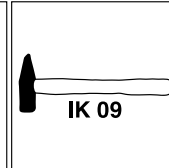

HAZET No.	l mm	EAN-No. 4000896+
1979 N-92	367	241415

1979 LED light

- Including 100 cm USB-C charging cable (without USB adapter)
- Battery charging option via a standard 5 V USB adapter
- Battery status and state-of-charge display
- Main light operating time: approx. 3–20 h
- Top light operating time: 4.5 h
- Main light luminous flux: 60–600 lm
- Top light luminous flux: 300 lm
- Dimmer switch at the rear for optimum light adjustment. Switching between top and main light
- Strong rubberised holding magnet on the underside
- Fold-out and 360° rotatable hanging hook
- 180° adjustable and 5-stage lockable foot
- Number of batteries: 1 x 3.7 V 2600 mAh
Lithium-ion rechargeable battery
- Power supply: USB cable (USB C)
- LED technology: COB/SMD
- Luminous flux 100%: 600 lm
- Operating time 100%: 3 h
- Charging time: 3 h
- Type of protection (IP): IP65
- Protection rating (IK): IK09

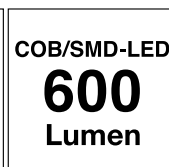
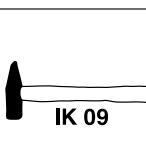

HAZET No.	l mm	EAN-No. 4000896+
1979 N-85	255	241491

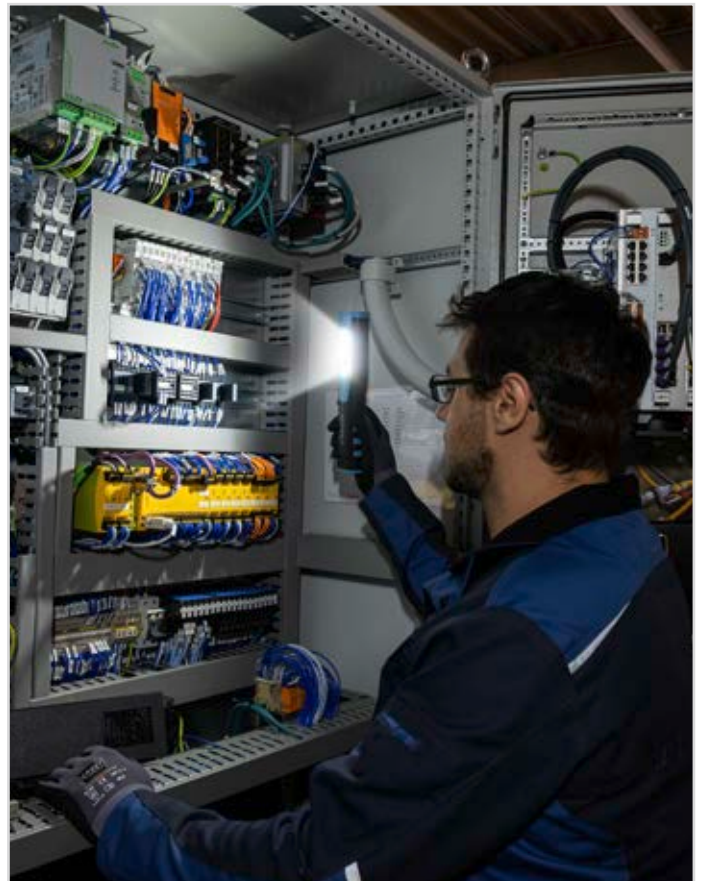



Lights

1979 LED pen light · wireless charging

- **Wireless charging**
- **Efficient and comfortable charging function due to optimised self-positioning of the lamp on the pad**
- Small compact LED lamp with high lighting power
- Progressively dimmable – optimal light adjustment
- Simple and quick diagnosis by main light (surface illumination) or top light (punctual illumination) for dialogue reception among other applications
- Should be in any tool bag
- Charging starts immediately after the light is fitted
- 2-component plastic housing with rubberised surface
- Battery status and state-of-charge display
- Switching on / off as well as switching between top and main light via main button
- Wireless charging pad 1979WP-1 or 1979WP-2 is needed
- Battery capacity: 1050 mAh
- Extendable clip holder
- Battery level display
- Top light operating time: 4 h
- Top light luminous flux: 120 lm
- Highly integrated holding magnets on rear of the housing
- Number of batteries: 1 x 3.7 V 1050 mAh lithium-ion rechargeable battery
- Power supply: Wireless charging
- LED technology: COB/SMD
- Luminous flux 100%: 200 lm
- Operating time 100%: 2.5 h
- Charging time: 2.5 h
- Type of protection (IP): IP65
- Protection rating (IK): IK09



2.5 h	IP 65
IK 09	COB-LED 200 Lumen

HAZET No.	l / mm	EAN-No. 4000896+
1979W-11	180	235230

1979 LED pocket light · wireless charging

- **Wireless charging**
- **Efficient and comfortable charging function due to optimised self-positioning of the lamp on the pad**
- Charging starts immediately after the light is fitted
- 2-component plastic housing with rubberised surface
- 4-stage battery status and state-of-charge display
- Switching on / off as well as switching between top and main light via main button
- Number of batteries: 1 x 3.7 V 1200 mAh Lithium-ion rechargeable battery
- Power supply: Wireless charging
- LED technology: COB/SMD
- Luminous flux 100%: 300 lm
- Operating time 100%: 2 h
- Charging time: 1.5 h
- Type of protection (IP): IP65
- Protection rating (IK): IK09
- 180° adjustable and 8-step lockable base for adjustment of work area illumination
- Progressively dimmable – optimal light adjustment
- Strong rubberised holding magnets on the underside and rear side of the housing
- 360° movable retaining hook
- **Main light:**
Operating time 2–10 h
Luminous flux 30 – 300 Lumen
3 watt COB LED
- **Top light:**
Operating time top light: 5 h
Luminous flux: 100 Lumen
1 watt LED



1979 LED pocket light · wireless charging

YouTube Clip

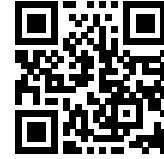

2 h	IP 65	IK 09	IK 09	100% 300 Lumen

HAZET No.	l / mm	EAN-No. 4000896+
1979W-82	133	227228

1979 LED pen light set · wireless charging

- **Wireless charging**
- **Efficient and comfortable charging function due to optimised self-positioning of the lamp on the pad**
- Small, compact LED lamp with high lighting power
- Progressively dimmable – optimal light adjustment
- Simple and quick diagnosis by main light (surface illumination) or top light (punctual illumination) for dialogue reception among other applications
- Should be in any tool bag
- Charging starts immediately after the light is fitted
- 2-component plastic housing with rubberised surface
- Battery status and state-of-charge display
- Switching on / off as well as switching between top and main light via main button
- Pen light for daily use in diverse application fields
- LED pen light set, 3 pieces
- Contents:
 - 2x 1979W-11 LED pen light · wireless
 - 1x 1979WP-2 dual wireless charging pad
 - 1x 100 cm USB-C cable
 - 1x 5 V, 2 A power supply unit
- Power supply: Wireless charging
- LED technology: COB/SMD
- Luminous flux 100%: 200 lm
- Type of protection (IP): IP65
- Protection rating (IK): IK09



IP 65	IK 09	IK 09	2.5 h

HAZET No.	Quantity	EAN-No. 4000896+
1979W-11/3	3	235247



1979 LED inspection light set · wireless charging

- **Wireless charging**
- **Efficient and comfortable charging function due to optimised self-positioning of the lamp on the pad**
- Small, compact LED lamp with high lighting power
- Progressively dimmable – optimal light adjustment
- Simple and quick diagnosis by main light (surface illumination) or top light (punctual illumination) for dialogue reception among other applications
- Should be in any tool bag
- Charging starts immediately after the light is fitted
- 2-component plastic housing with rubberised surface
- Battery status and state-of-charge display
- Switching on / off as well as switching between top and main light via main button
- LED light set, 3 pieces
- Contents:
 - 1x 1979W-11 LED pen light · wireless
 - 1x 1979W-82 LED pocket light · wireless charging
 - 1x 1979WP-2 dual wireless charging pad
 - 1x 100 cm USB-C cable
 - 1x 2A 5V charger / power supply unit
- Power supply: Wireless charging
- LED technology: COB/SMD
- Type of protection (IP): IP65
- Protection rating (IK): IK09

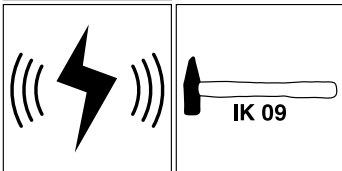

HAZET No.	mm	EAN-No. 4000896+
1979 NW/3	3	235261

1979 LED light

- **Wireless charging**
- **Efficient and comfortable charging function due to optimised self-positioning of the lamp on the pad**
- Charging starts immediately after the light is fitted
- Wireless charging pad 1979WP-1 or 1979WP-2 is needed
- Battery status and state-of-charge display
- Main light operating time: approx. 3–20 h
- Top light operating time: 4.5 h
- Main light luminous flux: 60–600 lm
- Top light luminous flux: 300 lm
- Dimmer switch for optimal light adjustment. Switching between top and main light
- Dimmer switch on the rear side of the lamp – optimal light adjustment
- Strong rubberised holding magnet on the underside
- Fold-out and 360° rotatable hanging hook
- 180° adjustable and 5-stage lockable foot
- Number of batteries: 1 x 3.7 V 2600 mAh Lithium-ion rechargeable battery
- Power supply: Wireless charging
- LED technology: COB/SMD
- Luminous flux 100%: 600 lm
- Operating time 100%: 3 h
- Charging time: 3.5 h
- Type of protection (IP): IP65
- Protection rating (IK): IK09



1979 LED light

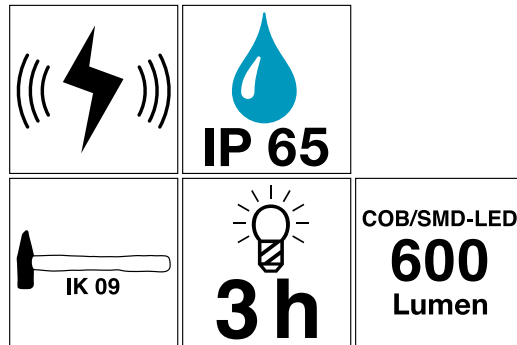

HAZET No.	mm	EAN-No. 4000896+
1979 W-85	255	241484

1979 LED slim light · wireless charging

- **Wireless charging**
- **Efficient and comfortable charging function due to optimised self-positioning of the lamp on the pad**
- Charging starts immediately after the light is fitted
- Wireless charging pad 1979WP-1 or 1979WP-2 is needed
- 2-component plastic housing with rubberised surface
- 4-stage battery status and state-of-charge display
- 120° adjustable and 5-step lockable aluminium head for adjustment of work area illumination
- Battery capacity: 4500 mAh (+30% compared to previous model)
- Main light operating time: approx. 3–14 h
- Top light operating time: 11 h
- Main light luminous flux: 110–1100 lm (+10% compared to previous model)
- Top light luminous flux: 150 lm
- Full-surface, homogenous illumination
- Dimmer switch on the rear side of the lamp – optimal light adjustment
- Switching between top and main light via main button
- Strong rubberised holding magnet on the underside
- Fold-out and 360° rotatable hanging hook
- Solid base for good stability even on non-metallic substrates
- Number of batteries: 1 x 3.6 V 4500 mAh lithium-ion rechargeable battery
- Power supply: Wireless charging
- LED technology: COB/SMD
- Luminous flux 100%: 1100 lm
- Operating time 100%: 3 h
- Charging time: 5.5 h
- Type of protection (IP): IP65
- Protection rating (IK): IK08

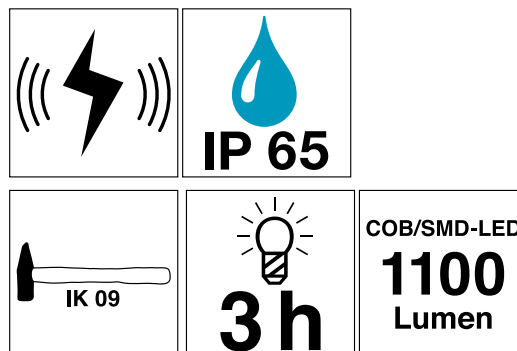

HAZET No.	mm	EAN-No. 4000896+
1979 W-92	367	241422





1979 LED light set · wireless charging

- **Wireless charging**
- **Efficient and comfortable charging function due to optimised self-positioning of the lamp on the pad**
- LED light set, 3 pieces
- 1x 1979W-82 LED pocket light
- 1x 1979W-92 LED slim light
- 1x 1979WP-2 charging pad for 2 lamps
- 1x USB-C cable, 100 cm
- 1x 5 V, 2 A power supply unit
- Power supply: Wireless charging
- LED technology: COB/SMD
- Type of protection (IP): IP65



HAZET No.		EAN-No. 4000896+
1979W 1/3	3	241408

1979 Wireless charging pad

- **Additional USB port for charging more devices**
- Holding magnets on the rear of the pad for fastening to substrates containing iron
- 4 screw holes
- Including 100 cm USB-C cable and USB adapter
- 5 V USB-C input
- It is possible to charge the battery via pad or USB port
- Power supply: USB cable (USB C)

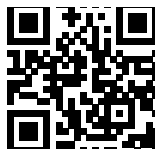
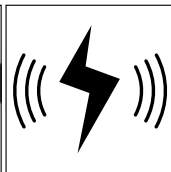

YouTube Clip

HAZET No.	EAN-No. 4000896+
<ul style="list-style-type: none"> • Maximum wireless output current: 850 mA • Optimised self-positioning of a light on the pad • 1 A charging current 1979 WP-1	227952
<ul style="list-style-type: none"> • Maximum wireless output current: 1700 mA • Optimised self-positioning of two lights on the pad • 2 A charging current 1979 WP-2	227945

1979 LED work spotlight

- **60 watt energy-efficient SMD LED technology for uniform room lighting**
- Rotatable dimmer switch for infinite adjustment
- Increased functionality by an additional 230V socket on the rear which enables coupling and operation of any additional devices
- 50 % of the power is immediately available when switching on
- Robust PU housing with surrounding aluminium components for better heat dissipation
- Visual power indication: 4-stage
- Base: 90° adjustable
- Cable length: 5 m
- Impact resistance (EN62262): IK07
- Extendable by:
 - 1979F-01 diffuser
 - 1979F-02 holding magnet
 - 1979F-03 telescopic tripod
- Power supply: 230 V power cable
- LED technology: SMD
- Luminous flux 100%: 6100 lm
- Type of protection (IP): IP54
- Protection rating (IK): IK07
- Luminous flux: 610 – 6100 lumens
- Colour temperature: 6000K (daylight white)
- 2 extension sockets on the rear

YouTube Clip

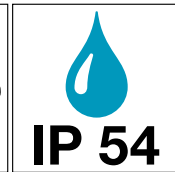
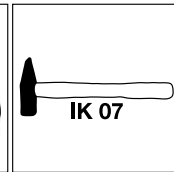
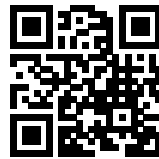

HAZET No.	l mm	EAN-No. 4000896+
1979 FC-60	304	227822





Workshop creepers/seats · Floor mats

195 Kneeling mat

Made in Germany

• In the shape of the HAZET logo

- Now even more comfort due to new foam quality
- Easy-to-clean surface
- Carrying/suspension handle
- Made of non-absorbing foam with closed cell structure



HAZET No.	L x W x H mm	EAN-No. 4000896+
195-1	450x210x30	121069

195 Mechanic's mat

Made in Germany

• In the shape of the HAZET logo

- Now even more comfort due to new foam quality
- Easy-to-clean surface
- Big mat for motor mechanics
- Made of non-absorbing foam with closed cell structure
- Carrying handle



HAZET No.	L x W x H mm	EAN-No. 4000896+
195-5	975x385x30	153718

195 Mechanic's creeper

• For convenient working underneath a vehicle

- 6 castors (70 mm Ø)
- Especially deep for maximum freedom of movement under the vehicle
- Rigid one-piece construction made of high strength plastic, black
- Ergonomically shaped: cut out arm areas for optimal elbow-room
- Very comfortable: soft upholstered head rest, HAZET blue
- Practical storage compartments for tools and small parts on the right and the left
- High capacity **up to 150 kg**
- Smooth-running swivel castors with rubber running surface, oil resistant and low-noise
- Practical carrying handle in the foot area
- Easy to clean
- Dimensions: H 115xW 1030xD 480 mm



HAZET No.	L x W x H mm	EAN-No. 4000896+
195N-2	1030x480x115	252169

195 Pneumatic chair

• Provides a comfortable seat at the work area

- 5 castors (approx. 76 mm Ø)
- Movable work chair with pneumatic seat height adjustment
- Cushioned seat base: 320 mm Ø, HAZET blue
- Easy to clean
- Loading capacity: up to 150 kg
- Adjustable in height from 396 to 526 mm
- 2 tool compartments, 1 rotating through 360°
- Tilt-resistant



HAZET No.	EAN-No. 4000896+
195-4	148707





Lubrication technology

197 Magnetic cup

• **Practical helper for the workshop**

- ABS plastic (HAZET blue)
- 80 mm rubberised magnet (approx. 2.5 kg retention force) for fixation to tool trolleys, panels, cabinets, car lifts etc.
- Magnetic on both sides – especially suitable for ferrous parts
- Housing opening enables good visibility and easy removal of parts
- Optimised, bevelled housing shape – also suitable for non-magnetic parts



HAZET No.	∅ mm	EAN-No. 4000896+
197-3	150	158584

197 Multifunctional drain pan

• **For oil change / oil filter replacement and for cleaning of parts**

- Safe and clean outpour due to circumferential overflow gutter
- Made of polyethylene (break-proof)
- Internal scale: Litre, US gal / UK gal
Scale graduation: 1 l / 1 gal
- 3 handles
- With pouring spout
- With protuberance including filter security (anti-slip) to deposit small parts
- With drainer for oil filter
- Stackable trays
- Dimensions LxWxH: 400x390x120 mm
- Manufactured in the EU



HAZET No.	l	EAN-No. 4000896+
197 N-1	6	198924

• **For oil change / oil filter replacement and for cleaning of parts**

- Safe and clean outpour due to circumferential overflow gutter
- Made of polyethylene (break-proof)
- Tap for pouring out liquids safely and cleanly
- Three carrying handles for safe carrying and outpouring



HAZET No.	l	EAN-No. 4000896+
197-2	16	146802

197 Multifunctional drain pan

• **Made in Germany**

- **Universal application**
- **Large capacity**

Application: can be used as a cleaning pan, dirt pan, oil pan, storage pan, disinfection pan, leakage pan, transport pan, feed pan, in sanitary and heating construction, the motor vehicle industry and workshops, for hunting equipment, chemical/laboratory use, food industry/ butcheries, fishing, pet supplies, horse accessories, etc.

- Alkaline-resistant and acid-resistant
- Internal dimensions (WxDxH): 800x520x100 mm
- From TÜV-certified production in accordance with DIN ISO 16901



HAZET No.	l	EAN-No. 4000896+
197-50	50	210008

197 Multifunctional drain pan

• **Chemical-resistant, unbreakable plastic with smooth, abrasion-proof surface**



HAZET No.	l	EAN-No. 4000896+
197-4	3	214235

198-1 Funnel · with flexible hose

• **Filling with all standard workshop liquids such as oil, fuel or brake fluid**

- Funnel made of polypropylene, flexible spout made of polyethylene, with stainless steel filter
- Funnel diameter: 165 mm
- Length including hose: 480 mm



HAZET No.	l	EAN-No. 4000896+
198-1	1.2	149155



199 Spray bottle · refillable

• Use with multi-purpose spray, such as e.g. penetrating oil, rust remover, as well as rim and brake cleaner



- Savings due to the use of large containers
- Safety valve
- Viton® gaskets
- Including 155 mm long jet nozzle and short spray nozzle
- Fog spray and point jet
- Two-piece design enables easy cleaning
- Easy filling through the bottleneck (∅ 25 mm) or in the lower part (∅ 54 mm)
- The valve located in the floor serves exclusively for filling with compressed air
- Max. working pressure [bar]: 8 bar

YouTube Clip

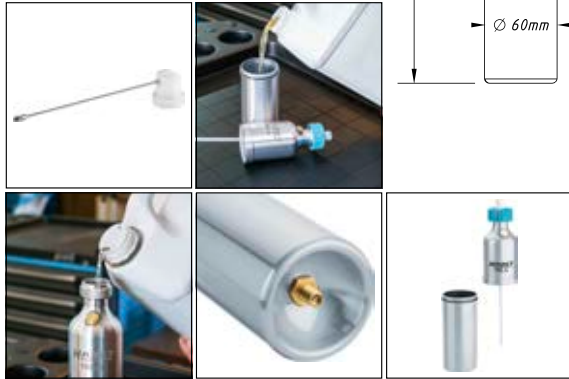
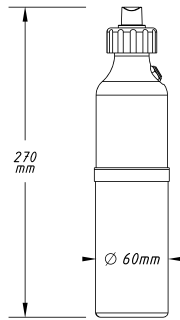

HAZET No.	l	EAN-No. 4000896+
199-4	0.227	198429

198 Measuring cup

• Brake fluid, battery fluid and non-acidic liquids

- Material: HDPE
- Colour: white/ transparent



HAZET No.	l	EAN-No. 4000896+
198-4	1	174485
198-5	2	174478
• With pouring spout		
198-6	5	174522
198-8	5	174508

2160 Oiler



HAZET No.	l	l	EAN-No. 4000896+
2160	245	0.2	013289

2160-1 Brush oiler

- Industrial oiler with single pump
- Replaceable brush, 20 mm diameter M6 x 0.75 mm
- Brass lance
- Suspension lug
- Semi-transparent container (PEHD) for better visibility of the filling level
- 20 bar pumping unit – delivery even of heavier oils with higher viscosity on chains and slide rails



HAZET No.	l	EAN-No. 4000896+
2160-1	0.3	234646

2162 Grease gun

- Capacity: 500 cm³
- Reinforced hose, nozzle pipe and 2 mouthpieces M10 x 1
- Filling with grease cartridge, loose grease or via a grease filler
- Rolled thread
- Pre-greased boot
- Long operating lever for low effort and minimisation of the crushing risk
- Short stroke system does not require the lever to fully open
- Actuation with ring-shaped push rod handle



HAZET No.	EAN-No. 4000896+
2162-1	075027



2162 High performance suction gun

- Unneeded material can be easily sucked out
- Flexible plastic hose outlet
- Housing material: galvanised steel



2162-6

HAZET No.	l	EAN-No. 4000896+
• Filling capacity: 500 ml • Inside diameter of the hose: 9.5 mm • Outside diameter of the hose: 12.5 mm • NBR seals • For engine oils with a viscosity of 30 to 68 • Not suitable for acidic (erosive) liquids		
2162-4	0.5	174850
• Metal outlet also included • Filling capacity: 1000 ml • Inside diameter of the hose: 9.5 mm • Outside diameter of the hose: 12.5 mm • NBR seals • For engine oils with a viscosity of 30 to 68 • Not suitable for acidic (erosive) liquids • Coupler thread (hose/pipe) on the pump bottom: 12.7 mm (1/2") PT x 19		
2162-6	1	174454

2162 Manual decanting / filling pump

Made in Germany

• 600 ml pump volume enables fast transfer pumping and filling of fluids between different tanks

- Application: Filling and decanting liquids
- Base plate and double connection for hoses with 10/15 mm inside Ø
- 1 suction hose, Ø 10 mm · length: 3 m
- 1 pressure hose, Ø 15 mm · length: 3 m
- On e.g. **MERCEDES-BENZ** Citaro Euro 6 together with coolant pipe 2xA.311.500.09.91 and coupling muff A.001.553.19.26 and coupler plug A.001.553.20.26
- Transmission or engine oils can be filled quickly, bubble-free and cleanly using the pump
- Fluids to be transferred, e.g.
 - Ad Blue
 - Coolant
 - Windscreen frost protection
 - Oil
 - Water



HAZET No.	EAN-No. 4000896+
2162-7	207756

2162 Hand-operated dosing pump

• **Double scaling for precise metering**

- Suitable for:
 - Biological oil · Drilling oil · Diesel oil · Antifreeze · Heating oil · Hydraulic oil · Coolant · Cooling lubricant · Multifunctional oil · Petroleum · Cutting oil · Synthetic oil · Contaminated waste oil · Water · Water emulsion
 - Not suitable for explosive liquids such as petrol
- Coupler thread (hose/pipe) on the pump bottom: M15 x 1.5
- Housing material: PVC (transparent)
- Hose inside Ø: 10 mm
- Hose outside Ø: 16 mm
- NBR seals
- Unneeded material can be easily sucked out
- Incl. flexible, transparent plastic hose fibre-reinforced
- Including curved 120° aluminium application tube Ø 10 mm
- Absorbent and smooth
- Hose length: 600 mm plus application tube
- Maximum transport volume 4 l/min
- Length without house: 545 mm



HAZET No.	l	EAN-No. 4000896+
2162-8	1	213337

2163 Hand pump · with telescopic suction tub

Made in Germany

- For drums from 50 to 200 l
- Telescopic suction tube made of metal, extendable from 450 to 860 mm
- Base component made of galvanised steel
- R 2" and R 1.1/2" drum adapters
- Removable curved metal outlet
- Flow rate: approx. 0.35 litres / stroke or 16 l/min.
- Weight: 2.2 kg

Caution: Not suitable for gasoline extraction



HAZET No.	EAN-No. 4000896+
2163-1	172771





2162 Mini grease gun

- Filling capacity: 80 g
- Creates pressure up to 1000 PSI / 69 bar
- Filling with loose grease
- Including lubricating nipple in 50° and 90° versions



HAZET No.	l mm	EAN-No. 4000896+
2162 M	145	185634
9300 N-60	–	203406

- Rapid and clean filling of the HAZET 2162M mini grease gun
- Improved mechanical stability prevents loss of lubrication performance in vibrating environment
- Good water washout resistance
- High oxidative stability
- High corrosion protection and excellent adhesion on metallic surfaces
- Grease cushion 60 ml

199 Pressure sprayer

- **Capped pumping mechanism increases chemical resistance**

- Universal application in industrial and automotive sectors
- **Cleaning and degreasing of workpieces, workshops and vehicles**, such as machinery, engines, trays, rims etc.
- **Applying oils and separating agents** on machinery, workpieces, track switches and components, for mould making, for formworks etc.
- **Disinfecting and cleaning** floors, facades, sanitary facilities, pools etc.
- Integrated safety valve (2.5 bar) enables the container to depressurize before opening
- With Viton® gaskets
- Seals and materials resistant to most acids and solvents as well as to chemicals that are used most frequently in industry, automotive technology and professional cleaning
- Adjustable conical nozzle and flexible, break-proof pumping lever
- Flow rate: 0.5 l/min. at 2.5 bar using the white, adjustable conical nozzle
- 0.8 l/min. at 2.5 bar with the grey flat spray nozzle
- Net volume: 1 l
- Gross volume: 1.35 l
- Max. working pressure [bar]: 2.5 bar



YouTube Clip

199 Pressure sprayer



HAZET No.	l	kg	EAN-No. 4000896+
199 N-1	1	0.46	189007

199 Pressure sprayer · foam

- **Three nozzles (in scope of delivery) for generating wet and dry foams as well as for implementing different reaction times**

- Application: Creating tight and permanent foam
- Cleaning/disinfecting of surfaces, workpieces, vehicles, sanitary facilities
- **Better visual control of the sprayed area**
- For neutral cleaners as well as diluted acid and alkaline cleaners
- For
 - Cleaning and disinfecting work on upholstery and rugs
 - Disinfection of bathrooms and sanitary facilities
 - Kitchens and food industry
 - Cleaning vehicles, work surfaces etc.
- Transparent, durable tank with level indicator
- Integrated safety valve (2.5 bar) enables the container to depressurize before opening
- With Viton® gaskets
- Net volume: 0.75 l
- Gross volume: 1.5 l
- For use of chemicals with surface-active properties (surfactants)
- Increasing the duration of contact between chemical and surface to be cleaned guarantees increased effectiveness of the chemical product
- Seals and materials resistant to most acids and solvents as well as to chemicals that are used most frequently in industry, automotive technology and professional cleaning
- Wide filling neck
- Protection cover for chamber valve
- Including 3 different nozzles (black = normal, green = dry, orange = wet) for adjusting the foam quality
- Special flat nozzle suitable for foam
- Special flat spray nozzle for wide fan beam
- Including 10 spare filter
- Flexible, break-proof pumping lever

Application fields:

- **Cleaning textiles, upholstery and carpets** while at the same time avoiding excessive moistening to reduce the drying time and prevent fungi and bacteria from developing
- Max. working pressure [bar]: 3 bar



YouTube Clip

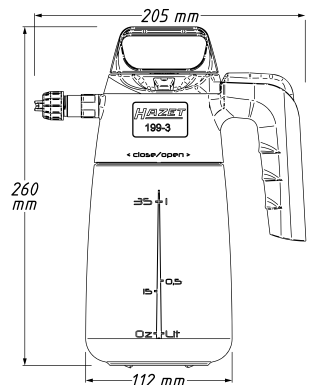

HAZET No.	l	EAN-No. 4000896+
199-3	0.75	207237



General workshop tools

197 Construction bucket

Made in Germany

- Application: Transport mortar · sand · water or tools on the construction site as well as in the garden for e.g. soil · mulch · fertiliser or plants
- Sturdy design: Particularly suited for transporting heavy materials thanks to the integrated cross base
- With litre measuring scale (inside): 2 to 20 l
- Made from recycled materials
- Certified by TÜV and German environmental certification „Blauer Engel“
- Diameter: inside 335 mm, edge 365 mm



HAZET No.	l	EAN-No. 4000896+
197-6	20	246304

197 Plaster cup set

• **Soft plaster cup made from rubber – easy breaking out of hard plaster residues**

- Application: Mixing of plaster
- Diameter: 125 mm
- Height: 95 mm
- Conical curved shape
- Contents: 5x plaster cups



HAZET No.	EAN-No. 4000896+
197-73/5	247851

1988 Clamping strap / Lashing strap

Made in Germany

- Application: Safe transport of luggage and goods
- Safe transport of the load is also indispensable for private individuals and small enterprises
- Length: 6 m
- As per EN 12195-2
- Lashing capacity / strapping: LC (strap webbing elongation in %) 1000 daN in the strapping
- Tensile force / ratchet: STF (tensile force) 200 daN
- Strap colour: light blue including printed HAZET logo, black



HAZET No.	EAN-No. 4000896+
1988-6	219193

2175 N Machinist's vice



HAZET No.	b mm	sf mm	sb max. mm	EAN-No. 4000896+
<ul style="list-style-type: none"> • Machinist's vice • Drop forged • Gripping jaw width: 100 mm • Installation on <i>Assistant</i> 177W · 179W · 179NW work benches together with 179NW-11 machinist's vice fastening set • Assembly on <i>Assistant</i> 177 tool trolleys together with 2175N-11 wooden liner • For assembly on <i>Assistant</i> 179N · 179NX · 179NT · 179NXL · 179NXXL model year 01/07/2019 tool trolleys → together with 179N-75 vice fastening 				
2175 N	100	50	125	013685
<ul style="list-style-type: none"> • Vice fastening for machinist's vice 2175N • For <i>Assistant</i> 179N · 179NX · 179NXL · 179NXXL model year 1/7/2019 tool trolleys • Easy installation on the worktop of the right side of the trolley • Includes fixing materials (screws and discs) for vice 2175N • Easy installation of the door 179N-21, the laptop holder 179W-42 and the basic fixture 179W-40 when the vice is installed 				
179 N-75	-	-	-	241835
<ul style="list-style-type: none"> • Vice fastening for machinist's vice 2175N • For tool trolley <i>Assistant</i> 179NXXLD • Easy installation on the worktop of the right side of the trolley • Includes fixing materials (screws and discs) for vice 2175N 				
179 N D-75	-	-	-	252343
<ul style="list-style-type: none"> • Distance plate (wooden) for machinist's vice 2175N • Installation of the vice on work benches or tool trolleys <i>Assistant</i> 172HD · 177 · 180 · 180K-4 • Including installation accessories 				
2175 N-11	-	-	-	013692

4617 Control cabinet key

Made in Germany

• **Practical pocket-sized helper**

- Inside square: s 5 · 7 · 8 mm
- Inside triangle: s 9 · 10 mm
- Inside hexagon: 6.3 mm (1/4")
- Inside hexagon (e.g. grub screw): 3 mm
- Stepped key (square): 6 up to 10 mm
- Including chain, adapter and reversible bit:
 - 1 x 7 mm / PH 2



HAZET No.	EAN-No. 4000896+
4617-1	246366



Safety at work

1987-5 Mechanic's gloves

- Extremely abrasion resistant due to perfect mix of synthetic leather (palms) and PVC, protectors on the outside surface
- Excellent elasticity and optimal fit, special Bignet® stretch fabric provides perfect grip and freedom of movement
- Breathable
- Non-skidding
- Washable
- Material: 48% polyamide/nylon, 25% polyacrylic, 25% polyester, 2% polyurethane



HAZET No.	EAN-No. 4000896+
• Size L 1987-5L	181735
• Size XL 1987-5XL	181759

1987 Mechanic's gloves

- Protection thanks to TPR protectors and fine knitted fabric
- The palm: maximum abrasion resistance thanks to high-quality nitrile rubber coating
- Easy grip
- Very good freedom of movement and fit
- Long wear life due to selected material components
- Easy to clean
- Size: L
- Tested against increased mechanical risks according to standard EN 388:2016
Additional cut protection test according to standard EN ISO 13997 with power levels 4131A



HAZET No.	EAN-No. 4000896+
1987-6	222643

1987 Working gloves · genuine leather

- Pleasant, lightweight feel and excellent dexterity due to high-quality kid leather
- High-quality mix of materials from supple genuine leather and modern microfibre textiles
- Exact-fit due to Velcro® strip cuffs (hook and loop fastener)
- Lightweight and breathable
- Tested against increased mechanical risks according to standard EN 388:2016
Additional cut protection test according to standard EN ISO 13997 with power levels 2111A
- Size: L



HAZET No.	EAN-No. 4000896+
1987 N-3	222650

1987 Gloves

- Microfoam coating
- Breathable coating
- Maximum flexibility and freedom of movement together with excellent mechanic protection
- Water repellent
- Material: 60% cotton, 40% polyester



HAZET No.	EAN-No. 4000896+
1987 N-4	203840







Specialty tools

	Engine	Engine timing / Timing belt Spark and glow plug Cylinder head Valves / Pistons Fuel system / Fuel injection Cooling system / Hose connection Diagnostics Exhaust system / Lambda probe	411-412 412-416 417 418-419 419-423 423-427 428-432 432-433	
	Gearbox	Clutch	434	
	Oil service		435-439	
	Brakes		440-447	
	Chassis	Spring vices / Shock absorbers Wheel bearing / Wheel hub Silent block Cardan shafts Wheels / Tyres	448-458 458-462 462-463 463-466 467-468	
	Electricity / Battery service	Electrical testing Battery service Contacts / Plug connections / Cable release tool Alternator / Radio removal	469 470 471-472 473	
	Body and interior equipment	Car body repair Car glass / Wiper arm Steering wheel	474-482 482-483 483	
	Commercial vehicles	Engine Oil service Brakes Chassis Electricity / Battery service Body and interior equipment	483-487 487-488 488-490 491-498 498-499 499	



HAZET specialty tools – The specialist for specialists

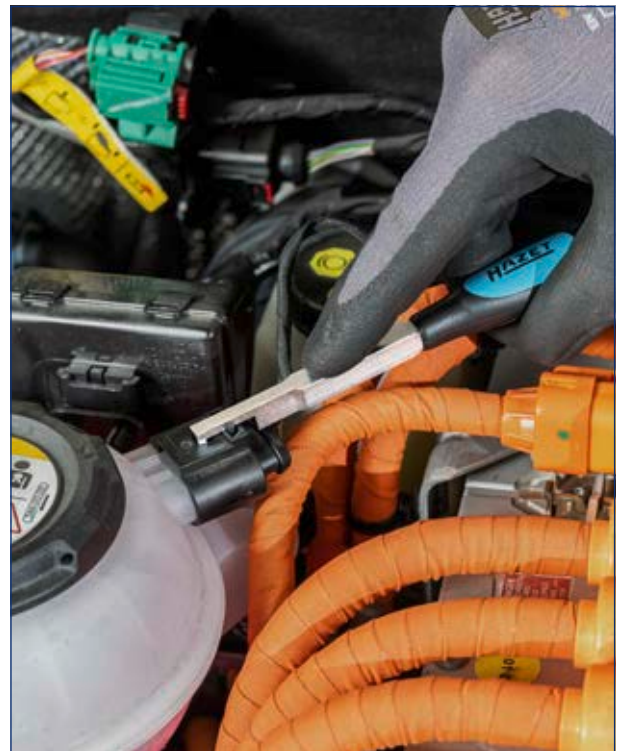
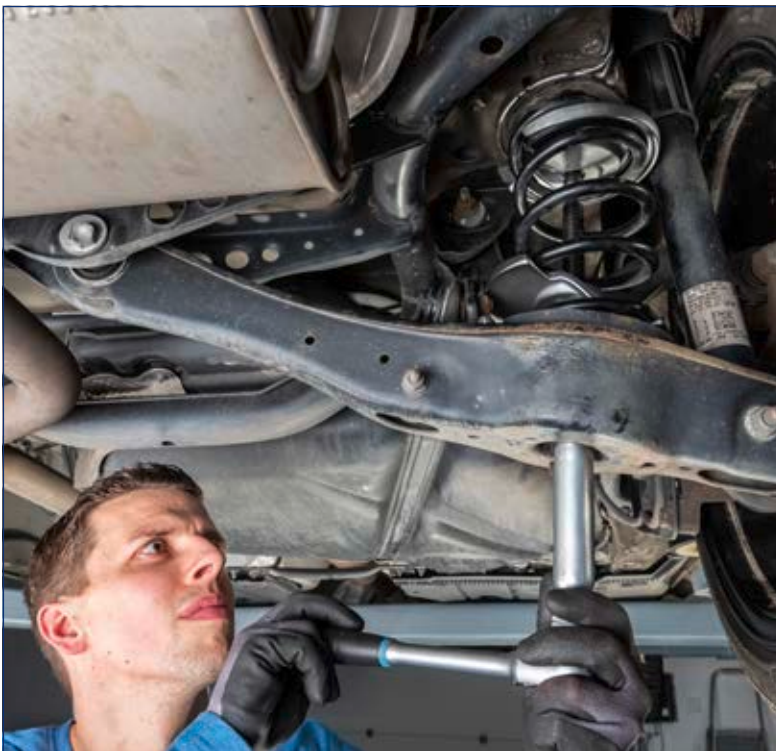
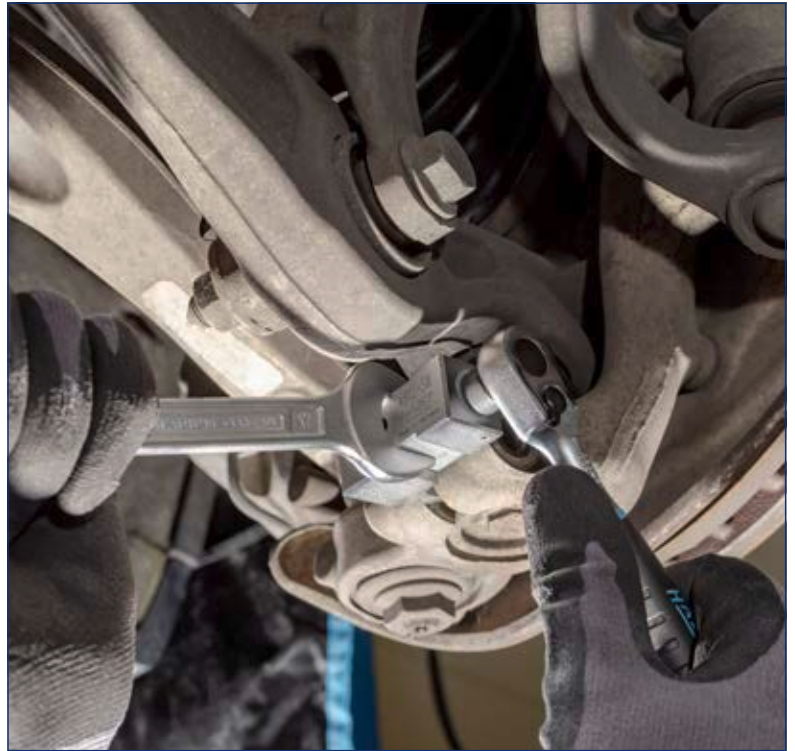

Good ideas –
cleverly implemented
by HAZET



Specialty tools

Engine – Engine timing / Timing belt



Engine

Engine timing / Timing belt

220 Universal engine support

Made in Germany

• For transverse engines

- Application: Supporting the engine during maintenance work on thrust bearings, timing belts, water pumps or tensioner rollers
- Suitable for nearly all vehicle types
- After loosening the engine mount, the engine support safely holds the vehicle engine in the engine compartment (time savings and higher safety at work)
- Installation of the engine support underneath the motor vehicle allows optimum access during repair work (engine is supported from below). Optimum working conditions in the engine compartment (from above)
- The most important advantage compared to work with engine lifting beam or engine crane (both are mounted above the engine and may obstruct repair works) is that the engine compartment is freely accessible
- Note for using engine lifting beams:
 - The fenders of newer vehicles often slope or are made of plastic material. This means that, unlike with the HAZET universal engine support, classic engine lifting beams are often unsuitable and not mountable without damage
- Rubber covered feet with ball bearings allow flexible adjustment of the engine support
- Variable length: 620 – 900 mm
- Including 2 assembly holders
- Fully galvanised for optimal surface protection
- Manual operation through T-handles or wing screws
- Maximum loading capacity: 250 kg



HAZET No.	EAN-No. 4000896+
220-1	191758



2540 Timing belt pulley-counterholder

Made in Germany

- Application: Removing and installing timing belt pulleys on the camshaft, crankshaft and injection pump
- Counterholder with replaceable pins
- On VW Lupo · Polo · New Beetle · Golf · Caddy · Bora · Touran · Sharan · Transporter
- AUDI A2 · A3 · A4 · A6 · TT
- SKODA Fabia · Octavia · Superb
- Distance between pins: 100 mm and 46 mm
- Opening width: 33 mm
- Handle with dip-coating
- Surface: chrome-plated



HAZET No.	l mm	EAN-No. 4000896+
2540-1	722	110407

2587 Timing belt double-pin wrench

Made in Germany

• For professional engine repair

- Application: Adjusting the timing belt on the tensioner roller
- AUDI A3 1.9 TDi · A4 1.6 · 1.6 l diesel
- SEAT Toledo 1.6 · 1.8 · 2.0 · 1.8 16V · 2.0 16V
- VW Golf 1.9 SDi · TDi · Golf · Jetta · Passat 1.6 l diesel · Passat 1.6 · Passat 2.0 · Polo 1.9 SDi · TDi
- SKODA 1.6 – 1.9 l diesel
- Offset
- Distance of pins: 18 mm, pin Ø: 2.9 mm
- Timing belt double-pin wrench

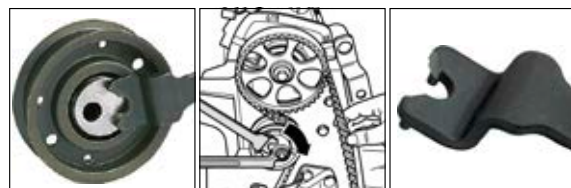

HAZET No.	l mm	EAN-No. 4000896+
2587	140	017140



Product applications

Engine timing tools
hazet.de → Service → Tool Finder
 → Engine timing tools

◀ For Smartphones with QR reader (app)

2588 Engine timing tool AUDI · VW · SEAT · ŠKODA

- Application: Checking and adjusting the engine timing
- Detailed operating instructions including cross references to original part numbers
- Single parts optionally available
- **VW** 1.2 TFSi petrol engines
- **AUDI** A1 · A3
- **SEAT** Altea/XL · Ibiza · León
- **ŠKODA** Fabia 2 · Octavia 2 · Roomster · Yeti
- **VW** Caddy · Golf · Golf Plus · Jetta · Polo · Touran
- **Engine code:** CBZA · CBZB · CBZC
- Safety-Insert-System, 2-component soft foam insert. Insert also suitable for HAZET Assistant



1/9			
-----	--	--	--

HAZET No.	L x W mm		EAN-No. 4000896+
• Engine timing tool set, contents: 2588-20 (1x) · 21 (1x) · 22 (2x)			
2588-1/4	172x114	4	180325

1/2" Camshaft adjuster 2788 TORX® screwdriver socket with drilled hole

Made in Germany

- Work on camshaft, timing chain or camshaft adjuster



- Application: Screw connection on camshaft adjuster
- **MERCEDES-BENZ:**
C-Class type 203 · 204 · 205 · CLK 209
E-Class type 211 · 212 · E-Class Coupé type 207
SLK type 171 · 172
G-Class type 463 · Sprinter type 906
- Petrol engines:
M133 · 157 · 176 · 177 · 270 · 271 · 271.8 · 271.9 · 272 · 273 · 274 · 276 · 278
- With knurling
- Surface: TIN coated

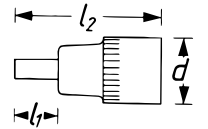

HAZET No.	l ₁ mm	l ₂ mm		EAN-No. 4000896+
2788-T100H	60	100	22.15	206650

Spark and glow plug

1849 Spark plug socket pliers

Made in Germany

- Especially suitable for hot terminals

- Application: **Installing and removing spark plug sockets**
- Side cutter
- Ergonomically shaped HAZET 2-component plastic handle covers (blue/black)
- Surface: chrome-plated



HAZET No.	l mm	EAN-No. 4000896+
1849	195	007080

1849 Spark plug socket pliers

Made in Germany

- Long style provides a better safety distance to the hot engine

- Application: **Installing and removing straight spark plug sockets**
- Especially for **low-lying spark plug sockets**, e.g. on **AUDI** V6 and V8 engines · **JAGUAR** 12-cylinder
- Ergonomically shaped HAZET 2-component plastic handle covers (blue/black)
- Surface: chrome-plated



HAZET No.	l mm	EAN-No. 4000896+
1849-2	290	007103

Made in Germany

- Safe application due to milled jaw profile

- Application: **Installing and removing straight spark plug sockets**
- Especially on **MERCEDES-BENZ**
- Ergonomically shaped HAZET 2-component plastic handle covers (blue/black)
- Surface: chrome-plated



HAZET No.	l mm	EAN-No. 4000896+
1849-1	200	128037

Made in Germany

- Especially suitable for hot terminals

- Application: **Installing and removing spark plug sockets**
- Long style
- Ergonomically shaped HAZET 2-component plastic handle covers (blue/black)
- Surface: chrome-plated



HAZET No.	l mm	EAN-No. 4000896+
1849-3	265	055098



Specialty tools

Engine – Spark and glow plug



1849 Spark plug socket remover

Made in Germany

• Slotted tube for optimal and careful guidance of the cable

• Application: **Installing and removing spark plug sockets**, even on hot engines

For 2.8-2.9 l VR6-engine **VW**
Golf, Passat, Vento, Corrado, T5
2.0 l, Lupo 4-cyl. engine model
year 1999 →, **AUDI** A4, A6 with
2.6 and 2.8 l V6 engines



HAZET No.	l mm	EAN-No. 4000896+
1849-6	253	007110

Made in Germany

• Application also on hot engines

• Application: **Installing and removing spark plug sockets**

• For **VW** Golf 4 · 5 · 6–1.6 l · Polo 5–1.2 l model year 2009 → · Bora model year 1999 → and Touran model year 2004 → with 1.6 l · 4-cylinder injection engine with roller cam follower, New Beetle model year 1999 → with 2.0 l · 4-cylinder injection engine and 2 valve 4-cylinder. injection engine with roller cam follower
AUDI A3 model year 2004 → with 2 valve 4-cylinder injection engine
SEAT · **ŠKODA** · **SMART** For Two (type 450)

• Plastic T-handle



HAZET No.	l mm	EAN-No. 4000896+
1849-9	275	110476

1849 Pencil coil extractor

Made in Germany

• Fast and safe extraction of the pencil coils

• Application: **Removal of pencil coils** e.g. on 1.0 l · 1.0 l TSI · TFSI · TGI · GTI · CNG · 1.2 l TSI · 1.4 l-25 · 30 · 35 · 40 · 45 TSI · TFSI · TGI · CNG · GTE · Mild Hybrid · e-Hybrid-1.6l · 1.6 l SRE · MPI- 2.0 l GTI

• **AUDI** A1 · A3 · A4 · A5 · Q2 · Q3

• **CUPRA** Formentor · León

• **SEAT** Alhambra · Arona · Ateca · Ibiza · León · Mii · Tarraco · Toledo

• **ŠKODA** Citigo · Fabia · Kamiq · Karoq · Kodiaq · Octavia · Rapid · Scala · Super · Yeti

• **VW** Caddy · Golf 6, 7, 8 · Jetta 4 → 7 · CC · Passat B8 / Polo 5 → 6 · Arteon · Beetle · Taigo · Tiguan · Touran · T-Cross · T-Roc · Up! · Scirocco · Sharan · T7

• **Removal of both ignition coil versions possible:**

– 04C.905.110.J → 2017 from VAG engines

– 04E.905.110.K 2017 → from VAG engines

• 2-component T-handle

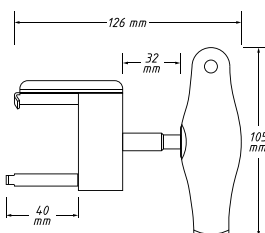

HAZET No.	l mm	EAN-No. 4000896+
1849-12A	126	247387

2131 Spark plug brush

Made in Germany

• Special corrugated brass wire bristles

• Application: **Cleaning electrodes and contacts on spark plugs**

• 3 rows

• Trim size: 15 mm

• Wooden body



HAZET No.	l mm	EAN-No. 4000896+
2131	150	012541

1849 Ignition coil remover

Made in Germany

• Application: **Installing and removing ignition coils with final output stage**

• On **VW** Polo · Fox 1.2 l · Golf 1.4 · 1.6 l · Golf Plus 1.4 l model year 2005 → · Caddy 1.4 l · Bora 1.4 · 1.6 l · Beetle 1.4 l (petrol engine model year 2003) · Scirocco 1.4 l model year 2009 → · Lupo 4-cylinder direct injection engine model year 1999 → · Passat B7 1.4 l TSI · Touran 1.6 l · Phaeton · Transporter T4 · **ŠKODA** Fabia

• Plastic T-handle
• Surface: chrome-plated



HAZET No.	l mm	EAN-No. 4000896+
1849-7	135	110353

Made in Germany

• Application: **Installing and removing ignition coils with final output stage**

• On **VW** Golf · Bora · Eos 3.2 l model year 2006 → · Passat · Sharan · Touareg 6-cylinder model year 2003 → · Transporter T5 3.2 l 6-cylinder injection engine model year 2004 →

AUDI TT 3.2 l model year 1999 → 2007 · A3 3.2 l model year 2004 → · Passat B7 3.6 l FSI

• Plastic T-handle
• Surface: chrome-plated



HAZET No.	l mm	EAN-No. 4000896+
1849-8	133	110360

Made in Germany

• Application: **Installation/removal of ignition coils with final output stage**

• **VW** direct injection engines 2.0: Golf model year 2004 → · Touran model year 2004 → · Passat model year 2006 → · Eos model year 2006 → · Polo model year 2002 → 4-cylinder 5V · Scirocco model year 2009 → 1.8 and 2.0 l · Tiguan model year 2006 → 1.8 and 2.0 l · Phaeton model year 2003 → 8-cylinder Passat B7 1.8–2.0 l TSI

• **AUDI** direct injection engines:
A3 model year 2004 → 2.0 · A4 model year 2002 → 2.0 · A5 model year 2008 → 3.2 and 4.2 l · A6 model year 2005 → 3.2 · A8 model year 2003 → 3.2–4.2 and 5.2 l, TT model year 2007 → 1.8 and 2.0 l · R8 model year 2008 → 4.2 l · Q5 model year 2008 → 2.0 and 3.2 l · Q7 model year 2007 → 3.6 and 4.2 l

• Plastic T-handle
• Surface: chrome-plated



HAZET No.	l mm	EAN-No. 4000896+
1849-10	102	132201



Overview spark and glow plugs

HAZET No.	mm	"	l mm	□
4760-2 (G)	8	–	142	10 3/8
2530 (G)	10	–	140	10 3/8
4766-2	14	–	64	10 3/8
4766-3	14	–	154	10 3/8
880 A MgT	16	5/8	64	10 3/8
880 A KF	16	5/8	64	10 3/8
900 A MgT	16	5/8	71	12 1/2
900 A KF	16	5/8	71	12 1/2
4766	16	5/8	97	10 3/8
4766-1	16	5/8	270	10 3/8
880 MgT-18	18	–	62	10 3/8
880 MgT	20,8	13/16	64	10 3/8
880 KF	20,8	13/16	64	10 3/8
900 Lg-20,8	20,8	13/16	85	12 1/2
900 TZ-20,8	20,8	13/16	85	12 1/2
900 MgT	20,8	13/16	68	12 1/2
900 KF	20,8	13/16	71	12 1/2
2505-2	20,8	13/16	137,5–197,5	10 3/8

(G) = Glow plug

880 MGT 3/8" Spark plug socket

Made in Germany

- Application: **Spark plug changing**
- With permanent magnet
- Long design
- **American dimensions**
- Surface: chrome-plated, polished

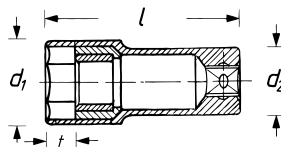

HAZET No.	S mm	S"	l mm	d ₁ mm	d ₂ mm	t mm	EAN-No. 4000896+
880 MGT	20.8	13/16	64	27.4	22.5	9	040872
880 A MGT	16	5/8	64	21.6	21.6	9	040247

Made in Germany

- With permanent magnet
- Application: **Spark plug changing**
- Outside hexagon: 17 mm
- For motorcycles, e.g. **HONDA · YAMAHA · SUZUKI · KAWASAKI** etc.
- Long design
- Surface: chrome-plated, polished

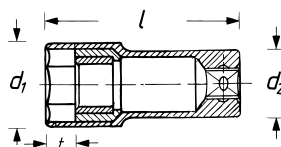

HAZET No.	S mm	l mm	d ₁ mm	d ₂ mm	t mm	EAN-No. 4000896+
880 MGT-18	18	62	23.5	22.8	9.6	040889

880 KF 3/8" Spark plug socket

Made in Germany

- The fixing clamp reduces the risk of insulator damage

- Application: **Spark plug changing** (s 20.8 mm = 13/16")
- **Fixing clamp** to hold the spark plug
- Long design
- **American dimensions**
- Surface: chrome-plated, polished

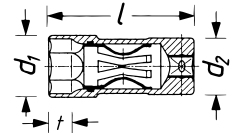

HAZET No.	S mm	S"	l mm	d ₁ mm	d ₂ mm	t mm	EAN-No. 4000896+
880 KF	20.8	13/16	64	27.4	25	10	040674
880 A KF	16	5/8	64	21.6	21.6	10	040131

900 MGT 1/2" Spark plug socket

Made in Germany

- Application: **Spark plug changing**
- Magnetic bit retention
- **American dimensions**
- Surface: chrome-plated, polished

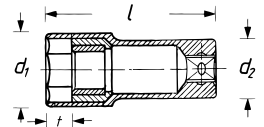

HAZET No.	S mm	S"	l mm	d ₁ mm	d ₂ mm	t mm	EAN-No. 4000896+
900 MGT	20.8	13/16	68	27.4	23.5	9	044023
900 A MGT	16	5/8	71	22.5	22.5	8.5	043491

900 KF 1/2" Spark plug socket

Made in Germany

- The fixing clamp reduces the risk of insulator damage

- Application: **Spark plug changing**
- **Fixing clamp** to hold the spark plug
- **American dimensions**
- Surface: chrome-plated, polished

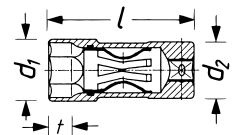

HAZET No.	S mm	S"	l mm	d ₁ mm	d ₂ mm	t mm	EAN-No. 4000896+
900 KF	20.8	13/16	71	27.4	25	10	043859
900 A KF	16	5/8	71	22.5	22.5	10	043408

Fixing clamp information

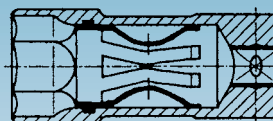

- Stainless and insensitive to heat
- Largest possible clearance of insulator
- 6 spring elements – firm hold of the spark plug
- Damping of transverse motion



Specialty tools

Engine – Spark and glow plug



2505 3/8" Spark plug spanner

Made in Germany

Adjustable in length from 137.5 mm to 157.5 and 197.5 mm

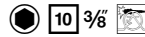

- Application: **Spark plug change with 20.8 / 13/16" size**
- Rubber ply
- American dimensions**
- Drive with ball race
- Surface: chrome-plated



HAZET No.	S mm	S"	l mm	d ₁ mm	d ₂ mm	t mm	EAN-No. 4000896+
2505-2	20.8	13/16	197.5	29	16	7	016266

4766 3/8" Spark plug spanner

Made in Germany

Short style

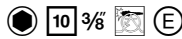

- Application: **Spark plug change (C plugs) (s 16 mm = 5/8")**
- On e.g. motorcycles, **BMW C1 · KAWASAKI · YAMAHA · HONDA · SUZUKI · DUCATI · MERCEDES-BENZ** passenger cars e.g. A-Class (type 168 · 169) · B-Class (type 245) · **SMART** (type 451)
- With fixing clamp for a firm hold of the spark plug
- Angular movement ± 25°
- American dimensions**
- With hinge – for working in areas with restricted access and for getting around obstructive edges
- Drive with ball race
- Surface: chrome-plated



HAZET No.	S mm	S"	l mm	d ₁ mm	d ₂ mm	t mm	EAN-No. 4000896+
4766	16	5/8	97	21.4	18	10	049295

Made in Germany

With fixing clamp for a firm hold of the spark plugs

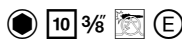

- Application: **Spark plug change (16 mm or 5/8")**
- On e.g. **VW · AUDI · SEAT · ŠKODA · RENAULT · FIAT · FORD · OPEL/VAUXHALL · BMW · NISSAN · HONDA · MAZDA · MITSUBISHI · KIA · Volvo**
- Angular movement ± 50°
- American dimensions**
- With hinge – for working in areas with restricted access and for getting around obstructive edges
- Drive with ball race
- Surface: chrome-plated



YouTube Clip

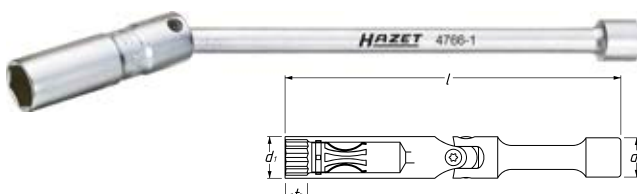

HAZET No.	S mm	S"	l mm	d ₁ mm	d ₂ mm	t mm	EAN-No. 4000896+
4766-1	16	5/8	270	21.4	18	10	048991

4766 3/8" Spark plug spanner

Made in Germany

12-point profile enables application of spark plugs with 6-point and 12-point

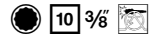

- Application: **Spark plug change (s 14 mm)**
- Fixing clamp for a firm hold of the spark plug
- On **BMW E90 N 54 engine 335 i** saloon model year 2006 → · 1 Series (F20) 118i · **RENAULT** Modus · Twingo · Clio · Kangoo with 1.2 l 16 V engine · **PEUGEOT** 207 · 307 and **CITROËN** C4 with 1.4 and 1.6 l 16 V engine · C5 with 2.0 l HPI engine · **MERCEDES-BENZ** engine M 156 · engine M 276 · **NISSAN** Micra · Note · **MINI** 1.2 – 1.4 l 4-cylinder model year 2007 → · **FORD** 1.0 EcoBoost engine · **ALFA ROMEO** 1.8 TBI engine · **KIA** · **PORSCHE** 911 GT3 model year 2014 → · 2.9 l · 3 l · 4 l · **AUDI** 3 l TFSI · **VW** 3 l TSI
- Drive with ball race

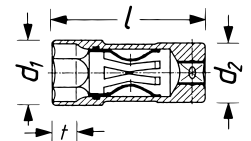

HAZET No.	S mm	l mm	d ₁ mm	d ₂ mm	t mm	EAN-No. 4000896+
4766-2	14	64	18	17.3	10	087655

Made in Germany

12-point profile enables application of 14 mm spark plugs with 6-point and 12-point

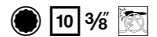

- Application: **14 mm spark plug change e.g. BMW and MERCEDES-BENZ**
- Fixing clamp for a firm hold and problem-free positioning and assembly of the spark plug
- Angular movement ± 56°
- With hinge – for working in areas with restricted access and for getting around obstructive edges
- Drive with ball race

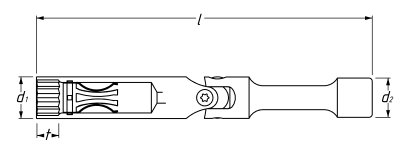

HAZET No.	S mm	l mm	d ₁ mm	d ₂ mm	t mm	EAN-No. 4000896+
4766-3	14	154	19.1	18	10	199976





2530 3/8" Glow plug socket

Made in Germany

• With ball clamping to hold the glow plug

- Application: **Glow plug change** (s 10 mm)
- **VW · AUDI** direct injection engines TDi and **MERCEDES-BENZ** CDI · **SMART**
- Angular movement $\pm 45^\circ$
- With hinge – for working in areas with restricted access and for getting around obstructive edges
- Drive with ball race
- Blister packed
- Surface: chrome-plated



HAZET No.	S mm	l mm	d ₁ mm	d ₂ mm	t mm	EAN-No. 4000896+
2530	10	140	15	18	9	016341

4760 3/8" Glow plug wrench

Made in Germany

• With ball clamping to hold the glow plug

- Application: **Glow plug change** (s 8 mm)
- On e.g. **MERCEDES-BENZ · SMART · VW · FIAT** and **OPEL/VAUXHALL** diesel engines
- Angular movement $\pm 45^\circ$
- **American dimensions**
- With hinge – for working in areas with restricted access and for getting around obstructive edges
- Drive with ball race
- Blister packed
- Surface: chrome-plated

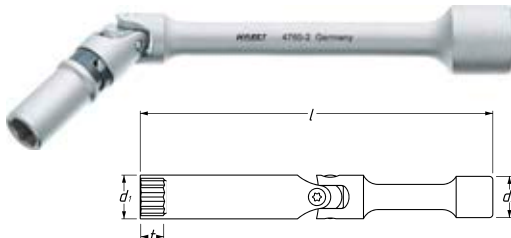

HAZET No.	S mm	l mm	d ₁ mm	d ₂ mm	EAN-No. 4000896+
4760-2	8	142	11.8	18	118670

4760 Glow plug socket pliers

Made in Germany

• The pliers' design is specially adapted to the sockets

- Application: **Installation and removal of glow plug sockets on diesel engines** e.g. **MERCEDES-BENZ · VW · AUDI · SEAT · ŠKODA · BMW**
- Offset design for use on glow plug sockets in areas with restricted access
- **With recess preventing cable damage**
- Ergonomically shaped HAZET 2-component plastic handle covers (blue/black)



HAZET No.	EAN-No. 4000896+
4760-5	089130

4760 Glow plug removal set

Made in Germany

• Knocking out broken glow plugs s 8–10 mm

- **Allows time-saving repair** without the need to remove the cylinder head
- Damaged threads are **trimmed or renewed/reworked** (see also 4760-M8 to -M10)
- Plastic box 165-L (1/3)
- Safety-Insert-System, 2-component soft foam insert. Insert also suitable for HAZET Assistant

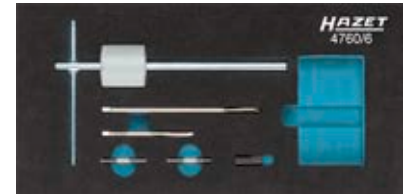

1/3			

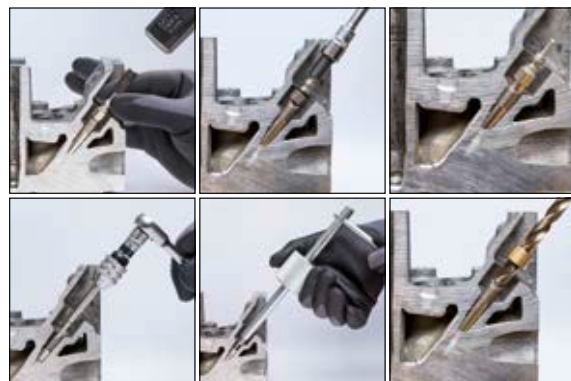

HAZET No.	L x W x H mm		EAN-No. 4000896+
4760/6	355x235x65	6	191642

4760 Glow plug repair set

Made in Germany

• Thread repair without having to remove the cylinder head

- To be used together with glow plug removal set 4760/6
- Plastic box 165-S (1/9)
- Safety-Insert-System, 2-component soft foam insert. Insert also suitable for HAZET Assistant



1/9			



YouTube Clip

HAZET No.	L x W x H mm		EAN-No. 4000896+
-----------	--------------	--	------------------

- Ripped out threads M8x1 are reworked on M10x1 thread
- 1 twist drill 6.8 mm with spacer sleeve
- 1 tap M8x1
- 1 tap M10x1
- 1 twist drill 9 mm
- 5 threaded inserts M8x1

4760-M8 x 1/9	185x153x52	9	191536
---------------	------------	---	--------

- Ripped out threads M10x1 are reworked on M12x1 thread
- 1 twist drill 9 mm with spacer sleeve
- 1 tap M10x1
- 1 tap M12x1
- 1 twist drill 11 mm
- 5 threaded inserts M10x1

4760-M10 x 1/9	185x153x52	9	191529
----------------	------------	---	--------



Cylinder head

TiN coating

TiN

Why choose TiN (Titanium Nitride) coating?

- A special coating process for extremely hard TiN coating guarantees high adhesive strength and wear resistance of the coating
- Particularly suitable for continuous load, e. g. for industrial applications in industry and trade
- Higher wear protection guarantees a longer lifetime
- Perfect fitting accuracy due to optimum coating thickness
- Optimized corrosion protection

TiN coated screwdriver sockets

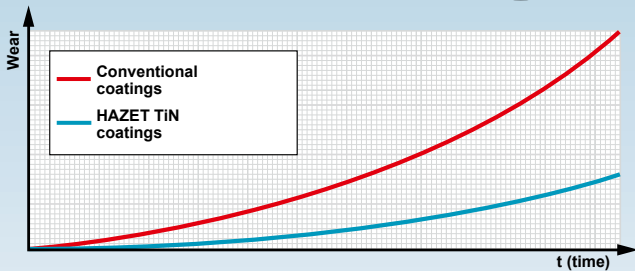
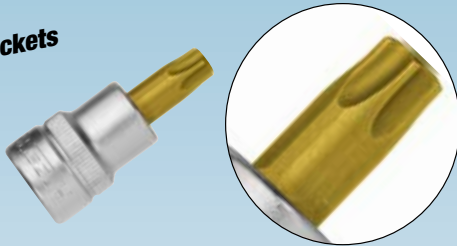

986 SL 1/2" Screwdriver socket

Made in Germany

- Extra long design
- With knurling
- Surface: TiN coated
- DIN 7422



HAZET No.	S mm	l ₁ mm	l ₂ mm	d mm	EAN-No. 4000896+
986 SL- 8	8	102	140	23	232345
986 SL-10	10	102	140	23	232321

990 1/2" Screwdriver socket

Made in Germany

- Application: Cylinder head screw connection (XZN screws)
- Short design
- With knurling
- Surface: TiN coated

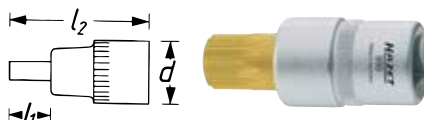

990 1/2" Screwdriver socket



HAZET No.	S	l ₁ mm	l ₂ mm	d mm	EAN-No. 4000896+
990-10	M10	15	53	23	047253
990 LG-9	M9	62	100	23	103140
990 LG-14	M14	62	100	23	065240
990 SLg-10	M10	82	120	23	047369
990 SLg-12	M12	102	140	23	047376
2751	M10	100	140	23	017508

991 1/2" Screwdriver socket

Made in Germany

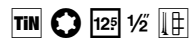

- Application: Cylinder head screw connection (RIBE CV screws), e.g. on FIAT 2.0 engines
- Short design
- With knurling
- Surface: TiN coated

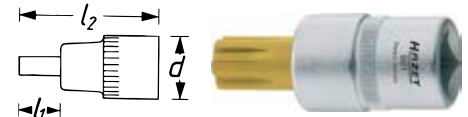

HAZET No.	S	l ₁ mm	l ₂ mm	d mm	EAN-No. 4000896+
991-12	M12	25	63	23	047413

992 LG 1/2" Screwdriver socket · TORX®

Made in Germany

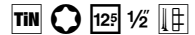

- Application: Cylinder head screw connection (for inside TORX® screws)
- Long design
- With knurling
- Surface: TiN coated



HAZET No.	S	l ₁ mm	l ₂ mm	d mm	mm	EAN-No. 4000896+
992 SLg-T55	T55	102	138	23	11.22	047642
992 LG-T55	T55	57	96	23.3	11.22	057337
992 LG-T70	T70	67	105	24.6	15.54	047611

2579 1/2" Cylinder head screwdriver socket

Made in Germany

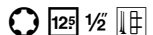

- Application: Operating Polydrive cylinder head bolts on VW engines (VW · AUDI · SEAT · ŠKODA) and FORD 1.0 EcoBoost engines
- Extra long design
- With knurling



HAZET No.	l ₁ mm	l ₂ mm	d mm	EAN-No. 4000896+
2579-9	130	168	23	086931



Valves / Pistons

794 Piston ring compressor

Made in Germany

- With tensioner adjuster
- Continuous regulation
- High-strength spring band steel
- Safety spring prevents undesired spring open



HAZET No.	h mm	∅ mm	EAN-No. 4000896+
794-01	50	40–75	031597
794-1	80	60–125	031610
794-2	80	90–175	031641

794 U Piston ring collet chuck

Made in Germany

- Application: Compression of piston rings on water-cooled and air-cooled engines
- **Tightening strap (width 32 mm), releasable**
- Surface: chrome-plated

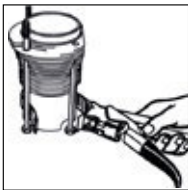

HAZET No.	l mm	h mm	∅ mm	EAN-No. 4000896+
794U-3	332	32	70–100	031672

790 Piston ring pliers

Made in Germany

- Application: Installing and removing piston rings
- Surface: bright nickel-plated



HAZET No.	l mm	∅ mm	EAN-No. 4000896+
790-1	220	50–100	031412
790-1A	240	65–110	031429

Made in Germany

- Prism holder



- Application: Safe grip of various piston ring types
- Surface: nickel-plated, prism holder burnished



790 Piston ring pliers



HAZET No.	l mm	∅ mm	EAN-No. 4000896+
790-3	220	60–120	031450

795 Valve refacer

Made in Germany

- With suction cup



HAZET No.	∅ mm	EAN-No. 4000896+
795-1	20	031771
795-2	25	031788
795-3	30	031795
795-4	37	031801

792 Valve spring compressors

Made in Germany

- Application: Tensioning valve springs
- 1 pair each of straight and curved jaws, with straight jaws · 75–225 mm clamping range with curved jaws · 45–195 mm
- Surface: bright nickel-plated



HAZET No.	l mm	EAN-No. 4000896+
792-1	290	031481

791 Valve stem sealing ring pliers

Made in Germany

- Hardened jaws, serrated



- Application: Removing valve stem seals on 2-valve engines
- On **FORD · OPEL/VAUXHALL · NISSAN** etc.
- Surface: nickel-plated, jaws burnished



HAZET No.	l mm	EAN-No. 4000896+
791-5	250	031467



Specialty tools

Engine – Fuel system / Fuel injection



791 Valve stem sealing ring pliers

Made in Germany

- Hardened jaws, serrated, dip-coated

- Application: Easy and reliable removing of low-lying valve stem seals (**multi-valve engines**) due to the long jaws
- On e.g. **AUDI · FORD · OPEL/VAUXHALL**
- Straight
- Surface: nickel-plated



HAZET No.	l mm	EAN-No. 4000896+
791-8	270	061068

2991 Valve stem sealing ring pliers

Made in Germany

- Working area with dip coating for avoiding damage to the valve timing

- Application: **Removing valve stem seals** especially on **BMW multi-valve engines, OPEL/VAUXHALL, FORD, SEAT, ŠKODA** and **VW/AUDI**
- Hardened jaws, longitudinally toothed



HAZET No.	l mm	EAN-No. 4000896+
2991	250	018352

Fuel system / Fuel injection

8502LGTH 1/4" Screwdriver socket · TORX®

Made in Germany

- Application: For operating the EGR valve screw connection on **BMW** and **MINI** diesel engines N47 · N57 · B37 · B47 · B57
- With knurling
- Long, thin blade for areas with difficult access – it is not necessary to combine different tools

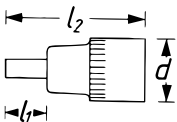
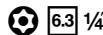

HAZET No.	s	l ₁ mm	l ₂ mm	d mm	EAN-No. 4000896+
8502LG-T30H	T30H	194	213	12	246076

615S Double box-end wrench

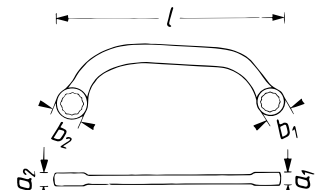
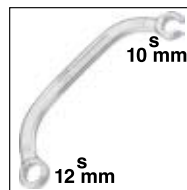

HAZET No.	l mm	a ₁ mm	a ₂ mm	b ₁ mm	b ₂ mm	EAN-No. 4000896+
615-S 10 x 12	147	7.5	7.5	18	20	203505

2168-2 Fuel filter releasing tool

Made in Germany

- Can be used easily even in areas with restricted access

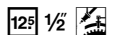

- Application: Operation of fuel filter housing on **FORD Duratorq 2.2 TDCI** engines
- Length: 130 mm
- Outside Ø: 160 mm
- **FORD** Transit Custom model year 04/2012 → · Tourneo Custom model year 04/2012 → · Transit model year 08/2013 →



HAZET No.	Ø mm	EAN-No. 4000896+
2168-2	160	226870

615S Double box-end wrench

Made in Germany

- Working on built-in components possible



- Application: Safe operation of control bar screw connection (loosening, adjusting, tightening) when removing or installing the pressurized can with position sensor for boost pressure plate on the turbocharger
- Bent double box-end wrench (12-point), slotted on sides (s 10 mm)
- Can be used in combination with HAZET socket **2561-10**
- For 2.0 l common rail engines (4-cylinder diesel engines)
- **VW** Golf model year 2009 → · Golf Plus model year 2009 → · Eos model year 2006 → · Jetta model year 2006 → · Passat model year 2006 → · Passat CC model year 2009 → · Beetle model year 2011 → · Scirocco model year 2009 → · Tiguan model year 2008 → · Transporter model year 2010 →
- **AUDI** A3 model year 2004 → TT model year 2008 → 2014
- **SEAT** Altea model year 2006 → · León model year 2006 → 2012 · Toledo model year 2006 → 2009
- **ŠKODA** Octavia model year 2006 → 2013 · Superb model year 2009 → 2015 · Yeti model year 2009 →





2517 High-pressure pump hub puller VAG

Made in Germany

- Especially suited to the very limited space at the installation site of the pump on the engine as well as the special shape of the wheel hub
- Application: Remove wheel hubs with no damage when dismantling the high-pressure pump
- For 1.4 l · 1.6 l · 2.0 l TDI/common rail engines:
VW Arteon · Golf 6-7 · Beetle · Polo 5-6 · Caddy · Passat · Sharan · Scirocco · Touran · Tiguan · T-Roc · Jetta · Crafter
AUDI A1 · A3 · A4 · A5 · A6 · TT · Q2 · Q3 · Q5
SEAT Ibiza · León · Toledo · Ateca · Arona · Alhambra · Altea · Exeo · Tarraco
ŠKODA Fabia · Superb · Octavia · Yeti · Kodiaq
- Hexagon for counterholding the puller: s 24 mm
- Spindle thread: TR 20x2
- Surface: aluminium puller, spindle burnished

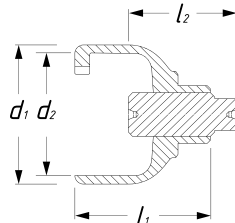

HAZET No.	l ₁ mm	l ₂ mm	d ₁ mm	d ₂ mm	EAN-No. 4000896+
2517-1	63	50	64.5	57	246786

2561 1/4" Turbo charger socket · 12-point

Made in Germany

Working on built-in components possible

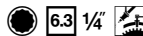

- Application: Safe operation of control bar screw connection (loosening, adjusting, tightening) when removing or installing the pressurized can with position sensor for boost pressure plate on the turbocharger
- Socket (12-point), slotted on sides
- Can be used in combination with HAZET double box-end wrench **615-S10x12**
- For 2.0 l common rail engines (4-cylinder diesel engines)
- VW** Golf model year 2009 → · Golf Plus model year 2009 → · Eos model year 2006 → · Jetta model year 2006 → · Passat model year 2006 → · Passat CC model year 2009 → · Beetle model year 2011 → · Scirocco model year 2009 → · Tiguan model year 2008 → · Transporter model year 2010 →
- AUDI** A3 model year 2004 → · TT model year 2008 → 2014
- SEAT** Altea model year 2006 → · León model year 2006 → 2012 · Toledo model year 2006 → 2009
- ŠKODA** Octavia model year 2006 → 2013 · Superb model year 2009 → 2015 · Yeti model year 2009 →

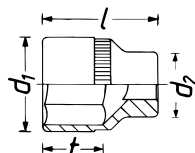

YouTube Clip

HAZET No.	s mm	l mm	d ₁ mm	d ₂ mm	f mm	EAN-No. 4000896+
2561-10	10	57	15	15	40	203512

2584-13 3/8" Suction pipe / special wrench · VAG

Made in Germany

Designed as a „suitcase handle“, enabling the screw connections to be easily tightened with torque

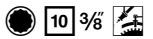

- Application: Operation of difficult to access fastening screw on the intake manifold (behind the high-pressure pump)
- Surface: chrome-plated
- For e.g. 3-cylinder common rail engines 1.4 l
AUDI A1 model year 2014 → 2018
SEAT Ibiza 4 model year 2015 →
VW Polo 5 model year 2014 → 2017
ŠKODA Fabia 3 model year 2014 → 2018 · Rapid model year 2015 → 2018

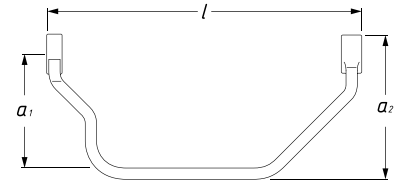

HAZET No.	l mm	a ₁ mm	a ₂ mm	EAN-No. 4000896+
2584-13	166	60	76.5	246779

2751 1/4" Turbo charger socket · Special profile

Made in Germany

Special profile engages with a positive fit in the screw connection and guarantees optimal force distribution

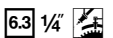

- Application: Operation of turbocharger intake manifold (not possible without special tool)
- MERCEDES-BENZ** C Class (W205, S205) C180 BlueTEC, C200 BlueTEC · C Class T model (S205) C180 BlueTEC, C200 BlueTEC · Vito (W447) 109 CDI, 111 CDI · Marco Polo Camper (W447) 160CDI, 180 CDI
- NISSAN** Qashqai / Qashqai +2 1 (J10, NJ10, JJ10E) 1.6 dCi, 1.6 dCi 4-wheel drive · Qashqai 2 (J11, J11) 1.6 dCi, 1.6 dCi All Mode 4x4-i · X-Trail (T32) 1.6 dCi, 1.6 dCi All Mode 4x4-i · NV300 Box (X82) 1.6 dCi 95/120
- OPEL/VAUXHALL** Vivaro B (X82) 1.6 CDTI
- RENAULT** Fluence (L3) 1.6 dCi, Grand Scénic 3 (JZ0/1) 1.6 dCi · Mégane CC (EZ0/1) 1.6 dCi · Mégane 3 Coupé (DZ0/1) 1.6 dCi · Scénic 3 (JZ0/1) 1.6 dCi · Trafic 3 Bus (JG, FG) 1.6 dCi 90/115
- Surface: phosphatized



HAZET No.	l mm	Ø mm	EAN-No. 4000896+
2751-1	26	12	246250





Specialty tools

Engine – Fuel system / Fuel injection



4550 3/8" Injection line wrench

Made in Germany
• Open 12-point socket

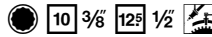

- Application: Operating screwed connections on injection lines
- Surface: chrome-plated



HAZET No.	S mm	l mm	d ₁ mm	d ₂ mm	EAN-No. 4000896+
<ul style="list-style-type: none"> • FIAT · CITROËN · PEUGEOT · RENAULT and IVECO models with Common Rail engines • Injection line screw connection e.g. on BMW · MERCEDES-BENZ · VW • Operation of the exhaust temperature sensor on VAG diesel engines from Euronorm 6 • Long design • <input type="checkbox"/> Drive 12.5 = 1/2" 					
4550-5	14	119	27	22.9	149582
<ul style="list-style-type: none"> • For BMW diesel and OPEL/VAUXHALL 2.5 TD-engines • <input type="checkbox"/> Drive 10 = 3/8" 					
4550	17	115	-	-	021680
<ul style="list-style-type: none"> • MERCEDES-BENZ 100 · 130 · 314 · 360 · 360h · 352A · 346/355 · 401 · 402 · 403 · 407h · 615 · 616 · 617 • Long style • <input type="checkbox"/> Drive 12.5 = 1/2" 					
4550-1	17	120	-	-	021697
<ul style="list-style-type: none"> • MERCEDES-BENZ M 352 · A · 346/355 · A · 401 · 402/422 · LA · 403 · 407h, as well as for the dipstick guide tube on M 314 • Long style • <input type="checkbox"/> Drive 12.5 = 1/2" 					
4550-2	19	119	-	-	021734

4555 1/2" Injection nozzle socket

Made in Germany

• Special relief to accommodate the return leakage tubes

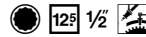

- Application: Injection nozzles (s 27 mm) on diesel engines
VW · AUDI · MERCEDES-BENZ · OPEL/VAUXHALL · FORD · PEUGEOT · Volvo · TOYOTA · MAZDA · NISSAN · MITSUBISHI · DAIHATSU
- Long design
- With knurling
- Surface: chrome-plated

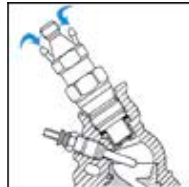

HAZET No.	S mm	l mm	d ₁ mm	d ₂ mm	t mm	EAN-No. 4000896+
4555 N	27	85	37.1	29.8	27.5	021840

4556 1/2" Pressure valve holder tool

Made in Germany

- Application: Installing and removing the **pressure valve holder** on the MRSF-ERE injection pump
- Serration socket
- For MERCEDES-BENZ diesel passenger cars, transport vehicles 601, 602, 603, 605, 606, 615, 616, 617
- 33 teeth
- Long design
- With knurling
- Surface: chrome-plated

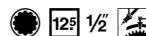

HAZET No.	S mm	l mm	d ₁ mm	d ₂ mm	t mm	EAN-No. 4000896+
4556	17.9x20	55.5	24	23	15.5	021864

4560 Injection line wrench

Made in Germany

- Application: Installing and removing the injection lines (s 17 mm)
- On e.g. VW, AUDI diesel engines:
1.6 l 4-cylinder, 2.0 l 5-cylinder, 2.4 l 6-cylinder
- Also suitable for the operation of the **exhaust temperature sensor** on VAG diesel engines (VW, AUDI, SEAT and ŠKODA) up to Euronorm 5
- Surface: chrome-plated



HAZET No.	S mm	l mm	EAN-No. 4000896+
4560	17x17	221	021918

4561 Injection pump wrench

Made in Germany

- Application: Operating **fastening screws** (s 13 mm) at the injection pump, when replacing the toothed belt or adjusting the injection start
- One-sided box-end wrench
- On 1.6 l 4-cylinder diesel engine AUDI, VW Golf, Jetta, Caddy, Passat, CITROËN
- Surface: chrome-plated



HAZET No.	S mm	l mm	EAN-No. 4000896+
4561	13	165	021925

4501 Fuel line pliers

Made in Germany

- Application: Operation of the **quick-release covers with light pressure on the fuel line** as well as tank aeration
- On FIAT · ALFA ROMEO · LANCIA vehicles with 1.3 l – 1.9 l – 2.4 l diesel, CHRYSLER · RENAULT OPEL/VAUXHALL (Diesel): Vectra C/Signum 1.9 l Diesel · Astra H 1.3 l and 1.9 l · Corsa C / Combo / Meriva 1.3 l OPEL/VAUXHALL (petrol): Corsa C · Astra G · Vectra C
- Plastic handle



YouTube Clip

HAZET No.	l mm	EAN-No. 4000896+
4501-1	155	058624



4501 Fuel line pliers

Made in Germany

- Simple operation of quick-release catches
- Application: For use when replacing the fuel filter or performing repair work on the engine
- For e.g. **MERCEDES-BENZ** · **VW-AUDI** · **FIAT** · **OPEL/VAUXHALL** · **CITROËN**
- **Volvo** D13 · D16 · **MAN** D3876 LF · D1556 LF · D2676 LF and **SCANIA** engines
- **CLAAS** agricultural machinery with **MAN** engine
- AdBlue lines and AdBlue injection nozzle
- Straight design
- Ergonomically shaped HAZET 2-component plastic handle covers (blue/black)



YouTube Clip



HAZET No.	l mm	EAN-No. 4000896+
4501-2	235	203499

4590 Flexible hose clamp

Clamping flexible hoses

- Firm fixation with clamp ring
- Made of high-quality plastic

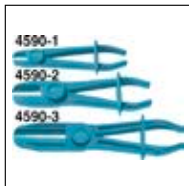

YouTube Clip

HAZET No.	l mm	EAN-No. 4000896+
4590-1	150	021932
4590-2	180	021949
4590-3	253	055753

4590 Flexible hose clamp set

Clamping flexible hoses



YouTube Clip

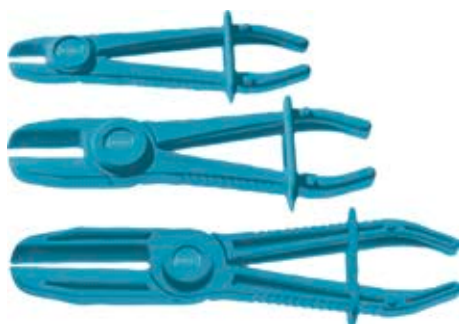

HAZET No.	l mm	EAN-No. 4000896+
4590/3	3	058266

2584-1 1/2" Intake pipe screwdriver socket

Made in Germany

- Application: Intake manifold screw connection
- **Extra long design**
- With knurling

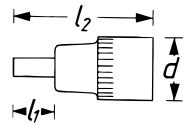
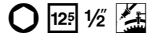

HAZET No.	S mm	l ₁ mm	l ₂ mm	EAN-No. 4000896+
2584-1	6	210	248	017058

4591 Pipe stopper set

Sealing of pipes and preventing fluids from escaping

- Application: Sealing pipelines in brake systems, air conditioning systems, power steering and fuel systems that cannot be secured with a flexible hose clamp
- Sealing in sizes of 6.3 mm (1/4") · 8 mm (5/16") · 10 mm (3/8") and for double sealing (e.g. banjo connections) in sizes of 10 mm (3/8")



HAZET No.	EAN-No. 4000896+
4591/4	219650

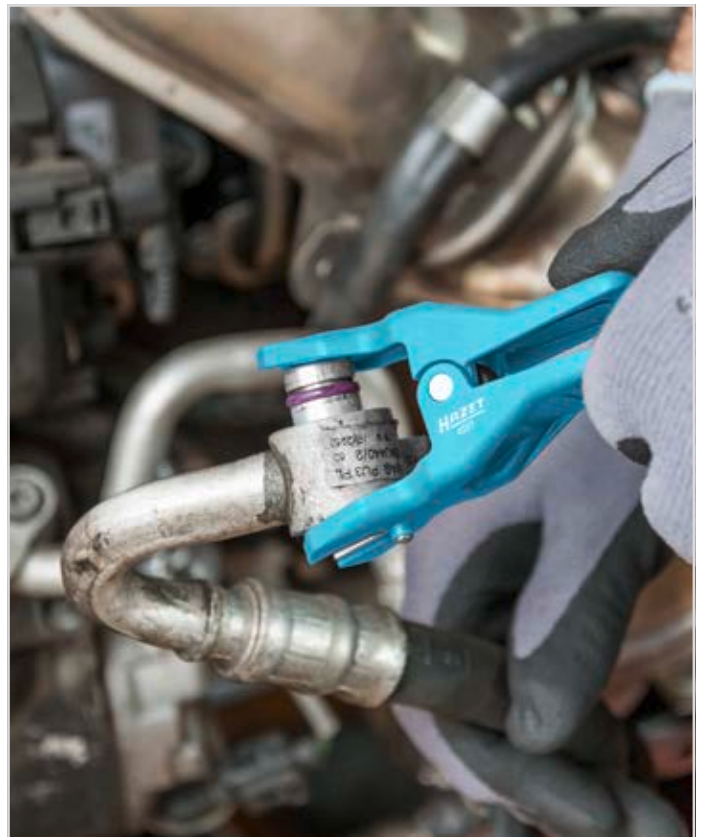



Specialty tools

Engine – Cooling system / Hose connection



4797 Injector extractor

Made in Germany

- Application: For disassembly of tight common rail injectors **without** removing the cylinder head

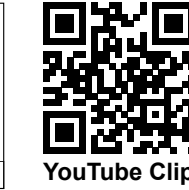

4797-1

YouTube Clip



4797-2

4797-3

4797-9

HAZET No.	l mm		EAN-No. 4000896+
<ul style="list-style-type: none"> • For e.g. MERCEDES-BENZ CDI engines 611 · 612 · 613 etc. • Especially suitable for the limited spaces due to the cylinder head cover 			
4797/2	460	2	121205
<ul style="list-style-type: none"> • Impact extractor • M16 x 1.5 • Striking weight: 1.8 kg 			
4797-1	460	-	121175
<ul style="list-style-type: none"> • Injector claw • M16 x 1.5 			
4797-2	130	-	121182
<ul style="list-style-type: none"> • External adapter with inside thread M16 x 1.5 on M27 x 1 • Removal of Bosch injectors with outside thread M27 x 1 • In conjunction with impact extractor 4797-1 • Operating mode: The external adapter must be used when the injector claw cannot be used, either because of the vehicle type or because of the lack of space. Note: after removing the injector with the external adapter, replace the injector 			
4797-3	50	-	121199

4797 Injector extractor



HAZET No.	l mm		EAN-No. 4000896+
<ul style="list-style-type: none"> • Piezo injector claw • Removal of Piezo injectors on MERCEDES-BENZ engines OM 651 • The design of the injector claw, tuned to the injector, ensures optimal reception of the injector during operation • MERCEDES-BENZ: A-class type 176 · B-class type 246 · C-class type 204, 205 E-class type 212 · S-class type 221, 222 · V-class type 639, 447 CLA type 117 · GLA type X156 · GLK type X204 CLS type 218 · ML type 166 · SLK/SLC type 172 · GLC type X253 • Operation with the HAZET impact extractor 4797-1 • Inside thread: M16 x 1.5 mm 			
4797-9	54.5	-	206667

4797 Thread repair tool set for injector fastening screw

- For **MERCEDES-BENZ** CDI engines. Suitable for reaming the broken-off expansion bolt M6 x 1 from the cylinder head **without** removing the valve cover
- Enormous money and time saving as the replacement of cylinder head and the removing of injectors and valve covers is not necessary
- Damaged thread is reworked to M8 x 1



- Contents:
- 1 twist drill 6 mm with spacer sleeve
 - 1 tap M8 x 1
 - 1 drill sleeve
 - 1 twist drill 7 mm with spacer sleeve and guide tube
 - 1 knob for screwing
 - 5 threaded inserts M6 x 1



YouTube Clip

- Plastic box 165-S (1/9)
- Safety-Insert-System, 2-component soft foam insert. Insert also suitable for HAZET Assistant

1/9			
-----	--	--	--



HAZET No.	L x W x H mm		EAN-No. 4000896+
4797/10	185 x 153 x 52	10	191505
<ul style="list-style-type: none"> • Threaded inserts · 5 pieces M6 x 1 for 4797/10 			
4797-M6 x 1/5	-	5	192441

Cooling system / Hose connection

798 Hose clamp pliers

Made in Germany

- Application: Simple hose clamps, e.g. on washing machines
- **Rotating jaws** – for areas with restricted access
- Surface: chrome-plated



HAZET No.	l mm	sb mm	EAN-No. 4000896+
798	206	40	031832

798 Hose clamp pliers

Made in Germany

- **Locking device, adjustable jaw opening**



HAZET No.	l mm	sb mm	EAN-No. 4000896+
798-1	285	45	031900



798 Clic hose clamp pliers

Made in Germany

- Application: Reusable CLIC type hose clips on fuel lines
- On e.g. **VW · AUDI · OPEL · PEUGEOT und ALFA ROMEO**
- Open and close easily by turning the pliers by 180°
- Fixed jaws, bent 90°



YouTube Clip

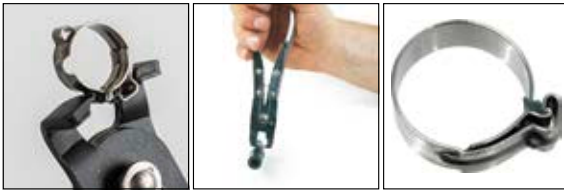

HAZET No.	l mm	sb mm	EAN-No. 4000896+
798-2	175	20	051397

Made in Germany

- Application: Operating reusable **CLIC** hose clips
- **AUDI · VW · OPEL/VAUXHALL · PEUGEOT · SMART** and **MERCEDES-BENZ**
- Open and close easily by turning the pliers by 180°
- **Rotating jaws** – for areas with restricted access
- Surface: nickel-plated



YouTube Clip

HAZET No.	l mm	sb mm	EAN-No. 4000896+
798-3	206	35	102433

798 Hose clamp pliers

Made in Germany

- Application: Self-gripping spring band hose clamps
- **Rotating jaws** – for areas with restricted access



HAZET No.	l mm	sb mm	EAN-No. 4000896+
798-4	205	35	031948

798 Hose clamp pliers

Made in Germany

- Application: **Spring band hose clamps** e.g. on **VW · AUDI · OPEL/VAUXHALL**
- **Rotating jaws** – for areas with restricted access

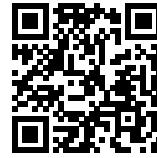

YouTube Clip



HAZET No.	l mm	sb mm	EAN-No. 4000896+
798-5	210	40	031955

Made in Germany

- Application: **Spring band hose clamps** 12 and 15 mm width, 13 – 22 mm Ø
- **Rotating safety jaws**

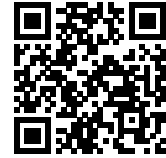

YouTube Clip

HAZET No.	l mm	sb mm	EAN-No. 4000896+
798-6	235	39	031962

Made in Germany

- **Self-adjusting joint** allows easy working even on spring band hose clamps with large diameter



- Application: **Self-gripping spring band hose clamps**, 12 and 15 mm width
- With locking device
- Self-adjusting joint
- **Rotating safety jaws**
- Handles with dip coating



HAZET No.	l mm	sb mm	EAN-No. 4000896+
798-8	290	45	076697



Specialty tools

Engine – Cooling system / Hose connection



798 Hose clamp pliers

- Made in Germany**
- With locking device



- Application: Especially for spring band hose clamps **12 and 15 mm width** e.g. cooling and heating system
- **Rotating jaws, bent 110°** – for areas with restricted access
- Handles with dip coating

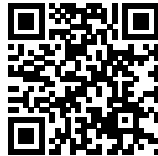

YouTube Clip

HAZET No.	l mm	sb mm	EAN-No. 4000896+
798-9	250	60	072163

- Made in Germany**
- With locking device



- Application: Spring band hose clamps – especially for **12 mm and 15 mm wide spring band hose clamps** e.g. on **OPEL/VAUXHALL · VW · FORD · RENAULT · FIAT · PEUGEOT · CITROËN · PORSCHE · ALFA-ROMEO · MERCEDES-BENZ · SMART**
- Adjustable jaw opening
- Fixed jaws



HAZET No.	l mm	sb mm	EAN-No. 4000896+
798-10	320	90	031917

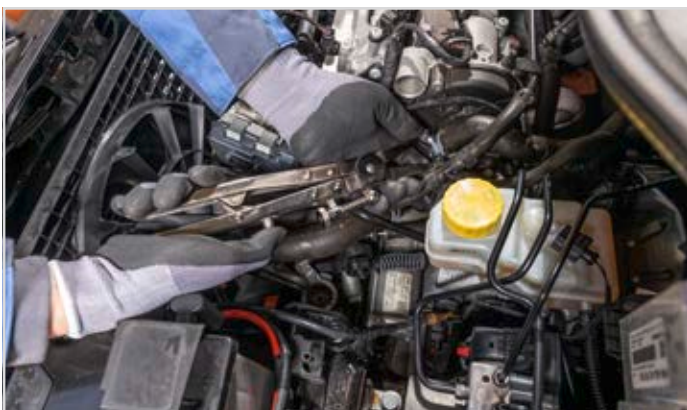

798 Hose clamp pliers

- Made in Germany**
- With locking device



- Application: Self-gripping spring band hose clamps
- Adjustable jaw opening
- Handles with dip coating



HAZET No.	l mm	sb mm	EAN-No. 4000896+
798-12	320	80	031931

- Made in Germany**



- For use in areas with restricted access where the clamp cannot be reached straight forwardly

- Application: **Operating spring band hose clamps whose three ends fit tightly on the hose**, e.g. on tank aeration lines and fuel lines on **VW · AUDI · SEAT · ŠKODA**
- **Rotating jaws** – for areas with restricted access

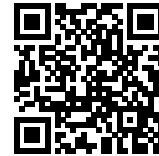
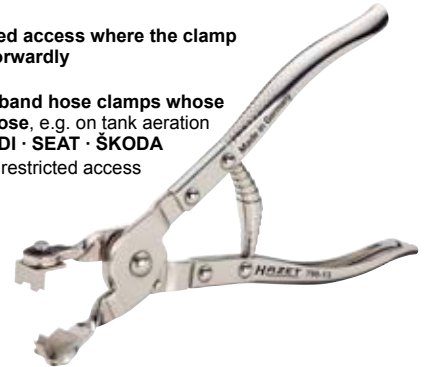

YouTube Clip

HAZET No.	l mm	sb mm	EAN-No. 4000896+
798-13	192	27	155248

- Made in Germany**



- Application: Operation of spring band hose clamps whose three ends fit tightly on the hose
- For e.g. on fuel lines and tank ventilation lines on **VW · AUDI · SEAT · ŠKODA**
- Surface: nickel-plated



HAZET No.	l mm	sb mm	EAN-No. 4000896+
798-14	177	20	109128



798 Hose clamp pliers

Made in Germany



• Bowden cable (610 mm) enables application in areas with restricted access where the direct use of pliers is not possible

• Application: Operation of self-gripping spring band and space-saving hose clamps sb 7–60 mm \varnothing , e.g. on the cooling and heating systems

• **One-hand operation thanks to automatic toothed fixing device**

• Sliding guide device with integrated tension spring and adjustable reversible plate

• Handles with dip coating

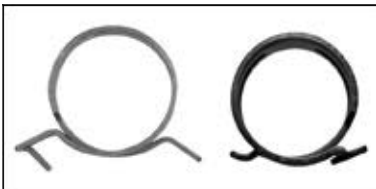

HAZET No.	l mm	sb mm	EAN-No. 4000896+
798-15 A	875	7–60	097258
• Bowden cable · complete Bowden cable · coating · 2 headless screws · spring for 798-15A			
798-0151 A	–	–	097753
• Bowden cable for 798-15A and B			
798-0152 A	–	–	097760
• Sliding guide device for 798-15A and B			
798-0153 A	–	–	097784

Made in Germany



• Particularly suitable for areas with restricted access where the direct application of pliers is not possible

• Application: Operating self-gripping spring band and space-saving hose clamps on the cooling and heating system

• **Plastic-coated, semi-flexible Bowden cable**

• The Bowden cable enables working without a guiding hand

• Sliding guide device with integrated tension spring and adjustable reversible plate

• **One-hand operation thanks to automatic toothed fixing device**

• Handles with dip coating



798 Hose clamp pliers

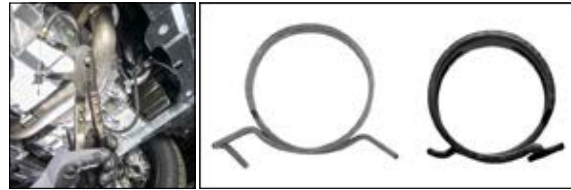

HAZET No.	l mm	sb mm	EAN-No. 4000896+
798-15 B	875	7–60	117727
• Flexible hose for 798-15B			
798-0150 B	–	–	142439
• Bowden cable for 798-15A and B			
798-0152 A	–	–	097760
• Sliding guide device for 798-15A and B			
798-0153 A	–	–	097784

Made in Germany



• Reinforced bowden cable and sliding guide device

• Application: **Special clamp with parallel clamp ends** e.g. at the charge-air cooler connection on VW Passat · T5 · T6

• Bowden cable enables application in areas with restricted access

• Toothed fixing device and one-hand operation

• Fixing device is released by pressure lever

• Handles with dip coating

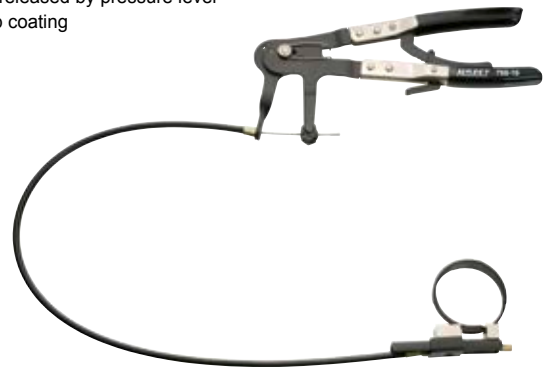

HAZET No.	l mm	sb mm	EAN-No. 4000896+
798-16	875	3–50	149032
• Bowden cable for 798-16			
798-0162	–	–	149056
• Sliding guide device for 798-16			
798-0163	–	–	149063





Specialty tools

Engine – Cooling system / Hose connection



798 Hose clamp pliers

Made in Germany

- Application: Operation of self-gripping **space-saving hose clamps** on coolant and fuel hoses in the entire vehicle area, in particular on **VW · AUDI · SEAT · ŠKODA**
- **Rotating jaws**
– for areas with restricted access



YouTube Clip

HAZET No.	l mm	sb mm	EAN-No. 4000896+
798-17	210	40	186068

798 Hose clamp pliers set

Made in Germany

- Safety-Insert-System, 2-component soft foam insert. Insert also suitable for HAZET Assistant



1/3			
-----	--	--	--

HAZET No.	L x W mm		EAN-No. 4000896+
798			
798-3 · 798-13 · 798-17			
163-425/3	342x172	3	202614

4562 Henn clamps operating tool

Made in Germany

- Handle shift of **90°** enables operation even on Henn clamps that are difficult to access



- Application: Proper operation of Henn clamps on coolant and charging air hoses
- Henn clamps with **2 operating openings** on the stop spring
- Width: 20 mm (in the functional range)



HAZET No.	l mm	EAN-No. 4000896+
4562-1	100	222353

4801 Vacuum radiator filler

Made in Germany

- Suitable in conjunction with the single and universal adapters from HAZET radiator tester program 4800 and cone set 4801-2/3



- Application: Vacuum leakage test before refilling the cooling system
- Bubble-free filling
- Easy application due to quick-release coupling
- Time-saving, no additional bleeding necessary
- Use with almost all types of vehicle possible
- Hose 7 x 1.5 mm
- Outer diameter 10 mm
- Inside diameter 7 mm
- Including operating instructions



YouTube Clip

HAZET No.	EAN-No. 4000896+
4801-1	148806

4801 Cone set for radiator / expansion tank

Made in Germany

- Universal set suitable for radiator / expansion tank



- Can be used together with vacuum radiator filler HAZET 4801-1 · 4802-1
 - Due to the vacuum generated in the cooling system the rubber cone is stuck firmly in the radiator or expansion tank opening
- 3-piece set** · Contents:
3 rubber cones with functional \varnothing 17–31 / 24–39 / 34–50 mm



YouTube Clip

HAZET No.		EAN-No. 4000896+
4801-2/3	3	152407



Diagnostics



Product applications
Classification radiator adapter
 hazet.de → Service → Tool Finder
 → Classification radiator adapter 4800
 ◀ For Smartphones with QR reader (app)

4800 Radiator tester

Made in Germany

- Application: Checking for leakage in cooling systems and heating circuits
- Classification to vehicle types: www.hazet.de → Service → The Tool Finder → Radiator adapters 4800
- Plastic box
- Application on **AUDI** A2 · A3 · A4 · A5 · A6 · A7 A8 · TT · **VW** Passat · Golf 4 · 5 · Lupo (model year 1998 →) · Vento · Jetta · EOS · Bora · T5 · **CITROËN** C2 · C3 · C4 · C5 · C6 · C8 · Jumper · Jumpy · **FIAT** Tipo · Tempra · **MERCEDES-BENZ** type 202 / 203 (C-Class) · 124 / 210 (E-Class) · 129 / 220 (S-Class) · 251 (R-Class) · 164 (M-Class) · **NISSAN** Micra · **OPEL/VAUXHALL** Vectra C · Astra H · Zafira A · Meriva · Signum · Corsa · **PEUGEOT** · **RENAULT** Safrane · Mégane · Laguna · Twingo · Trafic · Master · **SEAT** Arosa · Córdoba · Ibiza · Toledo · León · **SKODA** Octavia · Fabia · Roomster

Contents:
 4800-1 · 4800-2
 4800-4A · 6A · 12A · 15 · 17



HAZET No.		EAN-No. 4000896+
4800/7	7	132874

4800 Radiator tester

Made in Germany

- Application: Checking for leakage in cooling systems and heating circuits
- Classification to vehicle types: www.hazet.de → Service → The Tool Finder → Radiator adapters 4800
- Plastic box
- Contents
 4800-1 · 4800-2
 4800-3 · 4 A · 5 A · 6 A · 7 A · 8 A · 12 A · 13 A · 17 · 22 · 23



HAZET No.		EAN-No. 4000896+
4800/12	12	165483



4800 Cooling pump

Made in Germany

- Application: Checking for leakage in cooling systems and heating circuits
- Use with radiator adapters of series HAZET 4800



HAZET No.		EAN-No. 4000896+
4800-1	Cooling pump	022243
4800-2	Intermediary piece flexible hose, 500 mm long	022274



4800 Cooling pump and adapter

Made in Germany



- Application: Checking for leakage in cooling systems and heating circuits
- Threads adjusted exactly to opening of the expansion tank (bayonet fitting on 4800-3 · 10 · 11 · 16 · 22 · 23)
- Coupling nipple for connection to the quick coupling connection of the cooling pump 4800-1 and intermediary piece 4800-2 or vacuum radiator filler HAZET 4801-1 and 4802-1



HAZET No.

EAN-No. 4000896+

Radiator adapter STANDARD (with bayonet fitting) for:

- **Passenger cars:**
 - FIAT
 - KIA
 - MERCEDES-BENZ Vito · Viano · Solaris
 - MITSUBISHI
 - PORSCHE
 - SUZUKI Vitara · Samurai
- **Commercial vehicles / agricultural machinery:**
 - AMAZONE Pantera
 - CASE Magnum, Quadtrac
 - CLAAS Jaguar, Lexion, Scorpion, Ares, Atlas, Ceres, Arion
 - DAF 45 model year 05/1991 → 12/2000
 - DOOSAN Wheel excavator S · Caterpillar excavator DX
 - FENDT
 - KAESER Mobilair
 - LIEBHERR A308-316
 - MASSEY FERGUSON with tank number 180224M92 and 4296015M1
 - NISSAN forklifts
 - PUTZMEISTER BSA 1409
 - SCANIA

4800-3 022281

Radiator adapter (simultaneously serves as an adapter for HAZET radiator adapter without connecting nipple) for:

- **Passenger cars:**
 - ALFA ROMEO 147 · 164 · 166 · GT · Mito
 - CITROËN Berlingo model year 1998 → · C1 HDi · C2 · C3 · C4 · C5 · C6 · C8 · Jumper · Jumpy · Nemo · Picasso
 - DACIA Dokker · Duster · Lodgy · Logan · Sandero
 - FERRARI threaded port
 - FIAT 500 model year 2007 → · Bravo · Dobló · Ducato · Fiorino · Grande Punto · Idea · Linea · Multipla · Panda · Punto · Qubo · Scudo · Seicento · Stilo · Tempra · Tipo · Ulysse
 - FORD Ka model year 2009 →
 - LANCIA Delta · Musa · Phedra · Thesis · Ypsilon
 - LAND ROVER Defender TD5 · Freelander 2.0 DI
 - MASERATI threaded port
 - MERCEDES-BENZ Citan
 - MINI Mini model year 2007 →
 - MITSUBISHI Carisma D model year → 2003 · Space Star D
 - NISSAN Interstar · Kubistar · Micra · Primastar · Qashqai
 - OPEL Combo D · Crossland X · Grandland X · Movano · Zafira Life
 - PEUGEOT 206 · 207 · 307 model year 2004 → · 308 · 406 · 807 model year 2004 → · Expert · Partner
 - RENAULT Avantime · Espace · Master · Mégane · Laguna · Trafic · Twingo
 - Volvo 850 · 960 · C 70 model year → 2007 · S 40 model year → 2003 · S 60 model year → 2007 · S 80 model year → 2007 · V 40 model year → 2003 · V 70 model year → 2007 · XC 90 model year → 2007
- **Commercial vehicles / agricultural machinery:**
 - CASE CVX · Maxxum · Optum · Puma CS, SBS, LBS
 - CLAAS Arion · Axion
 - DEUTZ Engines 3.6 PowerPack · BF6M1013FC · TCD2013L6 2V and 4V · Genset 250kVA
 - FENDT Vario model year 2000 → · L series combine harvesters
 - FIAT M100 · 115 · 135 · 165
 - HATZ 4H50tic
 - IVECO Eco Daily with blue lock
 - NEW HOLLAND T6 · T7, T7 Elite Pack · TVT

4800-4A 156504

4800 Cooling pump and adapter



HAZET No.

EAN-No. 4000896+

Radiator adapter for

- **Passenger cars:**
 - AUDI
 - PORSCHE 986 · 987 · 996 · 997 · Cayman 987c1 · Carrera GT
 - SMART For Two · Roadster
 - VW Golf 2 · Transporter T3
- **Commercial vehicles / agricultural machinery**
 - COMPAIR Mobile compressor with VW expansion tank
 - FENDT Farmer 300 model year 1988 → · Type 500 · Type 700 · Vario model year 1988 →
 - LINDE forklifts
 - RENAULT Midlum model year 01/2000 → 12/2013
 - PUTZMEISTER BSA 1407D · BSA 2110 HP-D
 - Volvo FE model year 05/2006 → · FL model year 03/2000 →

4800-5A 161843

Radiator adapter for

- VW Passat · T4 · Lupo model year 1998 →
- SEAT Arosa · Córdoba · Ibiza model year 1999 →
- SEAT Vario and León model year → 1998
- ŠKODA Octavia model year → 1998

4800-6A 161850

Radiator adapter for

- **Passenger cars:**
 - CHEVROLET
 - DAEWOO/CHEVROLET
 - FORD Ka · Focus model year → 2007 · Fusion · Mondeo
 - OPEL/VAUXHALL Agila · Zafira A
- **Commercial vehicles / agricultural machinery:**
 - MAN Tga · L 2000

4800-7A 161867

Radiator adapter for

- BMW 3-series → model year 2008 · 5-series → model year 2003 · 5-series (E60) Diesel · 7-series → model year 2001 · X3 → model year 2010 · X5 → model year 2013

4800-8A 161874





4800 Radiator adapter

Made in Germany

• Application: Checking for leakage in cooling systems and heating circuits

Extended range for existing radiator tester HAZET 4800

• Threads adjusted exactly to opening of the expansion tank

• Coupling nipple for connection to the quick coupling connection of the cooling pump 4800-1 and intermediary piece 4800-2 or vacuum radiator filler HAZET 4801-1 and 4802-1



HAZET No.	EAN-No. 4000896+
Radiator adapter (with bayonet fitting) for • RENAULT 4800-10	022250
Radiator adapter (with bayonet fitting) for • SMART For Four · FORD · KIA • Japanese vehicles 4800-11	022267
Radiator adapter for • AUDI A1 (model year 2010 →) · A2 · A3 · A4 · A5 model year 2007 → · A6 · A8 · TT · Q5 · Q7 · R8 • VW Passat B5 · Eos · Bora · T5 · T6 · T7 · LT · Golf 4 · 5 · 6 · 7 · Vento · Jetta · ID.3 · ID.4 · ID.5 • SEAT Toledo · León • ŠKODA Octavia · Fabia model year 1998 → · Roomster · Superb • PORSCHE Cayenne · Panamera · Cayman 718 • MULTICAR M27 4800-12A	161898
Radiator adapter for • VW Sharan • FORD Galaxy • SEAT Alhambra 4800-13A	161904
Radiator adapter for • MERCEDES-BENZ Type 168 · 169 (A-Class) · 245 (B-Class) · CDi · 220 · 129 4800-14	079018
Radiator adapter for • MERCEDES-BENZ Type 202 / 203 (C-Class) · Type 204 (C-Class) · Type 124 / 210 / 211 (E-Class) · Type 129 / 220 (S-Class) · Type 164 (M-Class) · Type 251 (R-Class) Sprinter model year 2018 → 4800-15	079025

4800 Radiator adapter

HAZET No.	EAN-No. 4000896+
Radiator adapter (with bayonet fitting) for • Passenger cars: – MINI model year 2001 → – MERCEDES-BENZ SLK · CLK · Sprinter model year 1999 → type 170 · 208 · 611 and W124 model year 1984 → 1993 • Commercial vehicles / agricultural machinery – DEUTZ Engines KHD1015 · D2008 · D2009 · TD2.9 L4 · TCD3.6 · BFM1013 · BFM2012 · TCD2013 2V · BFM1015 · TCD2015 V8 · V6 · M · TCD 12.0 and 16.0 4800-16	098507
Radiator adapter for • OPEL/VAUXHALL Vectra C · Astra H · Astra J · Astra K · Meriva · Signum · Corsa D · Insignia • FIAT 500X • JEEP Compass · Renegade • ALFA ROMEO Giulia · Stelvio • JOHN DEERE – Tractors 5 Series · 6 Series · 7 Series · 8 Series · 9 Series – Forage Harvester 8000 · 9000 Series – Self-Propelled Sprayer R4040 · R4050 · R4140 · 4150 – Windrower W170 – Cotton picker CP690 – Excavator 160DLC – Crawler Dozer 700J – Wheel Loader WL53 · WL56 • HITACHI excavator ZAXIS 6 • HAGIE STS 10 · 12 · 14 · 16 4800-17	109661
Radiator adapter for • MERCEDES-BENZ Sprinter model year 2006 → · Viano model year 2003 → 4800-18	128815
Radiator adapter for • VW Crafter · MAN TGE 4800-19	128822
Radiator adapter for • MAZDA 3 • Volvo C30 · S40 model year 2004 → · V50 • Volvo commercial vehicles Scraper tractor dumpers • FORD Focus model year 2008 → · Fiesta model year 2008 → · C-Max · Galaxy model year 2006 → · Kuga and S-Max 4800-21 A	162185
Radiator adapter (with bayonet fitting) for • CITROËN C1 • DAIHATSU Cuore L201 · L501 · Move L601 • MAZDA 121 · Demio • MITSUBISHI Grandis model year 2004 → · L400 · Pajero Pinin / Sport · Space-Gear · Space-Runner · Space-Wagon • PEUGEOT 107 model year 2006 → • ROVER 600 • SUBARU B9 Tribeca · Justy • SUZUKI Alto • TOYOTA Aygo model year 2006 → · Celica · Corolla · Rav 4 · Starlet · Yaris 4800-22	144266
Radiator adapter (with bayonet fitting) for • DAIHATSU Standard • HONDA Accord · Civic · Legend • HYUNDAI · ISUZU commercial vehicles · KIA • MAZDA 323 · 626 model year → 2002 · 6 · MX5 · Premacy model year 2000 → · RX8 • MITSUBISHI Carisma · Eclipse · Galant · Lancer · Outlander · Pajero · Sigma · Spacewagon D model year 2003 → • MITSUBISHI commercial vehicles Fuso Canter • NISSAN 350Z · Almera · Maxima · Micra model year → 2004 · Terrano 2 · X-Trail · Forklifts • TOYOTA Avensis · Carina E • SUZUKI Baleno · Wagon-R • SUBARU Forester · Impreza · Legacy · Outback • OPEL/VAUXHALL Agila 1.0 and 1.2 l and • SMART Forfour • YALE GDP/ GLP 16-30 4800-23	144273
Radiator adapter for • For BMW : 1 Series (E87/F20) · 2 Series (F22) · 3 Series (F30) · 3 Series GT (F34) · 4 Series (F32/F33) · 5 Series model year 6/2003 → (E60/F12) · 5 Series GT (F07) · 6 Series model year 2004 → (E63/F12) · 7 Series (E65/F01) · X1 (E84) · X3 model year 2010 → (F25) · X4 model year 2013 → (F26) · X5 model year 2013 → (F15) · X6 (E71) · Z4 model year 2013 → (E89) 4800-24	203864



4800 Universal adapter

Made in Germany

- Application: Checking for leakage in cooling systems and heating circuits



HAZET No.	EAN-No. 4000896+
<ul style="list-style-type: none"> For radiator openings \varnothing 20–41 mm With 3-stage rubber for rough and precise adjustment 4800-30	078202
<ul style="list-style-type: none"> Especially for Japanese vehicles \varnothing 18–24 mm All current MAZDA models V-clamp fastening 4800-31	078196

4795 Engine leakage tester

Made in Germany

- Easy application, immediate test result



- Application: For the diagnosis of engine defects, e.g. on inlet and exhaust valves, pistons/piston rings and cylinder head/cylinder head gasket



HAZET No.	l mm	EAN-No. 4000896+
4795- 1	–	083770
<ul style="list-style-type: none"> Adapter for motorcycles Thread M12x1.25 (outside thread) 4795-11	–	083787
<ul style="list-style-type: none"> Adapter for motorcycles and diesel engines Thread M10x1 (outside thread) 4795-12	–	083794
<ul style="list-style-type: none"> Adapter for diesel engines Thread M24x2 (outside thread) 4795-13	–	083800
<ul style="list-style-type: none"> Adapter for VW diesel engines including 4795-11 Pin \varnothing 7 mm 4795-14	–	083817
<ul style="list-style-type: none"> Adapter for multi-valve engines Thread M14x1.25 4795-15	165	104345
<ul style="list-style-type: none"> Adapter for multi-valve engines Spark plug thread M12x1.25 (14 mm spark plugs) 4795-16	230	215140

4810 C Optical tester (refractometer)

Made in Germany



- Application: For testing the anti-freeze concentration in the coolant, also suitable for coolants G11, G12++, G12 EVO, G13, G40, G48 and G64
- For testing the quality of AdBlue solution
- For testing the battery acid concentration (state of battery charge)

- Optical tester (refractometer) with integrated lighting (LED) in the lid
- Incl. pipette and operating instructions

Description of scales:

- A – State of charge
- B – AdBlue concentration
- C – Anti-freeze concentration
- D – Screenwash anti-freeze concentration
- 5 – Light / dark line for reading the scale

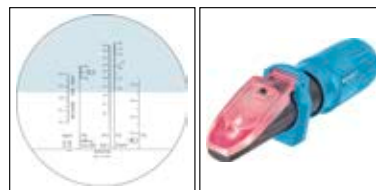

HAZET No.	EAN-No. 4000896+
4810 C	186402

4800 Cylinder head leakage tester

Made in Germany



- For radiator adapter HAZET 4800

- Application: Reliable detection of cylinder head damage and leakages between the combustion chamber and the cooling system on water-cooled combustion engines **gas, diesel, petrol**
- Reaction fluid included



HAZET No.	EAN-No. 4000896+
4800-41	058891
<ul style="list-style-type: none"> Reaction fluid (250 ml) For HAZET cylinder head leakage tester 4800-41 4800-041	108985





4793 Cylinder head tightness tester

Made in Germany

- Application: Detecting cylinder head gasket defects, leaks between the combustion chamber and the cooling system
- For water-cooled combustion engines (gas, diesel and petrol)
- Plastic box 165-L (1/3)
- 2-component soft foam insert



YouTube Clip

HAZET No.	L x W x H mm		EAN-No. 4000896+
4793/3	320x128x58	3	076192
• Tester			
4793-1	-	-	076185
• Reaction fluid (250 ml)			
4793-2	-	-	076208
• Flushing fluid (250 ml) for cleaning the tester 4793-1			
4793-3	-	-	076215

4803 Releasing tool · coolant expansion tank cover · VAG

Made in Germany

- **Exact fit of releasing tool avoids damage to the cover**



- Application: Problem-free loosening of very tight lids on the VAG coolant expansion tank
- For **VW** and Group vehicles as well as electric and hybrid models (MQB platform model year 2013→)
- Manual operation is only possible with great difficulty due to the geometric shape / low overall height of the cover and the recessed seat in the expansion tank



HAZET No.	∅ mm	EAN-No. 4000896+
4803-1	108	250158

Exhaust system / Lambda probe

4684 Exhaust equipment tool

Made in Germany

- Hook 40 mm, bent 9°

- Application: **Installation and removal of rubber retainers of the exhaust systems** e.g. for **FORD** Fiesta, Orion, Escort, **BMW** etc.
- 2-component T-handle
- Surface: chrome-plated



HAZET No.	l mm	EAN-No. 4000896+
4684-1 A	209	249305

4684 Exhaust equipment tool

Made in Germany

- Hook 17 mm, half-round, 20° offset

- Application: **Installing and removing rubber retainers of the exhaust systems** e.g. for **VW** · **AUDI** · **MERCEDES-BENZ** · **OPEL/VAUXHALL**, Japanese cars etc.
- 2-component T-handle
- Surface: chrome-plated



HAZET No.	l mm	EAN-No. 4000896+
4684-2 A	209	249282

4682 Chain tube cutter

- **Easy adjustment due to thumb screw during cutting process**



- Application: **Cutting of pipes**, e.g. made of steel (not stainless steel) up to 2.5 mm wall thickness and 75 mm ∅
- Extended cutting diameters are achieved by using extension chain HAZET 4682-01
- Little effort, fixed with **Grip technique**
- Surface: nickel-plated



HAZET No.	l mm	∅ mm	EAN-No. 4000896+
4682	255	15–75	022168
• Spare chain for 4682			
4682-01	-	-	022175
• Replacement set · 9 pieces for repairing the cutting chain 4682-01 For 4682			
4682-01/9	-	-	057214



Specialty tools

Engine – Exhaust system / Lambda probe



4682 Chain tube cutter

- Easy adjustment due to thumb screw during cutting process



- Application: **Cutting pipes** made of galvanized steel, copper, PVC and aluminium up to a wall thickness of 6 mm and 115 mm \varnothing
- 15 cutting wheels made of alloyed steel
- Surface: nickel-plated



HAZET No.	l mm	\varnothing mm	EAN-No. 4000896+
4682-1	315	20–115	149384
• Spare chain for 4682-1			
4682-03	–	–	149421

850 LG-GE 1/4" Socket · TORX®

Germany Made in Germany

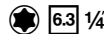

- Application: Operation of the oil pan screw connection in the engine and automatic gearbox.
Removal of the EGR radiator, EGR valve, valve cover etc. in **MERCEDES-BENZ** etc. in the OM 651 engine
Removal of the gearbox holder no longer required, time reduction: approx. 20 minutes
Much better accessibility to the screw connection on EGR valve and radiator enables further time reduction of approx. 15 minutes
- Socket and extension permanently connected
- With hinge – for working in areas with restricted access and for getting around obstructive edges
- Surface: chrome-plated, polished

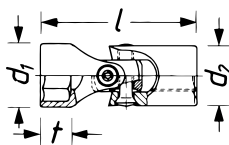

HAZET No.	s	l mm	d ₁ mm	d ₂ mm	t mm	EAN-No. 4000896+
850 LG-GE 10	E10	150	12	13.5	9.42	223572

4680 1/2" Lambda probe socket

Germany Made in Germany

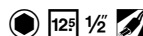

- For **lambda probes** on **NISSAN · FORD · VOLKSWAGEN · SEAT · ŠKODA** etc.
- Optimal fit to the 6-point profile of the lambda probe
- Long design
- Surface: chrome-plated



HAZET No.	s mm	l mm	d ₁ mm	d ₂ mm	EAN-No. 4000896+
4680-1	22	92	30.4	25	165605

4680 1/2" Lambda probe socket

Germany Made in Germany

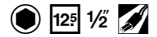

- Application: **Lambda probe** (s 22 mm) on **MERCEDES-BENZ** NOX sensors **MERCEDES-BENZ** Actros MP 5
- Long design
- Surface: chrome-plated



HAZET No.	s mm	l mm	d ₁ mm	d ₂ mm	EAN-No. 4000896+
4680-2	22	110	36	30	022090

Germany Made in Germany

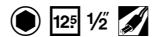

- Choice of \square drive 12.5 = 1/2" or \bullet 32 mm

- Application: Lambda probe (s 22 mm) on **VW, AUDI**
- Long design
- Surface: chrome-plated



HAZET No.	s mm	l mm	d ₁ mm	d ₂ mm	EAN-No. 4000896+
4680-3	22	110	41	34.4	022106

4680 Exhaust probe socket

Germany Made in Germany



- **Robust design for fixed exhaust gas probes**

- Application: Operation of the lambda probe, particle sensor, NOX sensor and exhaust gas temperature sensor
- Double square drive 12.5 = 1/2"
- Additional hexagon drive
- Also suitable for closing the slot to avoid widening the opened hexagon
- Torque-controlled tightening possible
- Slot width: 8 mm
- Blister packed
- Surface: phosphatized, oiled
- On e.g. **FORD · BMW · OPEL/VAUXHALL · VW · AUDI · SEAT and ŠKODA**
- Double \square drive 12.5 = 1/2" or operation with hexagon drive s 30 mm



YouTube Clip



HAZET No.	s mm	l mm	EAN-No. 4000896+
4680-5	22	66	057870



Gearbox

2174 Clutch centring tool

- No need to centre the clutch plate over the needle bearing



- Application: Precise centring and installation of the clutch plate to the clutch pressure plate
- Quick and easy installation
- Also suitable for vehicles **without** clutch guide bearings
- For passenger cars and lightweight commercial vehicles
- With 2 collets:
 - size 1 = 15-21 mm \varnothing
 - size 2 = 21-28 mm \varnothing
- Plastic with metal tightening screw



HAZET No.	EAN-No. 4000896+
2174	013609

880 GZ 3/8" Universal joint socket · 12-point

Made in Germany

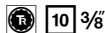

- Application: Operation of gearbox fitting (12-point screws) on **AUDI** vehicles model year 2008 → e.g. A4, A5, A6, A7, A8, Q5, Q7
- With hinge – for working in areas with restricted access and for getting around obstructive edges
- With locking ball
- Surface: chrome-plated, polished



880 GZ 3/8" Universal joint socket · 12-point

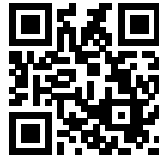

YouTube Clip

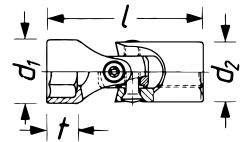

HAZET No.	l mm	d ₁ mm	d ₂ mm	t mm	EAN-No. 4000896+
880 G-Z 16	45.8	22	19	10	203734
880 G-Z 18	46.8	24.5	19	11	203529

2756 1/2" Screwdriver socket

Made in Germany

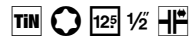

- Blade length of the **TORX**® screwdriver socket is precisely adapted to the available spatial conditions, screwing in a linear motion is thus achieved and the socket is not in direct contact with the cardan shaft flange

- Application: Operation of the cardan shaft screw connection on the gearbox of **MERCEDES-BENZ** GLC (X253) model years → 2015, GLC Coupé (C253) model years → 2016 with 4Matic
- With locking ball
- Surface: TIN coated

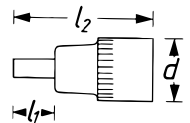

HAZET No.	s	l ₁ mm	l ₂ mm	d mm	mm	EAN-No. 4000896+
2756-T60	T60	65	103	24.6	13.25	204243

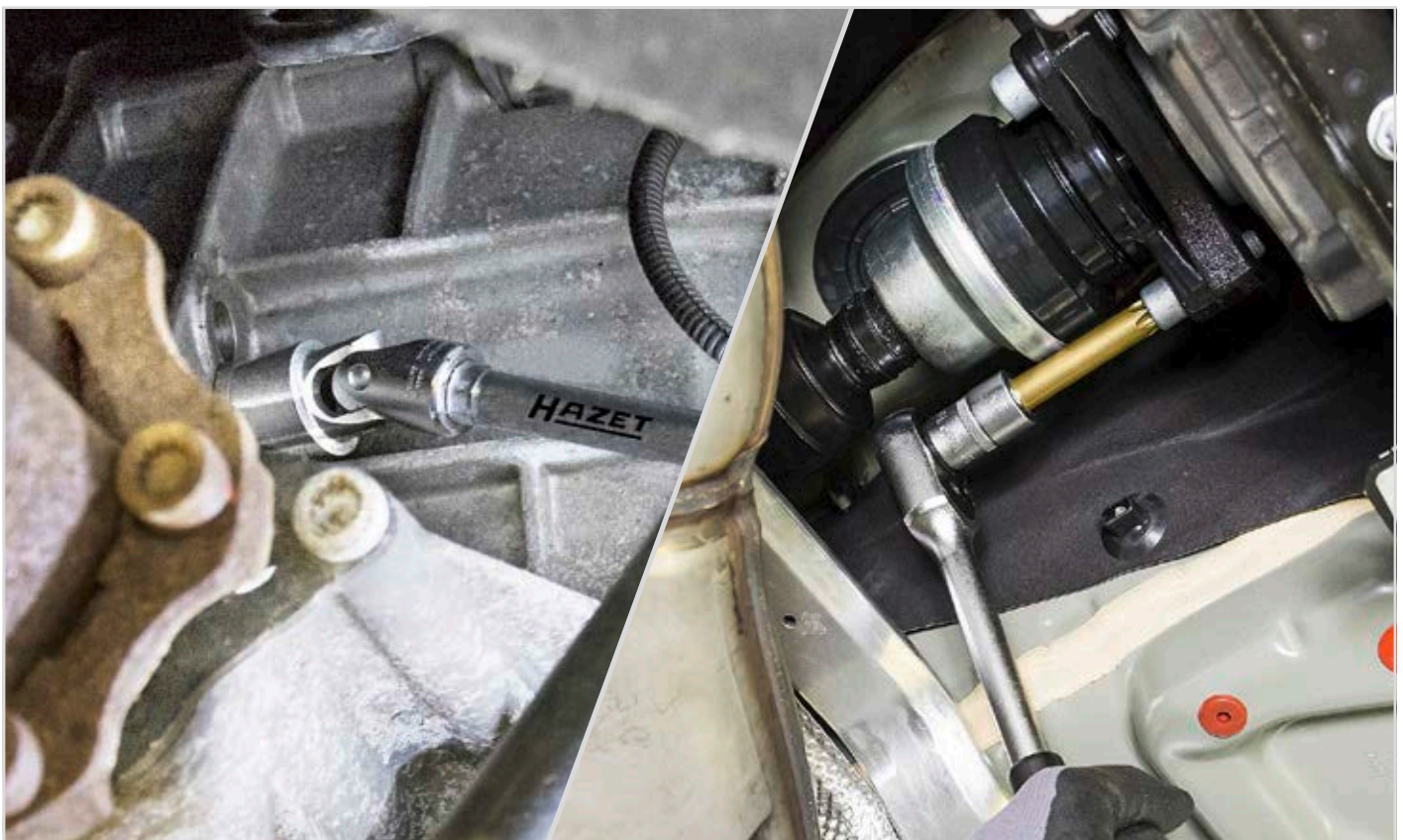



Specialty tools

Oil service



Oil service

Overview of oil filter wrenches

HAZET No.	Design points / grooves	Oil filter \varnothing mm	Oil filter wrench outside dimensions \varnothing mm	Insert depth Wrench mm	Total height mm	Drive		Page
						\varnothing mm	\square	
2168-46	6-Point	46	59	15	29	—	$10 \frac{3}{8}$	485
2169	14-Point	74	82	30	52	27	$10 \frac{3}{8}$	435
2169-1	15-Point	92	102	19	48	27	$12 \frac{25}{32}$	435
2169-6	16-Point	86	97	44	55	24	$12 \frac{25}{32}$	436
2169-7	14-Point	64	76	23	43	24	$12 \frac{25}{32}$	436
2169-8A	15-Point	74	105	—	38	—	$12 \frac{25}{32}$	437
2169-9	15-Point	105	119	36	52	24	$12 \frac{25}{32}$	487
2169-10	14-Point	74	82	20	42	27	$10 \frac{3}{8}$	435
2169-11	14-Point	84	97	30	48	24	$12 \frac{25}{32}$	436
2169-12	15 Grooves	74	107	—	38	—	$12 \frac{25}{32}$	437
2169-13	14-Point	80	107	—	38	—	$12 \frac{25}{32}$	437
2169-14	14-Point	72	104	—	38	—	$12 \frac{25}{32}$	437
2169-15	8-Point	75	105	—	38	—	$12 \frac{25}{32}$	437
2169-32	6-Point	32	43	18	30	—	$10 \frac{3}{8}$	436
2169-36	6-Point	36	49	15	29	—	$10 \frac{3}{8}$	436
2169-66	6 Grooves	66	76	23	43	24	$12 \frac{25}{32}$	436
2169-76	6 Grooves	76	85	21	42	24	$12 \frac{25}{32}$	436
2169-76B	6 Grooves	76	85	21	42	24	$12 \frac{25}{32}$	436
2169-76K	6 Grooves	76	85	14	34	24	$12 \frac{25}{32}$	436
2169-86	9 Grooves	86	97	24	44	24	$12 \frac{25}{32}$	436

Product applications

Oil service
hazet.de → Service → Tool Finder
 → Oil service

◀ For Smartphones with QR reader (app)

2169 Oil filter wrench

Made in Germany

- Application: Operating oil filters and oil filter housing caps
- 14-point ≤ 74.4 mm
- Drive $10 = \frac{3}{8}$ " or outside hexagon: 27 mm



HAZET No.	\varnothing mm	\varnothing mm	EAN-No. 4000896+
-----------	------------------	------------------	------------------

• For MANN and KNECHT filters · OPEL/VAUXHALL Longlife filters e.g. for MERCEDES-BENZ passenger cars with 2.2 l CDI engine · M 102 · M 103 · M 104 · M 110 · M 111 · M 119 · M 120 · M 613 · Sprinter · 2.2 l Turbo model year 2006 → diesel engine OM 651
 AUDI A4 2.0 model year 2002 → A4 4-cylinder petrol engines model year 12/2007 →
 BMW passenger cars · BMW motorcycles · K-models = K 75-1100 LT · Model series F and K
 VW Passat 1.9 TDI pump injector · Passat B7 1.4 · 1.8 · 2.0 l TSI · Golf Plus 2.0 model year 2005 → Golf 6 1.6 l and 1.2 / 1.4 / 1.8 / 2.0 l TSI · Golf 7 1.2 - 1.4 l TFSI · Polo 5 1.2 l - 1.4 l TSI · Tiguan model year 2007 → 1.4 l TSI (110 kW) 2.0 l TSI
 as well as FORD · OPEL/VAUXHALL · PORSCHE · PEUGEOT · CITROËN · RENAULT · NISSAN · TOYOTA · MAZDA etc.

2169	27	82	013340
------	----	----	--------

2169 Oil filter wrench

◀ $10 \frac{3}{8}$

HAZET No.	\varnothing mm	\varnothing mm	EAN-No. 4000896+
-----------	------------------	------------------	------------------

- Operating the oil filter housing cap when changing the oil filter element on MAZDA 3 with 2.0 l engine and 6 with 1.8–2.0–2.3 l engines
- Flat style: continuous 14-point profile up to the edge

2169-10	27	82	108831
---------	----	----	--------

Made in Germany

- Optionally, □ drive $12.5 = \frac{1}{2}$ " or outside hexagon 27 mm

Application: Operation of oil filters (KNECHT and MAHLE filters) 15-point ≤ 92 mm

- For e.g. VW · AUDI Passat 1.9 TDi · 2.8 l · CHRYSLER 300 M · PORSCHE · OPEL/VAUXHALL · RENAULT · FORD Focus 1.8 Di model year 08/1999 → 1.8 TDi model year 10/1998 → Maverick 2.7 TD · Mondeo 2.5 l · MITSUBISHI · NISSAN · ALFA-ROMEO · HONDA · Volvo · MAN (commercial vehicles) F 2000

HAZET No.	\varnothing mm	\varnothing mm	EAN-No. 4000896+
2169-1	27	102	013357



2169 Oil filter wrench

- Made in Germany**
- Forged design

- Application: Installing and removing oil filters and oil filter housing caps when changing the oil filter element
- Surface: chrome-plated

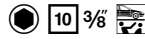

YouTube Clip

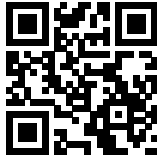

HAZET No.	mm	mm	EAN-No. 4000896+
6-point s 32 mm			
OPEL/VAUXHALL Astra · Corsa · 1.9 I CDTi · Astra 2.0 CDTi VW Passat · Golf 6 with 1.6 and 2.0 CR-TDI · Passat B7 1.6 · 2.0 diesel engine · Golf 7 2.0 petrol engine · Polo 5 1.2 I-1.4 I TDI · Polo 1.2 I petrol engines model year 2005 → · Transporter T5 1.9 I diesel model year 2004 → · Touran TDi · Tiguan model year 2007 → 1.4 I (90/118kW) 2.0 I diesel engines · AUDI A6 3.2 I TSI · V6 model year 2004 → · A4 diesel from model year 12/2007 BMW 530d M57 model year 2008 → For urea solution filter Ad-Blue® MAN e.g. TGX			
2169-32	32	43	082346
Hexagon s 36 mm			
e.g. for MERCEDES-BENZ engine 116 MB · 100 D Transporter · Actros MP 1 · MP 2 · BMW M 52-6-cylinder: 3 Series · 5 Series · M 60-8-cylinder: 5 Series · 7 Series · 8 Series · M 73-12-cylinder: 7 Series · 8 Series · 1 Series (E87): 118d · 120d · 1 Series (F20) 118i · OPEL Vectra B DI 16 V · Insignia · VW Lupo 1.2 TDi · Polo 5 1.2 I · Golf 6 1.4 I SRE/TSI · Touareg TDi · T.5 2.5 D · Passat B7 3.6 I FSI · AUDI 6-cylinder petrol engines model year 2004 → 2018 For fuel filters MAN e.g. TGA			
2169-36	36	49.5	086566

- Made in Germany**

- Application: Operating oil filters and oil filter housings made of plastic
- Drive 12.5 = 1/2" or outside hexagon: 24 mm

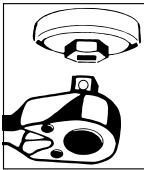
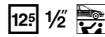

HAZET No.	mm	mm	EAN-No. 4000896+
16-point s 86 mm			
For e.g. BMW 316i Limousine Touring · 316ti Compact · 318Ci convertible · Coupé · 318i Limousine Touring · Compact model year 2001 → · 1-series (E87): 116i · 118i · 120i · 130i Volvo V40 · V70 · S40 · S60 · S70 · S80			
2169-6	24	97	100293
For the operation of oil filters 14-point s 64 mm on TOYOTA Yaris · Corolla · MR2 model year → 1999 · Starlet · Celica · Avensis NISSAN Micra · Almera MAZDA 323 · 626 · MX-5 · Xedo MERCEDES-BENZ A-Class (type 177), B-Class (type 247) with OM 608 engine SMART ForFour (type 454) engine 134 · 135 · SMART Fortwo (type 451) engine 132 · and SUBARU · SUZUKI · DAIHATSU Also suitable for YAMAHA Super Ténéré XT1200 z · YZF-R1 model year 2007 → · YZF-R6 model year 2006 → · FZ1-S model year 2006 · FZ1-N model year 2006 → · FZ6-S model year 2007 → · FZ6-N model year 2007 BMW G310R and G310GS			
2169-7	24	76	100224
14-point s 84 mm			
Operation of plastic oil filter housings e.g. on- MERCEDES-BENZ V6 diesel engines OM642 among others for 164 · 203 · 204 · X204 · 210 · 212 · 639 Operation of fuel filter housing cover on MERCEDES-BENZ type 213 with OM 654			
2169-11	24	97	118847

2169 Oil filter wrench

- Made in Germany**

- Application: Operating Purflux oil filters
- 12.5 = 1/2" or outside hexagon: 24 mm

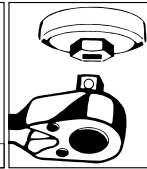
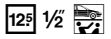

HAZET No.	mm	mm	EAN-No. 4000896+
s 66 mm groove profile (6 grooves)			
RENAULT Clio, Twingo (also operation of the oil filter housing cap) · Kangoo, FIAT Punto · Stilo · Brava · Bravo with 1.2 I, LANCIA Y 1.2 I, MAZDA 323 · 626 · MX 3 · Xedos, MITSUBISHI Colt · Carisma · Space Star, NISSAN Micra · Primera · Serena, TOYOTA Yaris · Starlet, MR 2 · Corolla · Carina · Avensis			
2169-66	24	76	100217
s 76 mm groove profile (6 grooves)			
For e.g. AUDI A3 · A4 · A6 · CITROËN C5 · Xantia · DACIA · FIAT Brava · Bravo · Punto · Tipo · FORD Fiesta · Escort · MERCEDES-BENZ passenger cars and Sprinter · e.g. Citan 1.5 I Diesel · A-Class · B-Class · PEUGEOT 106 · 206 · 306 · 406 · RENAULT Clio · Kangoo · Mégane · Laguna · Rapid · HONDA Accord · Civic · Prelude · CRX · OPEL/VAUXHALL Astra G/F · Corsa A/B · Calibra · Zafira · Frontera · SUZUKI Grand Vitara 1.9D model year 2009 VW Golf 3 and 4 · Polo · Passat · Sharan · SEAT Alhambra · Toledo · León · Córdoba · SKODA Octavia for fuel filters e.g. for RENAULT Espace · Laguna · R19 · Volvo S 40 and V 40 model year → 1999			
2169-76	24	85	100309
Especially for BMW motorcycles			
s 76 mm groove profile (6 grooves), reduced height			
For new BMW motorcycles R1200 GS · R1200 R · R1200 RT · R1200 ST · model years 2004 → 2012			
SMART 453			
2169-76 K	24	85	158188
s 86 mm groove profile (9 grooves)			
For e.g. ALFA ROMEO 145 · 146 · 156 1.9 JTD · 156 2.4 JTD · VW Golf 3 · Sharan · Vento · Passat with TDi engine · Lupo · Polo 1.7 SDi · AUDI A4 · A6 with TDi engine 85 KW/115 PS · FIAT Bravo and Brava 1.9 JTD · RENAULT Clio · R 19 with 1.4 – 1.7 and 1.8 I · Mégane 1.4 and 2.0 I · Rapid with 1.9 D · Laguna · Safrane and Espace 3 with 2.1 D · SEAT Alhambra · 1.9 TDi · Arosa 1.7 SDi · SUZUKI Grand Vitara 1.9 DDIS for fuel filters e.g. MERCEDES-BENZ Vito · Sprinter · A-Class (type 168) · C-Class (type 202) · E-Class (type 210)			
2169-86	24	97	100323

- Made in Germany**

- Application: Operating Purflux oil filters
- 12.5 = 1/2" or outside hexagon: 24 mm

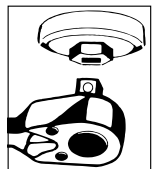
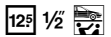

- s 76 mm groove profile (6 grooves)**
- Safe, non-conductive protective coating against danger of short circuit: In some RENAULT, e.g. K9K engine, the oil filter is located close to the alternator or the starter
- Eye-catching coat colour reduces the risk of it being left in the engine compartment after operation
- For e.g. AUDI · CITROËN · DACIA · FIAT · FORD · MERCEDES-BENZ · NISSAN · PEUGEOT · RENAULT · HONDA · OPEL/VAUXHALL · SUZUKI · VW · SEAT · SKODA



HAZET No.	mm	mm	EAN-No. 4000896+
2169-76 B	24	85	230259



Specialty tools

Oil service



2169 Oil filter wrench

- Application: Operating oil filters and oil filter housings
- Positive mounting of the oil filter housing
- Controlled screw tightening with torque wrench to the torque required by the manufacturer
- □ Drive 12.5 = 1/2"

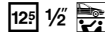

15-point s 74 mm

Operation of oil filters

FORD models e.g. EcoBoost engines among others B-Max · C-Max 2 · Fiesta 5-6-7 · Focus 2-3 · Fusion · Galaxy · Mondeo 4-5 · Tourneo · Transit, Ka+ · Kuga 2 · S-Max

MAZDA 2 (DL, DJ) 1.5D · 3 (BK, BL) 2.0 (BM, BN) 1.5D - 2.2D (BP) 1.8D · 5 (CW) 1.8-2.0 · 6 (GG) 1.8-2.0 (GY, GH) 1.8-2.0-2.5 (GJ, GL) 2.2D · CX-3 (DK) 1.5D-1.8D · CX-5 (KE, GH, KF) 2.2D · CX-7 (ER) 2.3D-2.5D · MX-5 (NC) 1.8-2.0



HAZET No.	Ø mm	EAN-No. 4000896+
2169-8A	105	232956

Made in Germany

- Application: Operating oil filters and oil filter housings
- Positive mounting of the oil filter housing
- Controlled screw tightening with torque wrench to the torque required by the manufacturer
- □ Drive 12.5 = 1/2"

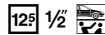

15 grooves s 74 mm

Operation of oil filters

OPEL/VAUXHALL models

Astra K · Insignia B with 1.5 diesel engines F15DVC · F15DVH with 77KW / 90KW



HAZET No.	Ø mm	EAN-No. 4000896+
2169-12	107	241798

Made in Germany

- Application: Operating oil filters and oil filter housings
- Positive mounting of the oil filter housing
- Controlled screw tightening with torque wrench to the torque required by the manufacturer
- □ Drive 12.5 = 1/2"

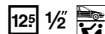

14-point s 80 mm

Operation of the oil filters in

Hyundai i30 · Tucson **KIA** Ceéd · Sportage · Soul · Stonic with 1.6 CRDI engine



HAZET No.	Ø mm	EAN-No. 4000896+
2169-13	107	241859

Made in Germany

- Application: Operating oil filters and oil filter housings
- Positive mounting of the oil filter housing
- Controlled screw tightening with torque wrench to the torque required by the manufacturer
- □ Drive 12.5 = 1/2"

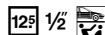

14-point s 72 mm

Operation of oil filters

FORD 1.0l / 1.1 l and 2.0 l EcoBoost engines B-Max · C-Max · EcoSport · Fiesta · Fiesta · Active · Focus · Grand C-Max · Grand Tourneo · Connect · Mondeo · S-Max · Galaxy · Tourneo Connect · Tourneo Courier · Transit Connect · Transit Courier



2169 Oil filter wrench

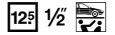

HAZET No.	Ø mm	EAN-No. 4000896+
2169-14	104	244195

Made in Germany

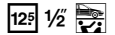

- Application: Operating oil filters and oil filter housings
- Positive mounting of the oil filter housing
- Controlled screw tightening with torque wrench to the torque required by the manufacturer
- □ Drive 12.5 = 1/2"

8-point s 75 mm

Operation of oil filters and oil filter housings, especially for

FIAT 500 · 500C · Panda · Bravo · **LANCIA** Ypsilon · **ALFA ROMEO** 147 and the 1.0 l mild hybrid engines 1.2 l, 1.9 D Multijet · 1.9 JTD



HAZET No.	Ø mm	EAN-No. 4000896+
2169-15	105	247066

2169 Oil filter wrench set

Made in Germany

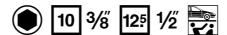

Operating oil filters and oil filter housings made of plastic

- Fast application, safe, appropriate and clean working
- The torque value recommended by the vehicle manufacturer can be safely achieved, e.g. with the HAZET 6110-1CT (10 = 3/8") and HAZET 6121-1CT (12.5 = 1/2") torque wrenches
- **Attention:** Follow vehicle manufacturer's specifications concerning torque tightening values
- Oil filter wrench set, contents: 2169 · 2169-1 · 2169-6 2169-36 · 2169-76 · 2169-86



HAZET No.	Ø mm	EAN-No. 4000896+
2169/6	6	120628

2170 Universal strap wrench

Made in Germany



- Especially for oil filters, generators and other round screwed connections
- Cotton textile tape, rubber coated, height 19.5 mm
- Non-skidding
- Surface: chrome-plated



HAZET No.	l mm	Ø mm	EAN-No. 4000896+
2170	235	80-180	013371



2171 Oil filter wrench

- Adjustable by turning knob or 6-point 13 mm



- Application: Operating oil filters even in areas with restricted access
- Replaceable steel strip (12x1 mm)



HAZET No.	Ø mm	EAN-No. 4000896+
2171-5	65-105	013449
2171-6	105-145	013456

2171 Oil filter chain wrench

Made in Germany

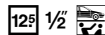

- The opening in the oil filter chain allows them to be used even in places which are difficult to reach due to the construction

- Application: Operation of oil filters and air dryer cartridges



YouTube Clip



HAZET No.	Ø mm	EAN-No. 4000896+
2171-8 LG	50-150	203703

Made in Germany

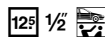

- Operation even in areas with restricted access

- Application: Operating oil filters and other cartridges on passenger and commercial vehicles
- With chain

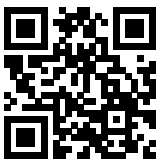

YouTube Clip

HAZET No.	Ø mm	EAN-No. 4000896+
2171-8	50-150	013463

2172 Oil filter wrench

Made in Germany

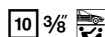

- For oil filters in areas with restricted access
- Left-hand and right-hand operation
- Universal application
- Drive 10 = 3/8" or ● 19 mm
- Forged design
- Surface: galvanised



2172 Oil filter wrench

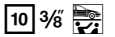

HAZET No.	Ø mm	EAN-No. 4000896+
2172	65-115	013470

2567 1/2" Oil service screwdriver socket

Made in Germany

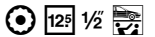

- Application: Gearbox oil change (XZN screw with journal guide)
- AUDI A2 · A3 · A4 · A6 · TT, VW Passat B5 · Golf 4 · LT · T4 · T5 ŠKODA Fabia · Octavia · Superb PORSCHE Boxster with gearbox FORD Galaxy 1.9 TDi with 6-speed gearbox
- With knurling
- Surface: chrome-plated



YouTube Clip

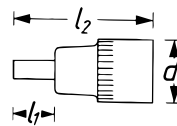

HAZET No.	l ₁ mm	l ₂ mm	EAN-No. 4000896+
2567-16	22	60	016419

2528 VAG oil drain plug special screwdriver bit

Made in Germany

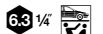

- Installing and removing the plastic oil drain plug with special profile on oil pans made of plastic
- Installation and removal of the plastic seal plugs in the camshaft-housing lid 1.6 · 2.0 TDI engines

- AUDI SEAT ŠKODA VW model year 2013 → with 1.2 · 1.4 · 1.8 · 2.0 TFSI petrol engines AUDI A1 · A3 · A4 · A5 · Q5 VW Golf 7 SEAT León · etc. with 1.6 and 2.0 l diesel engines



HAZET No.	l mm	EAN-No. 4000896+
2528-1	35	201372

2760 Oil service wrench

Made in Germany



- For oil filler screw on M8 gearbox
- Surface: chrome-plated
- Inside hexagon: 14 mm
- Outside hexagon: 17 mm



HAZET No.	S mm	l mm	EAN-No. 4000896+
2760	14x17	237	017638



Specialty tools

Oil service



3702 1/2" Oil service screwdriver socket

Made in Germany

- For the oil filler and oil drain plug gearbox, differential, oil pan
- Surface: chrome-plated
- 8 mm inside square
- For e.g. **MERCEDES-BENZ** type 415 (Citan) · type 177 (A-Class) · type 247 (B-Class) with OM 208 engine
- RENAULT**

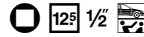

HAZET No.	S mm	l mm	EAN-No. 4000896+
3702	8	36	018918

3703 Oil service wrench

Made in Germany

- For the oil filler and oil drain plug gearbox, differential, oil pan on various French passenger cars
- 8 and 10 mm outside square
- Surface: chrome-plated



HAZET No.	S mm	l mm	EAN-No. 4000896+
3703	8x10	233	018932

198-10 Engine oil filling funnel

Made in Germany

- Replaceable adapter made of aluminium

- Easy installation on the engine of the vehicle
- Ensures the necessary slow, controlled filling of engine oil for some engines – saves time: other work can be done while the oil is draining
- Replaceable aluminium adapters for many common vehicle models
- Flexible use due to plug system
- With optional angle connection piece 198-12, also for hard-to-reach oil filling openings
- Special funnel made of sturdy plastic



198-10 Engine oil filling funnel

HAZET No.	1	2	EAN-No. 4000896+
-----------	---	---	------------------

For VW group vehicles of the MQB platform

- Necessary due to a smaller diameter of the oil filler plug
- **AUDI** A3 (8V) · **VW** Golf 7 · **SEAT** León (5F) · **ŠKODA** Octavia 3
- 2-part set, contents, special funnel 198-9 · oil filling adapter 198-7
- **Made in Germany**

198-9/2	1	2	186396
---------	---	---	--------

- Bayonet fitting, universal use e.g. on **AUDI** · **VW** · **SEAT** · **ŠKODA** · **MERCEDES-BENZ** etc.
- 2-part set, contents, special funnel 198-9 · oil filling adapter 198-10
- **Made in Germany**

198-10/2	1	2	187218
----------	---	---	--------

- **Oil filling adapter** for engine oil filling funnel 198-9, can be used in vehicles of the VW Group MQB platform
- AUDI** A3 (8V)
- VW** Golf 7
- SEAT** León (5F)
- ŠKODA** Octavia 3
- **Made in Germany**

198-7	-	-	187256
-------	---	---	--------

- **Special funnel** made of sturdy plastic
- Combination possible with oil filling adapters (198-7 · 10 · 13 · 14 · 15 · 16 · 17 · 18 · 19) also together with angle connection piece 198-12 (adapter and angle connection piece optionally available)
- **Made in Germany**

198-9	1	-	187249
-------	---	---	--------

- **Adapter with bayonet fitting** for engine oil filling funnel 198-9, can be universally used e.g. on **AUDI** · **VW** · **SEAT** · **ŠKODA** · **MERCEDES-BENZ** · **BMW** etc.
- **Made in Germany**

198-10	-	-	187263
--------	---	---	--------

- **Angle connection piece** for hard to reach oil filling openings
- **Made in Germany**

198-12	-	-	206766
--------	---	---	--------

- **Oil filling adapter** for engine oil filling funnel 198-9, can be used in engines: **OPEL/VAUXHALL** · **RENAULT**: G9Q-T-U
- NISSAN** · **OPEL/VAUXHALL** · **FIAT** · **RENAULT**: R9M
- MERCEDES-BENZ**: C-Class type 205, GLC type 253 with OM 626, Vito type 447 with OM 622
- DACIA**: H5F · K7M · K4M · D4F · K7J · K4M · H4B · D4F
- **Made in Germany**

198-13	-	-	206773
--------	---	---	--------

- **Oil filling adapter** for engine oil filling funnel 198-9, can be used in **MERCEDES-BENZ** engine
- M270: A-Class type 176 · B-Class type 246
- M271: C-Class type 203, 209, 204 · E-Class type 211, 212, 207 · SLK type 171, 172 · Sprinter type 906
- **Made in Germany**

198-16	-	-	206803
--------	---	---	--------

- **Oil filling adapter** for engine oil filling funnel 198-9, can be used in **MERCEDES-BENZ** engine
- OM 654: A-Class, type 177 · B-Class, type 247 · C-Class, type 205 · E-Class, type 213 · V-Class, type 447
- M 282: A-Class, type 177 · B-Class, type 247
- **Made in Germany**

198-17	-	-	206827
--------	---	---	--------

- **Oil filling adapter** for engine oil filling funnel 198-9, can be used in **MERCEDES-BENZ** engine
- OM 607: type: 415 Citan, 176 A-Class, 246 B-Class, 117 CLA, X156 GLA · **RENAULT** engine K9K
- **Made in Germany**

198-18	-	-	219179
--------	---	---	--------

- **Oil filling adapter** for engine oil filling funnel 198-9, can be used in 1.5 TSI VW Group engine

- AUDI** A1 model year 11/2018 → A3 model year 05/2017 → Q2 model year 11/2018 → Q3 model year 09/2018 →
- SEAT** Arona model year 11/2017 → Ibiza model year 08/2017 → León 3 model year 09/2018 → Tarraco model year 10/2018 → Ateca model year 10/2018 →
- ŠKODA** Karoq 07/2017 → Octavia 3 model year 08/2017 → Superb 3 model year 10/2018 →
- VW** Arteon model year 11/2018 → Golf 7 model year 03/2017 → Golf Sportsvan 10/2017 → Polo 6 model year 09/2017 → T-Roc model year 11/2017 → Passat B8 model year 10/2018 → Touran 2 model year 10/2018 →
- **Made in Germany**

198-19	-	-	226993
--------	---	---	--------



Brakes

163 Universal brake tool set

Made in Germany



1/3			
-----	--	--	--



- | | | |
|-----------------------|------------------------------------|--------------------------------|
| 751 KHS-3 | 8801K • O • $\frac{10}{16}$ 7 | 2784 • O • $\frac{10}{16}$ 7 |
| 751 KHS-4 | 986 • O • $\frac{10}{16}$ 9 | 2901 G • O • $\frac{10}{16}$ 7 |
| 748 LGB | 986 L • O • $\frac{10}{16}$ 9 • 11 | 4968-2 |
| 748 LGB-3 • 748 LGB-4 | | 4968-6 |
| 810 U-PH • PH3 | 2584-8 • O • $\frac{10}{16}$ 8 | |

HAZET No.	L x W mm		EAN-No. 4000896+
163-548/14	342x172	14	224197

2584-8 3/8" Brake calliper screwdriver socket

Made in Germany

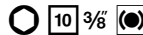

- Application: Operation of the brake calliper screw connection at the rear axle (s 8 mm) on: **AUDI TT** model year 2007 →, A4 model year 2001 →, A6 model year 2005 →, A8 model year 2003 →
- For controlled screw tightening please use torque wrench with drive 10 = $\frac{3}{8}$ ", e.g. HAZET 6110-1CT
- With fix blade (size 8 mm) for inside hexagon screws

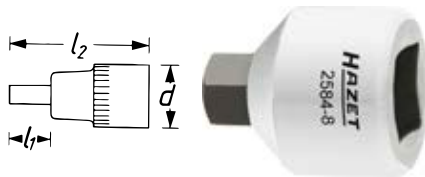

HAZET No.	S mm	l ₁ mm	l ₂ mm	EAN-No. 4000896+
2584-8	8	6.6	24	149438

2784 3/8" Brake calliper screwdriver socket

Made in Germany

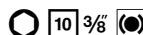

- Application: Operation of the guide bolts s 7 mm at the rear brake callipers on **MERCEDES-BENZ** type 204 (C-Class)
- For controlled screw tightening please use torque wrench with drive 10 = $\frac{3}{8}$ ", e.g. HAZET 6110-1CT
- With fix blade (size 7 mm) for inside hexagon screws

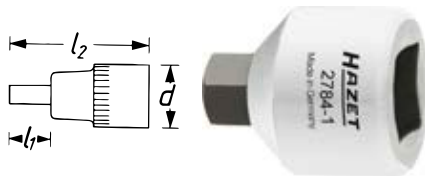

HAZET No.	S mm	l ₁ mm	l ₂ mm	EAN-No. 4000896+
2784-1	7	6.6	24	148530

2901 G 3/8" Brake calliper joint socket

Made in Germany

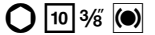

- Application: Rear brake calliper screws (s 7 mm) on **BMW** 3 • 5, and 8 Series • **VW** Golf 7 model year 2013 → • **AUDI** A3 model year 2013 → • **SKODA** Octavia model year 2013 → and **OPEL/VAUXHALL**
- With hinge – for working in areas with restricted access and for getting around obstructive edges



HAZET No.	S mm	l mm	EAN-No. 4000896+
2901 G-7	7	50	051816

Application chart for HAZET No. 4968 brake bleeding wrenches

	S mm				
BMW	7				
CITROËN		8	9		
DAIHATSU		8			
FIAT	7	8			
FORD	7	8	9	10	11
HONDA		8		10	
MAZDA		8			
MERCEDES-BENZ			9		11
MITSUBISHI				10	11
NISSAN				10	11
OPEL			9		
PEUGEOT	7	8	9	10	11
RENAULT	7	8	9		11

4968 Brake bleeding wrench set

Made in Germany



HAZET No.		EAN-No. 4000896+
4968 • ●		
7 • 8 • 9 • 10 • 11		
4968/5	5	086535



Specialty tools

Brakes



4968 Brake bleeding wrench

Made in Germany

- Equal hexagon size on both sides

- Application: **Brake bleeding without dismantling the wheels**, replacement of wheel brake cylinder, master brake cylinder and the tube connections
- Bent and offset
- Surface: chrome-plated



HAZET No.	S mm	l mm	EAN-No. 4000896+
4968- 7	7	190	085705
4968- 8	8	208	085699
4968- 9	9	208	085682
4968-10	10	236	085712
4968-11	11	236	085729

4963 Specialty tool for brakes

Made in Germany

- Push and turn-part with carbide coating layer in the front working area

- Application: Installation and removal of the spring plate and the holding device of the brake linings on drum brakes
- On e.g. **VW · SEAT · ŠKODA · OPEL/VAUXHALL and RENAULT** with rear drum brakes
- Plastic handle
- Surface: chrome-plated

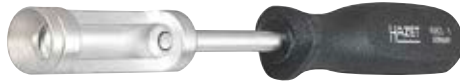

HAZET No.	l mm	EAN-No. 4000896+
4963-1	237	050383

4964 Draw spring assembly tool

Made in Germany

- Hook with T-handle

- Application: **Installing and removing the draw spring of hand brake shoes (rear disc brake)**
- On e.g. **MERCEDES-BENZ** passenger cars as well as Sprinter **VW Crafter** model year 2006 → 2016 and LT 1996 → 2006
- 2-component T-handle
- Surface: chrome-plated



HAZET No.	l mm	EAN-No. 4000896+
4964-1 A	162	249299

2191 Tube flaring tool set

Made in Germany

- For metal tubes and pipes with a wall thickness of 0.7 to 1.0 mm pipe Ø 4.75–10 mm

- Application: Making open (F) or twin (E) flares in accordance with DIN 74234, standard 90° and 180° flares
For flares on rolled and drawn pipes

- Replaceable, hinged gripping jaw
- Attention: for plastic-coated brake lines use HAZET 2193/4K**

- Special cast steel
- Plastic box 165-L (1/3)
- 2-component soft foam insert

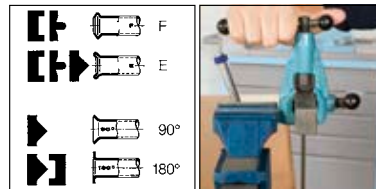

2181 N-1



2191-2



2191

2191-4 • 2191-5
2191-6 • 2191-8
2191-9 • 2191-10



2191-1



2191-3



2191-90

HAZET No.	L x W x H mm	□	EAN-No. 4000896+
2191/12K	290x173x50	12	013890

2191 Basic unit

Made in Germany

- Holding the gripping jaw 2191-1



HAZET No.	EAN-No. 4000896+
2191	013784

2191 Gripping jaw

Made in Germany

- Socket in basic unit 2191
- For E, F, 90° and 180° flares
- 4.75 up to 10 mm



HAZET No.	mm	EAN-No. 4000896+
2191-1	4.75–5–6–8–9–10 mm	013791



2191 Tube deburring tool

Made in Germany

- For tubes with outside \varnothing of 4-32 mm
- Application: For tube deburring



HAZET No.	\varnothing mm	EAN-No. 4000896+
2191-2	4-32	013814

2191 Base block

Made in Germany

- For E, F, 90° and 180° flares
- 4.75 up to 10 mm



HAZET No.	\varnothing mm	EAN-No. 4000896+
2191-3	4.75-10	013821

2191 Thrust block

Made in Germany

- For E and F-flares
- Surface: burnished, oiled

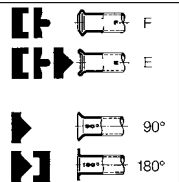

HAZET No.	\varnothing mm	EAN-No. 4000896+
2191-4	4.75	013838
2191-5	5	013845
2191-6	6	013852
2191-8	8	013869
2191-9	9	013876
2191-10	10	013807

Made in Germany

- For E and 90°, 180° flares 4.75 to 10 mm
- Surface: burnished, oiled

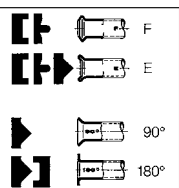

HAZET No.	\varnothing mm	mm	EAN-No. 4000896+
2191-90	4.75-10	($\frac{3}{16}$ "- $\frac{3}{8}$ ")	013883

2193 Tube flaring tool set

Made in Germany

- Application: Especially for F-flares on plastic-coated brake lines \varnothing 4.75 mm
- Plastic box 165-L (1/3)
- 2-component soft foam insert

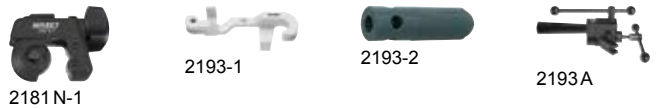

HAZET No.	L x W x H mm		EAN-No. 4000896+
2193/4K	290x173x50	4	014088

2193 Tube flaring tool

Made in Germany

- Especially for F-flares on plastic-coated brake lines \varnothing 4.75 mm

- Lightweight and easy to handle
- May be clamped into a machinist's vice, also allows manual operation under vehicles



HAZET No.	\varnothing mm	EAN-No. 4000896+
2193A	4.75	142538

2193 Replacement thrust block

Made in Germany

- Replacement thrust block with dowel pin for tube flaring tool 2193A



HAZET No.	EAN-No. 4000896+
2193/02	014071

2193 Bending tool

Made in Germany

- Application: Bending brake lines of 4.75 mm \varnothing



HAZET No.	\varnothing mm	EAN-No. 4000896+
2193-1	4.75	014057



Specialty tools

Brakes



2193 Tube deburring tool

Made in Germany

- Application: Inside and outside deburring of tubes



HAZET No.	Ø mm	EAN-No. 4000896+
2193-2	4.75	014064

4968 Brake calliper brush

Made in Germany

- Slim design

- Application: Removing stubborn brake dust and dirt from the disc brake calliper
- Plastic handle with suspension hole



HAZET No.	l mm	EAN-No. 4000896+
4968-2	225	084821

4968 Brass brake calliper brush

Made in Germany

- Soft brass bristles facilitate damage-free cleaning

- Application: Cleaning aluminium brake callipers
- Slim design – allows working in areas with restricted access
- Plastic handle with suspension hole



HAZET No.	l mm	EAN-No. 4000896+
4968-3	225	089147

4968 Brake calliper file

Made in Germany

- One-sided cut prevents damage to the dust boot at the brake piston

- Application: For removing stubborn brake dust, rust and dirt from the disc brake calliper
- 12 mm wide
- Blunt scraper on the face side for removing rough residues
- Cut of the file: coarse bevel cut on one side
- Plastic handle



Video

HAZET No.	l1 mm	l2 mm	EAN-No. 4000896+
4968-1	150	260	084739

4968 Brake calliper file

Made in Germany

- Extra slim style (width 10 mm), suitable for Japanese vehicles

- Application: For removing stubborn brake dust, rust and dirt from the brake calliper
- Blunt scraper on the face side for removing rough residues

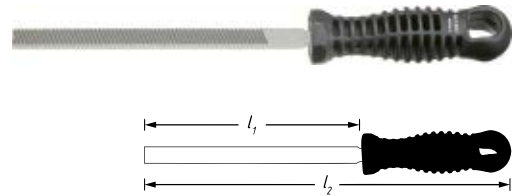

Video

HAZET No.	l1 mm	l2 mm	EAN-No. 4000896+
4968-5	155	265	129379

Made in Germany

- Extra slim design

- Application: For removing stubborn brake dust, rust and dirt from the brake calliper
- Square brake calliper file
- Very good service life
- 10 x 10 mm
- Plastic handle with hanging hole

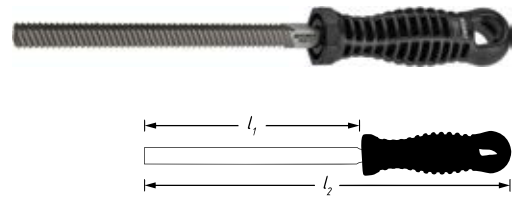

Video

HAZET No.	l1 mm	l2 mm	EAN-No. 4000896+
4968-6	155	265	218431

4968 Brake line scraper

Made in Germany

- Curved design enables work even in cramped and hard-to-reach areas

- Application: For removing dirt, underbody protection and rust from brake lines and for locating concealed corrosion areas
- For checking the condition of the brake line in the general inspection (HU)
- Application is possible with pulling or pushing
- Replaceable blade
- For brake line Ø 4.75 mm
- 2-component handle



HAZET No.	l mm	EAN-No. 4000896+
4968-12	245	219964
4968-012	-	229871



2582 Brake adjusting lever

Made in Germany

- Application: **Adjusting of drum brake shoes with eccentric**
- Adjusting handbrakes with eccentric
- Surface: chrome-plated



HAZET No.	l mm	EAN-No. 4000896+
2582	304	017027

2730 Hand brake shoe retaining spring tool

Made in Germany

- Tool is especially suited to areas with very restricted access

- Application: Operation of retaining springs of the hand brake shoes (rear disc brakes)
- **MERCEDES-BENZ V-Class** (Vito / Vitano) type 638 model year 1996 → 2003 · 639 model year 2003 → 2014 · 447 model year 2014 →
- The tool makes it easy to reach the retaining springs on the side behind the wheel hub, as operation through the borehole in the wheel hub is not possible for the above vehicle types
- T-handle with dip-coating



HAZET No.	l mm	EAN-No. 4000896+
2730-1	155	218400

Made in Germany

- Tool is especially suited to areas with very restricted access

- Application: Operation of retaining springs of the hand brake shoes (rear disc brakes)
- Universal application – e.g. on **BMW E36 · E46 · E39 · E60 · E85** (BMW models model year →2010)
- Easy access to the retaining spring laterally behind the hub, as operation through the borehole in the wheel hub is not possible with the above vehicle types
- T-handle with dip-coating

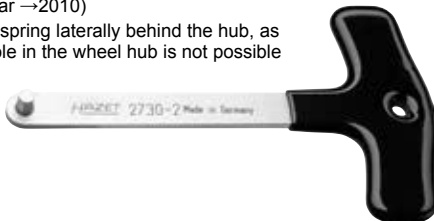

HAZET No.	l mm	EAN-No. 4000896+
2730-2	155	254286

Made in Germany

- Application: Operation of retaining springs of the hand brake shoes (rear disc brakes)
- **MERCEDES-BENZ** passenger cars · Sprinter, **VW Crafter**
- 2-component T-handle



HAZET No.	l mm	EAN-No. 4000896+
2730 A	142	249510

4954 Brake fluid tester

- **Portable** (for everywhere use) – to be connected to battery, replaces a stationary installation
Operating voltage 12 V
- **Boiling point tester** – higher testing accuracy in comparison to other testing methods
- **Time savings** - fluid can remain in the fluid reservoir on most vehicles
- **Safe and environmentally friendly**, since there is no loss of liquid
- Accepted by vehicle manufacturers
- Also meets the requirements of TÜV Austria
- For **DOT 3 · DOT 4 · DOT 4+ · DOT 5 · DOT 5+ brake fluid**
- **Easy application** – one push button
- No brake fluid selection necessary
- Warning when operating voltage is too low
- Cable length: 2.2 m
- **Test in °C and °F** – temperature range: 320° C / 608° F
Accuracy ±10° C
- **Quick diagnosis** – measuring duration: approx. 30 seconds
- Test container, syringe and operating instructions included in delivery
- Plastic box



HAZET No.	EAN-No. 4000896+
4954-2	229628

4956 Calliper gauge for brake discs

Made in Germany

- **Spherical measuring areas**



- Application: **Measuring the thickness of the brake discs** (wear/abrasion of the brake disc)
– follow the instructions of the manufacturer –
- Fixing screw and sliding vernier (vernier 1/10)
- In leather case
- For passenger cars and motorcycles
- Measuring range: 60 mm
- Jaw length: 75 mm



HAZET No.	EAN-No. 4000896+
4956-1	073160



Specialty tools

Brakes



4956 Calliper gauge for brake discs / thickness gauge

- Measurement without wheel removal
- Effortless measurement on the vehicle during direct receptions in the presence of the customer
- Measuring range: 0 – 60 mm (also suitable for application on commercial vehicles)
- Easy to handle
- **Note:** Information on the wear limits – Please observe vehicle manufacturer's data



HAZET No.	l mm	EAN-No. 4000896+
4956-3	395	219032

4956 Calliper gauge for brake discs

- Application: Simple, quick **determination of the brake disc diameter** through wheel opening without removing the wheels
- Measuring range 200–400 mm
- Universal application

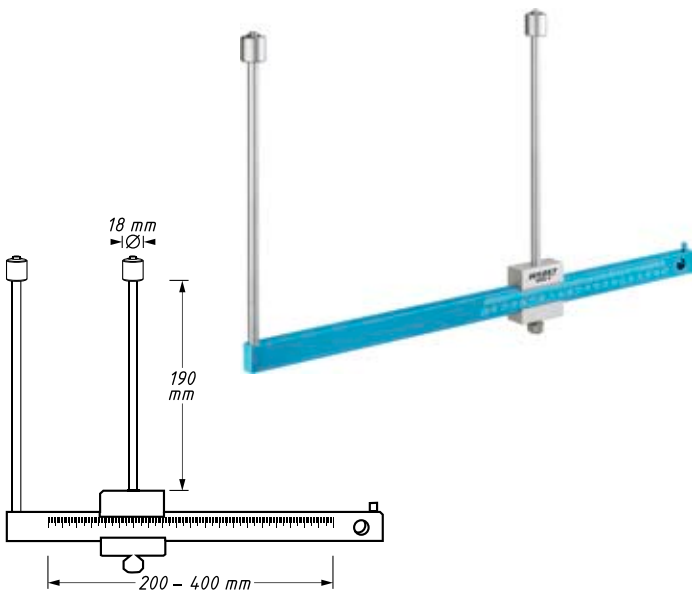

HAZET No.	EAN-No. 4000896+
4956-4	222339

4968 Brake test tool set

- Micrometer screw for exact determination of the thickness of the brake disc
- Application: Checking the lateral run-out of the brake disc
- Precision dial gauge for checking the lateral run-out
- Hinged bracket with magnetic base as mounting and for an exact positioning of the dial gauge on the vehicle
- Plastic box
- Soft foam insert



2155 N-25



2155-60



2155-65

HAZET No.	Quantity	EAN-No. 4000896+
4968/3	3	149179





4969 Pneumatic brake bleeding set

• Brake bleeder for the extraction of brake fluid on wheel brake cylinders / brake callipers

- Also suitable for ABS brakes (Caution: **Always follow manufacturer's specifications**)
- By means of compressed air, the integrated Venturi system creates a vacuum, with which the brake system is bled
- Including universal plastic nozzle, suitable for all vehicles
- Clear transparent brake bleeding hose enables easy visual check
- Air consumption: 180 l/min / working pressure: 6 to 8 bar
- Including coupler plug, nominal size 7.2
- Contents:
 - 1 brake bleeding device (container capacity 0.75 l)
 - 1 refill container with fixed nozzle
 - 1 refill container with flexible nozzle (container capacity: 1 litre each)



HAZET No.		EAN-No. 4000896+
4969-1/3	3	149445

4968 Hook set

- Application: Securely hanging dismantled components, e.g. brake callipers, avoids damage to brake hoses, lines etc.
- Universal application
- Hook \varnothing : 7 mm
- Surface: immersion-lacquered



HAZET No.	l mm	EAN-No. 4000896+
4968/2H	190	221820

4970 Basic unit

Made in Germany

• Application: **Readjusting brake pistons on floating calliper systems with or without locking device for hand brakes**

- **Basic unit**
- Thrust bearing avoids damaging the dust boot
- With additional outside hexagon ≤ 13 mm for flexible application of operating tools, e.g. ratchets



HAZET No.		EAN-No. 4000896+
4970-1		088874



Product applications

Brake piston readjusting sets

hazet.de \rightarrow Service \rightarrow Tool Finder
 \rightarrow Brake piston readjusting sets

◀ For Smartphones with QR reader (app)

4970 Brake piston readjusting tool set - pneumatic

• **Universal application thanks to 3-piece adapter set**

- Application: **Readjusting brake pistons on floating calliper systems with or without locking device for hand brakes**
- For clockwise and anti-clockwise brake pistons
- Largest possible recovery movement of the piston rod as far as into the housing – operation also when brake piston is extended far
- For smallest brake callipers **MINI** · **BMW** 1 Series to **BMW** X7 (largest brake calliper at present)
- Pneumatic support together with swivelling rotary level allows effortlessly easy and quick resetting
- It is possible to simultaneously press and turn or only press the brake piston after the brake pads on disc brake systems have been replaced
- Included adapter set 4970P-02/3 ensures flexible holding of pressure plates from other manufacturers available on the market, e.g.:
 - Inside hexagon adapter ≤ 13 mm for HAZET pressure plates of product group 4970
 - 10 mm ($\frac{3}{8}$ ") adapter to connect OEM special adapters e.g. all current **MINI** and **BMW** adapters · SW-Stahl
 - 2-pin adapter for, among others, VIGOR · SW-Stahl · KS-Tools · BGS · Kunzer
- In case with soft-foam insert and storage option for additional adapters
- Including operating instructions

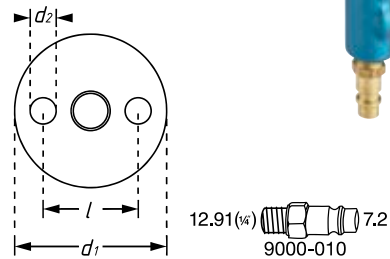

YouTube Clip



4970 P-02/3

HAZET No.		EAN-No. 4000896+
4970 P-1/4	4	232970

Adapter set

- For adapting pressure plates from different manufactures to basic unit HAZET 4970P-1:
 - Inside hexagon adapter ≤ 13 mm for HAZET pressure plates of product group 4970
 - 10 mm ($\frac{3}{8}$ ") outside square adapter to connect OEM special adapters e.g. all current **MINI** and **BMW** adapters · **BMW** 1 Series up to **BMW** X7 brake calliper (currently largest calliper)
 - 2-pin adapter for, among others, VIGOR · SW-Stahl · KS-Tools · BGS · Kunzer
- | HAZET No. | | EAN-No. 4000896+ |
|-------------|---|------------------|
| 4970 P-02/3 | 3 | 234929 |



Specialty tools

Brakes



4970 Pressure plates for 4970

Made in Germany

- Application: **Readjusting brake pistons on floating calliper systems with or without locking device for hand brakes**



HAZET No.	l mm	d ₁ mm	d ₂ mm	EAN-No. 4000896+
<ul style="list-style-type: none"> Pressure plate with 2 pins for: <ul style="list-style-type: none"> AUDI · A4 · model year 2007 → 2015 CITROËN · Berlingo 5 · model year 2008 → 2018 FIAT · Bravo · model year 2007 → 2014 FORD · Kuga · model year 2008 → 2012 · Mondeo · model year 2007 → 2014 · Transit · model year 2006 → 2013 OPEL/VAUXHALL · Insignia · model year 2008 → 2017 · Zafira B · model year 2005 → 2014 PEUGEOT · 407 · model year 2004 → 2011 · 508 · model year 2010 → 2018 RENAULT · Trafic · model year 2001 → 2014 SEAT · Altea · model year 2004 → 2015 ŠKODA · Octavia · model year 2004 → 2012 · Roomster · model year 2006 → 2015 VOLKSWAGEN · T5 · model year 2003 → 2015 · Touran · model year 2003 → 2015 				
4970-5	29	35	5	052943
<ul style="list-style-type: none"> Pressure plate inside hexagon: 12 mm AUDI · VOLKSWAGEN Please consider the brake calliper design 				
4970-6	-	30	-	052950
<ul style="list-style-type: none"> Pressure plate with 2 pins for: <ul style="list-style-type: none"> FIAT · 500 · model year 2007 → MERCEDES-BENZ · Citan · model year 2012 → RENAULT · Kangoo · model year 2008 → 2013 · Modus · model year 2004 → 2012 				
4970-7	24	32	6	052967
<ul style="list-style-type: none"> Pressure plate with 2 pins for: <ul style="list-style-type: none"> AUDI · Please consider brake calliper design CITROËN · Please consider brake calliper design VOLKSWAGEN 				
4970-8	44	55	6	052974
<ul style="list-style-type: none"> Pressure plate with 4 pins for: <ul style="list-style-type: none"> MINI · Cooper · model year 2006 → 2016 SAAB · Please consider brake calliper design 				
4970-9	22	30	5	052981
<ul style="list-style-type: none"> Pressure plate with 2 pins for: FORD · Transit · model year 2006 → 2013 				
4970-10	20	35	6	126019
<ul style="list-style-type: none"> Pressure plate with 2 pins for: FIAT · Panda · model year 2003 → 2012 				
4970-11	20	35	3	146581
<ul style="list-style-type: none"> Pressure plate with 2 pins for: FORD · S-Max · model year 2006 → 2014 · rear wheel brake 				
4970-12	20	40	5	149766

4971 Brake piston readjusting tool

Made in Germany

- Fast and uniform readjusting without tilting

- Application: **Damage-free readjusting brake pistons (floating callipers / fixed callipers) on disc brakes**
- For common vehicle types without integrated locking device for handbrakes
- Plate width 50 mm
- Working area 15 - 90 mm
- Avoids damaging of the boots and pistons
- High accuracy as well as high stability allow continuous use
- Reduced expenditure of force due to exact guidings

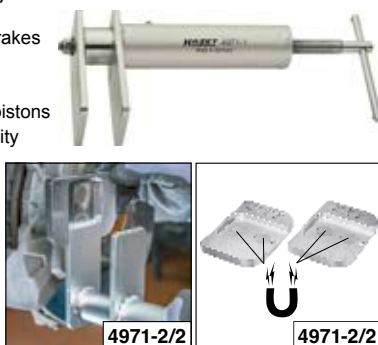

4971 Brake piston readjusting tool

HAZET No.	EAN-No. 4000896+
4971-1	156245
<ul style="list-style-type: none"> Adapter plate set · for brake piston readjusting tool 4971-1 for damage-free resetting of twin piston brake callipers Extension of width of supporting surface to 100 x 72 mm Easy fixing of the adapter plates using 2 disc magnets: Ø 20 mm (holding force per magnet: 2 kg) 	
4971-2/2	246243

796 Brake spring pliers

Made in Germany

- Application: Installing and removing the brake shoe return spring on **riveted brake linings**
- Surface: chrome-plated



HAZET No.	l mm	EAN-No. 4000896+
796	215	031818

797 Brake spring pliers

Made in Germany

- Moving claw

- Application: **Glued and riveted brake linings (rear drum brakes)**
- Surface: chrome-plated



HAZET No.	l mm	EAN-No. 4000896+
797	340	031825

1846 B Circlip pliers

Made in Germany

- Long, 90° angled tips

- Application: Operating **low-lying circlips** e.g. on brake callipers and gearboxes
- Jaws curved 90°
- Ergonomically shaped HAZET 2-component plastic handle covers (blue/black)
- Surface: chrome-plated



HAZET No.	l mm	mm	mm	EAN-No. 4000896+
1846 B-1.6	195	12-30	1.5	061457



Universal spring vice 4903

... everything fits well. And your safety is guaranteed.

- Short familiarization period due to easy handling
- Comfortable, safe and easy handling for just one user
- Clear workflows
- Top handling due to 90° swivelling
- Allows impact-free operation (e.g. cordless screwdriver or pneumatic air ratchet) (up to 15,000 N)
- Suitable for almost all spring shapes and designs
- Even blank-ends and accessories generally do not limit the tool's functionality
- Suitable for almost all shapes of head plates
- All workshop cases covered thanks to mobile and stationary application options of the basic unit 4900-2A
- Safe working due to tight spring fit and, in particular, due to load-free installation
- Time saving of approx. 10 minutes when completely removing the spring strut (McPherson)



5 steps to success

<p>Spring strut fixation</p>	<p>Swivelling</p> <p>Adjusting vertically, operating horizontally</p>	<p>Optimum working height approx. 1.30 m</p>	<p>Operating</p> <p>Retracting</p> <p>Optionally with reversible ratchet, cordless screwdriver or pneumatic ratchet</p>	<p>Load-free! Dismantling</p>
-------------------------------------	--	---	--	--------------------------------------

<p>www.hazet.de</p> <p>Further information:</p> <p>HAZET Online catalogue</p>	<p>HAZET YouTube channel</p> <p>Application video 4903</p>	<p>HAZET YouTube channel</p> <p>Application video 4903/4 W 203</p>
---	--	--



Specialty tools

Chassis – Spring vices / Shock absorbers



Time savings compared to standard applications thanks to the HAZET universal spring vice

Necessary work steps when replacing shock absorbers	HAZET 4903/4	Time saving compared to competitors
Clamping	Less complicated operation	👍
Operating	Comparable or considerably faster with cordless screwdriver	👍
Releasing	Not necessary	👍
Removal	Comparable	✓
Operating	Not necessary	👍
Releasing	Comparable	✓
Strut removal	Comparable	✓
Clamping of second shock absorber	Significant savings: easier and less complicated	👍
Operating	Comparable or considerably faster with cordless screwdriver	👍
Releasing	Not necessary	👍
Removal	Comparable	✓
Operating	Not necessary	👍
Releasing	Comparable	✓
Strut removal	Comparable	✓

- Can be used for almost any strut / shock absorber
- Innovative socket and installation concept
- High safety
- Allows record keeping by scaling
- Secured investment through the use of existing SYSTEM components 4900 [1]

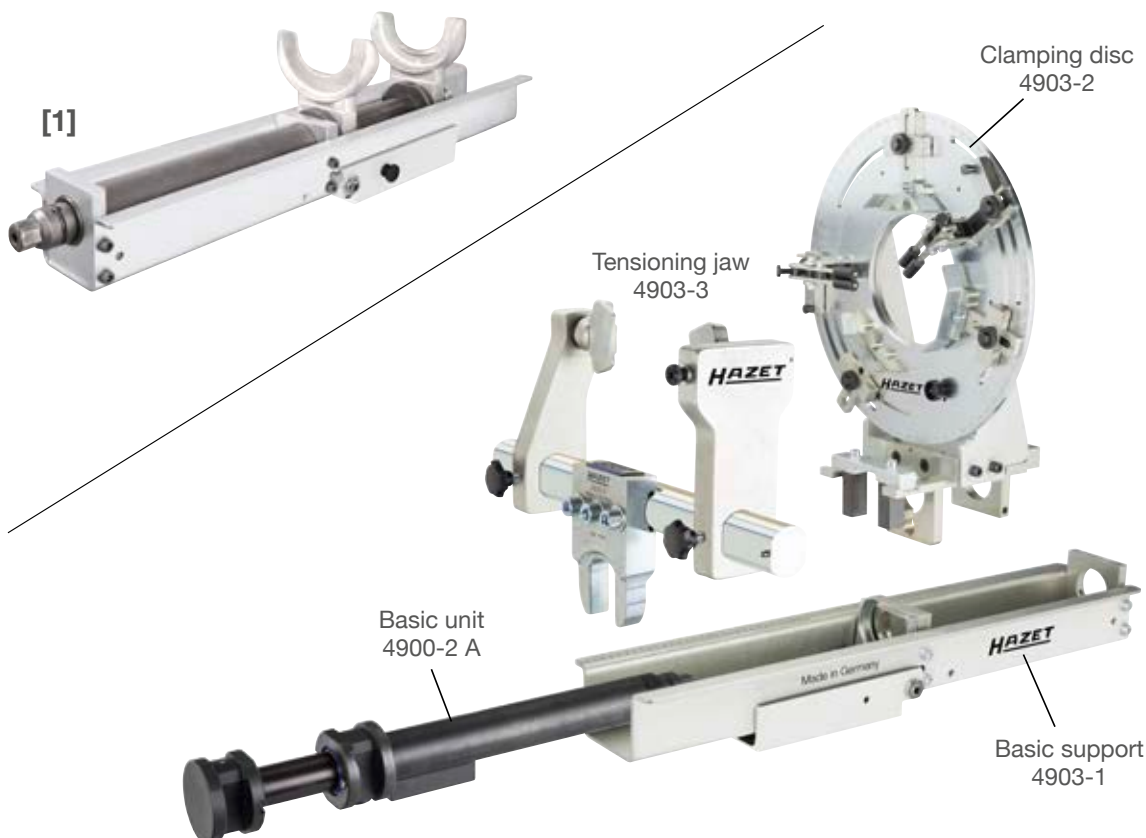

Patented

Made in Germany



HAZET safety spring vice 4900

... everything fits well. And your safety is guaranteed.

- Universal application thanks to replaceable tensioning jaws
- High loading capacity of 26,000 N
- Suitable for impact wrenches
- Closed system – maintenance-free
- Proven safety
- With socket rail for machinist's vice



Classification list

Suitable for approx. 200 vehicle types

Updated table on the internet

www.hazet.de



Service → Tool Finder



Safety spring vice database



Fahrzeugtypen-Übersicht						
Hersteller	Modell	Motor	Werkzeug	Werkzeug	Werkzeug	Werkzeug
CHRYSLER						
Alfa Romeo	159	159	159	159	159	159
Chrysler	159	159	159	159	159	159
Jeep	159	159	159	159	159	159
Jeep Grand Cherokee	159	159	159	159	159	159
Jeep Grand Cherokee (SRT)	159	159	159	159	159	159
Jeep Renegade	159	159	159	159	159	159
Jeep Wrangler	159	159	159	159	159	159
Jeep Wrangler (S)	159	159	159	159	159	159
Jeep Wrangler (Rubicon)	159	159	159	159	159	159

www.hazet.de

Tool Finder

... find the right tool for your application!





Specialty tools

Chassis – Spring vices / Shock absorbers



HAZET universal inside spring vice set 4904/6

Universal application on almost all passenger cars

Compact HAZET design – only 202 mm long – enables spring replacement on many vehicles with remarkable time savings



Optionally extendable with support device 4912-6

- Highlights:**
- Easy handling for just one user
 - Eliminates time-consuming work associated with most spring removal:
 - Removal of axle parts unnecessary
 - Axle alignment no longer necessary
 - Removal and installation possible in just a few minutes on each side
 - High loading capacity of 31,000 N
 - A 32 mm basic unit \varnothing
 - Angular movement 17°

Tested on vehicles from the following manufacturers:

AUDI · BMW · CITROËN · FIAT · FORD · HYUNDAI · KIA · MAZDA · MERCEDES BENZ · MINI · OPEL · PEUGEOT · RENAULT · SEAT · ŠKODA · TOYOTA · VOLKSWAGEN

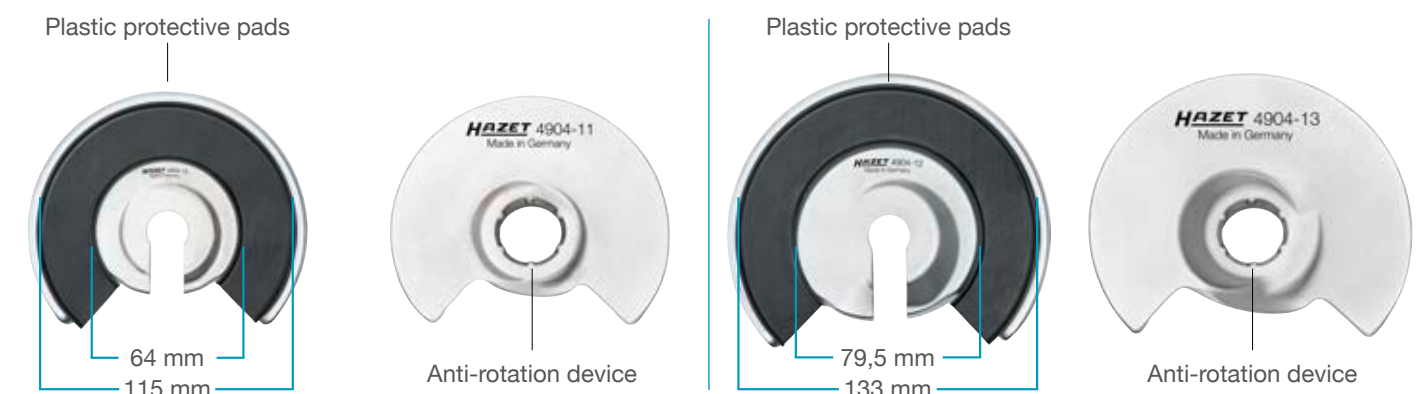



Product applications

Safety spring vice database
 hazet.de → Service → Tool Finder
 → Safety spring vice database

◀ For Smartphones with QR reader (app)

4900 Safety spring vice basic unit

- Made in Germany**
- **Installing and removing the coil spring when changing shock absorbers**
Suitable for around 200 different vehicle types
 - Application: Coil spring when changing shock absorber (please note safety spring vice classification table on the Internet or in the tool catalogue)
 - **Maximum span: 309 mm**
 - **High capacity of 26000 N**
 - **Suitable for impact operation**, e.g. HAZET 9012EL-SPC or 9012MT together with HAZET socket 900S-27 or 900SLG-27
 - Closed system – **maintenance-free**
 - Variable system thanks to easily replaceable tensioning jaws
 - **Location bar for machinist's vice**
 - GS mark – tested safety
 - Tempered cylindrical and guiding tube
 - Forged and tempered tensioning jaws
 - Also for spring strut with rebound spring in the shock absorber



YouTube Clip

HAZET No.	∅ mm	EAN-No. 4000896+
Safety spring vice basic unit		
4900-2A	–	077267
• Replacement set · for spring vice 4900-1A and -2A consisting of 2 straight pins and 1 O-ring		
4900-02A/3	7	069415
• Replacement set · for spring vice 4900-1 and 4900-2 consisting of 5 straight pins and 2 O-rings		
4900-02/7	6	063437

4900 Safety spring vice set

- Made in Germany**
- **Suitable for impact wrenches**
 - Application: Installing and removing the coil spring when **replacing shock absorbers**
 - Closed system – **maintenance-free**
 - Variable system thanks to easily replaceable tensioning jaws
 - Plastic inserts for the protection of the lacquered spring surfaces. This prevents spring damage due to corrosion
 - **Location bar for machinist's vice**
 - 4900-2A also for spring strut with rebound spring in the shock absorber
 - Maximum span: 309 mm
 - High **capacity of 26000 N**
 - GS mark – tested safety
 - Tempered cylindrical and guiding tube
 - Forged and tempered tensioning jaws



4900-2 A/3

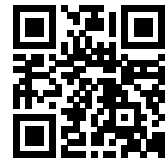

YouTube Clip

HAZET No.	∅ mm	EAN-No. 4000896+
• 1 basic unit and 2 tensioning jaws 4900-11		
• Suitable for around 50 different vehicle types		
• Plastic inserts optionally available		
4900-2A/3	3	149483
• 1 basic unit and 4 tensioning jaws (2x 4900-11 and 2x 4900-12)		
• Suitable for around 100 different vehicle types		
• Plastic inserts optionally available		
4900-2A/5	5	086054

4900 Tensioning jaw

Made in Germany

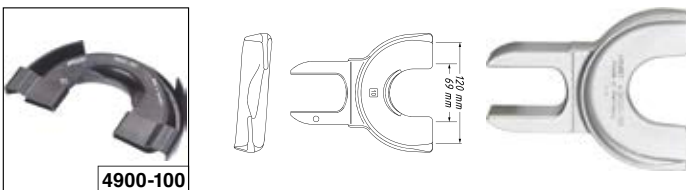

4900-100

HAZET No.	∅ mm	EAN-No. 4000896+
4900- 10	69–120	059706
• Plastic insert for protection of the lacquered spring surfaces preventing coil damage due to corrosion		
4900-100	–	061136

4900 Tensioning jaw

Made in Germany

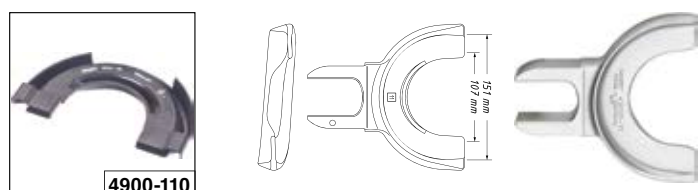

4900-110

HAZET No.	∅ mm	EAN-No. 4000896+
4900- 11	107–151	059713
• Plastic insert for protection of the lacquered spring surfaces preventing coil damage due to corrosion		
4900-110	–	061143



Specialty tools

Chassis – Spring vices / Shock absorbers



4900 Tensioning jaw

Made in Germany



4900-120

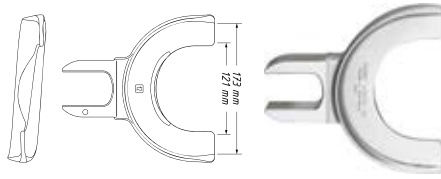

HAZET No.	∅ mm	EAN-No. 4000896+
4900- 12	121–173	059720
• Plastic insert for protection of the lacquered spring surfaces preventing coil damage due to corrosion		
4900-120	-	061150

Made in Germany

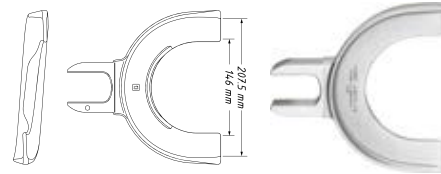

HAZET No.	∅ mm	EAN-No. 4000896+
4900-13	146–207.5	059737

Made in Germany

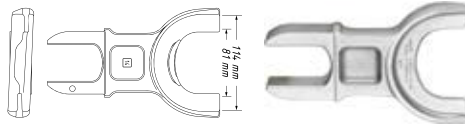

HAZET No.	∅ mm	EAN-No. 4000896+
4900-14A	81–114	064649

Made in Germany

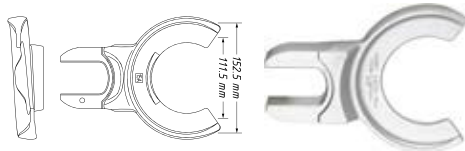

HAZET No.	∅ mm	EAN-No. 4000896+
4900-15A	111.5–152.5	121472

Made in Germany

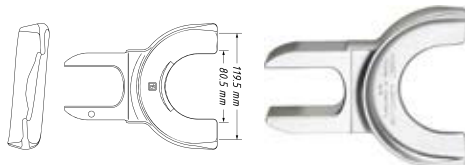

HAZET No.	∅ mm	EAN-No. 4000896+
4900-16	80.5–119.5	062164

4900 Tensioning jaw

Made in Germany

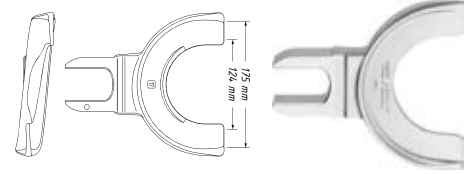

HAZET No.	∅ mm	EAN-No. 4000896+
4900-17	124–175	062171

Made in Germany



4900-180



HAZET No.	∅ mm	EAN-No. 4000896+
4900- 18		100378
• Plastic insert for protection of the lacquered spring surfaces preventing coil damage due to corrosion		
4900-180		074327

Made in Germany

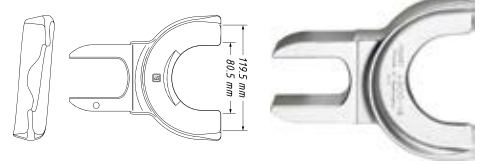

HAZET No.	∅ mm	EAN-No. 4000896+
4900-19	80.5–119.5	085842

Made in Germany

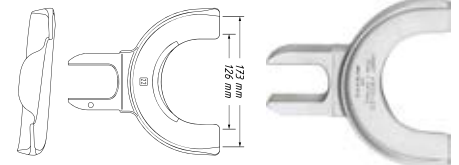

HAZET No.	∅ mm	EAN-No. 4000896+
4900-22	126–173	062188

Made in Germany

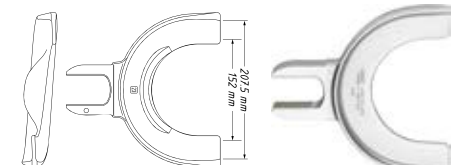

HAZET No.	∅ mm	EAN-No. 4000896+
4900-23	152–207.5	062195



4900 Tensioning jaw

Made in Germany



4900-243



HAZET No.	EAN-No. 4000896+
4900- 24	062201
Spacer ring for the tensioning jaw 4900-24	
• Especially advantageous if HAZET 4900-22 and -24 already exists	
4900-243	162932

Made in Germany



HAZET No.	EAN-No. 4000896+
• For driver's cabin with steel springs MERCEDES-BENZ Actros (MP-1) 1996 → · Atego 1998 →	
4900-25	121670

Made in Germany



HAZET No.	EAN-No. 4000896+
• For driver's cabin with steel springs MERCEDES-BENZ Actros (MP-1) 1996 → · Atego 1998 →	
4900-26	121687

Made in Germany



HAZET No.	EAN-No. 4000896+
4900-30	100514

Made in Germany

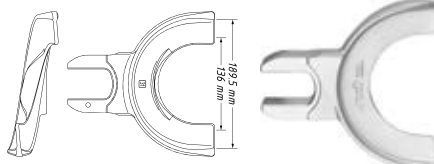

HAZET No.	∅ mm	EAN-No. 4000896+
4900-31	136–189.5	138036

4900 Tensioning jaw

Made in Germany



HAZET No.	EAN-No. 4000896+
4900-33	138043

Made in Germany

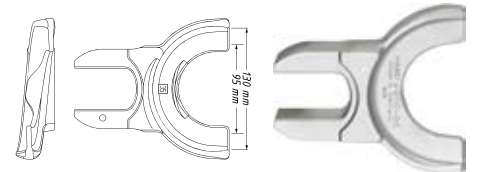

HAZET No.	∅ mm	EAN-No. 4000896+
4900-35	95–130	121212

4900 Tensioning jaw set · MERCEDES-BENZ

Made in Germany

• With brake

- Application: Operation of the coil springs of the front axle on **MERCEDES-BENZ**, type 204 (C-Class), type X 204 (GLK-Class), type 212 (E-Class with standard chassis) / type 212 (E-Class with sports chassis)
- To be used together with HAZET Safety Spring Vice 4900-2A
- Safe positioning of the spring struts with pivot bearing
- To be used together with HAZET safety spring vice 4900-2 A, suitable tensioning jaw, e.g. 4900-17 and suitable centring insert (choose according to vehicle type. Note: Please follow the instructions of the manufacturer)

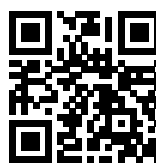

YouTube Clip

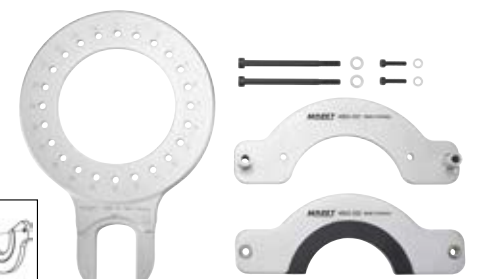
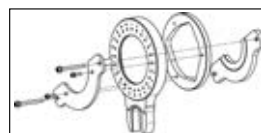

HAZET No.	∅ mm	EAN-No. 4000896+
4900-39/11	11	167678
Centring insert for MERCEDES-BENZ , type X204 (C class)		
• Use with HAZET safety spring vice 4900-2A, tensioning jaw 4900-17 as well as circular tensioning jaw with brake 4900-39/11		
4900-393	–	167722
Centring insert for MERCEDES-BENZ , type X204 (GLK class)		
• Use with HAZET safety spring vice 4900-2A, tensioning jaw 4900-17 and plastic spring protection insert 4900-120 as well as circular tensioning jaw with brake 4900-39/11		
4900-394	–	167739
Centring insert for MERCEDES-BENZ , type 212 (E-class) with standard chassis		
• Use with HAZET safety spring vice 4900-2A, tensioning jaw 4900-31 and plastic spring protection insert 4900-310 as well as circular tensioning jaw with brake 4900-39/11		
4900-395	–	167746



Specialty tools

Chassis – Spring vices / Shock absorbers



4902 Inside spring vice set

Made in Germany



- Application: Installation and removal of the **coil spring on the rear axle**
- Optimally coordinated to the confined spaces in the following vehicles
BMW
1 Series
– E87 Hatchback model year 2003 → 2011
– E81 Hatchback model year 2006 → 2013
– E82 Coupé 2006 → 2014
– E88 Convertible model year 2007 → 2015
– F20 · F21 model year 2011 → 2019
2 Series
– F22 · F23 · F87 model year 2013 →
3 Series
– E90 → Notchback model year 2004 → 2012
– E91 → Touring model year 2004 → 2013
– E92 → Coupé model year 2005 → 2013
– E93 → Convertible model year 2005 → 2013
– F30 · F31 · F34 · F35 · F80 model year 2011 → 2019
4 Series
– F32 · F33 · F36 · F82 · F83 model year 2013 → 2020
X1
– E84 model year 2009 → 2015
- Pendulum 6-point head provides a uniform distribution of power with the integrated twist protection
- Internal guidance of the tensioning jaws prevents the spring from sliding out
- Both-sided spindle operation possible
- Plastic box

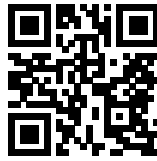

YouTube Clip

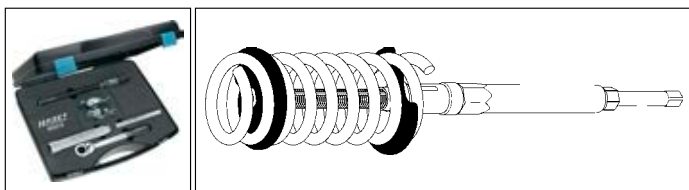

HAZET No.	l mm	∅ mm		EAN-No. 4000896+
• Inside spring vice set, contents: 4902-1 · 10 · 11 · 210 · 224 4910-1				
4902/6	–	–	6	121694
• Inside spring vice				
4902-1	–	–	–	122639
• Tensioning jaw				
4902-10	–	95–100	–	122646
4902-11	–	95–100	–	122653
• Tubular box wrench, size 10 mm				
4902-210	–	–	–	122677
• Tubular box wrench, size 24 mm				
4902-224	–	–	–	122660
• Reversible ratchet				
• Output: 12-point 21 mm				
4910-1	275	–	–	062133

4904 Universal inside spring vice

Made in Germany



- **Compact HAZET design enables spring replacement with remarkable time savings**
- **Universal application on almost all passenger cars**
- Application: Installation and removal of the **coil spring on the rear axle**
- Anti-rotation device for lower tensioning jaws integrated in the base component reduces the outer diameter to only 32 mm thanks to compact design
- Pendulum hexagonal head for equal force distribution with integrated anti-rotation protection for upper tensioning jaws
- One-sided counterholder for the spindle made possible by hexagon on top, e.g. with combination wrench HAZET 600N-13
- Removal and installation of springs with small coil spacing, e.g. for the **MINI Cooper S** (third generation) · **VW Passat (B8)**
- Extension of the span to 120 mm and an increase of the maximum load for increasing vehicle weights (electric and hybrid vehicles), for safe working up to 31,000 N → Tested with at least four-fold safety against breakage (GS mark of tested safety)
- 17° angular movement of the tensioning jaws now ensures removal of C-shaped (bent) springs, e.g. on the **AUDI A4 (B9)** · **VW Golf 7**
- Internal and external guidance of the tensioning jaws prevents the spring from sliding out
- All tensioning jaws included, reusable, replaceable plastic protective pads
- Tested on vehicles from the following manufacturers:
AUDI · BMW · CITROËN · FIAT · FORD · HYUNDAI · KIA · MAZDA · MERCEDES BENZ · MINI · OPEL · PEUGEOT · RENAULT · SEAT · ŠKODA · TOYOTA · VOLKSWAGEN

Highlights:

- Easy handling for just one user
- Eliminates time-consuming work associated with most spring removal:
 - Removal of axle parts unnecessary
 - Axle alignment no longer necessary
 - Removal and installation possible in just a few minutes on each side
- Plastic box
- Soft foam insert



Video



HAZET No.	∅ mm		EAN-No. 4000896+
• 6-piece set, contents:			
– 1 inside spring vice 4904-1			
– 1 tensioning jaw 4904-10 · span width 64 – 115 mm			
– 1 tensioning jaw 4904-11 · span width 64 – 115 mm			
– 1 tensioning jaw 4904-12 · span width 79.5 – 133 mm			
– 1 tensioning jaw 4904-13 · span width 79.5 – 133 mm			
– 1 tubular box wrench 4902-224 · s 24 mm			
4904/6	–	6	238897
• Inner spring vice: spindle · drive nut · pressure sleeve with anti-rotation device			
4904-1	–	–	236251
• Tensioning jaw · span width 64 – 115 mm			
4904-10	64–115	–	236213
4904-11	64–115	–	236220
• Tensioning jaw · span width 79.5 – 133 mm			
4904-12	79.5–133	–	236237
4904-13	79.5–133	–	236244
• Plastic protective pad (2 piece)			
4904-100/2	–	–	240036
4904-120/2	–	–	240043
4912-6	–	–	238835
• Tubular box wrench, size 24 mm			
4902-224	–	–	122660



4912 Support device

Made in Germany

• Can be used on almost all vehicles – helpful on vehicles with multi-link axle

- Application: Prevents unwanted raising of the chassis during a spring tensioning process
- Protective pads prevent damage to the vehicle parts
- Facilitates removal of rear axle springs
- Safety: visual chain provides a reminder for tool removal
- Use together with universal inside spring vice set 4904/6
- Clamping range: 80 – 127 mm
- Thrust block diameter: 30 mm
- Chain length: 750 mm



HAZET No.	EAN-No. 4000896+
4912-6	238835

4903 Universal spring vice

Made in Germany

• Increased safety – thanks to load-free installation

- Can be used for almost any spring strut / shock absorber strut
- **Load-free disassembly / assembly with completely relieved shock absorber**
- **Innovative socket and installation concept**
- Swivels in horizontal or vertical working position, HAZET recommends ergonomic working height: adjust vertically, operate horizontally
- Damage to shock absorbers and head plates impossible (no overload risk)
- Simple, lockable strut mount
- **High safety**
- Consistently reliable mounting of head plates
- Thread damage to piston rod impossible
- Permanent fixation of spring throughout operation

Secured investment – by using existing components of SYSTEM 4900

- Existing basic units 4900-2A and all tensioning jaws of System 4900 may be used
- Use of future applications is assured

Allows record keeping by scaling

- If recurring, significant time savings by scaling
- Firm fixation eliminates readjustment at the same spring strut (left/right)

4 steps to success:

1. Fix spring strut on clamping disc via gripper and brakes
2. Grip spring with universal tensioning jaw
3. Operate tensioning device with reversible ratchet, cordless screwdriver or pneumatic air ratchet
4. Disassemble shock absorber without load and install new one (afterwards in reverse order)

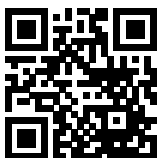

YouTube Clip

4903 Universal spring vice

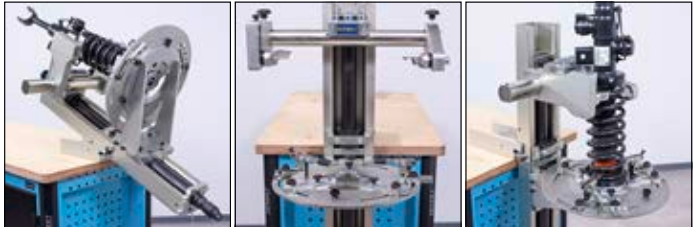
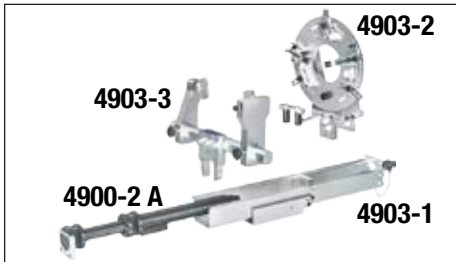

HAZET No.		EAN-No. 4000896+
4903-1	–	179824
4903-2	2	180530
4903-3	3	180554
4903-4	4	180561
4903-2	–	179831
4903-3	–	179848
4900-2A	–	077267
4903-01/3	–	181704
4903-04	–	226351



Specialty tools

Chassis – Spring vices / Shock absorbers



4910 Shock absorber tool set

Made in Germany

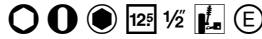

- Application: Repair work at the strut e.g. shock absorber, strut mounting, coil spring
- Counterholder for piston rod when removing and installing the spring strut
- **Caution:** Follow vehicle manufacturer's specifications concerning torque values
- Application with torque wrench (for example), e.g. HAZET 6291-1CT together with insert box-end wrench 6630d-21
Application of an impact wrench may damage the thrust bearing and the piston rod



YouTube Clip



1/3			
-----	--	--	--

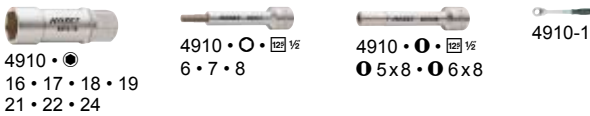

HAZET No.	L x W x H mm		EAN-No. 4000896+
4910/13	355x235x65	13	061495

4910 Reversible ratchet

Made in Germany



- Application: Repair work at the strut e.g. shock absorber, strut mounting, coil spring
- Reversible ratchet
- Output: 12-point 21 mm



HAZET No.	l mm	EAN-No. 4000896+
4910-1	275	062133

4910 Socket · hexagon

Made in Germany



- Application: Repair work at the strut e.g. shock absorber, strut mounting, coil spring
- Retaining the piston rod when removing and installing the spring strut
- **Caution:** Follow vehicle manufacturer's specifications concerning torque values
- Drive s 21 mm



4910 Socket · hexagon



HAZET No.	S mm	l mm	EAN-No. 4000896+
4910-16	16	82	062010
4910-17	17	82	062027
4910-18	18	82	062034
4910-19	19	82	062041
4910-21	21	82	062058
4910-22	22	82	062065
4910-24	24	82	062072

4910 Counterholder for piston rod

Made in Germany

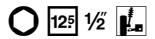

- Application: Repair work at the strut e.g. shock absorber, strut mounting, coil spring
- Drive with ball race



HAZET No.	S mm	l mm	EAN-No. 4000896+
4910-5	5	122.5	214549
4910-6	6	122.5	062089
4910-7	7	122.5	062096
4910-8	8	122.5	062102

• On e.g. **BMW**
 1 Series F20 · F21 model year 2011 →
 2 Series F22 · F23 · F45 · F46 model year 2013 →
 3 Series F30 · F31 · F34 · F35 model year 2011 →
 4 Series F32 · F33 · F36 model year 2013 →
 X1 F48 · F49 model year 2015

Made in Germany

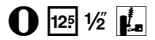

- Application: Repair work at the strut e.g. shock absorber, strut mounting, coil spring
- Drive with ball race



HAZET No.	S mm	l mm	EAN-No. 4000896+
4910-58	5x8	122.5	062119
4910-68	6x8	122.5	062126

• For **PORSCHE** Cayenne S · **VW** Touareg · Touran · Sharan

HAZET No.	S mm	l mm	EAN-No. 4000896+
4910-71	7.1x9.6	122.5	091195

Made in Germany

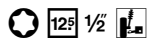

- Application: Repair work at the strut e.g. shock absorber, strut mounting, coil spring
- Drive with ball race
- For **OPEL/VAUXHALL** Astra H · **MERCEDES-BENZ** C-Class (204) · E-Class (212) · E-Class Coupé (207)



HAZET No.	S	l mm	EAN-No. 4000896+
4910-T50	T50	122.5	120598

Made in Germany

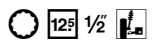

- Application: Repair work at the strut e.g. shock absorber, strut mounting, coil spring
 - Drive with ball race
- For e.g. **OPEL/VAUXHALL** Insignia B model year 2017 →



HAZET No.	l mm	EAN-No. 4000896+
4910-XZN 10	122.5	247004



4915 Shock absorber tool set

Made in Germany

- Application: Repair work at the spring strut e.g. shock absorber, strut mounting, coil spring
- Retaining the piston rod when removing and installing the spring strut
- **Attention:** Follow vehicle manufacturer's specifications concerning torque tightening values
 - Use with torque wrench e.g. HAZET 6291-1CT together with insert box-end wrench 6630d-21

Application of an impact wrench may damage the thrust bearing and the piston rod



1/3			
-----	--	--	--



606 • 21

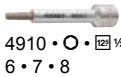

4910 • 6 • 7 • 8

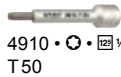

4910 • T50



4910 • 16 • 17 • 18 • 19 • 21 • 22 • 24

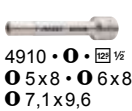

4910 • 5 x 8 • 6 x 8 • 7,1 x 9,6

HAZET No.	L x W x H mm	■	EAN-No. 4000896+
4915/15	355x235x65	15	179213

2593 Shock absorber crown wrench

Made in Germany

- Application: Operation of shock absorber screw connections (repairs) on **VW · SEAT · AUDI** vehicles (front axle)
- drive 22 mm, b = width of pins
- Surface: chrome-plated

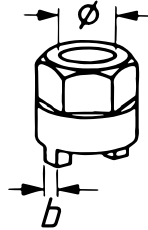

HAZET No.	mm	mm	b mm	EAN-No. 4000896+
2593-4	22	14.5	5	017263

2780 Shock absorber crown wrench

Made in Germany

- Application: Operation of shock absorber screw connections (upper journal fitting) on **MERCEDES-BENZ** type 203 (C-Class model year 2000 →)
- drive 22 mm, b = width of pins
- Surface: chrome-plated

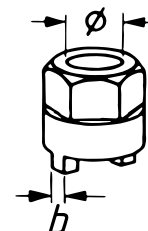

HAZET No.	mm	mm	b mm	EAN-No. 4000896+
2780-1	22	14.1	2.6	082858

2710 Camber adjustment specialty tool

Made in Germany

- **Specialty tool, tuned to the extremely hard-to-access shock absorber screw connection**

- Application: Shock absorber screw connection for camber adjustment on **MERCEDES-BENZ** Sprinter, **VW** Crafter
 - Specialty tool enables:
 - Operation even with unfavourable spatial conditions on a measurement platform
- The necessary force transmission for screwing operation



HAZET No.	EAN-No. 4000896+
2710-21	206414

Wheel bearing / Wheel hub

1779 Ball joint puller

Made in Germany

- Application: Removing the ball joint pivots of steering tie rods, stabilizers, etc.
- a = Jaw opening
- Surface: galvanised

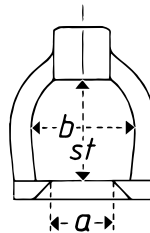

HAZET No.	a mm	b mm	st mm	EAN-No. 4000896+
1779-27	27	54	54	136025
1779-37	37	75	77	136032
1779-55	55	81.3	80	136407

• E.g. for commercial vehicles **MAN · MERCEDES-BENZ** etc.

1779 Universal ball joint puller

Made in Germany

- Application: Removing the ball joint pivots (jaw opening 23 mm) of steering arms, steering tie rods, stabilizers etc. on the most common vehicles
- Great clamping range due to continuous vertical adjustment and turn-over of the lower part

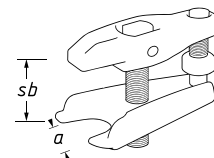

HAZET No.	a mm	sb mm	EAN-No. 4000896+
1779-1	23	65	135974



Specialty tools

Chassis – Wheel bearing / Wheel hub



1779 Universal ball joint puller

Made in Germany

• Sturdy design and deep location groove enable a safe and universal application, e.g. for light commercial vehicles

• Application: Removing the ball joint pivots of steering arms, steering tie rods, stabilizers etc.
• For the most common vehicles

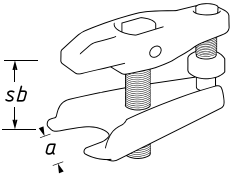

HAZET No.	a mm	sb mm	EAN-No. 4000896+
1779-3	32	85	135998

1779 Ball joint puller

Made in Germany

• Application: Removing the ball joint pivots of steering arms, steering tie rods, steering knuckles, stabilizers etc.
• Clamping range: 50–80 mm
• Length of the jaw: 35 mm

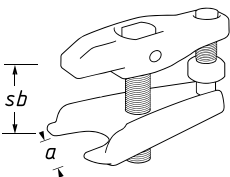

HAZET No.	a mm	sb mm	EAN-No. 4000896+
1779-22	20	50–80	141654

1790 Ball joint puller

Made in Germany

• Application: Removing ball joint pivots on vehicles with multi-link axle e.g. AUDI A6 and A8, VW Passat, Golf
• Surface: galvanized (free from Cr 6)

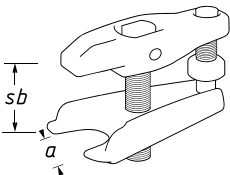

HAZET No.	a mm	sb mm	EAN-No. 4000896+
1790-4	30	65	145447



1790 Universal ball joint puller

Made in Germany

• Application: Removing the ball joint pivots of steering tie rods, stabilizers, etc.
For FORD · BMW · Volvo · TOYOTA · OPEL/VAUXHALL · VW · AUDI · RENAULT

• Jaw opening: 20 mm
• Clamping range (sb) in 2 stages
stage 1: up to 30 mm
stage 2: up to 50 mm
• Surface: galvanized (free from Cr 6)

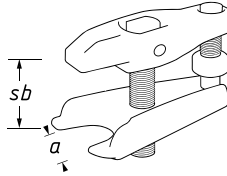

HAZET No.	a mm	sb mm	EAN-No. 4000896+
1790-7	20	12–50	148073

1790 Ball joint puller

Made in Germany

• Supported by hydraulic system

• Application: Safe removal of ball joint pivots and ball joints
• Surface: galvanized (free from Cr 6)
• For passenger cars · vans · commercial vehicles
• Load maximum 12 tonnes

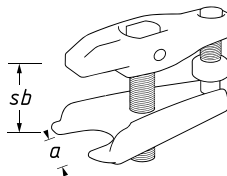

HAZET No.	a mm	sb mm	EAN-No. 4000896+
1790-5	32	70	145461

1780 Removal and assembly fork

Made in Germany

• Proven and economical system

• Application: Wedge-shaped fork end allows fast operation of push rod and steering tie rod ends, pitman arms and other parts of the steering
• Easy to handle
• Shock absorber removal and other separation work
• Application possible in confined spaces
• Sturdy forged design

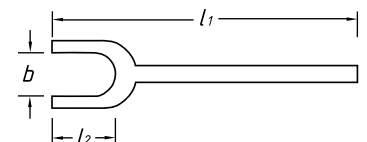

HAZET No.	l ₁ mm	l ₂ mm	b mm	EAN-No. 4000896+
1780-23	340	80	23	133352
1780-29	350	80	29	133376



2583 1/2" Wheel bearing tool

Made in Germany

- For the adjustment of torsion bars
– Removal of wheel bearings on VW transporter T4
- Long design
- With knurling
- Surface: matt chrome-plated

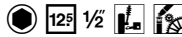

HAZET No.	S mm	l mm	EAN-No. 4000896+
2583	27	140	017034

4933 Double cone wheel bearing tool set

Made in Germany

- Application: Unscrewing e.g. screwed wheel bearings in combination with HAZET sliding hammer 1969-17. Can be used for almost all wheel bearings
- In soft foam insert
- Contents:
1 x spindle total length: 305 mm outside thread TR 20x3 inside thread M20 x 1.5
2 x spindle nut TR 20x3
2 x lock nut TR 20x3
6 x cone

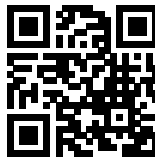

YouTube Clip

HAZET No.	Quantity	EAN-No. 4000896+
4933-1/11	11	223022

1969 Sliding hammer

- Application: For unscrewing e.g. screwed wheel bearings in combination with HAZET double cone bearing tool set 4933-1/11
- Striking weight: 6 kg
- Coupler thread: M20 x 1.5
- Total length: 890 mm

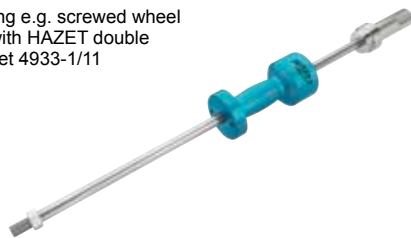

HAZET No.	EAN-No. 4000896+
1969-17	223015

4912 Spreader

Made in Germany

- Application: Expansion of the spring strut and ball joint mounting (separating the spring strut from the wheel bearing housing)
- Drive with ball race

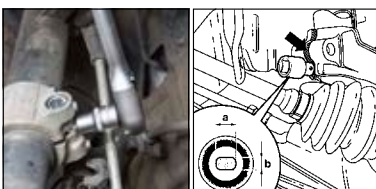
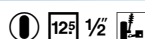

4912 Spreader

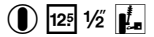

HAZET No.	S mm	l ₁ mm	l ₂ mm	EAN-No. 4000896+
• Application e.g. for VW Fox model year 2005→ · Polo model year 2002→ · New Beetle, Golf model years 1998 to 2004 · Tiguan model year 2008→ · Eos model year 2006→ · Passat model year 2006→ · Touran model year 2003→ · Caddy model year 2004→ · T5 model year 2004→				
• AUDI A2 model year 2001→ · A3 model year 2004→ · A4 model years 2001 to 2008 · A5 model year 2008→ · A6 model year 2008→ · TT model year 2007→				
• SEAT · ŠKODA				
• ⌀ 5.5x8 mm				
4912-1	⌀ 5.5x8	10	48	156368
• Application on e.g. RENAULT · PEUGEOT · CITROËN · VW Golf 7 · SEAT León 3				
• ⌀ 5x7 mm				
4912-2	⌀ 5x7	10	49	155804
• Application on e.g. BMW · MINI				
• ⌀ 6x8 mm				
4912-3	⌀ 6x8	10	49	217427
• Application on e.g. MERCEDES-BENZ Sprinter, type 910 with front-wheel drive model year 2018 →				
• ⌀ 7.8x11 mm				
4912-4	⌀ 7.8x11	10	50	222551

4912 Universal spreader · mechanical

Made in Germany

- Universal application due to wide spreading range 5 – 11.5 mm

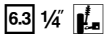

- Application: Expansion of the spring strut and ball joint mounting (separating the spring strut from the wheel bearing housing)
- Inspection window for checking the spreading range
- With chamfered edge for optimised insertion of the spreader into the steering knuckle
- Retainer with size 17 mm possible
- Optimised end stops with inspection window
- Robust, reinforced design
- Compact design



YouTube Clip



HAZET No.	L x W x H mm	EAN-No. 4000896+
4912-5N	60x24x30	249312

4912 Camber adjustment tool set

- Suitable for VW Golf, Jetta, SEAT Toledo, etc.



- Enables camber adjustment by one person only
- Tool significantly reduces the time required for the operation
- Sturdy 6-point spindle with s 22 mm for easy application
- Span width: 135 – 175 mm



HAZET No.	Quantity	EAN-No. 4000896+
4912-3/2	2	166596



Specialty tools

Chassis – Wheel bearing / Wheel hub



4960 Wheel hub grinder

- Prevents the falsification of the wheel bolt tightening torque originated by corrosion
- Application: Quick and easy removal of rust and dirt from contact surfaces of wheel hubs and brake discs with wheel bolt support
- Open-pored abrasive material and cup-formed grinding disc reduce the formation of dust to a minimum
- No formation of sparks
- 10 mm 3-point pin, e.g. for the use in (air) drills



Ø 200 mm
4960-0200/2

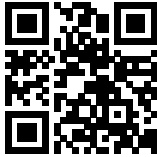

YouTube Clip



HAZET No.	Ø mm		EAN-No. 4000896+
For wheel hubs on passenger cars and transporters up to 200 mm Ø e.g. BMW · FIAT Ducato · MERCEDES-BENZ Sprinter, etc.			
• Wear-resistant: around 100 vehicles per wheel			
• Rotation speed maximum 1000 rpm			
• 3-piece set · contents:			
1 grinding pad, 2 grinding wheels Ø 200 mm			
4960-200/3	200	3	143290
• Hook and loop fastener for quick changing of grinding wheels			
• 2 spare grinding wheels Ø 200 mm			
4960-0200/2	200	2	143306

4960 F Rim flange cleaner

- Prevents the falsification of the wheel bolt tightening torque originated by corrosion
- Application: Optimum cleaning of the contact surface on the rim inside
- 11 mm outside hexagon with 3 contact surfaces for attachment e.g. to pneumatic, cordless and corded drilling machines
- Centre hole guidance and integrated sander for cleaning the wheel centring
- Wear-resistant: around 100 vehicles per wheel
- Open-pored abrasive material and cup-formed grinding wheel reduce the formation of dust to a minimum
- No formation of sparks



4960 F Rim flange cleaner



4960 F-0160/3

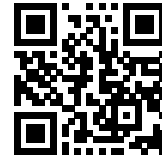

YouTube Clip

HAZET No.		EAN-No. 4000896+
• Outer diameter up to 160 mm Ø		
• For wheel centring diameter: at least 51 mm		
• Rotation speed maximum 500 rpm		
• 2-piece set · contents:		
1 base component		
1 grinding wheel Ø 160 mm		
4960 F-160/2	2	218387
• 3 spare grinding wheels Ø 160 mm		
• For 4960F-160/2		
• Hook and loop fastener for quick changing of grinding wheels		
4960 F-0160/3	3	218806

4960 R Wheel hub grinder

- Prevents the falsification of the wheel bolt tightening torque originated by corrosion
- Application: Quick and easy removal of rust and dirt from contact surfaces of wheel hubs and brake discs with wheel bolt support
- 11 mm outside hexagon with 3 contact surfaces for attachment e.g. to pneumatic, cordless and corded drilling machines
- Wear-resistant: around 100 vehicles per wheel
- Open-pored abrasive material and cup-formed grinding wheel reduce the formation of dust to a minimum
- No formation of sparks



YouTube Clip



4960 R-0160/3

HAZET No.		EAN-No. 4000896+
• For passenger car wheel hubs up to 160 mm Ø		
• Inside diameter: 75 mm Ø		
• Rotation speed maximum 500 rpm		
• 4-piece set · Contents:		
1 base component		
3 grinding wheels Ø 160 mm		
4960 R-160/4	4	218820
• 3 spare grinding wheels Ø 160 mm		
• For 4960R-160/4		
• Hook and loop fastener for quick changing of grinding wheels		
4960 R-0160/3	3	218790



4960 V Wheel hub grinder

- Prevents the falsification of the wheel bolt tightening torque originated by corrosion
- Application: Quick and easy removal of rust and dirt from contact surfaces of wheel hubs and brake discs with wheel bolt support
- With \square 12.5 mm (1/2 inch) inside square collet for attachment e.g. to pneumatic, cordless and corded impact wrenches
- Wear-resistant: around 100 vehicles per wheel
- Open-pored abrasive material and cup-formed grinding wheel reduce the formation of dust to a minimum
- No formation of sparks
- Quick and safe application of the grinding pad due to tothing and hook and loop

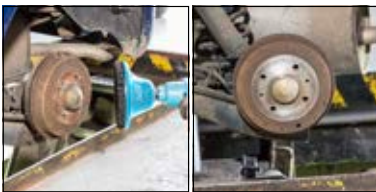

4960 V-0160/3



HAZET No. EAN-No. 4000896+

- For passenger car wheel hubs up to 160 mm \varnothing
 - Inside diameter: 75 mm \varnothing
 - Rotation speed maximum 500 rpm
 - 2-piece set** · contents:
 - 1 base component
 - 1 grinding wheel \varnothing 160 mm
- | | | |
|--------------|---|--------|
| 4960 V-160/2 | 2 | 218394 |
|--------------|---|--------|
- 3 spare grinding wheels \varnothing 160 mm**
 - For 4960V-160/2
 - Hook and loop fastener for quick changing of grinding wheels
- | | | |
|---------------|---|--------|
| 4960 V-0160/3 | 3 | 218813 |
|---------------|---|--------|

4960 N Wheel hub grinder

- Made in Germany**
- Prevents the falsification of the wheel bolt tightening torque originated by corrosion
- Application: Quick and easy removal of rust and dirt from contact surfaces of wheel hubs and brake discs with wheel bolt support
- Open-pored abrasive material and cup-formed grinding disc reduce the formation of dust to a minimum
- No formation of sparks



4960 N Wheel hub grinder

-
-
-
-
-

HAZET No. EAN-No. 4000896+

- Hexagon insert for firm hold on the device
- 8-point profile** enables safe and firm fixation of the grinding wheel to the base component
- For wheel hubs with stud bolts (diameter of grinding zone 40 or 50 mm; stud bolt maximum 55 mm length), e.g. **FORD · PORSCHE · Volvo**, Japanese passenger cars
- Wear-resistant: around 50 vehicles per wheel

12-piece set · contents:
1 base component made of aluminium
6 grinding wheels, diameter 50 mm
5 grinding wheels, diameter 40 mm

4960 N-45/12	12	186860
--------------	----	--------

- Hook and loop fastener for quick changing of grinding wheels
- 5 spare grinding wheels (small) \varnothing 40 mm**

4960 N-40/5	5	187232
-------------	---	--------

- Hook and loop fastener for quick changing of grinding wheels
- 5 spare grinding wheels (small) \varnothing 50 mm**

4960 N-50/5	5	187126
-------------	---	--------

Silent block

4925 Tool set for silent blocks

- Made in Germany**
- For VW, AUDI, SEAT, ŠKODA

- Application: Removal and installation of the silent blocks located in the operating panel on the wishbone of the front axle
- Working on built-in components
- Tool set spares from axle alignment
- M12x1.75
- VW** Polo 9N model years 2002 → 2009 · Fox model year 2005 →
- AUDI** A2 model years 2000 → 2005
- ŠKODA** Fabia model years 2000 → 2004
- SEAT** Ibiza · Altea · Córdoba model years 2003 → 2005
- Tool set for silent blocks, contents: 4925-4 · 5 · 6 · 7 · 8A



HAZET No. EAN-No. 4000896+

4925-2501/5	5	159406
-------------	---	--------



4925 Double silent block tool set

Made in Germany

• Removal and installation of the double silent block in the aggregate carrier

- AUDI: A3 · Q3, TT model year 2003 →
- SEAT: León · Altea · Alhambra model year 2004 →
- ŠKODA: Octavia · Superb, Yeti model year 2004 →
- VW: Caddy · Golf 5-6 · Jetta · Sharan · Scirocco · Eos · Touran · Tiguan model year 2003 →
- Operation with HAZET spindle set 4925-67/2 (optional)



HAZET No.		EAN-No. 4000896+
4925-2510/9	9	194926

4925 Spindle set

Made in Germany

• Motion screw thread at spindle and spindle nut cause high tractive and compressive output with little effort (torque)

- Application: Operation of the double silent block tool set HAZET 4925-2510/9
- **2-piece set:**
4925-67 spindle TR 14 x 2 mm
4925-11 spindle nut with axial groove bearing



HAZET No.	l mm		EAN-No. 4000896+
4925-67/2	259	2	194940

4929 Spindle set

Made in Germany

- Operation of the tool sets for silent blocks 4925-2506/16
- Motion screw thread at the spindle and axial groove bearing at the pressure piece cause high tractive and compressive output by low expenditure of force (torque)
- **3-piece set** · contents:
4929-1 spindle TR 12 x 1.5
4929-2 compression nut with axial bearing s 24
4929-3 hexagon nut



HAZET No.	l mm		EAN-No. 4000896+
4929-1/3	225	3	156900

Cardan shafts

2584 LG-1 3/8" Drive shaft screwdriver socket

Made in Germany

• Torque-controlled screw tightening, e.g. with HAZET 5110-3CT possible (Please follow the manufacturer's specifications)

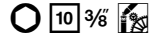

- Application: Operation of the stud shaft on AUDI · VW · SEAT · ŠKODA
Operation of the fastening screws on the heat protection plate when removing the drive shaft
- Universal application for deep screw connections
- Also for gearbox repair
- **Extra long design**

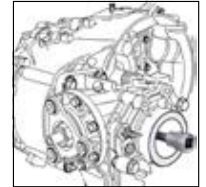

HAZET No.	l ₁ mm	l ₂ mm	EAN-No. 4000896+
2584 LG-1 A	332	359	252817

1847 Clamp pliers for axle boots

Made in Germany

- Application: Installation of **axle boots made of Hytrel** and special stainless steel clamps with pre-set **torque tightening values**, together with e.g. torque wrench HAZET 6110-1CT
- For VW · AUDI · SEAT · ŠKODA · OPEL/VAUXHALL · FORD etc.
- Ergonomically shaped HAZET 2-component handle



HAZET No.	l mm	EAN-No. 4000896+
1847	178	050918
• Pair of clamping jaws · for steering gear boots AUDI A4 · A5 · A6 · A7 · Q5 in conjunction with 1847 · for refitting		
1847-02/2	–	174447
• Pair of clamping jaws · angled 90° · for installation of high-grade steel straps / Hytrel axle boots that are difficult to access		
• "Movable" sockets enable the ear clamp to be clamped in parallel		
• Simple conversion of pliers 1847		
1847-090/2	–	206711



1847 Pliers for axle boot clamps

Made in Germany
• Lug hold-down device



- Application: Passenger car axle boot clamps
- On e.g. VW · AUDI · OPEL/VAUXHALL · BMW · MERCEDES-BENZ · HONDA · NISSAN · MAZDA
- Surface: nickel-plated



HAZET No.	l / mm	EAN-No. 4000896+
1847-1	230	007004

1847 Clamp pliers

Made in Germany



- Application: Operation of progressively adjustable, earless clamps e.g. for axle boots on VW · AUDI · MERCEDES-BENZ · TOYOTA



HAZET No.	l / mm	EAN-No. 4000896+
1847-11	191	079520

1847 Circlip pliers

Made in Germany



- Application: Snap rings on outside lockrings, e.g. gearbox
- Jaws bent 90°, tips chequered
- For outside lockrings
- Surface: chrome-plated



HAZET No.	l / mm	EAN-No. 4000896+
1847-2	200	007011

Made in Germany



- Application: Snap rings on VW · AUDI · OPEL/VAUXHALL · FORD
- For homocinetic joint or drive shaft
- Jaws bent 10°, tips chequered
- For outside lockrings
- Surface: chrome-plated



HAZET No.	l / mm	EAN-No. 4000896+
1847-3	200	007028

1847 Circlip pliers

Made in Germany



- Application: Circlips on outside cardan shaft / bearing and gearbox for VW · AUDI · SEAT · ŠKODA · OPEL/VAUXHALL · FORD etc.
- Jaws bent 30°
- Surface: chrome-plated



HAZET No.	l / mm	EAN-No. 4000896+
1847-6	200	050468

Made in Germany



- Application: Operation of snap rings / circlips on flange and cardan shafts for VW e.g. T4
- Jaws bent 30°
- Surface: chrome-plated



HAZET No.	l / mm	EAN-No. 4000896+
1847-61	200	058761

1847 Circlip pliers set

Made in Germany



- Easy, damage-free assembly of the drive shaft joint: damage to the serration of joint and shaft is avoided with internal circlip during assembly of the drive shaft joint

- Application: Correct, centred insertion of the circlip, e.g. when mounting the joint on the drive shaft
- Easy fixing of the locking pliers with the circlip
- The pliers automatically slip down when striking the joint
- Safe work without damage to the bellows
- For drive shafts from all manufacturers
- One-hand operation of the pliers
- No other tools needed

Application tip:

- Insert appropriate half shells (shaft diameter) in pliers
- Place pliers on serration with pre-assembled circlip and clamp
- Pre-positioning of the hinge due to conical shape of the pliers makes it easier to introduce the serration without damage
- Suitable for almost all vehicles commonly registered in Europe
- Plastic box 165-L (1/3)
- Safety-Insert-System, 2-component soft foam insert. Insert also suitable for HAZET Assistant



1/3				
-----	--	--	--	--

1847-12	1847-122/2	1847-124/2	1847-126/2
1847-121/2	1847-123/2	1847-125/2	1847-127/2



Specialty tools

Chassis – Cardan shafts



1847 Circlip pliers set



HAZET No.	L x W x H mm		EAN-No. 4000896+
1847-12/15	355x235x65	15	221288

1847 Components

Made in Germany



HAZET No.	EAN-No. 4000896+
• Circlip pliers	
1847-12	222117
• Half shell pair (∅ 19 mm)	
1847-121/2	221295
• Half shell pair (∅ 21.4 mm)	
1847-122/2	221301
• Half shell pair (∅ 22.3 – 23 mm)	
1847-123/2	221318
• Half shell pair (∅ 23.8 – 24.6 mm)	
1847-124/2	221325
• Half shell pair (∅ 26.2 – 26.9 mm)	
1847-125/2	221332
• Half shell pair (∅ 28.5 – 29.2 mm)	
1847-126/2	221349
• Half shell pair (∅ 30 mm)	
1847-127/2	221356

1847 Supplementary set

Made in Germany



- Half shell pair (∅ 32.8 mm)
- Supplement for 1847-12/15
- Easy, damage-free installation of the drive shaft joint VW T5 · T6
- Correct, centred insertion of the circlip, e.g. when mounting the hinge on the drive shaft
- Exact fit, safe storage in the circlip pliers set 1847-12/15 with supplied soft foam insert

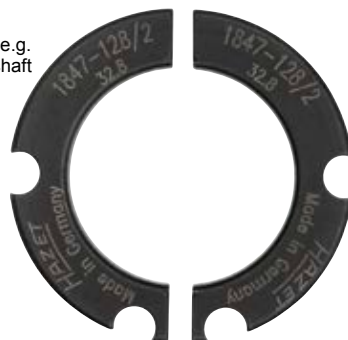

1/3			
-----	--	--	--



HAZET No.	EAN-No. 4000896+
1847-128/2	242009

3047 1/2" Impact socket · 12-point

Made in Germany

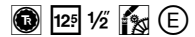

- Operating the 12-point cardan shaft screw connection ≤ 36 mm in the wheel hub

- With an external diameter of just 47 mm, considerably smaller than conventional standard sockets
- Optimally suited to the given spaces in the wheel hub
- For OPEL/VAUXHALL Corsa D 2006 → · Adam 2012 → · Mokka 2012 → · CHEVROLET Trax 2013 → · Also for BMW · SEAT and VW vehicles
- With borehole for locking pin or safety spring and groove for O-ring
- Surface: phosphatized, oiled
- DIN 3129, ISO 2725-2

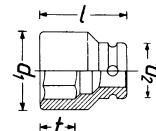

HAZET No.	s mm	l mm	d ₁ mm	d ₂ mm	f mm	EAN-No. 4000896+
3047-36	36	60	47	30	25	190683

900 SZ 1/2" Impact socket · 12-point

Made in Germany

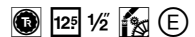

- With borehole for locking pin or safety spring and groove for O-ring
- Surface: phosphatized, oiled
- DIN 3129, ISO 2725-2

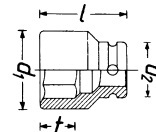

HAZET No.	l mm	d ₁ mm	d ₂ mm	f mm	EAN-No. 4000896+
-----------	------	-------------------	-------------------	------	------------------

- Operation of cardan shaft screw connection on VW Golf model year 2004 →, Touran model year 2004 →, Golf Plus model year 2006 →, Eos model year 2006 →, Scirocco model year 2009 →, Tiguan model year 2008 →, AUDI A3 model year 2004 →, TT model year 2007 →

900 SZ-24 44 35 30 17.5 115556

- Axle shaft nuts on VW Golf 4, Polo, New Beetle, AUDI TT 1.8, ŠKODA Octavia, Superb, Fabia

900 SZ-30 50 42 30 23.3 086573

- Operation of cardan shaft screw connection in the wheel hub on VW Touareg model year 2003 →

AUDI A4 model year 2001 →, A6 model year 2005 →, A8 model year 2003 →, Q7 model year 2007 →

900 SZ-32 50 44.5 30 22.2 115921

- Axle shaft nut on

– BMW 3 series · 5 series · 7 series · Z3 · M3 · VW Polo model year 2001 → · SEAT Ibiza model year 2002 →

– VW Golf Plus 1.9 TDi model year 2005 → · Polo 5

- Wheel hub screw connection on the front axle

RENAULT Twingo 3 and SMART (453) Fortwo / Forfour model year 2014 →

900 SZ-36 60 50 30 25 100132

990 LG 1/2" Screwdriver socket

Made in Germany

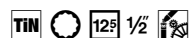

- Application: Install and remove cardan shafts on VW, AUDI (XZN screw M8)
- Long design
- With knurling
- Surface: TIN coated

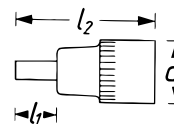

HAZET No.	s	l ₁ mm	l ₂ mm	d mm	EAN-No. 4000896+
990 LG-8	M8	62	100	23	047352



4935 Drive shaft disassembly / assembly set

Made in Germany

- Application: Disconnecting the drive shaft joint and pulling in the shaft through the wheel hub with just one tool
- Disconnecting the drive shaft joint from the shaft using the sleeves or spindles together with HAZET **sliding hammer 4797-1** (not included in delivery)
- Pulling in the drive shaft through the wheel hub on vehicles where the drive shaft is very difficult to pull through the wheel hub
- Suitable for all vehicle brands
- For drive shafts with outside and inside thread
- Contents (12-piece set):
 - 2 spindles (M14, M16) for pulling the drive shaft through the wheel hub or for disconnecting the articulated joint from the shaft in case of articulated joints with inside thread
 - 2 sleeves for supporting on wheel hub
 - 1 spindle nut
 - 7 screw sleeve adapters
 - M16 x 1.5 (VAG · MAZDA)
 - M18 x 1.5 (Volvo · SUZUKI · OPEL/VAUXHALL)
 - M20 x 1.5 (MERCEDES-BENZ · VAG · MITSUBISHI · MAZDA)
 - M22 x 1.5 (FIAT · PSA · BMW · FORD · OPEL/VAUXHALL · HYUNDAI)
 - M24 x 1.5 (RENAULT · BMW · MERCEDES-BENZ · OPEL/VAUXHALL · MAZDA · HONDA · VAG)
 - M27 x 1.5 (PSA · BMW · FORD)
 - M30 x 1.5 (MERCEDES-BENZ · PSA · BMW)

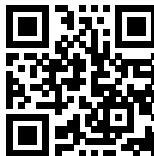

YouTube Clip

HAZET No.		EAN-No. 4000896+
4935-11/12	12	217434
Spindle nut for 4925-2505/9 · 4925-67/2 · 4927-2701/4 · 4935-11/12		
4925-11	–	168590
Spindle for 4935-11/12		
4935-111	–	217571
4935-112	–	217564
Extraction sleeve M16 x 1.5 for AUDI · SEAT · ŠKODA · VOLKSWAGEN · MAZDA		
4935-1116	–	217588
Extraction sleeve M18 x 1.5 for Volvo · SUZUKI · OPEL/VAUXHALL		
4935-1118	–	217601
Extraction sleeve M20 x 1.5 for MERCEDES-BENZ · AUDI · SEAT · ŠKODA · VOLKSWAGEN · MITSUBISHI · MAZDA		
4935-1120	–	217618
Extraction sleeve M22 x 1.5 for FIAT · PEUGEOT · CITROËN · BMW · FORD · OPEL/VAUXHALL · HYUNDAI		
4935-1122	–	217625
Extraction sleeve M24 x 1.5 for RENAULT · BMW · MERCEDES-BENZ · OPEL/VAUXHALL · MAZDA · HONDA · AUDI · SEAT · ŠKODA · VOLKSWAGEN		
4935-1124	–	217632
Extraction sleeve M27 x 1.5 for PEUGEOT · CITROËN · BMW · FORD		
4935-1127	–	217656
Extraction sleeve M30 x 1.5 for MERCEDES-BENZ · PEUGEOT · CITROËN · BMW		
4935-1130	–	217663
Clamping sleeve for 4935-11/12		
4935-1139	–	217670
4935-1146	–	217687

900 SZ 1/2" Impact socket set

Made in Germany

- Application: Operation of drive and cardan shaft screw connections, e.g. ≤ 24 mm for VW Touran model year 2006 → and Passat C ≤ 30 mm for axle shaft nut on VW Golf 4 · Polo and New-Beetle · AUDI TT 1.8 · ŠKODA Octavia · Superb · Fabia ≤ 32 mm operation of the cardan shaft screw connection in the wheel hub on VW Touareg model year 2003 → ≤ 36 mm for axle shaft nut on BMW 3 Series · 5 Series · 7 Series · Z3 · M3 VW Polo model year 2001 → Golf Plus 1.9 TDI model year 2005 → SEAT Ibiza model year 2002 → Wheel hub screw connection on the front axle RENAULT Twingo 3 · SMART (453) Fortwo / Forfour model year 2014 →
- Surface: phosphatized, oiled
- DIN 3129, ISO 2725-2

900 SZ · · 1/2"
24 · 30 · 32 · 36



HAZET No.		EAN-No. 4000896+
900 SZ/4	4	156375

2521 S 1/2" Impact socket set · with special profile

Made in Germany

- Optimised special profile for damage-free attachment of the flat-head lightweight nuts
- Application: For the operation of lightweight nuts with special profile for rear axle screw connections / camber adjustment e.g. AUDI A4 B9 model year 2015 → · A6 C8 model year 2018 →
- Surface: phosphatized

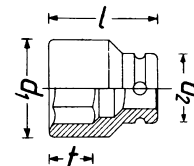

HAZET No.	l mm	d ₁ mm	d ₂ mm	t mm	EAN-No. 4000896+
2521 S-1	40	31	30	15	246571





Wheels / Tyres

772 Telescopic wheel nut wrench

Made in Germany

- Solid telescopic part, drop forged
- For series 900 sockets
- Surface: chrome-plated

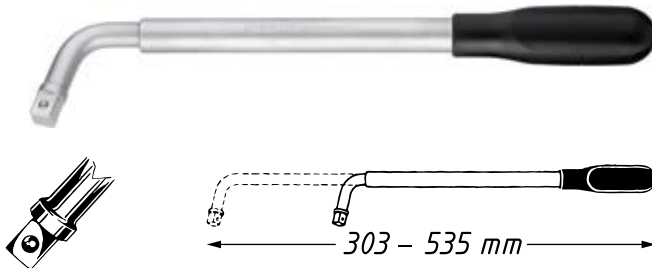
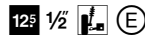

HAZET No.	l ₁ mm	l ₂ mm	EAN-No. 4000896+
772	303	535	030897

665 Balance weight pliers

Made in Germany

- Application: Installing, removing and cutting **balance weights**
- Also for expanding and compressing the retaining springs
- Surface: chrome-plated



HAZET No.	l mm	EAN-No. 4000896+
665	245	029204

Made in Germany

- Plastic head on the hammer side



- Application: Fastening, loosening and cutting off **balance weights**, as well as expanding and compressing the retaining springs
- Especially for **lacquered weights**
- Surface: chrome-plated



HAZET No.	l mm	EAN-No. 4000896+
665-1	245	029228

705 Four-way rim wrench

Made in Germany

- For passenger cars, vans and people carriers



- Surface: chrome-plated
- DIN 3119, ISO 6788



HAZET No.	S mm	l mm	EAN-No. 4000896+
705 N	17x19x13/16x21	380	029389
• With $12.5 = 1/2"$ for series 900 sockets			
705 V-02	17x19x22x $12.5 = 1/2"$	380	029396

Made in Germany

- For passenger cars, vans and people carriers



- Surface: chrome-plated
- DIN 3119, ISO 6788
- Firmly secured sleeves to prevent scratches in the rim hole
- Coloured sleeves for quick recognition of wrench sizes
- All common wrench sizes in one
- With $12.5 = 1/2"$ for series 900 sockets



YouTube Clip

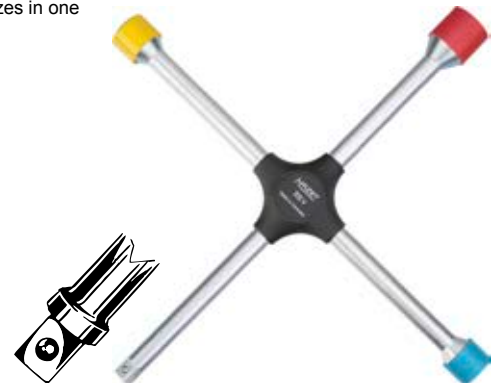

HAZET No.	S mm	l mm	EAN-No. 4000896+
705 V	17x19x21x $12.5 = 1/2"$	380	196388

650 Tyre lever

Made in Germany

- Double-T profile ensures high stability
- Surface: chrome-plated



HAZET No.	l mm	EAN-No. 4000896+
650-8	199	028672
• For passenger cars and vans		
650-12	303	028627
650-16	396	028634
650-20	500	028641
650-24	598	028658



650 K Tyre lever

Made in Germany

- Screwed, replaceable plastic coating



- Application: Installing and removing tyres on steel and esp. on aluminium rims
- Surface: chrome-plated

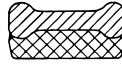

HAZET No.	l mm	EAN-No. 4000896+
650 K-20	500	028696

650 RF Run-flat tyre lever

Made in Germany



- Optimised construction (reinforced, rounded, blunt edges) to prevent damage to the tyre casing
- Plastic protective sleeve prevents scratching of the rim and protects against slippage
- Application: Safe and damage-free installation, especially of run-flat and low profile tyres
- The reinforced tyre wall on run-flat tyres and low profile tyres is significantly more rigid than the casing of conventional tyres. Using a less than optimal lever leads to tyre damage.
- Set consisting of run-flat tyre lever 650RF and plastic protective sleeve 650RF-01



HAZET No.	l mm	EAN-No. 4000896+
650 RF/2	535	206896

652 Tyre lever

Made in Germany

- For commercial vehicles · agricultural and construction machinery
- Heavy design



HAZET No.	l mm	EAN-No. 4000896+
652	600	028702

653 Tyre lever

Made in Germany

- Especially for tubeless tyres
- Heavy design



HAZET No.	l mm	EAN-No. 4000896+
653	456	028719

666 Valve tool

Made in Germany

- Application: For installing and removing tyre valve cores
- Pushing in the valve pin when deflating the tyre, e.g. on passenger cars, vans and commercial vehicles



666 Valve tool



HAZET No.	EAN-No. 4000896+
666-1	087136

666 Tyre tread depth gauge

Made in Germany

- Graduation in 0.1 mm steps for an exact determination of the tread depth



- Application: Measure tyre profile depth
- Glare-free reading
- Measuring depth 30 mm
- Lightweight and easy to handle
- Very robust – made of hard brass
- In practical storage case



HAZET No.	EAN-No. 4000896+
666-5	129164

666 Pliers for wheel nut caps

Made in Germany

- The pliers' jaw tips are specially shaped for the protection caps



- Application: Damage-free removal of the wheel bolt protection caps on alloy rims
- On e.g. AUDI · VW · OPEL/VAUXHALL
- Surface: bright chrome-plated, handle with dip coating



HAZET No.	l mm	EAN-No. 4000896+
666-10	160	110575

654 Universal axle lever

- Various application; pivoting and 6 position adjustment



- Application: Removal of ball joints, wishbones and further axle components



HAZET No.	EAN-No. 4000896+
654-1	161089



Electricity / Battery service

Electrical testing

2152N Electronic set

• Torque tester for motor vehicle electricity and electronics



- Application: **Troubleshooting in electronic components**
- **3–48 V**
- Voltage display: LED 5 V · 12 V · 24 V · 48 V
- Polarity display: LED for positive or negative, AC voltage with illuminated LED
- Probe tip, needle with sliding mechanism,
- Additional: Crocodile clip and probe tip for attaching
- Cable length: 1300 mm



HAZET No.		EAN-No. 4000896+
2152N/3	3	204151
Basic unit for HAZET electronic set 2152N/3		
2152N	–	204205
Crocodile clip for HAZET electronic set 2152N/3		
2152N-01	–	204199
Test tip for 2152N/3		
2152N-02	–	204182

2152 Electrical system multifunction torque tester

• **Made in Germany**



• LED display and integrated lighting

- Application: For testing electrical components, e.g. electrical fuel pumps, relays, lamps, window lift motors, etc.
- Especially for the workshop area (motorcycles, passenger cars, commercial vehicles, boats)
- 12–24 Volt
- 6 m cable and integrated lighting
- Short circuit proof 7.5 A
- **Optimal lighting of the inspection area**
- **Several acoustical signals**
- **Immediate checking of polarity due to LED-display red/green**
- Detects bonding defaults
- Continuity test: e.g. relays, safety fuse, switches, wiring, etc.
- Self-testing function



HAZET No.	EAN-No. 4000896+
2152-5	144440

2153 Car light tester

• **Made in Germany**



- Probe tip (10 mm long) and protection cap
- Cable with crocodile clip
- 6–24 Volt
- Tester with soffit

Not to be used on vehicles with electronic components. For vehicles with electronic components see HAZET 2152N/3

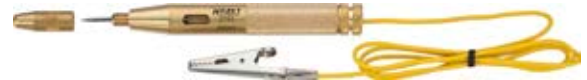

HAZET No.	l mm	EAN-No. 4000896+
2153	120	013111

2152 Multimeter



- For trade, industry, do-it-yourselfers as well as car, commercial vehicle and agricultural workshops
- Including measuring tips for clipping into the protective cover
- Including temperature probe from -20°C to 200°C
- DC voltage: 0 - 600 V
- AC voltage: 0 - 600 V
- Direct current: 0 - 10 A
- Alternating current: 0 - 10 A
- Resistance: 0 - 60 MOhm
- Diode test
- During the continuity test, the integrated buzzer signals continuity below 50 Ohm
- Frequency: 0 - 10 MHz
- Duty cycle
- Capacitance measurement: 0 - 60 MOhm
- Automatic switch-off
- Backlight
- Data hold
- True RMS
- CAT III 600 V
- Including 2x AA batteries
- Easy operation thanks to clearly arranged control panel and large illuminated LCD display (all data quickly readable)
- Very short response times ensure rapid display of measurement results
- Optimal device alignment thanks to the stand on the housing
- Protective cover protects multimeter against damage from being dropped



HAZET No.	EAN-No. 4000896+
2152-600	246762



Battery service

4650 Battery filler

Made in Germany



HAZET No.	l mm	EAN-No. 4000896+
4650-0	256	022007

4650 Acid tester

Made in Germany



• Aerometer

- Application: Checking the acid content of the battery fluid
- Solid plastic housing – significantly reduced risk of breakage compared to glass enclosures



HAZET No.	l mm	EAN-No. 4000896+
4650-1	280	022014

4650 Special tool for battery plugs

Made in Germany



- Special length allows universal application in areas with restricted access

- Application: Screwing battery plugs in and out
- Profile is especially suitable for battery plugs
- 2-component T-handle
- Surface: chrome-plated



HAZET No.	l mm	$\frac{a}{b}$ mm	b mm	EAN-No. 4000896+
4650-3 A	95	1.7	14.5	249275

4650 Battery pole and terminal brush

Made in Germany



- Application: Cleaning the terminal posts and clamps
- With protection cap



HAZET No.	l mm	EAN-No. 4000896+
4650-4	120	022038

4650 Battery cell tester

Made in Germany



- Measuring range 6 and 12 volt for application on passenger cars and motorcycles

- Application: Fast diagnosis of the charging system and state of the battery



HAZET No.	l mm	EAN-No. 4000896+
4650-5	333	022045





Specialty tools

Electricity / Battery service – Contacts / Plug connections



Contacts / Plug connections / Cable release tool

Cable release tool

- For professional working
- High ease of use
- Safe application
- OEM quality "Made in Germany"
- Malfunctions due to loose contacts can be remedied easily, quickly and professionally
- Universal application in the field of car electricity
- With sliding caps protecting the blades from damage and avoiding the risk of injury

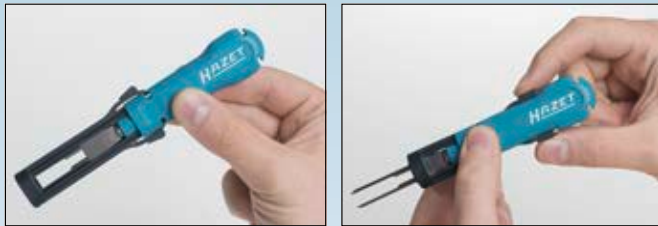

4670 Cable release tool assortment

Made in Germany

- Application: Damage-free releasing of plug contacts e.g. flat and round plug contacts
- For professional working
- High ease of use
- Safe application
- OEM quality "Made in Germany"
- Malfunctions due to loose contacts can be remedied easily, quickly and professionally
- Universal application in the field of car electricity
- With sliding caps protecting the blades from damage and avoiding the risk of injury
- Plastic box
- Soft foam insert
- Supplementary set for VW · AUDI · SEAT · ŠKODA



HAZET No.		EAN-No. 4000896+
4670-4/10	10	135530

Made in Germany

- Application: Damage-free releasing of plug contacts e.g. flat and round plug contacts
- For professional working
- High ease of use
- Safe application
- OEM quality "Made in Germany"
- Malfunctions due to loose contacts can be remedied easily, quickly and professionally
- Universal application in the field of car electricity
- With sliding caps protecting the blades from damage and avoiding the risk of injury
- Plastic box
- Soft foam insert



HAZET No.		EAN-No. 4000896+
4670-5/12	12	135646

4670 Cable release tool assortment

Made in Germany

- Application: Damage-free releasing of plug contacts e.g. flat and round plug contacts
- For professional working
- High ease of use
- Safe application
- OEM quality "Made in Germany"
- Malfunctions due to loose contacts can be remedied easily, quickly and professionally
- Universal application in the field of car electricity
- With sliding caps protecting the blades from damage and avoiding the risk of injury
- Plastic box
- Soft foam insert
- **Basic set** - for approx. 80% of all passenger car plug contacts



HAZET No.		EAN-No. 4000896+
4670-1/12	12	132898



4672 Cable release tool

Made in Germany

- Application: Damage-free unlocking of **blade terminal contacts**
- **For professional working**
- **High ease of use**
- **Safe application**
- OEM quality "Made in Germany"
- Malfunctions due to loose contacts can be remedied easily, quickly and professionally
- Universal application in the field of car electricity
- With sliding caps protecting the blades from damage and avoiding the risk of injury



HAZET No.	EAN-No. 4000896+
• Micro Timer II · Micro Timer II 4672- 1	135042
• JPT / SPT 4672- 4	135165
• Flat connectors with 2 snap-in pins / contact width 4.8 mm (e.g. ISO-connector car radio) 4672-12	135578

4673 Cable release tool

Made in Germany

- Application: Damage-free releasing of **micro-standard timer, secondary locking and various lock catches**
- **For professional working**
- **High ease of use**
- **Safe application**
- OEM quality "Made in Germany"
- Malfunctions due to loose contacts can be remedied easily, quickly and professionally
- Universal application in the field of car electricity
- With sliding caps protecting the blades from damage and avoiding the risk of injury



HAZET No.	EAN-No. 4000896+
• Micro Standard 4673-1	134946

4675 Unlocking tool · plug connections · VAG

Made in Germany

- **VAG group plug connections · SCANIA · MAN TGE / TGX model year 2020→**, e.g. injectors · rail pressure sensors · fluid level sensors · ignition coils · vacuum sensors · brake wear sensors · pressure regulators · lighting systems



Video



HAZET No.	l_1 mm	l_2 mm	EAN-No. 4000896+
• Damage-free unlocking of electrical plug connections on various components and sensors 4675-1	71	130	244331
• Extra-long blade, curved at the head allows access to hard-to-reach places • Head offset 20 mm • Damage-free unlocking of electrical plug connections on various components and sensors 4675-2	132	191	244348

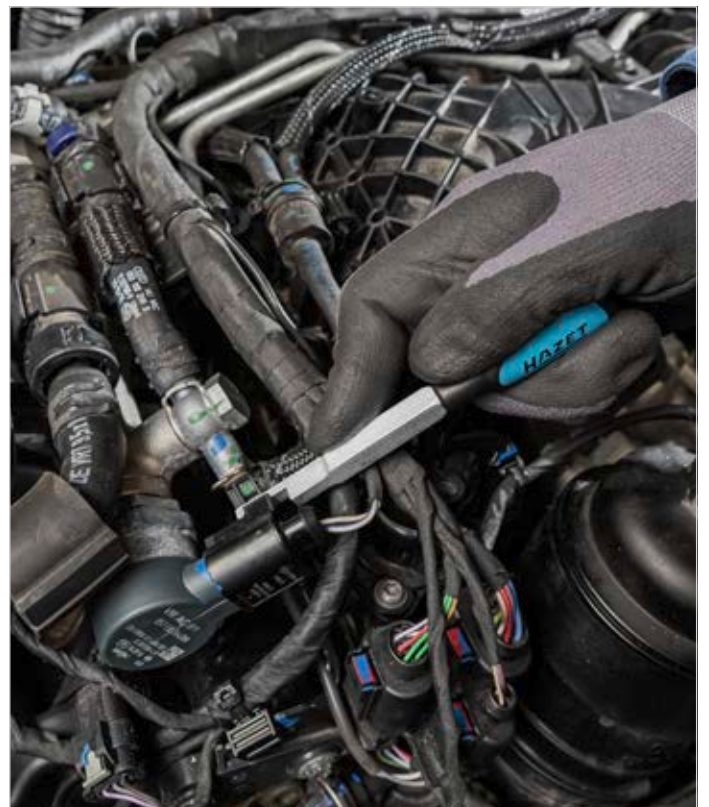



Specialty tools

Electricity / Battery service – Alternator / Radio removal



Alternator / Radio removal

2592 V-(ribbed) belt pulley adapter

Made in Germany

• Adapter with internal serration

• Application: Installation or removal of the V-(ribbed) belt pulley at the generator
For e.g. VALEO, BOSCH etc. on VW · AUDI · ŠKODA · SEAT



HAZET No.	S mm	l mm	Ø mm	EAN-No. 4000896+
2592	19.6	30	17	057443

4641 V-(ribbed) belt pulley tool

Made in Germany

• Application: Installation or removal of the V-(ribbed) belt pulley at the generator (BOSCH)
• VW · AUDI · ŠKODA · SEAT · PORSCHE · MERCEDES-BENZ · FORD · Volvo etc.

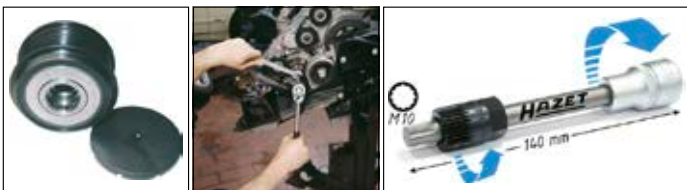
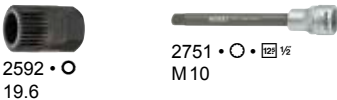

HAZET No.	l mm	Ø mm	EAN-No. 4000896+
4641/2	140	2	081479

Made in Germany

• Application: Installing and removing the V-(ribbed) belt pulley at generators
• Assembly tool set for working on the built-in or dismantled generator
• Control of the screw connection
• TORX® and XZN screwdriver sockets for different inside profiles
• The generator is locked with the respective screwdriver socket and the screw connection of the belt pulley is operated with the adapter with internal serration
• Application on VW · AUDI · ŠKODA · SEAT · PORSCHE · MERCEDES-BENZ · FORD · RENAULT · Volvo etc.



4641 V-(ribbed) belt pulley tool

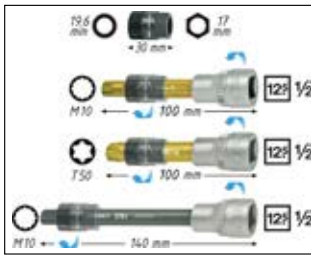

2592 · Ø 19.6

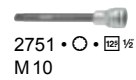

2751 · Ø M10

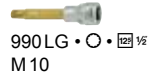

990 LG · Ø M10



992 LG · Ø T50

HAZET No.	Quantity	EAN-No. 4000896+
4641/4	4	103157

4655 Radio dismantling tool

• All applications in one tool – no need to search the right tool

• Application: Installation and removal of car radios of numerous car and radio manufacturers
• VW · AUDI · FORD · BMW · MERCEDES-BENZ · PORSCHE · GM OPEL / VAUXHALL · ŠKODA · FIAT · LAND-ROVER · KENWOOD · SONY · CLARION · BLAUPUNKT and many others
• Very easy to handle
• Practical slide for separating both halves
• Many unlocking types in one compact tool

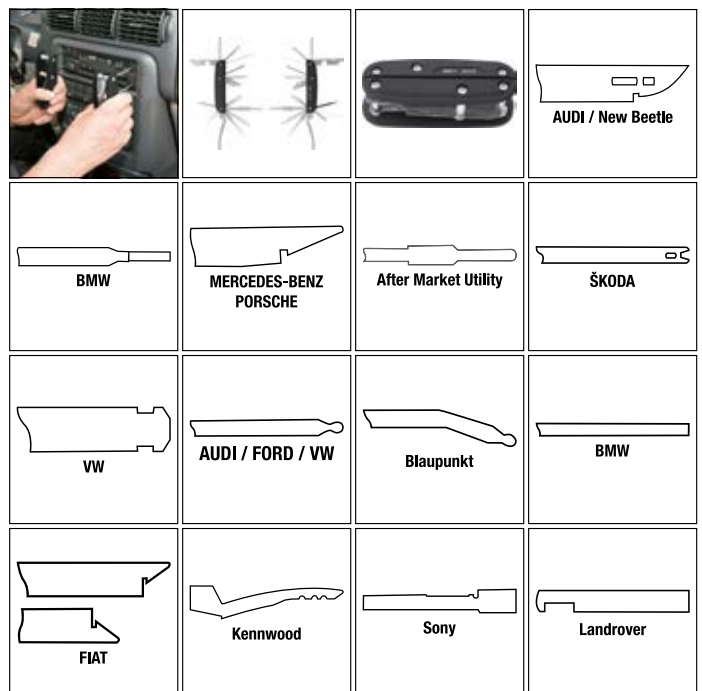

HAZET No.	EAN-No. 4000896+
4655-1	120666



Body and interior equipment

Car body repair

For grip pliers see chapter Hand Tools / Pliers on page 239–240

0-1900 Tool assortment

Made in Germany
Assortment for car bodies
• For tool trolleys *Assistant*



- | | | | |
|--|---|------------------|-------------------|
| 428 • ●
6 • 7 • 8 • 10
11 • 13 | 821-2 | 1927 | 1960-5 |
| 600 N • ●
8 • 9 • 10 • 11
12 • 13 • 14 • 15
17 • 19 • 22 • 24 | 900 • ● $\frac{1}{2}$
10 • 11 • 12 • 13
15 • 17 • 19 • 22 | 1929-1 | 1961 L-2 |
| 745-3 | 916 HP • $\frac{1}{2}$
917-5 • $\frac{1}{2}$ $\frac{1}{2}$ $\frac{1}{2}$ | 1930 | 1961 R-2 |
| 745 A-6 | 918-10 • $\frac{1}{2}$ $\frac{1}{2}$ $\frac{1}{2}$ | 1931 | 1965/5 |
| 746-1 | 918-10 • $\frac{1}{2}$ $\frac{1}{2}$ $\frac{1}{2}$ | 1934 | 2130 |
| 757-10 | 1810-250 | 1934-1 | 2140 |
| 760-2 | 1851-44 | 1934-4 | 2140-30 • 2140-50 |
| 799-3 | 1917 N | 1934-9 • 1934-10 | 2143 |
| 801 NK • ●
1 x 5.5 | 1919 N | 1934 | 2165 |
| 803 • ●
0.4 x 2.5 • 1 x 5.5
1.2 x 6.5 • 1.2 x 8
1.6 x 10 | 1920 N | 1937 K | 2165-1 • 2165-2 |
| 803-PH • ●
PH1 • PH2 • PH3 | 1921 | 1940 | |
| | 1922 | 1944-1950 | |
| | 1923 | 1950 | |

HAZET No.		EAN-No. 4000896+
0-1900/77	77	000241

1905 Body and fender tool set

Made in Germany
• For car body work
• Sheet metal box (HAZET blue)
• Soft foam insert



- | | | | |
|--------|--------|------|--------|
| 1911 | 1928 K | 1934 | 1938 K |
| 1917 N | 1930 | 1935 | 1940 |
| 1919 N | 1931 | | |

HAZET No.	L x W x H mm		EAN-No. 4000896+
1905/10 N	759x305x115	10	007448

1911 Hand anvil

Made in Germany
• Roof wedge-shaped
• Length: 137 mm,
width: 55 mm



HAZET No.	EAN-No. 4000896+
1911	007486

1917 N Hand anvil

Made in Germany
• Daimler Stöckle
• 110 x 50 mm,
height: 50 mm



HAZET No.	EAN-No. 4000896+
1917 N	007509

1918 N Hand anvil

Made in Germany
• Wedge-shaped
• 110 x 63 mm



HAZET No.	EAN-No. 4000896+
1918 N	007516



Specialty tools

Body and interior equipment – Car body repair



1919 N Hand anvil

Made in Germany

- Toe-shaped
- 120x58 mm, height: 20 mm



HAZET No.	EAN-No. 4000896+
1919 N	007523

1920 N Hand anvil

Made in Germany

- Universal
- 76x56 mm and 65x47 mm, height: 60 mm



HAZET No.	EAN-No. 4000896+
1920 N	007530

1921 Hand anvil

Made in Germany

- All-sides ground
- Heel-shaped, flat/halfround
- 84x62 mm, height: 34 mm



HAZET No.	EAN-No. 4000896+
1921	007554

1922 Hand anvil

Made in Germany

- "Diabolo" style
- 59x61 mm, height: 59 mm



HAZET No.	EAN-No. 4000896+
1922	007561

1923 Box file

All sides with cut of a file

- Application: Body sheet planishing
- Work surface 162x37x27 mm



HAZET No.	EAN-No. 4000896+
1923	007578

1927 General purpose spoon

Made in Germany

- Work surface 52x150 mm



HAZET No.	l mm	EAN-No. 4000896+
1927	275	007691

1928 K General purpose spoon

Made in Germany

- Cut on one side
- Work surface 60x30x200 mm



HAZET No.	l mm	EAN-No. 4000896+
1928 K	385	007707

1929-1 General purpose spoon

Made in Germany

- Wide shape
- Offset and curved
- Work surface 170x50 mm



HAZET No.	l mm	EAN-No. 4000896+
1929-1	480	007721

1930 General purpose spoon

Made in Germany

- Wide shape
- Deep offset and heavily curved



HAZET No.	l mm	EAN-No. 4000896+
1930	455	007738

1930-1 General purpose spoon

Made in Germany

- Narrow shape
- Work surface 105x85x38 mm



HAZET No.	l mm	EAN-No. 4000896+
1930-1	315	007745

1931 Bending iron

Made in Germany

- With leather cap



HAZET No.	l mm	EAN-No. 4000896+
1931	410	007769



1932 Flange tool

Made in Germany

• Crimping capacity: 12 mm



- Application: Form crimping edges on metal sheets up to 1 mm thickness
- Plastic handle covers
- Surface: chrome-plated

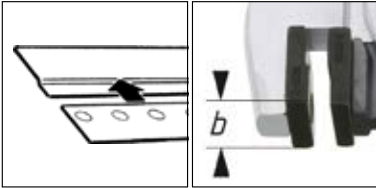

HAZET No.	l mm	b mm	EAN-No. 4000896+
1932-1	300	15	007806
1932-2	300	30	007868

1964 Sheet metal punch

Made in Germany

• To be used with HAZET Flange Tool 1932



- Plastic handle covers
- Surface: chrome-plated



HAZET No.	l mm	Ø mm	EAN-No. 4000896+
• For sheet metal punching up to 1 mm during spot-welding (MAG-welding)			
1964-50	300	5	009039
1964-55	300	5.5	009077
1964-70	300	7	009121

1960 Car body sheet metal chisel

Made in Germany

• Forged design



- Application: Cutting sheet metal, welding spots, welding grooves etc.
- Hand guard (730HS)
- Blade size: 7 x 26 mm
- Consistently hardened as per DIN (54-58 HRC)
- Impact head tempered as per DIN (38-46 HRC)
- Blades ground
- Regrinding without rehardening
- Surface: immersion-lacquered



HAZET No.	l mm	EAN-No. 4000896+
1960-5	240	008759

1961 Sheet metal profile snips

- For figure cutting and short, straight cuts
- For sheet metal up to 1.8 mm, VA-steel sheets up to 1.2 mm
- With lever transmission system
- Shear head drop-forged, hardened and tempered
- Induction-hardened cutting edges with grind
- Ergonomically shaped HAZET 2-component plastic handle covers (blue/black)



HAZET No.	l mm	EAN-No. 4000896+
• R = right hand cutting		
1961 R-1	260	008803
• L = left hand cutting		
1961 L-1	260	008780

- For figure cutting and straight cuts
- With lever transmission system
- Shear head drop-forged, hardened and tempered
- Induction-hardened cutting edges with grind
- Ergonomically shaped HAZET 2-component plastic handle covers (blue/black)



HAZET No.	l mm	EAN-No. 4000896+
• R = right hand cutting		
1961 R-2	260	008810
• L = left hand cutting		
1961 L-2	260	008797





Specialty tools

Body and interior equipment – Car body repair



1961 Sheet metal profile snips

- Compact design facilitates working in confined spaces and cutting the smallest of contours



- For figure cutting and straight cuts
- For sheet thickness up to 1.2 mm (600 N/mm²)
- Edge length: 20 mm
- Lever transmission system for a minimum effort
- For small radii and working in areas with restricted access
- Shear head drop-forged
- Induction-hardened cutting edges with grind
- Ergonomically shaped HAZET 2-component plastic handle covers (blue/black)



1961 L-3

1961 R-3

HAZET No.	l mm	EAN-No. 4000896+
• Left hand cutting 1961 L-3	180	176533
• Right hand cutting 1961 R-3	180	176540

1963 Hand riveting tool

- Application: Safe and fast rivet joints
- For **blind rivets** made of aluminium up to 5 mm Ø, steel up to 4 mm Ø, stainless steel up to 3.2 mm Ø
- Rivet is fixed automatically when inserting the nose piece
- Quick changing of nose pieces due to knurling, no tools needed
- Rivet snaps off with little effort
- Due to the design, the slitting process of the rivet pin is optimally damped
- Patented rivet plug gauge
- Assembly tool in the handle



HAZET No.	l mm	EAN-No. 4000896+
1963 N-1	255	187447

- Flexible use due to 360° rotation rivet head



- Application: Riveting various materials such as metal, aluminium, plastic, leather, etc.
- 4 replaceable nose pieces in the body of the pliers
- Assembly tool in the handle
- Patented rivet plug gauge
- For aluminium rivets Ø 2.4 · 3.0 · 3.2 · 4.0 · 4.8 · 5.0 mm · 3/32" · 1/8" · 9/32" · 3/16"
- Steel rivets Ø 2.4 · 3.0 · 3.2 · 4.0 mm · 3/32" · 1/8" · 9/32"
- Stainless steel rivets Ø 2.4 · 3.0 · 3.2 mm · 3/32" · 1/8"

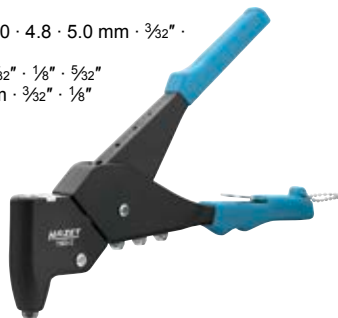

HAZET No.	l mm	EAN-No. 4000896+
1963-2	290	232864

1934 Car body file holders

- **Made in Germany**

- Adjustable, with tightening screw
- With 1 file blade 1934-4
- For flat file blades HAZET 1934-1 up to -5



HAZET No.	l mm	EAN-No. 4000896+
1934	355	008018

1934 N Car body file holders

- **Made in Germany**

- Made of wood
- Without file blade



HAZET No.	l mm	EAN-No. 4000896+
• For flat file blades 1934-1 up to -5 1934 N-1	525	008155
• For half-round (hollow) file blades 1934-7 1934 N-2	525	008179

1934 Car body file blade

- Flat
- Milled, diagonal cut
- Teeth (cut):
1 = coarse 1934-1
2 = medium 1934-2
3 = fine 1934-3
- For file holders HAZET 1934 and 1934N-1
- DIN 7264 form A



HAZET No.	l mm	EAN-No. 4000896+
1934-1	350	008025
1934-2	350	008063
1934-3	350	008070

- Flat
- Milled, curved cut
- Teeth (cut):
1 = coarse 1934-4
2 = medium 1934-5
- For file holders HAZET 1934 and 1934N-1
- DIN 7264 form A



HAZET No.	l mm	EAN-No. 4000896+
1934-4	350	008087
1934-5	350	008094



1934 Car body file blade

- Half-round (hollow)
- Diagonal cut
- Teeth (cut): 1 = coarse
- For file holder HAZET 1934N-2
- DIN 7264 form F



HAZET No.	l mm	EAN-No. 4000896+
1934-7	350	008100

1934 Car body file

Made in Germany

- Heat the metal with a welding torch. Then work the metal with the file. Due to the special alloy, the heat will be extracted when working the metal with the file and the metal will be planished

- Cross cut
- Teeth (cut):
1 = coarse (1934-8)
3 = fine (1934-9)
- Cranked
- Plastic handle

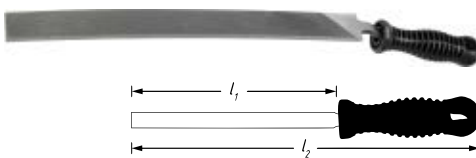

HAZET No.	l ₁ mm	l ₂ mm	EAN-No. 4000896+
1934- 8	350	430	008124
1934- 9	350	430	008131

- Single cut
- Teeth (cut):
0 = coarse - 1934-10

1934-10	350	430	008032
---------	-----	-----	--------

1935-1938 K Car body hammer

Made in Germany

- HICKORY handle



HAZET No.	l mm	Ø mm	EAN-No. 4000896+
• Bumping and planishing hammer			
• 154 mm			
• 2 round faces of different sizes			
1935	308	○ 40 • 30	008193
• Stretching and planishing hammer			
• 103 mm			
• Round faces, finely chequered, milled			
1937 K	305	□ 24 ○ 32	008209
• Stretching and planishing hammer			
• 96 mm			
• Round faces, finely chequered, milled			
1938 K	310	□ 35 ○ 40	008216

1940-1943 Car body hammer

Made in Germany

- HICKORY handle



HAZET No.	l mm	Ø mm	EAN-No. 4000896+
• Planishing and embossing hammer			
• 160 mm			
• Round face and ball			
1940	309	○ 40 • 17	008230
• Planishing and cross-peen hammer			
• 135 mm			
• Round face and curved, sharp pin			
1943	309	○ 40 — 15	008261

1944-1950 Car body hammer

Made in Germany

- HICKORY handle



HAZET No.	l mm	Ø mm	EAN-No. 4000896+
• Bumping and picking hammer			
• 165 mm			
• Rounded face and straight calibration pin			
1944	325	○ 41 • 10	008278
• Aluminium hammer			
• Flat, half-round			
1950	310	○ 30	008339

1967 Welding spot drill

Made in Germany

- Application: Precise welding of welding spots in sheet metal processing
- Suitable for drills

- 7 mm hexagon shank prevents slippage in drill chuck
- Replaceable cutting crown (right-hand thread) made of high-speed steel (oiled)
- Cutting crown for use at both ends
- With screw for gauge depth adjustment (*)

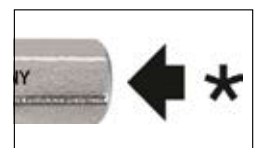

HAZET No.	l mm	Ø mm	EAN-No. 4000896+
1967	70	11	009312



Specialty tools

Body and interior equipment – Car body repair



1967 Welding spot drill

Made in Germany

• Self-cutting centring tip
resharpenable



- Application: Exact reaming of welding spots
- High performance, high-speed steel, blued



HAZET No.	l mm	Ø mm	EAN-No. 4000896+
1967-70	74	7	009343
1967-80	79	8	009350
1967-90	79	9	009367

1959 Special bumping mallet

Made in Germany

• Permanently plastic filler
for non-damaging work without striation



- Application: Attaching decorative strips, working on roof rails as well as seat installing, upholstery
- Assembly tool for materials that are susceptible to scratching



HAZET No.	l mm	EAN-No. 4000896+
• Rubber body 70 x 70 mm 1959-2	260	102259
• Handle adjustable by 90° • Rubber body 70 x 140 mm 1959-3	280	008728
• Handle adjustable by 90° • White rubber body 70 x 140 mm 1959-4	280	127221

1965 Soldering wedge

Made in Germany

- Application: Working with hot-tinned surfaces
- Beech wood



HAZET No.	l mm	EAN-No. 4000896+
1965/5	5	009220

1965 Wedge

Made in Germany

• Application: For car body work, e.g. for loosening decorative strips, covers, graphics, etc. without damage



- Plastic
- Tip 0.5 mm



HAZET No.	l mm	h mm	b mm	EAN-No. 4000896+
1965-20	190	25	30	009183

1965 Combination lever

• Avoids damage to lacquered surfaces, plastic and metal parts



- Application: Quick and easy loosening of the decorative strips and door panels
- Operation of plugs and plastic clips
- Removal of protection caps and covers



HAZET No.	l mm	b mm	EAN-No. 4000896+
1965-21	270	22	087839

1965-22 Extractor hook

Made in Germany

• High stability and flexibility despite small blade diameter (Ø 2 mm)



- Application: For the removal of e.g. trims · covers · plugs · fan nozzles · instrument panels · speedometer · instrument clusters inside the vehicle as well as on the car body

- Hook 6 mm · bent 80°
- 2-component T-handle

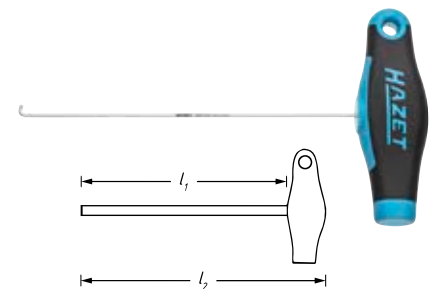

HAZET No.	l ₁ mm	l ₂ mm	EAN-No. 4000896+
1965-22 A	146.5	180.5	247448

799 Lever for removing door panels

Made in Germany

• Protective coating



- Application: Removing fixing plugs from door panels
- Jaw opening: 16 mm to 7 mm
- Width: 28 mm



HAZET No.	l mm	EAN-No. 4000896+
799-3	268	031993



799 Pliers for removing door panels

- Made in Germany**
- Protective coating

Application: Removing the fixing plugs on **door panels**, decorative strips and bumper rubber strips



HAZET No.	l mm	EAN-No. 4000896+
799-4	230	032013

828 LG-T Screwdriver · with T-handle

- Made in Germany**

- Application: Installation and removal **door handle** on **MERCEDES-BENZ** type 168 · type 169 (A-Class) · type 245 (B-Class) · type 203 (C-Class) · type 204 (C-Class) · type 212 (E-Class) · 117 CLA Setting **headlights** **MERCEDES-BENZ** Actros
- Extra long design**
- Round blade
- Ergonomically shaped HAZET 2-component T-handle
- Surface: chrome-plated, tips burnished

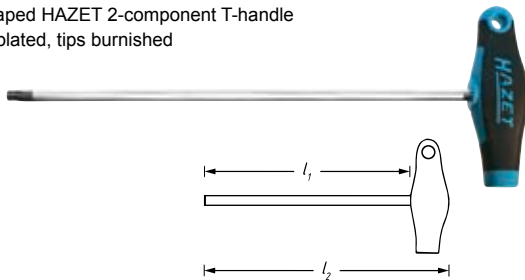

HAZET No.	l ₁ mm	l ₂ mm	mm	EAN-No. 4000896+
828 LG-T20	200	226	3.86	139941

2597 Insert tool for door hinges · bent bit holder

- Made in Germany**

- Torque-controlled screw tightening possible (Please follow the instructions of the manufacturer)**

- Application: Installing, removing and adjusting the front and rear doors
- Plug connection 9 x 12 mm square
- With **TORX** Bit T45 (HAZET 2597-01)
- Removal** together with tool holder HAZET 6396, **installation** with torque wrench HAZET 6290-1CT · 5290-3CT
- VW** Observe torque regulations
- Surface: chrome-plated

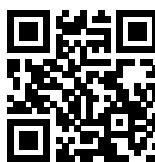

YouTube Clip

HAZET No.	l mm	EAN-No. 4000896+
2597	95	017379

2597 Bit

- Made in Germany**

- Torque-controlled screw tightening possible (Please follow the instructions of the manufacturer)**

- Application: Installing, removing and adjusting the driver and passenger door
- Removal or loosening together with tool holder HAZET 6396
- Installation with torque wrench HAZET 6290-1CT or 5290-3CT
- Together with curved bit holder HAZET 2597
- Hexagon drive ISO 1173 C8 (5/16")
- VW** · **SKODA** Fabia 2 model year 2007 → 2014 · Roomster model year 2006 → 2015, **AUDI** A5 model year 2007 → 2016
- For inside **TORX** screws T45



HAZET No.	l mm	EAN-No. 4000896+
2597-01	18	017386

- Made in Germany**

- Torque-controlled screw tightening possible (Please follow the instructions of the manufacturer)**

- Application: Installing, removing and adjusting the driver and passenger door
- Removal or loosening together with tool holder HAZET 6396
- Installation with torque wrench HAZET 6290-1CT or 5290-3CT
- Together with curved bit holder HAZET 2597
- Blister packed
- Hexagon drive ISO 1173 C8 (5/16")
- VW** Golf 4 model year 1997 → 2006 · Golf 7 model year 2012 → 2021 · Passat B5 model year 1996 → 2000, **SEAT** León model year 1999 → 2006
- For **screws with internal serration (XZN) M10**
- Similar to DIN 65254



HAZET No.	l mm	EAN-No. 4000896+
2597-02	21	066667

- Made in Germany**

- Torque-controlled screw tightening possible (Please follow the instructions of the manufacturer)**

- Application: Installing, removing and adjusting the driver and passenger door
- Removal or loosening together with tool holder HAZET 6396
- Installation with torque wrench HAZET 6290-1CT or 5290-3CT
- Together with curved bit holder HAZET 2597
- Blister packed
- Hexagon drive ISO 1173 C8 (5/16")
- VW** Golf 5 model year 2003 → 2008 · Golf 6 model year 2008 → 2012 · Passat B6 model year 2005 → 2010 · Caddy model year 2004 → 2010 · Beetle model year 2011 → 2019 · Sharan 2 model year 2010 → · Tiguan model year 2011 → · Touran model year 2010 →, **SKODA** Superb model year 2008 →
- For **screws with internal serration (XZN) M8**
- Similar to DIN 65254



HAZET No.	l mm	EAN-No. 4000896+
2597-03	21	118830

- Made in Germany**

- Torque-controlled screw tightening possible (Please follow the instructions of the manufacturer)**

- Application: Installing, removing and adjusting the driver and passenger door
- Removal or loosening together with tool holder HAZET 6396
- Installation with torque wrench HAZET 6290-1CT or 5290-3CT
- Together with curved bit holder HAZET 2597
- Hexagon drive ISO 1173 C8 (5/16")
- VW** Polo 6 model year 2017 → · T-Cross model year 2018, **SKODA** Fabia 3 model year 2014 →, **Porsche** Panamera
- For **screws with internal serration (XZN) M12**



HAZET No.	l mm	EAN-No. 4000896+
2597-04	21	241972



Specialty tools

Body and interior equipment – Car body repair



2597 Bit

Made in Germany

• T45 with special length



- Application: Installing and removing the driver's and front passenger's door on **VW**
- Together with fine-tooth reversible ratchet for bit 863HPB or reversible ratchet head 6408 and torque wrench 6290-1CT · 5290-3CT – observe **VW** torque regulations –
- Hexagon drive ISO 1173 C6.3 (1/4")



HAZET No.	l mm	EAN-No. 4000896+
2597-T45	25	017393

2598 Door handle tool

Made in Germany

• Safe and fast working



- Application: Operation of the difficult-to-reach locking hook (bearing cap) when removing / installing the door handle
- Disassembly and assembly of the closing cylinder housing (door handle) with doors without closing cylinders
- For e.g. **VW** Passat model year 2005 → 2010 · Tiguan model year 2008 → · Golf 6 model year 2008 → 2012 · Golf 7 model year 2012 → 2021 · Amarok model year 2010 → · Beetle model year 2011 → 2019
- Assembly of the door lock **VW** Fox model year 2005 → 2011
- Ergonomically shaped 1-component trinamic handle



HAZET No.	l ₁ mm	l ₂ mm	EAN-No. 4000896+
2598-1	155	256	204144

828 LG-T Screwdriver · with T-handle

• Extra long design for safe operation of deeply located screw connections



• Application: Side mirror removal / installation e.g. on **OPEL/VAUXHALL** Corsa D · Meriva B

• Extra long design

- Round blade
- Ergonomically shaped HAZET 2-component T-handle
- Surface: chrome-plated, tips burnished

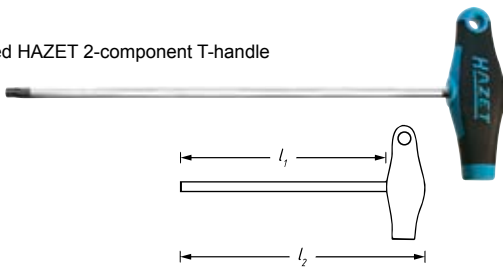

HAZET No.	l ₁ mm	l ₂ mm	Ø mm	EAN-No. 4000896+
828 LG-T40	290	325	6.65	235360

2534-1 Clamp washer operating tool

Made in Germany

- Quick and easy operation of the clamp washers
- Prevents damage to underfloor panels and heat shields

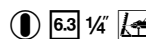

- Application: Operation of the clamp washers on underfloor panels and heat shields on e.g. **AUDI, SEAT, ŠKODA, VW, FORD**
- Ø in the operating range: 27 mm
- Pin Ø: 2 mm
- Pin height: 2 mm
- Distance between pins: 22.9 mm



2534-1 Clamp washer operating tool

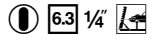

HAZET No.	l mm	EAN-No. 4000896+
2534-1	22	224227

2797 1/4" Bumper tubular socket wrench

Made in Germany

• Operation of the rear bumper screws

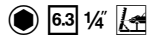

- **MERCEDES-BENZ** type 204 (C-Class) station wagon and saloon · type 205 (C-Class) · **AUDI** A3 model years 2004 → · A4 model years 2001 → · A6 model years 2005 → · TT model years 2007 →
- Note: Screw operation with threaded rod
- Controlled screwing with the torque value required by the manufacturer



HAZET No.	S mm	l mm	EAN-No. 4000896+
2797-1	10	160	154746

2797-2 1/4" Bumper tubular socket wrench

Made in Germany

• Controlled screwing with the torque value required by the manufacturer

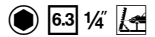

- Application: Operation of the side bumper holder on the rear
- Note: screw operation with threaded rod
- **MERCEDES-BENZ** type 213 (E-class) model year 2016 →



HAZET No.	S mm	l mm	EAN-No. 4000896+
2797-2	8	160	210053

2797 3/8" Headlights adjustment tool

Made in Germany

• Adjusting the headlights or clearance from bumpers and bonnet

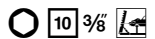

- Following car body repairs and headlight replacement respectively on **MERCEDES-BENZ** 205 C-Class · model year 2014 and **AUDI** A7
- Tool is especially suited to areas with restricted access
- Surface: matt chrome-plated

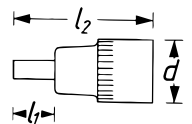

HAZET No.	S mm	l mm	d mm	EAN-No. 4000896+
2797-14	14	195	18	202201



828 Screwdriver · with T-handle

- Application: Setting the headlights on **FORD** models
Optimal length ensures direct use on the component (putting together several tools is not necessary)
- 6-point blade
- Ergonomically shaped HAZET 2-component T-handle
- Surface: chrome-plated, tips burnished

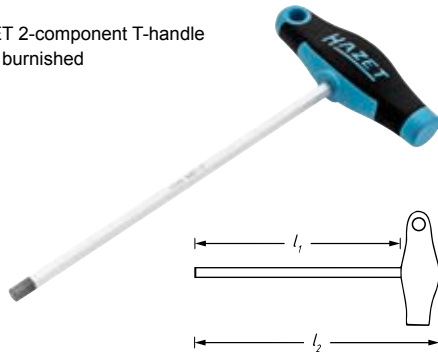

HAZET No.	S mm	l ₁ mm	l ₂ mm	EAN-No. 4000896+
828-7	7	200	234	210060

828 LG Screwdriver · with T-handle

- Application: Setting the headlights on **RENAULT, AUDI**
Optimal length ensures direct use on the component (putting together several tools is not necessary)
- 6-point blade
- Ergonomically shaped HAZET 2-component T-handle
- Surface: chrome-plated, tips burnished

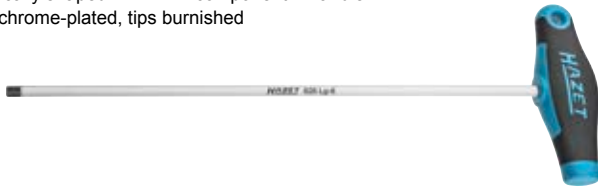

828 LG Screwdriver · with T-handle

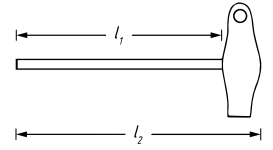

HAZET No.	S mm	l ₁ mm	l ₂ mm	EAN-No. 4000896+
828 LG-6	6	300	334	226672

1816 Flat nose pliers

Made in Germany

- Particularly flat shape for use in very confined spaces

- Application: Removal and adjustment of the grab handles in the interior as well as the sun visors on **VAG** vehicles
- Flat form
- Straight design
- Handles with dip coating



HAZET No.	l mm	EAN-No. 4000896+
1816 K-1	135	232949

Car glass / Wiper arm

4852 Tool set for car glass removal

Made in Germany

- Self-closing safety pull handles hold the sawing or cutting wire firmly
- 4-point cutting wire for fast and easy cutting of nearly all adhesive beads
- Sawing wire twisted from three brass-plated steel wires for very hard or large adhesive beads
- Robust wire starter made of spring steel with large T-handle to pierce the wire through the bead
- Counterholder with long shaft and stable M4-thread secures the cutting wire from inside



4852 Tool set for car glass removal



4852-6 4852-7

HAZET No.	l ₂ mm		EAN-No. 4000896+
• Tool set for car glass removal, contents 4852-3 (2x) · 4 A · 5 · 6 · 7			
• Extraction of glued car windows			
4852/6	–	6	129447
• Pull handle for collecting the cutting wire			
• Extraction of glued car windows			
4852-3	–	–	129454
• Counterholder for guiding and retaining the cutting wire			
• Total blade length 370 mm · tapered to 160 mm			
• Extraction of glued car windows			
4852-4 A	–	–	164769
• Wire starter for puncturing the glue bead			
• Extraction of glued car windows			
4852-5	325	–	129478
• Roll of square cutting wire 0.6x0.6 mm, 22 metres			
• Extraction of glued car windows			
4852-6	–	–	129485
• Roll of round cutting wire Ø 0.8 mm, 22 metres			
• Extraction of glued car windows			
4852-7	–	–	129492



Specialty tools

Body and interior equipment – Commercial vehicles



4850 Nozzle adjusting tool

- The telescopic handle can be used to indicate the nozzle jet direction to the windscreen
- Application: Adjusting the nozzles of the windscreen washing systems
- With pocket clip
- Magnetic head: 6 mm \varnothing
- Adjusting needle (\varnothing 0.7 mm) and protection cap

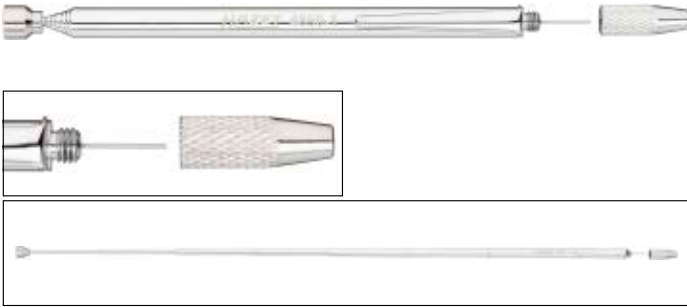

HAZET No.	l_1 mm	l_2 mm	EAN-No. 4000896+
4850-1	155	670	022366

4852 Dashboard protection set · with handle

- The light blue colour draws attention to soiling on the individual protection panels quicker than conventional grey protective panels do and therefore prevents the interior from being soiled
- Application: For protection against damage to the dashboard, interior lining and vehicle headlining when removing windows
- Clean and professional work
- Sturdy plastic
- Contents:
 - Protection panel, angled, 270 200 mm
 - Protection panel, angled, 450 300 mm
 - Protection panel, straight 270x200 mm
 - Protection panel, straight, 450x300 mm



HAZET No.	Quantity	EAN-No. 4000896+
4852/4	4	210114

Steering wheel

1776 Pitman arm puller · 2-arm

Made in Germany

- For ball bearings, toothed wheels, pinions, pitman arms and similar
- The clamp clip is used for pressing the puller jaws on the parts to be extracted
- Surface: galvanised

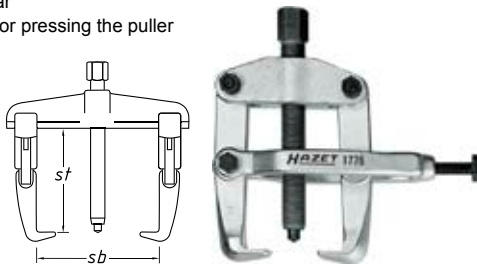

HAZET No.	sb mm	sf mm	EAN-No. 4000896+
1776-100	90	100	135950

2223 LG Bit

Made in Germany

- Long design
- Hexagon drive similar to ISO 1173 C6.3 (1/4")



HAZET No.	l mm	d mm	EAN-No. 4000896+
2223 LG-T 30	70	5.52	015092

• Round blade
 • For all MERCEDES-BENZ passenger cars model year → 2011 with bolted air bag unit
 • For removal and installation of the airbag unit e.g. MERCEDES-BENZ · VW · AUDI · OPEL/VAUXHALL · PORSCHE (inside TORX® screws T30)

Commercial vehicles

Engine

Cylinder head

2850 3/4" Impact socket · TORX®

Made in Germany

- Operation of cylinder head bolts

- Reinforced design
- Long design
- With borehole for locking pin or safety spring and groove for O-ring
- Surface: phosphatized, oiled

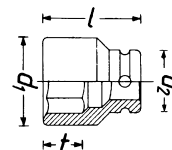

HAZET No.	s	l mm	d_1 mm	d_2 mm	d mm	t mm	EAN-No. 4000896+
• MAN commercial vehicles F 2000, F 90, F 8 and MAN buses with D 25 and D 28 engines							
2850-E20	E20	110	25	44	18.49	15	079681
• MAN commercial vehicles with Common Rail Engine (D20)							
2850-E24	E24	110	30	44	22.16	17.5	146758



Fuel system / Fuel injection

2168 Fuel filter wrench

Made in Germany

• Easy operation with introduced square 12.5 mm (1/2 inch)

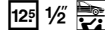

- Application: Operation of fuel filter housing on construction and agricultural machinery
- For e.g.: **CLAAS** Torion, **LIEBHERR** wheel loaders and wheel loaders with Euro 6 emission standard and **LIEBHERR**, **JOHN DEERE** engines
- Harvester 1070G, 1170G · Forwarder 1110G, 1210G, 1510G · Caterpillar-track timber crane 2154G, 2154G · Log loader 2156G, 2156G LC · Timber crane, hitch-mounted 337E, 437E · Wheel loader 524K, 524K-II, 524L, 544K, 544L · Field sprayer, self-propelled R403, R4040L, R4050L · Tractors 6M, 6R series · Tractors 7R series · Combine T series · Combine W series · Bulldozer 700K · Excavator 210G LC Deere · Sprayer Mazzotti MAF HP · Hagie STS 10, STS 12



HAZET No.

EAN-No. 4000896+

2168-1

223251

2849 Single box-end wrench

Made in Germany

• Operation of the turbocharger nuts on MAN trucks



- Bent form of the box wrench is especially adapted to the confined spaces
- Ergonomically shaped HAZET 2-component handle



HAZET No.

l mm

EAN-No. 4000896+

2849-15

266

159284

2871 Turbocharger / manifold **TORX** socket

Made in Germany

• Lower installation height than nut-driver with reversible ratchet



- Application: Operating the turbocharger and manifold screws (E12)
- On **MAN** TGL · TGM with E08 engines
- Drive s 17 mm
Operation e.g. with ratcheting combination wrench 606-17 or insert box-end wrench 6630d-17 and tool holder 6397 (screw loosening) with torque wrench 5292-3CT · 6292-1CT (tightening)
- Necessary due to limited space
- Surface: phosphatized, oiled



HAZET No.

l mm

EAN-No. 4000896+

2871-E12

28

201730

4550 3/8" Injection line wrench

Made in Germany

• Open 12-point socket

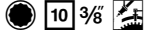

- Application: Operating screwed connections on injection lines
- Surface: chrome-plated
- On **MAN** commercial vehicles with D 20 engines – common rail injection systems
- **Short style**
- Drive 10 = 3/8"



HAZET No.

s mm

l mm

d₁ mm

d₂ mm

t mm

EAN-No. 4000896+

4550-3

17

83

27

18

8

104307

4550 1/2" Injection line wrench

Made in Germany

• Professional operating of the screwed connection on injection line

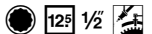

- Application: Operation of the union nut on the high-pressure line on the injection valve common rail injection system
- Open double hexagon socket for injection lines
- The tightening torque required by the manufacturer is achieved by using a HAZET torque wrench (observe manufacturer specifications)
- Surface: burnished
- **DAF** Euro 6 engines MX11/ MX13 e.g. XF · CF
- Drive 12.5 = 1/2"



HAZET No.

s mm

l mm

d₁ mm

d₂ mm

t mm

EAN-No. 4000896+

4550-21

21

91

33

32

19

204137

Made in Germany

• Professional operating of the screwed connection on injection line

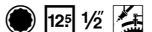

- Application: Operation of the union nut on the high-pressure line on the **MAN** injection valve common rail injection system
- Open double hexagon socket for injection lines
- The tightening torque required by the manufacturer is achieved by using a HAZET torque wrench (observe manufacturer specifications)
- Surface: burnished
- Drive 12.5 = 1/2"



HAZET No.

s mm

l mm

d₁ mm

d₂ mm

t mm

EAN-No. 4000896+

4550 N-22

22

85

33

32

21.8

234387

4558 Pressure nut crown wrench

Made in Germany

• Application: Operation of the **compression nut at the nozzle holder**

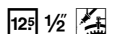

- For **MAN** and **MERCEDES-BENZ** commercial vehicles M 401/421, M 402/422 · LA · A · M 403/423 · M 470h



HAZET No.

l mm

EAN-No. 4000896+

4558

72

021888



1788 T Impact extractor

Made in Germany

- Application: For disassembly of tight common rail injectors **without** removing the cylinder head
- **Impact extractor** (sliding hammer – sliding weight 200 g) with coupler thread M10
- Removal of caps with inside thread, ball bearings, washers etc.
- To be used with stud bolt set 1788T-1/6 and internal extractors 1788N-15 to 35
- Also together with injector extractor 4797-5



HAZET No.	M	EAN-No. 4000896+
1788 T-1	M10	134304

4797 Injector extractor

Made in Germany

- Application: For disassembly of tight common rail injectors **without** removing the cylinder head

Easy removal of injectors together with impact extractor e.g. **HAZET 1788 T-1**

- **Injector claw** with inside thread M10 x 1.5 mm
- **MAN Engines** D08 · D20 · D26 · D28
- Suited to the very limited space conditions in the cylinder head
- Due to the tool's claw, the injector in the upper part may be gripped without causing damage



4797 Injector extractor



HAZET No.	EAN-No. 4000896+
4797-5	176137

2168 Ad-Blue® filter wrench

Made in Germany

- Operation of the filter housing cap when replacing the AdBlue® filter (urea solution filter) on **MERCEDES-BENZ** commercial vehicles with BlueTec® engines, e.g. Actros, Atego, Axor, Econic

- The tightening torque recommended by the vehicle manufacturer (please follow the instructions of the manufacturer) is reached e.g. with the torque wrench HAZET 6110-1CT
- ∅ 46 mm

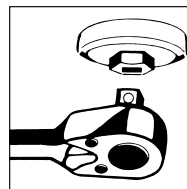

HAZET No.	∅ mm	EAN-No. 4000896+
2168-46	59	156252

Diagnostics

4800 Radiator tester for agricultural machinery

Made in Germany

- Application: Checking for leakage in cooling systems and heating circuits
- Classification to vehicle types: www.hazet.de → **Service** → **The Tool Finder** → **Radiator adapters 4800**
- Plastic box
- 4800-1 Cooling pump to 2.5 bar
- 4800-2 Intermediary piece, flexible hose
- 4800-3 Radiator adapter for **AMAZONE** Pantera
- **CLAAS** Jaguar · Lexion · Scorpion · Ares · Atlas · Ceres
- **FENDT**
- **MASSEY FERGUSON** with tank number 180224M92 and 4296015M1
- **CASE** Quadtrac · Magnum
- 4800-4A Radiator adapter for **CASE** Puma · SBS · LBS · Optum · Maxxum · CVX
- **NEW HOLLAND** TVT · T7, T7 Elite Pack · T6
- **FENDT** Vario model year 2000 → Combine harvester L series
- **CLAAS** Arion · Axion
- **DEUTZ** engines 3.6 PowerPack · BF6M1013FC · TCD2013L6 2V and 4V genset 250kW
- 4800-5A Radiator adapter for **FENDT** Farmer 300 model year 1988 → Type 500 · Type 700 · Vario model year 1988 → 2000
- 4800-20 Radiator adapter for **CLAAS** Xerion · Tucano as well as all new **CLAAS** machines with **MERCEDES-BENZ** expansion tank



HAZET No.	6	EAN-No. 4000896+
4800/6	6	216482



4800 Commercial vehicle radiator tester

Made in Germany



- Application: Checking for leakage in cooling systems and heating circuits
- Classification to vehicle types: www.hazet.de → **Service** → **The Tool Finder** → **Radiator adapters 4800**
- Plastic box
- 4800-1 Cooling pump to 2.5 bar
- 4800-2 Intermediary piece, flexible hose
- 4800-3 Radiator adapter for **DAF** 45 model year 05/1991 → 12/2000
DOOSAN wheel excavator S, caterpillar excavator DX
KAESER Mobilair
LIEBHERR A308-316
MERCEDES-BENZ Vito, Viano, Solaris
NISSAN forklifts
PUTZMEISTER BSA 1409
SCANIA Vabis
- 4800-5 A radiator adapter for **COMPAIR** mobile compressor with **VW** expansion tank
LINDE forklift
PUTZMEISTER BSA 1407D · BSA 2110 HP-D
RENAULT Midlum model year 01/2000 → 12/2013
Volvo FE model year 05/2006 → FL model year 03/2000 →
- 4800-25 radiator adapter for **MAN** buses such as Lions Coach, Lions Star, Lions Comfort, Lions City
MERCEDES-BENZ Citaro model year 01/1998
IVECO Euro-Star, Euro-Tech, Euro-Truck, Stralis, Daily with black lock
MAN F90, F2000, TGA model year 03/2000 →, TGL model year 04/2005 →, TGM model year 10/2005 →, TGS model year 10/2007 → 01/2012, TGX model year 10/2007 → 01/2012
MERCEDES-BENZ commercial vehicles Actros, Atego 1217 model year → 1999, Eco 8401, SK1728, Antos, Arocs, Atego model year 1998 → 2013, Axor model year 09/2001 → 10/2004, Econic, Zentros
- 4800-26 Radiator adapter for **DAF** CF, XF Euro 6 model year 2013 →
- 4800-27 Radiator adapter for **MERCEDES-BENZ** Atego model year 2014 →
- 4800-28 radiator adapter for **MERCEDES-BENZ** Actros EURO 6 with HEYCO expansion tank model year 2014 →
MAN TGX, TGS EURO 6 with HEYCO expansion tank model year 2012 →



HAZET No.	Image	EAN-No. 4000896+
4800/8		216499



4800 Radiator adapter

Made in Germany



- Application: Checking for leakage in cooling systems and heating circuits
- **Extended range for existing radiator tester HAZET 4800**
- Threads adjusted exactly to opening of the expansion tank
- Coupling nipple for connection to the quick coupling connection of the cooling pump 4800-1 and intermediary piece 4800-2 or vacuum radiator filler HAZET 4801-1 and 4802-1



HAZET No.	Image	EAN-No. 4000896+
4800-29		222780
4800-20		144242
4800-25		203857
4800-26		214495
4800-27		214501
4800-28		214518



Specialty tools

Commercial vehicles – Oil service



4802 Commercial vehicle vacuum radiator filler

Made in Germany

- Suitable in conjunction with single or universal adapters, e.g. 4801-2/3



- Application: Vacuum leakage test before refilling the cooling system
- **Filling of the coolant and heating circuit without bubbles in trucks · buses · agricultural machinery and construction vehicles**
- New design of the vacuum radiator filler allows the desired vacuum to be reached faster, which allows the cooling system to be filled more quickly
- Fast coolant flow rate: **80 litres in approx. 20 minutes**
- Filling possible with standard stoppers as well as with fixed cap
- No loss of coolant due to overflow of the cooling system
- Separate control through the diagnostic testing device is no longer necessary
- Hose: 10x16 mm
- Outside diameter: 16 mm
- Inside diameter: 10 mm



YouTube Clip

HAZET No.	EAN-No. 4000896+
4802-1	200030

Oil service

2169 Oil filter wrench

Made in Germany

- Application: Operation of oil filters e.g. from MANN as well as MAHLE/KNECHT

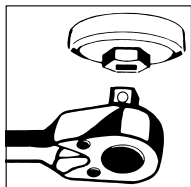
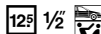

HAZET No.	mm	mm	EAN-No. 4000896+
2169-9	24	119	116690

• Drive: Outside 6-point \leq 24 mm / \square drive 12.5 1/2"

• Output: **15-point \leq 105 mm**

• For e.g.: **Volvo · SCANIA · RENAULT · MAN · IVECO · FIAT · FODEN · IRISBUS · ASTRA · CATERPILLAR · LIEBHERR · JOHN DEERE · KOMATSU · FAUN · MITSUBISHI**

• The torque value recommended by the vehicle manufacturer can be safely achieved, e.g. with a HAZET torque wrench (Attention: observe the manufacturer's tightening torque values)

2169 Oil filter wrench

Made in Germany

- Forged design

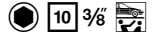

- Application: Installing and removing **oil filters and oil filter housing caps** when changing the oil filter element
- Surface: chrome-plated

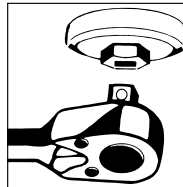

2169-32



YouTube Clip

HAZET No.	mm	mm	EAN-No. 4000896+
• 6-point \leq 32 mm OPEL/VAUXHALL Astra · Corsa · 1.9 I CDTi · Astra 2.0 CDTi VW Passat · Golf 6 with 1.6 and 2.0 CR-TDI · Passat B7 1.6 · 2.0 diesel engine · Golf 7 2.0 petrol engine · Polo 5 1.2 I-1.4 I TDI · Polo 1.2 I petrol engines model year 2005→ · Transporter T5 1.9 I diesel model year 2004→ · Touran TDI · Tiguan model year 2007→ 1.4 I (90/118kW) 2.0 I diesel engines · AUDI A6 3.2 I TSI · V6 model year 2004→ · A4 diesel from model year 12/2007 BMW 530d M57 model year 2008→ For urea solution filter Ad-Blue® MAN e.g. TGX			
2169-32	32	43	082346
• Hexagon \leq 36 mm e.g. for MERCEDES-BENZ engine 116 MB · 100 D Transporter · Actros MP 1 · MP 2 · BMW M 52-6-cylinder: 3 Series · 5 Series · M 60-8-cylinder: 5 Series · 7 Series · 8 Series · M 73-12-cylinder: 7 Series · 8 Series · 1 Series (E87): 118d · 120d · 1 Series (F20) 118i · OPEL Vectra B DI 16 V · Insignia · VW Lupo 1.2 TDI · Polo 5 1.2 I · Golf 6 1.4 I SRE/TSI · Touareg TDI · T5 2.5 D · Passat B7 3.6 I FSI · AUDI 6-cylinder petrol engines model year 2004→2018 For fuel filters MAN e.g. TGA			
2169-36	36	49.5	086566

2171 Oil filter wrench

Made in Germany

- Steel strip adjustable to seven positions

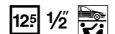

- Application: Operation of oil filters e.g. as an assembly tool for oil and fuel filters on **MAN** commercial vehicles



2171-1



HAZET No.	l mm	mm	EAN-No. 4000896+
2171-1	160	80–110	013418
2171-2	230	75–110	013432



2171 Oil filter chain wrench

Made in Germany

- The opening in the oil filter chain allows them to be used even in places which are difficult to reach due to the construction
- Application: Operation of oil filters and air dryer cartridges



HAZET No.	Ø mm	EAN-No. 4000896+
2171-8 LG	50-150	203703

Brakes

2195 Cartridge wrench

Made in Germany

• Forged design

- Application: Operating the granulates cartridge on commercial vehicles with compressed air dryers
- Design "Made by HAZET"
- Negative position of arms
- MAN No. 8099606-0307
- Surface: burnished, oiled



HAZET No.	Ø mm	EAN-No. 4000896+
2195	90-140	014101

2784 3/4" Brake calliper screwdriver socket

Made in Germany

• Drive allows transmission of high separation forces

- Application: Operation of the brake calliper screw connection (Knorr-Bremse) on MERCEDES-BENZ commercial vehicles e.g. Actros
Operation of the upper wishbone screw on MAN TGA
- Controlled screw tightening with the torque value required by the manufacturer (follow manufacturer's instructions) e.g. with torque wrench HAZET 6144-1CT
- With knurling
- With bolt for locking pin retaining



HAZET No.	S mm	l ₁ mm	l ₂ mm	d mm	EAN-No. 4000896+
2784-14	14	60	112	33.2	155583

2784 3/4" Brake disc screwdriver socket set

Made in Germany

• Drive allows transmission of high separation forces

- Application: Operation of the brake disc screws on MERCEDES-BENZ Actros 2nd generation model 2011→
- Replaceable impact screwdriver socket T60



HAZET No.	S	l ₂ mm	Ø mm	□	EAN-No. 4000896+
2784-T60/4	T60	154.5	13.25	4	188611

2871 Brake calliper TORX® socket

Made in Germany

• Operation of the brake calliper screws on MAN commercial vehicles

- Application: Brake calliper screws E20
- Operation e.g. with HAZET insert box-end wrench 6630d-22 together with tool holder 6397 (loosening) or torque wrench 6293-1CT or 6295-1CT (tightening)

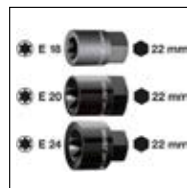

HAZET No.	S	l mm	d mm	Ø mm	f mm	EAN-No. 4000896+
2871-E18	E18	39.5	23.4	16.70	13.5	176175
2871-E20	E20	39.5	25.7	18.49	15.9	148790
2871-E24	E24	39.5	35	22.16	19.7	148783



2872 TORX® slogging wrench · with 2 striking faces

Made in Germany

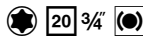

• Use of the wrench for assembly and disassembly of the brake calliper screw connections renders disassembly of the steering tie lever unnecessary

- Application: Operation of **TORX®** screws on brake calliper screw connections on commercial vehicle front axle and trailing axles
- Controlled screw tightening with torque wrench according to manufacturer's specifications
- Wrench flat with laser-engraved formula for calculating the correct effective length

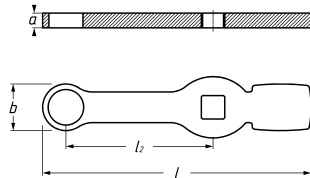

HAZET No.	l mm	lz mm	a mm	b mm		EAN-No. 4000896+
For e.g. MAN TGL TGM						
2872-E 18	215	120	12	30	16.70	201235
2872-E 20	216	120	12	32	18.49	201242
For e.g. MAN TGA TGS TGX						
MERCEDES-BENZ Atego 970-976 – Vehicles with air suspension brake calliper screw connection on the rear axle						
2872-E 24	219	120	12	38	22.16	201259

2872 FS Box-end wrench – striking face pattern · 12-point · with 2 striking faces

Made in Germany

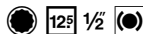

• Use in trucks, buses, trailers and trailer axles without removing the wheel

- Application: Operation of brake cylinder screw connections
- Also for brake cylinder screw connections protruding far into the rim
- Laser-engraved formula for rapid conversion of the tightening torque specified by the manufacturer
- 2 impact areas enable the force to be applied using a hammer
- About 20 minutes time saving
- Highly stable and resilient

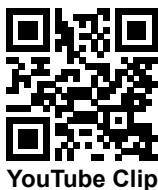

HAZET No.	a mm	b mm	EAN-No. 4000896+
2872 FS-24	12	38	209989

2872 SZ Box-end wrench – striking face pattern · 12-point · with 2 striking faces

Made in Germany

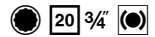

• The 12-point profile allows application even in areas with hard-to-reach screw connections

- Application: Operation of the brake calliper fitting on commercial vehicles
- Controlled screw tightening with torque wrench according to manufacturer's specifications
- Wrench flat with laser-engraved formula for calculating the correct effective length

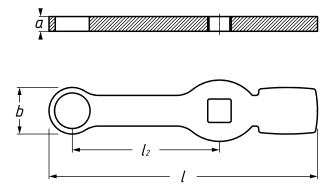

HAZET No.	l mm	lz mm	lz mm	a mm	b mm	EAN-No. 4000896+
For e.g. SAF -brake calliper on MERCEDES-BENZ Atego and Actros						
2872 SZ-24	219	120	120	12	38	204175
E.g. for DAF XF95/ XF105/ XF						
2872 SZ-26	219	120	120	12	38	203727
For e.g. MERCEDES-BENZ Atego · Actros · KÄSSBOHRER buses Volvo FH						
2872 SZ-27	220.5	120	120	12	38	207183
For brake callipers on front and rear axles SCANIA series 3 · 4 · G · P · T · R · S · SCANIA Omnibus Citywide LE/LF · OmniCity · OmniLink and IVECO Stralis						
2872 SZ-30	225.5	120	–	12	45	246281

4969 Compressed air quick-connector releasing tool

Made in Germany



• For operation with open-end wrench size 13 mm (HAZET 600N-13), no further tools necessary

- Application: Easy loosening of quick-connectors with 6 · 8 · 10 · 12 mm Ø
- For plug connectors DIN 74324 6x1.0 · 8x1.0 · 10x1.0 · 12x1.5 · 12x2.0 mm
- Separation of contaminated tubes and plug connectors
- To be used by one person
- Prevention of injuries
- Time and cost saving



HAZET No.	EAN-No. 4000896+
4969-612	204281



4971 Brake calliper resetting tool

Made in Germany

- Adjusting with nut-driver s 12 mm

- Application: Operation of the adjuster (adjusting the brake calliper) on Knorr-Bremse disc brakes on trucks, buses, trailers and trailer axles from all brands
- Special 11-tooth profile



HAZET No.	l mm	d ₁ mm	d ₂ mm	t mm	EAN-No. 4000896+
4971-11	18	15	11.5	9.8	218257

4971 Brake calliper resetting tool

Made in Germany

- Special insert in the ratchet wrench ensures safe power transmission on the resetting device

- Application: Resetting **WABCO** brake callipers without removing the brake cylinder on **MERCEDES-BENZ** Actros, Antos, Arocs
- Non-slip HAZET 3-component handle – allows high power transmission



HAZET No.	l mm	EAN-No. 4000896+
4971-12	454.4	232857



4972 Lifting aid

Made in Germany

- Allows you to work safely, without straining your back, in tight spaces in the wheel arch on trucks, buses, trailers and trailer axles

- Application: Secure retention and movement of heavy components, e.g. when disassembling and assembling brake callipers and wheel hubs on commercial vehicles
- Makes fitting screws easier
- Takes the various installation situations of the brake callipers into consideration
- Easy to use
- One-hand operation possible via spindle
- Second person not required
- Setting range min./max.: 716 – 911 mm



YouTube Clip

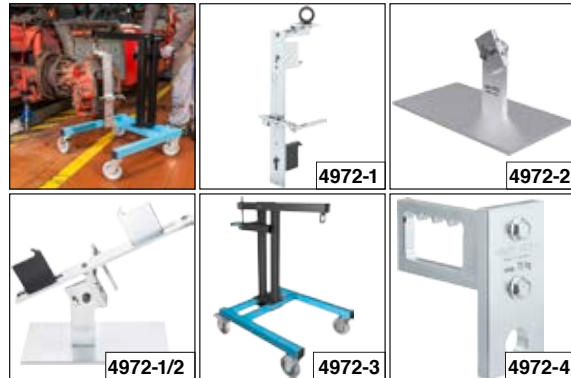

HAZET No.		EAN-No. 4000896+
• Lifting aid consisting of lifting aid 4972-3, – brake calliper holder 4972-1 and wheel hub holder 4972-4		
4972-1/3	3	215799
• Brake calliper holder • Maximum load: 35 kg		
4972-1	–	215423
• Swivel bearing • Use with brake calliper holder 4972-1 • For disassembly and assembly of brake callipers in trucks, buses, trailers and trailer axles that are installed in a diagonal „clockwise position between 8 o'clock and 5 o'clock“ • Easy to set the screws, even in awkward positions • Connect swivel bearing to brake calliper holder and position with e.g. jacking carriage below brake calliper		
4972-2	–	215393
• Lifting aid single, without brake calliper holder 4972-1 and wheel hub holder 4972-4 • Maximum load: 75 kg		
4972-3	–	215782
• Wheel hub holder • Use with lifting aid 4972-3 or 4972-1/3 • Assembling and disassembling wheel hubs • Maximum load: 70 kg		
4972-4	–	216031



Chassis

Wheel bearing / Wheel hub

1790 Ball joint puller

Made in Germany

- Application: Removing the **ball joint pivots** of steering arms, steering tie rods, stabilizers etc. on heavy commercial vehicles
- Surface: galvanized (free from Cr 6)

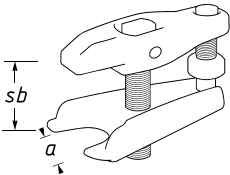

HAZET No.	a mm	sb mm	EAN-No. 4000896+
1790-3	40	85	145454

Made in Germany

• **Supported by hydraulic system**

- Application: Safe removal of **ball joint pivots** and ball joints
- Surface: galvanized (free from Cr 6)

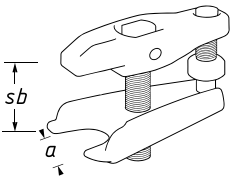

HAZET No.	a mm	sb mm	EAN-No. 4000896+
1790-5	32	70	145461
1790-6	40	85	145478

- For passenger cars · vans · commercial vehicles
- Load maximum 12 tonnes

- For commercial vehicles, buses and building machinery
- Load maximum 12 tonnes

4961 N Wheel hub grinder

Made in Germany

- **Grinding pad made of aluminium with 8-point profile enables safe and firm fixation of the grinding wheels**



- Application: Quick and easy **removal of rust and dirt from contact surfaces of wheel hubs and brake discs with wheel bolt support**
- Open-pored abrasive material and cup-formed grinding disc reduce the formation of dust to a minimum
- No formation of sparks



HAZET No.	EAN-No. 4000896+
4961 N-23/12	186754
4961 N-023 M/5	187270
4961 N-023 S/5	187287

- Hexagon insert for firm hold on the device
- Special grinder for optimal cleaning of the bearing surface of a wheel rim (wheel hubs) on trucks and transporters with stud bolt
- **8-point profile** enables safe and firm fixation of the grinding wheel to the base component
- Inner Ø max.: 23 mm
- Grinding wheel Ø 56 mm, stud bolt maximum length 100 mm
- Made in Germany (base component made of aluminium)

12-piece set · contents:

- 1 base component made of aluminium
- 5 grinding wheels for moderate soiling
- 6 grinding wheels for heavy soiling

4961 N-23/12 12 186754

- Hook and loop fastener for quick changing of grinding wheels
- **5 spare grinding wheels for moderate soiling**, outside Ø 56 mm, maximum inside Ø 23 mm

4961 N-023 M/5 5 187270

- Hook and loop fastener for quick changing of grinding wheels
- **5 spare grinding wheels for heavy soiling**, outside Ø 56 mm, inside Ø maximum 23 mm

4961 N-023 S/5 5 187287

Cardan shafts

4685-1 Taper key extractor

Made in Germany

- Application: Safe removal of taper keys from the sprockets of agricultural machinery as well as manual operation of input shafts on accessory equipment



HAZET No.	l mm	EAN-No. 4000896+
4685-1	420	222889

4685-2 Taper key extractor

Made in Germany

- Application: Safe removal of taper keys from the sprockets of agricultural machinery as well as manual operation of input shafts on accessory equipment



HAZET No.	l mm	EAN-No. 4000896+
4685-2	366	222896



4685-4 1/2" Tubular socket wrench

Made in Germany

- Multi-finger operation through the very narrow opening on the feed drum

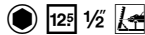

- Application: Operation of multi-fingers on combine cutting platforms
- For **CLAAS · LEXION · TUCANO · AVERO**
- Application of torques on multi-fingers
- Disassembly / assembly with just one tool



HAZET No.	s mm	l mm	d ₁ mm	d ₂ mm	t mm	EAN-No. 4000896+
4685-4	24	330	32.3	28	21.5	231126

4937 Commercial vehicle pin wrench set

Made in Germany

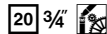

- For repair and maintenance work on the wheel hub, wheel bearing or brake disc on **MAN, MERCEDES-BENZ**

- For e.g. **MAN TGL** front axle model years 2000→ and L 2000 **MERCEDES-BENZ** Atego rear axle HL 2
- Precise fit
- Precise pin geometry for ideal tool operation in slotted nuts
- Solid design: High (shape) stability even with high loosening or tightening torques
- Pin wrench for rear axle, inside Ø: 87 mm
- Length (total): 65 mm
- 6 pins, width of pins: 10 mm
- Two replaceable guide tubes
Outside-Ø: 49 mm · 57 mm
Length (total): 140 mm

Operating tools for commercial vehicle axle nuts and wheel hubs

- Surface: burnished

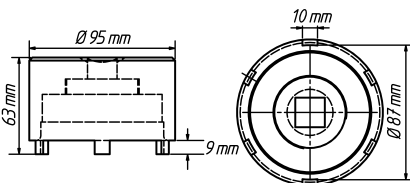

HAZET No.	l ₂ mm	Icon	EAN-No. 4000896+
4937-87/3	54	3	199235

Made in Germany

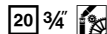

- For repair and maintenance work on the rear axle **MERCEDES-BENZ**

- For **MERCEDES-BENZ** Actros · Hypoid rear axle HL 8
- Precise fit
- Precise pin geometry for ideal tool operation in slotted nuts
- Solid design: High (shape) stability even with high loosening or tightening torques
- Inner Ø: 117 mm
- Length (total): 200 mm
- 6 pins, pin width: 9.8 mm
- Guide tube
Outside Ø: 60 mm
length (total): 185 mm
- Surface: burnished



4937 Commercial vehicle pin wrench set

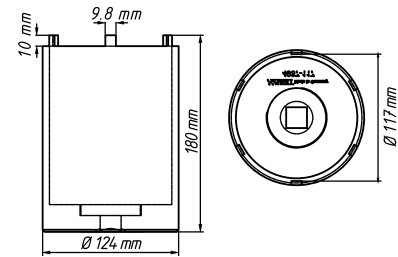
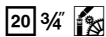

HAZET No.	l ₂ mm	Icon	EAN-No. 4000896+
4937-117/2	180	2	199242

4937 Commercial vehicle hub cap socket

Made in Germany

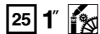

- For flat oval **BPW** hub cap

- For **BPW** Eco and Eco Plus axles
- Perfect fit for **BPW** contour Ø 110 mm
- Precise fit
- Solid design: High (shape) stability even with high loosening or tightening torques
- Surface: burnished

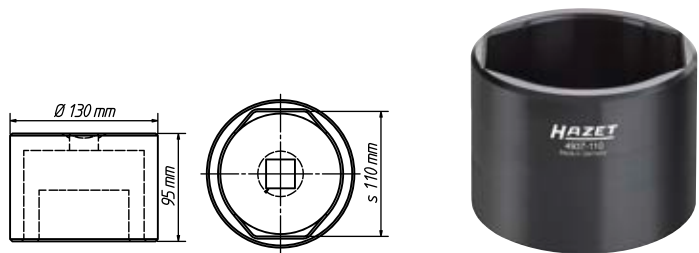

HAZET No.	l ₂ mm	EAN-No. 4000896+
4937-110	95	199273

4937 Commercial vehicle axle nut socket

Made in Germany

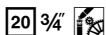

- Perfect fit for **BPW** contour Ø 120 mm

- Application: For flat oval **BPW** hub cap
- Precise fit
- Solid design: High (shape) stability even with high loosening or tightening torques
- Surface: burnished



HAZET No.	EAN-No. 4000896+
4937-120	210459



Specialty tools

Commercial vehicles – Chassis



4937 Commercial vehicle pin wrench set

Made in Germany

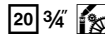

• For repair and maintenance work on the wheel hub, wheel bearing or brake disc rear axle on **MAN** and **MERCEDES-BENZ**

- For **MAN** and **MERCEDES-BENZ** 10 t and 13 t AP Hypoid and tag axle N7/4 · Omnibus 0305G · 0405G
MAN hub reduction rear axle F series H7 · HD7
Hypoid axle F series HY-1175 · HDY-1175
- Precise fit
- Precise pin geometry for ideal tool operation in slotted nuts
- Solid design: High (shape) stability even with high loosening or tightening torques
- Inner \varnothing : 103 mm
- Length (total): 140 mm
- 6 pins, width of pins: 11.5 mm
- Two replaceable guide tubes
Outside- \varnothing : 51.5 mm · 66.5 mm
Length (total): 135 mm
- Surface: burnished

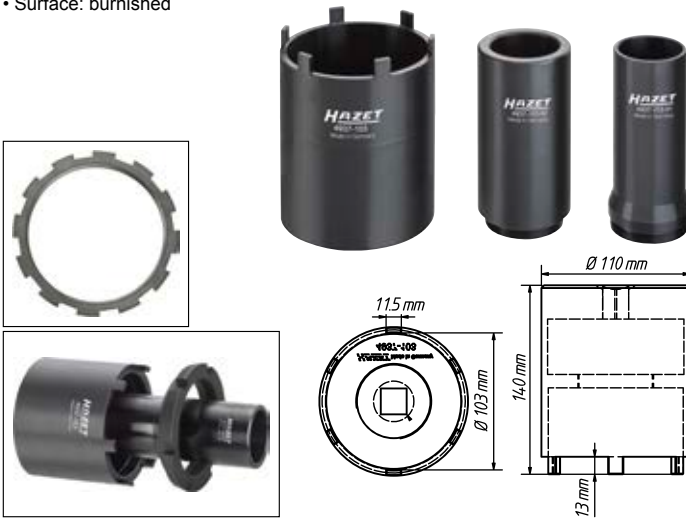

HAZET No.	Icon	EAN-No.
4937-103/3	3	4000896+ 199259

Made in Germany

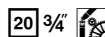

• For dismantling / assembly work on the rear axle as well as repair and maintenance work on the wheel hub, wheel bearing or brake disc rear axle **MERCEDES-BENZ**

- **MERCEDES-BENZ** hub-reduction axle, such as tag axle NR 7/4
- **MERCEDES-BENZ** hub-reduction rear axle (Euro-axes) 10 t and 13 t, HL7/0 · HL7/1 · HL7/2 · HL7/3, HL7/18 · HO7/8 · HO7/9 · HL7/015, HL7/021 · HD7/2 · HD7/19DG · HD7/016DG
- **MERCEDES-BENZ** hub-reduction axle 7 t AL7/1
- Precise fit
- Precise pin geometry for ideal tool operation in slotted nuts
- Solid design: High (shape) stability even with high loosening or tightening torques
- Inner \varnothing : 101.5 mm
- Length (total): 140 mm
- 12 pins, pin width: 11.4 mm
- Three replaceable guide tubes
External \varnothing : 50 · 51 · 53 mm
Length (total): 85 mm
- Surface: burnished



4937 Commercial vehicle pin wrench set

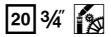

HAZET No.	Icon	EAN-No.
4937-101/4	4	4000896+ 199266

4937 Commercial vehicle pin wrench

Made in Germany

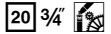

• For rear axle **MERCEDES-BENZ**

- For rear axle nuts **MERCEDES-BENZ** Actros · Atego (heavy design): LN2 · SK rear axle: 740.0/9 – 744.8 745.7 – 747.7 – 748.2 HD 7/19 DG 13 · HD4/16-1
- With outside guide collar
- Precise fit
- Precise pin geometry for ideal tool operation in pin nuts
- Solid design: High (shape) stability even with high loosening or tightening torques
- Inner \varnothing : 62.8 / 70 mm
- 6 pins, width of pins: 7.5 mm
- Surface: burnished



HAZET No.	l mm	EAN-No.
4937-62	85	4000896+ 199020

4937 Commercial vehicle axle nut socket

Made in Germany

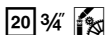

• Dismantling / assembly of the front axle nut with 8-point in front of the brake disc

- **SCANIA** Series R · Series 4 · Series 124 I - 144 I - etc.
- Suitable for impact wrenches, e.g. HAZET 9013SPC · 9013MG
- Precise fit
- Parallel surfaces for perfect force fit on axle nuts
- Solid design: High (shape) stability even with high loosening or tightening torques
- \leq 80 mm **8-point**
- For impact operation
- Surface: burnished



HAZET No.	l ₂ mm	EAN-No.
4937-80	90	4000896+ 199006



4937 Commercial vehicle axle nut socket

Made in Germany

- Nut-driver tuned to the axle nut ensures secure mounting of axle nuts

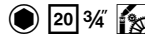

- Application: Front axle screw connection for **DAF** CF and XF series
- Solid design: high (shape) stability even with high loosening or tightening torques
- DAF:**
CF FA · FT · FAR · FAN · FAT · FTT · FTP · FTG · FAD · FTS · FTR
CF 65 FA
CF 75 FA · FT · FAR · FAG · FAT · FAD
CF 85 FA · FAR · FAG · FAN · FAT · FAC · FAX · FAQ · FAD · FT · FTP · FTS · FTR · FTG · FTT
XF FA · FT · FAR · FTP · FAN · FTG · FTT · FAD · FAS · FAT · FAK · FTM · FAG · FAR
XF 95 FA · FAD · FAK · FAN · FAR · FAS · FAT · FT · FTG · FTM · FTP · FTR · FTS · FTT
XF 105 FA · FAR · FAS · FAT · FAK · FAD · FT · FTG · FTS · FTT · FTM
- Surface: burnished



HAZET No.	l_2 mm	EAN-No. 4000896+
4937-S80	63	206889

Made in Germany

- With guide collar



- Application: Operation of the rear axle nut on e.g. **IVECO** Daily 6.5 t · 7.0 t
- Nut-driver completely encloses the flat rear axle nut for secure work
- Suitable for impact wrenches, e.g. HAZET 9013SPC · 9013MG with socket 1000S-36
- Precise fit
- Parallel surfaces for perfect force fit on axle nuts
- Solid design: High (shape) stability even with high loosening or tightening torques
- Hexagon drive $s \leq 36$ mm**
- Output: $s \leq 90$ mm
- For impact operation
- Surface: burnished

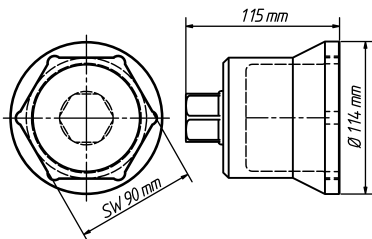

HAZET No.	l_2 mm	EAN-No. 4000896+
4937-90	115	199280

4937 Commercial vehicle oil caps / axle nut socket

Made in Germany

- Operation of the oil cap on the front axle

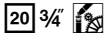

- For e.g. **IVECO** Stralis and Eurofire · **MERCEDES-BENZ** Discos Trailer with compact bearing hub unit · **BPW** Eco Plus 1 · **BPW** Eco Plus 3 · **GIGANT** trailer axles
- Precise fit
- Solid design: High (shape) stability even with high loosening or tightening torques
- Output: $s \leq 95$ mm
- Surface: burnished

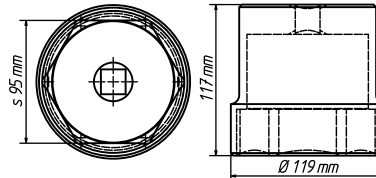

HAZET No.	l_2 mm	EAN-No. 4000896+
4937-95	117	199457

4937 Commercial vehicle centring sleeve set

Made in Germany

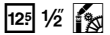

- Application: Fast assembly of centred commercial vehicle drop centre rim wheels for rim hole $\varnothing 26$ mm M22x1.5
- For e.g.: **DAF** · **FORD** · **MAN** · **MERCEDES-BENZ** · **RENAULT** · **Volvo**
- No damage of the thread as well as exact centring of the rims through conically cranked bushes
- High fitting accuracy through precise thread production
- Inside thread: M22x1.5 mm
- Surface: burnished



HAZET No.	l mm		EAN-No. 4000896+
4937-26/3	115	3	199013

4937 Commercial vehicle mounting sleeve MAN · thread M100x1.5

Made in Germany

- Mounting sleeve to protect the thread on the axle during bearing disassembly and assembly



- Use with **MAN** TGX · TGA · TGS e.g. for **MAN** HY 1350 axle (13 tonnes) · F2000 · Lion's Star · Lion's Regio · Lion's Coach · Lion's Classic · ND · NUE · NM · **NEOPLAN** Starliner · Cityliner · Centroliner · Trendliner
- Only lift the approx. 40 kg bearing unit (bearing, brake disc and wheel hub) onto the mounting sleeve once, then push up to the bearing seat with $\varnothing 105$ mm
- Thread: M100x1.5
- Outside \varnothing : 105 mm
- Drive via chequered handle surface or suitable lateral rod
- Surface: burnished



HAZET No.	\varnothing mm	EAN-No. 4000896+
4937-100	105	201983



Specialty tools

Commercial vehicles – Chassis



4937 Commercial vehicle axle nut socket set DAF · RENAULT · Volvo

Germany Made in Germany

• Screw-in guide tube allows for flexible application

- Drive 25 = 1" or ● 60 mm
- DAF with guide tube
- RENAULT · Volvo without guide tube
- With outside guide collar
- Operation with impact wrench (9014MG-1 · 9014MG-2) and torque wrench (6160-1CT · 6170-1CT)
- Precise fit
- Solid design: High (shape) stability even with high loosening or tightening torques
- Surface: burnished

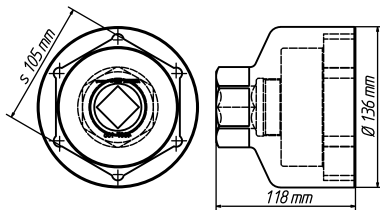

HAZET No.	l ₂ mm		EAN-No. 4000896+
4937-105/2	118	2	201938

4937 MAN commercial vehicle pin wrench set for rear axle

Germany Made in Germany

• For MAN TGX, TGA, TGS

- For e.g. rear axle HY 1350
- Drive 25 = 1" or ● 60 mm
- 6 inside pins, with 11 mm width
- Inside Ø: 134.5 mm
- Inside Ø (pin-pin) 118 mm
- Outside Ø 148.5 mm
- Operation possible with impact wrench (9014MG-1 · 9014MG-2) and torque wrench (6160-1CT · 6170-1CT)
- Precise fit
- Precise pin geometry for ideal tool operation in pin nuts
- Solid design: High (shape) stability even with high loosening or tightening torques
- Surface: burnished

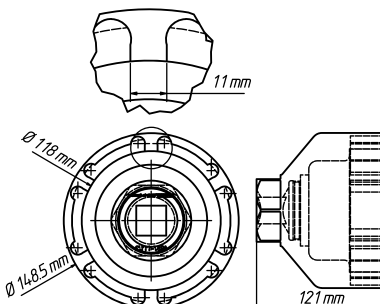

HAZET No.	l ₂ mm		EAN-No. 4000896+
4937-111/2	121	2	201945

4937 Commercial vehicle centring sleeve set

Germany Made in Germany

• For rim hole Ø 26 mm 7/8" - 11 G e.g. SCANIA

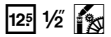

- Application: Fast assembly of centred commercial vehicle drop centre rim wheels for rim hole Ø 26 mm
- No damage of the thread as well as exact centring of the rims through conically cranked bushes
- High fitting accuracy through precise thread production
- Inside thread: 7/8" - 11 G
- Surface: burnished



HAZET No.	l mm		EAN-No. 4000896+
4937-27/3	115	3	202010

4937 Commercial vehicle mounting sleeve MERCEDES-BENZ · thread M75x 1.5

Germany Made in Germany

• Mounting sleeve to protect the thread on the axle during bearing disassembly and assembly

- Application: Use in MERCEDES-BENZ Atego, Atego 2, Tourino, Econic
- Only lift the approx. 40 kg bearing unit (bearing, brake disc and wheel hub) onto the mounting sleeve once, then push to the bearing seat with Ø 78 mm
- Thread: M75 x 1.5
- Outside Ø: 78 mm
- Drive via lateral rod or without additional tools is possible (chequered handle surface)
- Surface: burnished



HAZET No.	Ø mm	EAN-No. 4000896+
4937-7578	78	201990

4937 Commercial vehicle mounting sleeve MAN · thread M75x 1.5

Germany Made in Germany

• Mounting sleeve to protect the thread on the axle during bearing disassembly and assembly

- Application: Use with MAN TGL, TGM, L series, HL 2
- Only lift the approx. 40 kg bearing unit (bearing, brake disc and wheel hub) onto the mounting sleeve once, then push up to the bearing seat with Ø 82 mm
- Thread: M75 x 1.5
- Outside Ø: 82 mm
- Drive via lateral rod or without additional tools is possible (chequered handle surface)
- Surface: burnished



HAZET No.	Ø mm	EAN-No. 4000896+
4937-7582	82	201969



4937 Commercial vehicle mounting sleeve SAF – thread M75x1.5 right/left

Made in Germany

• Mounting sleeve to protect the thread on the bearing journal during bearing disassembly and assembly

- The sleeve has both a left-hand and a right-hand thread M75x1.5
- For SAF axles with disc and drum brakes with \varnothing 88 mm bearing seat
- Only lift the approx. 40 kg bearing unit (bearing, brake disc and wheel hub) onto the mounting sleeve once, then push up to the bearing seat with \varnothing 88 mm
- Outside \varnothing : 88 mm
- Drive via lateral rod or without additional tools is possible (chequered handle surface)
- Surface: burnished



HAZET No.	\varnothing mm	EAN-No. 4000896+
4937-7588	88	202003

4937 Commercial vehicle axle nut socket

Made in Germany

• Solid design: high (shape) stability even with high loosening or tightening torques

- Operation of the axle nut, e.g. on SAF trailer axles for repair and maintenance work
- Hexagon drive \leq 36 mm
- Output: \leq 85 mm
- Surface: burnished

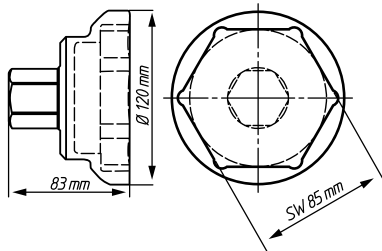

HAZET No.	l_2 mm	EAN-No. 4000896+
4937-85	83	204267



4937 Commercial vehicle pin wrench for front axle MAN

Made in Germany

• Pin wrench MAN TGX, TGA, TGS all models, model year 2000 →

- For e.g. front axle V9-82L-01 (disc brake with ABS) and MERCEDES-BENZ Atego rear axle as well as MAN · MERCEDES-BENZ · VAN HOOL and NEOPLAN buses
- Inside \varnothing : 100.5 mm
- Inside \varnothing (pin-pin): 92.5 mm
- Outside \varnothing : 114 mm
- 6 inside pins with 7 mm width
- □ Drive 20 = 3/4" as well as outside hexagon \leq 46 mm
- Use possible with ■ 20 = 3/4" impact wrench (9013MG · 9013M) and torque wrench (6145-1CT · 6150-1CT)
- Precise fit
- Precise pin geometry for ideal tool operation in pin nuts
- Solid design: High (shape) stability even with high loosening or tightening torques
- Screw connection tightening torque 750–800 Nm (please observe manufacturer's instructions)
- For: **MAN trucks:** E 2000 (ÖAF) · F 2000 · M 2000 L · M 2000 M · **MAN TGA** · TGM · TGS · TGX
- **MAN buses:** Lions City · Lions Classic · Lions Coach · Lions Regio · Lions Star as well as older constructions (models) · chassis
- **NEOPLAN** Cityliner · Starliner · Tourliner · Trendliner
- **TEMSA** Diamond · **WISEON** high-decker
- Surface: burnished

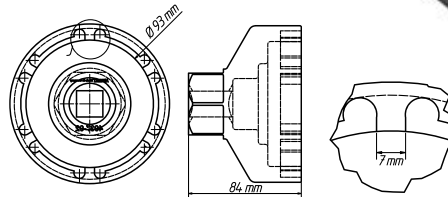

HAZET No.	l_2 mm	\varnothing mm	EAN-No. 4000896+
4937-92	84	114	201952

4937 Box-end wrench – striking face pattern · 12-point · with 2 striking faces

Made in Germany

• The 12-point profile allows application even in areas with hard-to-reach screw connections

- Application: Operating the tight cardan shaft screw connection, even when the space available is limited
- Laser-engraved formula for rapid conversion of the tightening torque specified by the manufacturer
- Especially suitable for all repairs on the go, where no working pit is available
- 2 impact areas enable the force to be applied using a hammer
- Highly stable and resilient

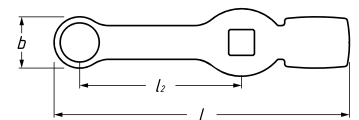

HAZET No.	l mm	a mm	b mm	EAN-No. 4000896+
For Mercedes-Benz commercial vehicle cardan shaft screw connections				
4937-19	215	12	30	215645
For MAN commercial vehicle cardan shaft screw connections				
4937-21	215	12	30	215638



Wheels / Tyres

715 Four-way rim wrench

Made in Germany

• For passenger cars, vans, people carriers and agricultural machinery

- Forged central piece
- Tested up to 500 Nm
- With $12.5 = \frac{1}{2}$ " for series 900 sockets
- Surface: chrome-plated, head polished
- DIN 3119, ISO 6788

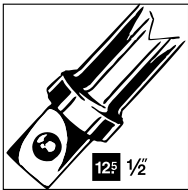

HAZET No.	S mm	l mm	EAN-No. 4000896+
715-01	17x19x22x12.5	420	029464

720 Four-way rim wrench

Made in Germany

• For commercial vehicles, tractors, agricultural and construction machinery

- Forged central piece
- Tested up to 2000 Nm
- American dimensions
- Surface: chrome-plated, head polished
- DIN 3119

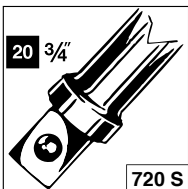

HAZET No.	S mm	l mm	EAN-No. 4000896+
720-30	24x27x30x32	750	029518
720 S	24x27x32x20	750	029532

1003 S Impact adapter

Made in Germany

• Operation of impact and power screwdriver sockets 900SZ6 · 903SZ6 · 985S · 990S · 1003S-07

- Surface: phosphatized, oiled
- Input $20 = \frac{3}{4}$ " → Output 24 mm



HAZET No.	l mm	d mm	EAN-No. 4000896+
1003 S-1	54	44	161034

772 Universal axle and slotted nut wrench tool set

• Clamping range: 35 – 170 mm

20 3/4"

- Application: Removal and precise installation of nearly all common axle nuts, e.g. hexagon nuts, 8-point nuts, slotted nuts, face nuts, round nuts with drilled holes, round nuts with pin holes etc.
- Maximum torque: 700 Nm
- Plastic box
- Safety-Insert-System, 2-component soft foam insert. Insert also suitable for HAZET Assistant



HAZET No.	Clamping range	EAN-No. 4000896+
772-2/16	16	161041

900 SLG6 1/2" Impact socket · hexagon

Made in Germany

• Operation via impact adapter e.g. HAZET 1003S-1 or nut-drivers ≤ 24 mm enables high force transmission thanks to optimal $20 \text{ mm} = \frac{3}{4}$ " drive

12.5 1/2"

- For operating wheel bolts/nuts on small commercial vehicle transporters e.g. FIAT Ducato · PEUGEOT Jumper
- Long design
- With borehole for locking pin or safety spring and groove for O-ring
- DIN 3129, ISO 2725-2

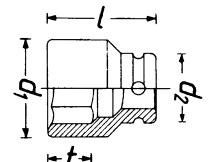
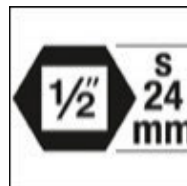

HAZET No.	l mm	d ₁ mm	d ₂ mm	t mm	EAN-No. 4000896+
900 SLG6-24	85	35	26.9	25	232789



1004 S 3/4" Impact socket · hexagon

Made in Germany

- E.g. for deeply located wheel nuts and bolts on commercial vehicles
- **Extra long design**
- With borehole for locking pin or safety spring and groove for O-ring
- Surface: phosphatized, oiled
- DIN 3129, ISO 2725-2

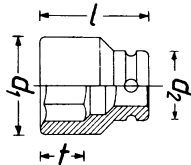
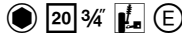

¹⁾ Not according to DIN

HAZET No.	l mm	d ₁ mm	d ₂ mm	t mm	EAN-No. 4000896+
1004 S-32	400	48	44	32	055784
1004 S-33 ¹⁾	400	48	44	32	055791

1104 S 1" Impact socket · hexagon

Made in Germany

- E.g. for deeply located wheel nuts and bolts on commercial vehicles
- **Extra long design**
- With borehole for locking pin or safety spring and groove for O-ring
- Surface: phosphatized, oiled
- DIN 3129, ISO 2725-2

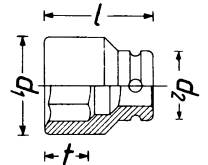
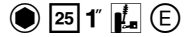

HAZET No.	l mm	d ₁ mm	d ₂ mm	t mm	EAN-No. 4000896+
1104 S-32	270	48.5	54	30.5	002665

Electricity / Battery service

Contacts / Plug connections / Cable release tool

Cable release tool

- For professional working
- High ease of use
- Safe application
- OEM quality "Made in Germany"
- Malfunctions due to loose contacts can be remedied easily, quickly and professionally
- Universal application in the field of car electricity
- With sliding caps protecting the blades from damage and avoiding the risk of injury

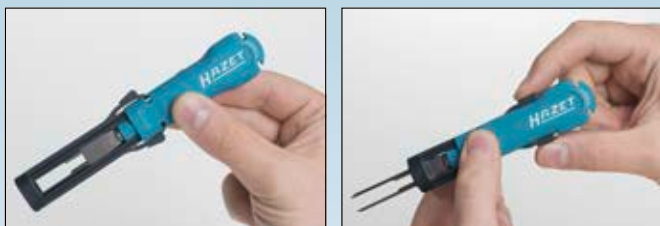

4670 Cable release tool assortment

Made in Germany

- Application: Damage-free releasing of plug contacts e.g. flat and round plug contacts
- For professional working
- High ease of use
- Safe application
- OEM quality "Made in Germany"
- Malfunctions due to loose contacts can be remedied easily, quickly and professionally
- Universal application in the field of car electricity
- With sliding caps protecting the blades from damage and avoiding the risk of injury
- Plastic box
- Soft foam insert
- Supplementary set for trucks/commercial vehicles



HAZET No.	Quantity	EAN-No. 4000896+
4670-6/9	9	135776



Specialty tools

Commercial vehicles – Body and interior equipment



4670 Cable release tool assortment

Made in Germany



- Guarantees damage-free releasing of the most common commercial vehicle contacts
- Application: Damage-free releasing of flat plug contacts, e.g. secondary locking, housing locking as well as flat spring contacts
- For professional working
- High ease of use
- Safe application
- OEM quality "Made in Germany"
- Malfunctions due to loose contacts can be remedied easily, quickly and professionally
- Universal application in the field of car electricity
- With sliding caps protecting the blades from damage and avoiding the risk of injury
- Plastic box 165-S (1/9)
- Safety-Insert-System, 2-component soft foam insert. Insert also suitable for HAZET Assistent
- Supplementary set for trucks/commercial vehicles



1/9				
-----	--	--	--	--

HAZET No.	L x W x H mm		EAN-No. 4000896+
4670-9/5	185x153x52	5	205042

4675 Unlocking tool · plug connections · VAG

Made in Germany



- VAG group plug connections · SCANIA · MAN TGE / TGX model year 2020→, e.g. injectors · rail pressure sensors · fluid level sensors · ignition coils · vacuum sensors · brake wear sensors · pressure regulators · lighting systems



Video



HAZET No.	l ₁ mm	l ₂ mm	EAN-No. 4000896+
4675-1	71	130	244331
4675-2	132	191	244348

- Damage-free unlocking of electrical plug connections on various components and sensors
- Extra-long blade, curved at the head allows access to hard-to-reach places
- Head offset 20 mm
- Damage-free unlocking of electrical plug connections on various components and sensors

Body and interior equipment

2784 SLG 1/2" Impact socket set · with special profile

Made in Germany

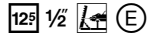

- Optimised special profile for damage-free attachment of the flat-head lightweight nuts
- Extra long style
- Application: For the operation of the lightweight nuts with special profile on the frame, fifth-wheel coupling, front carrier and vibration damper MERCEDES-BENZ on the Actros · Antos · Arocs model year 2016 →
- Surface: phosphatized



HAZET No.	l mm	Ø mm	d ₁ mm	d ₂ mm	t mm	EAN-No. 4000896+
2784 SLg-1	75	39	38.8	30	16	218240

2784 S 1/2" Impact socket set · with special profile

Made in Germany

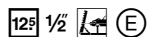

- Optimised special profile for damage-free attachment of the flat-head lightweight nuts
- Application: For the operation of the lightweight nuts with special profile on the frame, fifth-wheel coupling, front carrier and vibration damper MERCEDES-BENZ on the Actros · Antos · Arocs model year 2016 →
- Surface: phosphatized



HAZET No.	l mm	Ø mm	d ₁ mm	d ₂ mm	t mm	EAN-No. 4000896+
2784 S-1	45	39	38.8	30	16	213252

2784 SR 1/2" Box-end wrench – striking face pattern · Special profile · with 2 striking faces

Made in Germany

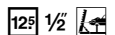

- Optimised special profile for damage-free attachment of the flat-head lightweight nuts
- Application: For the operation of the lightweight nuts with special profile on the frame, fifth-wheel coupling, front carrier and vibration damper MERCEDES-BENZ on the Actros · Antos · Arocs model year 2016 →
- Special application in case of lack of space due to design and very low vehicle body
- Surface: phosphatized

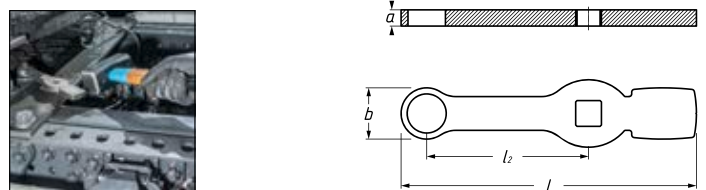

HAZET No.	l mm	l ₂ mm	a mm	b mm	EAN-No. 4000896+
2784 SR-1	220	120	12	41	229758

SOUGHT AND FOUND! IN THE NEW HAZET SPARE PARTS SHOP

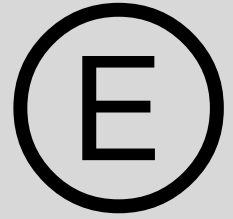

Find the right parts now!

www.hazet.de/ersatzteil-shop

Spare parts (E)	HAZET No.	EAN-No. 4000896+	
For tool cabinet 111			
• Lock with 2 keys For HAZET tool trolley 111L HAZET tool trolley <i>Assistant</i> 162C · 166N · 174	160-08 A	004294	
For tool trolley 162 C			
• Lock with 2 keys For HAZET tool trolley 111L HAZET tool trolley <i>Assistant</i> 162C · 166N · 174	160-08 A	004294	
• Container for small parts • For HAZET <i>Assistant</i> 162C · 166C · 167T tool trolleys	162 C-5	078189	
• Separation sheets , 5 pieces for intermediary tray • For <i>Assistant</i> 162C · 166C tool trolleys	162 C-6/5	120772	
• Chain with locking of chain case For HAZET <i>Assistant</i> 162C · 166C tool trolleys	162 C-01/2	079735	
• Covercomplete with worktop For HAZET <i>Assistant</i> 162C · 166C tool trolleys	162 C-010	079780	
• Swivel castor Ø 125 mm complete with brake For HAZET <i>Assistant</i> 162C · 166C tool trolleys • Tightening torque: 15 Nm	162 C-011	079865	
• Set of castors consisting of 2 swivel castors Ø 125 mm and set of fixed castors Ø 150 mm For 166C	162 C-0119	079889	
• Hand knob For HAZET <i>Assistant</i> 162C tool trolleys	162 C-080	080397	
For tool trolley 162 N			
• Lock with 2 keys For HAZET tool trolley 111L HAZET tool trolley <i>Assistant</i> 162C · 166N · 174	160-08 A	004294	
• Separation sheets , 5 pieces • For HAZET <i>Assistant</i> 162N and 166N tool trolleys	160-6/5	120741	
• Fixed castor · 125 mm Ø · complete For HAZET <i>Assistant</i> 166N tool trolleys	160-09	004300	

Spare parts (E)	HAZET No.	EAN-No. 4000896+	
For tool trolley 162 N			
• Twin swivel castor , · 75 mm Ø · with brake · complete to be used in pairs For HAZET <i>Assistant</i> 166N tool trolleys • Tightening torque: 15 Nm	160-011	004225	
• Set of castors · consisting of: 2 fixed castors · 125 mm Ø · complete 2 twin swivel castors · 75 mm Ø · with brakes · complete For 166N	160-0119	004232	
• Rubber mat for table board For HAZET tool trolley <i>Assistant</i> 166N	160-012	004263	
• Profiled rubber strip with black filler for table board or intermediary trays For HAZET tool trolley <i>Assistant</i> 166N	160-013	004270	
• Plastic bushing for bottom intermediary tray For HAZET <i>Assistant</i> 166N tool trolleys	160-15	004331	
• Indexing box for table board · complete For HAZET <i>Assistant</i> 166N tool trolleys	160-20	004348	
• Indexing box for top intermediary tray · complete For HAZET <i>Assistant</i> 166N tool trolleys	160-40	004362	
• Chain · 47 links / 470 mm length · per pair For HAZET <i>Assistant</i> 166N	160 LG-01	004447	
• Hand knob For HAZET <i>Assistant</i> 162C tool trolleys	162 C-080	080397	
For tool trolley 166 C			
• Container for small parts • For HAZET <i>Assistant</i> 162C · 166C · 167T tool trolleys	162 C-5	078189	
• Separation sheets , 5 pieces for intermediary tray • For <i>Assistant</i> 162C · 166C tool trolleys	162 C-6/5	120772	
• Chain with locking of chain case For HAZET <i>Assistant</i> 162C · 166C tool trolleys	162 C-01/2	079735	
• Cover complete with worktop For HAZET <i>Assistant</i> 162C · 166C tool trolleys	162 C-010	079780	



Information

Components and spare parts



Spare parts (E)	HAZET No.	EAN-No. 4000896+
For tool trolley 166 C		
• Swivel castor Ø 125 mm complete with brake For HAZET <i>Assistant</i> 162C · 166C tool trolleys	162C-011	079865
• Tightening torque: 15 Nm		
• Set of castors consisting of 2 swivel castors Ø 125 mm and set of fixed castors Ø 150 mm For 166C	162C-0119	079889
• Tubular pillar complete with hand knob and clamping rod For HAZET <i>Assistant</i> 166C tool trolleys	166C-070	079759
• Clamping rod complete with hand knob and clamping rod For HAZET <i>Assistant</i> 166C · 166N tool trolleys	166C-080	080403
For tool trolley 166 N		
• Lock with 2 keys For HAZET tool trolley 111L HAZET tool trolley <i>Assistant</i> 162C · 166N · 174	160-08 A	004294
• Fixed castor · 125 mm Ø · complete For HAZET <i>Assistant</i> 166N tool trolleys	160-09	004300
• Separation sheets , 5 pieces • For HAZET <i>Assistant</i> 162N and 166N tool trolleys	160-6/5	120741
• Twin swivel castor , · 75 mm Ø · with brake · complete to be used in pairs For HAZET <i>Assistant</i> 166N tool trolleys	160-011	004225
• Tightening torque: 15 Nm		
• Set of castors · consisting of: 2 fixed castors · 125 mm Ø · complete 2 twin swivel castors · 75 mm Ø · with brakes · complete For 166N	160-0119	004232
• Rubber mat for table board For HAZET tool trolley <i>Assistant</i> 166N	160-012	004263
• Profiled rubber strip with black filler for table board or intermediary trays For HAZET tool trolley <i>Assistant</i> 166N	160-013	004270
• Plastic bushing for bottom intermediary tray For HAZET <i>Assistant</i> 166N tool trolleys	160-15	004331
• Indexing box for table board · complete For HAZET <i>Assistant</i> 166N tool trolleys	160-20	004348
• Indexing box for top intermediary tray · complete For HAZET <i>Assistant</i> 166N tool trolleys	160-40	004362
• Chain · 47 links / 470 mm length · per pair For HAZET <i>Assistant</i> 166N	160 LG-01	004447
• Clamping rod complete with hand knob and clamping rod For HAZET <i>Assistant</i> 166C · 166N tool trolleys	166C-080	080403
For tool trolley 167-3 (S)		
• Fixed castor Ø 100 mm For HAZET <i>Assistant</i> 167-3 · S · 177 tool trolleys	177-09	151158
• Tightening torque: 15 Nm		
• Swivel castor with brake , Ø 100 mm For HAZET <i>Assistant</i> 167-3 · S · 177 tool trolleys	177-011	151165
• Tightening torque: 15 Nm		
• Swivel castor without brake · Ø 100 mm For HAZET <i>Assistant</i> 167-3 · S · 177 tool trolleys	177-0110	151172
• Tightening torque: 15 Nm		
For tool trolley 167 XXL		
• Fixed castor · grey · Ø 125 mm · (model year → 31/12/2020) For HAZET <i>Assistant</i> 167XXL · 179 tool trolleys · (179N · 179NX up to December 2020)	179-09	143160
• Tightening torque: 15 Nm		

Spare parts (E)	HAZET No.	EAN-No. 4000896+
For tool trolley 167 XXL		
• Swivel castor with brake · grey · Ø 125 mm · (model year → 31/12/2020) For HAZET <i>Assistant</i> 167XXL · 179 tool trolleys · (179N · 179NX up to December 2020)	179-011	143184
• Tightening torque: 15 Nm		
For tool trolley 169 N		
• Lock with 2 keys For HAZET tool trolley 111L HAZET tool trolley <i>Assistant</i> 162C · 166N · 174	160-08 A	004294
For tool trolley 171		
• Guiding rails · ball bearing · pair For HAZET <i>Assistant</i> 152N · 168N · 169HD · 171 · 172HD · 174 model year → 2000 tool trolleys	152N-07	003501
• riveted slide · inside drawer carrier width: 545 mm complete · per pair		
• Lock with 2 keys For HAZET tool trolley 111L HAZET tool trolley <i>Assistant</i> 162C · 166N · 174	160-08 A	004294
• Fixed castor · 125 mm Ø · complete For HAZET <i>Assistant</i> 166N tool trolleys	160-09	004300
• Twin swivel castor , · 75 mm Ø · with brake · complete to be used in pairs For HAZET <i>Assistant</i> 166N tool trolleys	160-011	004225
• Tightening torque: 15 Nm		
• Set of castors · consisting of: 2 fixed castors · 125 mm Ø · complete 2 twin swivel castors · 75 mm Ø · with brakes · complete For 166N	160-0119	004232
For tool trolley 172 HD		
• Guiding rails · ball bearing · pair For HAZET <i>Assistant</i> 152N · 168N · 169HD · 171 · 172HD · 174 model year → 2000 tool trolleys	152N-07	003501
• riveted slide · inside drawer carrier width: 545 mm complete · per pair		
• Swivel castor · 125 mm Ø · with brake · complete For HAZET <i>Assistant</i> 172HD tool trolleys	172-011	005550
For tool trolley 173		
• Drawer slides · for front drawers complete · per pair For HAZET <i>Assistant</i> 173 tool trolleys	173-07	089819
• Fixed castor · including screws · 125 mm Ø For HAZET <i>Assistant</i> 173 tool trolleys	173-09	089932
• Swivel castor · with brake · including screws For HAZET <i>Assistant</i> 173 tool trolleys	173-011	089949
• Lock for side-locker and closing cylinder for central locking For HAZET <i>Assistant</i> 173 tool trolleys	173-013	090174
• Pawls · plastic for locking · 5 pieces For HAZET <i>Assistant</i> 173 tool trolleys	173-017	090181
• Drawer locking pins · 5 pieces · rivets included For HAZET <i>Assistant</i> 173 and 178 tool trolleys	173-019	090198
• Locking bar For HAZET tool trolley <i>Assistant</i> 173	173-021	092741
For tool trolley 174		
• Guiding rails · ball bearing · pair For HAZET <i>Assistant</i> 152N · 168N · 169HD · 171 · 172HD · 174 model year → 2000 tool trolleys	152N-07	003501
• riveted slide · inside drawer carrier width: 545 mm complete · per pair		



Spare parts (E)	HAZET No.	EAN-No. 4000896+
For tool trolley 174		
• Lock with 2 keys For HAZET tool trolley 111L HAZET tool trolley <i>Assistant</i> 162C · 166N · 174	160-08 A	004294
For tool trolley 177		
• Cylinder lock with 2 keys For HAZET <i>Assistant</i> 177 tool trolleys	177-04	151226
• Fixed castor Ø 100 mm For HAZET <i>Assistant</i> 167-3 · S · 177 tool trolleys	177-09	151158
• Tightening torque: 15 Nm		
• Swivel castor with brake , Ø 100 mm For HAZET <i>Assistant</i> 167-3 · S · 177 tool trolleys	177-011	151165
• Tightening torque: 15 Nm		
• Swivel castor without brake · Ø 100 mm For HAZET <i>Assistant</i> 167-3 · S · 177 tool trolleys	177-0110	151172
• Tightening torque: 15 Nm		
• Flat drawer · including ball-bearing guiding rails For HAZET <i>Assistant</i> 177 · 177W tool trolleys	177-80	151189
• Ball-bearing guiding rails · pair For HAZET <i>Assistant</i> 177 · 177W · 178 · 178N · 178NK tool trolleys	178-07/2	143443
• Locking bar for individual locking For HAZET <i>Assistant</i> 177 · 177W · 178 · 179 · 179W tool trolleys	179-056	146215
For tool trolley 178		
• Drawer locking pins · 5 pieces · rivets included For HAZET <i>Assistant</i> 173 and 178 tool trolleys	173-019	090198
• Ball-bearing guiding rails · pair For HAZET <i>Assistant</i> 177 · 177W · 178 · 178N · 178NK tool trolleys	178-07/2	143443
• Flat drawer · 75 mm For HAZET <i>Assistant</i> 178 tool trolleys	178-050	146178
• Edge protection For HAZET <i>Assistant</i> 178 tool trolleys	178-093	143221
• Fixed castor · grey · Ø 125 mm · (model year → 31/12/2020) For HAZET <i>Assistant</i> 167XXL · 179 tool trolleys · (179N · 179NX up to December 2020)	179-09	143160
• Tightening torque: 15 Nm		
• Swivel castor with brake · grey · Ø 125 mm · (model year → 31/12/2020) For HAZET <i>Assistant</i> 167XXL · 179 tool trolleys · (179N · 179NX up to December 2020)	179-011	143184
• Tightening torque: 15 Nm		
• Separation sheet for flat drawer For HAZET <i>Assistant</i> 177W · 178 · 179 · 179W tool trolley	179-055	145782
• Locking bar for individual locking For HAZET <i>Assistant</i> 177 · 177W · 178 · 179 · 179W tool trolleys	179-056	146215
• Separation sheet for high drawer For HAZET <i>Assistant</i> 178 · 179 · 179W tool trolleys	179-065	146239
For tool trolley 179		
• Guiding rails · pair For HAZET <i>Assistant</i> 179 · 179W tool trolleys	179-07/2	143177
• Set of locks For HAZET <i>Assistant</i> 179-1 tool trolleys	179-08/2	188659
• Fixed castor · grey · Ø 125 mm · (model year → 31/12/2020) For HAZET <i>Assistant</i> 167XXL · 179 tool trolleys · (179N · 179NX up to December 2020)	179-09	143160
• Tightening torque: 15 Nm		

Spare parts (E)	HAZET No.	EAN-No. 4000896+
For tool trolley 179		
• Swivel castor with brake · grey · Ø 125 mm · (model year → 31/12/2020) For HAZET <i>Assistant</i> 167XXL · 179 tool trolleys · (179N · 179NX up to December 2020)	179-011	143184
• Tightening torque: 15 Nm		
• Locking bolt plate For HAZET <i>Assistant</i> 179 · 179W tool trolleys	179-019	146208
• Flat drawer · 75 mm For HAZET <i>Assistant</i> 179 · 179W tool trolleys	179-050	146192
• High drawer · 160 mm For HAZET <i>Assistant</i> 179 tool trolley	179-051	146185
• Separation sheet for flat drawer For HAZET <i>Assistant</i> 177W · 178 · 179 · 179W tool trolley	179-055	145782
• Locking bar for individual locking For HAZET <i>Assistant</i> 177 · 177W · 178 · 179 · 179W tool trolleys	179-056	146215
• Separation sheet for high drawer For HAZET <i>Assistant</i> 178 · 179 · 179W tool trolleys	179-065	146239
For tool trolley 179N (X)		
• Fixed castor · grey · Ø 125 mm · (model year → 31/12/2020) For HAZET <i>Assistant</i> 167XXL · 179 tool trolleys · (179N · 179NX up to December 2020)	179-09	143160
• Tightening torque: 15 Nm		
• Swivel castor with brake · grey · Ø 125 mm · (model year → 31/12/2020) For HAZET <i>Assistant</i> 167XXL · 179 tool trolleys · (179N · 179NX up to December 2020)	179-011	143184
• Tightening torque: 15 Nm		
• Cable For HAZET tool trolley <i>Assistant</i> model year → 1/8/2019: 179N · 179NX	179 N-01	216703
• Locking bar For HAZET tool trolley <i>Assistant</i> 179N · 179NX · 179NXL · 179NXXL	179 N-04	216475
• Worktop · plastic For HAZET <i>Assistant</i> 179N tool trolleys	179 N-05	216710
• Cover cap For HAZET <i>Assistant</i> 179N · 179NX · 179NXL · 179NXXL tool trolleys	179 N-05 K	216666
• Pull-handle For HAZET <i>Assistant</i> 179N tool trolleys	179 N-06	216468
• Tightening torque: 10 Nm		
• Telescopic rails · pair For HAZET <i>Assistant</i> 179N · 179NW · 179NX tool trolleys	179 N-07/2	216697
• Cylinder lock with 2 keys For HAZET tool trolleys <i>Assistant</i> model year → 1/8/2019: 179N · 179NX · 179NXL · 179NXXL	179 N-08	217311
• Drawer locking hook For HAZET <i>Assistant</i> 179N · 179NW · 179NX · 179NXL · 179NXXL tool trolleys	179 N-019	216635
• Drawer · flat complete including telescopic rails (pair) · drawer handle profile · drawer locking hook For HAZET <i>Assistant</i> 179N · 179NW · 179NX tool trolleys	179 N-050	216659
• Drawer · high complete including telescopic rails (pair) · drawer handle profile · drawer locking hook For HAZET <i>Assistant</i> 179N · 179NX tool trolleys	179 N-051	216642
• Drawer handle profile For HAZET <i>Assistant</i> tool trolleys 179N · 179NW · 179NX	179 N-057	216628



Information

Components and spare parts



Spare parts (E)	HAZET No.	EAN-No. 4000896+
For tool trolley 179N (X)		
• Lower edge protection with lettering "Made in Germany" for HAZET <i>Assistant</i> model year → 1/5/2019: 179N · 179NW · 179NX · 179NXL · 179NXXL tool trolleys	179N-093	216680
• Upper edge protection with "HAZET" logo For HAZET <i>Assistant</i> model year 1/5/2019 →: 179N · 179NX · 179NXL · 179NXXL tool trolleys	179N-094	216673
• Work surface · stainless steel for HAZET <i>Assistant</i> 179NX tool trolleys	179NX-05	217298
• Plastic cover For HAZET tool trolley <i>Assistant</i> 179NX · 179NXL · 179NXXL	179NX-05 G	217304
• Plastic cover For HAZET <i>Assistant</i> 179NX · 179NXL · 179NXXL tool trolleys	179NX-05 R	217328
• Stainless steel pull-handle For HAZET <i>Assistant</i> 179NX · 179NXL · 179NXXL tool trolleys • Tightening torque: 10 Nm	179NX-06	216727
For tool trolley 179 XL		
• Worktop For HAZET tool trolley <i>Assistant</i> 179XL	179XL-05	181292
• Plastic cover · on handle side For HAZET <i>Assistant</i> 179A XXL · 179T XXL · 179XL · 179XXL tool trolleys	179XL-05 G	181308
• Cylinder lock with 2 keys For HAZET <i>Assistant</i> 178N · 178NK · 179XL · 179XXL tool trolleys	179XL-08	181124
• Locking bolt plate for HAZET <i>Assistant</i> 179A XXL · 179T XXL · 179XL · 179XXL tool trolleys	179XL-019	181278
• Plastic cover with logo For HAZET tool trolley <i>Assistant</i> 179 · 179A XXL · 179T XXL · 179XL · 179XXL	179XL-045 L	181285
For tool trolley 179NXL		
• Locking bar For HAZET tool trolley <i>Assistant</i> 179N · 179NX · 179NXL · 179NXXL	179N-04	216475
• Cover cap For HAZET <i>Assistant</i> 179N · 179NX · 179NXL · 179NXXL tool trolleys	179N-05 K	216666
• Cylinder lock with 2 keys For HAZET tool trolleys <i>Assistant</i> model year → 1/8/2019: 179N · 179NX · 179NXL · 179NXXL	179N-08	217311
• Drawer locking hook For HAZET <i>Assistant</i> 179N · 179NW · 179NX · 179NXL · 179NXXL tool trolleys	179N-019	216635
• Lower edge protection with lettering "Made in Germany" for HAZET <i>Assistant</i> model year → 1/5/2019: 179N · 179NW · 179NX · 179NXL · 179NXXL tool trolleys	179N-093	216680
• Edge protection · upper with "HAZET" logo For HAZET <i>Assistant</i> model year 1/5/2019 →: 179N · 179NX · 179NXL · 179NXXL tool trolleys	179N-094	216673
• Plastic cover For HAZET tool trolley <i>Assistant</i> 179NX · 179NXL · 179NXXL	179NX-05 G	217304
• Plastic cover For HAZET <i>Assistant</i> 179NX · 179NXL · 179NXXL tool trolleys	179NX-05 R	217328
• Stainless steel pull-handle For HAZET <i>Assistant</i> 179NX · 179NXL · 179NXXL tool trolleys • Tightening torque: 10 Nm	179NX-06	216727
• Cable For HAZET tool trolley <i>Assistant</i> model year → 1/8/2019: 179NXL	179NXL-01	216802
• Work surface · stainless steel for HAZET <i>Assistant</i> 179NXL tool trolleys	179NXL-05	217281

Spare parts (E)	HAZET No.	EAN-No. 4000896+
For tool trolley 179NXL		
• Telescopic rails · pair For HAZET <i>Assistant</i> 179NW · 179NXL · 179NXXL tool trolleys	179NXL-07/2	216789
• Drawer · flat complete including telescopic rails (pair) · drawer handle profile · drawer locking hook For HAZET <i>Assistant</i> 179NW tool trolley	179NXL-050	217267
• Drawer · high complete including telescopic rails (pair) · drawer handle profile · drawer locking hook For HAZET <i>Assistant</i> 179NW tool trolley	179NXL-051	217250
• Drawer handle profile For HAZET <i>Assistant</i> 179NXL tool trolleys	179NXL-074	216826
• Fixed castor · black · Ø 125 mm (model year → 31/12/2020) For HAZET <i>Assistant</i> 179A XXL · 179T XXL · 179XL · 179XXL · 179NW · 179NXL · 179NXXL tool trolleys	179W-09	146666
• Swivel castor with brake · black · Ø 125 mm (model year → 31/12/2020) For HAZET <i>Assistant</i> 179A XXL · 179XL · 179XXL · 179NXL · 179NXXL · 179T XXL · 179NW tool trolleys	179W-011	146659
For tool trolley 179 XXL		
• Drawer handle profile · for 5/3 drawer For HAZET <i>Assistant</i> 179A XXL tool trolleys · 179T XXL · 179XXL	179XXL-092	181339
For tool trolley 179NXXL		
• Locking bar For HAZET tool trolley <i>Assistant</i> 179N · 179NX · 179NXL · 179NXXL	179N-04	216475
• Cover cap For HAZET <i>Assistant</i> 179N · 179NX · 179NXL · 179NXXL tool trolleys	179N-05 K	216666
• Cylinder lock with 2 keys For HAZET tool trolleys <i>Assistant</i> model year → 1/8/2019: 179N · 179NX · 179NXL · 179NXXL	179N-08	217311
• Drawer locking hook For HAZET <i>Assistant</i> 179N · 179NW · 179NX · 179NXL · 179NXXL tool trolleys	179N-019	216635
• Edge protection · lower with lettering "Made in Germany" for HAZET <i>Assistant</i> model year → 1/5/2019: 179N · 179NW · 179NX · 179NXL · 179NXXL tool trolleys	179N-093	216680
• Edge protection · upper with "HAZET" logo For HAZET <i>Assistant</i> model year 1/5/2019 →: 179N · 179NX · 179NXL · 179NXXL tool trolleys	179N-094	216673
• Plastic cover For HAZET tool trolley <i>Assistant</i> 179NX · 179NXL · 179NXXL	179NX-05 G	217304
• Plastic cover For HAZET <i>Assistant</i> 179NX · 179NXL · 179NXXL tool trolleys	179NX-05 R	217328
• Stainless steel pull-handle For HAZET <i>Assistant</i> 179NX · 179NXL · 179NXXL tool trolleys • Tightening torque: 10 Nm	179NX-06	216727
• Telescopic rails · pair For HAZET <i>Assistant</i> 179NW · 179NXL · 179NXXL tool trolleys	179NXL-07/2	216789
• Cable For HAZET <i>Assistant</i> model year → 1/8/2019: 179NXXL tool trolleys	179NXXL-01	216796
• Work surface · stainless steel for HAZET <i>Assistant</i> 179NXXL tool trolleys	179NXXL-05	217274
• Drawer · flat complete including telescopic rails (pair) · drawer handle profile · drawer locking hook For HAZET <i>Assistant</i> 179NW tool trolley	179NXXL-050	217243



Spare parts (E)	HAZET No.	EAN-No. 4000896+
For tool trolley 179NXXL		
• Drawer · high complete including telescopic rails (pair) · drawer handle profile · drawer locking hook (pair) · handle profile screws · drawer locking hook screws For HAZET <i>Assistant</i> 179NW tool trolley	179 NXXL-051	217236
• Drawer handle profile For HAZET <i>Assistant</i> 179NXXL tool trolleys	179 NXXL-091	216819
• Fixed castor · black · Ø 125 mm (model year → 31/12/2020) For HAZET <i>Assistant</i> 179A XXL · 179T XXL · 179XL · 179XXL · 179NW · 179NXL · 179NXXL tool trolleys	179 W-09	146666
• Swivel castor with brake · black · Ø 125 mm (model year → 31/12/2020) For HAZET <i>Assistant</i> 179A XXL · 179XL · 179XXL · 179NXL · 179NXXL · 179T XXL · 179NW tool trolleys	179 W-011	146659
For tool trolley 179 T XXL		
• Cylinder lock set For HAZET <i>Assistant</i> 179NW · 179T XXL tool trolleys	179 TXXL-08/2	181438
• High drawer · with 3/3 width For HAZET <i>Assistant</i> 179A XXL · 179T XXL tool trolleys	179 TXXL-051	181384
For work bench 177 W		
• Flat drawer · including ball-bearing guiding rails For HAZET <i>Assistant</i> 177 · 177W tool trolleys	177-80	151189
• Ball-bearing guiding rails · pair For HAZET <i>Assistant</i> 177 · 177W · 178 · 178N · 178NK tool trolleys	178-07/2	143443
• Separation sheet for flat drawer For HAZET <i>Assistant</i> 177W · 178 · 179 · 179W tool trolley	179-055	145782
• Locking bar for individual locking For HAZET <i>Assistant</i> 177 · 177W · 178 · 179 · 179W tool trolleys	179-056	146215
For work bench 179 W		
• Guiding rails · pair For HAZET <i>Assistant</i> 179 · 179W tool trolleys	179-07/2	143177
• Locking bolt plate For HAZET <i>Assistant</i> 179 · 179W tool trolleys	179-019	146208
• Flat drawer · 75 mm For HAZET <i>Assistant</i> 179 · 179W tool trolleys	179-050	146192
• Separation sheet for flat drawer For HAZET <i>Assistant</i> 177W · 178 · 179 · 179W tool trolley	179-055	145782
• Locking bar for individual locking For HAZET <i>Assistant</i> 177 · 177W · 178 · 179 · 179W tool trolleys	179-056	146215
• Separation sheet for high drawer For HAZET <i>Assistant</i> 178 · 179 · 179W tool trolleys	179-065	146239
For work bench 179NW		
• Telescopic rails · pair For HAZET <i>Assistant</i> 179N · 179NW · 179NX tool trolleys	179 N-07/2	216697
• Drawer locking hook For HAZET <i>Assistant</i> 179N · 179NW · 179NX · 179NXL · 179NXXL tool trolleys	179 N-019	216635
• Drawer · flat complete including telescopic rails (pair) · drawer handle profile · drawer locking hook For HAZET <i>Assistant</i> 179N · 179NW · 179NX tool trolleys	179 N-050	216659
• Drawer handle profile For HAZET <i>Assistant</i> tool trolleys 179N · 179NW · 179NX	179 N-057	216628

Spare parts (E)	HAZET No.	EAN-No. 4000896+
For work bench 179NW		
• Lower edge protection with lettering "Made in Germany" for HAZET <i>Assistant</i> model year → 1/5/2019: 179N · 179NW · 179NX · 179NXL · 179NXXL tool trolleys	179 N-093	216680
• Locking bar For HAZET tool trolley <i>Assistant</i> 179NW	179 NW-04	220151
• Worktop · wood For HAZET <i>Assistant</i> 179NW tool trolleys	179 NW-05	220175
• Magnetic catch including 2 screws For HAZET <i>Assistant</i> 179NW tool trolleys	179 NW-012	220182
• Door , lockable, including hinges (2x), grip profile For HAZET <i>Assistant</i> 179NW tool trolleys	179 NW-21	220168
• Drawer · high complete including telescopic rails (pair) · drawer grip profile · drawer locking hook For HAZET <i>Assistant</i> 179NW tool trolley	179 NW-051	220144
• Upper edge protection with "HAZET" logo for HAZET <i>Assistant</i> model year 1/5/2019 →: 179NW tool trolleys	179 NW-094	220137
• Telescopic rails · pair For HAZET <i>Assistant</i> 179NW · 179NXL · 179NXXL tool trolleys	179 NXL-07/2	216789
• Cylinder lock set For HAZET <i>Assistant</i> 179NW · 179T XXL tool trolleys	179 TXXL-08/2	181438
• Fixed castor · black · Ø 125 mm (model year → 31/12/2020) For HAZET <i>Assistant</i> 179A XXL · 179T XXL · 179XL · 179XXL · 179NW · 179NXL · 179NXXL tool trolleys	179 W-09	146666
• Swivel castor with brake · black · Ø 125 mm (model year → 31/12/2020) For HAZET <i>Assistant</i> 179A XXL · 179XL · 179XXL · 179NXL · 179NXXL · 179T XXL · 179NW tool trolleys	179 W-011	146659
For mechanic's creeper 195-2		
• Replacement swivel castors · 2 pieces For mechanic's creeper HAZET 195-2	195-02/2	162499
For rubber mat 196 VDE		
Bag for HAZET rubber mat 196VDE-8	196-8 TL	173921
Various component parts		
Socket rail, empty for 450 N/8 RS and 610 N/8 RS	450 N/8 RSL	020294
450N/12RS · 450N/12NRS · 610N/12RS	450 N/12 RSL	020270
• Plastic part with screws for 650K-20	650 K-020/6	028689
• Plastic hammer head for 665-1 and 665-2	665-01	029211
• Hand guard for HAZET flat chisel 730-6 · 7 · 8 • Made of impact-resistant plastic	730 HS	029631
• Punch tip for 747-1	747-02	051380
• Tightening strap For HAZET piston ring collet chuck 794U-3	794 U-301	031689
• Segment with slip band For HAZET piston ring collet chuck 794U-3	794 U-303	031702
• Replacement set · consisting of: 2 retaining bolts · 2 lock washers for 798	798-0/4	031849
798-1	798-01/4	031856
798-3	798-03/6	107513
798-5	798-05/4	031894
798-10	798-010/4	031863
798-6 · 798-8 · 798-12	798-012/4	031870
• Bowden cable · complete with fixing kit 2x nuts M4 for 798-15	798-0151	082254
• Bowden cable for 798-15	798-0152	082247



Information

Components and spare parts



Spare parts (E)	HAZET No.	EAN-No. 4000896+
Various component parts		
• Bowden cable · complete Bowden cable · coating · 2 headless screws · spring for 798-15A	798-0151 A	097753
• Flexible hose for 798-15B	798-0150 B	142439
• Bowden cable for 798-15A and B	798-0152 A	097760
• Sliding guide device for 798-15A and B	798-0153 A	097784
• Spare blade set · for 822 5 pieces per set	822-01/5	033720
• Hard-metal tip for 825-25	825-025	033928
• Spare chisel for mechanical · HAZET nut splitters 847-0410A and 1027A	847-10 A	144150
For reversible ratchet etc.		
• Replacement set for shift lever consisting of: shift lever · pawl · screws · ball · compression spring For HAZET reversible ratchet 863K · 863 · 863G · 863P · 863PC · 863Q · 863S · 863ST · 863BGL · 863BKC · 863BK · 863MC · 863Mbit · 2264	863 P/6	144600
• Replacement set for ratchet wheel 6.3 = ¼" ■ consisting of: ratchet wheel · pawl · shift lever · screws · ball · compression spring For HAZET reversible ratchet 863G · 863P · 863PC · 863ST · 863K · 863MC	863 P/7 N	038596
• Replacement set for ratchet wheel with safety lock 6.3 = ¼" ■ consisting of: Ratchet wheel with safety lock · pawl · shift lever · screws · ball · compression spring For HAZET reversible ratchets 863Q · 863S as well as for retrofitting HAZET reversible ratchets 863P · 863PC · 863G · 863ST · 863K · 863MC	863 S/7	048472
• Fixing clamp for HAZET spark plug wrench 880KF · 900KF · 4767KF	880 KF-01	050123
• Fixing clamp for HAZET spark plug wrench 880A KF · 900A KF · 4766 · 4766-1 · 4767A KF	880 A KF-01	050130
• Replacement set for shift lever consisting of: shift lever · screws · ball · compression spring · pawl For HAZET reversible ratchet 8816G · 8816GK · 8816P · 8816S · 8816ST · 916K · 2264-1 For HAZET torque wrench 5110-2CT · 5120-2CT · 5110-3CT · 5111-3CT · 5120-3CT · 6110CT · 6110-1CT · 6111-1CT · 6114-1CT · 6115-1CT · 6402-1 · 6402-1S · 6408-1	8816 P/6	144617
• Replacement set for ratchet wheel 10 = ¾" ■ consisting of: ratchet wheel · pawl · shift lever · screws · ball · compression spring For HAZET reversible ratchet 8816G · 8816GK · 8816P · 8816ST For HAZET torque wrench 5110-2CT · 5110-3CT · 5111-3CT · 6110CT · 6110-1CT · 6111-1CT · 6114-1CT · 6115-1CT · 6402-1	8816 P/7 N	042234
• Replacement set for ratchet wheel with safety lock 10 = ¾" ■ consisting of: Ratchet wheel with safety lock · pawl · shift lever · screws · ball · compression spring For HAZET reversible ratchets 8816S · 6402-1S as well as for retrofitting HAZET reversible ratchets 8816P · 8816G · 8816GK · 8816ST · 6110CT · 6110-1CT · 6111-1CT · 6114-1CT · 6115-1CT · 6402-1	8816 S/7	048465
• Plastic handle for HAZET 8814 · 8816P · 8816F · 8816G · 8816GK · 2593Lg-17	8816 KG-02	042166

Spare parts (E)	HAZET No.	EAN-No. 4000896+
For reversible ratchet etc.		
• Replacement set for hinge connection consisting of: screw and lock washer For HAZET flexible handle 8814 and HAZET reversible ratchet 8816G · 8816GK	8816 G-013	042111
• Replacement set · consisting of: hinged section · screw and lock washer For HAZET flexible handle 914-15 and 914-18	914/3	046065
• Replacement set for hinge connection consisting of: screw and lock washer For HAZET flexible handle 914-15 · 914-18 and HAZET reversible ratchet 916GK	916 G-013	046188
• Plastic handle for HAZET 916F · 916SP · 2574 · 2574-1	916 KG-02	046225
• Plastic handle for HAZET 771A-13/16 · 771-17 · 771-19 · 771-21 · 772 · 914-15 · 914-18 · 916GK	916 KG-04	046249
• Replacement set for ratchet wheel with safety lock 12.5 = ½" ■ consisting of: Shift lever · 2 screws · ball · compression spring · ratchet wheel with safety lock · pawl For HAZET reversible ratchet 916S as well as for retrofitting HAZET reversible ratchets 916SP · 916GK · 916L · 916ST	916 S/7	046300
• Replacement set for shift lever 12.5 = ½" ■ consisting of: shift lever · 2 screws · ball and compression spring and pawl For HAZET reversible ratchet 916S · 916SP · 916GK · 916LG · 916L · 916GL · 916ST and beam puller 1774-1	916 SP/6	144624
• Replacement set for ratchet wheel 12.5 = ½" ■ consisting of: shift lever · screws · ball · compression spring · ratchet wheel and pawl For HAZET reversible ratchet 916SP · 916GK · 916Lg · 916L · 916GL · 916ST	916 SP/7-1	046348
• Replacement set for ratchet wheel 12.5 = ½" ■ consisting of: shift lever · screws · ball · ratchet wheel and pawl For HAZET reversible ratchet 916K	916 K/7	155743
• Replacement set for shift lever consisting of: shift lever · screws · ball · compression spring For HAZET reversible ratchet 1016 · 1016/2 For HAZET torque wrench 5143-3CT · 5145-3CT · 6132-1CT · 6143CT · 6143-1CT · 6144CT · 6144-1CT · 6145CT · 6145-1CT · 6146-1CT	1016/6	001972
• Replacement set for ratchet wheel 20 = ¾" ■ consisting of: ratchet wheel · pawl · shift lever · screws · ball · compression spring For HAZET reversible ratchet 1016 · 1016/2 For HAZET torque wrench 5145-3CT · 6132-1CT · 6143CT · 6143-1CT · 6144CT · 6144-1CT · 6145CT · 6145-1CT · 6146-1CT	1016/8 N	001989
• Insert square for HAZET adapter 1058-2	1058-02 A	233557
• Replacement set for shift lever consisting of: shift lever · screws · ball · compression spring For HAZET reversible ratchet 1116 For HAZET torque wrench 6150-1CT · 6160-1CT · 6170-1CT · 7250-2 sTAC · 7250-5 sTAC	1116/6	003228



Spare parts (E)	HAZET No.	EAN-No. 4000896+
For reversible ratchet etc.		
• Replacement set for ratchet wheel 25 = 1" ■ consisting of: shift lever · screws · ball · compression spring · pawl · ratchet wheel For HAZET reversible ratchet 1116 For HAZET torque wrench 6160-1CT · 6170-1CT	1116/8 N	003235
For range of pullers/ extractors		
Spindle M14x1.5x140 For HAZET puller 1786F-9 · 13 · 1786S-1 · 1786S/12 · 1786FS/6 · 1787F-9 · 13 · 1787S-1	1786-01	134724
Spindle G½x210 for 1786F-16 · 20 · 1786S-2 · 1787F-16 · 20 · 1787S-2	1786 S-03	134793
Various component parts		
• Telescopic spring for 1805-3 · 1806-1 to -4	1806-01	006175
• Conversion tips · bent at 90° To convert the pliers 1846 a-5	1846 B-05/2	081318
• Conversion tips · bent at 90° To convert the pliers 1846 c-5	1846 D-05/2	081370
• Replacement set · consisting of: 1 pair of jaws · 15 mm wide · 2 screws and 2 sleeves For 1932-1 · -2 · -5	1932-1/6	007820
• Replacement set · consisting of: 1 pair of jaws · 30 mm wide · 2 screws and 2 sleeves For 1932-1 · -2 · -5	1932-2/6	007905
• Spare heads · pair for HAZET plastic soft-faced hammer 1952-28	1952-028	008391
1952-35	1952-035	008414
1952-40	1952-040	008438
1952-50	1952-050	008452
• Replacement set · consisting of: 1 handle and 2 cylinder screws For 1959-3 and -4	1959-03/3	008711
• Chuck jaws · 2 pieces for 1963	1963-05	008957
Spare cutting crowns, set of 5, for 1967	1967-01/5	211319
• Tip for HAZET welding spot drill 1967	1967-02	009336
• Mirror and 2 spare bulbs for HAZET inspection mirror 1977-1	1977-01/3	009794
• Spare bulb for HAZET inspection mirror 1977-1	1977-02	070442
• Spare bulb for HAZET flexible light 1977-1	1978-01	076154
• Saw blade for 1981, made of chrome-alloyed tool steel • Number of teeth/inch: 32 (1 inch = 25.4 mm)	1981-01	009848
Plastic clip , empty, for offset screwdriver set HAZET 2105LG/9H	2105 LG/9 HL	012022
• Diaphragm for HAZET stethoscope 2151	2151-01	013050
• Ear tips for HAZET stethoscope 2151	2151-02/2	062287
• Tubular lamp · Soffitte for 2153	2153-00	013128
• Snap-off blades , e.g. for trimming knife 2157 · 7 break-away parts 100x18 mm set of 10 pieces	2157-04	013210
• Trapezoid blades with 2 holes · e.g. for universal knife 2157 set of 10 pieces	2157-05	013227
• Hook blades · e.g. for universal knife 2157 · set of 10 pieces	2157-06	013234
• Trapezoid blades with 3 holes · e.g. for 2157-1 set with 10 pieces	2157-07	150977
• Replacement set · consisting of: belt and rivet for 2170 • Belt length: 600 mm • Cotton textile tape · rubber coated · belt height 19.6 mm • Non-skidding	2170/2	013388
• Tightening strap · 396 mm long · for 2171-5	2171-05	013395

Spare parts (E)	HAZET No.	EAN-No. 4000896+
Various component parts		
• Tightening strap · 496 mm long · for 2171-6	2171-06	013401
• Replacement set for ratchet wheel ○ 6.3 = ¼" consisting of: ratchet wheel · pawl · shift lever · screws · ball · compression spring For HAZET reversible ratchet 863BGL · 863BKC · 863BK · 863MBit · 2264	2264/7	015917
• Replacement set for ratchet wheel ○ 8 = ⅜" consisting of: ratchet wheel · pawl · shift lever · screws · ball · compression spring For HAZET reversible ratchet 2264-1 · 6408-1	2264-1/7	015900
• Spare chain for 4682-1	4682-03	149421
4682	4682-01	022175
• Replacement set · 9 pieces for repairing the cutting chain 4682-01 For 4682	4682-01/9	057214
• Pipette for 4810A · 4810B • Capacity: 3 ml	4810 B-05	082650
• Pull handle for collecting the cutting wire	4852-3	129454
• Wire starter for puncturing the glue bead	4852-5	129478
• Replacement set · for spring vice 4900-1A and -2A consisting of 2 straight pins and 1 O-ring	4900-02 A/3	069415
• Replacement set · for spring vice 4900-1 and 4900-2 consisting of 5 straight pins and 2 O-rings	4900-02/7	063437
• Plastic insert for protection of the lacquered spring surfaces preventing coil damage due to corrosion	4900-100	061136
• Plastic insert for protection of the lacquered spring surfaces preventing coil damage due to corrosion	4900-110	061143
• Plastic insert for protection of the lacquered spring surfaces preventing coil damage due to corrosion	4900-120	061150
For torque wrenches		
• Sliding square without knob 10 = ⅜" ■ For 5110CT · 5110ST · 5110-1	5110-02	022373
• Replacement display window For HAZETCLT torque wrench 5121-2CLT · 5122-2CLT · 5123-2CLT	5000 CLT-02	117154
• Sliding square 12.5 = ½" ■ For 5121CT · 5121ST · 5121-1 5122CT · 5122ST · 5122-1 5123CT · 5123ST · 5123-1	6414-1	027675
• Plastic handle For torque wrenches HAZET 6391-12 · V 6391-25 · V · 35 · V · 50 · V · 85 · V 6392-200 · V · 320 · V	6391-06 6391-07 6392-04	026999 027002 027095
• Replacement set for twist lock consisting of: lock spring · twist lock with 2 headless screws For HAZET torque wrench 6010-1CT · 6110-1CT · 6114-1CT · 6290-1CT	6110-27	025053
• Replacement set for twist lock consisting of: lock spring · twist lock with 2 headless screws For HAZET torque wrench 5121-2CLT · 5122-2CLT · 5123-2CLT · 5128-2CLT 6021-1CT · 6022-1CT · 6023-1CT 6111-1CT · 6115-1CT · 6121-1CT · 6122-1CT · 6123-1CT · 6127-1CT · 6128-1CT 6291-1CT · 6292-1CT · 6293-1CT · 6722TAC · 6291-2CT	6122-27	025299



Information

Components and spare parts



Spare parts (E)	HAZET No.	EAN-No. 4000896+
For torque wrenches		
• Replacement set for twist lock consisting of: twist lock · lock spring and cylinder screw For HAZET torque wrench model year → 2013 6132-1CT · 6143-1CT · 6144-1CT · 6145-1CT · 6150-1CT · 6160-1CT · 6170-1CT 6243-1CT · 6244-1CT · 6245-1CT · 6146-1CT · 6246-1CT, 6294-1CT · 6295-1CT · 6296-1CT	6144-01/3	025527
• Replacement set for twist lock consisting of: twist lock · lock spring and threaded pin For HAZET torque wrenches model year 2014 → 6132-1CT · 6143-1CT · 6144-1CT · 6145-1CT · 6150-1CT · 6160-1CT · 6170-1CT 6243-1CT · 6244-1CT · 6245-1CT · 6146-1CT · 6246-1CT 6294-1CT · 6295-1CT · 6296-1CT	6144-02/3	192557
• Replacement set for ratchet wheel 20 = ¾" ■ consisting of: ratchet wheel · pawl · shift lever · screws · ball · compression spring For HAZET reversible ratchet 1016 · 1016/2 For HAZET torque wrench 5145-3CT · 6132-1CT · 6143CT · 6143-1CT · 6144CT · 6144-1CT · 6145CT · 6145-1CT · 6146-1CT	1016/8 N	001989
• Replacement set for ratchet wheel 25 = 1" ■ consisting of: shift lever · screws · ball · compression spring · pawl · ratchet wheel For HAZET reversible ratchet 1116 For HAZET torque wrench 6160-1CT · 6170-1CT	1116/8 N	003235
• Replacement set for ratchet wheel 10 = ¾" ■ consisting of: ratchet wheel · pawl · shift lever · screws · ball · compression spring For HAZET reversible ratchet 8816G · 8816GK · 8816P · 8816ST For HAZET torque wrench 5110-2CT · 5110-3CT · 5111-3CT 6110CT · 6110-1CT · 6111-1CT 6114-1CT · 6115-1CT · 6402-1	8816 P/7 N	042234
• Replacement set for shift lever · complete 12.5 = ½" ■ consisting of: ratchet wheel · pawl · shift lever · screws · ball · compression spring · spring washer · circlip For HAZET torque wrench 5121-2CT · 5122-2CT · 5123-2CT 5121-3CT · 5122-3CT · 5123-3CT 5121-2CLT · 5122-2CLT · 5123-2CLT · 5128-2CLT 5122ST-1 6121CT · 6122CT · 6123CT 6121-1CT · 6122-1CT · 6123-1CT · 6127-1CT · 6128-1CT 6722TAC	6122/9 N	025343
• Replacement set for ratchet wheel 12.5 = ½" ■ consisting of: ratchet wheel · pawl · shift lever · screws · ball · compression spring For torque wrench HAZET 5120-2CT · 5120-3CT	5120/7	235490
• Replacement set for ratchet wheel 12.5 = ½" ■ consisting of: ratchet wheel · pawl · shift lever · screws · ball · compression spring For torque wrench HAZET 5143-3CT	5143/8	237142
• Replacement set for ratchet wheel 20 = ¾" ■ consisting of: ratchet wheel · pawl · shift lever · screws · ball · compression spring For 6150-1CT · 7250-2 sTAC · 7250-5 sTAC	6150/8	151431
• Replacement set for ratchet wheel 6.3 = ¼" ■ consisting of: ratchet wheel · pawl · shift lever · screws · ball · compression spring For HAZET torque wrench 5107-2CT · 5107-3CT · 5108-2CT · 5108-3CT 6106-1CT · 6108-1CT · 6109-1CT · 6109-2CT · 6401-1	6401/7	111169

Spare parts (E)	HAZET No.	EAN-No. 4000896+
For torque wrenches		
• Replacement set for ratchet wheel 6.3 = ¼" ■ consisting of: ratchet wheel with safety lock · pawl · shift lever · screws · ball · compression spring For 6401-1S as well as for retrofitting insert reversible ratchets 5107-2CT · 5107-3CT · 5108-2CT · 5108-3CT 6106-1CT · 6108-1CT · 6109-2CT	6401-1S/7	111152
• Replacement set for ratchet wheel 12.5 = ½" ■ consisting of: ratchet wheel · pawl · shift lever · screws · ball · compression spring · spring washer · circlip For 6403-1 · 6404-1	6403-1/9	070749
• Replacement set for ratchet wheel 12.5 = ½" ■ consisting of: ratchet wheel with safety lock · pawl · shift lever · screws · ball · compression spring · spring washer · circlip For 6403-1S · 6404-1S	6403-1S/9	070817
• Replacement set for shift lever consisting of: shift lever · screws · ball · compression spring For HAZET reversible ratchet 1016 · 1016/2 For HAZET torque wrench 5143-3CT · 5145-3CT · 6132-1CT · 6143CT · 6143-1CT · 6144CT · 6144-1CT · 6145CT · 6145-1CT · 6146-1CT	1016/6	001972
• Replacement set for shift lever consisting of: shift lever · screws · ball · compression spring For HAZET reversible ratchet 1116 For HAZET torque wrench 6150-1CT · 6160-1CT · 6170-1CT · 7250-2 sTAC · 7250-5 sTAC	1116/6	003228
• Replacement set for shift lever consisting of: shift lever · screws · ball · compression spring · pawl For HAZET reversible ratchet 8816G · 8816GK · 8816P · 8816S · 8816ST 916K · 2264-1 For HAZET torque wrench 5110-2CT · 5120-2CT · 5110-3CT · 5111-3CT · 5120-3CT 6110CT · 6110-1CT · 6111-1CT 6114-1CT · 6115-1CT 6402-1 · 6402-1S · 6408-1	8816 P/6	144617
• Replacement set for shift lever consisting of: shift lever · screws · ball · compression spring For HAZET torque wrench 5107-2CT · 5107-3CT · 5108-2CT · 5108-3CT 6106-1CT · 6108-1CT · 6109-1CT · 6109-2CT · 6401-1 · 6401-1S · 6408	6401-1/6	146048
• Replacement set for shift lever consisting of: shift lever · screws · ball · compression spring · spring washer and circlip For HAZET insert reversible ratchet 6403-1 · 6403-1S · 6404-1 · 6404-1S	6403-1/7	070756
• Replacement set for shift lever consisting of: shift lever · screws · ball · compression spring · spring washer · circlip For HAZET torque wrench 5121-2CLT · 5121-2CT · 5121-3CT 5122-2CLT · 5122-2CT · 5122-3CT · 5122ST-1 5123-2CLT · 5123-2CT · 5123-3CT · 5128-2CLT 6121-1CT · 6121CT · 6122-1CT · 6122CT · 6123-1CT · 6123CT · 6127-1CT · 6128-1CT · 6722TAC	6122/7	025329
• Reversible ratchet with screw complete replaceable: ■ 20 = ¾" model year → End 2004 For HAZET torque wrench 6132-1CT · 6143CT · 6143-1CT 6144CT · 6144-1CT 6145CT · 6145-1CT · 6146-1CT	6143-01	111190



Spare parts (E)	HAZET No.	EAN-No. 4000896+
For torque wrenches <ul style="list-style-type: none"> • Reversible ratchet with screw complete replaceable: ■ 20 = 3/4" model year 2005 → For HAZET torque wrench 5145-3CT 6132-1CT · 6144CT · 6144-1CT 6145CT · 6145-1CT · 6146-1CT 	6145-01	111206
<ul style="list-style-type: none"> • Replacement set for visual signal transmitter consisting of: red button · compression spring · housing · black · pin · screw For HAZET torque wrench 6021-1CT · 6022-1CT · 6023-1CT 6110CT · 6110-1CT · 6111-1CT 6114-1CT · 6115-1CT · 6121CT · 6121-1CT · 6122CT · 6122-1CT · 6123CT · 6123-1CT · 6127-1CT · 6128-1CT · 6291-1CT · 6291-2CT · 6290-1CT · 6291CT · 6292-1CT · 6293-1CT 	6122-29	025305
Safe box for safe storage of torque wrenches Up to size BX 8 with display window For HAZET torque wrench 5107-2CT · 5107-3CT · 5108-2CT · 5108-3CT · 5110-1CT · 5110-2CT · 5110-3CT · 5120-2CT · 5120-3CT · 6110-1CT · 6110-1CT (CAL) · 6114-1CT · 6290-1CT · 6290-1CT (CAL)	6060 BX-2	024629
Safe box for HAZET torque wrench 5121-1CT · 5121-2CLT · 5121-3CT · 6111-1CT · 6111-1CT (CAL) · 6115-1CT · 6121-1CT · 6121-1CT (CAL) · 6291-1CT · 6291-1CT (CAL) · 6291-2CT · 6291-2CT (CAL)	6060 BX-4	024636
Safe Box for HAZET torque wrench 5122-1CT · 5122-2CLT · 5122-2CLT-PD · 5122-2CT/5 · 5122-3CT · 6122-1CT · 6122-1CT (CAL) · 6127-1CT · 6292-1CT · 6292-1CT (CAL)	6060 BX-6	024643

Spare parts (E)	HAZET No.	EAN-No. 4000896+
For torque wrenches Safe box for HAZET torque wrench 5123-1CT · 5123-2CLT · 5123-3CT · 5128-2CLT · 6123-1CT · 6123-1CT (CAL) · 6128-1CT · 6293-1CT · 6293-1CT (CAL)	6060 BX-8	102907
For pneumatic tools Replacement grinding disc (6 holes) For Orbital Sander 9033-1 <ul style="list-style-type: none"> • Medium hard • With hook and loop fastener • Ø 150 mm with 5/16" threaded mount 	9033-010	139378
Abrasive belts For belt sander 9033N-4 330 x 10 mm. Pack contents 10 pieces. Grain size 80	9033-480/10	139101
Grain size 100	9033-4100/10	139118
Grain size 120	9033-4120/10	139125
Grinding pads For orbital sander 9033-1 and -2 6 holes For metalworking. Ø 150 mm. Pack contents 10 pieces Grain size 80	9033-180/10	139330
Grain size 100	9033-1100/10	139347
Grain size 120	9033-1120/10	139354
Grain size 150	9033-1150/10	139361
<ul style="list-style-type: none"> • Spare needles For needle scaler 9035-5 19 needles, Ø 3 mm 	9035-050	139385
<ul style="list-style-type: none"> • Replacement set · for 9036-5 upper and lower cutter including spacer plate and screw 	9036-05/9	142569



Information

Components and spare parts



Boxes, empty

without plastic inserts, order separately

Suitable for assortment	Box size outside mm	HAZET No.	FAN-No. 4000896+
Tool box, empty made of metal For HAZET socket set 888AZN · 888N · 888ZN · 1000 · 1000AZ · 1000Z · 1002 · 1002Z · 1530A/38 · 1530M/49 · 1900/6 · 5292-1CT/20 · 6292-1CT/20-6292-1CT/28	578 x 235 x 88	1000 KL	001200

Suitable for assortment	Box size outside mm	HAZET No.	FAN-No. 4000896+
Box, empty made of metal For HAZET socket set 1100Z	759 x 305 x 115	1100 KL	157419
Case · empty, with insert For 4800/9		4800/9 KL	049820
Case · empty, For 4904/6		4904 KL	237128

2-component soft foam inserts

Suitable for assortment	HAZET No.	FAN-No. 4000896+
163-30/25	163-30 L	118595
163-31/27	163-31 L	118625
163-53/75	163-53 L	122509
163-55/15	163-55 L	122523
163-57/56	163-57 L	122752
163-58/27	163-58 L	122769
163-60/22	163-60 L	122776
163-95/8	163-95 L	145966
163-96/3	163-96 L	145973
163-97/6 · 606N/6	163-97 L	145980
163-98/17	163-98 L	145997
163-99/18	163-99 L	146000
163-100/13	163-100 L	146017
163-102/27	163-102 L	146031
163-118/57	163-118 L	153480
163-119/23	163-119 L	153503
163-120/24	163-120 L	153565
163-121/4	163-121 L	153558
163-122/3	163-122 L	153527
163-124/4	163-124 L	153596
163-131/8	163-131 L	153619
163-138/77	163-138 L	151516
163-139/90	163-139 L	151523
163-140/33	163-140 L	151837
163-141/31	163-141 L	151844
163-143/18	163-143 L	151868
163-181/17 · 880/17	163-181 L	161492
163-182/9	163-182 L	161508
163-184/6	163-184 L	161515
163-185/5	163-185 L	161522
163-186/16	163-186 L	162338
163-191/18 · 932/18	163-191 L	162543
163-192/24	163-192 L	162550
163-211/20	163-211 L	164691
163-215/5 · 986/5	163-215 L	168132
163-217/6 · 958N/6	163-217 L	168156

Suitable for assortment	HAZET No.	FAN-No. 4000896+
1557/10	163-218 L	168163
163-220/13 · 986/13	163-220 L	168200
163-224/57	163-224 L	176328
163-226/4	163-226 L	178025
163-227/3	163-227 L	178131
163-229/7	163-229 L	178179
163-243/7	163-243 L	178315
163-245/12	163-245 L	178308
163-251/14	163-251 L	178254
163-252/9	163-252 L	178247
163-257/4	163-257 L	179336
163-259/14	163-259 L	179541
163-264/5	163-264 L	180646
163-265/6	163-265 L	180653
163-269/3	163-269 L	180806
163-270/9 · 986/9	163-270 L	181049
163-271/9 · 992/9	163-271 L	181032
163-292/8	163-292 L	186365
163-296/7	163-296 L	186693
163-297/26	163-297 L	186273
163-299/8	163-299 L	186747
163-302/6 · 8801/6	163-302 L	186594
4760-M8 x 1/9	163-321 L	191963
4760-M10 x 1/9	163-323 L	192076
4760/6	163-325 L	192182
4797/10	163-326 L	191741
2272/23N	163-333 L	192588
880N-1	163-334 L	193431
880ZN-1	163-335 L	193424
849	163-336 L	195404
854	163-337 L	194261
854-1	163-338 L	194469
854T	163-339 L	194452
4910/13	163-340 L	194445
2200/36	163-341 L	194339
900 · 900Z	163-342 L	194438

Suitable for assortment	HAZET No.	FAN-No. 4000896+
1557/32	163-346 L	194896
844/5	163-347 L	194889
1557/21	163-348 L	194391
882-1	163-349 L	194384
853-1	163-350 L	194872
882	163-351 L	194377
880-2	163-353 L	194360
855-1	163-354 L	194353
1557/58	163-356 L	194322
900AZ	163-357 L	194315
906	163-358 L	194308
954N	163-359 L	194292
1557/9	163-360 L	194285
986/9N	163-361 L	193844
163-366/18	163-366 L	197071
163-367/31	163-367 L	197293
163-369/104	163-369 L	197309
163-370/9	163-370 L	197286
163-371/7	163-371 L	197279
163-372/25	163-372 L	197262
163-373/39	163-373 L	197248
163-374/27	163-374 L	197231
163-375/5	163-375 L	197347
163-377/11	163-377 L	197361
163-379/38	163-379 L	197354
163-380/4	163-380 L	197255
163-382/3	163-382 L	197125
863 MBIT/33	163-384 L	197392
163-385/12 · 606N/12	163-385 L	197101
163-406/20	163-406 L	200009
163-407/35	163-407 L	200016
163-587/35 · 1557/35	163-587 L	239870
900SZ 6/11	163-588 L	241781



Equivalent standard bolt diameters

German, American, British, Norwegian, French and Swedish dimensions for wrenches
(Only sizes printed in the dark column can be ordered)

Metric dimensions											
Wrench size and nominal size mm	Thread diameter										
	DIN ISO 272						Swedish dimensions SMS				
	normal hexagon		large hexagon		with flange		Norwegian dimensions	French dimensions	Metric sizes		Whitworth
	Bolt	Nut	Bolt	Nut	small 1414	large 1412			small 1415	large 1413	
3											
3.2	1.6										
3.5											
4	2				1.7	2.5	2.3				
4.5					2		2.6				
5	2.5				2.3	3	3				
5.5	3				2.6						
6					3	3.5	3.5	3			
7	4		5		3.5	4.4.5	4	3.5			
8	5		6	5	4	5	5	4			
9					5	5.5	5				
10	6		8	6		6	6				
11	7				6	7	7	6			
12						7	8				
13	8		10	8					5/16	1/4	
14					8	8		8			
15			12	10			10		3/8	5/16	
16	10					9					
17					9	10	10	10			
18	12		14	12			12		7/16	3/8	
19					11	11					
20											
20.8	Spark Plugs M 14										
21	14	12	16	14		12	14		1/2	7/16	
22					12	14		12	14		
23						14				1/2	
24	16	14		16			16		5/8		
25											
26	Spark Plugs M 18										
27	18	16	20		16		18	16			
28									3/4	5/8	
29						18					
30	20	18		20			20				
32					18	20	22	18	20		
33									7/8	3/4	
34	22	20					24				

American dimensions							
Wrench size and nominal size	Thread diameter						
	Wrench size and nominal size		Bolts and nuts according to SAE	USS		Americ. Stand.	
	Inch	mm		Screws & nuts	Head screws	Screws & nuts	Head screws
1/8	3.175						
5/32	3.97				0	1	
3/16	4.76				2	3	
13/64	5.16						
7/32	5.56						
15/64	5.95						
1/4	6.35					4	
17/64	6.75						
9/32	7.14						
19/64	7.54						
5/16	7.94		1/8	1/8	5	6	
11/32	8.73					8	
3/8	9.52			3/16	10		
13/32	10.32						
7/16	11.11	1/4		1/4	12	14	1/4
15/32	11.90						
1/2	12.70	5/16	1/4	5/16		5/16	
9/16	14.29	3/8		3/8	5/16	3/8	
19/32	15.08		5/16				
5/8	15.88	7/16		7/16	3/8	7/16	
11/16	17.46		3/8				
3/4	19.05	1/2		1/2	7/16	1/2	
25/32	19.84		7/16				
13/16	20.64			9/16	1/2	9/16	
7/8	22.22	9/16	1/2	5/8	9/16	5/8	
15/16	23.81	5/8					
31/32	24.61		9/16				
1	25.40	11/16		3/4	5/8	3/4	
1.1/16	26.99	3/4	5/8				
1.1/8	28.57			7/8	3/4	7/8	
1.3/16	30.16						
1.1/4	31.75	7/8	3/4	1			
1.5/16	33.34				7/8	1	

British dimensions					
Nominal size Thread inches	Wrench size		Wrench size		
	BSW Large Hex BS 192	BSF and BSW small 6-point BS 1083	BA	Wrench size	
				Inch	mm
		10	.117	2.97	
		9	.131	3.33	
		8	.152	3.86	
		7	.172	4.37	
		6	.193	4.90	
		5	.220	5.59	
		4	.248	6.30	
1/16 = 3/32			.256	6.50	
		3	.282	7.16	
3/32 = 1/8			.297	7.54	
		2	.324	8.23	
1/8 = 3/16			.340	8.64	
		1	.365	9.27	
		0	.412	10.49	
3/16 = 1/4			.445	11.30	
1/4 = 5/16			.525	13.33	
5/16 = 3/8			.600	15.24	
3/8 = 7/16			.710	18.03	
7/16 = 1/2			.820	20.83	
1/2 = 9/16			.920	23.34	
9/16 = 5/8			1.010	25.65	
5/8 = 11/16			1.100	27.94	
11/16 = 3/4			1.200	30.48	
3/4 = 7/8			1.300	33.02	



Information

Equivalent standard bolt diameters



Equivalent standard bolt diameters

German, American, British, Norwegian, French and Swedish dimensions for wrenches
(Only sizes printed in the dark column can be ordered)

Metric dimensions											
Wrench size and nominal size mm	Thread diameter										
	DIN ISO 272					Norwegian dimensions	French dimensions	Swedish dimensions SMS			
	normal hexagon	large hexagon	with flange		Metric sizes			Whitworth	small 1414	large 1412	small 1415
			Bolt	Nut							
35						22					
36	24	22			22	24		22	24		
37									1	7/8	
38					24						
41	27	24			27			27			
42					27				1.1/8	1	
46	30	27			30	30		30			
47									1.1/4	1.1/8	
50	33	30			33	33		33			
52									1.3/8	1.1/4	
54					36						
55	36	33			36			36			
56									1.1/2	1.3/8	
58					39						
60	39	36			39			39	1.5/8	1.1/2	
63					42						
65	42	39			42			42	1.3/4	1.5/8	
67					45						
70	45				45			45	1.7/8	1.3/4	
71					48						
75	48				48			48	2	1.7/8	
77					52						
80	52				52			52		2	
82					56						
85	56				56			56		2.1/4	
88					60						
90	60				60			60			
94					64						
95	64				64			64		2.1/2	
100	68				68	68		68			
105	72				72	72		72		2.3/4	
110	76				76	76		76		3	
115	80				80			80			
116					80						
120	85				84			85		3.1/4	
130	90				89			90		3.1/2	
135	95				94			95		3.3/4	
145	100				99			100		4	
150	105				104			105			
155	110				109			110		4.1/4	

American dimensions							
Wrench size and nominal size	Thread diameter						
	Inch	mm	Bolts and nuts according to SAE		USS		Americ. Stand.
			Screws & nuts	Head screws	Screws & nuts	Head screws	
							Americ. Stand.
1.3/8	34.92					1.1/8	
1.7/16	36.51	1	7/8				
1.1/2	38.10					1.1/4	1
1.9/16	39.69						
1.5/8	41.28	1.1/8	1			1.3/8	
1.11/16	42.86						1.1/8
1.3/4	44.45						1.1/4
1.13/16	46.04	1.1/4	1.1/8				
1.7/8	47.63					1.1/4	
2	50.80	1.3/8	1.1/4				
2.1/16	52.39						1.3/8
2.3/16	55.56	1.1/2	1.3/8				1.1/4
2.1/4	57.15						1.1/2
2.3/8	60.32						
2.7/16	61.91						1.5/8
2.9/16	65.09						1.5/8
2.5/8	66.68						1.3/4
2.3/4	69.85						1.3/4
2.13/16	71.44						1.7/8
2.15/16	74.61						1.7/8
3	76.20						2
3.1/8	79.38						2
3.3/8	85.72						2.1/4
3.1/2	88.90						2.1/4
3.3/4	95.25						2.1/2
3.7/8	98.42						2.1/2
4.1/8	104.78						2.3/4
4.1/4	107.95						2.3/4
4.1/2	114.30						3
4.5/8	117.48						3
5	127.00						3.1/4
5.3/8	136.52						3.1/2
5.3/4	146.05						3.3/4
6.1/8	155.57						4

British dimensions				
BSW Large Hex BS 192	Thread inches	BSF and BSW small 6-point BS 1083	Wrench size	
			W	BS
	13/16 = 15/16		1.390	35.31
	7/8 = 1		1.480	37.59
	15/16 = 1.1/16		1.580	40.13
	1 = 1.1/8		1.670	42.42
	1.1/8 = 1.1/4		1.860	47.24
	1.1/4 = 1.3/8		2.050	52.07
	1.3/8 = 1.1/2		2.220	56.39
	1.1/2 = 1.5/8		2.410	61.21
	1.5/8 = 1.3/4		2.580	65.53
	1.3/4 = 2		2.760	70.10
	2 = 2.1/4		3.150	80.01
	2.1/4 = 2.1/2		3.550	90.17
	2.1/2 = 2.3/4		3.890	98.81
	2.3/4 = 3		4.180	106.17
	3 = 3.1/4		4.530	115.06
	3.1/4 = 3.1/2		4.850	123.19
	3.1/2 = 3.3/4		5.180	131.57
	3.3/4 = 4		5.550	140.92



A

Acid tester	431
Ad-Blue filter wrench	485
Adapter (connector)	100, 150–151, 161–162, 176–178, 186, 190–191, 193–194, 226–228, 327, 429–431, 473, 486, 497
Adjustable spanner	123
Adjustable wrench	123
Adjusting and testing devices for torque wrenches	329–331
Air blow and suction gun	372
Air blow gun / pen	368–370
Air inlet nipple / hose connection nipple	376
Air ratchet	334–387
Angle dial, mechanical	328–331
Angle drill	352
Angle grinder	359
Angle scraper	262
Anti-freeze tester	431
Anti-slipping mat	52
Assembly trolley	35–46, 62–67, 70–84
Assistant and accessories	19–115, 122–126, 174–177, 186, 195, 205–208, 210–211, 236, 243, 257, 276, 278–280, 427, 440–447
Assortment	49–50, 58–93, 266, 270–283, 471–472, 474–483, 498–499
Automatic grip pliers	240
Automatic wire stripper	281–282
Axe	247–248

B

Balance weight pliers	467
Ball joint puller	259, 458–461, 491–497
Ball-head extension	151, 162, 177
Ball-head screwdriver	149, 161, 173
Beam puller	259
Belt sander	356
Bending iron	250
Bending iron, bending tool	250
Bits and accessories	143–144, 146, 150, 161–162, 177, 217–228, 310, 322, 326–327, 349, 480–481, 483–484
Blind rivet tool	367, 477
BluGuard club hammer	246
BluGuard hammer	244–250
Blunt scraper	261–262
Bolt extractor	265–267
Borescope technology / service technology	390–407
Box-end wrench	94–95, 123–125, 328, 419, 421, 484
Box-end wrench, striking face pattern	496
Brush / file	260–261, 264, 267, 413, 443, 461–462, 470, 475, 477–478, 491

C

Cable drum	52
Cable release tool	471–472, 498–499
Cable stripper tool	281–282
Camber adjustment tool	456, 460
Cape chisel	248
Car body tools	93, 234, 239–240, 249, 260, 357–359, 364–367, 386, 466, 474–483, 499
Car glass removal tool	482
Car light and circuit tester	469–473
Cardan (universal) hinge	151, 156–157, 162, 165, 167, 177, 186, 190–191, 193–194, 434, 440
Carpet knife	263

C

Cartridge wrench	488–490
Case	88–89
Centre punch	249
Chain tube cutter	264, 432–433
Chisel, drift punch, centre punch	248–250
Circlip / circlip pliers	235–238, 427, 447, 464
Clamp pliers	238–239, 464–465
Clamping pliers	422
Clamping strap / Lashing strap	406
Clic hose clamp pliers	240, 424
Clutch alignment tool	434
Combination pliers	229–243, 280
Combination wrench	94–95, 123–125
Components and spare parts	115, 146, 155, 158, 162, 167, 170, 183, 186, 188, 191–192, 194, 224, 247–248, 256, 319, 326, 442, 480
Connecting pin, safety spring and O-ring	162, 186, 191, 194
Connector (adapter)	100, 150–151, 161–162, 176–178, 186, 190–191, 193–194, 226–228, 327, 429–431, 473, 486, 497
Construction bucket	406
Control cabinet key	406
Cordless tool	382–386, undefined
Creeper	401
Crimping pliers	282
Crowfoot wrench	157, 170
Current / phase tester	209, 280, 469–473
Cutter / drill	260–264, 352–366, 384–385, 442–443, 478–479
Cylinder head tool	172–175, 328–331, 417, 431–432

D

Dashboard protection	483
Decanting / filling pump	404
Diagnostics, testing	209, 268–269, 275, 280, 329–331, 390–407, 427–432, 444–445, 469–473, 483, 485–487
Diagonal cutter	232–233, 280
Die grinder	353–356, 363–364
Digital vernier calliper	269
Door (handle/hinge/panel) tool	480–481
Door panel remover	479–480
Double box-end wrench	95, 126–128, 419, 440–441
Double open-end wrench	94–115, 117–283
Double-pin wrench	411
Drawer inserts / plastic drawer insert	19–115, 122–126, 174–177, 186, 195, 205–208, 210–211, 236, 243, 276, 278–280, 427, 440–447
Drift pin	249–250
Drift punch	249–250
Drill / Cutter	260–264, 352–366, 384–385, 442–443, 478–479
Drilling machine	260–264, 384–385

E

Electronic screwdriver	209
Electronic torque wrench with built-in angle gauge	320–321
End cutting / tower pincers	234
Engine leakage tester	431
Engine oil filling funnel	439
Engine support	409–499
Engine timing tool	412
Engineer's hammer	244–250
Engraving pen	364
Exhaust equipment tool	264, 432–433



Information

Table of contents



E	
Exhaust pipe cutter	264, 432–433
Extension	151, 162, 177–178, 180, 186, 190–191, 193–194, 277–278
Extractor tool range	234, 251–259, 412–413, 420, 423, 432–433, 448–468, 479, 483, 491–497
F	
Feeler gauge	268–269, 275, 469
File / brush	260–261, 264, 267, 413, 443, 461–462, 470, 475, 477–478, 491
Filling / decanting pump	404
Filling funnel	402, 439
Filter-pressure reducer	378
Five-star screwdriver	224
Flange tool	476
Flare nut wrench	128, 157, 170, 328, 419
Flat (round-) nose pliers	233, 281, 482
Flat chisel	248–249, 476
Flexible extension	151, 162
Flexible handle	156, 167
Flexible head wrench	157, 159, 191, 194, 416, 434, 440
Flexible hose clamp	422
Flexible inspection light	396–397
Flexible lamp	396–397
Flexible pick-up tool with claws / magnetic pick-up tool	395
Flexible screwdriver / nut-driver	209
Flexible screwdriver / wrench	209
Folding rule	268
Four-way rim wrench	467, 497
Fuel line pliers	421–422
Funnel	402, 439
G	
Generator tool	473
Gloves	407
Glow plug tool	416, 423
Grease gun	372, 377, 403, 405
Grinding, separation and cutting	260–264, 352–366, 442–443, 478–479
Grip pliers	239–240
H	
Hack saw	262, 364, 386
Hammer	244–250, 478–479
Hand anvil	474–475
Hand pump	404
Hand-held light	396–397
Handle bar	188, 192
Hatchet	247–248
Headlight adjustment tool	481
Heavy-duty combination pliers / diagonal cutter	232, 280
Henn clamp tool	427
HEXAnamic screwdriver	196–228
High-leverage diagonal cutter	233
Hollow scraper	262
Hose clamp pliers / hose clip pliers	240–243, 423–427
Hose connection nipple / air inlet nipple	376
Hose reel	374–375, 379
Hot-air tool	387
I	
Ignition module / coil puller	485

I	
Impact socket and accessories	151, 162, 178–186, 190–191, 193–194, 228, 334–387, 465–466, 483–499
Impact tools	151, 162, 178–186, 190–191, 193–194, 228, 334–387, 465–466, 483–499
Impact wrench	228, 334–387
Impact wrench sockets and accessories	151, 162, 178–186, 190–191, 193–194, 228, 350–351, 382–384, 465–466, 483–499
Injection system tools	149, 226, 241, 411, 419–424, 484–485
Injector tools	420, 423
Insert tool holder and tools	325–328
Inside hexagon screwdriver (sockets)	98–100, 106, 113–114, 143–144, 149, 160–161, 171–175, 189, 210–213, 217–219, 223–224, 226–228, 276–278, 417, 422, 440–447, 457, 463–466, 482
Inside spring vice	455
Inspection, testing	209, 268–269, 275, 280, 329–331, 390–407, 427–432, 444–445, 469–473, 483, 485–487
Insulating mat	282
Internal extractor	258–259, 485
J	
Jack-knife	263, 282
K	
Kneeling mat	401
Knives	263, 282
L	
Lambda probe tool	433
Lamp / light	396–400
Line wrench	128, 157, 170, 328
Lubricator / oil can	378–379, 403
M	
Machinist's vice	406
Magnetic cup	402–405
Magnetic holder	377, 379
Magnetic insert for sockets	149, 158, 170
Magnetic pick-up tool	395
Marking tool	260
Measurement	268–269, 275, 469
Measuring cup	403
Mechanic's creeper	401
Micrometer	269
Mini tool pneumatics	349, 355–356, 361–363
Mobile work bench	47–51, 84–87
Multi sander	357
Multi Table	46
Multifunctional drain pan	402
Multimeter	268, 275, 469
N	
Needle scaler	365
Nibbler	366
Non-contact infrared thermometer	395
Non-rebound hammer	247
Nozzle adjusting tool	483
Nut splitter	267



O

O-ring, safety spring and connecting pin	162, 186, 191, 194
Offset screwdriver	212–213
Oil service tools	402, 419, 435–439, 484–488
Open-end wrench	94–115, 117–283, 327
Optical tester	431
Orbital sander	356

P

Phase tester	209, 280
Pick-up tool with claws	395
Pin wrench	458, 484
Pipe wrench	234–235, 281
Piston ring tools	418
Pitman arm puller	255, 483
Plaster container	406
Plastic / soft-faced hammer	246–247
Plastic drawer insert	90, 94–115, 122–126, 129–186, 194–195, 205–208, 210–211, 217–222, 226–227, 236, 243, 266–267, 276, 278–280, 412, 423, 427, 440–447, 457
Pliers	111, 229–243, 262, 280–282, 412–416, 418–419, 421–427, 447, 463–465, 467–468, 476–477, 480, 482
Pneumatic roller seat	401
Pneumatic tools and accessories	334–387
Pointed pliers	233, 281
Polishing tool	358, 361
Power tool / cordless tool	385–386
Pressure sprayer	405
Probe adapter	393–395
Pry bar	250
Pry bar / tyre lever	250, 444, 467–468, 479
Puller for fans	255
Puller, extractor, forcing screw	258–259, 458–463, 485, 491–497
Pulley tools	411, 473

R

Radio dismantling tool	473
Ratchet	126, 145–146, 154–155, 165–167, 188, 192, 224, 226, 283, 285–331, 334–387, 457
Ratchet box	88–89, 96, 98–106, 113–114, 129–195, 217–219, 226–227, 276, 440–447
Refractometer	431
Reversible ratchet	126, 145–146, 154–155, 165–167, 188, 192, 224, 285–331, 334–387
RIBE-CV tool	105, 175–176, 417
Right-angle grinder	356, 361–363, 385
Riveting tool	367, 477
Roofing hammer	246
Rotary joint	376
Round file	260
Round-nose pliers	281
Rubber hammer	247
Rubber mallet	246–247
Run-flat tyre lever	468

S

Sabre saw	364, 386
Safety at work	401, 407
Safety coupling	376–377
Safety spring, O-ring and connecting pin	162, 186, 191, 194

S

Safety-Insert-System	90, 94–115, 123–126, 160, 164, 173–178, 186, 195, 205–208, 210–211, 236, 243, 266–267, 276, 278–280, 412, 416, 423, 427, 440–447, 457
Saw	262, 364, 386
Scraper	261–262
Screw driving tool (XZN)	98, 100, 103–105, 161, 174–176, 185, 224, 228, 277, 417, 438, 465, 473, 480
Screwdriver	96, 105, 107–108, 110–111, 176, 196–228, 278–280, 322, 480–482
Screwdriver socket and bit	143–147, 150–151, 156, 161–162, 168, 177, 188, 192, 217–228, 277–278, 322, 326–327, 415, 433, 438, 457, 480–481, 483–484
Separation and pulling device	256–257, 459
Service technology / Borescope technology	390–407, 444–445, 469–473
Service trolley Assistant®	35–46, 62–67, 70–84
Shears	262, 280, 282, 476–477
Sheet metal punch	476
Sheet metal tool	93, 234, 239–240, 249, 260, 357–359, 364–367, 474–483
Shock absorber tool	448–468
Single box-end wrench	276, 328, 421, 484
Sledge hammer	246
Slide hammer / sliding hammer	259, 485
Sliding hammer	259, 485
Sliding square, insert square	326–327
Sliding T-handle	147, 156, 168, 188, 192, 210–211, 482
Small hack saw	262
Small open-end wrench	94
Small tube cutter	264
SmartCase	143–144, 218–219, 226–227
SmartHolder	220–222
SmartRail	145, 147–148, 150, 165, 168–169, 171–172, 174, 176, 178, 180–181
Socket (box nut)	147–151, 156–162, 168–176, 178–186, 188–191, 193–194, 228, 277–278, 412, 414–417, 419–422, 433–434, 436, 438–440, 457, 460, 463–466, 481, 483–499
Socket rail / holder	51, 145, 164
Socket set	88–89, 96, 98–107, 113–114, 129–195, 210, 217–219, 226–227, 276, 440–447
Socket wrench set	88–89, 96, 98–104, 106, 113–114, 129–195, 217–219, 226–227, 276, 440–447
Sockets (screwdriver bits) and accessories	143–144, 146, 150, 154, 161–162, 164, 177, 188, 192, 217–228, 310, 322, 325–327, 349, 415–416, 433, 438, 457, 460, 480–481, 483
Soda spray gun	373
Soft foam insert	94–115, 122–125, 129–186, 194–195, 205–206, 217–219, 226–227, 236, 267, 276, 412, 416, 423, 440–447
Spanner socket	147–150, 156–162, 168–176, 178–186, 188–191, 193–194, 228, 277–278, 412, 414–417, 419–422, 434, 436, 438–440, 460, 463–466, 481, 483–499
Spanner socket set	88–89, 96, 98–105, 129–195, 217–219, 226–227
Spark plug tools	154, 158, 170, 234, 264, 269, 412–416
Special bumping mallet	479
Specialty tools for axles	238–239, 250, 395, 458, 460–466, 481, 491–496
Specialty tools for battery service	470
Specialty tools for brakes	128, 189, 237, 249, 261, 264, 440–447, 461–462, 488–491



Information

Table of contents



S

Specialty tools for

- car body repair 93, 234, 239–240, 249, 260, 357–359, 364–367, 386, 466, 474–483, 499
- cooling system 209, 240–243, 373, 422–432, 485–487
- electricians 92, 270–283
- fuel supply 149, 226, 241, 411, 419–424, 484–485
- timing belts 411–412
- tyres 371, 444, 467–468, 497

Spin type speeder 146–147, 156

Spiral hose 374

Splitting tool 247–248

Spray gun / sprayer / spray bottle 372–373, 403–405

Spring strut tool / safety spring vice 448–468

sTAC torque wrench with built-in angle gauge 320–321

Straightedge 269

Strap wrench 418, 437

Striking face pattern (open-end/box-end) 496

Stud bolt extractor 258, 265–266

Stud extractor 265–266

Suction gun 404

Swedish pattern wrench 235

SYSTEM cable release tool 471–472, 498–499

T

T-handle screwdriver 147, 156, 168, 210–211, 480–482

Tape measure 268–269

Taper key extractor 491

Telescopic inspection mirror 395

Telescopic reversible ratchet 166

Telescopic wheel nut wrench 467–468

Tensioning jaw (safety spring vice) 452–454

Thermal camera 390–407

Thread repair 265–267, 416, 423

Tool box / case / cabinet 49–50, 88–90, 98–100, 105–106, 113–114, 129–195, 274–276, 440–447

Tool holder 50–51, 145, 147–148, 150, 164–165, 168–169, 171–172, 174, 176, 178, 180–181, 377, 379, 402–405

Tool set / assortment 49–50, 58–115, 122–195, 205–213, 217–222, 224, 226–227, 236, 238, 243, 249–250, 255–259, 265–266, 270–283, 318–319, 326, 357–358, 395, 416, 422–423, 427, 437, 440–447, 452, 454–458, 460, 463–466, 469–483, 488, 490, 492–495, 497–499

Tool set for silent blocks 462–463

Tool trolley “Assistant” and accessories 19–115, 122–126, 174–176, 195, 205–208, 210–211, 236, 243, 257, 276, 278–280, 427, 440–447

Tool with protective insulation 278–283

Tools for commercial vehicles 189, 191, 420, 436, 438, 459, 483–499

Torque tester 329–331

Torque tools and accessories 188, 192, 283, 285–331

Torque wrench with built-in angle gauge 320–321

TORX® screw driving tool 88–89, 96, 99–110, 128–151, 153, 159, 161–163, 171, 175–176, 184, 186, 189, 191, 194–195, 204–205, 207–211, 213, 217–219, 223, 226–228, 277, 279, 412, 417, 419–422, 433–434, 457–458, 473, 480–481, 483–499

Tower pincers 234

trInamic / TRInamicULTRA screwdriver 205, 207–208

T

Tube cutter 263

Tube deburring tool / tube cutter 263–264, 442–443

Tube flaring tool 441–442

Tube flaring tools 441

Turbocharger tool 420

Twin Turbo impact wrench 345–347

Twist drill bits 260–264, 479

U

Universal joint 151, 156–157, 162, 165, 167, 177, 186, 190–191, 193–194, 434, 440

Universal knife / shear 262–263, 282

Universal pliers 234–235, 281

Universal puller 255–256

Universal spring vice 448–468

Universal strap wrench 437

V

V-(ribbed) belt pulley tool 411, 473

Valve adjusting tools 418–419

Vernier calliper 269, 444–445

Vice 406

Video borescope 393–395

W

Wedge 479

Welding tools 239–240

Wheel hub / wheel bearing tools 456, 460–463, 466, 491–496

Wheel wrench / nuts 179–184, 190, 193, 466–468, 497–498

Window pane holder 52

Wire brush 264, 413, 443

Wire stripping tools 281–282

Wobble extension 151, 162, 177

Wood axe 247–248

Work bench 47–51, 86–87

Working light 396–400

X

XZN screw driving tools 98, 100, 103–105, 161, 174–176, 185, 224, 228, 277, 417, 438, 465, 473, 480





HAZET No.	Page	HAZET No.	Page	HAZET No.	Page	HAZET No.	Page	HAZET No.	Page
0-7	91	450N	122	802	204	856	144	906	163
0-20	92, 273	450N	94, 122	802-PH	204	858	150	914	167
0-111	50	450NA	122	802-PZ	204	863	145	915	168
0-179	273			802	107, 205	863-Bit	146, 224	916	165-167
0-1900	93, 474	600LG	124	802-TH	204	865	147	917	177
0-2500	68-69	600LG	125	802TH	108, 205	866	147	917/918KV	278
		600N	123	803	207	866BH	226	918	177
111	50	600N	94, 123-124	803-PH	208	866U	146	919	177
111	49	600NA	124	803-PZ	208	867	151	920	177
111L	49	603	125	803	107-108, 208	868	151	932	164
112	50	603	95, 125	803-T	208	869	151	953HP	163
112	50	606	126	803LG	208	870	151	954N	163
130	49	606	95, 126	803LG-PH	208	871	151	958	176
150	274	609	128	803LG-T	208	880	156	958-28	178
150	274-275	610N	126	804VDE	278	880	152	958N	177
161-Z	52	610N	95, 127	805	209	880-Z	154	960MGT	149
161N-Z	52	612	128	805	108, 209	880A	157		158, 170
161T	52-53	612N	128	805C	209	880AKF	158, 414	980	171
162C-Z	53-54	615S	419	808	209	880AMGT	158, 414	985	171
163	115	630	127	810	206	880AZ	157	985	171
163	94, 96-114, 176-177, 195, 280, 440	630	95, 127-128	810-PH	206	880E	159	985S	184
		630A	128	810-PZ	206	880G	157	985S	184
		630KV	276	810	207	880G-E	159	986	172
165	90	630KV	114, 276	810-T	207	880G-E	159	986	99-100, 173-174
166C	44	650	467	810BH	225	880G	154	986A	173
166N	44	650K	468	810BHK	225	880GZ	157, 434	986KK	173
167-3	45	650RF	468	810BMK	225	880KF	158, 414	986L	172
167-3S	46	652	468	810PZ	207	880KV	114, 276	986LGKV	278
167-Z	54	653	468	810R	225	880LG	156	986SL	173, 417
167T	46	654	468	810SPC	225	880LG-E	159	990	174, 417
173-Z	52, 54	665	467	810TSPC	110, 207	880LG-E	159	990	100, 175
177	35, 59	666	468	810U	205	880MGT	158, 414	990LG	174, 417, 465
177	59			810U-PH	206	880N	152	990S	185
177W	47, 85	705	467	810U	110, 206	880S-Z	162	990S	185
177W	85	715	497	810VDE	279	880SE	162	990SLG	174, 417
177W-Z	54	720	497	810VDE-PH	279	880TZ	157	991	175, 417
178N	37, 60	730	248	810VDE	115, 279	880TZ	98, 154	992	175
178N	60	730HS-Z	248	810VDE-T	279	880Z	156	992	175
179-Z	55	731	248	821	262	880ZN	153	992H	175
179N	39, 63, 65, 67, 71, 73	740	248	822	262	882	152-153	992LG	176, 417
179N	71	741	248	823	262	885N	153	992SLG	176, 417
179N-Z	53-57, 406	745	249	824	261	888ZN	153	992T	176
179NW	48, 87	746	249	824-6	261			992T	106, 175
179NW	87	747	249	825	262	900	168	995S	186
179NW-Z	56-57	748A	249	828	210, 482	900	163, 171		
179NXL	41, 75, 77, 79	748B	249	828	110, 211	900AKF	170, 414	1000	188
179NXL	75, 77, 79	748C	249	828-T	210	900AMGT	170, 414	1000	100, 187
179NXL-Z	53, 56	748LGB	249	828LG	210, 482	900AZ	169	1000AZ	189
179NXXL	42, 81	750	249	828LG-T	211, 480-481	900AZ	164	1000AZ	187
179NXXL	81	751	249			900E	171	1000S	190
179NXXL-Z	53, 56	751HS	250	829KK	211	900HL	164	1000S-Z	191
179NXXLD	43, 84	751KHS	250	829KKT	211	900KF	170, 414	1000SLG	190
179NXXLD-Z	53, 57, 406	751LHS	250	830	209, 280	900KV	278	1000Z	189
		752	240	840	265	900KV	115, 278	1002	187
179W-Z	55	753	239	840	265	900LG	168	1002	187
180-Z	52, 54-55, 57	755	240	841	265	900LG	99	1002Z	187
190	88	757	239	842AG	266	900MGT	170, 414	1002Z	187
190L	89-90, 386	758	239	842AIG	266	900S	178	1003S	191, 497
190L	88	759N-VDE	281	842N	266	900S-E	184	1004S	190, 498
195	401	760	234	844	265	900S-Z	105, 178	1005S	191
196VDE	282	760N	234	844	266	900S	186	1006S	191
197	402, 406	772	467	847	267	900SK	179	1007S	191
198	403	772	497	848Z	157, 170	900SK	178-179	1010	189
198-1	402	790	418	849	267	900SK	178-179	1012	189
198-10	439	791	418-419	849AG	267	900SLG	179-180	1014	188
198	439	792	418	849IG	267	900SR	165	1015	188
199	403, 405	794	418	850	147	900SZ	183, 465	1015	188
		794U	418	850A	147	900SZ	183, 466	1016	188
		795	418	850E	148	900TZ	169	1016	188
220	411	796	447	850EHL	145	900Z	169	1017	190
279	123	797	447	850LG	148	900Z	164	1018	190
		798	240-243, 423-427	850LG-GE	148, 433	901SLG	180	1021	190
426	209	798	110, 243, 427	850SR	145	902SLG	181	1058	190
426	106	799	479-480	850TZ	148	903SLG	181		
428	210	801NK	205	853	142	903SLG	181	1100S	193
428	106, 210	801NK-PH	205	854	142	903SPC	181	1100S-Z	194
428LG	210			854T	142	904SLG	182	1100SLG	193
450KV	275			855	143	905	164	1100Z	193
450KV	114, 276					905SLG	182-183	1100Z	192



Information

Numerical index



HAZET No.	Page	HAZET No.	Page	HAZET No.	Page	HAZET No.	Page	HAZET No.	Page	HAZET No.	Page
1905.	474	2145.	269	2304.	227, 322	4672.	472	6001	322	9000-040	355, 376
1911.	474	2147.	269	2304	220-222	4673.	472	9000-041	376	9000-050-080	377
1917N	474	2147MS	269	2311.	227	4675.	472, 499	6200-1CT.	315-317	9005S	180, 186
1918N	474	2150.	260	2505.	415	4680.	433	6290	318	9006S	186
1919N	475	2151.	395	2517.	420	4682.	264, 432-433	6292	318	900SLG6	179, 497
1920N	475	2152.	268, 275, 469	2521S	466	4684.	432	6300.	323-324	900SZ6	183-184
1921.	475	2152N	469	2528.	438	4685-1	491	6396.	325	9007S	186
1922.	475	2153.	469	2530.	416	4685-2	491	6397.	325	9011M	343
1923.	475	2154.	268-269	2534-1	481	4685-4	492	6399.	324	9012.	345
1927.	475	2154N	268	2540.	411	4760.	416	6400	318	9012-Z	343-345, 377
1928K	475	2155.	269	2561.	420	4766.	158, 415	6401.	325	9012ATT	344
1929-1	475	2155N	269	2567.	438	4793	432	6401-1	325	9012EL-SPC	345
1930.	475	2156.	282	2579.	417	4795.	431	6401S	325	9012M	343-344
1930-1	475	2156VDE	282	2582.	444	4797.	259, 485	6408.	326	9012PPT	344
1931.	475	2157.	263	2583.	460	4797	423	6413.	326	9012TT	345
1932.	476	2158.	262, 282	2584-1	173, 422	4800.	428-431, 486	6414.	327	9013M	346
1934.	477-478	2160.	403	2584-8	160, 440	4800	428, 485-486	6420.	327	9013TT	346-347
1934N	477	2160-1	403	2584LG-1	160, 463	4801.	427	6423.	327	9014P	348
1935-1938K	478	2162.	377, 403-405	2587.	411	4801	427	6430.	327	9014TT	347
1940-1943	478	2163.	404	2588	412	4802.	487	6450C	327	9020.	349
1944-1950	478	2164	250	2592.	473	4803.	432	6450D	327	9021.	349-350
1951.	247	2165.	250	2593.	458	4810C	431	6602.	325	9022.	350-351
1952.	247	2166.	250	2597.	480-481	4812.	393-395	6606D	328	9023M	349
1953.	246	2168.	484-485	2597-Z	480	4812	395	6612C	328	9030.	352
1953-Z	247	2168-2	419	2598.	481	4850.	483	6630C	328	9032.	353-356
1959.	479	2169.	435-437, 487	2710.	458	4852.	482	6630D	328	9032-Z	353-356, 363
1960.	476	2169	437	2730.	444	4852	482-483	6690.	328	9033.	356-362
1961.	476-477	2170.	437	2751.	174, 417, 420	4900.	452-454, 456	7000STAC	321	9033-2-Z	356
1963.	477	2171.	438, 487-488	2756.	434	4900	452, 454	7034P	364	9033-4-Z	356
1964.	476	2172.	438	2760.	438	4902	455	9035	364-365	9034P	364
1965.	479	2174.	434	2780.	458	4903.	456	9035-5-Z	365	9035H	365
1965-22	479	2175N	57, 406	2784.	160, 189, 440, 488	4903	456	9035V	366	9036.	366
1965	479	2175N-Z	57, 406	2784	488	4904	455	9036	366	903SLG6	182
1967.	260, 478-479	2180.	263	2784S	499	4910.	455, 457	8500.	150	9037.	367
1967-Z	260	2181.	264	2784SR	499	4910	457	8501.	149	9040.	368-370, 374-375
1969.	460	2183.	235	2784SLG	499	4912.	455-456, 460	8501KK	149	9040D	379
1975.	395	2191.	441-442	2788.	412	4912	460	8502.	149	9040LG	370
1976.	395	2191	441	2788SR	412	4915	458	8502LGTH.	150, 419	9041.	371
1977.	395	2193.	442-443	2797.	481	4925	462-463	8503.	150	9042.	372
1979.	396-400	2193	442	2797-2	481	4929	463	8506.	150	9042N	372
1980N	262	2195.	488	2849.	484	4933	460	8507.	150	9043.	372
1981.	262	2200	143-144, 217-219	2850.	191, 483	4935	466	8508S	151	9045.	373
1981-Z	262	2204ELG	224	2871.	484, 488	4937.	492-496	8801.	160	9048P	373
1987.	407	2204N	223	2872.	489	4937	492-495	8801A	160	9070.	378-379
1987-5	407	2204SLG	223	2872FS	489	4954.	444	8801K	160	9212-1000	383
1988.	406	2208ELG	222	2872SZ	489	4956.	444-445	8801KV	277	9212-3	383
1990.	387	2210.	227	2901G	440	4960	461	8802KV	277	9212M	382
1990	387	2211.	224	2991.	419	4960F	461	8802KV-LG	277	9212SPC	382
1991.	395	2212.	228	3047.	183, 465	4960N	462	8802T	154	9212SPC	382
1992.	393	2215ELG	222	3702.	439	4960R	461	8803.	161	9213-1000	384
2025X	51	2215N	222	3703.	439	4960V	462	8806.	161	9230	385
2100.	212, 267	2215SLG	222	4501.	421-422	4961N	491	8807S	162	9230B	384
2100	212	2216ELG	223	4550.	421, 484	4963.	441	8808.	161	9233	385
2100A	212	2216SLG	222	4555.	421	4964.	441	8808	98	9234.	386
2105ALG	213	2217.	227	4556.	421	4968.	261, 264, 441, 443, 446	8808	161	9400.	379
2105LG	212	2218.	228	4558.	484	4969.	489	8808LG	161		
2105LG	213	2223ELG	223	4560.	421	4969	446	8808LGKV	277		
2115.	213	2223LG	223, 483	4561.	421	4970.	446-447	8808S	162, 228		
2115	213	2223N	223	4562.	427	4970	446	8812U	156		
2116LG	213	2223SLG	223	4590.	422	4971.	447, 490	8814.	156		
2119.	260	2224.	228	4590	422	4972.	490	8815.	156		
2120.	260	2224SLG	228	4590	422	4972	490	8816.	154-155		
2122.	261	2225.	224	4590	422	5000-3CT.	309	8820.	162		
2123.	261	2238.	227	4591.	422	5000B-3CT.	310	8821.	162		
2126.	267	2239.	226-227	4617.	406	5000CLT	311	8821KV	277		
2128.	260	2240N	217	4641	473	5000KV	283	8822.	162		
2130.	264	2250.	150, 161, 177, 227-228, 267	4641	473	5200-3CT.	310	8830.	162		
2131.	264, 413	2255.	226	4650.	470	6000-1CT.	311-313	8858.	161		
2132.	247	2265.	226	4655.	473	6000-1CT-US.	314				
2133.	247	2272.	228	4656.	282	6000CT	322				
2134.	248	2272	227	4658.	282						
2135.	248	2300	220	4670	471, 498-499						
2138.	246										
2139.	246										
2140.	246										
2142.	246										
2143.	247										



A. General Provisions

I. Validity

1. All offers, sales, deliveries and services of HAZET-WERK Hermann Zerver GmbH & Co. KG (hereinafter referred to as "HAZET") are based exclusively on the following general terms and conditions (hereinafter referred to as "Terms and Conditions"). Conflicting terms and conditions of the Purchaser pursuant to §§ 305 ff. of the German Civil Code („BGB“), in particular purchasing conditions of the Purchaser do not apply on any account, nor also if HAZET does not contradict them after receipt.
2. The following Terms and Conditions are an integral part of all contracts concluded with HAZET's contractual partners for its deliveries and services. Agreement is given to the Terms and Conditions when the order is placed or the delivery accepted. The Terms and Conditions do not apply to relations with consumers in the sense of Section 13, BGB.
3. Modifications and/or supplements to these Terms and Conditions are only valid if written agreement thereto has been given. The written form pursuant to these Terms and Conditions also comprises the text form.
4. "Purchaser" refers to the contractual partner irrespective of the nature of the contract.
5. To the extent that nothing else is agreed in these Terms and Conditions, the determining factor for the interpretation of the various terms of delivery is the INCOTERMS® 2020.

II. Offers and Conclusion of Contracts

1. HAZET offers are subject to confirmation and without obligation. Requests can be accepted by HAZET within thirty (30) days. The Purchaser is thus bound to its request for at least this period. A request is deemed as accepted when HAZET has confirmed it in writing to the Purchaser. The delivery and invoice are both deemed as confirmation of an order.
2. HAZET reserves the right to ownership and the copyright to the documentation pertaining to the offer (illustrations, drawings, descriptions and the like); third parties may only obtain access to the documentation if it is intended to be circulated. Otherwise it should be returned to HAZET upon request.
3. The information, drawings, illustrations, technical data, weights, measurements and descriptions of services included in brochures, catalogues, circulars, advertisements, price lists or in the documentation pertaining to the offer are only intended to convey a general idea of the products described. They do not include any explanations, other assurances or guarantees and shall not become an integral part of the contract. Common practice deviations, or modifications which are made due to legal regulations or as technical improvements, are permitted insofar as they do not adversely affect the contractually intended use.

III. Prices

1. Prices are net cash plus VAT of the respective statutory amount as well as freight ex works or warehouse and do not include outer packaging, postage and insurance.
2. If the Purchaser's value of consignment exceeds a value of 750 euros net, i.e. excluding VAT, the delivery shall be made with carriage paid to the Purchaser's address within Germany and without charging for the standard trade packaging. This applies exclusively to deliveries to the Purchaser's address. For different delivery addresses, the prices listed under Point III shall apply. 1.

IV. Payment Conditions

1. Unless otherwise agreed in writing or indicated on the invoice, the invoices are due for full payment in euros immediately, irrespective of any delays in delivery for which HAZET is responsible. An agreed discount always refers only to the invoice value excluding freight. Unless otherwise agreed, discount periods begin from the invoice date.
2. The receipt by HAZET shall determine the timeliness of payment.
3. As long as purchase price receivables based on older invoices which are due for payment are still unsettled, it is not permitted to make a cash discount deduction in any case.
4. If special agreements are the basis, HAZET shall only accept fulfillment cheques and bills of exchange which are re-discountable with the Bundesbank (German Central Bank).
5. Bills of exchange or cheques shall be credited subject to receipt with the value of the date – and only apply as payment on the day – when HAZET can ultimately dispose over the proceeds. The Purchaser shall bear all costs and disbursements which result from this.
6. If the Purchaser falls into payment arrears, the Purchaser shall pay interest on the respective claim at a rate of 9 percentage points above the basic interest rate pursuant to Section 247 of the BGB (Bürgerliches Gesetzbuch; German Civil Code). The right to assert further claims due to the delay remains unaffected.
7. If it becomes discernible after conclusion of the contract that the payment claim by HAZET is jeopardised by inadequate performance on the part of the Purchaser or if other circumstances occur, which are indicative of a significant deterioration in his performance, HAZET can refuse agreed advance performances as well as exercise the rights from § 321 BGB. This also applies insofar as HAZET's duty of performance is not yet due. In such cases, HAZET can furthermore call in claims from the current business relationship with the Purchaser. Inadequate performance on the part of the Purchaser is also deemed to be case if the Purchaser is at least three weeks in payment arrears with a considerable amount, furthermore a considerable downgrading of the limit available to him for HAZET's goods credit insurance.
8. The retention of payments or offsetting with the Purchaser's counterclaims is only permitted if the counterclaims are undisputed or have become legally binding, or they would entitle the Purchaser to refuse his performance pursuant to § 320 BGB.
9. Claims against HAZET are only assignable with HAZET's written consent.

V. Securities / Retention of title

1. The ownership of the delivered goods („reserved property“ in this section A. V.) is transferred under the condition precedent of full payment of the purchase price. Furthermore, HAZET shall retain ownership of all delivered goods until the fulfillment of all claims by HAZET, in particular also the respective outstanding balance claims, which are due to HAZET as part of the business relationship (balance reservation). This also applies if the payments are made for specifically designated receivables. The balance reservation shall expire finally with the settlement of all claims still outstanding and covered by this balance reservation at the time of payment. In case of prepayment transactions or cash transactions pursuant to § 142 Insolvency Ordinance, only the simple retention of title according to A. V. 1. clause 1 shall apply, the extension and prolongation forms of the retention of title shall not then apply.

2. The Purchaser may only sell reserved property during the course of normal business and as long as it is not behind with the payment of outstanding receivables towards HAZET. The Purchaser herewith assigns in advance to HAZET all receivables against third parties arising from such sales in the amount of the respective invoice value for the resold reserved property, including the statutory VAT. HAZET shall accept this assignment. The same applies for other claims, which occur at the point of the reserved property or otherwise result in respect to the reserved property, for instance insurance claims or claims from illicit action upon loss or destruction.
3. If the Purchaser sells the reserved property together with other objects not delivered by HAZET, the assignment of the receivables from the sale shall apply only in the amount of the invoiced value of the reserved property, the value of which is stated in the HAZET invoices. In case of processing, combination and mixing the reserved property with other goods by the Purchaser, HAZET is entitled to co-ownership of this in the proportion of the invoice value of the reserved property to the invoice value of the other goods used. If HAZET's ownership is terminated by combination or mixing, The Purchaser shall already assign to HAZET the ownership rights to which he is entitled to the new inventory or the item in the scope of the invoice value of the reserved property and store it free of charge for HAZET. The co-ownership rights apply as reserved property.
4. The Purchaser is entitled to collect the receivables from the sale to third parties.
5. HAZET is entitled to revoke the authorisation to collect receivables given in A. V. 4 if the Purchaser defaults on its payments, as well as in the event of a significant decline in the Purchaser's financial situation pursuant to A. IV. in the event of A.IV.7. Without the need for such a revocation, the collection authority expires with the placement of a request for insolvency proceedings or with the assignment of security measures in an insolvency proceeding. Upon request the Purchaser must inform HAZET of the assigned receivables and their debtors, and provide the documentation necessary for the collection of the receivables. Upon special request by HAZET the Purchaser shall inform the affected third-party debtors of the assignments having taken place.
6. Insofar as the Purchaser becomes entitled to claims against insurance companies or other third parties due to the reserved property deteriorating or becoming damaged, lost or destroyed, or for other reasons, these claims shall also be assigned instead of the sales proceeds to HAZET, in advance and to the same extent, and with all ancillary rights.
7. Rights arising from the retention of title and from all the special forms stipulated in these conditions are also deemed as contingent liabilities, which HAZET has accepted in the Purchaser's interest, until the title is transferred in full.
8. The Purchaser may not make or allow dispositions regarding the reserved property which do not correspond to the above conditions.
9. The Purchaser must inform HAZET in writing and without undue delay of seizures and other risks to HAZET's rights, which risks arise from third parties, and give information necessary for legal action to be brought by a third party claiming title to the seized property in accordance with §771, Code of Civil Procedure (Zivilprozessordnung – ZPO). The Purchaser shall be liable if HAZET suffers a loss because a third party cannot pay the legal and out-of-court costs of legal action which it must reimburse to HAZET pursuant to § 771, ZPO.
10. HAZET is entitled, at the Purchaser's expense, to insure the reserved property against fire, water and theft unless the Purchaser can demonstrate that it has taken out such insurance itself.
11. If the value of the securities, including offset possibilities, exceeds the secured receivables by more than 20% for an extended period of time, HAZET is obliged upon the Purchaser's request to release securities of HAZET's choice.

VI. Return of Goods

1. Insofar as HAZET is not obliged to take back goods, HAZET shall only take back goods insofar as the goods are current, in their original packaging and re-sellable and insofar as HAZET has consented to the take-back in writing beforehand. These must be returned free of charge.
2. A credit note for goods returned pursuant to A. VI. 1. is made with 80% of the calculated price. Costs for any reprocessing or new packaging shall be deducted additionally. The credit note can only be credited with new deliveries of goods. As a general principle, returns of insulated tools cannot be accepted for safety reasons.

B. Deliveries, Warranty, Liability

I. Delivery Periods, Delivery Dates

1. Periods and deadlines set by HAZET for deliveries and performances always apply only approximately, unless a fixed period or a fixed deadline is expressly assured or agreed.
2. The delivery periods commence with the receipt of the order confirmation but not before all the details of the order have been completely clarified and any necessary national and international official certificates have been obtained. The delivery periods and dates refer to the time of shipment, i.e. dispatch ex works or warehouse. These are also deemed to have been observed with the notification that the goods are ready to be dispatched, even if, through no fault of HAZET's, they cannot be dispatched on time.
3. Without influencing HAZET's rights arising from the Purchaser's default, the agreed delivery period is extended by the time during which the Purchaser defaults on its obligations arising from this or other business plus an appropriate start-up period.
4. Partial deliveries are permitted as far as the Purchaser can be reasonably expected to accept them. Each partial delivery is considered an independent business transaction.
5. HAZET is entitled to withhold outstanding deliveries if the Purchaser does not fulfil its payment obligations or if there is reasonable concern that it cannot fulfil such an obligation (right of retention). HAZET reserves the right in any case to make deliveries in return for advance payment or cash on delivery.
6. HAZET's delivery obligation is always subject to the reservation of correct, timely and contractual self-delivery, unless the incorrect or delayed self-delivery is the fault of HAZET.
7. If HAZET is in delay with a delivery or other service, the Purchaser can demand replacement of the delay damage as well as the performance; but in the case of minor negligence this is limited to maximum 10% of the agreed price for the delayed delivery or performance. The right of the Purchaser to damage compensation in lieu of performance pursuant to B. VII. 1. and B. VII. 2. remains unaffected.



II. Special Conditions for Goods on Recall

1. For business with continuous deliveries HAZET must receive release orders and type categories for roughly the same amount per month. If the release orders or type categories are not given on time, HAZET is entitled, after the deadline has expired without any result, to categorise and deliver the goods itself, or to rescind from the outstanding part of the transaction and demand compensation instead of payment.

III. Force Majeure and Other Delivery Conditions

1. Force majeure events, such as strike, lockout, mobilization, war, blockade, pandemic or epidemic, export and import bans, raw material and fuel shortages, fire and other circumstances which are not the fault of HAZET and which significantly impede the delivery or performance by HAZET, shall entitle HAZET to postpone the delivery for the duration of the obstacle and an appropriate start-up time. This applies irrespective of whether the above-mentioned circumstances occur at HAZET, the preliminary supplier or one of the subcontractors.
2. The Purchaser can demand an explanation from HAZET as to whether delivery will take place within an appropriate period or whether a rescission from the contract should be considered. If HAZET does not make a declaration within an appropriate deadline, the Purchaser can itself rescind from the as yet unfulfilled part of the delivery.
3. The declaration made by the preliminary supplier or the sub-contractor to HAZET regarding circumstances which have occurred at their premises pursuant to B.III. 1. are deemed as sufficient proof that HAZET is not responsible for the hindrance of the delivery.

IV. Dispatch and Passing of Risk

1. The forwarding agent or freight carrier shall be determined by HAZET. In the absence of any special agreement, the choice of route and means of transport is entrusted to HAZET, excluding any liability.
2. Release orders must be given without undue delay for goods which have been notified as ready for dispatch on the agreed date. HAZET is otherwise entitled to store them as it sees fit at the Purchaser's expense and risk, and invoice them as delivered ex works or warehouse. The means of transport must be unloaded immediately if the delivery is made with carriage paid. The costs for any periods of delay shall always be borne by the Purchaser.
3. Unless otherwise agreed, the delivery shall be made „ex works“. The risk shall in any case – including a confiscation – pass to the Purchaser when the goods are handed over to the forwarding agent or freight carrier or at the latest when the goods leave the plant or warehouse – e.g. even if the delivery is made with carriage paid.
4. Premature deliveries which the Purchaser can be reasonably expected to accept and excess or short deliveries which are customary in the trade are permitted.
5. The requested amount does not have to be reached or may be exceeded by up to 10% for custom-made products. Also considered as custom-made products are mass-produced articles which the Purchaser explicitly wishes to have a special designation. The Purchaser is not entitled to a right of withdrawal. The goods cannot be returned to HAZET.

V. Defects and Warranty

1. If the delivered goods exhibit a material defect, HAZET is first entitled to reworking or replacement delivery with a reasonable period as chosen by HAZET.
2. The buyer shall examine the received goods immediately after delivery. Claims for defects only arise if defects are complained about immediately, but no later than in 7 days in text form; concealed defects must be notified in text form immediately after their discovery. Furthermore, the Purchaser shall immediately notify the responsible shipping agent, transport/freight company or post office, as well as HAZET, of any transport damage and obvious defects.
3. If an acceptance of the goods or an initial sample inspection has been agreed, the buyer is obliged to immediate acceptance or initial sample inspection. An initial sample inspection does not exonerate the buyer from an incoming goods inspection of the series parts. Complaint about defects, which the Purchaser could have discerned upon immediate initial sample inspection, is excluded from the delivery of series parts.
4. HAZET shall be given the opportunity to determine the defects receiving complaint. Goods that have received complaint shall be sent back to HAZET immediately on demand; HAZET shall assume the transport costs if the defect complaint is justified. If the Purchaser does not fulfil these obligations or makes changes to goods that have already received complaint without the consent of HAZET, he shall lose any material defect claims.
5. HAZET has equally little responsibility for defects, which arise due to unsuitable or improper use, defective assembly or commissioning by the Purchaser or third parties, normal wear, erroneous or negligent handling, as for the consequences of improper changes or repair work performed by the Purchaser or third parties without HAZET's consent.
6. Statutory recourse claims by the Purchaser against HAZET only exist as far as the Purchaser has not come to any understanding with its customer which exceeds the statutory claims due to liability for defects.
7. The reimbursement pursuant to B.V.6. above is limited to the cost price (e.g. transport and material costs) incurred by the Purchaser but not its profit margin towards the customer.
8. Further claims by the Purchaser due to material defects, which are asserted against HAZET and its vicarious agents, are excluded subject to the regulation in B.VI. of these Terms and Conditions.
9. HAZET vouches that the goods supplied by HAZET are free of commercial property rights and/or copyrights of third parties. HAZET is obliged to exonerate the Purchaser from claims within the framework of the statutory regulations, which third parties assert on account of the violation of commercial property rights and/or copyrights to which they are entitled in the Federal Republic of Germany. A precondition for the exoneration is that the claims of third parties have either been recognised by HAZET or determined judicially with legal effect.
10. The Purchaser shall enable HAZET to participate at its own expense in the legal defence against such claims of third parties, in particular by what is referred to as a third-party intervention in the sense of civil procedure. The Purchaser shall support HAZET in the preparation and execution of the legal defence or settlement negotiation to a reasonable extent. HAZET shall reimburse the Purchaser all necessary expenses in conjunction with the legal defence against this utilisation, whereby legal fees are reimbursed on the basis of the Law on the Remuneration of Lawyers („RVG“).

1. A precondition for the above claims of the Purchaser against HAZET is that
 - a) the Purchaser shall inform HAZET immediately in writing if claims are asserted against the Purchaser in relation to the supplied goods on account of the violation of property rights of third parties,
 - b) the Purchaser grants HAZET control of the legal defence and acts in the context of the legal defence and/or in settlement negotiations only and always in agreement with HAZET and
 - c) the alleged infringement is exclusively attributable to the goods supplied by HAZET without connection or use with other products.

VI. Guarantee

1. Irrespective of the material defect claims to which the Purchaser might be entitled according to B. V., HAZET grants a full guarantee on all tools in case of material and production faults. All adapters are excluded from the full guarantee. The full guarantee on sockets for impact operation is limited to material defects and/or faulty workmanship. The guarantee does not cover the tools or consumables for normal wear and/or tear damage. The full guarantee will not be valid for tools which cannot be used any more due to their old age or due to abuse or improper use. The relevant operating instructions and safety instructions for the HAZET tools shall be considered in this context. The general safety instructions as well as the data in the HAZET tool catalogue shall also be considered. An improper use of tools occurs especially in case:
 - an exceeding of the normal or specified loading capacity of the tool (for instance when using a diagonal cutter on a wire that is too hard or in case of chisels, centre punches or drift punches that are used on steel that is too hard or for work that is too heavy).
 - the further use of a tool that already shows damage or defects.
 - the operation of screws and nuts with a wrong-sized socket.
 - tools that have been modified.
 - the use of sockets designated for manual operation on impact wrenches.
 - the improper use of tools (e.g. use of screwdrivers as chisels or pry bars etc.).
2. In order to make use of the guarantee right, the Purchaser shall send the tool carriage free domicile via specialist trade to HAZET in the event of a material or manufacturing defect. HAZET shall check the tool. If a material or manufacturing defect is present, HAZET shall replace the goods or repair the goods free of charge.

VII. Liability

1. On account of violation of contractual and non-contractual obligations, in particular on account of impossibility, delay, fault upon contract initiation and unauthorised handling, HAZET shall only be liable on cases of wilful intent and gross negligence. In case of gross negligence, HAZET's liability is limited to the contract-typical damage foreseeable upon conclusion of contract.
2. The limitations of liability from B. VII. 1. do not apply in case of culpable violation of essential contractual obligations, insofar as the attainment of the contractual purpose is jeopardised, in case of culpably caused damage to life, body and health and also then if and to the extent that HAZET has assumed the guarantee for the nature of the sold item, as well as in cases of mandatory liability according to the Product Liability Act. Essential contractual obligations are those, which actually enable the proper execution of the contract and upon whose compliance the Purchaser may regularly rely. A reversal of the burden of proof to the Purchaser's disadvantage is not associated with the above regulations.
3. Insofar as the liability of HAZET is excluded or limited, this also applies for the personal liability of the employees, workers, personnel, legal representatives and vicarious agents of HAZET.
4. Insofar as the Purchaser is legally obliged, on account of an error caused by HAZET in the goods produced and supplied by HAZET, to implement a recall action and insofar as HAZET itself would therefore be liable in the external relationship, HAZET shall bear the costs associated with the recall action only to the extent that the measures and costs are reasonable and necessary, no milder equally effective means of risk aversion are available and insofar as these were coordinated with HAZET before any costs are incurred. HAZET's objection to the contributory negligence remains unaffected.
5. Unless otherwise agreed, contractual claims, which arise for the Purchaser against HAZET on the occasion of and in conjunction with the delivery of the goods, shall come under the statute of limitations one year after delivery of the goods. This does not apply, insofar as §§ 438 Para. 1 No. 2, 478, 479 or § 634 a Para. 1 No. 2 of the BGB stipulates longer periods as well as in cases of injury to life, body or health, in case of a deliberate or grossly negligent breach of duty by us or in case of fraudulent concealment of a defect. The limitation period shall not recommence in cases of defective supplementary performance. The statutory regulations concerning the burden of proof remain unaffected.

C. Final Provisions

1. The place of fulfillment and exclusive court of venue for all disputes directly or indirectly resulting from this contractual relationship is Remscheid.
2. The legal relationship between HAZET and the Purchaser is exclusively subject to the law of the Federal Republic of Germany excluding the United Nations Convention on Contracts for the International Sale of Goods (CISG) dated April 11, 1980.
3. Should any one of the clauses in these Terms and Conditions be or become invalid either in part or in full, the validity of the rest and/or the other provisions shall not be affected.



- Select the right tool
- Use the tool as indicated in the operating instructions
- Wear eye protection
- Keep tools clean
- Use tools with protective insulation when working on live components



Read operating instructions before use



Measuring units serve to select the right-sized tools



Wear safety glasses



An optimal frictional connection guarantees a long service life of tools and screws



Use hearing protection



Do not modify tools



Only use suitable specialty tools to extend the lever arm



Hand-operated tools are not suitable for use with impact wrenches



Do not hit hand tools with a hammer



Never open more than one drawer at a time (danger of tipping over)



Avoid splintering due to incorrect striking



Never use drawers as a ladder



Never use a screwdriver as a pry bar or chisel



Never pull tool trolleys



Select screwdriver with an appropriate blade. Always be sure that the screwdriver blade is vertical to the screw



Dispose of worn-out tools



Environmental management

We wish to avoid substances hazardous to water (e.g. acids, lyes, oils, coolants etc.) or store and use them in such a way that no damage is done to the environment. Wastewater must only be discharged in clean condition. Emissions that come from our company must not cause any damage to the environment or people. Carefully handling the resources and actively protecting the environment are part of our corporate responsibility.

Consumption of resources

Corporate environmental protection to us means looking at, analysing and improving company processes in their entirety. Negative impacts on the environment can only be reduced by taking appropriate care during production and provision of services.

Compliance with legal regulations, continuous improvement

We are obligated to comply with the official requirements, laws and provisions and constantly improve the corporate environmental protection. For all measures for protecting the environment, we orientate ourselves by the best available and economically viable technology.

Employee development

Successful environmental protection can only be achieved through the active cooperation of all employees. We therefore wish to inform and educate all employees to the extent that they can actively take joint responsibility.

Active public relations

We wish to engage in an open and objective dialogue with the business partners, neighbours, authorities and the interested public regarding negative environmental impacts of our company and are receptive to suggestions for improvement.

Procurement

When procuring our raw and auxiliary materials, we consider ecological criteria and we prefer suppliers who place a similarly high amount of importance on environmental protection as we do.

Monitoring

We regularly monitor and assess the environmental impacts of our company as well as the attainment of our set targets, which are adapted when new knowledge is acquired.





Information
Notes



Lined area for notes with horizontal ruling lines.



HAZET representatives and sales offices in Germany

HAZET-WERK
Hermann Zerver GmbH & Co. KG
Postanschrift:
100461
42804 REMSCHEID
Hausanschrift:
Güldenwerther Bahnhofstr. 25-29
42857 REMSCHEID
☎ +49(0)2191/792-0
FAX) Inland +49(0)2191/792-375
FAX) Export +49(0)2191/792-400
www.hazet.de
e-mail info@hazet.de

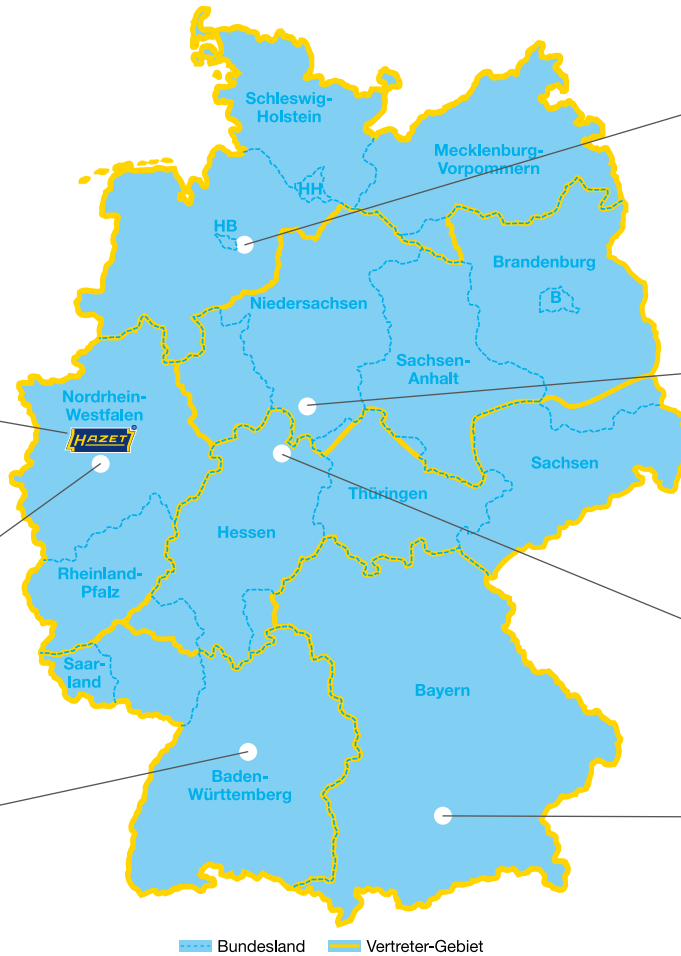

Verkaufsbüro Nord
☎ +49(0)2191/792-425
FAX) +49(0)2191/792-375
www.hazet.de
e-mail auftragscenternord@hazet.de

Wenzel GmbH
Altendorfer Tor 23
37574 Einbeck
Postfach 18 41
37559 Einbeck
☎ +49(0)5561/9342-0
FAX) +49(0)5561/9342-30
e-mail info@wenzeleinbeck.de

Verkaufsbüro West
☎ +49(0)2191/792-231
FAX) +49(0)2191/792-375
www.hazet.de
e-mail auftragscenterwest@hazet.de

Verkaufsbüro Mitte
☎ +49(0)2191/792-229
FAX) +49(0)2191/792-375
www.hazet.de
e-mail auftragscentermitte@hazet.de

Verkaufsbüro Südwest
☎ +49(0)2191/792-230
FAX) +49(0)2191/792-375
www.hazet.de
e-mail auftragscentersw@hazet.de

Verkaufsbüro Süd
☎ +49(0)2191/792-272
FAX) +49(0)2191/792-375
www.hazet.de
e-mail auftragscentersued@hazet.de

Delivery only via HAZET specialist dealers. The named representatives are available to provide information and advice.

HAZET-Guarantee



During the whole production process, all HAZET tools are subject to stringent quality controls and before delivery ex works they are meticulously checked for material defects and faulty workmanship.

HAZET offers a total quality guarantee on all tools showing material defects or faulty workmanship.

If you detect material defects or faulty workmanship, please send us the tool in question free of charge through your distributor.

After inspection by us, we will replace your tool or repair it free of charge, provided that the tool shows a material defect or faulty workmanship.

All adapters are excluded from the guarantee.

The full guarantee on sockets for impact operation is limited to material defects and faulty workmanship.

The guarantee does not cover the sockets' normal wear and tear damage.

The guarantee will not be valid for tools which cannot be used any more due to their old age or due to abuse or improper use.

In this context, we emphasise that the operating instructions and safety recommendations of each tool must be strictly observed. For more details, also see the General Safety Recommendations on this page as well as the indications given in the HAZET tool catalogue.

Below are some examples which are considered as "improper use of tools" and are not covered by the guarantee:

- Exceeding the tool's normal or prescribed capacity, e.g.
 - The use of a diagonal cutter for a steel thread whose diameter is too large
 - Chisels, centre punches or drift punches that have been used too hard or on a too hard steel surface.
- the further use of a tool that already shows damage or defects.
- the operation of screws and nuts with a wrong-sized socket.
- Tools that have been modified.
- the use of sockets designated for manual operation on impact wrenches.



We replace any tool showing material defects and/or faulty workmanship (see also our sales, delivery and payment conditions).



HAZET – environmental protection is of fundamental importance to us.
This price list has been printed using environmentally friendly chlorine-free paper.

HAZET is certified in accordance with
DIN EN ISO 14001
0410430403
DIN EN ISO 9001
0410030403



HAZET-WERK – With Tradition to the Future!



Plant 1 · Remscheid-Güldenwerth



Plant 2 · Heinsberg



Plant 3 · Remscheid-Vieringhausen



Plant 4 · Remscheid-Vieringhausen



Partner of
Manthey



Official partner of the
Nürburgring



Official supplier of
MERCEDES-BENZ
Global TechMasters



PORSCHE
MOTORSPORT

OFFICIAL SUPPLIER



Online-Katalog:
<https://www.hazet.de/de/produkte/>



facebook:
<https://www.facebook.com/hazetwerk/>



youtube:
<https://www.youtube.com/user/HAZETWERK>



Instagram:
https://www.instagram.com/hazet_1868_official/





Das Werkzeug



4 000896 1257423
WHB24/EN/XX/0 L 11/2023/5. myview HZ-938/M6