



NAGYKERESKEDELMI
ÁRJEGYZÉK

2025



KIZÁRÓLAG NEM TERMÉSZETES SZEMÉLYNEK MINŐSÜLŐ VÁSÁRLÓK RÉSZÉRE.
AZ ÁRAK A 27%-OS ÁFA-T NEM TARTALMAZZÁK.
ÉRVÉNYES: 2026. FEBRUÁR 28-IG.
A NYOMDAI HIBÁKÉRT FELELŐSSÉGET NEM VÁLLALUNK.

A BETA ÉRTÉKEI
ELSZÁNTSÁG. ELKÖTELEZETTSÉG. HARMÓNIA. TEHETSÉG.



Beta
WELL DONE

A Beta-nál a dolgokat csak egyféleképpen csinálhatjuk: jól.

Ez a Beta világa, és ez az elv vezérli mindennapi munkánkat világszerte. Ennek során pedig négy alapértékünkre támaszkodunk:

ELSZÁNTSÁG hogy egy olasz mesterember által 1923-ban létrehozott, azóta az egész világon ismertté vált és négy generáció óta folyamatosan növekvő vállalkozásba fektessünk és azt folyamatosan megújítsuk.

ELKÖTELEZETTSÉG w dbanie o jakość produktów, aby każdy handlowiec wiedział, że może liczyć na rzetelną obsługę, a każdy użytkownik oczekiwał precyzji, jakości i trwałości produktów Beta.

HARMÓNIA a vonalvezetésben a tökéletes konstrukcióért, mert ha valamit jól csinálunk, az a funkció és design tökéletes egyensúlyát eredményezi.

TEHETSÉG a legnagyobb kincsünk, mert ez jellemez minden munkatársunkat és szakembert, aki a Beta-t választja. Hogy semmit sem bíz a véletlenre ötleteinek és álmainak elkötelezett és szenvedélyes megvalósításában.

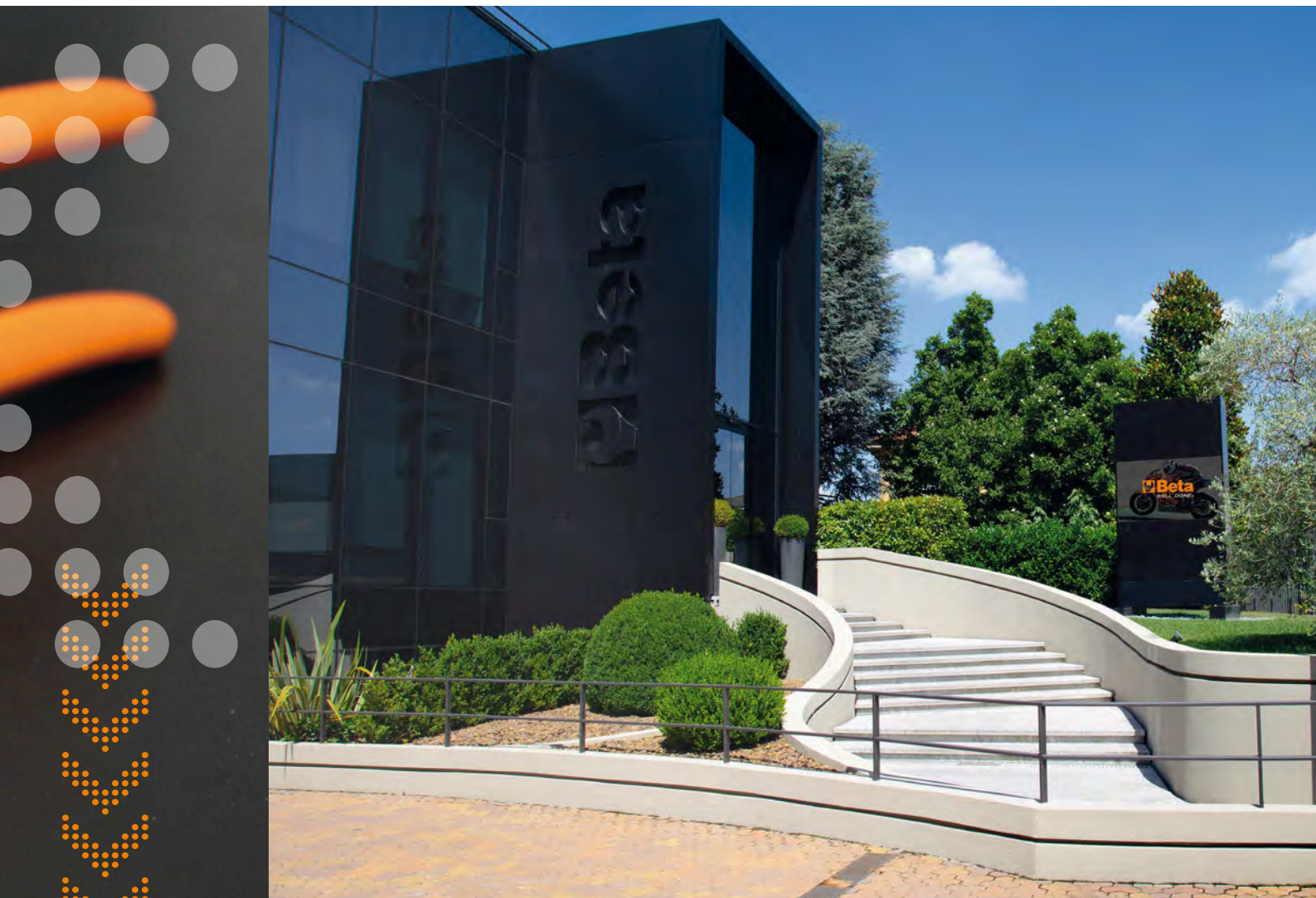

TARTALOM

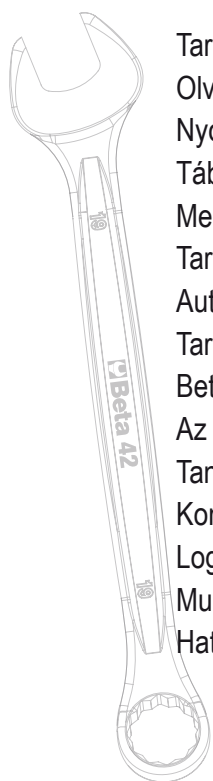

Tartalomjegyzék	4
Olvasási útmutatás	8
Nyomatéklucskok húzási nyomatéktartománya	58-59
Táblázat szerszámokhoz és készletekhez	343, 492-493
Megszűnt cikkek - Ajánlott cikkek	727÷732
Tartalomjegyzék betűrendben	733÷737
Autószerelő szerszámok	738÷740
Tartalomjegyzék cikkszám szerint	741÷755
Beta csoport	756
Az olasz szerszámkészítés története	757
Tanúsított minőség	758
Kontroll és minőség	759
Logisztika	760
Munkaszervezés	761
Hatékony jelenlét	762

RSC55 MŰHELYBERENDEZÉS



RSC55

416÷440; 488÷491

RSC50 2.0 MŰHELYBERENDEZÉS



Beta RSC50 2.0

441÷463; 488÷491

C45PRO 2.0 MŰHELYBERENDEZÉS



Beta C45PRO 2.0

464÷487; 488÷491

MŰHELYBERENDEZÉSEK ÉS KÉSZLETEK



343÷361



362÷391



375; 392÷414

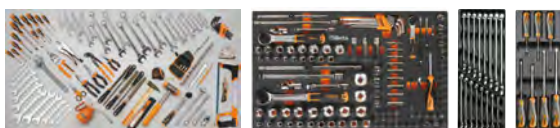

492÷569

KULCSOK



11÷17

23÷28

112÷117

DUGÓKULCSOK ÉS TARTOZÉKOK



69÷78

85÷112

NYOMATÉKKULCSOK ÉS NYOMATÉKSOKSZOROZÓK



54÷56

57÷69

CSAVARHÚZÓK, IMBUSZCSAVARHÚZÓK ÉS CSAVARHÚZÓBETÉTEK



18÷23

78÷85

115÷117

143÷157

FOGÓK



126÷133

137÷140

231÷232

KALAPÁCSOK ÉS BEÜTŐSZERSZÁMOK



9÷10

164÷167

212

FÚRÓ- ÉS MENETVÁGÓSZERSZÁMOK



36÷41

41÷43

43÷51

51÷53

LEHÚZÓK



168÷169

194÷199; 203

MÉRŐ- ÉS JELÖLŐESZKÖZÖK



205÷212

VÁGÓSZERSZÁMOK ÉS ÁLTALÁNOS KARBANTARTÓ SZERSZÁMOK

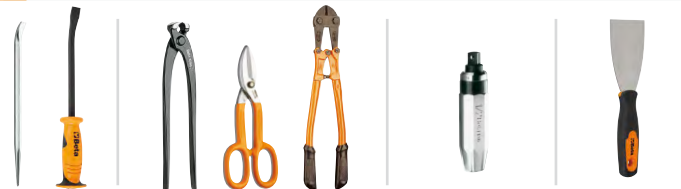

121÷122

132÷135

156÷157

178



204

213÷223



233÷237

LÁMPÁK

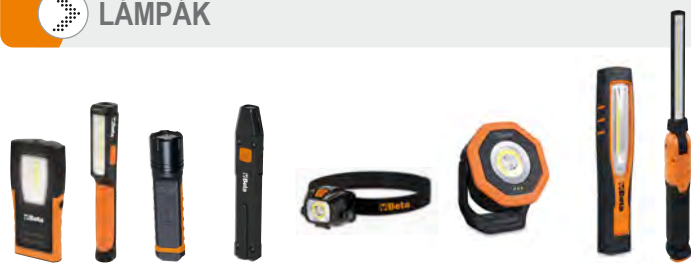

237÷242

KÁBELDOBOK



242÷244; 339

VÍZ- ÉS GÁZSZERELŐ SZERSZÁMOK



28÷35

ELEKTRONIKAI ÉS MIKROMECHNIKAI SZERSZÁMOK

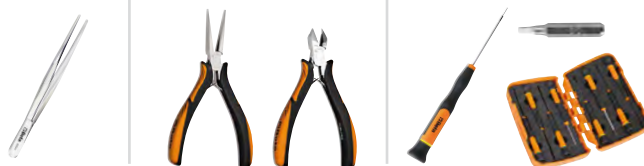

124÷125

140÷142

146÷149

ELEKTROTECHNIKAI SZERSZÁMOK



135÷137

148

585÷587

227÷231

1000V-IG SZIGETELT SZERSZÁMOK



278÷284

ROZSDAMENTES SZERSZÁMOK



292÷296

SZIKRAMENTES SZERSZÁMOK



297÷305

AUTÓJAVÍTÓ SZERSZÁMOK



118÷124

158÷163



168÷194; 199÷202

224÷233



247÷254

MŰHELYBERENDEZÉS



254÷266

MOTORKERÉKPÁR-SZERELŐ SZERSZÁMOK



267÷272

KERÉKPÁRSZERELŐ SZERSZÁMOK



273÷277

AKKUMULÁTOROS GÉPEK



306÷319

PNEUMATIKUS SZERSZÁMOK ÉS TARTOZÉKOK



320÷342

LEESÉSVÉDETT SZERSZÁMOK



285÷291

BETA VEGYIÁRUK



572÷578

BETA CSISZOLÓANYAGOK



579÷584

BM MÁRKANÉVEN KAPHATÓ TERMÉKEINK



588÷594

ROBUR-RÖGZÍTÉSTECHNIKAI SZERELVÉNYEK

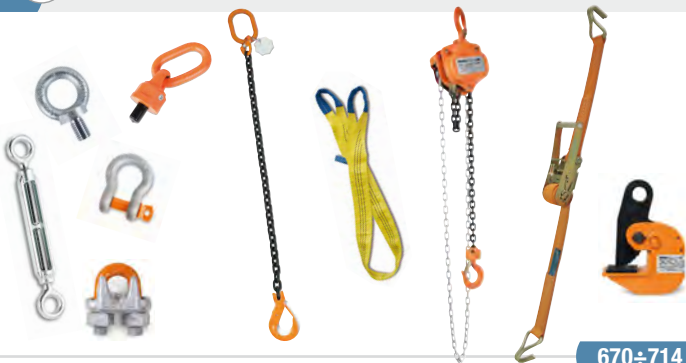

670÷714

MUNKAVÉDELMI CIPŐK ÉS ZOKNIK



624÷649

MUNKARUHÁZAT



650÷669

BLISTER



595÷609

ÁLLVÁNYOK ÁRUHÁZAKBA, BEMUTATÓTERMÉKBE



610÷623

BETA-KOLLEKCIÓ



715÷726

Katalógusszám

42MP

Csillag-villáskulcs, fényes krómozott

Szerszám profil



Egységár

DIN 3113 UNI-ISO 7738

★ Ajánlatkérésre szállítható cikk

• Fő méret

○ Hatszögű

Méret

Egységcsomag

Darab

Csomagolásmód jelölése

Szerszámok mennyisége a készletben

mm	mm	Ft	
6x6	100	6.150	5 000421606
7x7	110	6.190	5 000421607
8x8	120	6.230	5 000421608
9x9	130	6.280	5 000421609
10x10	140	6.320	5 000421610
11x11	150	6.440	5 000421611
12x12	158	6.520	5 000421612
13x13	170	6.600	5 000421613
14x14	178	7.130	5 000421614
15x15	190	7.690	5 000421615
16x16	199	8.140	5 000421616
17x17	209	8.500	5 000421617
18x18	219	9.070	5 000421618
19x19	230	9.390	5 000421619
20x20	240	10.700	3 000421620
21x21	250	11.350	3 000421621
22x22	260	11.550	3 000421622
24x24	280	13.350	3 000421624
27x27	307	15.800	3 000421627
30x30	337	19.650	3 000421630
32x32	360	20.450	3 000421632



	Ft	
42MP/B9	68.150	1 000421661
-6-7-8-10-11-13-14-17-19 mm	5.180	1 020020030
2002/BV9		

Blister-áruházi polccsomagolás



Motorkerékpár-szerelő szerszámok



Kerékpárszerelő szerszámok



Cikkszám

Új termék 2025

A leggyakrabban használt jelölések jelentése

Például

készleteknél	
B	= műanyag táskában 42/B9N
BV	= üres tasak/táska 2002/BV9
C	= fémdobozban 900/C11
D	= felüggeszhető csomagolás 1293/D6
S	= kartondobozban 42/S17
SP	= tartó állvánnyal 42/SP25
SPV	= üres tartó állvány 42/SPV7
SC	= tartó állvány 96/SC9
SCV	= üres tartó 96/SCV

A leggyakrabban használt jelölések jelentése

Például

PT	= 5-lapú csavar 910PT
X	= irányváltós racsnis (fémdobozban) 920A/C12X

Csavarhúzóknál és csavarhúzóbetéteknél

LP	= egyenes hornyú csavarokhoz 920LP
PE	= hatszögornyú csavarokhoz 920PE
PH	= PHILLIPS®-csavarokhoz 920PH
PZ	= POZIDRIV®- és SUPADRIV®-csavarokhoz 1299PZ
RTX	= TAMPER-RESISTANT-TORX®-csavarokhoz 1298RTX
SP	= SPANNER csavarhúzóbetétek 861SP
TRW	= TRI-WING®-csavarokhoz 861TRW
TQS	= TORQ-SET®-csavarokhoz 861TQS
TX	= TORX®-csavarokhoz 920TX
XZN	= XZN®-csavarokhoz 920XZN

általánosságban

készleteknél	
AS	= coll méretű szerszámok 5915VU/AS
E	= elektronika/elektrotechnika 5980ET/A
I	= vízvezeték-szereléshez 5980ID
MT	= földmunkagépekhez 5902MT
U	= általános szereléshez 5915VU/3
SBK	= motorkerékpár javítás 5940SBK
VG	= autószereléshez 5904VG/5T
VI	= ipari szereléshez 5902VI

dugókulcsbetéteknél	
A	= hatszögprofilú 910A
B	= tizenkétshögprofilú 910B
ES	= homlyolt profilú 920ES
FTX	= TORX® profilú 910FTX

AS	= coll-méret 42AS
BA	= szikramentes szerszámok 42BA
BM	= bimateriális nyél 1150BM
C	= üres kocsi C25
HS	= Leesésvédett szerszámok 42HS
INOX	= Szerszámok nemesacélból 42 INOX
L	= hosszú kivitel 952L
MQ	= 1000V szigetelésű szerszámok 1150MQ
MP	= fényes krómozott 42MP
R	= szár három anyagból 338R

A nyomtatott képek tájékoztató jellegűek.

Beta Utensili cég fenntartja magának azt a jogot, hogy áruválasztékán előzetes bejelentés nélkül változtatást hajtson végre.



FELHÍVJA a figyelmet a szerszámok rendeltetészerű használatára és a személyi biztonság érdekében a vonatkozó előírások betartására.



KIÜTŐK

A Beta ütőszerszámaikat arra tervezték, hogy optimális teljesítményt nyújtsanak és biztosítsák a felhasználók biztonságát.

Gyártásukhoz speciális típusú acélt használnak amely krómot, molibdént és vanádiumot (65CrMoV2-2) tartalmaz, és így rendkívül kemény és ellenálló szerszámok jönnek létre. A termékek – ha geometriai formájuk lehetővé teszi – húzott rudakból készülnek; egyéb esetekben a salakképződés elkerülése érdekében ellenőrzött légkör mellett forró kovácsolással alakítják ki a szerszámokat.

1 A hatszögprofil megakadályozza, hogy a szerszám elgördüljön a tartófelületen

2 A kiütők rendkívül hosszú, és mégis tökéletesen egyenes szárral rendelkeznek, hogy szűk helyekhez is hozzá lehessen férni velük

3 Annak érdekében, hogy a kiütők méretezése megfelelő legyen, a nagyobb hatékonyság érdekében minden egyes darab ütőfelülete úgy van kialakítva, hogy van egy egységes hengeres része és egy tökéletesen lapos vége.

4 Az összes ütőfelületet indukciós temperálásnak vetik alá, hogy megakadályozzák a szilánkos törést; az ütőpont deformálódásatermészetes következmény, így biztosítani lehet a szerszám használójának biztonságát.



A pontozókat és a kiütőket krómozás után élezzik, hogy jobb véső és vágó teljesítményt nyújtsanak, és eltávolítsák a hegyekről a galvanikus lerakódásokat. A főleg lerakódásokat el kell távolítani, hogy megakadályozzuk a sarkok „lekerekedését” és ridegségét a galvanizálás során keletkező hidrogén mennyisége miatt. A megmunkált területeket rozsdamentes réteg védi. ntykorozyjną.



30 Kiütő



Ø mm	L mm	Ft	📦	📄
2	125	3.360	10	000300020
3	125	3.360	10	000300030
4	150	4.490	10	000300040
5	150	4.490	10	000300050
6	150	4.740	10	000300060

31 Hosszú kiütő



Ø mm	L mm	L1 mm	Ft	📦	📄
2	110	22	3.360	10	000310002
3	128	35	3.480	10	000310003
4	146	45	4.290	10	000310004
5	164	55	4.490	10	000310005
6	182	65	5.670	5	000310006
8	200	80	5.950	5	000310008
10	220	95	7.490	5	000310010
12	250	115	8.020	3	000310012



31/B6N	Ft	📦	📄
2-3-4-5-6-8 mm	31.300	1	000310024
2002/BV6	4.050	1	020020000
31/SP6	37.050	1	000310030
2-3-4-5-6-8 mm			
31/SPV	10.700	1	000310031

31BM Kiütő nyéllel



Ø mm	L mm	L1 mm	Ft	📦	📄
2	168	42	6.920	2	000310402
3	180	52	7.090	2	000310403
4	191	62	7.730	2	000310404
5	200	72	8.140	2	000310405
6	221	82	9.350	2	000310406
8	235	94	9.840	2	000310408



31BM/D6	Ft	📦	📄
2-3-4-5-6-8 mm	49.050	1	000310420

31L Extra hosszú kiütő



Ø mm	L mm	L1 mm	Ft	📦	📄
4	175	80	5.060	5	000310104
5	175	80	5.430	5	000310105
6	175	80	6.400	5	000310106

31SE Vezetőcsapos kiütő

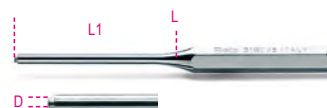

Ø mm	D mm	L mm	L1 mm	Ft	📦	📄
4	2,4	175	80	5.060	5	000310204
5	3,0	175	80	5.430	5	000310205
6	3,6	175	80	6.400	5	000310206



31/B6N-LSE	Ft	📦	📄
31L: 4-5-6 mm	37.800	1	000310324
31SE: 4-5-6 mm			
2002/BV6	4.050	1	020020000

32 Pontozó, krómozott



Ø mm	L mm	L1 mm	Ft	📦	📄
3	100	44	3.120	10	000320100
4	125	52	3.870	10	000320125
5	150	62	4.740	10	000320150

32AU Automata pontozó, barnított, krómozott

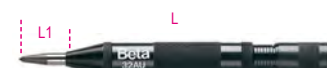

Ø mm	L mm	L1 mm	Ft	📦	📄
3	150	23	25.300	2	000320160

32AUR

Tartalékhegy a 32AU-hoz



Ø mm	Ft	5	10
3	4.570	5	000320170

33LT

Betűbeütő készlet

- Maximum 80 kg/mm² keménységű acélhoz
- 27 db beütőből álló készlet: betűk A-tól Z-ig + & jel



H mm	L mm	A mm	Ft	1	10
3	60	6,35	28.550	1	000330023
4	63	7,93	34.800	1	000330024
5	61	7,93	34.800	1	000330025
6	68	9,52	42.700	1	000330026
8	70	12,7	64.150	1	000330028

33NR

Számbeütő készlet

- Maximum 80 kg/mm² keménységű acélhoz
- 9 beütőből álló készlet: számok 0-tól 9-ig



H mm	L mm	A mm	Ft	1	10
3	61	6,35	10.100	1	000330003
4	62	7,93	12.350	1	000330004
5	62	7,93	12.350	1	000330005
6	68	9,52	14.950	1	000330006
8	71	12,7	21.850	1	000330008

34

Laposvágó, standard kivitel, krómozott



L mm	A mm	L1 mm	Ft	5	10
125	14,5	45	4.860	5	000340001
150	17,0	58	6.360	5	000340002
175	21,5	68	9.230	5	000340003

35

Erősített laposvágó, krómozott



L mm	A mm	Ft	5	10
100	14,5	5.710	5	000350001
125	17,0	6.360	5	000350002
150	20,5	7.940	5	000350003
200	23,0	11.950	5	000350004
250	28,5	17.200	2	000350005
300	34,0	23.700	2	000350006

35PM

Erősített laposvágó, kézzelvéddel



L mm	A mm	Ft	2	10
200	23,0	17.900	2	000350014
250	28,5	23.150	2	000350015
300	34,0	29.950	2	000350016

35PMR

Tartalék kézzelvéddő a 35PM-hez



L mm	Ft	1	10
200	5.950	1	000350024
250	5.950	1	000350025
300	6.280	1	000350026

36

Keresztvágó, standard kivitel, krómozott



L mm	A mm	L1 mm	Ft	5	10
125	4	44	5.060	5	000360001
150	6	53	5.950	5	000360002

37

Erősített keresztvágó, krómozott



L mm	A mm	L1 mm	Ft	5	10
150	6	45	9.150	5	000370001
200	8	55	13.150	3	000370002

37PM

Erősített keresztvágó, kézzelvéddel



L mm	A mm	Ft	2	10
200	8	19.450	2	000370012

37PMR

Tartalék kézzelvéddő a 37PM-hez



L mm	Ft	1	10
200	6.280	1	000370022



38/B6N

38/SP6

	Ft	1	10
38/B6N	31.800	1	000380016
30: 2-3 mm			
32: 4 mm			
34: 125-150 mm			
36: 150 mm			
2002/BV6	4.050	1	020020000
38/SP6	37.550	1	000380009
30: 2-3 mm			
32: 4 mm			
34: 125-150 mm			
36: 150 mm			
38/SPV	10.700	1	000380019



ÚJ 42-ES CSILLAG-VILLÁSKULCSOK

A klasszikus 42-es csillag-villáskulcs formája megújult.

A karcsú profilnak köszönhetően a forma stílusos, vékony és kézreálló. A Beta csillag-villáskulcs robusztus, ellenálló és ergonomikus, a lehető legjobb szerszám. A kulcs a legmodernebb automatizációs technológiával és kitűnően képzett szakemberek felügyeletével Sovicóban és Sulmonában készül.

GYORSAN HASZNÁLHATÓ

A tengelyhez képest 15°-os szögnek köszönhetően kisebb a felvételi szög.

ELLENÁLLÓ

Erőssége figyelemreméltó: nem rendeltetésszerű használat esetén a kulcs deformálódik, de nem törik el hirtelen és veszélyes módon.

HOMOGÉN

A félkész termék préselése során a száleloszlás egyenletessége megelőzi a veszélyes belső feszültségek kialakulását.

SZŰK HELYEN HASZNÁLHATÓ

A vékonyabb kialakításnak köszönhetően a szűk helyek is elérhetőek.

VÉDELEMMEL ELLÁTOTT

A nikkel-króm bevonat sokáig ellenáll a külső behatásoknak és megfelel az ISO 2819 szabvány tapadóképeségi vizsgálatokra előírt szigorú követelményeinek.

ERŐS

A hosszabb erőkarnak köszönhetően az ISO 1711 szabványban előírt nyomaték kétszerese érhető el.

OPTIMALIZÁLT

A kulcs – amely hosszabb, mint a legtöbb versenytárs termékei – lehetővé teszi, hogy kisebb erőfeszítéssel nagyobb nyomatékot érjen el.



ERGONOMIKUS

A 15°-ban hajlított fej védi a kezét. A forma kialakítása öntéssel történik; nem később hajlítják meg.



42

csillag-villáskulcsok

Az elérhető nyomaték több mint a duplája az ISO 1711 szabványban elfogadottakhoz képest



DIN 3113 UNI-ISO 7738

mm	L mm	S1 mm	Ft	cs	cs
5,5x5,5	95	3,4	3.700	5	000421005
6x6	95	3,4	3.740	5	000421006
7x7	105	3,6	3.770	5	000421007
8x8	116	3,9	3.930	5	000421008
9x9	127	4,2	4.090	5	000421009
10x10	137	4,5	4.170	5	000421010
11x11	148	4,8	4.450	5	000421011
12x12	158	5,1	4.490	5	000421012
13x13	169	5,6	4.530	5	000421013
14x14	180	5,7	5.220	5	000421014
15x15	190	6,0	5.750	5	000421015
16x16	201	6,3	5.950	5	000421016
17x17	212	6,8	6.230	5	000421017
18x18	222	7,0	6.640	5	000421018
19x19	233	7,5	6.840	5	000421019
20x20	243	7,7	7.690	3	000421020
21x21	254	7,9	8.340	3	000421021
22x22	264	8,3	8.540	3	000421022
23x23	275	8,5	9.270	3	000421023
24x24	285	8,7	9.800	3	000421024
25x25	296	8,7	10.300	2	000421025
26x26	307	8,9	11.150	2	000421026
27x27	317	9,1	11.950	2	000421027
28x28	328	9,3	12.350	2	000421028
29x29	338	9,5	13.550	2	000421029
30x30	349	9,7	14.150	2	000421030
32x32	370	10,1	15.600	2	000421032
34x34	391	10,5	29.550	1	000421034
35x35	412	10,7	31.550	1	000421035
36x36	412	10,7	33.000	1	000421036
38x38	433	11,3	36.450	1	000421038
41x41	465	12,0	41.300	1	000421041



	Ft	cs	cs
42/B9N 6-7-8-10-11-13-14-17-19 mm	48.050	1	000421074
2002/BV9	5.180	1	020020030



FIGYELEM!

A 42-es csillag-villáskulcs új formája tökéletesen illeszkedik a klasszikus 42-es csillag-villáskulcs tartóba és szerszámtálcáiba





	Ft		
42/S14 6-7-8-10-11-12-13-14 -15-16-17-19-22-24 mm	77.400	1	000421067
42/S17 6-7-8-9-10-11-12-13-14-15 16-17-18-19-20-21-22 mm	94.400	1	000421065
42/S15 6-7-8-10-11-12-13-14 17-19-22-24-27-30-32 mm	107.400	1	000421066
42/S17X 6-7-8-10-11-12-13-14- 15-16-17-19-21-22- 24-27-30 mm	111.900	1	000421068
42/S26 6-7-8-9-10-11-12-13-14 15-16-17-18-19-20-21 22-23-24-25-26-27-28 29-30-32 mm	202.500	1	000421070

42/SC9I-E

9 darabos csillag-villáskulcs készlet kompakt tartóval

Az elérhető nyomaték több mint a duplája az ISO 1711 szabványban elfogadottakhoz képest



	Ft		
42/SC9I 8-10-11-12-13-14-15-17-19 mm	49.450	1	000421087
142/SCV9I	4.700	1	001420103
42/SC9E 8-10-11-12-13-16-17-18-19 mm	51.050	1	000421088
142/SCV9E	4.700	1	001420104



	Ft		
42/SP25 6-7-8-9-10-11-12-13-14- 15-16-17-18-19-20-21- 22-23-24-25-26-27-28- 30-32 mm	217.100	1	000421085
42/SPV2	28.150	1	000420090



42/SP15

42/SPV...

	Ft		
42/SP15 6-7-8-9-10-11-12-13-14-15- 16-17-19-22-24 mm	87.850	1	000421078
42/SPV7 42: 8-10-11-13-14-17-19 mm 55: 6x7-8x9-10x11-12x13 14x15-16x17-18x19 mm	3.320	1	000420097
42/SPV11 42MP: 8-9-10-11-12-13 14-15-16-17-19 mm	4.700	1	000420100
142-142SN : 8-9-10-11-12-13 14-15-16-17-19 mm	6.320	1	000420102
42/SPV15 42: 6-7-8-9-10-11-12-13-14 15-16-17-19-22-24 mm			



42AS

Csillag-villáskulcs, krómozott



	L mm	Ft		
1/4x1/4	95	4.490	2	000421106
9/32x9/32	106	4.530	2	000421107
5/16x5/16	116	4.570	2	000421108
3/8x3/8	137	5.060	2	000421110
7/16x7/16	148	5.430	2	000421111
1/2x1/2	169	5.630	2	000421113
9/16x9/16	180	6.110	2	000421114
19/32x19/32	191	6.680	2	000421115
5/8x5/8	201	7.090	2	000421116
11/16x11/16	212	7.570	2	000421117
3/4x3/4	233	8.060	2	000421119
13/16x13/16	254	9.760	2	000421121
7/8x7/8	264	10.100	2	000421122
15/16x15/16	285	11.750	2	000421124
1x1	296	11.950	2	000421125
1.1/16x1.1/16	317	13.750	2	000421127
1.1/8x1.1/8	338	14.950	2	000421129
1.1/4x1.1/4	370	18.200	2	000421132
1.5/16x1.5/16	391	29.750	1	000421133
1.3/8x1.3/8	412	34.200	1	000421135
1.7/16x1.7/16	412	35.400	1	000421136
1.1/2x1.1/2	433	37.250	1	000421138



	Ft		
42AS/B9N 1/4-5/16-3/8-7/16-1/2 9/16-5/8-11/16-3/4	59.200	1	000421159
2002/BV9	5.180	1	020020030



	Ft		
42AS/13 1/4-5/16-3/8-7/16-1/2-9/16-5/8 11/16-3/4-13/16-7/8-15/16-1	97.550	1	000421163
42AS/16 1/4-5/16-3/8-7/16-1/2-9/16-5/8 11/16-3/4-13/16-7/8-15/16-1- 1.1/16-1.1/8-1.1/4	144.500	1	000421166
42AS/17 1/4-9/32-5/16-3/8-7/16-1/2- 9/16-19/32-5/8-11/16-3/4- 13/16-7/8-15/16-1-1.1/16-1.1/8	137.500	1	000421168

42MP

Csillag-villáskulcs, fényes krómozott



DIN 3113 UNI-ISO 7738

mm	L mm	Ft		
6x6	100	6.150	5	000421606
7x7	110	6.190	5	000421607
8x8	120	6.230	5	000421608
9x9	130	6.280	5	000421609
10x10	140	6.320	5	000421610
11x11	150	6.440	5	000421611
12x12	158	6.520	5	000421612
13x13	170	6.600	5	000421613
14x14	178	7.130	5	000421614
15x15	190	7.690	5	000421615
16x16	199	8.140	5	000421616
17x17	209	8.500	5	000421617
18x18	219	9.070	5	000421618
19x19	230	9.390	5	000421619
20x20	240	10.700	3	000421620
21x21	250	11.350	3	000421621
22x22	260	11.550	3	000421622
24x24	280	13.350	3	000421624
27x27	307	15.800	3	000421627
30x30	337	19.650	3	000421630
32x32	360	20.450	3	000421632



	Ft		
42MP/B9 6-7-8-10-11-13-14-17-19 mm	68.150	1	000421661
2002/BV9	5.180	1	020020030



	Ft		
42MP/S17 6-7-8-9-10-11-12-13-14-15-16-17-18-19-20-21-22 mm	134.300	1	000421652
42MP/S21 6-7-8-9-10-11-12-13-14-15-16-17-18-19-20-21-22-24-27-30-32 mm	203.500	1	000421653



42LMP

Hosszú csillag-villáskulcs, fényes krómozott



mm	L mm	Ft		
8x8	148	5.870	2	000420508
9x9	167	6.070	2	000420509
10x10	172	6.280	2	000420510
11x11	186	6.600	2	000420511
12x12	197	6.720	2	000420512
13x13	207	6.840	2	000420513
14x14	223	7.290	2	000420514
15x15	233	8.020	2	000420515
16x16	243	8.620	2	000420516
17x17	261	9.150	2	000420517
18x18	270	10.050	2	000420518
19x19	280	10.300	2	000420519
21x21	301	11.750	2	000420521
22x22	318	12.350	2	000420522
24x24	338	14.150	2	000420524
27x27	376	16.200	2	000420527
30x30	409	20.650	2	000420530
32x32	435	22.450	2	000420532



	Ft		
42LMP/S14 8-9-10-11-12-13-14-15-16-17-18-19-21-22 mm	115.900	1	000420551
42LMP/S18 8-9-10-11-12-13-14-15-16-17-18-19-21-22-24-27-30-32 mm	189.400	1	000420552

42SLIM

vékonyított végű csillag-villáskulcsok



DIN 3113 UNI-ISO 7738

mm	L mm	S1 mm	Ft		
8x8	116	3,4	4.250	5	000420408
10x10	137	3,8	4.570	5	000420410
11x11	148	3,8	4.780	5	000420411
12x12	158	4,2	4.900	5	000420412
13x13	169	4,4	5.020	5	000420413
14x14	180	4,6	5.670	5	000420414
15x15	190	4,7	6.230	5	000420415
16x16	201	4,7	6.440	5	000420416
17x17	212	5,1	6.640	5	000420417
18x18	222	5,1	7.170	5	000420418
19x19	233	5,6	7.290	5	000420419



	Ft		
42SLIM/B8NI 10-11-12-13-14-15-17-19 mm	50.300	1	000420478
42SLIM/B8NE 10-11-12-13-16-17-18-19 mm	52.000	1	000420479
2002/BV8	5.180	1	020020020



	Ft		
42SLIM/S11 8-10-11-12-13-14-15-16-17-18-19 mm	62.950	1	000420471

45

Erősített csillag-villáskulcs, krómozott



DIN 3113 UNI-ISO 7738

mm	L mm	Ft		
46x46	500	85.400	1	000450046
50x50	540	96.150	1	000450050
55x55	560	137.700	1	000450055
60x60	600	176.500	1	000450060
65x65	675	211.700	1	000450065
70x70	675	231.600	1	000450070
75x75	720	270.000	1	000450075
80x80	720	311.300	1	000450080

52

Egyoldalas villáskulcs, krómozott



UNI 6733 DIN 3114

mm	L mm	Ft		
10	119	4.490	5	000520010
11	119	4.570	5	000520011
12	119	4.740	5	000520012
13	145	5.340	5	000520013
14	145	5.470	5	000520014
15	145	5.630	5	000520015
16	159	6.070	5	000520016
17	159	6.110	5	000520017
18	159	6.520	5	000520018
19	175	7.090	5	000520019
20	175	7.570	5	000520020
21	175	7.810	5	000520021
22	196	8.790	2	000520022
23	196	9.030	2	000520023
24	196	9.230	2	000520024
25	215	10.300	2	000520025
26	215	10.500	2	000520026
27	215	10.500	2	000520027
28	240	12.350	2	000520028
30	240	12.550	2	000520030
32	270	14.950	2	000520032
34	270	16.200	1	000520034
35	295	18.600	1	000520035
36	295	18.600	1	000520036
38	295	20.850	1	000520038
40	335	25.700	1	000520040
41	335	25.700	1	000520041
42	335	28.550	1	000520042
45	370	32.800	1	000520045
46	370	32.800	1	000520046
48	370	37.850	1	000520048
50	415	44.100	1	000520050
52	415	49.400	1	000520052
55	415	51.200	1	000520055
60	490	64.950	1	000520060
65	490	66.200	1	000520065
70	490	74.900	1	000520070

Egyoldalal villáskulcs, foszfátzott



mm	L mm	Ft		
36	317	13.750	1	000530036
38	320	15.200	1	000530038
41	342	17.800	1	000530041
46	396	21.650	1	000530046
50	412	33.800	1	000530050
55	457	38.650	1	000530055
60	492	47.950	1	000530060
65	528	56.900	1	000530065
70	572	65.800	1	000530070
75	608	82.400	1	000530075
80	645	100.800	1	000530080
85	690	122.700	1	000530085
90	690	145.300	1	000530090
95	847	202.800	1	000530095
100	847	214.200	1	000530100
105	1000	267.200	1	000530105
110	1000	289.100	1	000530110
115	1000	322.300	1	000530115
120	1000	365.600	1	000530120
125	1000	422.300	1	000530125
130	1000	452.600	1	000530130
135	1000	485.400	1	000530135

Villáskulcs, krómozott



UNI-ISO 10102 DIN 3110

mm	L mm	Ft		
4x5	101	2.650	5	000550003
5x5,5	101	3.020	5	000550006
5,5x7	120	3.020	5	000550009
• 6x7	120	2.370	5	000550012
7x8	140	3.020	5	000550018
• 8x9	140	2.410	5	000550021
8x10	140	3.020	5	000550024
• 10x11	155	2.530	5	000550030
10x12	155	3.460	5	000550033
10x13	170	3.790	5	000550035
• 12x13	170	2.870	5	000550042
12x14	170	3.870	5	000550045
13x14	185	4.330	5	000550047
13x17	189	4.620	5	000550051
• 14x15	185	3.600	5	000550054
14x17	189	4.980	5	000550057
• 16x17	202	4.130	5	000550060
17x19	220	5.590	2	000550063
• 18x19	220	4.900	2	000550066
19x22	236	6.320	2	000550069
• 20x22	236	5.590	2	000550075
• 21x23	245	5.910	2	000550078
22x24	245	6.840	2	000550081
• 24x26	262	7.040	2	000550087
24x27	262	7.650	2	000550090
• 25x28	272	8.020	2	000550096
• 27x29	284	9.070	2	000550099
27x30	284	10.500	2	000550102
27x32	297	11.350	2	000550105
• 30x32	297	10.100	2	000550108
32x36	325	30.950	1	000550114
34x36	325	30.950	1	000550117
35x38	375	34.200	1	000550120
36x41	375	35.800	1	000550123
41x46	425	40.900	1	000550129
46x50	475	50.800	1	000550132
50x55	500	59.100	1	000550135
55x60	500	62.350	1	000550138



	Ft		
55/B8N	33.600	1	000550160
6x7-8x9-10x11-12x13 14x15-16x17-18x19 20x22 mm			
2002/BV8	5.180	1	020020020
55/B12N	68.050	1	000550164
6x7-8x9-10x11-12x13- 14x15-16x17-18x19- 20x22-21x23-24x26- 25x28-30x32 mm			
2002/BV12	8.580	1	020020040



	Ft		
55/S8	28.400	1	000550174
6x7-8x9-10x11-12x13 14x15-16x17-18x19 20x22 mm			
55/S12	59.450	1	000550178
6x7-8x9-10x11-12x13 14x15-16x17-18x19 20x22-21x23-24x26 25x28-30x32 mm			
55/S12X	60.050	1	000550179
6x7-8x9-10x11-12x13 14x15-16x17-18x19 20x22-21x23-24x27 25x28-30x32 mm			
55/S13	68.500	1	000550182
6x7-8x9-10x11-12x13 14x15-16x17-18x19 20x22-21x23-24x26 25x28-27x29-30x32 mm			



55/SP7



55/SP13

	Ft		
55/SP7	24.050	1	000550167
6x7-8x9-10x11-12x13 14x15-16x17-18x19 mm			
42/SPV7	3.320	1	000420097
42: 8-10-11-13-14-17-19 mm 55: 6x7-8x9-10x11-12x13 14x15-16x17-18x19 mm			
55/SP13	84.900	1	000550186
6x7-8x9-10x11-12x13 14x15-16x17-18x19 20x22-21x23-24x26 25x28-27x29-30x32 mm			
55/SPV	16.400	1	000550190



Villáskulcs, krómozott



	L mm	Ft		
1/4x9/32	120	3.160	2	000550203
1/4x5/16	120	3.160	2	000550206
5/16x11/32	140	3.400	2	000550209
5/16x3/8	140	3.400	2	000550212
3/8x7/16	155	3.680	2	000550215
7/16x1/2	170	4.050	2	000550218
1/2x9/16	170	4.330	2	000550221
9/16x5/8	185	4.780	2	000550224
19/32x11/16	189	5.830	2	000550227
5/8x11/16	202	5.830	2	000550230
5/8x3/4	202	6.560	2	000550233
11/16x13/16	220	6.800	2	000550242
3/4x7/8	236	7.330	2	000550245
25/32x13/16	236	7.330	2	000550244
7/8x15/16	245	7.940	2	000550251
15/16x1	262	10.100	1	000550257
1x1.1/8	272	10.500	1	000550259
1.1/16x1.1/4	284	13.750	1	000550267
1.1/8x1.5/16	297	13.750	1	000550266
1.5/16x1.1/2	325	36.450	1	000550269
1.3/8x1.1/2	375	40.300	1	000550272
1.7/16x1.5/8	375	40.300	1	000550275



	Ft		
55AS/5	24.550	1	000550290
5/16x11/32-3/8x7/16 1/2x9/16-5/8x11/16 3/4x7/8			
55AS/8	39.300	1	000550296
1/4x9/32-5/16x11/32-3/8x7/16- 1/2x9/16-9/16x5/8-5/8x11/16- 11/16x13/16-3/4x7/8			
55AS/12	81.000	1	000550298
1/4x9/32-5/16x11/32-3/8x7/16-1 2x9/16-9/16x5/8-5/8x11/16- 11/16x13/16-25/32x13/16-3/4x7/8- 15/16x1-1x1.1/8-1.1/16x1.1/4			

Ütővilláskulcs, horganyzott



DIN 133

	L mm	Ft		
24	177	14.550	1	000580024
27	180	15.200	1	000580027
30	190	16.800	1	000580030
32	190	17.600	1	000580032
34	200	22.050	1	000580034
36	215	22.650	1	000580036
41	235	26.900	1	000580041
46	255	36.050	1	000580046
50	275	40.500	1	000580050
55	300	48.600	1	000580055
60	320	53.250	1	000580060
65	342	69.650	1	000580065
70	375	89.850	1	000580070
75	375	98.150	1	000580075
80	408	149.400	1	000580080

mm	L mm	Ft		
85	408	167.600	1	000580085
90	445	192.700	1	000580090
95	445	198.400	1	000580095
100	485	274.500	1	000580100
*105	485	309.700	1	000580105
*110	510	338.900	1	000580110
*115	510	386.200	1	000580115
*120	545	397.600	1	000580120
*125	545	455.500	1	000580125
*130	575	617.400	1	000580130
*135	575	645.700	1	000580135
*140	575	702.400	1	000580140
*145	640	959.500	1	000580145
*150	640	998.000	1	000580150
*155	640	1.093.100	1	000580155
*160	640	1.198.400	1	000580160
*165	715	1.283.400	1	000580165
*170	715	1.749.000	1	000580170
*175	715	1.854.300	1	000580175
*180	715	2.008.100	1	000580180
*185	715	2.060.700	1	000580185
*190	800	2.267.200	1	000580190
*195	800	2.376.500	1	000580195
*200	800	2.493.900	1	000580200
*210	800	3.113.400	1	000580210
*220	800	4.012.100	1	000580220
*230	800	4.898.800	1	000580230

73

Műszerész villáskulcs, krómozott



UNI 6737

mm	L mm	Ft		
4x4	78	3.970	5	000730040
4,5x4,5	78	3.970	5	000730045
5x5	78	3.970	5	000730050
5,5x5,5	86	4.290	5	000730055
6x6	86	4.290	5	000730060
7x7	86	4.290	5	000730070
8x8	97	4.490	5	000730080
9x9	97	4.490	5	000730090
10x10	108	4.860	5	000730100
11x11	108	4.860	5	000730110
12x12	124	5.630	5	000730120
13x13	124	5.630	5	000730130
14x14	124	5.630	5	000730140



73/B13N	Ft		
4-4,5-5-5,5-6-7-8-9	65.550	1	000730202
10-11-12-13-14 mm			
2002/BV13	5.180	1	020020050



73/S13	Ft		
4-4,5-5-5,5-6-7-8-9	60.350	1	000730210
10-11-12-13-14 mm			

78

Útőcsillagkulcs, horganyzott



DIN 7444

mm	L mm	Ft		
24	162	14.550	1	000780024
27	180	17.000	1	000780027
30	190	20.050	1	000780030
32	190	21.450	1	000780032
34	200	24.500	1	000780034
36	205	26.500	1	000780036
41	225	34.200	1	000780041
46	235	38.250	1	000780046
50	250	45.350	1	000780050
55	265	51.800	1	000780055
60	275	63.150	1	000780060
65	295	79.950	1	000780065
70	325	80.350	1	000780070
75	325	95.350	1	000780075
80	350	146.200	1	000780080
85	350	159.900	1	000780085
90	390	195.500	1	000780090
95	390	226.300	1	000780095
100	420	250.200	1	000780100
105	420	295.100	1	000780105
110	450	322.300	1	000780110
115	450	366.800	1	000780115
*120	490	504.000	1	000780120
*125	480	682.200	1	000780125
*130	520	785.400	1	000780130
*135	520	842.100	1	000780135
*140	520	957.500	1	000780140
*145	580	1.206.500	1	000780145
*150	580	1.263.200	1	000780150
*155	580	1.457.500	1	000780155
*160	650	1.493.900	1	000780160
*165	650	1.587.000	1	000780165
*170	650	1.902.800	1	000780170
*175	650	2.056.700	1	000780175
*180	650	2.259.100	1	000780180
*185	695	2.327.900	1	000780185
*190	695	2.546.600	1	000780190
*195	695	2.550.600	1	000780195
*200	695	2.587.000	1	000780200
*210	740	2.761.100	1	000780210
*215	740	3.089.100	1	000780215
*220	740	3.408.900	1	000780220
*230	740	4.222.700	1	000780230

78AS

Útőcsillagkulcs



mm	L mm	Ft		
*1.1/16	180	20.450	1	000780327
*1.1/8	190	20.450	1	000780329
*1.3/16	190	20.450	1	000780330
*1.1/4	197	22.250	1	000780332
*1.5/16	197	22.850	1	000780333
*1.3/8	223	24.500	1	000780335
*1.7/16	223	29.550	1	000780336
*1.1/2	223	30.550	1	000780338
*1.5/8	223	34.800	1	000780341
*1.11/16	225	36.250	1	000780343
*1.13/16	240	40.100	1	000780346
*1.7/8	250	40.500	1	000780348
*2	250	46.350	1	000780350
*2.1/16	250	47.950	1	000780352
*2.3/16	275	50.600	1	000780355
*2.3/8	270	68.400	1	000780360
*2.9/16	302	75.700	1	000780365
*2.3/4	350	82.400	1	000780370
*2.15/16	350	95.150	1	000780375
*3.1/8	354	157.100	1	000780380

80

Kettős csuklós dugókulcs, krómozott



mm	L mm	Ft		
6x7	170	16.000	3	000800006
8x9	176	16.400	3	000800008
8x10	179	16.400	3	000800009
10x11	182	17.400	3	000800010
12x13	228	19.850	3	000800012
14x15	232	20.050	3	000800014
13x17	231	21.450	3	000800015
16x17	234	21.450	2	000800016
18x19	285	26.500	2	000800018
19x22	287	27.950	2	000800019
20x22	289	27.950	2	000800020
21x23	289	28.350	2	000800021
24x27	405	46.350	2	000800024
30x32	413	49.200	2	000800030



80/S8	Ft		
6x7-8x9-10x11-12x13-14x15	165.600	1	000800051
16x17-18x19-20x22 mm			
80/S11	289.500	1	000800056
6x7-8x9-10x11-12x13			
14x15-16x17-18x19-20x22			
21x23-24x27-30x32 mm			

83

Önindító kulcs, krómozott, az önindító csavarjainál használható



ISO 3318

mm	L mm	Ft		
8x10	126	8.140	3	000830008
10x12	137	8.540	3	000830010
11x13	138	8.790	3	000830011
14x17	183	11.150	3	000830014
15x17	184	12.550	2	000830015
16x18	196	13.550	2	000830016
19x22	231	17.400	2	000830019



83/S3	Ft		
11x13-14x17-19x22 mm	37.300	1	000830081
83/S5	60.850	1	000830085
10x12-11x13-15x17-			
16x18-19x22 mm			



"	L mm	Ft	🔧	📦
7/16x1/2	138	10.300	2	000830111
9/16x5/8	183	12.550	2	000830114
3/4x7/8	230	19.650	2	000830119



		Ft	🔧	📦
83AS/3		42.500	1	000830181
7/16x1/2-9/16x5/8 3/4x7/8				



"	L mm	Ft	🔧	📦
8x10	235	9.070	2	000880008
12x14	330	10.700	2	000880012
13x15	330	10.700	2	000880013
16x18	405	14.950	2	000880016
17x19	405	14.950	2	000880017
21x23	435	17.200	2	000880021
22x24	435	17.200	2	000880022



		Ft	🔧	📦
88/S7		94.900	1	000880107
8x10-12x14-13x15-16x18- 17x19-21x23-22x24 mm				



DIN 838 ISO 10104

"	L mm	Ft	🔧	📦
6x7	165	4.490	5	000900006
8x9	180	4.820	5	000900012
8x10	180	5.670	5	000900015
10x11	195	5.300	5	000900018
10x12	195	5.750	5	000900021
11x13	215	6.320	5	000900024
12x13	215	5.790	5	000900027
12x14	215	6.640	5	000900030
14x15	230	6.320	5	000900033
14x17	250	7.850	5	000900036
16x17	250	7.210	5	000900039
17x19	265	9.310	5	000900042
18x19	265	8.420	5	000900045
19x22	285	10.500	3	000900048
20x22	285	9.720	3	000900051
21x23	305	10.950	2	000900057
22x24	305	11.750	2	000900060
24x26	325	12.350	2	000900063
24x27	325	13.550	2	000900067
25x28	340	14.750	2	000900070
27x29	355	15.800	2	000900073
27x30	355	17.200	2	000900076
27x32	375	19.250	2	000900078
30x32	375	17.800	2	000900080
32x36	395	26.500	1	000900088
34x36	415	31.350	1	000900089
35x38	415	31.800	1	000900091
36x41	435	36.250	1	000900094
41x46	460	52.000	1	000900097
46x50	500	68.800	1	000900100



		Ft	🔧	📦
90/B8N		57.250	1	000900156
6x7-8x9-10x11-12x13- 14x15-16x17-18x19- 20x22 mm				
2002/BV8		5.180	1	020020020



		Ft	🔧	📦
90/S8		52.050	1	000900162
6x7-8x9-10x11-12x13 14x15-16x17-18x19 20x22 mm				
90/S12		107.900	1	000900166
6x7-8x9-10x11-12x13 14x15-16x17-18x19 20x22-21x23-24x26 25x28-30x32 mm				
90/S12X		109.100	1	000900167
6x7-8x9-10x11-12x13 14x15-16x17-18x19 20x22-21x23-24x27 25x28-30x32 mm				
90/S13		123.700	1	000900170
6x7-8x9-10x11-12x13 14x15-16x17-18x19 20x22-21x23-24x26 25x28-27x29-30x32 mm				



		Ft	🔧	📦
90/SP13		140.100	1	000900174
6x7-8x9-10x11-12x13 14x15-16x17-18x19 20x22-21x23-24x26 25x28-27x29-30x32 mm				
55/SPV		16.400	1	000550190



"	L mm	Ft	🔧	📦
1/4x5/16	165	5.180	2	000900203
5/16x11/32	180	5.590	2	000900206
5/16x3/8	180	5.710	2	000900209
3/8x7/16	195	5.790	2	000900212
7/16x1/2	215	6.520	2	000900215
1/2x9/16	230	7.450	2	000900218
9/16x5/8	230	7.450	2	000900221
19/32x11/16	250	8.100	2	000900222
5/8x11/16	250	8.420	2	000900224
5/8x3/4	265	9.920	2	000900227
11/16x3/4	265	9.920	1	000900230
11/16x13/16	265	9.920	1	000900233
3/4x25/32	265	11.550	1	000900235
3/4x7/8	285	11.550	1	000900237
13/16x7/8	285	11.750	1	000900240
7/8x15/16	305	11.750	1	000900243
15/16x1	325	14.150	1	000900252
1.1/16x1.1/4	375	20.450	1	000900258
1.1/8x1.5/16	375	20.650	1	000900261



		Ft	🔧	📦
90AS/8		68.250	1	000900298
1/4x5/16-5/16x11/32 3/8x7/16-1/2x9/16 5/8x11/16-11/16x3/4 13/16x7/8-15/16x1				
90AS/10		109.400	1	000900300
1/4x5/16-5/16x11/32 3/8x7/16-1/2x9/16 5/8x11/16-11/16x3/4 13/16x7/8-15/16x1 1.1/16x1.1/4-1.1/8x1.5/16				

91

Feltűző csillagkulcs, krómozott



Ø mm	Ø mm	Ft	📦	📦
24	38	25.900	1	000910024
27	41	26.700	1	000910027
30	48	28.750	1	000910030
32	49	30.950	1	000910032
36	54	35.400	1	000910036
41	62	42.100	1	000910041
46	69	49.200	1	000910046
50	76	56.050	1	000910050
55	81	62.750	1	000910055
60	90	78.350	1	000910060
65	98	87.650	1	000910065
70	105	98.600	1	000910070
75	110	113.000	1	000910075
80	125	129.600	1	000910080
85	125	135.200	1	000910085
90	140	242.100	1	000910090
95	140	265.200	1	000910095
100	143	281.000	1	000910100
105	146	314.200	1	000910105

92

Csőtoldatok a 91. típusú kulcsokhoz, krómozott



	L mm	91 mm	Ø mm	Ft	📦	📦
92/1	460	24÷30	19	15.600	1	000920010
92/2	610	32÷41	22	23.900	1	000920020
92/3	760	46÷55	25	33.800	1	000920030
92/4	860	60÷105	30	44.950	1	000920040

93

Állványozó csillagkulcs
állványcsavarokhoz, krómozott



mm	L mm	Ft	📦	📦
21x22	310	18.400	3	000930021

93C

Állványozó csillagkulcs, lapos,
speciális fejkiképzés



mm	L mm	Ft	📦	📦
17x19	310	20.850	1	000930117
19x22	310	22.450	1	000930119
19x24	365	27.550	1	000930120
21x22	310	25.100	1	000930121
36x38	445	42.300	1	000930136

94

Nyitott hollandier kulcs, krómozott



DIN 3118

Ø mm	L mm	Ft	📦	📦
8x10	140	7.850	2	000940008
9x11	153	8.140	2	000940009
10x11	153	8.580	2	000940010
11x13	175	8.870	2	000940011
12x14	175	9.390	2	000940012
13x15	175	9.390	2	000940013
14x15	175	11.150	2	000940014
14x17	195	11.350	2	000940015
17x19	212	11.550	2	000940017
19x22	228	12.350	2	000940019
22x24	242	15.200	2	000940022
24x27	260	16.400	2	000940024
30x32	300	21.450	2	000940030
36x41	320	36.450	1	000940036



	Ft	📦	📦
94/S6	58.600	1	000940050
8x10-10x11-11x13-12x14-17x19-19x22 mm			
94/S10	119.800	1	000940052
8x10-9x11-10x11-11x13-12x14-17x19-19x22-22x24-24x27-30x32 mm			

95

Egyenes csillagkulcs, krómozott



DIN 837 ISO 10103

Ø mm	L mm	Ft	📦	📦
6x7	120	5.140	3	000950161
8x9	135	5.510	3	000950162
10x11	150	6.230	3	000950163
12x13	165	6.760	3	000950164
14x15	185	7.130	3	000950165
16x17	210	7.570	3	000950166
17x19	225	8.790	3	000950167
18x19	225	8.790	2	000950168
20x22	240	9.920	2	000950169
21x23	255	10.500	2	000950170
24x26	270	11.150	2	000950171
25x28	285	13.350	2	000950172
27x29	315	13.550	2	000950173
30x32	335	15.400	2	000950174



	Ft	📦	📦
95/S8	57.050	1	000950177
6x7-8x9-10x11-12x13-14x15-16x17-18x19-20x22 mm			
95/S13	121.000	1	000950179
6x7-8x9-10x11-12x13-14x15-16x17-18x19-20x22-21x23-24x26-25x28-27x29-30x32 mm			

95FTX

Egyenes Torx® csillagkulcs,
krómozott



Ø mm	L mm	Ft	📦	📦
E6xE8	115	5.300	2	000950306
E10xE12	143	5.590	2	000950310
E14xE18	177	6.320	2	000950314
E20xE24	224	8.580	2	000950320



	Ft	📦	📦
95FTX/S4	25.800	1	000950325
E6xE8-E10xE12-E14xE18-E20xE24			



HAJLÍTOTT IMBUSZKULCSOK

A Beta imbuszkulcsait hosszú élettartamra és pontos működésre tervezték.

A széles választék minden felhasználási követelményt lefed: extra rövid, rövid, hosszú, extra hosszú, gömbfejű és T-kulcsok, valamint nagy forgatónyomatékot biztosító markolattal ellátott kulcsok. Mindezek a Beta legfontosabb termékei közé tartoznak, valamint egyedülállóak a piacon.

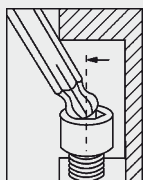

A gömbfejnek köszönhetően a hajlított imbuszkulcs a csavar tengelyéhez képest 30°-ban is használható.

A kulcsok a szükséges méret gyors azonosítása érdekében kihajtható tartóba vannak csomagolva. Bezárt állapotban megakadályozza, hogy a kulcsok, beleértve a kisebbeket is, véletlenül kiessenek.

A színes változat a standard kulcsok kiemelkedő tulajdonságait ötvözi azzal, hogy a szükséges méret azonnal felismerhető, és így a napi munka felgyorsítható.

96

Hajlított imbuszkulcs, krómozott



ISO 2936

mm	L	L1	Ft	🔧	📦
0,9	35	8	455	20	000960013
1,3	39	10	455	20	000960014
1,5	45	15	455	20	000960015
2	50	17	480	20	000960020
2,5	57	20	480	20	000960025
3	64	22	565	20	000960030
3,5	68	25	670	20	000960035
4	72	28	705	20	000960040
4,5	78	30	725	20	000960045
5	83	32	755	20	000960050
5,5	88	35	945	20	000960055
6	94	37	945	20	000960060
7	99	40	1.170	10	000960070
8	105	43	1.380	10	000960080
9	111	46	1.620	10	000960090
10	119	49	1.940	10	000960100
11	126	52	2.430	10	000960110
12	134	56	2.910	10	000960120
13	142	62	3.720	10	000960130
14	151	69	4.370	10	000960140
16	165	75	6.400	5	000960160
17	174	79	6.720	5	000960170
19	196	88	9.390	5	000960190
22	216	100	14.750	3	000960220
24	242	112	19.450	1	000960240
27	271	125	25.700	1	000960270
30	309	140	34.600	1	000960300
32	341	155	45.350	1	000960312
36	385	174	65.400	1	000960316



96/ST6
2,5-3-4-5-6-8 mm

Ft 6.530
🔧 3 📦 000960370



96/BGS7
1,5-2-2,5-3-4-5-6 mm

Ft 14.550
🔧 1 📦 000960367



96/BG7
2,5-3-4-5-6-8-10 mm

Ft 15.400
🔧 1 📦 000960368



	Ft	🔧	📦
96/B8 2-2,5-3-4-5-6-8-10 mm	8.140	5	000960386
96/B10 1,5-2-2,5-3-4-5-6-8-10-12 mm	11.500	5	000960380
96N/BV	885	1	000960651



	Ft	🔧	📦
96/SC9 1,5-2-2,5-3-4-5-6-8-10 mm	9.690	1	000960374
96/SCV	1.980	1	000960985



	Ft	🔧	📦
96/SC12 2-2,5-3-3,5-4-4,5-5-6-7-8-9-10 mm	13.800	1	000960395
96/SCV12	2.370	1	000960975

96N

Hajlított imbuszkulcs, barnított



ISO 2936

mm	L mm	L1 mm	Ft	🔧	📦
0,9	32	10	225	20	000960409
1,3	44	12	225	20	000960413
1,5	46	15	240	20	000960415
2	51	17	255	20	000960420
2,5	57	20	265	20	000960425
3	64	22	295	20	000960430
3,5	68	25	350	20	000960435
4	72	28	400	20	000960440
4,5	78	30	435	20	000960445
5	83	32	455	20	000960450
6	94	37	575	20	000960460
7	99	40	765	10	000960470
8	105	43	905	10	000960480
9	111	46	1.190	10	000960490
10	119	49	1.400	10	000960500
11	126	52	1.740	10	000960510
12	134	56	2.130	10	000960520
13	142	62	2.830	10	000960530
14	151	69	3.180	10	000960540
16	165	72	4.820	5	000960560
17	174	79	5.180	5	000960570
19	194	88	7.000	5	000960590
22	216	99	12.950	1	000960592
24	242	111	17.000	1	000960594



96N/ST6 Ft 4.600 3 000960640
2,5-3-4-5-6-8 mm



96N/G7 Ft 11.950 3 000960645
2,5-3-4-5-6-8-10 mm
96N/G7A Ft 8.420 3 000960643
1,5-2-2,5-3-4-5-6 mm



96N/B10 Ft 7.800 5 000960650
1,5-2-2,5-3-4-5-6
8-10-12 mm
96N/BV 885 1 000960651



96N/SC9 Ft 6.770 1 000960644
1,5-2-2,5-3-4-5-6-8-10 mm
96N/SCV 1.980 1 000960986



96N/SC12 Ft 9.660 1 000960661
2-2,5-3-3,5-4-4,5-5
6-7-8-9-10 mm
96N/SCV12 2.370 1 000960976



96C-AS/SC9 Ft 16.450 1 000961753
1/16-3/32-1/8-5/32-3/16-
7/32-1/4-5/16-3/8

96AS
Hajlított imbuszkulcs, barnított



"	L mm	L1 mm	Ft	🔧	📄
1/30 (0,035")	44	14	405	20	000960698
1/20 (0,050")	44	15	405	20	000960701
1/16	46	16	435	20	000960702
5/64	50	18	540	20	000960704
3/32	53	19	620	20	000960706
7/64	57	21	635	20	000960708
1/8	60	22	645	20	000960710
9/64	64	24	770	20	000960712
5/32	68	25	795	20	000960714
3/16	75	29	885	20	000960716
7/32	82	32	990	20	000960718
1/4	89	35	1.160	20	000960720
5/16	103	40	1.460	10	000960724
3/8	117	44	1.760	10	000960728
7/16	132	49	2.570	10	000960730
1/2	149	54	3.240	10	000960732
9/16	151	69	5.300	2	000960734



96AS/SC9 Ft 10.750 1 000960743
1/16-3/32-1/8-5/32-3/16
7/32-1/4-5/16-3/8
96AS/SCV 1.980 1 000960744



96AS/T7 Ft 8.710 3 000960740
3/32-1/8-5/32
3/16-7/32-1/4-5/16



96AS/BG7 Ft 15.400 1 000960747
3/32-1/8-5/32-3/16
1/4-5/16-3/8



96AS/B11 Ft 10.600 1 000960749
1/20-1/16-5/64-3/32
1/8-5/32-3/16-7/32
1/4-5/16-3/8
96N/BV 885 1 000960651

96LC
Hajlított hosszú imbuszkulcs, krómózott



ISO 2936

mm	L mm	L1 mm	Ft	🔧	📄
2	101	17	860	20	000960320
2,5	113	20	925	20	000960321
3	127	22	1.010	20	000960322
3,5	138	25	1.030	20	000960323
4	142	28	1.120	20	000960324
4,5	154	28	1.320	20	000960325
5	163	32	1.420	20	000960326
6	184	37	1.540	20	000960327
7	194	40	1.760	10	000960328
8	205	43	2.170	10	000960329
9	216	46	2.390	10	000960330
10	231	49	3.100	10	000960331
12	259	56	3.830	10	000960332



96LC/SC8 Ft 14.100 1 000960334
2-2,5-3-4-5-6-8-10 mm
96LC/SCV 1.980 1 000960983



96LC/SC12 Ft 21.000 1 000960337
2-2,5-3-3,5-4-4,5-5
6-7-8-9-10 mm
96LC/SCV12 2.370 1 000960977



96L

Hajlított hosszú imbuszkulcs, barnított



ISO 2936

mm	L mm	L1 mm	Ft	📦	🚚
2	99	15	610	20	000960820
2,5	110	17	630	20	000960825
3	124	19	715	20	000960830
3,5	135	21	770	20	000960835
4	138	24	855	20	000960840
4,5	150	25	990	20	000960845
5	158	27	1.050	20	000960850
6	178	31	1.190	20	000960860
7	187	33	1.520	10	000960870
8	197	35	1.920	10	000960880
9	207	37	2.150	10	000960890
10	221	39	2.850	10	000960900
12	247	44	3.680	10	000960920



	Ft	📦	🚚
96L/SC8 2-2,5-3-4-5-6-8-10 mm	11.800	1	000960924
96L/SCV	1.980	1	000960987



	Ft	📦	🚚
96L/SC12 2-2,5-3-3,5-4-4,5-5-6-7-8-9-10 mm	17.600	1	000960929
96L/SCV12	2.370	1	000960978

96BP-CL

gömbfejű hajlított imbuszkulcskészlet, krómozott, színezett



mm	L mm	L1 mm	Ft	📦	🚚
1,5	91	16	1.360	5	000961600
2	102	17	1.520	5	000961601
2,5	113	21	1.680	5	000961602
3	128	23	1.860	5	000961603
4	143	28	2.060	5	000961604
5	163	33	2.250	5	000961605
6	185	37	2.870	5	000961606
8	206	43	3.930	2	000961608
10	231	50	5.180	2	000961610



	Ft	📦	🚚
96BP-CL/SC9 1,5-2-2,5-3-4-5-6-8-10 mm	24.700	1	000961619
96BP-CL/SCV	1.980	1	000961629

96BPC

Hajlított gömbfejű imbuszkulcs, krómozott

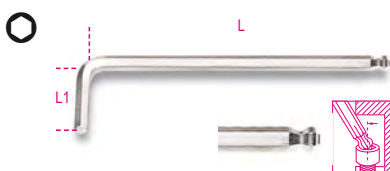

mm	L mm	L1 mm	Ft	📦	🚚
1,5	79	13	1.020	10	000960340
2	84	15	1.070	10	000960341
2,5	89	17	1.130	10	000960342
3	99	19	1.210	10	000960343
4	108	24	1.380	10	000960344
5	126	27	1.680	10	000960345
6	148	31	2.390	10	000960346
7	157	33	3.140	5	000960353
8	168	35	3.180	5	000960347
10	187	39	5.180	5	000960348
12	220	55	6.640	5	000960352



	Ft	📦	🚚
96BPC/SC9 1,5-2-2,5-3-4-5-6-8-10 mm	20.200	1	000960354
96BPC/SCV	1.980	1	000960984

96BP

Hajlított gömbfejű imbuszkulcs, barnított

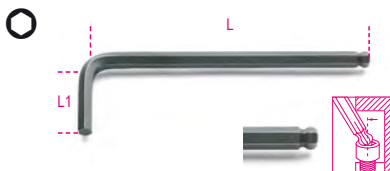

mm	L mm	L1 mm	Ft	📦	🚚
1,5	79	13	770	10	000960960
2	84	15	825	10	000960961
2,5	89	17	855	10	000960962
3	99	19	885	10	000960963
4	108	24	1.020	10	000960965
5	126	27	1.360	10	000960967
6	148	31	1.940	10	000960968
8	168	35	2.790	5	000960970
10	187	39	4.740	5	000960972
12	220	55	7.040	5	000960973



	Ft	📦	🚚
96BP/SC9 1,5-2-2,5-3-4-5-6-8-10 mm	17.150	1	000960974
96BP/SCV	1.980	1	000960988

96BP-HO/SC9

9 darabos gömbfejű hajlított imbuszkulcs készlet, csavar megtartó véggel



	Ft	📦	🚚
96BP-HO/SC9 1,5-2-2,5-3-4-5-6-8-10 mm	21.850	1	000961254

96LBP

Hajlított gömbfejű imbuszkulcs extra hosszú kivitel

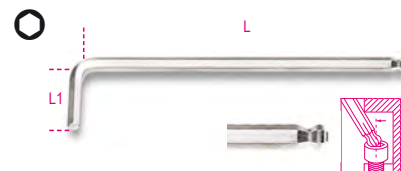

mm	L mm	L1 mm	Ft	📦	🚚
1,5	90	15	1.190	5	000961340
2	100	17	1.260	5	000961341
2,5	112	20	1.320	5	000961342
3	127	22	1.380	5	000961343
4	144	27	1.700	5	000961344
5	163	32	2.020	5	000961345
6	184	37	2.810	5	000961346
8	204	44	3.850	2	000961348
10	230	49	6.150	2	000961350



	Ft	📦	🚚
96LBP/SC9 1,5-2-2,5-3-4-5-6-8-10 mm	23.650	1	000961354
96LBP/SCV	1.980	1	000961984



96BP/AS

Hajlított gömbfejű imbuszkulcs,
barnított

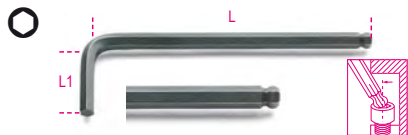

"	L mm	L1 mm	Ft		
3/32	89	17	935	10	000960989
1/8	98	18	990	10	000960990
5/32	108	24	1.190	10	000960991
3/16	126	26	1.360	10	000960992
7/32	139	28	1.960	10	000960993
1/4	152	31	2.150	10	000960994
5/16	168	34	2.830	5	000960995
3/8	190	39	4.700	5	000960996



	Ft		
96BP-AS/SC9 1/16-3/32-1/8-5/32-3/16 7/32-1/4-5/16-3/8	18.550	1	000961000
96BP-AS/SCV	1.980	1	000961001



	Ft		
96BP-AS/8 3/32-1/8-5/32-3/16-7/32 1/4-5/16-3/8	17.000	1	000960997
96BP-AS/BV	885	1	000960998

96BPA

110°-ban hajlított gömbfejű imbuszkulcs,
extra rövid kivitel



mm	L mm	L1 mm	Ft		
1,5	71	9	1.110	5	000961960
2	86	11	1.160	5	000961961
2,5	96	13	1.210	5	000961962
3	104	15	1.320	5	000961963
4	116	17	1.580	5	000961964
5	132	19	1.900	5	000961965
6	155	21	2.730	5	000961966
8	176	24	3.620	2	000961968
10	200	27	5.670	2	000961970



	Ft		
96BPA/SC9 1,5-2-2,5-3-4-5-6-8-10 mm	22.250	1	000961974
96BPA/SCV	1.980	1	000961988

96T HAJLÍTOTT IMBUSZKULCSOK NAGY FORGATÓNYOMATÉKOT BIZTOSÍTÓ MARKOLATTAL

Gyorsan és könnyen kezelhető

A tökéletesen kiegyensúlyozott, kis méretű
markolat könnyedén fog a tenyérben.

Az ergonomikus forma rendkívül nagy
forgatónyomatékokat biztosít.

A hatszög alakú végeket úgy tervezték,
hogy a lehető legnagyobb nyomatékokat
továbbítsák a csavarra.

A kerek test a hatszögűhöz képest
homogénebb vázzal rendelkezik, és
fokozott szilárdságot biztosít.



A test áthalad a markolaton

96T

T-szárú imbuszkulcs,
műanyag markolattal

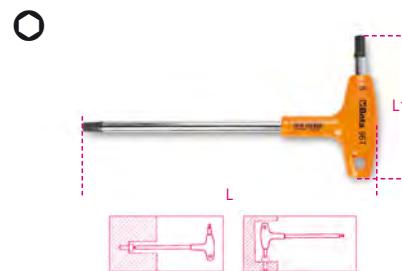

mm	L mm	L1 mm	Ft		
2	139	52	5.300	5	000960934
2,5	153	55	5.300	5	000960935
3	153	55	5.590	5	000960936
3,5	179	70	5.750	5	000960937
4	179	70	5.750	5	000960938
4,5	200	84	5.870	5	000960939
5	200	84	5.870	5	000960940
6	221	103	6.720	5	000960941
7	236	106	7.410	3	000960942
8	255	117	8.580	3	000960943
10	285	132	9.880	3	000960945



	Ft		
96T/S5P 2,5-3-4-5-6 mm	29.250	1	000960946
96T/S6 2-2,5-3-4-5-6 mm	34.550	1	000960952
96T/S8 2-2,5-3-4-5-6-8-10 mm	53.000	1	000960933
96T/S11 2-2,5-3-3,5-4-4,5-5-6-7-8-10 mm	72.000	1	000960951



	Ft		
96T/SP11 2-2,5-3-3,5-4-4,5-5 6-7-8-10 mm	89.850	1	000960957
96T/SPV 96T/S11 97TTX/S11	20.050	1	000960958

96T/AS

T-szárú imbuszkulcs

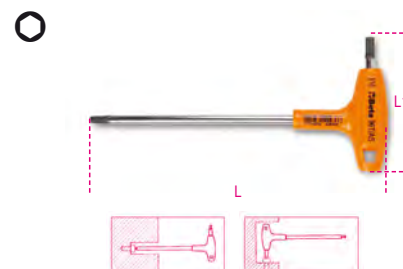

"	L mm	L1 mm	Ft		
3/32	153	55	6.600	2	000960669
7/64	153	55	6.600	2	000960670
1/8	179	70	6.680	2	000960671
9/64	179	70	7.000	2	000960672
5/32	200	84	7.000	2	000960673
3/16	200	84	7.000	2	000960674
7/32	221	103	7.810	2	000960675
1/4	236	106	8.660	2	000960676
5/16	255	117	9.880	2	000960678
3/8	285	132	11.750	2	000960680



	Ft		
96T/AS8 3/32-7/64-1/8-5/32-3/16- 1/4-5/16-3/8	64.150	1	000960682
96T/AS10 3/32-7/64-1/8-9/64-5/32 3/16-7/32-1/4-5/16-3/8	79.000	1	000960683

96TBP

T-szárú imbuszkulcs műanyag markolattal



mm	L mm	L1 mm	Ft	📦	🏠
2,5	153	55	5.590	3	000960685
3	153	55	5.830	3	000960686
4	179	70	6.150	3	000960687
5	200	84	6.400	3	000960688
6	221	103	7.000	3	000960689
8	255	117	9.270	2	000960690
10	285	132	9.880	2	000960692



96TBP/S6	Ft	📦	🏠
2,5-3-4-5-6-8 mm	40.250	1	000960694

97TX

Hajlított Torx®-imbuszkulcs, barnított



🌀	L mm	L1 mm	Ft	📦	🏠
T6	42	16	2.960	5	000970006
T7	48	16	2.960	5	000970007
T8	48	16	2.960	5	000970008
T9	48	16	3.260	5	000970009
T10	51	17	3.320	5	000970010
T15	54	18	3.320	5	000970015
T20	57	19	3.540	5	000970020
T25	60	20	3.620	5	000970025
T27	64	21	3.970	5	000970027
T30	70	24	3.970	5	000970030
T40	76	26	4.410	5	000970040
T45	83	29	5.300	5	000970045
T50	95	32	6.070	5	000970050
T55	108	35	7.690	5	000970055
T60	120	38	10.100	5	000970060



97TX/ST8	Ft	📦	🏠
T9-T10-T15-T20-T25-T27-T30-T40	31.900	1	000970640



97TX/G8	Ft	📦	🏠
T9-T10-T15-T20-T25-T27-T30-T40	24.900	1	000970645



97TX/BG8	Ft	📦	🏠
T9-T10-T15-T20-T25-T27-T30-T40	19.850	1	000970368



97TX/SC8	Ft	📦	🏠
T9-T10-T15-T20-T25-T27-T30-T40	31.400	1	000970064
97TX/SCV	1.980	1	000970985



97TX/B13	Ft	📦	🏠
T6-T7-T8-T9-T10-T15-T20-T25-T27-T30-T40-T45-T50	50.550	1	000970650
96N/BV	885	1	000960651

97BTX

Hajlított gömbfejű Torx®-imbuszkulcs, barnított

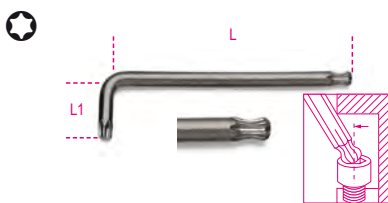

🌀	L mm	L1 mm	Ft	📦	🏠
T9	62	16	3.770	5	000970109
T10	71	17	3.770	5	000970110
T15	81	18	3.770	5	000970115
T20	92	19	4.050	5	000970120
T25	94	20	4.330	5	000970125
T27	105	21	4.570	5	000970127
T30	114	24	4.620	5	000970130
T40	129	26	5.340	5	000970140
T45	133	28	6.280	5	000970145



97BTX/SC8	Ft	📦	🏠
T9-T10-T15-T20-T25-T27-T30-T40	36.200	1	000970164
97BTX/SCV	1.980	1	000970983



97BTX/B8	Ft	📦	🏠
T9-T10-T15-T20-T25-T27-T30-T40	35.100	1	000970159
96N/BV	885	1	000960651



97BTX-C/SC8	Ft	📦	🏠
T9-T10-T15-T20-T25-T27-T30-T40	40.100	1	000971658
97BTX-C/SCV	1.980	1	000971659

97BTXL

hajlított bitkulcs egyik vége gömbölyű, hosszú kivétel
Torx® csavarokhoz



🌀	L mm	L1 mm	Ft	📦	🏠
T9	80	15	3.970	3	000970309
T10	86	17	3.970	3	000970310
T15	100	18	3.970	3	000970315
T20	110	19	4.530	3	000970320
T25	126	20	4.980	3	000970325
T27	140	24	5.630	3	000970327
T30	160	28	5.830	3	000970330
T40	176	32	6.960	3	000970340



97BTXL/SC8	Ft	📦	🏠
T9-T10-T15-T20-T25-T27-T30-T40	41.800	1	000970364
97BTXL/SCV	1.980	1	000970982

97RTX

Hajlított Tamper Resistant Torx®
imbuszkulcs



Ø	L mm	L1 mm	Ft	🔧	📄
T6	40	15	3.580	5	000970206
T7	45	15	3.580	5	000970207
T8	50	16	3.580	5	000970208
T9	56	16	3.580	5	000970209
T10	62	17	3.580	5	000970210
T15	72	17	3.580	5	000970215
T20	83	18	3.680	5	000970220
T25	90	18	3.790	5	000970225
T27	100	20	4.250	5	000970227
T30	105	24	4.290	5	000970230
T40	112	26	4.740	5	000970240
T45	118	26	5.590	5	000970245
T50	122	28	7.170	3	000970250
T55	128	30	8.260	3	000970255



97RTX/SC8	Ft	🔧	📄
T9-T10-T15-T20-T25 T27-T30-T40	33.500	1	000970263
97RTX/SCV	1.980	1	000970984



97RTX/B8	Ft	🔧	📄
T9-T10-T15-T20-T25 T27-T30-T40	32.400	1	000970260
96N/BV	885	1	000960651

97BRTLX/SC8

8 részes hajlított gömbfejű imbuszkulcskészlet,
hosszú modell,
Tamper Resistant Torx® csavarokhoz



97BRTLX/SC8	Ft	🔧	📄
T9-T10-T15-T20- T25-T27-T30-T40	42.300	1	000970464
97BRTLX/SCV	1.980	1	000970986

97TTX

T-szárú Torx®-imbuszkulcs,
műanyag markolattal, krómozott,
fekete hegyek

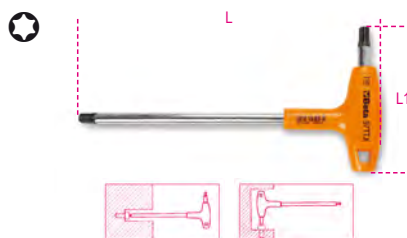

Ø	L mm	L1 mm	Ft	🔧	📄
T6	130	52	5.470	3	000970706
T7	130	52	5.470	3	000970707
T8	139	52	5.510	3	000970708
T9	139	52	5.510	3	000970709
T10	179	70	5.670	3	000970710
T15	179	70	6.110	3	000970715
T20	179	70	6.320	3	000970720
T25	179	70	6.720	3	000970725
T27	200	84	7.410	3	000970727
T30	200	84	7.650	3	000970730
T40	221	103	9.070	3	000970740
T45	236	106	10.700	2	000970745
T50	255	117	13.550	2	000970750



97TTX/S6	Ft	🔧	📄
T10-T15-T20-T25-T30-T40	41.550	1	000970791
97TTX/S8	54.450	1	000970808
T8-T10-T15-T20-T25- T27-T30-T40			
97TTX/S11	84.250	1	000970800
T8-T9-T10-T15-T20-T25 T27-T30-T40-T45-T50			
97TTX/S13	95.200	1	000970813
T6-T7-T8-T9-T10-T15-T20-T25 T27-T30-T40-T45-T50			



97TTX/SP11	Ft	🔧	📄
T8-T9-T10-T15-T20-T25 T27-T30-T40-T45-T50	102.100	1	000970840
96T/SPV	20.050	1	000960958
96T/S11			
97TTX/S11			

98XZN

XZN®-profilú imbuszkulcs,
nikkelezett



DIN 65253

Ø	L mm	L1 mm	Ft	🔧	📄
M5	83	25	2.570	5	000980005
M6	89	30	2.940	5	000980006
M8	97	32	3.720	5	000980008
M10	106	35	4.900	5	000980010
M12	116	37	6.190	5	000980012



98XZN/B5	Ft	🔧	📄
M5-M6-M8-M10-M12	21.200	1	000980650
96N/BV	885	1	000960651

99

Körmöskulcs az UNI/ISO 2982, 2983 szerinti
hornyos anyához, krómozott



UNI 6752

Ø mm	A mm	Ft	🔧	📄
12-14	1,5	4.940	3	000990012
16-18-20	1,8	4.940	3	000990016
22-25-28	1,8	6.600	3	000990022
30-32	2,1	6.600	3	000990030
34-36-38	2,4	8.020	3	000990034
40-42	2,4	8.020	3	000990040
45-50	2,5	9.920	3	000990045
52-55-58	2,5	9.920	3	000990052
62-65	3,1	12.550	3	000990062
68-70-75	3,1	12.550	3	000990068
80-85-90	3,8	16.800	2	000990080
92-95	4,3	16.800	2	000990092
98-100	4,3	16.800	2	000990098
105-110-115	4,4	26.500	1	000990105
120-125-130	4,9	26.500	1	000990120
135-145	6,0	39.050	1	000990135
155-165	6,0	39.050	1	000990155

99SQ

Állítható körmöskulcs,
krómozott



Ø mm	S mm	Ft	🔧	📄
15-35	5,1	13.350	2	000990215
35-50	6,0	15.200	2	000990235
50-80	8,0	19.850	2	000990250
80-120	8,3	27.100	2	000990280
120-180	10,8	36.250	2	000990290

99ST

Állítható csapos körmőskulcs, krómozott



mm	Ø mm	B mm	Ft	🔧	📦
15-35	3,0	2,5	13.550	2	000990315
35-50	4,0	4,5	16.000	2	000990335
50-80	5,0	5,0	21.450	2	000990350
80-120	6,0	7,0	29.150	2	000990380
120-180	8,0	9,0	37.850	2	000990390

99 VN/...

Tartalék csapok a 99ST-hez

mm	Ø mm	Ft	🔧	📦
99ST VN/15	15-35	3.740	1	000990295
99ST VN/35	35-50	4.290	1	000990296
99ST VN/50	50-80	5.300	1	000990297
99ST VN/80	80-120	6.110	1	000990298
99ST VN/120	120-180	8.020	1	000990299

100

Állítható homlokoldali csapos körmőskulcs, krómozott, barnított csapok



Ø mm	L mm	Ø mm	Ft	🔧	📦
4,8-5,8	250	18÷100	69.650	1	001000001
6,9-7,9					

100/KIT

Tartalék csapok, barnított

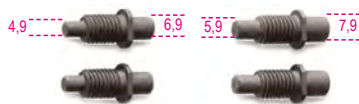

100/KIT	Ft	🔧	📦
	21.450	1	001000010



111E ÁLLÍTHATÓ VILLÁSKULCS SKÁLÁVAL

A Beta 111E új, állítható, mérőskálával ellátott villáskulcsa fokozatmentesen állítható, így a befogó pófák különböző méretű csavarokhoz méretezhetők.

A 15°-ban elforgatott fejnek köszönhetően a nehezen hozzáférhető helyeket is elérhetjük, mint az ikonikus "42" csillag-villáskulcsunkkal



Szélesre nyitható befogó pófák

Kompakt fej teljesen nyitott pófával

Kettős lézeres skála: mm/coll



Az új ergonomikus kivitel 20%-kal könnyebb.

A nagy szilárdságú ötvöztött acél fokozott csavaroszilárdságot biztosít.

A speciális hőkezelés kiemelkedő kopásállóságot biztosít.

A markolaton kialakított lyuknál felakasztható.

111E

állítható villáskulcs skálával, krómozott

- Jobbmenetes orsó
- Mm/coll skála



DIN 3117 ISO 6787

L mm	L "	A max mm	Ft	🔧	📦
100	4	15	11.550	3	001110110
150	6	24	11.950	3	001110115
200	8	29	14.750	3	001110120
250	10	34	17.800	3	001110125
300	12	40	23.700	3	001110130
380	15	45	46.350	3	001110138
450	18	54	77.100	2	001110145
600	24	62	106.500	1	001110160



111E/D3	Ft	🔧	📦
150-200-250 mm	44.550	1	001110163

111EN

állítható villáskulcs skálával, foszfátzott

- Balmenetes orsó
- Mm/coll skála



DIN 3117 ISO 6787

L mm	L "	A max mm	Ft	🔧	📦
100	4	15	10.500	3	001110410
150	6	24	11.150	3	001110415
200	8	29	12.950	3	001110420
250	10	34	16.000	3	001110425
300	12	40	21.650	3	001110430
380	15	45	42.700	3	001110438
450	18	54	72.850	2	001110445

111ER

állítható villáskulcs megfordítható pófával, skálával, krómozott

- Megfordítható pofa
- Jobbmenetes orsó
- Mm/coll skála



L mm	L "	A max mm	Ø max	Ft	🔧	📦
200	8	29	3/4	15.400	3	001110520
250	10	34	1	19.000	3	001110525
300	12	40	1.1/4	24.700	2	001110530



111CM

széles nyílású állítható villáskulcs, krómozott, rövid sorozat

- Széles nyílás
- Jobbmenetes állítás
- Mm/coll skála



L mm	L mm	A max mm	Ft	🔧	📄
170	6	32	17.600	2	001110770
220	8	38	21.450	3	001110722
270	10	46	28.350	3	001110727

120

Nyitható racsnis hollandier kulcs, krómozott, barnított fejfel

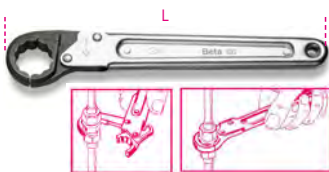

Ø mm	L mm	Ft	🔧	📄
10	135	22.050	1	001200010
11	135	22.050	1	001200011
12	135	22.050	1	001200012
13	135	22.050	1	001200013
14	135	24.900	1	001200014
17	185	26.900	1	001200017
19	185	28.750	1	001200019
22	230	39.050	1	001200022
24	230	41.900	1	001200024
27	230	53.250	1	001200027
30	320	60.300	1	001200030
32	320	63.950	1	001200032



Model	Ft	🔧	📄
120/B6N 10-11-13 17-19-22 mm	166.100	1	001200060
2002/BVL6	5.180	1	020020010



123E1/4

Adapter 1/4" 10 mm-es racsniskulcshoz

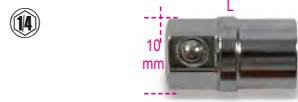

Ø mm	L mm	Ft	🔧	📄
10	20,6	2.890	1	001230010

123Q1/4

Adapter gyorscsatlakozóval 1/4" 10 mm-es racsniskulcshoz



Ø mm	L mm	Ft	🔧	📄
10	17,5	4.010	1	001230310

123Q3/8

Adapter gyorscsatlakozóval 3/8" 13 mm-es racsniskulcshoz



Ø mm	L mm	Ft	🔧	📄
13	22,5	4.050	1	001230313

123Q1/2

Adapter gyorscsatlakozóval 1/2" 19 mm-es racsniskulcshoz



Ø mm	L mm	Ft	🔧	📄
19	30,5	4.330	1	001230319

123/K4

adapterkészlet racsnis csillagkulcshoz, 4 darabos:

- 1 bit adapter
- 3 adapter gyorscsatlakozóval



Model	Ft	🔧	📄
123/K4	15.300	1	001230504

141

egyenes, rövid csillag-villáskulcs racsnival



ISO 21982:2020

mm	L mm	Ft	🔧	📄
8x8	136	7.250	3	001410008
9x9	143	7.570	3	001410009
10x10	160	7.810	3	001410010
11x11	168	7.940	3	001410011
12x12	174	8.260	3	001410012
13x13	180	8.950	3	001410013
14x14	193	9.350	2	001410014
15x15	200	9.760	2	001410015
16x16	216	10.700	2	001410016
17x17	233	11.150	2	001410017
18x18	239	11.550	2	001410018
19x19	250	11.750	2	001410019



Model	Ft	🔧	📄
141/B6 8-10-13-14-17-19 mm	60.250	1	001410066
141/B9 8-10-11-12-13-14-15-17-19 mm	87.000	1	001410069



Model	Ft	🔧	📄
141/S12 8-9-10-11-12-13- 14-15-16-17-18-19 mm	112.000	1	001410072



142 -ES TÍPUSÚ RACSNIS KULCSOK

A 72-fogas racsni legfeljebb 5°-os felvételi szögét biztosítja, ezáltal biztosítja a csavarok gyors, pontos meghúzását.

1 A hosszú száron elhelyezett fix befogó lehetővé teszi a csavarok erős meghúzását.

2 A beépített irányváltó pöcök segít elkerülni a véletlen irányváltást.



3 A tizenkétszögű gyűrű vége 15°-os szöglet zár be a kéz védelme és a könnyebb hozzáférés érdekében.

4 A fix fej 15°-os szöglet zár be a tengellyel, így kisebb a felvételi szög.



	Ft		
142/B6 8-10-13-14-17-19 mm	68.750	1	001420066
142/BV6	4.010	1	001420076
142/B9 8-10-11-12-13-14-15-17-19 mm	99.850	1	001420069
142/BV9	4.820	1	001420079



	Ft		
142/S15 6-7-8-9-10-11-12-13 14-15-16-17-18-19-22 mm	164.000	1	001420074
142/S17 6-7-8-10-11-12-13-14-15- 16-17-18-19-21-22-24-27 mm	225.500	1	001420068
142/S19 6-7-8-9-10-11-12 13-14-15-16-17-18 19-22-24-27-30-32 mm	290.300	1	001420075

142/SC9I-E

9 darabos csillag-villáskulcs-készlet, racsnival, kompakt tartóval



	Ft		
142/SC9I 8-10-11-12-13-14-15-17-19 mm	98.850	1	001420087
142/SCV9I	4.700	1	001420103
142/SC9E 8-10-11-12-13-16-17-18-19 mm	102.700	1	001420088
142/SCV9E	4.700	1	001420104

142MC

csillag-villáskulcs irányváltós racsnival, színezett



ISO 21982:2020

mm	L mm	Ft		
8x8	136	8.620	3	001422008
10x10	159	9.430	3	001422010
11x11	168	9.680	3	001422011
12x12	174	10.100	3	001422012
13x13	180	10.700	3	001422013
14x14	190	11.350	2	001422014
15x15	200	11.750	2	001422015
16x16	216	13.150	2	001422016
17x17	233	13.350	2	001422017
18x18	239	13.950	2	001422018
19x19	248	14.550	2	001422019



	Ft		
142MC/SC9I 8-10-11-12-13-14-15-17-19 mm	103.400	1	001422087
142MC/SC9E 8-10-11-12-13-16-17-18-19 mm	107.500	1	001422088

142AS

Csillag-villáskulcs irányváltós racsnival



mm	L mm	Ft		
5/16x5/16	136	9.680	2	001420308
3/8x3/8	159	9.880	2	001420310
7/16x7/16	168	10.500	2	001420311
1/2x1/2	180	11.750	2	001420313
9/16x9/16	190	11.950	2	001420314
5/8x5/8	216	13.350	2	001420316
11/16x11/16	233	13.550	2	001420317
3/4x3/4	248	14.950	2	001420319



	Ft		
142AS/8 5/16-3/8-7/16-1/2 9/16-5/8-11/16-3/4	95.650	1	001420330

142

Csillag-villáskulcs irányváltós racsnival



ISO 21982:2020

mm	L mm	Ft		
6x6	136	7.940	3	001420006
7x7	136	7.940	3	001420007
8x8	136	8.180	3	001420008
9x9	143	8.790	3	001420009
10x10	159	8.990	3	001420010
11x11	168	9.310	3	001420011
12x12	174	9.640	3	001420012
13x13	180	10.300	3	001420013
14x14	190	10.700	2	001420014
15x15	200	11.350	2	001420015
16x16	216	12.350	2	001420016
17x17	233	12.750	2	001420017
18x18	239	13.550	2	001420018
19x19	248	13.750	2	001420019
21x21	285	17.800	1	001420021
22x22	285	18.400	1	001420022
24x24	325	21.450	1	001420024
27x27	355	30.950	1	001420027
30x30	420	36.250	1	001420030
32x32	420	37.650	1	001420032
34x34	482	52.650	1	001420034
36x36	482	53.050	1	001420036
38x38	482	54.050	1	001420038



142C

Egyenes, rövid csillag-villáskulcs racsnival



ISO 21982:2020

Ø mm	L mm	Ft	🔧	📄
8x8	88	5.910	2	001420108
9x9	96	5.910	2	001420109
10x10	96	6.150	2	001420110
11x11	100	6.560	2	001420111
12x12	104	6.960	2	001420112
13x13	108	7.250	2	001420113
14x14	114	7.570	2	001420114
15x15	118	7.850	2	001420115
16x16	122	8.060	2	001420116
17x17	128	8.790	2	001420117
18x18	132	9.430	2	001420118
19x19	138	9.680	2	001420119



	Ft	🔧	📄
142C/A12 8-9-10-11-12-13-14 15-16-17-18-19 mm	101.900	1	001420175

142SN

Csuklós racsnis csillag-villáskulcs



ISO 21982:2020

Ø mm	L mm	Ft	🔧	📄
7x7	136	9.510	2	001420207
8x8	136	9.880	2	001420208
9x9	143	10.300	2	001420209
10x10	160	10.950	2	001420210
11x11	168	11.350	2	001420211
12x12	174	11.750	2	001420212
13x13	180	12.750	2	001420213
14x14	193	13.150	2	001420214
15x15	200	13.750	2	001420215
16x16	216	14.750	2	001420216
17x17	233	14.950	2	001420217
18x18	239	16.000	2	001420218
19x19	250	16.200	2	001420219
22x22	285	19.450	1	001420222
24x24	325	21.650	1	001420224



	Ft	🔧	📄
142SN/S13 7-8-9-10-11-12-13-14 15-16-17-18-19 mm	165.300	1	001420263

187

Csuklós csillagkulcs, nyitható



Ø mm	L mm	Ft	🔧	📄
8x9	125	15.400	1	001870008
10x11	155	16.400	1	001870010
12x13	175	17.000	1	001870012
14x15	205	18.600	1	001870014
16x17	235	21.250	1	001870016



	Ft	🔧	📄
187/B5 8x9-10x11-12x13 14x15-16x17 mm	93.500	1	001870050

192

Egyenes racsnis csillagkulcs 4 az 1-ben



Ø mm	L mm	Ft	🔧	📄
8x10/12x13	160	13.150	1	001920008
16x17/18x19	230	16.800	1	001920016



	Ft	🔧	📄
192/S2 8x10/12x13 mm 16x17/18x19 mm	29.950	1	001920070

194

Betéttartókulcs átváltós racsnival



Ø	L mm	Ft	🔧	📄
1/4x5/16	128	16.800	2	001940006

186

Önzáró kulcs automatikus visszaállítással 8 és 32 mm közötti hatszögű csavarokhoz

a következő profilú csavarfejekhez ideális: hatszög, Spline, négyzög, Torx(R); sérült is.



L mm	Ft	🔧	📄
260	22.450	1	001860008



Beta



195

Egyenes racsnis csillagkulcs



ISO 21982:2020

Ø mm	L mm	Ft	📦	📄
8x10	128	9.150	2	001950010
12x13	170	10.500	2	001950013
14x15	190	10.950	2	001950015
16x18	230	12.950	2	001950018
17x19	230	13.550	2	001950019



	Ft	📦	📄
195/B5	61.950	1	001950066
8x10-12x13-14x15 16x18-17x19 mm			
195/BV5	4.820	1	001950070

195AS

Egyenes racsnis csillagkulcs



Ø "	L mm	Ft	📦	📄
5/16x3/8	128	9.430	2	001950606
7/16x1/2	170	10.500	2	001950611
9/16x5/8	190	11.750	2	001950614
11/16x3/4	230	13.350	2	001950617



	Ft	📦	📄
195AS/B4	49.850	1	001950654
5/16x3/8 - 7/16x1/2 - 9/16x5/8 - 11/16x3/4			
195FTX/BV4	4.820	1	001950520



195P

Racsnis csillagkulcs 15°-ban hajlított



ISO 21982:2020

Ø mm	L mm	Ft	📦	📄
8x10	128	13.750	2	001950210
12x13	170	14.750	2	001950213
14x15	190	15.200	2	001950215
16x18	230	17.000	2	001950218
17x19	230	17.800	2	001950219



	Ft	📦	📄
195P/B5	83.350	1	001950266
8x10-12x13-14x15 16x18-17x19 mm			
195/BV5	4.820	1	001950070

310

Csőhegesztő PE, PP, PVC
műanyagokhoz, PVDF csövekhez
és szerelvényekhez

CE



230V-650 Watt
50 Hz=60Hz
Schuko (CEE 7/7)

Ø mm	Ft	📦	📄
310/2 16÷63	178.900	1	003100002

310B

Idomok a 310 csőhegesztőhöz



Ø mm	Ft	📦	📄
16	30.550	1	003100016
20	33.400	1	003100020
25	35.800	1	003100025
32	39.650	1	003100032
40	46.750	1	003100040
50	59.300	1	003100050
63	68.200	1	003100063

310/C8

Csőhegesztő 7 idommal,
fémdobozban



	Ft	📦	📄
310/C8	401.600	1	003100108
310/2+310B: Ø 16-20-25 32-40-50-63			
☞ 440x270x120 mm - 📦 7,7 kg			

311

Platnis kézi csőhegesztő PE csövekhez

CE



230V
50 Hz=60Hz

Schuko (CEE 7/7)

	Ø mm	Watt	Ft	📦	📄
311/1	120	300	159.500	1	003110001
311/2	190	900	177.300	1	003110002





A BETA CSŐVÁGÓK ALKALMAZÁSI TERÜLETEI

A Beta csővágók széles körben alkalmazhatók. Pontos, sima görgői és csavaros vagy teleszkópos előtölói miatt bármilyen csőanyagon pontos és tiszta vágások végezhetők.

Az alábbi táblázatban láthatók az egyes anyagokhoz alkalmas csővágó/vágókerék kombinációk.

	ACÉL GÁZCSÖVEK			ROZSDAMENTES ACÉL GÁZCSÖVEK		
	10 mm	60 mm	115 mm	10 mm	60 mm	115 mm
	1/8"	2"	4"	1/8"	2"	4"
330/2						
330/4						

	RÉZ ÉS KÖNNYŰ ÖTVÖZET CSÖVEK							
	3 mm	6 mm	8 mm	16 mm	28 mm	30 mm	38 mm	67 mm
	1/8"	1/4"	5/16"	5/8"	1"1/8"	1"1/2"	1"1/2"	2"5/8"
332								
334								
336								
338								

	VÉKONY FALÚ ROZSDAMENTES ACÉL CSÖVEK							
	3 mm	6 mm	8 mm	16 mm	28 mm	30 mm	38 mm	67 mm
	1/8"	1/4"	5/16"	5/8"	1"1/8"	1"1/2"	1"1/2"	2"5/8"
332 + 334R/I								
334 + 334R/I								
336 + 338R/I								
338 + 338R/I								

	MŰANYAG CSÖVEK							
	6 mm	8 mm	16 mm	30 mm	38 mm	50 mm	67 mm	127 mm
	1/4"	5/16"	5/8"	1"1/8"	1"1/2"	2"	2"5/8"	5"
336 + 338RP								
338 + 338RP								

330

Csővágó, acél gázcsövekhez



	∅ mm - "	L mm	Ft		
330/2	10÷60 1/8"÷2"	380	75.900	1	003300002
330/4	60÷115 2"÷4"	585	172.900	1	003300004

330R/A

Tartalék vágókerék a 330 típusú csővágóhoz, acélcsövekhez



	∅ mm	S mm	Ft		
330R/A2	32	7	7.290	1	003300012
330R/A4	42	9	19.000	1	003300014

330R/I

Tartalék vágókerék a 330 típusú csővágóhoz, rozsdamentes acélcsövekhez



	∅ mm	S mm	Ft		
330R/I2	32	7	16.200	1	003300024
330R/I4	32	9	45.750	1	003300034

331C

hordozható C-formájú csővágó réz- és könnyűfém csövekhez



	∅ mm	L mm	Ft		
331C	15÷22	78	26.900	1	003310050

332

mini csővágó réz- és könnyűfém csövekhez



	∅ mm - "	L mm	Ft		
332	3÷16 1/8"÷5/8"	59	10.950	2	003320001
332	3÷28 1/8"÷1"1/8"	63	12.350	2	003320003

334

Csővágó, réz és könnyűfém csövekhez



	∅ mm - "	L mm	Ft		
334	3÷30 1/8"÷1"1/8"	150	15.200	1	003340001

334R

Tartalék vágókerék a 332 és 334 típusú csővágókhöz, réz és könnyűfém csövekhez



	D mm	Ft		
334R	18	3.240	1	003340021

334R/I

Tartalék vágókerék a 332 és 334 típusú csővágókhöz, rozsdamentes acélcsövekhez



	D mm	Ft		
334R/I	18	9.190	1	003340023



336

Teleszkópos csővágó
réz és könnyűfém csövekhez



Ø mm -"	L mm	Ft		
6÷38 1/4"÷1"1/2	160	24.900	1	003360001

338

Teleszkópos csővágó gyors
előtolással, réz, könnyűfém
és műanyag csövekhez



Ø mm -"	L mm	Ft		
6÷67 1/4"÷2"5/8	290	62.150	1	003380001

338R

Tartalék vágókerék a 331L, 336 és 338
típusú csővágókhoz,
réz és könnyűfém csövekhez



Ø mm	Ft		
338R 18,5	3.420	1	003380022

338R/I

Tartalék vágókerék a 336 és 338
típusú csővágókhoz, rozsdamentes
acélcsövekhez

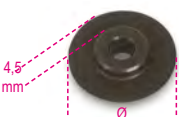

Ø mm	Ft		
338R/I 21,8	10.100	1	003380023

338RP

Tartalék vágókerék a 336 és 338
típusú csővágókhoz



Ø mm	Ft		
338RP 21,9	3.720	1	003380025

340

csővágó fogó többretegű csövekhez
legnagyobb Ø 26 mm
PTFE burkolatú penge
4 támasztógörgő a cső forgatásának megkönnyítésére vágás
közben
nyélbe épített flexibilis cső vágó rendszer
könnyű magnézium test



Ø max mm	Ft		
340 26	51.600	1	003400001

340RL

pótpenge a 340 fogóhoz



Ft		
340RL 14.750	1	003400010

340C

csővágó fogó bordás csövekhez

alumínium-magnézium ötvözet
kompakt, könnyű, zsebben elfér
kiegészítő vágólap hosszanti vágáshoz



Ø mm	L mm	Ft		
340C 14-45	134	24.500	1	003400050

340C/KRL

3 darabos vágólap készlet a 340C fogóhoz



Ft		
340C/KRL 14.750	1	003400055

341

Csővágó fogó műanyag csövekhez



Ø mm	L mm	Ft		
341 0÷25	190	18.400	1	003410001

341RL

Tartalék vágókés a 341
típusú csővágó fogóhoz



Ft		
341RL 8.300	1	003410010

341B

Rácsis csővágóolló műanyagcsövekhez



Ø mm	L mm	Ft		
341B 0÷35	195	33.800	1	003410051

341B/RM

Tartalék rugó a 341B típusú csővágóollóhoz

Ft		
341B/RM 1.280	1	003410061

341B/RL

Tartalék vágókés a 341B típusú csővágó ollóhoz



341B/RL Ft 12.750 1 003410060

342

Racsnis csővágóolló műanyag csövekhez



Ø mm - " 0÷42 1"5/8 L mm 200 Ft 24.700 1 003420030

342MOL

Tartalékrugó a 342-es modellhez

342MOL Ft 1.800 1 003420033

342RL

Tartalék vágókés a 342-es modellhez



342RL Ft 11.350 1 003420032

342A

Racsnis csővágóolló műanyag csövekhez



Ø mm - " 0÷50 2" L mm 270 Ft 50.600 1 003420101

342A/MOL

Tartalékrugó a 342A-hoz

342A/MOL Ft 1.100 1 003420111

342A/RL

Tartalék vágókés a 342A típusú ollóhoz



342A/RL Ft 26.300 1 003420110

342P

Racsnis csővágó olló műanyag csövekhez, magnézium ötvözet



Ø mm - " 0÷50 2" L mm 260 Ft 54.850 1 003420121

342P/RL

Tartalék vágókés 342P-hez



342P/RL Ft 22.850 1 003420130

345

Csősorjázó, műanyaggal bevont fémtest

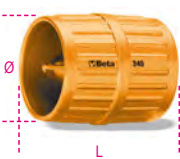

Ø mm - " 3÷42 1/8"±1"5/8 L mm 58 Ft 13.350 5 003450001

345U

Belső-külső-sorjázó, acél, réz és könnyűfém csövekhez



Ø mm - " 4÷36 5/32±1"7/16 L mm 60 Ft 35.200 1 003450050

345U/A

adapter a 345U csősorjázóhoz, 1/4" hatlapfejú csatlakozó fúrókhoz



L mm 90 Ft 8.950 3 003450055

345C

kalibráló eszköz többretegű csövekhez



Ø mm 16-20-26-32 Ft 21.250 1 003450032

345SB

Sorjázó forgó cserélhető késsel, gyorsacél, réz, könnyűfém és PVC csövekhez



L mm 150 Ft 10.950 5 003450010

345SB/R

Tartalék vágókés a 345SB sorjázóhoz



345SB/R Ft 3.870 3 003450015

345SB2

sorjázó rögzített késsel



L mm 140 Ft 5.470 5 003450022

345SC

4 az 1-ben külső-belső sorjázó,
1/2" és 3/4" átmérőhöz



L mm	L1 mm	L2 mm	Ft	csomagolás	art. szám
195	28	32	6.400	2	003450060

345SI

belső sorjázó,
forgó cserélhető késsel



L mm	Ø mm	Ft	csomagolás	art. szám
168	16,5	20.850	1	003450040

345SI/R

tartalék kés a 345SI sorjázóhoz



345SI/R	Ft	csomagolás	art. szám
	14.550	1	003450045

349

Csőperemező réz és könnyűfém csövekhez

38"



Ø mm - "	Ft	csomagolás	art. szám
6-8-10-12-14-15-16-18 (1/8-3/16-1/4-5/16 3/8-1/2-5/8-3/4)	132.000	1	003490011

270x200x50 mm - 2,7 kg

349/SMM

Peremező szán, metrikus a 349-hez



Ø mm	Ft	csomagolás	art. szám
6-8-10-12-14-15-16-18	38.650	1	003490011

349/SMAS

Peremező szán, col-os a 349-hez



Ø "	Ft	csomagolás	art. szám
1/8-3/16-1/4-5/16 3/8-1/2-5/8-3/4	36.450	1	003490012

350

Csőperemező réz és könnyűfém csövekhez



Ø mm	L mm	A mm	Ft	csomagolás	art. szám
4-4,75-6-8 10-12-14	175	104	38.250	1	003500001

351C

Csővágó és peremező készlet,
műanyag dobozban



351C	Ft	csomagolás	art. szám
	69.250	1	003510010

334	Ø 3+30 mm (1/8"+1"1/8)
350	Ø 4+14 mm
351P	Ø 4-4,75-6-8-10-12-14 mm

225x150x45 mm - 1,6 kg

351P

Peremező betétek a 350 típusú csőperemezőhöz



351P	Ø mm	Ft	csomagolás	art. szám
4	4	3.160	3	003510101
4,75	4,75	3.160	3	003510102
6	6	3.160	3	003510103
8	8	3.160	3	003510104
10	10	3.160	3	003510105
12	12	3.160	3	003510106
14	14	3.160	3	003510107

352U

Csőperemező réz és könnyűfém csövekhez

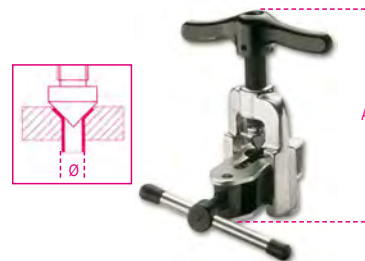

Ø mm - "	A mm	Ft	csomagolás	art. szám
5+16 3/16+5/8	130	45.350	1	003520101

352C/U

Csővágó, sorjázó és peremező készlet



352C/U	Ft	csomagolás	art. szám
	89.250	1	003520110

334	Ø 3+30 mm (1/8"+1"1/8)
345SB	
352U	Ø 5+16 mm (3/16"+5/8")

335x145x60 mm - 2120 g

355

Ótlépcsős szerelőkulcs

12"



Ø "	L mm	Ft	csomagolás	art. szám
3/8"-1/2" 3/4"-1"	90	18.000	2	003550001

357F3

Vízmérték 3 libellával csapok beállításához



Ø "	L mm	Ft	csomagolás	art. szám
3/8" / 1/2"	90÷220	57.300	1	003570100

357R/F3

Csere fiola a 357F3 cikkhez



357R/F3	Ft	1	003570101
	9.230		

358

Sorjázó készülék műanyag csövekhez, lakkozott



	Ø mm	Ft	1	003580001
358/1	16÷110	80.550		
358/2	40÷250	80.550		

358RL

Tartalék sorjázó kés a 358/1 és a 358/2 típusú sorjázó készülékhez



358RL	Ft	1	003580011
	14.950		

359

Univerzális lefolyókulcs



Ø "	L mm	A mm	Ft	1	003590001
1"±1"1/4	160	140	39.650		

359CH

Lefolyóadapter, keresztalakú, alumínium



Ø "	L mm	Ft	1	003590005
1"1/2	74	22.450		

360

„Stillson” csőfogó kovácsolt acélból



L mm	Ø max " "	Ø max mm	Ft	1	003600025
250	1" gas	34	16.400		
350	1"1/2 gas	49	21.850		
450	2" gas	60	30.550		
600	2"1/2 gas	76	46.750		
900	3"1/2 gas	102	129.600		

360R/...

Alkatrészek a 360 modellhez
Tartalma: pofa és állítógyűrű

	Ft	1	003600025
360R 250	6.150		
360R 350	8.460		
360R 450	12.350		
360R 600	18.000		
360R 900	32.400		

361N

állítható csőkulcs

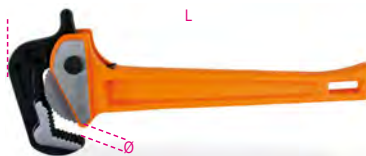

L mm	Ø max " "	Ø max mm	Ft	1	003610014
350	1" 1/2	49	34.000		

362

Amerikai csőfogó



L mm	Ø max " "	Ø max mm	Ft	1	003620020
200	1" gas	34	14.550		
250	1"1/2 gas	49	18.200		
300	2" gas	60	21.850		
350	2" gas	60	26.100		
450	2"1/2 gas	76	37.650		
600	3" gas	90	57.100		
900	5" gas	140	69.850		

362R/...

Alkatrészek a 362 modellhez

Tartalma: fix pofa; mozgó pofa; állítógyűrű, rögzítő stift

	Ft	1	003620220
362R 200	3.040		
362R 225	4.330		
362R 300	5.340		
362R 350	6.150		
362R 450	8.420		
362R 600	11.350		
362R 900	28.150		

363

Amerikai csőfogó



L mm	Ø max " "	Ø max mm	Ft	1	003630035
350	2" gas	60	31.350		
450	2"1/2 gas	76	42.300		
600	3" gas	90	71.450		
900	5" gas	140	134.000		
1200	6" gas	165	142.100		

363R/...

Alkatrészek a 363 modellhez

Tartalma: fix pofa; mozgó pofa; állítógyűrű, rögzítő stift

	Ft	1	003630235
363R 350	6.760		
363R 450	8.990		
363R 600	12.550		
363R 900	24.500		
363R 1200	37.850		



365

Amerikai csőfogó,
eltolt tengelyű modell

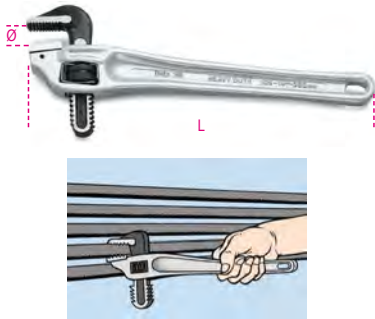

L mm	Ø max "	Ø max mm	Ft		
350	2" gas	60	39.250	1	003650035
450	2 1/2" gas	76	53.850	1	003650045

365R/...

Alkatrészek a 365 modellhez
Tartalma: fix pofa; mozgó pofa; állítógyűrű,
rögzítő stift

	Ft		
365R 350	29.350	1	003650235
365R 450	43.900	1	003650245

366

Csőfogó, könnyített kivitel,
szénacélból



L mm	Ø max "	Ø max mm	Ft		
175	1" gas	34	14.950	1	003660017
225	1 1/2" gas	49	17.600	1	003660022
275	2" gas	60	21.450	1	003660027
300	2 1/2" gas	76	23.050	1	003660030

374

Svéd csőfogó, 45°-os keskeny pofa



DIN 5234

L mm	Ø max "	Ø max mm	Ft		
240	1 1/2" gas	21	17.200	1	003740024
320	1" gas	34	23.050	1	003740032
410	1 1/2" gas	49	30.350	1	003740041
550	2" gas	60	47.150	1	003740055
630	3" gas	90	84.400	1	003740063

375

Svéd csőfogó
45°-os keskeny pofa



DIN 5234

L mm	Ø max "	Ø max mm	Ft		
320	1" gas	34	23.050	1	003750032
410	1 1/2" gas	49	30.350	1	003750041
550	2" gas	60	47.150	1	003750055

376

Svéd csőfogó, 90°-os lapos pofa



DIN 5234

L mm	Ø max "	Ø max mm	Ft		
320	1" gas	34	23.050	1	003760032
410	1 1/2" gas	49	30.350	1	003760041
550	2" gas	60	47.150	1	003760055
630	3" gas	90	85.800	1	003760063

378

Svéd csőfogó, 45°-os keskeny pofa



DIN 5234

L mm	Ø max "	Ø max mm	Ft		
250	1 1/2" gas	21	18.200	1	003780025
320	1" gas	34	24.300	1	003780032
410	1 1/2" gas	49	31.350	1	003780041
550	2" gas	60	51.800	1	003780055
650	3" gas	90	87.250	1	003780065

374R/...

Komplett alkatrészek a 374 - 375 - 376 - 378
modellhez
hornyos anya és állítógyűrű

	Ft		
374R 240 x 374/240-378/250	1.020	1	003740724
374R 320 x 374/320-376/320-378/320	1.140	1	003740732
374R 410 x 374/410-375/410-376/410-378/410	1.400	1	003740741
374R 550 x 374/550-376/550-378/550	1.680	1	003740755
374R 630 x 374/630-378/650	2.530	1	003740763

383

Kettős működésű szijas csőfogó,
kovácsolt acél fogantyú



	Ø max "	Ø max mm	L mm	Ft		
383/1	3" gas	90	300	24.700	1	003830001
383/2	8" gas	220	300	26.100	1	003830002

383R

Tartalék szijas a 383 típusú
csőfogóhoz



	S mm	Ft		
383R/1	27	10.100	1	003830010
383R/2	27	10.500	1	003830015

384

Kettős működésű láncos csőfogó



	Ø max "	Ø max mm	L mm	Ft		
384	4" gas	115	300	33.400	1	003840032

384RC

Tartalék lánc a 384 típusú
csőfogóhoz



	Ft		
384RC	20.650	1	003840033

386A

Erősített láncos csőfogó



	Ø max "	L mm	Ft		
386A/1	4" gas 115 mm	900	113.800	1	003860001
386A/2	6" gas 168 mm	900	210.100	1	003860002
386A/5	8" gas 220 mm	1100	270.900	1	003860005
386A/6	12" gas 324 mm	1300	469.200	1	003860006



386A/RC

Tartalék lánc a 386A-hoz



	Ft	🔧	📦
386A1/RC	35.400	1	003860011
386A2/RC	50.400	1	003860012
386A5/RC	66.800	1	003860015
386A6/RC	117.400	1	003860016

387

csőhajlító réz- és színesfémcsövekhez, cserélhető kengyelekkel 3/16"-1/4"-5/16"-3/8"



L mm	∅ mm	Ft	🔧	📦
255	3/16"-1/4"-5/16"-3/8"	22.450	1	003870001

387R

tartalék kengyel a 387 termékhez



∅ mm	Ft	🔧	📦
3/16"-1/4"	5.710	1	003870010
5/16"-3/8"	6.030	1	003870015

388

Csőhajlító, vékonyfalú réz, könnyűfém és lágyacél csövekhez

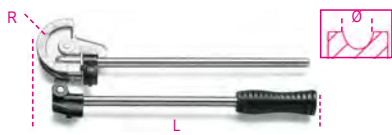

∅ mm	L mm	R mm	Ft	🔧	📦
6	305	18,0	28.350	1	003880006
8	315	23,5	30.550	1	003880008
10	350	31,0	35.200	1	003880010
12	360	31,0	37.450	1	003880012
15	465	46,5	51.600	1	003880015

388A

Csőhajlító vékonyfalú réz és könnyűfém csövekhez



	∅ mm	L mm	Ft	🔧	📦
388A/1	6-8-10	mm 220	30.750	1	003880051
388A/2	1/4"-5/16"-3/8"	220	30.750	1	003880055

388C/C8

Csőhajlító 7 kengyellel réz és könnyűfém csövekhez



	∅ mm	Ft	🔧	📦
388C/C8	10-12-14-16-18-20-22	223.900	1	003880200

400x330x110 mm - 3,6 kg

389/K4

csőhajlító rugó készlet rézcsövekhez külső



∅ mm	L mm	Ft	🔧	📦
1/4-3/8-1/2-5/8	290	9.470	1	003890001

392C

"Connector"-Szifonfogó



∅ mm	L mm	Ft	🔧	📦
25÷65	260	21.250	1	003920100

392RG/C

Tartalék pófavédő a 392C modellhez, 1 pár



	Ft	🔧	📦
392RG/C	2.890	1	003920101

393

Hollander fogó PVC-bevonatú száraz, krómzott



L mm	Ft	🔧	📦
270	30.750	1	003930001

395

Univerzális önzáró hollander kulcs, lakkozott



∅ mm	L mm	Ft	🔧	📦
15÷32 mm	240	20.250	1	003950001

5/8"±1"1/4

395T

Teleszkópos hollander kulcs, krómzott test, lakkozott pófák



∅ mm	L mm	Ft	🔧	📦
10÷32 mm	250÷430	27.100	1	003950100

3/8"±1"1/4

398

munkapadra szerelhető láncos csőszatu



∅ mm	L mm	Ft	🔧	📦
1/2÷8"	250	139.700	1	003980008

399

Asztali csőszatu, lakkozott

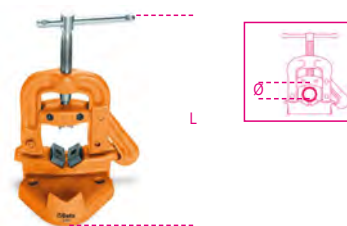

∅ mm	L min mm	Ft	🔧	📦
10÷60 mm	220	86.050	1	003990005
1/8÷2"				
10÷89 mm	290	154.300	1	003990010
1/8÷3"				

399R/...

tartalék készlet a 399 modellhez, két alsó pofa és egy felső pofa



	Ft	🔧	📦
399RG 1/8-2"	11.150	1	003990105
399RG 1/8-3"	17.800	1	003990110

TÁBLÁZAT FÚRÓSZERSZÁMOKHOZ

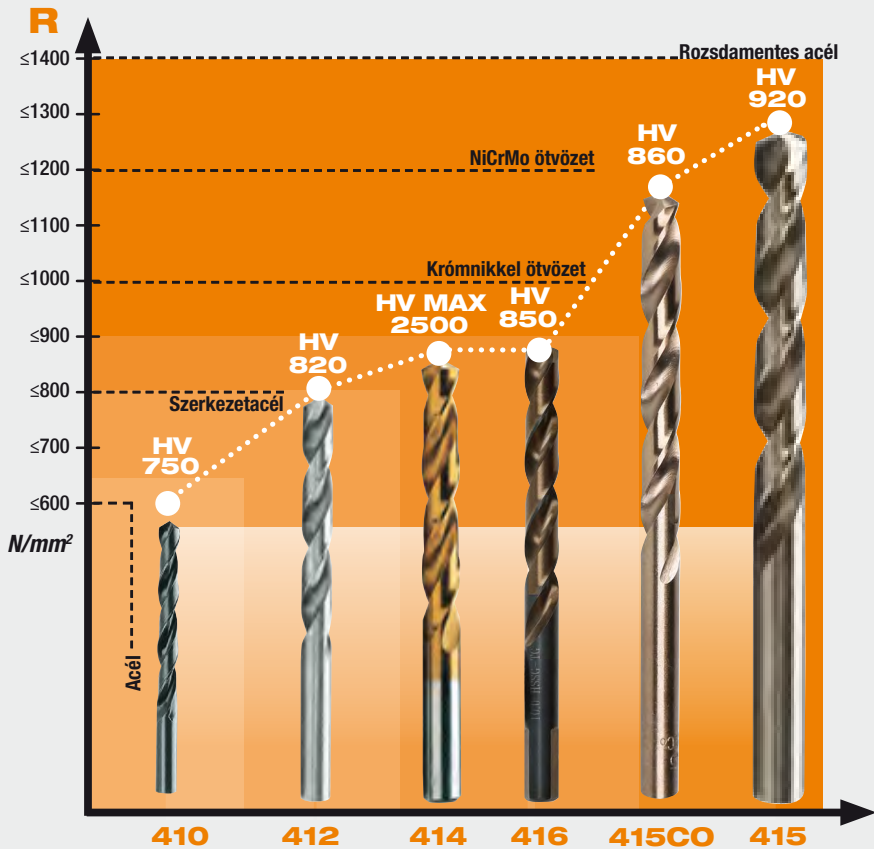

R N/mm² - A fúrni kívánt anyag mechanikai ellenállása.

HV - A csigafúró Vickers skála szerinti keménysége: minél magasabb az érték, annál keményebb az anyag.

ÚTMUTATÓ: CSIGAFÚRÓ HENGERES SZÁRRAL

Hengerelt csigafúrók - Meleg hengereléssel előállított csigafúrók. Jó minőségű csiga- és csavarfúrók könnyű munkákhoz, általában például vas, lágyacél, könnyűfém ötvözetek és színesfémek fúrására.

Köszörült csigafúrók - Teljes mértékben hőkezelt acélrúd köszörülésével készült csigafúrók. Nagy teljesítményű csigafúrók acél és könnyűfém ötvözetek fúrására: állandó hatékonyság, kiváló forgácsolóhatás és fúrási pontosság.

HSS - Gyorsacél, rendkívül kemény és ellenáll a magas hőmérsékletnek; a leginkább megfelelő anyag szerszámok vágásához, csapolásához és menetvágásához.

Kobalt (Co) - Alapötözet, amely javítja az acél hőállóságát, és például magas hőmérsékleten csökkenti a csigafúró kopását. Minél magasabb a kobalttartalom, a szerszám annál jobb teljesítményt nyújt. A leggyakrabban használt ötvözetek kobalttartalma 5% vagy 8%.

HSS-Co - 5% vagy 8% kobalttartalmú gyorsacél.

TiN - Ultravékony titán-nitrid bevonat; nagy keménységének és alacsony súrlódási tényezőjének köszönhetően fokozottan ellenáll a kopásnak és az oxidációnak, valamint jobban eltávolítja a keletkező forgácsot.

Krómacél - A krómacélból készült szerszámok kézi használatra alkalmasak vas, könnyűfém ötvözetek, kezeletlen acél és alacsony keménységű hőkezelt acélok menetvágásához. Minden szakipari területen, de különösen az autópárházban széles körben használják sérült menetek tisztítására és javítására.

Keményfém - Nagy kopásállóságú anyag kőfúró fejekhez.

118°-os élszög - A fémhez használt csigafúrók szokásos élszöge, amely lehetővé teszi a fémek gyors fúrását, a könnyebb közép tartást és a kiváló hőelvezetést.

130°-os élszög - Széles élszög, nagyobb pontosságot biztosít a kezdeti fúrási műveletek során, és kevesebb fúróerőt igényel.

Kétfős 115°/135°-os élszög - A két szög minden közös előnye, továbbá forgácsoló funkció; a legjobb választás hosszú forgácsokat produkáló anyagokhoz.

SDS-Plus - Gyors, biztonságos befogórész ütvefúrókhoz.

410

Rövid csigafúró, HSS hengerelt, barnított

R ≤ 650 N/mm²
HV ~ 750÷820



DIN 338 ISO 235

Ø mm	L mm	L1 mm	Ft	📦	🏠
0,50	22	6	740	10	004100030
1,00	34	12	410	10	004100040
1,25	38	16	340	10	004100043
1,50	40	18	315	10	004100046
1,75	46	22	315	10	004100049
2,00	49	24	290	10	004100052
2,25	53	27	340	10	004100055
2,50	57	30	315	10	004100058
2,75	61	33	340	10	004100061
3,00	61	33	315	10	004100064
3,25	65	36	430	10	004100066
3,25	65	36	430	10	004100067
3,50	70	39	400	10	004100070
3,75	70	39	480	10	004100073
4,00	75	43	440	10	004100076
4,20	75	43	550	10	004100078
4,25	75	43	550	10	004100079
4,50	80	47	495	10	004100082
4,75	80	47	570	10	004100085
5,00	86	52	540	10	004100088
5,25	86	52	775	10	004100091
5,50	93	57	725	10	004100094
5,75	93	57	795	10	004100097
6,00	93	57	725	10	004100100
6,25	101	63	945	10	004100103
6,50	101	63	890	10	004100106
6,75	109	69	1.140	10	004100109
7,00	109	69	1.050	10	004100112
7,50	109	69	1.110	10	004100118
8,00	117	75	1.320	10	004100124
8,50	117	75	1.380	10	004100130
9,00	125	81	1.680	5	004100136
9,50	125	81	1.840	5	004100142
10,00	133	87	2.020	5	004100148
10,50	133	87	2.430	5	004100172
11,00	142	94	2.870	5	004100184
11,50	142	94	2.980	5	004100196
12,00	151	101	3.300	5	004100210
12,50	151	101	3.620	5	004100222
13,00	151	101	3.830	5	004100234
14,00	160	108	5.060	5	004100242
15,00	169	114	5.910	5	004100250
16,00	178	120	7.410	5	004100258
17,00	184	125	8.140	3	004100262
18,00	191	130	9.680	3	004100266
19,00	198	135	10.950	3	004100270
20,00	205	140	13.150	3	004100274



	Ft	📦	🏠
410/SP19 Ø 1÷10 x 0,5 mm	21.250	1	004100419
410/SPVP1	11.750	1	004100421
410/SP25 Ø 1÷13 x 0,5 mm	44.550	1	004100425
410/SPVP2	16.200	1	004100427



410/SEL19 Ft 16.400 1 004100418
 Ø 1÷10 x 0,5 mm

410MIX/SEL19

13 darab 410 típusú csigafúróból és 6 darab keményfémlapkás fúróból álló készlet műanyag dobozban



410MIX/SEL19 Ft 16.400 1 004100417



Ø 1 - 1,5 - 2 - 2,5 - 3 - 3,5 - 4
 4,5 - 5 - 5,5 - 6 - 8 - 10 mm

Ø 4 - 5 - 6 - 8 - 9 - 10 mm

410A

rövid nagyméretű csigafúró
 keskeny hengeres szárral,
 HSS, hengerelt
 $R \leq 650 \text{ N/mm}^2$

HV ~ 750+820



DIN 338 ISO 235

Ø mm	L mm	L1 mm	Ft	1	004100281
13,50	160	108	5.950	5	004100281
14,00	160	108	5.950	5	004100283
14,50	169	114	6.960	5	004100285
15,00	169	114	6.960	5	004100287
15,50	178	120	8.580	5	004100289
16,00	178	120	8.580	5	004100291
16,50	184	125	9.030	3	004100292
17,00	184	125	9.030	3	004100293
17,50	191	130	10.700	3	004100294
18,00	191	130	10.700	3	004100295
18,50	198	135	11.950	3	004100296
19,00	198	135	11.950	3	004100297
19,50	205	140	13.950	3	004100298
20,00	205	140	13.950	3	004100299



412

Rövid csigafúró, HSS, köszörült,
 polírozott kivitel

$R \leq 800 \text{ N/mm}^2$
 HV ~ 750+820



DIN 338 ISO 235

Ø mm	L mm	L1 mm	Ft	10	004120030
0,50	22	6	1.280	10	004120030
1,00	34	12	825	10	004120040
1,25	38	16	880	10	004120043
1,50	40	18	740	10	004120046
1,75	46	22	740	10	004120049
2,00	49	24	625	10	004120052
2,25	53	27	795	10	004120055
2,50	57	30	680	10	004120058
2,75	61	33	795	10	004120061
3,00	61	33	715	10	004120064
3,25	65	36	935	10	004120067
3,50	70	39	860	10	004120070
3,75	70	39	1.020	10	004120073
4,00	75	43	935	10	004120076
4,25	75	43	1.200	10	004120079
4,50	80	47	1.070	10	004120082
4,75	80	47	1.280	10	004120085
5,00	86	52	1.200	10	004120088
5,25	86	52	1.700	10	004120091
5,50	93	57	1.560	10	004120094
5,75	93	57	1.900	10	004120097
6,00	93	57	1.620	10	004120100
6,25	101	63	2.370	10	004120103
6,50	101	63	2.060	10	004120106
6,75	109	69	2.650	10	004120109
7,00	109	69	2.430	10	004120112
7,25	109	69	2.960	5	004120115
7,50	109	69	2.510	5	004120118
7,75	117	75	3.380	5	004120121
8,00	117	75	3.100	5	004120124
8,25	117	75	3.770	5	004120127
8,50	117	75	3.810	5	004120130
8,75	125	81	4.170	5	004120133
9,00	125	81	3.970	5	004120136
9,25	125	81	4.570	5	004120139
9,50	125	81	4.130	5	004120142
9,75	133	87	5.140	5	004120145
10,00	133	87	4.570	5	004120148
10,25	133	87	7.000	5	004120149
10,50	133	87	6.150	5	004120150
10,75	142	94	8.380	5	004120151
11,00	142	94	7.330	5	004120152
11,25	142	94	8.910	5	004120153
11,50	142	94	7.730	5	004120154
11,75	142	94	9.680	5	004120155
12,00	151	101	8.500	5	004120156
12,25	151	101	10.500	5	004120157
12,50	151	101	9.070	5	004120158
12,75	151	101	11.950	5	004120159
13,00	151	101	9.640	5	004120160



	Ft	1	004120419
412/SP19 Ø 1÷10 x 0,5 mm	42.100	1	004120419
410/SPVP1	11.750	1	004100421
412/SP25 Ø 1÷13 x 0,5 mm	87.250	1	004120425
410/SPVP2	16.200	1	004100427
412/SP49 Ø 1÷13 x 0,25 mm	209.300	1	004120449
412/SPV4	49.600	1	004120451

412/C150



412/C150 Ft 254.700 1 004120450

412 Ø 3 mm n.
 Ø 1 - 1,5 - 2 - 2,5 - 3 - 3,5 - 4 - 4,5 - 5 mm 10
 Ø 5,5 - 6 - 6,5 - 7 - 7,5 - 8 - 8,5 - 9 - 9,5 - 10 mm 5
 365x230x47 mm - 3,3 kg



412/SP91 Ft 271.700 1 004120452
 Ø 1÷10 x 0,10 mm

412A

rövid nagyméretű csigafúró
 keskeny hengeres szárral,
 HSS,
 köszörült, barnított

$R \leq 800 \text{ N/mm}^2$

HV ~ 750+820



DIN 338 ISO 235

Ø mm	L mm	L1 mm	Ft	3	004120202
13,50	160	108	15.600	3	004120202
14,00	160	108	16.000	3	004120204
14,50	169	114	17.200	3	004120206
15,00	169	114	18.000	3	004120208
15,50	178	120	20.650	3	004120210
16,00	178	120	21.450	3	004120212
16,50	184	125	22.050	1	004120213
17,00	184	125	23.700	1	004120214
17,50	191	130	25.100	1	004120215
18,00	191	130	26.700	1	004120216
18,50	198	135	28.750	1	004120217
19,00	198	135	29.550	1	004120218
19,50	205	140	33.200	1	004120219
20,00	205	140	33.800	1	004120220

412L

Hosszú csigafúró, HSS, köszörült, barnított

R ≤ 800 N/mm²
HV ~ 750÷820



DIN 340

Ø mm	L mm	L1 mm	Ft	🔧	🏠
2,00	85	56	1.700	10	004120232
2,50	95	62	1.800	10	004120234
3,00	100	66	1.900	10	004120236
3,50	112	73	2.170	10	004120238
4,00	119	78	2.370	10	004120240
4,50	126	82	2.850	10	004120242
5,00	132	87	2.960	10	004120244
5,50	139	91	3.770	10	004120246
6,00	139	91	4.030	10	004120248
6,50	148	97	4.820	5	004120250
7,00	156	102	5.630	5	004120252
8,00	165	109	7.490	5	004120256
9,00	175	115	8.830	5	004120260
10,00	184	121	9.680	5	004120264

412XL

csigafúró hengeres szárral, extra hosszú, HSS, köszörült

R ≤ 800 N/mm²
HV ~ 750÷820



DIN 1869/1

Ø mm	L mm	L1 mm	Ft	🔧	🏠
3,00	150	100	6.520	1	004120520
3,50	165	115	7.170	1	004120522
4,00	175	120	7.170	1	004120524
4,50	185	125	7.410	1	004120526
5,00	195	135	7.410	1	004120528
5,50	205	140	9.070	1	004120530
6,00	205	140	9.070	1	004120532
6,50	215	150	10.700	1	004120534
7,00	225	155	12.550	1	004120536
7,50	225	155	14.550	1	004120538
8,00	240	165	15.400	1	004120540
8,50	240	165	16.000	1	004120542
9,00	250	175	20.450	1	004120544
9,50	250	175	22.050	1	004120546
10,00	265	185	22.050	1	004120548
10,50	265	185	22.050	1	004120550
11,00	280	195	22.050	1	004120552
12,00	295	205	28.150	1	004120556
13,00	295	205	29.150	1	004120560

414

Rövid csigafúró, HSS-TiN, köszörült

R ≤ 900 N/mm²
HV 0,05 ~ 2500



DIN 338 ISO 235

Ø mm	L mm	L1 mm	Ft	🔧	🏠
1,00	34	12	1.120	10	004140040
1,25	38	16	1.280	10	004140042
1,50	40	18	995	10	004140046
1,75	46	22	1.280	10	004140048
2,00	49	24	1.050	10	004140052
2,25	53	27	1.320	10	004140054
2,50	57	30	1.110	10	004140058
2,75	61	33	1.520	10	004140060
3,00	61	33	1.230	10	004140064
3,25	65	36	1.600	10	004140066
3,50	70	39	1.520	10	004140070
3,75	70	39	1.680	10	004140072
4,00	75	43	1.520	10	004140076
4,25	75	43	1.840	10	004140078
4,50	80	47	1.680	10	004140082
4,75	80	47	2.090	10	004140084
5,00	86	52	1.960	10	004140088
5,25	86	52	2.710	10	004140090
5,50	93	57	2.350	10	004140094
5,75	93	57	2.850	10	004140096
6,00	93	57	2.610	10	004140100
6,25	101	63	3.300	10	004140102
6,50	101	63	2.890	10	004140106
6,75	109	69	3.970	10	004140108
7,00	109	69	3.180	10	004140112
7,25	109	69	4.370	5	004140114
7,50	109	69	3.930	5	004140118
7,75	117	75	5.140	5	004140120
8,00	117	75	4.570	5	004140124
8,25	117	75	5.340	5	004140125
8,50	117	75	4.780	5	004140130
8,75	125	81	6.640	5	004140132
9,00	125	81	5.910	5	004140136
9,25	125	81	7.570	5	004140138
9,50	125	81	6.640	5	004140142
9,75	133	87	7.940	5	004140144
10,00	133	87	7.040	5	004140148
10,50	133	87	8.260	5	004140150
11,00	142	94	8.910	5	004140152
11,50	142	94	9.680	5	004140154
12,00	151	101	10.300	5	004140156
12,50	151	101	11.950	5	004140158
13,00	151	101	12.550	5	004140160



	Ft	🔧	🏠
414/SP19 Ø 1÷10 x 0,5 mm	61.750	1	004140419
410/SPVP1	11.750	1	004100421
414/SP25 Ø 1÷13 x 0,5 mm	124.700	1	004140425
410/SPVP2	16.200	1	004100427
414/SP49 Ø 1÷13 x 0,25 mm	274.500	1	004140429
414/SPV4	49.600	1	004140430

414/C116

Rövid csigafúró készlet, HSS-TiN, 116 darabos



414/C116	Ft	🔧	🏠
	251.500	1	004140450

414	Ø	n.
	Ø 1 - 1,5 - 2 - 2,5 - 3 - 3,5 - 4 - 4,5 - 5 mm	10
	Ø 5,5 - 6 - 6,5 - 7 - 7,5 - 8 mm	3
	Ø 8,5 - 9 - 9,5 - 10 mm	2

📏 365x230x47 mm - 🏠 2,7 Kg

415

Rövid csigafúró, HSS-CO 8%, köszörült

R ≤ 1400 N/mm²
HV ~ 850÷920



DIN 338 ISO 235

Ø mm	L mm	L1 mm	Ft	🔧	🏠
0,50	22	6	3.140	10	004150029
1,00	34	12	1.560	10	004150040
1,25	38	16	1.720	10	004150043
1,50	40	18	1.560	10	004150046
1,75	46	22	1.620	10	004150049
2,00	49	24	1.520	10	004150052
2,25	53	27	1.840	10	004150055
2,50	57	30	1.680	10	004150058
2,75	61	33	1.840	10	004150061
3,00	61	33	1.700	10	004150064
3,25	65	36	2.350	10	004150067
3,50	70	39	2.150	10	004150070
3,75	70	39	2.610	10	004150073
4,00	75	43	2.350	10	004150076
4,25	75	43	2.910	10	004150079
4,50	80	47	2.650	10	004150082
4,75	80	47	3.060	10	004150085
5,00	86	52	2.850	10	004150088
5,25	86	52	4.130	10	004150091
5,50	93	57	3.770	10	004150094
5,75	93	57	4.330	10	004150097
6,00	93	57	3.970	10	004150100
6,25	101	63	5.630	10	004150103
6,50	101	63	4.900	10	004150106
6,75	109	69	6.440	10	004150109
7,00	109	69	5.790	10	004150112
7,25	109	69	7.000	5	004150115
7,50	109	69	6.280	5	004150118
7,75	117	75	8.180	5	004150121
8,00	117	75	7.410	5	004150124
8,25	117	75	8.910	5	004150127
8,50	117	75	8.380	5	004150130
8,75	125	81	11.150	5	004150133
9,00	125	81	9.760	5	004150136
9,25	125	81	11.550	5	004150139
9,50	125	81	10.500	5	004150142
9,75	133	87	12.550	5	004150145
10,00	133	87	11.550	5	004150148
10,25	133	87	14.950	5	004150149
10,50	133	87	12.750	5	004150150
10,75	142	94	16.400	5	004150151
11,00	142	94	14.950	5	004150152
11,25	142	94	18.400	5	004150153
11,50	142	94	16.200	5	004150154
11,75	142	94	19.000	5	004150155



Ø mm	L mm	L1 mm	Ft		
12,00	151	101	17.600	5	004150156
12,25	151	101	22.450	5	004150157
12,50	151	101	19.000	5	004150158
12,75	151	101	24.700	5	004150159
13,00	151	101	20.250	5	004150160
14,00	160	108	35.600	3	004150164
15,00	169	114	42.100	3	004150168
16,00	178	120	51.600	3	004150172
17,00	186	125	58.700	1	004150174
18,00	194	130	65.200	1	004150176
19,00	202	135	75.100	1	004150178
20,00	210	140	84.400	1	004150180



Co8%

	Ft		
415/SP19 Ø 1÷10 x 0,5 mm	86.650	1	004150419
410/SPVP1	11.750	1	004100421
415/SP25 Ø 1÷13 x 0,5 mm	179.400	1	004150425
410/SPVP2	16.200	1	004100427
415/SP49 Ø 1÷13 x 0,25 mm	445.700	1	004150431
415/SPV4	49.600	1	004150432

415/C116

Rövid csigafúró készlet, HSS-CO 8%, 116 darabos



415/C116	Ft		
	379.100	1	004150450

415	Ø	n.
	1 - 1,5 - 2 - 2,5 - 3 - 3,5 - 4 - 4,5 - 5 mm	10
	5,5 - 6 - 6,5 - 7 - 7,5 - 8 mm	3
	8,5 - 9 - 9,5 - 10 mm	2

365x230x47 mm - 2,7 kg



415/SP91	Ft		
Ø 1÷10 x 0,10 mm	520.200	1	004150460

415CO

csigafúró hengeres szárral, rövid, HSS-CO 5%, köszörült

R ≤ 1200 N/mm²

HV ~ 800+860



DIN 338 ISO 235

Ø mm	L mm	L1 mm	Ft		
1,00	34	12	795	10	004150310
1,50	40	18	795	10	004150312
2,00	49	24	795	10	004150314
2,50	57	30	825	10	004150316
3,00	61	33	825	10	004150320
3,50	70	39	1.020	10	004150322
4,00	75	43	1.200	10	004150324
4,50	80	47	1.380	10	004150326
5,00	86	52	1.420	10	004150328
5,50	93	57	1.800	10	004150330
6,00	93	57	2.000	10	004150332
6,50	101	63	2.390	10	004150334
7,00	109	69	2.940	10	004150336
7,50	109	69	3.200	5	004150338
8,00	117	75	3.810	5	004150340
8,50	117	75	3.970	5	004150342
9,00	125	81	4.860	5	004150344
9,50	125	81	5.140	5	004150346
10,00	133	87	5.910	5	004150348
10,50	133	87	7.170	5	004150350
11,00	142	94	7.940	5	004150352
11,50	142	94	8.740	5	004150354
12,00	151	101	9.510	5	004150356
12,50	151	101	10.300	5	004150358
13,00	151	101	11.350	5	004150360

415CO-A

csigafúró hengeres szárral, rövid, HSS-CO 5%, köszörült

R ≤ 1200 N/mm²

HV ~ 800+860



DIN 338

Ø mm	L mm	L1 mm	Ft		
14,00	160	108	22.050	3	004150364
15,00	169	114	25.300	3	004150366
16,00	178	120	30.750	3	004150368
17,00	184	125	31.350	1	004150370
18,00	191	130	40.300	1	004150372
19,00	198	135	46.550	1	004150374
20,00	205	140	53.650	1	004150376



Co5%

415CO/SP19	Ft		
Ø 1÷10 x 0,5 mm	45.350	1	004150421
410/SPVP1	11.750	1	004100421

415L

csigafúró hengeres szárral, hosszú, HSS-CO 5%, köszörült

R ≤ 1200 N/mm²

HV ~ 800+860



DIN 340

Ø mm	L mm	L1 mm	Ft		
3,00	100	66	2.170	10	004150236
3,50	112	73	2.390	10	004150238
4,00	119	78	2.940	10	004150240
4,50	126	82	3.600	10	004150242
5,00	132	87	3.770	10	004150244
5,50	139	91	4.700	10	004150246
6,00	139	91	5.140	10	004150248
6,50	148	97	6.030	5	004150250
7,00	156	102	7.170	5	004150252
8,00	165	109	9.070	5	004150256
9,00	175	115	11.350	5	004150260
10,00	184	121	14.750	5	004150264

416

Csigafúrókészlet különleges csiszolással dupla kúpos fejfel

R ≤ 900 N/mm²

HV ~ 820+850



DIN 338 ISO 235

Ø mm	L mm	L1 mm	Ft		
1,00	34	12	1.210	10	004160010
1,50	40	18	1.210	10	004160015
2,00	49	24	1.210	10	004160020
2,50	57	30	1.280	10	004160025
3,00	61	33	1.380	10	004160030
3,50	70	39	1.540	10	004160035
4,00	75	43	1.700	10	004160040
4,50	80	47	1.900	10	004160045
5,00	86	52	2.150	10	004160050
5,50	93	57	2.750	10	004160055
6,00	93	57	2.940	10	004160060
6,50	101	63	3.500	10	004160065
7,00	109	69	4.030	10	004160070
7,50	109	69	4.330	5	004160075
8,00	117	75	5.180	5	004160080
8,50	117	75	5.630	5	004160085
9,00	125	81	6.560	5	004160090
9,50	125	81	7.040	5	004160095
10,00	133	87	8.100	5	004160100



416/SP19	Ft		
Ø 1÷10 x 0,5 mm	61.350	1	004160419
410/SPVP1	11.750	1	004100421

416P/SP19

19 darab csigafúró hengeres szárral, HSS, AISI M2, kisebb fúróval a precíz, folyamatos központosításhoz

Ø 1+10 x 0,5 mm
MAGASABB FÚRÁSI SEBESSÉG
R ≤ 900 N/mm²
HV ~ 820+850

MAGASABB FÚRÁSI SEBESSÉG



416P/SP19 Ft 66.600 1 004160469
Ø 1+10 x 0,5 mm
115x170x40 mm

417

Rövid vídiás fúró, lágyacélból készült szár, keményfém vágóélel



DIN 8039

Ø mm	L mm	Ft	1	004170003
3	70	1.620	10	004170003
4	75	1.620	10	004170004
5	85	1.720	10	004170005
5L	150	3.870	5	004170105
6	100	1.780	10	004170007
6L	150	3.870	5	004170106
7	120	2.000	10	004170009
8	120	2.210	10	004170010
8L	200	4.170	5	004170113
9	120	2.490	10	004170011
10	120	2.910	10	004170012
10L	200	5.020	5	004170120
12	150	3.810	10	004170014
12L	200	5.470	5	004170125
14	150	5.300	5	004170016
16	150	6.560	5	004170018



417/SP8 Ft 24.700 1 004170100
Ø 3-4-5-6-8-9-10-12 mm

418/K3

kőműves véső készlet SDS-plus csatlakozóval

kőműves véső készlet SDS-plus csatlakozóval



L mm	A mm	A1 mm	Ft	1	004180103
250	20	40	15.600	1	004180103

419

ütvefúró fúrószár, marással kialakítva, keményfém vágóélel
HVA~ 1650



Ø mm	L mm	Ft	10	004190002
4	110	3.340	10	004190002
5	110	3.340	10	004190004
5	160	3.700	10	004190006
6	110	3.280	10	004190012
6	160	3.600	10	004190014
6	210	4.820	10	004190016
7	160	3.970	10	004190028
8	110	3.540	10	004190030
8	160	3.810	10	004190032
8	210	4.570	10	004190034
8	260	6.230	10	004190036
8	310	7.650	10	004190038
8	460	13.950	10	004190042
9	160	4.700	5	004190044
10	160	4.820	5	004190050
10	210	5.590	5	004190052
10	260	6.960	5	004190054
10	310	9.760	5	004190056
10	460	15.400	5	004190060
12	160	5.340	5	004190064
12	210	7.250	5	004190066
12	260	7.810	5	004190068
12	460	16.000	5	004190074
14	160	7.410	3	004190086
14	260	8.910	3	004190090
14	310	12.750	3	004190092
14	460	16.400	3	004190096
16	210	10.950	3	004190112
16	260	11.550	3	004190114
16	310	13.950	3	004190116
16	460	18.400	3	004190120
18	260	14.950	1	004190124
20	310	14.950	1	004190128



419/SP7 Ft 34.200 1 004190507
Ø 5 - 6 - 8 x 110 mm
Ø 6 - 8 - 10 - 12 x 160 mm

419T

ütvefúró fúrószár, marással kialakítva, 4 spirális horonnyal és 4 vágóélel
HVA~ 1650



Ø mm	L mm	Ft	5	004190604
5	110	2.270	5	004190604
5	160	2.530	5	004190606
6	110	2.390	5	004190612
6	160	2.810	5	004190614
6	210	3.810	5	004190616
7	160	2.850	5	004190628
8	110	2.610	5	004190630
8	160	2.940	5	004190632
8	210	3.930	5	004190634
8	260	4.450	5	004190636
8	310	5.470	5	004190638
9	160	3.120	3	004190644
10	160	3.140	3	004190650
10	210	4.170	3	004190652
10	260	4.530	3	004190654
10	310	6.520	3	004190656
10	460	8.830	3	004190660
12	160	3.520	3	004190664
12	210	4.570	3	004190666
12	260	4.860	3	004190668
12	460	9.070	3	004190674
14	160	4.780	2	004190686
14	260	5.590	2	004190690
14	310	7.890	2	004190692
14	460	8.830	2	004190696
16	210	6.320	2	004190712
16	260	8.380	2	004190714
16	310	9.030	2	004190716
16	460	9.350	2	004190720
18	260	10.300	1	004190724
20	310	12.550	1	004190728

420D/SP8

8 darabos hengerelt csigafúró készlet fához, rövid szárral, 2 vágóélel, központosító csúccsal



420D/SP8 Ft 8.460 1 004200200
Ø 3 - 4 - 5 - 6 - 7 - 8 - 9 - 10 mm

421

vezetőcsapos kúpos tágitó
finom fokozat
HSS acélból



DIN 373

M	L mm	Ø mm	D1 mm	D mm	Ft		
3	71	6	3,2	5	12.350	1	004210003
4	71	8	4,3	5	12.350	1	004210004
5	80	10	5,3	8	12.350	1	004210005
6	80	11	6,4	8	12.550	1	004210006
8	100	15	8,4	12,5	20.250	1	004210008
10	100	18	10,5	12,5	24.100	1	004210010
12	100	20	13,0	12,5	26.100	1	004210012



421/SP6	Ft		
M 3-4-5-6-8-10	99.400	1	004210019
421/SPV	7.410	1	004210020

423A-CO

Rövid ponthegészítés lefűrő, HSS-CO 5%,
köszörült



DIN 1412/E

Ø mm	L mm	Ft		
6,5	40	11.350	1	004230115
8,0	40	12.350	1	004230120

424

Kúpos lemezfűrő, HSS



L mm	Ø mm	D mm	Ft		
424/1	58	3÷14	6	14.150	2 004240001
424/2	71	4÷20	8	23.900	2 004240002
424/3	76	16÷30,5	9	40.700	2 004240003
424/4	79	5÷22,5	8	49.800	1 004240004
424/5	103	5÷31	9	67.200	1 004240005
424/6	89	24÷40	10	85.400	1 004240006
424/7	97	36÷50	12	128.300	1 004240007
424/8	103	40÷61	13	212.600	1 004240008



424/SP3	Ft		
424/1+424/2+424/3	81.800	1	004240019
Ø 3÷30,5 mm			
424/SPV	11.350	1	004240020

425

Lépcsős lemezfűrő, HSS



L mm	Ø mm	S mm	D mm	Ft		
425/1	70	4÷12	1 6	24.100	2	004250010
425/2	55	4÷12	2 6	25.300	2	004250012
425/3	85	4÷20	2 10	37.050	2	004250015
425/4	85	12÷20	1 10	56.250	1	004250016
425/5	97	20÷30	1 10	110.500	1	004250017
425/6	75	4÷30	2 10	77.100	1	004250020
425/7	97	30÷40	1 13	153.800	1	004250025
425/8	100	40÷50	1 13	214.200	1	004250029

422

rektifikált központosító fűrőhegyek
tágítási szög 60°
HSS acélból

• A központosító furatok gyors és biztonságos kialakításához



DIN 333/A

Ø mm	D mm	L mm	Ft		
1,60	4,0	35,5	3.870	1	004220116
2,50	6,3	45,0	4.410	1	004220125
3,15	8,0	50,0	4.980	1	004220131

423CO

Ponthegészítés lefűrő, HSS-CO 5%, köszörült



Ø mm	L mm	Ft		
6	66	7.650	5	004230106
7	74	9.350	5	004230107
8	80	10.300	5	004230108
10	89	11.950	5	004230110



425/SP3	Ft		
425/1+425/3+425/6	140.900	1	004250030
Ø 4÷30 mm			
425/SPV	11.350	1	004250035

426

süllyesztő maró
három vágóélel,
HSS



DIN 335-C

GR	Ø mm	L mm	Ø1 mm	Ft		
1	4,3	40	4	8.020	3	004260001
2	5,3	40	4	8.020	3	004260002
3	6,3	45	5	8.380	3	004260003
4	7,3	50	6	9.800	3	004260004
5	8,3	50	6	9.800	3	004260005
6	9,4	50	6	10.950	3	004260006
7	10,4	50	6	12.350	3	004260007
8	12,4	56	8	13.150	3	004260008
9	15,0	60	10	14.950	3	004260009
10	16,5	60	10	15.800	3	004260010
11	20,5	63	10	21.650	3	004260011
12	25,0	67	10	34.200	3	004260012
13	28,0	71	12	46.150	3	004260013
14	31,0	71	12	48.800	3	004260014



DIN 335-C

426/SP6	Ft		
GR 3-5-7-8-10-11	85.800	1	004260030
Ø 6,3÷20,5 mm			
426/SPV	11.350	1	004260035



426A/SP6

6 darabos süllyesztő maró készlet,
három aszimmetrikus vágóélel,
gyorsacélból (HSS)

Ø 6.3 - 8.3 - 10.4 - 12.4 - 16.5 - 20.5 mm



426A/SP6	Ft		
Ø 6,3-8,3-10,4-12,4-16,5-20,5 mm	89.450	1	004260060
100x145x40 mm			

426T

süllyesztő maró
három vágóélel,
HSS + TiN

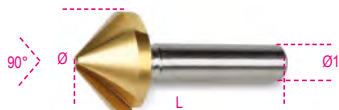

DIN 335-C

GR	Ø mm	L mm	Ø1 mm	Ft		
1	4,3	44	4	10.300	3	004260061
2	5,3	44	4	10.300	3	004260062
3	6,3	44	5	10.700	3	004260063
4	7,3	44	6	11.950	3	004260064
5	8,3	50	6	11.950	3	004260065
6	9,4	50	6	12.750	3	004260066
7	10,4	54	6	14.950	3	004260067
8	12,4	54	8	15.600	3	004260068
9	15,0	56	10	17.400	3	004260069
10	16,5	60	10	19.650	3	004260070
11	20,5	63	10	25.300	3	004260071
12	25,0	66	10	38.450	3	004260072
13	28,0	71	12	48.150	3	004260073
14	31,0	71	12	51.600	3	004260074



DIN 335-C

426T/SP6	Ft		
GR 3-5-7-8-10-11	97.950	1	004260080
Ø 6,3÷20,5 mm			
426/SPV	11.350	1	004260035

426SB

Süllyesztő maró, HSS



	GR	Ø Min mm	Ø Max mm	Ø2 mm	L mm	Ft		
426/SB1	1	2÷5	6	45	10.700	1	004260101	
426/SB2	2	5÷10	8	48	13.350	1	004260102	
426/SB3	3	10÷15	10	65	24.100	1	004260103	
426/SB4	4	15÷20	12	85	46.350	1	004260104	
426/SB5	5	20÷25	12	102	77.950	1	004260105	



426SB/SP4	Ft		
426/SB1-426/SB2	107.700	1	004260130
426/SB3-426/SB4			
Ø 2÷20 mm			
426SB/SPV1	11.350	1	004260135

426MD-3/CP3

mini forgómaró, keményfém

• Lágy típusú keresztvágás forgácsolóval



L mm	Ø mm	Ft		
38,1	3	5.910	1	004260332

426MD-3/CT3

mini forgómaró, keményfém

• Lágy típusú keresztvágás forgácsolóval



L mm	Ø mm	Ft		
37,8	3	5.910	1	004260333

426MD-3/F3

mini forgómaró, keményfém

• Lágy típusú keresztvágás forgácsolóval

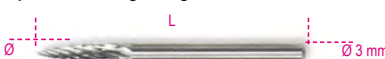

L mm	Ø mm	Ft		
38,3	3	5.910	1	004260334

426MD-3/FA3

mini forgómaró, keményfém

• Lágy típusú keresztvágás forgácsolóval



L mm	Ø mm	Ft		
38,2	3	5.910	1	004260339

426MD-3/OG3

mini forgómaró, keményfém

• Lágy típusú keresztvágás forgácsolóval



L mm	Ø mm	Ft		
38,1	3	5.910	1	004260337

426MD-3/OV3

mini forgómaró, keményfém

• Lágy típusú keresztvágás forgácsolóval



L mm	Ø mm	Ft		
38,2	3	5.910	1	004260331

426MD-3/S3

mini forgómaró, keményfém

• Lágy típusú keresztvágás forgácsolóval



L mm	Ø mm	Ft		
38,0	3	5.910	1	004260338

426MD-3/T3

mini forgómaró, keményfém

• Lágy típusú keresztvágás forgácsolóval



L mm	Ø mm	Ft		
38,3	3	5.910	1	004260336

426MD-3/TA3

mini forgómaró, keményfém

• Lágy típusú keresztvágás forgácsolóval



L mm	Ø mm	Ft		
38,3	3	5.910	1	004260335



426MD-3/A9	Ft		
426MD-3/OV3 - 426MD-3/CP3	53.200	1	004260349
426MD-3/CT3 - 426MD-3/F3			
426MD-3/TA3 - 426MD-3/T3			
426MD-3/OG3 - 426MD-3/S3			
426MD-3/FA3			

426MD/CP

Sülylesztő maró, keményfém

HM6



L mm	Ø mm	Ft		
50	6	16.400	1	004260532
63	8	18.200	1	004260512
63	9,5	20.450	1	004260542
69	12	28.950	1	004260522
69	16	41.500	1	004260552

426MD/CT

Sülylesztő maró, keményfém

HM4



L mm	Ø mm	Ft		
50	6	16.400	1	004260533
63	8	18.200	1	004260513
63	9,5	20.450	1	004260543
69	12	28.950	1	004260523
69	16	40.100	1	004260553

426MD/F

Sülylesztő maró, keményfém

HM4



L mm	Ø mm	Ft		
50	6	16.400	1	004260534
63	8	18.200	1	004260514
63	9,5	20.450	1	004260544
69	12	28.950	1	004260524
69	16	32.800	1	004260554

426MD/FA

Sülylesztő maró, keményfém

HM4



L mm	Ø mm	Ft		
50	6	16.400	1	004260539
63	8	18.200	1	004260519
63	9,5	20.450	1	004260549
69	12	28.950	1	004260529
69	16	37.250	1	004260559

L mm	Ø mm	Ft		
50	6	16.400	1	004260535
67	8	18.200	1	004260515
72	9,5	20.450	1	004260545
73	12	28.950	1	004260525
78	16	41.500	1	004260555

426MD/OG

Sülylesztő maró, keményfém

HM4



L mm	Ø mm	Ft		
50	6	16.400	1	004260537
63	8	18.200	1	004260517
70	10	20.450	1	004260547
76	12	28.950	1	004260527
81	16	41.500	1	004260557

426MD/OV

Sülylesztő maró, keményfém

HM4



L mm	Ø mm	Ft		
50	6	16.400	1	004260531
61	9,5	20.450	1	004260541
67	12	28.950	1	004260521
69	16	37.250	1	004260551

426MD/S

Sülylesztő maró, keményfém

HM4



L mm	Ø mm	Ft		
50	6	16.400	1	004260538
51	8	18.200	1	004260518
53	9,5	20.450	1	004260548
56	12	28.950	1	004260528
59	16	32.800	1	004260558

426MD/T

Sülylesztő maró, keményfém

HM4



L mm	Ø mm	Ft		
50	6	16.400	1	004260536
63	8	18.200	1	004260516
63	9,5	20.450	1	004260546
69	12	28.950	1	004260526
70	16	32.800	1	004260556

426MD/TA

Sülylesztő maró, keményfém

HM4



L mm	Ø mm	Ft		
50	6	16.400	1	004260535
67	8	18.200	1	004260515
72	9,5	20.450	1	004260545
73	12	28.950	1	004260525
78	16	41.500	1	004260555



426MD/SP10	Ft		
426MD/CP-426MD/CT-426MD/F	213.400	1	004260510
426MD/T-426MD/S			
Ø 8-12 mm			

427

Morse-kúpos kiütő, nemesített acélból készült, horganyzott



DIN 317

GR	L mm	A mm	Ft		
0	92	13	5.750	3	004270000
1-2	140	19	8.100	3	004270002
3	190	25	9.760	3	004270003
4	225	30	16.400	3	004270004
5-6	260	35	30.150	3	004270006

428FP

Egyenes hornyú gépi menetfúró, HSS

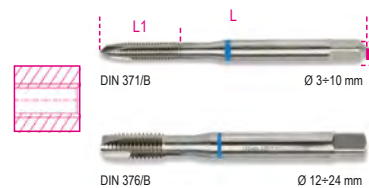

ISO 529

M	mm	L mm	L1 mm	Ft		
3x0,5	2,7	56	11	7.850	10	004280003
4x0,7	3,4	63	13	7.850	10	004280004
5x0,8	4,9	70	16	7.850	10	004280005
6x1	4,9	80	19	8.260	10	004280006
8x1,25	6,2	90	22	9.960	10	004280008
10x1,5	8,0	100	24	11.750	10	004280010
12x1,75	7,0	110	28	15.400	5	004280012
14x2	9,0	110	30	18.600	5	004280014
16x2	9,0	110	32	22.450	5	004280016
18x2,5	11,0	125	34	28.950	3	004280018
20x2,5	12,0	140	34	32.600	3	004280020
22x2,5	14,5	140	34	39.250	3	004280022
24x3	14,5	160	38	42.500	3	004280024

428FP/C7

7 darabos 428FP gépi menetfúró készlet, HSS



	Ft	1	004280203
428FP/C7	49.000	1	004280203
428FP M3÷12			
428F/SPV	8.460	1	004280205

428FC

Csavart hornyú gépi menetfúró, HSS

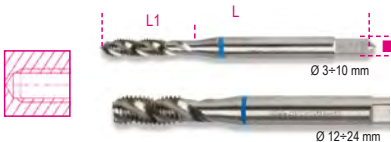

ISO 529

M	■ mm	L mm	L1 mm	Ft	1	004280103
3x0,5	2,7	56	11	9.470	10	004280103
4x0,7	3,4	63	13	9.470	10	004280104
5x0,8	4,9	70	16	9.470	10	004280105
6x1	4,9	80	19	9.760	10	004280106
8x1,25	6,2	90	22	10.500	10	004280108
10x1,5	8,0	100	24	12.550	10	004280110
12x1,75	7,0	110	28	16.000	5	004280112
14x2	9,0	110	30	21.450	5	004280114
16x2	9,0	110	32	25.100	5	004280116
18x2,5	11,0	125	34	33.800	3	004280118
20x2,5	12,0	140	34	36.250	3	004280120
22x2,5	14,5	140	34	44.100	3	004280122
24x3	14,5	160	38	46.750	3	004280124

428FC/C7

7 darabos 428FC gépi menetfúró készlet, HSS



	Ft	1	004280204
428FC/C7	57.900	1	004280204
428FC M3÷12			
428F/SPV	8.460	1	004280205

429FP

Egyenes hornyú gépi menetfúró, HSS-CO 5%

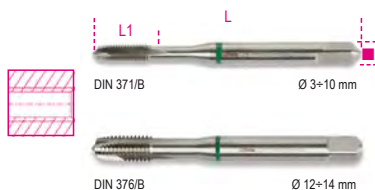

ISO 529

M	■ mm	L mm	L1 mm	Ft	5	004290003
3x0,5	2,7	56	11	10.300	5	004290003
4x0,7	3,4	63	13	10.300	5	004290004
5x0,8	4,9	70	16	10.300	5	004290005
6x1	4,9	80	19	11.150	5	004290006
8x1,25	6,2	90	22	12.350	5	004290008
10x1,5	8,0	100	24	14.550	5	004290010
12x1,75	7,0	110	28	18.000	5	004290012
14x2	9,0	110	30	24.100	5	004290014

429FP/C7

7 darabos 428FP gépi menetfúró készlet, HSS-CO 5%



	Ft	1	004290203
429FP/C7	60.100	1	004290203
429FP M3÷12			
428F/SPV	8.460	1	004280205

429FC

Csavart hornyú gépi menetfúró, HSS-CO 5%



ISO 529

M	■ mm	L mm	L1 mm	Ft	5	004290103
3x0,5	2,7	56	11	12.550	5	004290103
4x0,7	3,4	63	13	12.550	5	004290104
5x0,8	4,9	70	16	12.550	5	004290105
6x1	4,9	80	19	13.150	5	004290106
8x1,25	6,3	90	22	14.750	5	004290108
10x1,5	8,0	100	24	17.600	5	004290110
12x1,75	7,0	110	28	21.450	5	004290112
14x2	9,0	110	30	28.150	5	004290114

429FC/C7

7 darabos 429FC gépi menetfúró készlet, HSS-CO 5%



	Ft	1	004290204
429FC/C7	71.250	1	004290204
429FC M3÷12			
428F/SPV	8.460	1	004280205

430

Kézi menetfúró, metrikus normál menet, króm-acélból



DIN 352 UNI 4535

M	■ mm	L mm	L1 mm	Ft	5	004300002
2x0,4	2,5	36	11	6.800	5	004300002
3x0,5	2,5	40	12	4.820	5	004300003
4x0,7	3,0	45	14	4.820	5	004300004
5x0,8	4,0	48	16	4.980	5	004300005
6x1	5,0	50	18	5.020	5	004300006
7x1	4,5	50	18	6.440	5	004300007
8x1,25	5,0	56	22	6.520	3	004300008
9x1,25	5,5	63	22	8.830	3	004300009
10x1,5	6,0	70	25	8.380	3	004300010
11x1,5	7,0	70	25	10.700	3	004300011
12x1,75	7,0	75	30	10.700	3	004300012
14x2	8,0	80	32	13.550	3	004300014
16x2	10,0	80	32	16.000	3	004300016
18x2,5	11,0	95	40	21.450	1	004300018
20x2,5	12,0	95	40	25.700	1	004300020
22x2,5	14,5	100	40	31.150	1	004300022
24x3	14,5	110	50	37.050	1	004300024



	Ft	1	004300201
430/SP21	57.700	1	004300201
M 3-4-5-6-8-10-12			
430/SPV	11.950	1	004300202

430ASW

Kézi menetfúró, Whitworth menet, króm-acélból DIN 352



DIN 352

BSW	mm	L	L1	Ft	csomagolás	anyag
1/8x40	2,7	40	12	4.740	5	004300031
5/32x32	3,4	45	14	4.740	5	004300032
3/16x24	4,3	48	18	4.740	5	004300033
1/4x20	4,9	50	22	5.510	5	004300034
5/16x18	4,9	56	25	6.680	3	004300035
3/8x16	5,5	70	28	8.830	3	004300036
7/16x14	6,2	70	30	9.960	3	004300037
1/2x12	7,0	75	32	11.150	3	004300038
9/16x12	9,0	80	32	13.550	1	004300039
5/8x11	9,0	80	38	16.200	1	004300040
3/4x10	11,0	95	40	23.700	1	004300041
7/8x9	14,5	100	40	29.550	1	004300042
1"x8	16,0	110	50	38.250	1	004300043

430ASC

Kézi menetfúró, UNC menet, króm-acélból

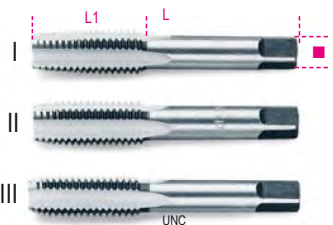

ANSI B1.1

UNC	mm	L	L1	Ft	csomagolás	anyag
1/4x20	4,9	70	30	7.040	5	004300051
5/16x18	4,9	70	30	9.070	5	004300052
3/8x16	5,5	75	35	10.300	3	004300053
7/16x14	6,2	80	40	13.350	3	004300054
1/2x13	7,0	85	45	16.800	3	004300055
9/16x12	9,0	90	45	20.450	3	004300056
5/8x11	9,0	100	47	23.700	3	004300057
3/4x10	11,0	110	50	31.800	3	004300058
7/8x9	14,5	120	60	36.850	1	004300059
1"x8	16,0	130	60	41.500	1	004300060

431

Kézi menetfúró, metrikus normál menet, HSS



DIN 352 UNI 4535

M	mm	L	L1	Ft	csomagolás	anyag
3x0,5	2,5	40	10	9.070	5	004310003
4x0,7	3,3	45	12	9.070	5	004310004
5x0,8	4,2	50	13	9.350	5	004310005
6x1	5,0	56	15	9.350	5	004310006
7x1	6,0	56	16	12.550	5	004310007

M	mm	L	L1	Ft	csomagolás	anyag
8x1,25	6,8	56	18	11.350	3	004310008
10x1,5	8,5	70	24	13.950	3	004310010
12x1,75	10,2	75	29	21.250	3	004310012
14x2	12,0	80	30	29.550	1	004310014
16x2	14,0	80	32	33.400	1	004310016
18x2,5	15,5	95	40	50.200	1	004310018
20x2,5	17,5	95	40	53.650	1	004310020
22x2,5	19,5	100	40	76.900	1	004310022
24x3	21	110	45	86.650	1	004310024



431/SP21	Ft	csomagolás	anyag
M 3-4-5-6-8-10-12	105.300	1	004310201
431/SPV	11.950	1	004310202

433

Kézi menetfúró, metrikus finom menet, króm-acélból készült

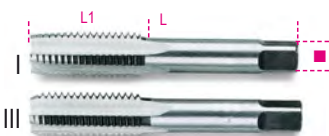

DIN 2181 UNI 4535

M	mm	L	L1	Ft	csomagolás	anyag
6x0,75	4,5	48	16	4.170	5	004330201
7x0,75	4,5	56	18	5.220	5	004330202
8x0,75	5,0	50	16	5.220	5	004330203
8x1	5,0	56	16	5.220	5	004330204
9x0,75	6,0	63	22	6.800	5	004330205
9x1	6,0	63	22	6.800	5	004330206
10x0,75	6,5	63	18	6.800	5	004330207
10x1	6,5	63	18	6.800	5	004330208
10x1,25	6,5	63	18	6.800	5	004330209
11x0,75	7,0	70	25	9.190	3	004330210
11x1	7,0	70	25	9.190	3	004330211
11x1,25	7,0	70	25	9.190	3	004330212
12x0,75	7,0	70	20	8.910	3	004330213
12x1	7,0	70	20	8.910	3	004330214
12x1,25	7,0	70	20	8.910	3	004330215
12x1,5	7,0	70	20	8.910	3	004330216
14x1	8,0	80	32	11.750	1	004330217
14x1,25	8,0	80	32	11.750	1	004330218
14x1,5	8,0	80	32	11.750	1	004330219
16x1	10,0	80	32	13.750	1	004330220
16x1,5	10,0	80	32	13.750	1	004330221
18x1,5	11,0	95	40	16.200	1	004330222
18x2	11,0	80	25	21.250	1	004330223
20x1,5	14,5	80	22	24.100	1	004330224
22x1,5	14,5	80	22	28.750	1	004330225
24x1,5	14,5	80	22	33.400	1	004330226
24x2	14,5	80	22	33.200	1	004330227



433ASF

Kézi menetfúró, UNF menet, króm-acélból

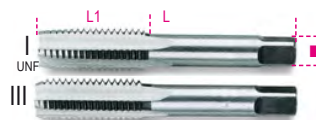

ANSI B1.1

UNF	mm	L	L1	Ft	csomagolás	anyag
1/4x28	4,9	70	30	5.300	5	004330301
5/16x24	4,9	70	30	6.320	5	004330302
3/8x24	5,5	75	35	7.170	3	004330303
7/16x20	6,2	80	40	9.070	3	004330304
1/2x20	7,0	85	45	11.550	3	004330305
9/16x18	9,0	90	45	14.550	3	004330306
5/8x18	9,0	100	47	16.200	3	004330307
3/4x16	11,0	110	50	22.050	3	004330308
7/8x14	14,5	120	60	28.550	1	004330309
1"x12	16,0	130	60	39.050	1	004330310

433ASG

Kézi menetfúró, hengeres gázmenet, króm-acélból



DIN 5157

GAS	mm	L	L1	Ft	csomagolás	anyag
1/8x28	5,5	65	18	7.570	1	004330401
1/4x19	9,0	70	24	9.680	1	004330402
3/8x19	9,0	75	25	11.750	1	004330403
1/2x14	12,0	80	31	16.400	1	004330405
3/4x14	16,0	90	33	27.100	1	004330408
1"x11	20,0	100	39	44.100	1	004330410

434

Kézi menetfúró, metrikus finom menet, HSS

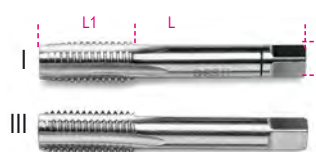

DIN 2181 UNI 4535

M	mm	L	L1	Ft	csomagolás	anyag
6x0,75	5,2	50	15	11.950	5	004340001
8x0,75	7,2	56	18	13.950	5	004340003
8x1	7,0	56	18	13.950	5	004340004
10x0,75	9,2	63	20	17.600	5	004340007
10x1	9,0	63	18	17.600	5	004340008
10x1,25	8,7	70	24	17.600	5	004340009
12x1	11,0	70	20	19.000	3	004340014
12x1,25	10,7	70	20	19.000	3	004340015
12x1,5	10,5	70	20	19.000	3	004340016
13x1,5	11,5	70	22	39.650	1	004340017
14x1	13,0	70	20	23.700	1	004340018
14x1,25	12,7	70	20	23.700	1	004340019
14x1,5	12,5	70	20	20.250	1	004340020
15x1,5	13,5	70	22	39.650	1	004340021
16x1	15,0	70	20	25.300	1	004340022
16x1,5	14,5	70	20	21.850	1	004340023
18x1,5	16,5	80	22	28.350	1	004340024
18x2	16,0	80	22	34.200	1	004340025
20x1,25	18,8	80	22	48.600	1	004340026
20x1,5	18,5	80	22	30.150	1	004340027
20x2	18,0	80	22	37.250	1	004340028
22x1,5	20,5	80	22	43.100	1	004340029
24x1	23,0	90	22	57.700	1	004340030
24x1,5	22,5	90	22	48.600	1	004340031
24x2	22,0	90	22	50.800	1	004340032

435

Állítható hajtóvas menetfúrókhoz



DIN 1814

	□ mm	L mm	Ft		
435/0	2÷5 M1÷M8	170	8.140	3	004350007
435/1	2÷6 M1÷M10	200	9.800	2	004350009
435/1,5	2,5÷6 M1÷M12	200	10.300	2	004350011
435/2	3÷7 M4÷M12	260	14.750	2	004350013
435/3	4÷12 M5÷M20	345	24.500	1	004350020
435/4	5,5÷16 M11÷M27	430	38.050	1	004350027
435/5	7÷18 M13÷M32	770	86.250	1	004350032

435G

Állítható hajtóvas menetfúrókhoz



DIN 1814

	□ mm	L mm	Ft		
435G/0	2÷5 M1÷M8	130	5.790	5	004350108
435G/1	2÷6 M1÷M10	190	7.090	5	004350110
435G/1,5	2÷7 M2÷M12	175	7.410	5	004350112
435G/2	3,4÷7 M4÷M12	280	12.350	5	004350114
435G/3	4,9÷12 M5÷M20	380	19.650	2	004350121
435G/4	7÷16 M11÷M27	500	31.150	2	004350127
435G/5	7÷18 M13÷M32	700	49.200	1	004350132
435G/6	11÷24 M18÷M42	800	81.350	1	004350142

436

Írányváltós racsnis hajtóvas, krómozott

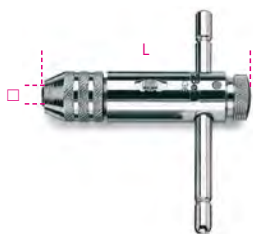

	□ mm	L mm	Ft		
436/1	2÷5 M3÷M8	85	13.550	5	004360002
436/2	4,6÷8 M5÷M12	110	17.200	5	004360004

436L

Írányváltós racsnis hajtóvas, hosszú kivitel, krómozott



	□ mm	L mm	Ft		
436L/1	2÷5 M3÷M8	245	21.450	2	004360012
436L/2	4,6÷8 M5÷M12	295	24.900	2	004360014

436R

Hajtóvasbetét a 436-hoz és a 436L-hez

	Ft		
436R/1	2.510	1	004360022
436R/2	2.850	1	004360024

437P

menetjavító
külső és belső, balos és jobbos menetek
javítására

P 0.80÷3.00 mm



L mm	Ft		
230	22.050	1	004370003

437C

Menetjavító készlet gyújtógyertyához
M14x1,25 mm

• Csavarfelület nagysága : 8,40 - 12,40 - 16,40 mm (5 darab méretenként)



437C	Ft		
	57.500	1	004370100

437C/...

Menetjavító rozsdamentes acélból a 437C-hez



H mm	Ft		
8.4	14.750	1	004370108
12.4	14.750	1	004370112
16.4	14.750	1	004370116

A megadott árak 10 darabra vonatkoznak.

437C/RM14

Menetfúró M14x1,25 gyújtógyertya
menetjavító betéthez



437C/RM14	Ft		
	47.550	1	004370124

437K/9

Keréksavar és anya sérült menetének
helyreállítására való javítókészlet

Lehetővé teszi az eredeti menet javítását és
helyreállítását.

lehetővé teszi az eredeti menet javítását és utánköszörülését

A készlet tartalma:

- Menetfúrók:
M12x1,25 - M12x1,5 - M12x1,75 - M14x1,5
- Menetmetszők:
M12x1,25 - M12x1,5 - M14x1,5



Ø 12 - 24 mm

437K/9	Ft		
	39.850	1	004370029

161x123x50 mm

437K/12

Féltengely sérült menetének helyreállítására
való javítókészlet

Lehetővé teszi az eredeti menet javítását és
helyreállítását.

lehetővé teszi az eredeti menet javítását és utánköszörülését

A készlet tartalma:

- Metrikus méret:
M16x1,0 - M16x1,5 - M20x1,0 - M20x1,5 - M22x1,5 - M24x1,5 -
M24x2,0 - M27x2,0
- Hüvelyk méret:
3/4x16 - 3/4x20 - 13/16x20 - 27/32x20



Ø 32 - 35 mm

437K/12	Ft		
	47.550	1	004370032

220x118x52 mm



437K/33

izzítógyertya sérült menet javítókészlet

Perselyek:

M8x1,0 - M10x1,0 - M10x1,25 - M12x1,25

Tüskék:

M8x1,0 - M10x1,0 - M10x1,25 - M12x1,0 - M12x1,25 - M14x1,25



437K/33	Ft	1	004370133
210x150x50 mm			

437U/09

Menetjavító készlet M5-M6-M8-M10-M12



25 x M5, M6, M8, M10
10 x M12

437U/09	Ft	1	004370550
M5x0,8			
M6x1,0			
M8x1,25			
M10x1,5			
M12x1,75			
370x230x55 mm - 2 Kg			

437U/E-M...

Menetjavító rozsdamentes acélból



M	H mm	Ft	1	004370555
M5	7.5	8.540	1	004370555
M6	9	8.540	1	004370556
M8	12	11.750	1	004370558
M10	15	15.600	1	004370560
M12	18	9.760	1	004370562

A megadott árak 25 darabra vonatkoznak (10 darabos az M12-es)

437U/PM

Fúró és menetmetsző a 437U/09-hez



M	Ft	1	004370565
M5	16.000	1	004370565
M6	16.800	1	004370566
M8	22.450	1	004370568
M10	29.550	1	004370570
M12	37.050	1	004370572

438A

fúró, menetvágó és süllyesztő készlet, HSS

- M3 - M4 - M5 - M6 - M8 - M10
- Mágneses csavartartó



1/4
S MAX mm = Ø mm

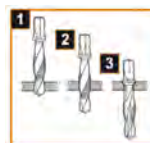

438A	Ft	1	004380010
53.850			

438...

Fúró, menetvágó és süllyesztő készlet

HSS 1/4"

1/4



M	S max mm	Ft	2	004380103
M3	3	10.300	2	004380103
M4	4	10.300	2	004380104
M5	5	10.300	2	004380105
M6	6	10.300	2	004380106
M8	8	11.750	2	004380108
M10	10	11.750	2	004380110



440

Menetmetsző, metrikus normál menet, krómaccélból

R ≤ 600 N/mm²
HRC | 60+61

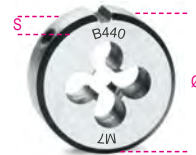

UNI 4535
DIN 223

M	Ø x S mm	Ft	5	004400002
2x0,4	25,4 x 9	8.180	5	004400002
3x0,5	25,4 x 9	6.030	5	004400003
4x0,7	25,4 x 9	6.030	5	004400004
5x0,8	25,4 x 9	5.180	5	004400005
6x1	25,4 x 9	5.180	5	004400006
7x1	25,4 x 9	5.180	5	004400007
8x1,25	25,4 x 9	5.180	5	004400008
9x1,25	25,4 x 9	5.180	5	004400009
10x1,5	25,4 x 9	5.180	5	004400010
12x1,75	25,4 x 9	5.180	5	004400012

440A

Menetmetsző, metrikus normál menet, krómaccélból

R ≤ 600 N/mm²
HRC | 60+61

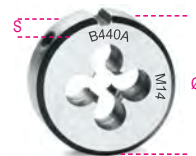

UNI 4535
DIN 223

M	Ø x S mm	Ft	3	004400110
10x1,5	38,1 x 14	7.410	3	004400110
11x1,5	38,1 x 14	7.410	3	004400111
12x1,75	38,1 x 14	7.410	3	004400112
14x2	38,1 x 14	7.410	3	004400114
16x2	38,1 x 14	7.410	3	004400116
18x2,5	38,1 x 14	8.580	3	004400118
20x2,5	38,1 x 14	9.470	3	004400120

440B

Menetmetsző, metrikus normál menet, krómaccélból

R ≤ 600 N/mm²
HRC | 60+61



UNI 4535
DIN 223

M	Ø x S mm	Ft	3	004400122
18x2,5	50,8 x 16	13.150	3	004400122
20x2,5	50,8 x 16	13.750	3	004400124
22x2,5	50,8 x 16	14.950	3	004400126
24x3	50,8 x 16	15.200	3	004400128

440ASW

Menetmetsző, Whitworth menet,
krómaccélből
R ≤ 600 N/mm²



UNI EN 22568
DIN 223

BSW	Ø x S mm	Ft	UN	IT
1/8x40	25,4 x 9	7.000	5	004400201
5/32x32	25,4 x 9	7.000	5	004400202
3/16x24	25,4 x 9	6.230	5	004400203
1/4x20	25,4 x 9	6.230	5	004400204
5/16x18	25,4 x 9	6.230	5	004400205
3/8x16	38,1 x 14	8.910	3	004400206
7/16x14	38,1 x 14	8.910	3	004400207
1/2x12	38,1 x 14	9.190	3	004400208
9/16x12	38,1 x 14	9.190	3	004400209
5/8x11	50,8 x 16	16.000	3	004400210
3/4x10	50,8 x 16	16.000	3	004400211
7/8x9	50,8 x 16	18.400	3	004400212
1"x8	50,8 x 16	18.400	3	004400213

440ASC

Menetmetsző, UNC menet,
krómaccélből

R ≤ 600 N/mm²



UNI EN 22568
DIN 223

UNC	Ø x S mm	Ft	UN	IT
1/4x20	25,4 x 9	6.190	5	004400221
5/16x18	25,4 x 9	6.190	5	004400222
3/8x16	38,1 x 14	8.580	3	004400223
7/16x14	38,1 x 14	8.580	3	004400224
1/2x13	38,1 x 14	8.580	3	004400225
9/16x12	38,1 x 14	8.580	3	004400226
5/8x11	50,8 x 16	18.000	3	004400227
3/4x10	50,8 x 16	18.000	3	004400228
7/8x9	50,8 x 16	18.000	3	004400229
1"x8	50,8 x 16	18.000	3	004400230

440ASF

Menetmetsző, UNF menet,
krómaccélből

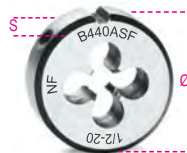

UNI EN 2258
DIN 223

UNF	Ø x S mm	Ft	UN	IT
1/4x28	25,4 x 9	6.560	5	004400241
5/16x24	25,4 x 9	6.560	5	004400242
3/8x24	38,1 x 14	9.350	3	004400243
7/16x20	38,1 x 14	9.350	3	004400244
1/2x20	38,1 x 14	9.350	3	004400245
9/16x18	38,1 x 14	9.350	3	004400246
5/8x18	50,8 x 16	19.000	3	004400247
3/4x16	50,8 x 16	19.000	3	004400248
7/8x14	50,8 x 16	19.000	3	004400249
1"x12	50,8 x 16	19.000	3	004400250

440ASG

Menetmetsző, hengeres gáz-menet,
krómaccélből

R ≤ 600 N/mm²



UNI EN 24231
DIN 223

GAS	Ø x S mm	Ft	UN	IT
1/8x28	38,1 x 14	7.410	3	004400255
1/4x19	38,1 x 14	7.410	3	004400256
3/8x19	38,1 x 14	7.410	3	004400257
1/2x14	50,8 x 16	15.200	3	004400259
3/4x14	50,8 x 16	15.200	3	004400260
1"x11	63,5 x 19	29.550	3	004400261

441

Menetmetsző, metrikus finom menet,
krómaccélből

R ≤ 600 N/mm²
HRC || 60+61

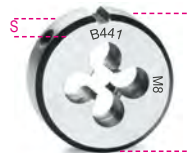

UNI 4535
DIN 223

M	Ø x S mm	Ft	UN	IT
6x0,75	25,4 x 9	6.230	5	004410004
7x0,75	25,4 x 9	6.230	5	004410005
8x0,75	25,4 x 9	6.230	5	004410006
8x1	25,4 x 9	6.230	5	004410007
9x0,75	25,4 x 9	6.230	5	004410008
9x1	25,4 x 9	6.230	5	004410009

441A

Menetmetsző, metrikus finom menet,
krómaccélből

R ≤ 600 N/mm²
HRC || 60+61

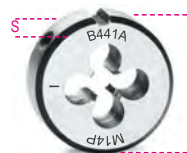

UNI 4535
DIN 223

M	Ø x S mm	Ft	UN	IT
10x0,75	38,1 x 14	9.350	3	004410100
10x1	38,1 x 14	9.350	3	004410101
10x1,25	38,1 x 14	9.350	3	004410102
11x0,75	38,1 x 14	9.350	3	004410103
11x1	38,1 x 14	9.350	3	004410104
11x1,25	38,1 x 14	9.350	3	004410105
12x0,75	38,1 x 14	9.350	3	004410106
12x1	38,1 x 14	9.350	3	004410107
12x1,25	38,1 x 14	9.350	3	004410108
12x1,5	38,1 x 14	9.350	3	004410109
14x1	38,1 x 14	9.350	3	004410110
14x1,25	38,1 x 14	9.350	3	004410111
14x1,5	38,1 x 14	9.350	3	004410112
16x1	38,1 x 14	9.350	3	004410113
16x1,5	38,1 x 14	9.350	3	004410114
18x1,5	38,1 x 14	9.350	3	004410115

441B

Menetmetsző, metrikus finom menet,
krómaccélből

R ≤ 600 N/mm²
HRC || 60+61

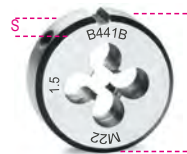

UNI 4535
DIN 223

M	Ø x S mm	Ft	UN	IT
18x1,5	50,8 x 16	17.400	3	004410117
18x2	50,8 x 16	17.400	3	004410118
20x1,5	50,8 x 16	17.600	3	004410119
22x1,5	50,8 x 16	18.400	3	004410120
24x1,5	50,8 x 16	18.600	3	004410121
24x2	50,8 x 16	18.600	3	004410122



442

Menetmetsző, metrikus normál menet, HSS

HRC ▯ 62+63
AISI M2



UNI EN 22568
DIN 223

M	ØxS mm	Ft	🔧	📦
3x0,5	20x5	7.250	3	004420003
4x0,7	20x5	7.250	3	004420004
5x0,8	20x7	7.410	3	004420005
6x1	20x7	7.410	3	004420006
7x1	25x9	8.260	3	004420007
8x1,25	25x9	8.260	3	004420008
10x1,5	30x11	9.350	3	004420010
12x1,75	38x14	15.800	3	004420012
14x2	38x14	20.250	1	004420014
16x2	45x18	25.700	1	004420016
18x2,5	45x18	27.100	1	004420018
20x2,5	45x18	27.100	1	004420020

443

Menetmetsző, metrikus finom menet, HSS

HRC ▯ 62+63
AISI M2



UNI EN 22568
DIN 223

M	ØxS mm	Ft	🔧	📦
6x0,75	20x7	12.550	1	004430107
8x0,75	25x9	13.750	1	004430110
8x1	25x9	13.150	1	004430111
10x0,75	30x11	17.000	1	004430113
10x1	30x11	15.200	1	004430114
10x1,25	30x11	15.200	1	004430115
12x1	38x10	24.700	1	004430116
12x1,25	38x10	24.700	1	004430117
12x1,5	38x10	24.700	1	004430118
13x1,5	38x10	29.350	1	004430119
14x1	38x10	24.700	1	004430120
14x1,25	38x10	24.700	1	004430121
14x1,5	38x10	24.700	1	004430122
15x1,5	38x10	33.000	1	004430123
16x1	45x14	36.450	1	004430124
16x1,5	45x14	36.450	1	004430125
18x1,5	45x14	36.450	1	004430127
20x1,25	45x14	37.650	1	004430129
20x1,5	45x14	37.650	1	004430130
20x2	45x14	37.650	1	004430131
22x1,5	55x16	45.350	1	004430132
24x1	55x16	46.950	1	004430133
24x1,5	55x16	46.950	1	004430135
24x2	55x16	49.600	1	004430136

444

Metsző hajtóvas



UNI EN 22568
DIN 225

	Ø mm	L mm	Ft	🔧	📦
444	20x5	190	9.840	5	004440005
444/0	20x7	190	9.840	5	004440007
444/1	25,4x9,5	210	10.300	5	004440025
444/1A	25x9	215	10.500	5	004440027
444/1B	30x11	250	12.350	5	004440030
444/C	38x10	310	15.600	3	004440033
444/1C	38x14	310	15.600	3	004440035
444/2	38,1x12,7	300	16.000	3	004440038
444/1D	45x14	445	21.850	1	004440045
444/2D	45x18	445	21.850	1	004440046
444/3	50,8x15,9	520	31.350	1	004440050
444/4	55x16	495	31.350	1	004440055
444/5A	63,5x19	520	54.050	1	004440057

444G

Metsző hajtóvas



UNI EN 22568
DIN 225

	Ø mm	L mm	Ft	🔧	📦
444G/A	16x5	160	4.620	5	004440103
444G	20x5	185	5.340	5	004440105
444G/0	20x7	185	5.340	5	004440107
444G/1	25,4x9,5	215	6.520	5	004440125
444G/1A	25x9	215	6.520	5	004440127
444G/1B	30x11	265	8.380	5	004440130
444G/C	38x10	315	12.350	3	004440133
444G/1C	38x14	315	12.350	3	004440135
444G/2	38,1x12,6	310	12.350	3	004440138
444G/1D	45x14	450	16.000	1	004440145
444G/2D	45x18	450	16.400	1	004440146
444G/3	50,8x16	485	17.200	1	004440150
444G/4	55x16	560	20.650	1	004440155
444G/5A	63,5x19	630	36.450	1	004440163
444G/6	65x18	630	38.650	1	004440165



446/C30

Krómacél menetfúró és menetmetsző készlet, metrikus normál menet és tartozékok



446/C30 Ft 150.200 1 004460055
📦 325x220x35 mm - 🏠 3,2 Kg

430 M mm	440 M mm	🔧	📦
3x0,5	3x0,5	435/1,5	444/1
4x0,7	4x0,7		
5x0,8	5x0,8		
6x1	6x1		
8x1,25	8x1,25		
10x1,5	10x1,5		
12x1,75	12x1,75		

446/C48

Krómacél menetfúró és menetmetsző készlet, metrikus normál menet és tartozékok



446/C48 Ft 284.600 1 004460057
📦 580x300x50 mm - 🏠 5 Kg

430 M mm	440 M mm	440A M mm	🔧	📦
3x0,5	3x0,5	10x1,5	435/1	444/1
4x0,7	4x0,7	12x1,75	435/3	444/2
5x0,8	5x0,8	14x2		
6x1	6x1	16x2		
8x1,25	8x1,25	18x2,5		
10x1,5		20x2,5		
12x1,75				
14x2				
16x2				
18x2,5				
20x2,5				

446/C110

Krómacél menetfúró és menetmetsző készlet, metrikus normál és finom menet és tartozékok



446/C110 Ft 411.300 1 004460060

500x337x60 mm - 8,1 Kg

430	433	440/440A	441/441A
M	M	M	M
mm	mm	mm	mm
2x0,4	6x0,75	2x0,4	6x0,75
3x0,5	7x0,75	3x0,5	7x0,75
4x0,7	8x0,75	4x0,7	8x0,75
5x0,8	8x1	5x0,8	8x1
6x1	9x0,75	6x1	9x0,75
7x1	9x1	7x1	9x1
8x1,25	10x0,75	8x1,25	10x0,75
9x1,25	10x1	9x1,25	10x1
10x1,5	10x1,25	10x1,5	10x1,25
11x1,5	11x0,75	11x1,5	11x0,75
12x1,75	11x1	12x1,75	11x1
14x2	11x1,25	14x2	11x1,25
16x2	12x0,75	16x2	12x0,75
	12x1		12x1
	12x1,25		12x1,25
	12x1,5		12x1,5
	14x1		14x1
	14x1,25		14x1,25
	14x1,5		14x1,5
	16x1		16x1
	16x1,5		16x1,5
	18x1,5		18x1,5

435/0	444/1	436/1
435/3	444/2	

446ASF/C29

Krómacél menetfúró és menetmetsző készlet, UNF menet



446ASF/C29 Ft 325.900 1 004460070

660x410x50 mm - 6 Kg

433ASF	440ASF		
1/4	1/4	435/1,5	444/1
5/16	5/16	435/3	444/2
3/8	3/8		444/3
7/16	7/16		
1/2	1/2		
9/16	9/16		
5/8	5/8		
3/4	3/4		

446ASC/C37

Krómacél menetfúró és menetmetsző készlet, UNC menet



446ASC/C37 Ft 349.000 1 004460080

660x410x50 mm - 6,7 Kg

430ASC	440ASC		
1/4	1/4	435/1,5	444/1
5/16	5/16	435/3	444/2
3/8	3/8		444/3
7/16	7/16		
1/2	1/2		
9/16	9/16		
5/8	5/8		
3/4	3/4		

446ASW/C36

Krómacél menetfúró és menetmetsző készlet, Whitworth menet



446ASW/C36 Ft 240.900 1 004460075

525x310x50 mm - 3,4 Kg

430ASW	440ASW		
1/8	1/8	435/1,5	444/1
5/32	5/32	435/2	444/2
3/16	3/16		
1/4	1/4		
5/16	5/16		
3/8	3/8		
7/16	7/16		
1/2	1/2		

446ASG/C23

Krómacél menetfúró és menetmetsző készlet, hengeres gázmenet



446ASG/C23 Ft 508.100 1 004460085

700x430x70 mm - 9,8 Kg

433ASG	440ASG		
1/8	1/8	435/3	444/2
1/4	1/4	435/5	444/3
3/8	3/8		444/5A
1/2	1/2		
3/4	3/4		
1"	1"		



447/C37

HSS menetfúró és menetmetsző készlet, metrikus normál menet



447/C37 Ft 303.700 1 004470055

≡ 380x185x35 mm - 3,9 Kg

431 M mm	442 M mm		
3x0,5	3x0,5	435/0	444
4x0,7	4x0,7	435/2	444/0
5x0,8	5x0,8		444/1A
6x1	6x1		444/1B
8x1,25	8x1,25		444/1C
10x1,5	10x1,5		
12x1,75	12x1,75		

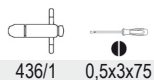

436/1 0,5x3x75

447/C53

HSS menetfúró és menetmetsző készlet, metrikus normál menet



447/C53 Ft 631.600 1 004470060

≡ 500x235x50 mm - 9 Kg

431 M mm	442 M mm			
3x0,5	3x0,5	435/1,5	444	436/1
4x0,7	4x0,7	435/3	444/0	436/2
5x0,8	5x0,8		444/1A	
6x1	6x1		444/1B	
8x1,25	8x1,25		444/1C	
10x1,5	10x1,5		444/2D	
12x1,75	12x1,75			
14x2	14x2			
16x2	16x2			
18x2,5	18x2,5			
20x2,5	20x2,5			

447/C70

HSS menetfúró és menetmetsző készlet, metrikus normál és finom menet



447/C70 Ft 795.500 1 004470065

≡ 510x340x70 mm - 7,5 Kg

431 M mm	434 M mm	442 M mm	443 M mm
3x0,5	8x1	3x0,5	8x1
4x0,7	10x1,25	4x0,7	10x1,25
5x0,8	12x1,25	5x0,8	12x1,25
6x1	12x1,5	6x1	12x1,5
7x1	14x1,25	7x1	14x1,25
8x1,25	14x1,5	8x1,25	14x1,5
10x1,5	16x1,5	10x1,5	16x1,5
12x1,75		12x1,75	
14x2		14x2	
16x2		16x2	

435/0	444	436/1
435/3	444/0	
	444/1A	
	444/1B	
	444/C	
	444/1C	
	444/1D	
	444/2D	

450

Koronafúró, bimetál, HSS-Co 8%

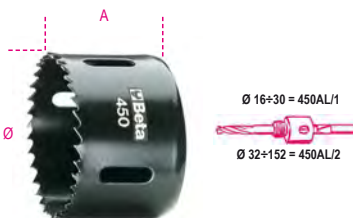

HSS-Co 8%

Ø mm	Ø	A mm	Ft		
16	(5/8)	57	8.020	1	004500016
17	(11/16)	57	8.020	1	004500017
19	(3/4)	51	8.020	1	004500019
20	-	51	8.020	1	004500020
21	(13/16)	51	8.020	1	004500021
22	(7/8)	51	8.020	1	004500022
24	(15/16)	51	8.020	1	004500024
25	(1")	51	8.830	1	004500025
27	(1 1/16)	51	9.150	1	004500027
29	(1 1/8)	51	9.150	1	004500029
30	(1 3/16)	51	9.150	1	004500030
32	(1 1/4)	51	9.150	1	004500032

Ø mm	Ø	A mm	Ft		
33	(1 5/16)	51	9.350	1	004500033
35	(1 3/8)	51	10.500	1	004500035
37	(1 7/16)	51	10.500	1	004500037
38	(1 1/2)	44	10.700	1	004500038
40	(1 9/16)	44	11.150	1	004500040
41	(1 5/8)	44	11.350	1	004500041
43	(1 11/16)	44	11.350	1	004500043
44	(1 3/4)	44	11.750	1	004500044
46	(1 13/16)	44	11.750	1	004500046
48	(1 7/8)	44	11.950	1	004500048
51	(2")	44	12.550	1	004500051
52	(2 1/16)	44	13.950	1	004500052
54	(2 1/8)	44	13.950	1	004500054
57	(2 1/4)	44	13.950	1	004500057
59	(2 5/16)	44	14.750	1	004500059
60	(2 3/8)	44	14.750	1	004500060
64	(2 1/2)	44	15.400	1	004500064
65	(2 9/16)	44	15.400	1	004500065
67	(2 5/8)	44	15.400	1	004500067
68	-	44	15.400	1	004500068
70	(2 3/4)	44	15.800	1	004500070
73	(2 7/8)	44	15.800	1	004500073
76	(3")	44	16.200	1	004500076
79	(3 1/8)	44	17.200	1	004500079
83	(3 1/4)	44	17.800	1	004500083
86	(3 3/8)	44	17.800	1	004500086
89	(3 1/2)	44	18.600	1	004500089
92	(3 5/8)	44	19.850	1	004500092
95	(3 3/4)	44	20.650	1	004500095
98	(3 7/8)	44	21.250	1	004500098
102	(4")	44	22.050	1	004500102
105	(4 1/8)	44	24.100	1	004500105
108	(4 1/4)	44	29.750	1	004500108
111	(4 3/8)	44	34.000	1	004500111
114	(4 1/2)	44	40.100	1	004500114
121	(4 3/4)	44	44.750	1	004500121
127	(5")	44	49.000	1	004500127
140	(5 1/2)	44	59.700	1	004500140
152	(6")	44	69.250	1	004500152

450AL

Fellevőszár, központfúróval

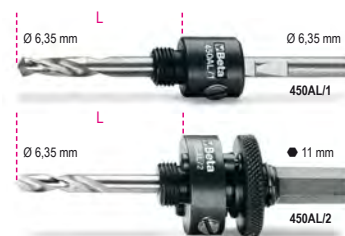

	Ø mm	L mm	Ft		
450AL/1	16÷30	54	9.800	1	004500210
450AL/2	32÷152	70	22.650	1	004500215

450AD

Koronafúró adapter



	Ø mm	Ft		
450AD	32÷51	3.850	1	004500230



450PA/1

Központfúró a 450AL/1 típusú felvevőszárhoz, HSS

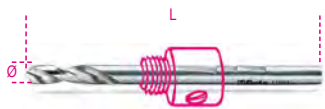

ØxL mm	Ft		
6,35x105	6.070	1	004500252

450PA/2

Központfúró a 450AL/2 típusú felvevőszárhoz, HSS

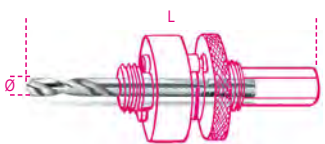

ØxL mm	Ft		
6,35x80	6.070	1	004500253

450PR

Felvevőszár hosszabbító



L mm	Ft		
305	16.400	1	004500255

450/C9

Koronafúró készlet villanszerelőknek, ütésálló műanyag dobozban



HSS-Co 8%

450/C9	Ft		
	116.200	1	004500305

450	Ø 22 - 29 - 35 - 44 - 51 - 64 mm
450AL	/1 - /2
450AD	220x160x60 mm - 1,6 Kg

450/C13

Koronafúró készlet
gáz- és vízvezetékszerelőknek,
ütésálló műanyag dobozban



HSS-Co 8%

450/C13	Ft		
	145.700	1	004500310

450	Ø 19 - 22 - 29 - 35 - 38 44 - 51 - 57 - 64 mm
450AL	/1 - /2
450PA/1	
450AD	215x180x65 mm - 1,8 Kg

450/C15

koronafúró és tartozék készlet
villanszerelőknek



HSS-Co 8%

450/C15	Ft		
	190.400	1	004500313

450	Ø 16 - 20 - 25 - 32 - 40 51 - 60 - 65 - 70 mm
450AL	/1 - /2
450PA	/1 - /2
450PR	
450AD	420x185x60 mm - 3,2 Kg

450/C21

Koronafúró készlet ipari használatra



HSS-Co 8%

450/C21	Ft		
	331.900	1	004500315

450	Ø 19 - 22 - 29 - 35 - 38 44 - 51 - 57 - 64 - 76 83 - 92 - 95 - 105 - 114 mm
450AL	/1 - /2
450PA	/1 - /2
450PR	
450AD	420x280x60 mm - 7 Kg

451

Koronafúró HSS, köszörült



Ø mm	L mm	D mm	Ft		
12	85	8	11.950	1	004510012
13	85	8	11.950	1	004510013
14	85	8	12.350	1	004510014
15	85	10	12.350	1	004510015
16	85	10	12.350	1	004510016
17	85	10	12.350	1	004510017
18	85	10	12.350	1	004510018
19	85	10	12.550	1	004510019
20	85	10	13.150	1	004510020
21	85	10	14.150	1	004510021
22	85	10	14.950	1	004510022
23	85	10	15.600	1	004510023
24	85	10	16.000	1	004510024
25	85	10	16.400	1	004510025
26	90	10	17.400	1	004510026
27	90	10	17.800	1	004510027
28	90	10	18.200	1	004510028
29	90	10	19.000	1	004510029
30	90	10	19.250	1	004510030
31	90	10	20.250	1	004510031
32	90	10	20.650	1	004510032
33	90	10	21.450	1	004510033
34	90	10	22.050	1	004510034
35	90	10	22.650	1	004510035
36	85	10	23.700	1	004510036
37	85	10	24.100	1	004510037
38	85	10	24.500	1	004510038
39	85	10	25.100	1	004510039
40	85	10	25.700	1	004510040
41	85	10	26.300	1	004510041
42	85	10	27.550	1	004510042
43	85	10	28.550	1	004510043
44	85	10	28.950	1	004510044
45	85	10	29.550	1	004510045
46	85	10	29.550	1	004510046
47	85	10	30.550	1	004510047
48	85	10	32.000	1	004510048
49	85	10	33.000	1	004510049
50	85	10	33.000	1	004510050

451/C

8 darabos koronafúró készlet,
HSS, köszörült



451/C8	Ft	1	004510308
Ø 16-18-20-22-25-30-32-35 mm	154.700		
270x225x70 mm			

451GA

Felvevőszár



M	Ø	L	D	Ft	1	004510101
10x1,25	12÷14	57	8	6.840		
12x1,25	15÷34	57	10	6.840		1 004510102
14x1,5	35÷50	57	10	8.380		1 004510105

451PA

Központfúró a felvevőszárhoz,
HSS



Ø	L	Ft	1	004510103
6	53	3.850		

451PR

Felvevőszár hosszabbító a 451 típusú
HSS-koronafúróhoz



M	Ø	L	Ø1	Ft	1	004510104
12x1,25	15÷34	400	13	29.750		
14x1,5	35÷50	400	13	29.750		1 004510108



452

Keményfémlapkás koronafúró

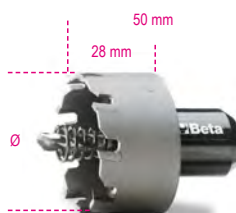

Ø	Ø1	Ft	1	004520015
15	10	49.200		
16	10	49.200		1 004520016
17	10	49.200		1 004520017
18	10	49.200		1 004520018
19	10	49.200		1 004520019
20	10	49.200		1 004520020
21	10	49.200		1 004520021
22	10	49.200		1 004520022
23	10	49.200		1 004520023
24	10	49.200		1 004520024
25	10	49.200		1 004520025
26	10	55.450		1 004520026
27	10	55.450		1 004520027
28	10	55.450		1 004520028
29	10	55.450		1 004520029
30	10	55.450		1 004520030
31	10	66.800		1 004520031
32	10	66.800		1 004520032
33	10	66.800		1 004520033
34	10	66.800		1 004520034
35	10	66.800		1 004520035
36	10	77.550		1 004520036
37	10	77.550		1 004520037
38	10	77.550		1 004520038
39	13	77.550		1 004520039
40	13	77.550		1 004520040
41	13	87.450		1 004520041
42	13	87.450		1 004520042
43	13	87.450		1 004520043
44	13	87.450		1 004520044
45	13	87.450		1 004520045
46	13	98.400		1 004520046
47	13	98.400		1 004520047
48	13	98.400		1 004520048
49	13	98.400		1 004520049
50	13	98.400		1 004520050
55	13	111.700		1 004520055
60	13	148.200		1 004520060
65	13	148.200		1 004520065
70	13	172.900		1 004520070
75	13	188.300		1 004520075
80	13	204.500		1 004520080
85	13	230.800		1 004520085
90	13	244.500		1 004520090

452GA

Felvevőszár



452GA/1	Ø	Ft	1	004520125
	mm			
452GA/2	15÷21	6.110		
452GA/3	22÷38	7.130		1 004520126
	39÷100	8.500		1 004520127

460

koronafúró építőanyagokhoz

- Beton, cement, természetes és műkő fúrásához
- Maximum fúrásmélység: 60 mm

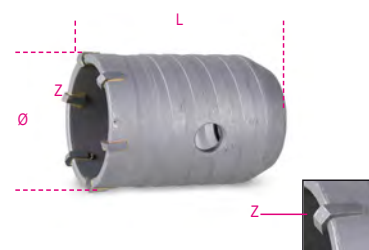

Ø	L	Z	Ft	1	004600050
50	75	6	25.100		
60	75	6	29.750		1 004600060
65	75	6	31.150		1 004600065
80	75	6	46.350		1 004600080
90	75	6	49.000		1 004600090
100	75	8	60.100		1 004600100
112	75	8	68.800		1 004600112
125	80	10	85.400		1 004600125
150	80	12	115.400		1 004600150

460PP

előfúró az építőanyagokhoz ajánlott 460 típusú
koronafúróhoz



Ø	L	Ft	1	004600201
8	120	2.850		

460G

szár a 460 típusú koronafúróhoz



L	Ft	1	004600222
220	15.600		
370	21.650		1 004600237
460	34.200		1 004600246

A nyomatéksokszorozók az anyák és csavarok meghúzásának elengedhetetlen eszközei, mivel szűk vagy nehezen hozzáférhető helyeken nagyobb forgatónyomaték létrehozását teszik lehetővé, mint amit használója egyébként alkalmazna. Nem igényelnek nagy méretű hosszabbításokat, és így teljes biztonságot nyújtanak. A Beta nyomatéksokszorozói különféle megoldásokat és teljesítményeket kínálnak 9500 Nm-ig, 125:1 nyomaték szorzó aránnyal. Sok modell – különösen a legnagyobb teljesítményűek – kétirányú visszaütésgátlóval vannak felszerelve, amely megakadályozza a veszélyes húzóerő visszajutását a szerszám használójához. A Beta nyomatéksokszorozóinak mindegyike rendelkezik azt igazoló tanúsítvánnyal, hogy a szerszámot optimális üzemi körülmények között, maximális értéken tesztelték.



Kezelési útmutató

A nyomatéksokszorozót **nyomatékkulccsal együtt kell használni** a kimeneti nyomaték szabályozásának biztosítása érdekében; továbbá mindig **dugókulcsokkal** kell használni.

Az egyes nyomatéksokszorozók arányai határozzák meg a bemeneti és a kimeneti nyomaték közötti szorzótényezőt. Példa: nyomaték szorzó aránya 5:1. A nyomatékkulcson beállított 100 Nm bemeneti nyomaték alkalmazása 500 Nm kimeneti nyomatékot visz át az anyára vagy a csavarra.

Azonban meg kell győződni arról, hogy a meghúzással érintett minden alkatrész megfelelően illeszkedjen. Kerülje a **hosszabbítások** használatát, mivel ezek megcsavarodhatnak, és így olyan rugóhatás jöhet létre, ami módosíthatja a kívánt nyomaték értékét.

Mindig ellenőrizze, hogy a nyomatéksokszorozó reakciókarja olyan erős szerkezethez legyen rögzítve, vagy támaszkodjon, amely ellenáll a reakcióerőnek. Főszabályként a megmunkálni tervezett darab közelében található megfelelő merevségű falak vagy csavarok használhatók. A reakciókar mindig a meghúzás irányával **ellentétes** irányban forog.

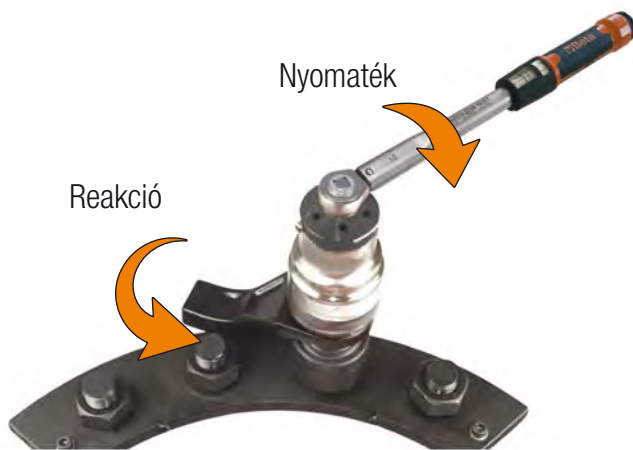

Óra járásával megegyező



Óra járásával ellentétes



Zökkenőmentesen és megszakítás nélkül alkalmazza.

A meghúzási feszültség a nyomatéksokszorozó ellentétes irányba történő forgatásával oldható fel - mielőtt azt leválasztaná. Ha a nyomatéksokszorozót csavarodásgátló rendszerrel látták el, a meghúzási feszültséget az irányváltókaron keresztül kell feloldani.

A fenti utasítások a **kicsavazási** műveletekre is vonatkoznak.

560/C3

Nyomatéksokszorozó, jobb- és bal irányú meghúzáshoz, műanyag ládában, áttétel 3,8:1, visszaütésgátlóval

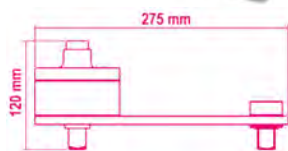

Nm	kgfm	lbf.ft	□	■	kg
1500	150	1110	1/2"	3/4"	3,9
Ft					
405.300					
1 005600030					
400x260x110 mm					

560/C3PLUS

Nyomatéksokszorozó, jobb- és bal irányú meghúzáshoz, műanyag ládában, áttétel 3,8:1, visszaütésgátlóval



Nm	kgfm	lbf.ft	□	■	kg
2700	270	1991	3/4"	1"	7,5
Ft					
472.100					
1 005600038					
470x240x160 mm					

560/C2

Nyomatéksokszorozó, jobb- és bal irányú meghúzáshoz, tartozékokkal, áttétel 5:1, műanyag kofferban



Nm	Kgfm	lbf.ft	□	■	kg
1300	130	960	1/2"	3/4"	3,8
Ft					
824.200					
1 005600020					
560/2					
613.400					
1 005600002					
560/18					
19.450					
1 005600018					
560/19					
40.900					
1 005600019					
560/22					
142.100					
1 005600022					
310x275x120 mm					

560/C4+

Nyomatéksokszorozó, jobb- és bal irányú meghúzáshoz, tartozékokkal, áttétel 5:1, kitámasztó karral



Nm	Kgfm	lbf.ft	□	■	kg
2700	270	2000	3/4"	1"	5
Ft					
809.600					
1 005600042					
560/4					
639.700					
1 005600004					
560/18					
19.450					
1 005600018					
560/22					
142.100					
1 005600022					
310x275x120 mm					

560/C6

Nyomatéksokszorozó, jobb- és bal irányú meghúzáshoz, áttétel 6,5:1, műanyag kofferban



Nm	kgfm	lbf.ft	□	■	kg
1500	150	1106	1/2"	3/4"	6
Ft					
421.900					
1 005600160					
400x260x110 mm					

560/C12

Nyomatéksokszorozó, jobb- és bal irányú meghúzáshoz, áttétel 12:1, műanyag kofferban



Nm	kgfm	lbf.ft	□	■	kg
2500	250	1844	1/2"	1"	7
Ft					
605.300					
1 005600210					
400x260x110 mm					

561/1

Nyomatéksokszorozó, irányváltós racsnival, áttétel 5:1, két kitámasztó karral

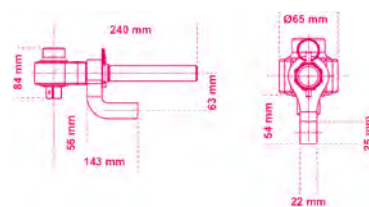

Nm	kgfm	lbf.ft	□	■	kg
1000	100	740	1/2"	3/4"	2,7
Ft					
591.100					
1 005610010					
270x210x70 mm					

562-1/VA - 562-2/VA

jobb- és balos nyomatéksorozó
 áttétel 5,2:1
 562VV-A táskában



Nm	Kgfm	lbf.ft	□	■	D	A	L min	L max	h
1700	170	1250	3/4	1"	mm	mm	mm	mm	kg
					108	95	85	220	8,8

562-1/VA **1.310.500** 1 005620601

Nm	Kgfm	lbf.ft	□	■	D	A	L min	L max	h
3400	340	2500	3/4	1"	mm	mm	mm	mm	kg
					119	115	85	265	10,5

562-2/VA **1.585.800** 1 005620602

564-3R/V - 564-4R/V

nyomatéksorozó jobb- és bal irányú
 meghúzáshoz

áttétel 25:1
 visszaütegátlóval
 fémdobozban



Nm	Kgfm	lbf.ft	□	■	D	A	L	h
4000	400	3000	1/2	1"	mm	mm	mm	kg
					92	185	205	7,6

564-3R/V **2.550.600** 1 005640613

☞ 390x310x145 mm

Nm	Kgfm	lbf.ft	□	■	D	A	L	h
7000	700	5000	1/2	1 1/2"	mm	mm	mm	kg
					120	200	210	13,2

564-4R/V **3.016.200** 1 005640614

☞ 500x435x170 mm

565-1R/VA - 565-2R/VA - 565-3R/VA

jobb- és balos nyomatéksorozó
 áttétel 27:1
 visszaütegátlóval
 562VV-A táskában



Nm	Kgfm	lbf.ft	□	■	D	A	L min	L max	h
1700	170	1250	1/2	1"	mm	mm	mm	mm	kg
					108	125	80	215	11,2

565-1R/VA **2.120.200** 1 005650611

Nm	Kgfm	lbf.ft	□	■	D	A	L min	L max	h
3400	340	2500	1/2	1"	mm	mm	mm	mm	kg
					119	145	85	265	13,6

565-2R/VA **2.768.000** 1 005650612

Nm	Kgfm	lbf.ft	□	■	D	A	L min	L max	h
3400	340	2500	1/2	1 1/2"	mm	mm	mm	mm	kg
					119	145	85	265	14,2

565-3R/VA **2.921.900** 1 005650613

565-4R/VB

jobb- és balos nyomatéksorozó
 áttétel 27:1
 visszaütegátlóval
 565VV-B táskában

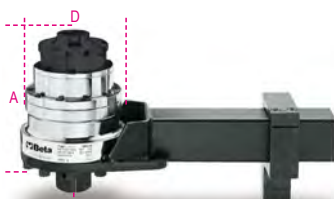

Nm	Kgfm	lbf.ft	□	■	D	A	L min	L max	h
6000	600	4500	1/2	1 1/2"	mm	mm	mm	mm	kg
					144	180	125	335	22,4

565-4R/VB **3.301.200** 1 005650614

565-5R/VB

jobb- és balos nyomatéksorozó
 áttétel 27:1
 visszaütegátlóval
 565VV-B táskában



Nm	Kgfm	lbf.ft	□	■	D	A	L min	L max	h
9500	950	7000	3/4	1 1/2"	mm	mm	mm	mm	kg
					184	180	155	355	30,4

565-5R/VB **5.617.000** 1 005650615

567-4R/VB

jobb- és balos nyomatéksorozó
 áttétel 135:1
 visszaütegátlóval
 565VV-B táskában

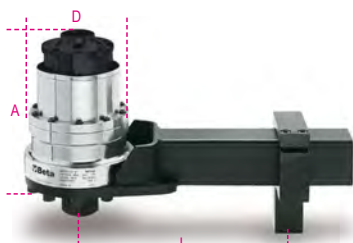

Nm	Kgfm	lbf.ft	□	■	D	A	L min	L max	h
6000	600	4500	1/2	1 1/2"	mm	mm	mm	mm	kg
					144	210	125	335	24,4

567-4R/VB **3.665.600** 1 005670614

567-5R/VB

jobb- és balos nyomatéksorozó
 áttétel 135:1
 visszaütegátlóval
 565VV-B táskában

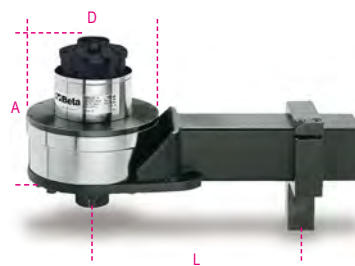

Nm	Kgfm	lbf.ft	□	■	D	A	L min	L max	h
9500	950	7000	1/2	1 1/2"	mm	mm	mm	mm	kg
					184	210	155	350	32,4

567-5R/VB **6.293.100** 1 005670615

562VV-A

nyomatéksorozó hordozótáska,
 tartós polipropilén, szivacsbelés

Belső méret: 380x270x180 mm



562VV-A **112.100** 1 005620501

562/1-562/2-564/3R
 564/4R-565/1R-565/2R
 565/3R

☞ 410x340x205 mm - h 3,5 kg

565VV-B

nyomatéksorozó hordozótáska,
 tartós polipropilén, szivacsbelés

Belső méret: 480x370x205 mm



565VV-B **151.400** 1 005650502

565/4R-565/5R
 567/4R-567/5R

☞ 520x435x230 mm - h 5,4 kg



A nyomatékkulcsokat mindig a markolat közepén kell megfogni, hogy ne változhasson meg a erőkar nagysága. Zökkenőmentesen és megszakítás nélkül alkalmazza, kerülje a hirtelen rántásokat.

A beállító skálát használatot követően nullára kell állítani, hogy ne befolyásolja a meghúzás pontosságát. Erre a folyamatra a Zero-Reset nyomatékkulcsoknál nincsen szükség.

A Beta a nyomatékkulcsok széles választékát kínálja, négy különböző alap modell segítségével.

MÉRŐTÁRCSÁS MODELLEK

Az alkalmazott meghúzási nyomaték összenyomja a tekercsrugót, és a mérőtárcsa közvetlenül kijelzi az értéket. Az alkalmazott nyomaték valós időben olvasható le a mutató segítségével. Egy második mutató a nyomaték célértékére állítható. Amikor eléri a nyomaték célértékét, a második mutatót a fő mutató megfogja, és rögzíti a csúcsértéket. A mérőtárcsás nyomatékkulcsok hosszú időn át nyújtanak figyelemreméltó pontosságot és tartósságot.

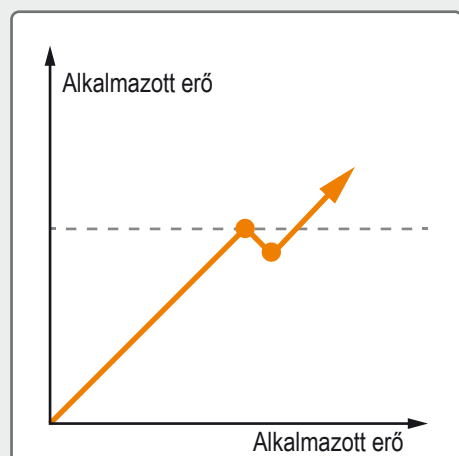

KIOLDÓ MODELLEK

A kioldó nyomatékkulcsok a legnépszerűbb modellek, mert könnyen használhatók. A rugós terhelésnek köszönhetően lehetővé teszik a nyomaték gyors előválasztását. A nyomatékérték az alkalmazott erő növelésével együtt növekszik. Amikor eléri a kívánt nyomatékértéket, hirtelen kioldás következik be, és a kulcs kb. 3-5°-ig nem alkalmaz meghúzási erőt. Ha az eszköz használója nem szakítja meg a mozgást, a nyomaték folyamatosan növekszik, és így túllépi a szükséges értékeket.

ÖNKIOLDÓ MODELLEK

Az önkieldő nyomatékkulcsok a kioldó modellekhez hasonlóan működnek, de a kívánt nyomatékérték elérésekor a kar hirtelen kiold (kb. 20°). Ezáltal a szerszám használója könnyebben abbahagyhatja az erő kifejtést. Ezeket a szerszámokat többnyire magas nyomatékértékekhez használják, rendkívül hosszú karokkal.

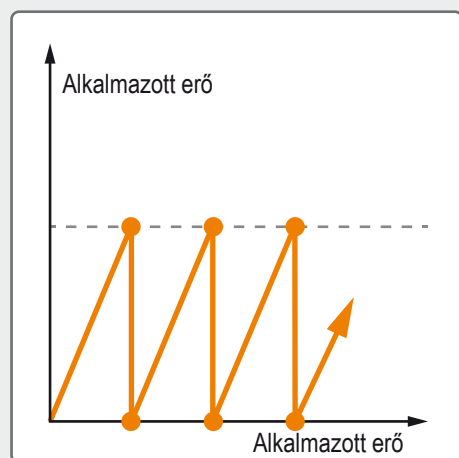
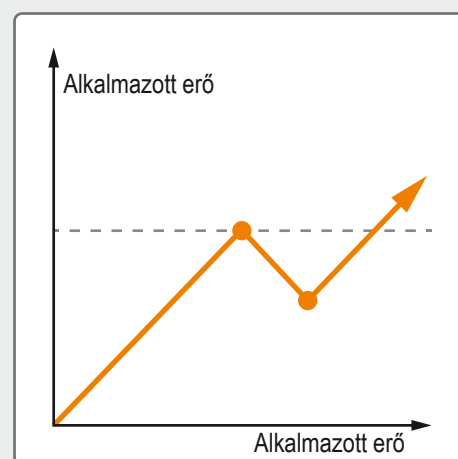

CSÚSZÓ MODELLEK

Az előre beállított nyomatékérték elérésekor a csúszó mechanizmus leállítja a nyomaték alkalmazását, és így a szerszám inaktív lesz. Megakadályozza a szükségesnél magasabb nyomatékértékekkel történő meghúzást. Erő további alkalmazása esetén a ciklus megismétlődik. Ideális eszközök alacsony nyomatékértékű sorrendben végzett műveletekhez (elektronikai és mikromechanikai ipar), ahol rendkívül fontos a törékeny vagy kisméretű alkatrészek törésének elkerülése.



NYOMATÉKULCSOK HÚZÁSI NYOMATÉK TARTOMÁNYA

1 Nm = 0,10197 Kgf·m = 0,7375 lbf·ft

			Nm																					
			0	10	20	30	40	50	60	70	80	90	100	200	300	400	500	600	700	800	900	1000	1500	2000
14"	590		0,8	4																				
	590/1		2,5	12,5																				
	599DGT-AW/30			6	30																			
	603/5		1	5																				
	603/10		2	10																				
	605E/5		1	5																				
	605E/10		2	10																				
	605BC/15		3	15																				
	605DGT/2			4	20																			
	666/2			5	25																			
	666 LBF.FT/2			4 LBF.FT	18 LBF.FT																			
3/8"	592/3			5	25																			
	592/4			8	40																			
	599DGT/6			12	60																			
	599DGT-AW/135				27	135																		
	666/2X			5	25																			
	666/5			10	50																			
	666/10			20	100																			
	666 LBF.FT/2X			4 LBF.FT	18 LBF.FT																			
	666 LBF.FT/5			7 LBF.FT	37 LBF.FT																			
	666 LBF.FT/10			15 LBF.FT	75 LBF.FT																			
	668RGC/6			12	60																			
668RGC/10			20	100																				
12"	594/8			16	80																			
	594/21			40	200																			
	599DGT/10X			20	100																			
	599DGT/20			40	200																			
	599DGT/30			68	340																			
	599DGT-AW/340			68	340																			
	606MQ/50			5	50																			
	610/5			90	130																			
	610L/5			90	130																			
	610L/5L			120	200																			
	666/10X			20	100																			
	666/20			40	200																			
	666/30			60	300																			
	666 LBF.FT/10X			15 LBF.FT	75 LBF.FT																			
	666 LBF.FT/20			30 LBF.FT	150 LBF.FT																			
	666 LBF.FT/30			50 LBF.FT	230 LBF.FT																			
	667/20			40	200																			
	667/30			60	300																			
	668RGC/10X			20	100																			
668RGC/20			40	200																				

Kgf·m 0 1 2 3 4 5 6 7 8 9 10 20 30 40 50 60 70 80 90 100 150 200

lbf·ft 0 10 20 30 40 50 60 70 100 200 300 400 500 600 700 1100 1500

Beta

581

Önkioldó nyomatéksavarhúzó, mérőskála nélkül

Jobb
Pontosság: ±6%
(588 - 682 modellhez)



UNI EN ISO 6789

Nm	gfm	lbf.ft	A	L	kg
1,2÷6	120÷600	1/4"	275		

581 132.400 1 005810001

583

Önkioldó nyomatéksavarhúzó Jobb
Pontosság: ±6%



UNI EN ISO 6789

Nm	gfm	lbf.ft	A	L	kg
0,3÷1,5	30÷150	1/4"	240	0,05	

583/1,5 148.600 1 005830015

Nm	gfm	lbf.ft	A	L	kg
0,6÷3	60÷300	1/4"	240	0,1	

583/3 148.600 1 005830030

Nm	gfm	lbf.ft	A	L	kg
1,2÷6	120÷600	1/4"	350	0,2	

583/6 148.600 1 005830060

583/C31

1 nyomatéksavarhúzó, 8 hatlapú dugókulcs, 20 csavarhúzóbetét és 2 tartozék



583/C31 207.400 1 005830931

583/6	1,2 - 6 Nm
900	4-5-5,5-6-7-8-9-10 mm
860LP	0,6x4,5 - 1x5,5 - 1,2x6,5 mm
860PH	PH1 - PH2 (x2) - PH3
860PE	2-2,5-3-4-5 mm
860TX	T9-T10-T15-T20-T25-T27-T30-T40
882P/80	80 mm
892/0	1/4" 1/4"

270x120x45 mm - 1,2 kg

590 - 592

Mérőtárcsás nyomatékkulcs
Jobbos és balos
Pontosság: ±4%

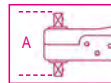

UNI EN ISO 6789

Nm	Kgfm	lbf.in	A	L	kg
0,8÷4	0,08÷0,4	7÷35	1/4	60	253

590 351.000 1 005900001

Nm	Kgfm	lbf.in	A	L	kg
2,5÷12,5	0,25÷1,25	21÷110	1/4	60	253

590/1 351.000 1 005900003

Nm	Kgfm	lbf.in	A	L	kg
1÷27	0,1÷2,7	10÷240	3/8	70	253

592/3 348.600 1 005920005

Nm	Kgfm	lbf.in	A	L	kg
3÷40	0,3÷4	20÷360	3/8	70	253

592/4 348.600 1 005920007

594

Mérőtárcsás nyomatékkulcs
Jobbos és balos
Pontosság: ±4%

12"

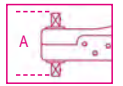

UNI EN ISO 6789

Nm	Kgfm	lbf.ft	A	L	kg
16÷80	1,6÷8	12÷60	1/2	85	455

594/8 528.300 1 005940011

Nm	Kgfm	lbf.ft	A	L	kg
40÷200	4÷20	30÷160	1/2	85	530

594/21 528.300 1 005940015

Nyomatékkulcs-kalibrálással kapcsolatos információk az árlista végén található!

596

Mérőtárcsás nyomatékkulcs
Jobbos és balos
Pontosság: ±4%

A meghatározott meghúzási nyomaték elérésekor fényjelzésen kívül hangjelzést is ad.

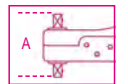

UNI EN ISO 6789

Nm	Kgfm	lbf.ft	A	L	kg
80÷400	8÷40	60÷300	3/4	111	710

596/40SL 872.500 1 005960010

Nm	Kgfm	lbf.ft	A	L	kg
160÷800	16÷80	120÷600	3/4"	115	1025

596/80SL 1.097.200 1 005960020

Beta

Beta

599DGT

elektronikus nyomatékulcs
irányváltós racsnival
jobb és bal oldali meghúzáshoz
meghúzási pontosság +/- 2% jobb irányban,
± 3% bal irányban

- Kettős mérési mód: csúcs és maradvány
- A beállított nyomaték elérését fényjelzések és egy szaggatott hangjelzés mutatja
- Tápfeszültség 2 db 1,5V elemmel (együtt szállítva)



UNI EN ISO 6789

Nm	Kgfm	lbf.ft	D	A	L	W	W
12÷60	1,2÷6	8÷44	3/8	30	33	413	0,9 0,1

Ft		W	W
599DGT/6	185.800	1	005990003

Nm	Kgfm	lbf.ft	D	A	L	W	W
20÷100	2÷10	15÷80	1/2	30	37	413	0,9 0,1

Ft		W	W
599DGT/10X	191.100	1	005990010

Nm	Kgfm	lbf.ft	D	A	L	W	W
40÷200	4÷20	30÷150	1/2	40	43	520	2 0,1

Ft		W	W
599DGT/20	198.800	1	005990020

Nm	Kgfm	lbf.ft	D	A	L	W	W
68÷340	6,8÷34	58÷280	1/2	40	43	640	2,35 0,1

Ft		W	W
599DGT/30	214.200	1	005990030

599DGT-AW

Elektronikus nyomatékulcs nyomaték és szög
leolvasással, irányváltós racsnival és vezeték
nélküli adatátvitellel, jobbirányú (+/- 2%
pontosság) és balirányú (+/- 3% pontosság)
meghúzáshoz

- Meghúzási típusok: nyomaték, szög, nyomaték + szög
- Kettős mérési mód: csúcs és maradvány
- Fény-, és szaggatott hangjelzés mellett érzhető rezgés tájékoztat a nyomaték vagy a szögérték eléréséről
- Az utolsó 999 csúcs nyomaték és/vagy szög értékek tárolhatók és megjeleníthetők
- 9 előre beállítható és menthető mód
- Kétféleképp vezeték nélküli tömeges adatátvitel a nyomatékulcs és a szoftver között, utólag és valós időben
- Biztonsági gombreteszelés
- A nyomatékulcs a szoftverrel adott felhasználóhoz társítható
- Követhető meghúzási adatok. A szoftver lehetővé teszi a dátum és az időpont, a szerszám sorozatszáma, a beállított meghúzási érték, az elért érték rögzítését, és a felhasználói azonosítóhoz társítását
- Egyedi adatfeldolgozó szoftver közvetlen, könnyen leolvasható OK/NG (JÓ/ROSSZ) eredménnyel és valós idejű grafikon megjelenítés
- Csúszásmentes kétkomponensű markolat
- Nyomatékulcs + 9 nyelvű szoftver
- A következő tartozékokkal: 3 db AA - 1.5V elem, vezeték nélküli vevőegység és szoftver USB kulcs



UNI EN ISO 6789

Nm	Kgfm	lbf.ft	D	A	L	W	W
6÷30	0,6÷3	4,5÷22	1/4	23,7	20,4	410	0,8 0,1

Ft		W	W
599DGT-AW/30	472.100	1	005990702

Nm	Kgfm	lbf.ft	D	A	L	W	W
27÷135	2,7÷13,5	20÷100	3/8	30,5	27	445	1 1,0

Ft		W	W
599DGT-AW/135	481.000	1	005990713

Nm	Kgfm	lbf.ft	D	A	L	W	W
68÷340	6,8÷34	50÷250	1/2	40	37	615	1,5 1,0

Ft		W	W
599DGT-AW/340	512.100	1	005990734

Nyomatékulcs-kalibrálással kapcsolatos
információk az árlista végén található!



600

Nyomatékszögmérő

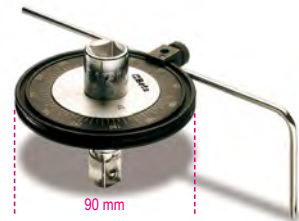

	□	■	Ft	W	W
600/1	1/2	1/2	74.300	1	006000001
600/2	3/4	3/4	84.200	1	006000002

601C

Digitális szögmérő szögértékes meghúzáshoz
Az előre beállított szögérték elérését fény- és
szaggatott hangjelzés kíséri.

az előre beállított szögérték elérését
fényjelzés és
szaggatott hangjelzés mutatja



Ft		W	W
601C	100.000	1	006010100

601CA

digitális szögmérő nyomaték
és szögérték meghúzáshoz

az előre beállított nyomaték vagy szögérték elérését
fényjelzés és egy
szaggatott hangjelzés mutatja



□	■	Nm	W	Ft	W	W
1/2"	1/2"	40÷200	0,1	176.900	1	006010120

120x90x120 mm - W 240 g

603

Önkioldó nyomatékkulcs
Jobbos
Pontosság: $\pm 6\%$



UNI EN ISO 6789

Nm	Kgfm	lbf.in	■	A	L	■	■
1÷5	0,1÷0,5	10÷45	1/4	35	195	235	0,05

603/5		Ft	■	■
		301.200	1	006030005

Nm	Kgfm	lbf.in	■	A	L	■	■
2÷10	0,2÷1,0	18÷90	1/4	35	195	235	0,1

603/10		Ft	■	■
		308.100	1	006030010

604B

Önkioldó nyomatékkulcs
jobb- és bal forgásirányú
pontosság: $\pm 6\%$



UNI EN ISO 6789

Nm	Kgfm	lbf.in	■	■	L	■	■
1÷5	0,1÷0,5	10÷45	8	220	290	0,025	

604B/5		Ft	■	■
		195.500	1	006040015

Nm	Kgfm	lbf.in	■	■	L	■	■
2÷10	0,2÷1,0	18÷90	8	220	300	0,05	

604B/10		Ft	■	■
		195.500	1	006040020

605E

Kioldó nyomatékkulcs
Írányváltós racsnival
Jobb és bal oldali meghúzáshoz
Pontosság: $\pm 6\%$



UNI EN ISO 6789

Nm	Kgfm	lbf.in	■	A	L	■	■
1÷5	0,1÷0,5	10÷45	1/4	20	190	180	0,05

605E/5		Ft	■	■
		100.400	1	006050105

Nm	Kgfm	lbf.in	■	A	L	■	■
2÷10	0,2÷1,0	18÷90	1/4	20	190	180	0,1

605E/10		Ft	■	■
		104.900	1	006050110

605BC/15

Kioldó nyomatékkulcs irányváltós racsnival,
jobb oldali meghúzáshoz, kompakt, alumínium,
meghúzási pontosság: $\pm 4\%$



UNI EN ISO 6789

Nm	Kgfm	lbf.in	■	D	A	L	■	■
3÷15	0,3÷1,5	26÷133	1/4	26	29	175	215	0,1

605BC/15		Ft	■	■
		97.950	1	006050015

605DGT/2

Elektronikus nyomatékkulcs
irányváltós racsnival
jobb és bal oldali meghúzáshoz,
meghúzási pontosság $\pm 3\%$ (jobb oldali)
 $\pm 4\%$ (bal oldali)

- Kettős mérési mód: csúcs és maradvány
- A beállított nyomaték elérését fényjelzések és szaggatott hangjelzés mutatja
- Tápfeszültség: 1 db 1,5V AAA elemmel (együtt szállítva)



UNI EN ISO 6789

Nm	Kgcm	lbf.ft	■	D	A	L	■	■
4÷20	0,4÷2	35÷177	1/4	20	20	210	175	0,01

605DGT/2		Ft	■	■
		120.200	1	006050302

610/5

Kioldó nyomatékkulcs
irányváltós racsnival
jobb oldali meghúzáshoz,
5 beállított értékkel,
meghúzási pontosság: $\pm 4\%$

Választható nyomatékértékek:
90 - 100 - 110 - 120 - 130 Nm



UNI EN ISO 6789

Nm	■	D	A	L	■	■
90÷130	1/2	42	39	490	1330	10

610/5		Ft	■	■
		83.800	1	006100025

610L/5

Kioldó nyomatékkulcs
L-formájú karral
jobb oldali meghúzáshoz,
5 beállított értékkel,
meghúzási pontosság: $\pm 4\%$

Választható nyomatékértékek:
90 - 100 - 110 - 120 - 130 Nm



UNI EN ISO 6789

Nm	■	L	L1	■	■
90÷130	1/2	470	80	1350	10

610L/5		Ft	■	■
		74.300	1	006100125

610L/5L

Kioldó nyomatékkulcs
L-formájú karral,
jobb oldali meghúzáshoz,
5 beállított értékkel,
meghúzási pontosság: $\pm 4\%$

Választható nyomatékértékek:
120 - 140 - 160 - 180 - 200 Nm



UNI EN ISO 6789

Nm	■	L	L1	■	■
120÷200	1/2	470	80	1400	20

610L/5L		Ft	■	■
		76.500	1	006100150

611

Kettős működésű racsnival
a 604B/5 és a 604B/10 modellel
Külső négyzet: 8 mm



■	L	Ft	■	■
1/4	42,5	70.450	1	006110001

Nyomatékkulcs-kalibrálással kapcsolatos
információk az árlista végén található!

612 ÷ 614

Írányváltós racsní
Ø 16 mm csatlakozóval rendelkező
nyomatékkulcshoz



612 és 612X nem használható 100 Nm feletti
meghúzási nyomatéknál

	■	L mm	LA mm	Ft	🔧	📄
612	3/8	66	32	31.550	2	006120000
612X	1/2	66	32	33.400	2	006120010
614	1/2	71	32	36.450	2	006140000
614X	3/4	71	32	39.850	2	006140004

614/50

Átnyomós racsní
Ø 16 mm csatlakozóval rendelkező
nyomatékkulcshoz



	■	L mm	LA mm	Ft	🔧	📄
614/50	1/2	71	32	33.400	2	006140002

Tartalék forgó alkatrészek



111

615

kétirányú racsní
nyomatékkulcshoz
szögletes csatlakozóval



■ mm	■	L mm	LA mm	Ft	🔧	📄
9x12	3/8	53	28,8	26.700	1	006150010
9x12	1/2	53	28,8	26.700	1	006150020
14x18	1/2	70	39,8	26.700	1	006150120



616 - 617 - 619

Fix négyszög fej Ø 16 mm nyomatékkulcshoz

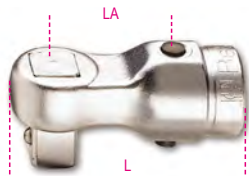

	■	L mm	LA mm	Ft	🔧	📄
616	1/4	61	32	24.900	1	006160000
617	3/8	61	32	24.900	1	006170000
619	1/2	63	32	24.900	1	006190000

621

betéttartó tartozék
nyomatékkulcshoz
szögletes csatlakozóval



	■	L mm	LA mm	Ft	🔧	📄
621P 1/4	9x12	14	43 28,8	31.800	1	006210000
* 621P 5/16	14x18	5/16	52,5 32,5	48.800	1	006210110

*Figyelem! Számítsa ki újra a beállítandó nyomaték
értékét a fejezet elején található táblázat alapján.

622

megfordítható racsní
nyomatékkulcshoz,
kerek fejű, Ø 22 mm

3/4"

1"



	■	L mm	LA mm	Ft	🔧	📄
622 3/4	3/4	110	56	88.850	1	006220019
622 1"	1	110	56	108.100	1	006220024

641

Villáskulcs fejek
a 604B/5 és a 604B/10 modellhez
Külső négyszög: 8 mm



■ mm	L mm	Ft	🔧	📄
4	37	37.850	1	006410003
5	37	37.850	1	006410004
5,5	37	37.850	1	006410005
6	37	37.850	1	006410006
7	37	37.850	1	006410007
8	42	37.850	1	006410008
9	42	37.850	1	006410009
10	42	37.850	1	006410010

642

Villáskulcsfejek

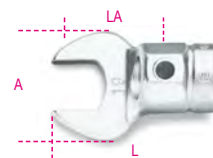

■ mm	L mm	LA mm	A mm	Ft	🔧	📄
8	54	32	22	26.900	1	006420008
10	57	32	26	26.900	1	006420010
12	58	32	30	26.900	1	006420012
13	58	32	30	26.900	1	006420013
14	59	32	32	26.900	1	006420014
15	59	32	35	26.900	1	006420015
16	59	32	38	26.900	1	006420016
17	60	32	39	26.900	1	006420017
18	61	32	42	26.900	1	006420018
19	61	32	43	26.900	1	006420019
20	61	32	50	41.900	1	006420020
21	62	32	53	41.900	1	006420021
22	62	32	53	45.950	1	006420022
23	65	32	53	45.950	1	006420023
24	63	32	53	45.950	1	006420024
25	64	32	53	56.050	1	006420125
26	64	32	59	56.050	1	006420026
27	65	32	59	56.050	1	006420027
28	66	32	64	56.050	1	006420028
30	66	32	66	56.050	1	006420030
32	67	32	66	56.050	1	006420032
* 36	76	42	80	76.900	1	006420036
* 40	77	52	95	76.900	1	006420040
* 41	78	52	95	76.900	1	006420041
* 46	90	52	95	92.700	1	006420046

*Figyelem! Számítsa ki újra a beállítandó nyomaték
értékét a fejezet elején található táblázat alapján.



643

villáskulcs
nyomatékkulcshoz
szögletes csatlakozóval

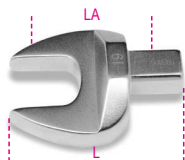

mm	mm	L mm	LA mm	Ft		
7	9x12	37	28,8	23.700	1	006430007
8	9x12	37	28,8	23.700	1	006430008
10	9x12	39	28,8	23.700	1	006430010
12	9x12	39	28,8	23.700	1	006430012
13	9x12	39	28,8	23.700	1	006430013
14	9x12	43	28,8	23.900	1	006430014
15	9x12	43	28,8	23.900	1	006430015
16	9x12	43	28,8	23.900	1	006430016
17	9x12	43	28,8	23.900	1	006430017
*18	9x12	47	36,3	23.900	1	006430018
*19	9x12	51	36,3	23.900	1	006430019
*21	9x12	52	36,3	37.050	1	006430021
*22	9x12	52	36,3	37.050	1	006430022

*Figyelem! Számítsa ki újra a beállítandó nyomaték értékét a fejezet elején található táblázat alapján.

mm	mm	L mm	LA mm	Ft		
13	14x18	60	39,8	24.700	1	006430113
14	14x18	58	39,8	24.700	1	006430114
15	14x18	60	39,8	24.700	1	006430115
16	14x18	60	39,8	24.900	1	006430116
17	14x18	60	39,8	24.900	1	006430117
18	14x18	61	39,8	24.900	1	006430118
19	14x18	61	39,8	24.900	1	006430119
21	14x18	61	39,8	39.050	1	006430121
22	14x18	62	39,8	39.050	1	006430122
24	14x18	64	39,8	39.050	1	006430124
*27	14x18	68	44,8	44.100	1	006430127
*30	14x18	77	49,8	44.350	1	006430130
*32	14x18	77	49,8	44.350	1	006430132
*34	14x18	80	54,8	70.450	1	006430134
*36	14x18	83	54,8	70.450	1	006430136
*38	14x18	83	54,8	70.450	1	006430138
*41	14x18	91	64,8	70.450	1	006430141

*Figyelem! Számítsa ki újra a beállítandó nyomaték értékét a fejezet elején található táblázat alapján.

644

villáskulcsfejek
nyomatékkulcshoz,
kerek fejű, Ø 22 mm



mm	L mm	LA mm	A mm	Ft		
22	91	56	52	45.950	1	006440022
24	91	56	52	45.950	1	006440024
27	94	56	64	56.050	1	006440027
30	94	56	64	56.050	1	006440030
32	97	56	75,5	56.050	1	006440032
34	97	56	75,5	56.050	1	006440034
36	97	56	75,5	76.900	1	006440036
41	103,5	56	94	76.900	1	006440041
46	115,5	56	94	92.700	1	006440046

650A

állítható villáskulcs
nyomatékkulcshoz
szögletes csatlakozóval



A min-max mm	mm	L mm	LA mm	Ft		
*5-27	9x12	93	74,3	43.100	1	006500027
*5-30	9x12	106	85,3	43.100	1	006500030
*5-30	14x18	115	89	44.100	1	006500130
*10-41	14x18	127	100	45.350	1	006500141

*Figyelem! Számítsa ki újra a beállítandó nyomaték értékét a fejezet elején található táblázat alapján.

650H

körmőskulcs
nyomatékkulcshoz
szögletes csatlakozóval



mm	mm	L mm	LA mm	Ft		
*28-36	14x18	122	92	22.850	1	006500928
*40-45	14x18	129	92	22.850	1	006500940
*50-55	14x18	129	92	22.850	1	006500950
*58-62	14x18	135	92	24.300	1	006500958
*68-75	14x18	139	92	26.500	1	006500968
*80-90	14x18	145	92	26.500	1	006500980

*Figyelem! Számítsa ki újra a beállítandó nyomaték értékét a fejezet elején található táblázat alapján.

652

Csillagkulcsfejek



mm	L mm	LA mm	Ft		
8	58	32	29.150	1	006520008
10	58	32	29.150	1	006520010
12	58	32	29.150	1	006520012
13	58	32	29.150	1	006520013
14	58	32	29.150	1	006520014
15	62	32	29.150	1	006520015
16	63	32	29.150	1	006520016
17	64	32	29.150	1	006520017
18	65	32	29.150	1	006520018
19	65	32	29.150	1	006520019
21	67	32	43.900	1	006520021
22	68	32	46.350	1	006520022
24	69	32	55.450	1	006520024
26	71	32	62.350	1	006520026
27	71	32	62.350	1	006520027
30	73	32	62.350	1	006520030
32	74	32	62.350	1	006520032

653

csillagkulcs
nyomatékkulcshoz
szögletes csatlakozóval

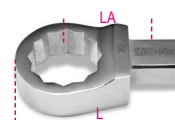

mm	mm	L mm	LA mm	Ft		
7	9x12	40	28,8	25.100	1	006530007
8	9x12	40	28,8	25.100	1	006530008
10	9x12	43	28,8	25.100	1	006530010
12	9x12	44	28,8	25.100	1	006530012
13	9x12	44	28,8	25.100	1	006530013
14	9x12	45	28,8	25.100	1	006530014
15	9x12	46	28,8	25.100	1	006530015
16	9x12	47	28,8	25.300	1	006530016
17	9x12	47	28,8	25.300	1	006530017
18	9x12	48	28,8	25.300	1	006530018
19	9x12	49	28,8	25.300	1	006530019
21	9x12	51	28,8	26.500	1	006530021
22	9x12	51	28,8	26.500	1	006530022

mm	mm	L mm	LA mm	Ft		
13	14x18	61	39,8	27.950	1	006530113
14	14x18	61	39,8	27.950	1	006530114
15	14x18	62	39,8	27.950	1	006530115
16	14x18	63	39,8	28.150	1	006530116
17	14x18	64	39,8	28.150	1	006530117
18	14x18	64	39,8	28.150	1	006530118
19	14x18	66	39,8	28.150	1	006530119
21	14x18	66	39,8	40.500	1	006530121
22	14x18	67	39,8	40.500	1	006530122
24	14x18	69	39,8	50.600	1	006530124
*27	14x18	76	44,8	50.600	1	006530127
*30	14x18	77	44,8	50.600	1	006530130
*32	14x18	79	44,8	50.600	1	006530132
*34	14x18	80	44,8	71.650	1	006530134
*36	14x18	80	44,8	71.650	1	006530136
*38	14x18	90	49,8	73.250	1	006530138
*41	14x18	90	49,8	73.250	1	006530141

*Figyelem! Számítsa ki újra a beállítandó nyomaték értékét a fejezet elején található táblázat alapján.



654

csillagkulcsfejek
nyomatékkulcshoz,
kerek fejű, Ø 22 mm



mm	L mm	LA mm	A mm	Ft		
22	98,5	56	38	46.350	1	006540022
24	98,5	56	38	55.450	1	006540024
27	102,8	56	46,5	62.350	1	006540027
30	102,8	56	46,5	62.350	1	006540030
32	106,5	56	55	62.350	1	006540032
34	106,5	56	55	62.350	1	006540034
36	106,5	56	55	80.950	1	006540036
41	115,5	56	72	80.950	1	006540041
46	115,5	56	72	88.050	1	006540046

659/15

szűkítő közbetét belső (14x18 mm) és külső
(9x12 mm)



L mm	□ mm	■ mm	LA mm	Ft		
* 51	14x18	9x12	32	36.850	1	006590815

*Figyelem! Számítsa ki újra a beállítandó nyomaték értékét a fejezet elején található táblázat alapján.



Ügyeljünk a forgató nyomatékra,
fokozatosan növeljük, hogy a törést,
illetve az esetleges sérülést elkerüljük.

659/16

Bővítő közbetét belső (9x12 mm) és külső
(14x18 mm)



L mm	□ mm	■ mm	LA mm	Ft		
* 51	9x12	14x18	31	31.150	1	006590816

*Figyelem! Számítsa ki újra a beállítandó nyomaték értékét a fejezet elején található táblázat alapján.



666 - 667 ZERO-RESET

AZ ÚJ NYOMATÉKKULCS, AMELY NEM IGÉNYEL
VISSZAÁLLÍTÁST HASZNÁLAT UTÁN

A előfeszítés kioldása nélkül is garantált a referenciaszabványoknak megfelelő ciklusszám, tartósság és meghúzási pontosság. E paraméterek igazolása érdekében a Beta Utensili Kutató és Fejlesztő Részlege számos tartóssági próbát végzett a saját laboratóriumokban és több száz végfelhasználónál. Ezt az eredményt a jelenleg elérhető legjobb anyagok felhasználásával és a belső részek speciális hőkezelésével érték el.

100% OLASZ GYÁRTMÁNY

A csúcsmínőségét garantálja, hogy a Zero Reset nyomatékkulcs teljes egészében a Beta Utensili olaszországi gyáraiban tervezett, gyártott, szerelt, bevizsgált és tanúsított.

Az új komponenseknek köszönhetően a nyomatékkulcsot használat után nem kell visszaállítani.

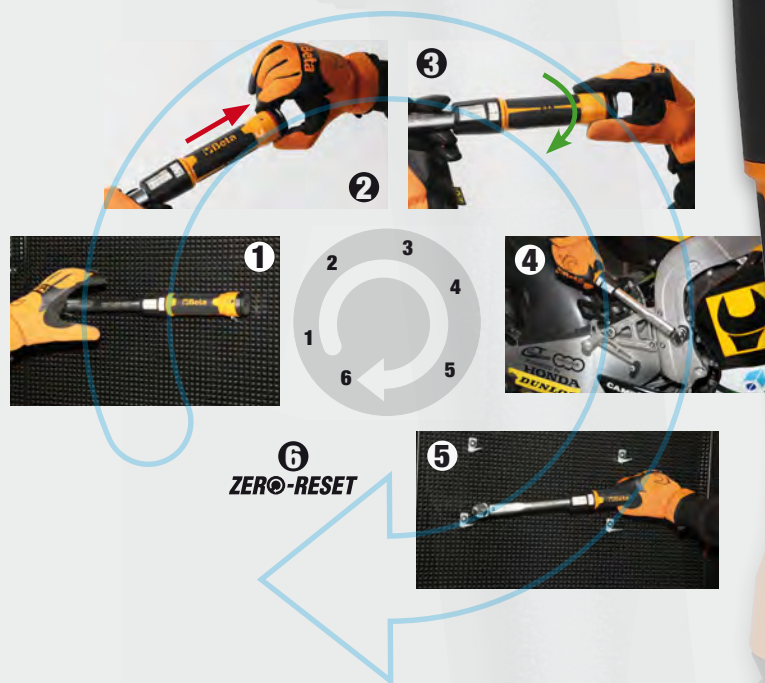

ZERO-RESET kioldó nyomatékkulcsok
irányváltós racsnival
jobb oldali meghúzáshoz,
meghúzási pontosság: ± 3%

Nem igényel visszaállítást



UNI EN ISO 6789

Nm	5÷25	1/4	D mm	26	A mm	25	L mm	273	g	395	0,05
----	------	-----	------	----	------	----	------	-----	---	-----	------

666/2	Ft	122.700	1	006660702
--------------	-----------	----------------	---	-----------

Nm	5÷25	3/8	D mm	26	A mm	29	L mm	273	g	405	0,05
----	------	-----	------	----	------	----	------	-----	---	-----	------

666/2X	Ft	122.700	1	006660703
---------------	-----------	----------------	---	-----------

Nm	10÷50	3/8	D mm	30	A mm	33	L mm	342	g	680	0,25
----	-------	-----	------	----	------	----	------	-----	---	-----	------

666/5	Ft	111.300	1	006660705
--------------	-----------	----------------	---	-----------

Nm	20÷100	3/8	D mm	30	A mm	33	L mm	385	g	760	0,25
----	--------	-----	------	----	------	----	------	-----	---	-----	------

666/10	Ft	112.100	1	006660710
---------------	-----------	----------------	---	-----------

Nm	20÷100	1/2	D mm	30	A mm	37	L mm	385	g	770	0,25
----	--------	-----	------	----	------	----	------	-----	---	-----	------

666/10X	Ft	114.600	1	006660711
----------------	-----------	----------------	---	-----------

Nm	40÷200	1/2	D mm	42	A mm	43	L mm	471	g	1020	0,5
----	--------	-----	------	----	------	----	------	-----	---	------	-----

666/20	Ft	121.900	1	006660720
---------------	-----------	----------------	---	-----------

Nm	60÷300	1/2	D mm	42	A mm	43	L mm	600	g	1270	1,0
----	--------	-----	------	----	------	----	------	-----	---	------	-----

666/30	Ft	138.500	1	006660730
---------------	-----------	----------------	---	-----------

666 LBF.FT

ZERO-RESET kioldó nyomatékkulcsok
irányváltós racsnival
jobb oldali meghúzáshoz,
meghúzási pontosság: ± 3%

• Nem igényel visszaállítást

• A skálabeosztás font-lábban (lbf.ft) van megadva



UNI EN ISO 6789

lbf.ft	4÷18	1/4	D mm	26	A mm	25	L mm	273	g	395	0,05
--------	------	-----	------	----	------	----	------	-----	---	-----	------

666 LBF.FT/2	Ft	115.800	1	006660762
---------------------	-----------	----------------	---	-----------

lbf.ft	4÷18	3/8	D mm	26	A mm	29	L mm	273	g	405	0,05
--------	------	-----	------	----	------	----	------	-----	---	-----	------

666 LBF.FT/2X	Ft	115.800	1	006660763
----------------------	-----------	----------------	---	-----------

lbf.ft	7÷37	3/8	D mm	30	A mm	33	L mm	342	g	680	0,25
--------	------	-----	------	----	------	----	------	-----	---	-----	------

666 LBF.FT/5	Ft	105.300	1	006660765
---------------------	-----------	----------------	---	-----------

lbf.ft	15÷75	3/8	D mm	30	A mm	33	L mm	385	g	760	0,25
--------	-------	-----	------	----	------	----	------	-----	---	-----	------

666 LBF.FT/10	Ft	106.100	1	006660780
----------------------	-----------	----------------	---	-----------

lbf.ft	15÷75	1/2	D mm	30	A mm	37	L mm	385	g	770	0,25
--------	-------	-----	------	----	------	----	------	-----	---	-----	------

666 LBF.FT/10X	Ft	108.100	1	006660781
-----------------------	-----------	----------------	---	-----------

lbf.ft	30÷150	1/2	D mm	42	A mm	43	L mm	471	g	1020	0,5
--------	--------	-----	------	----	------	----	------	-----	---	------	-----

666 LBF.FT/20	Ft	115.400	1	006660782
----------------------	-----------	----------------	---	-----------

lbf.ft	50÷230	1/2	D mm	42	A mm	43	L mm	600	g	1270	1,0
--------	--------	-----	------	----	------	----	------	-----	---	------	-----

666 LBF.FT/30	Ft	130.800	1	006660783
----------------------	-----------	----------------	---	-----------

667

ZERO-RESET kioldó nyomatékkulcsok
átnyomós racsnival,
jobb és bal oldali meghúzáshoz,
meghúzási pontosság: ± 3%

• Nem igényel visszaállítást



UNI EN ISO 6789

Nm	40÷200	1/2	D mm	42	A mm	42	L mm	471	g	1035	0,5
----	--------	-----	------	----	------	----	------	-----	---	------	-----

667/20	Ft	119.800	1	006670720
---------------	-----------	----------------	---	-----------

Nm	60÷300	1/2	D mm	42	A mm	42	L mm	600	g	1285	1,0
----	--------	-----	------	----	------	----	------	-----	---	------	-----

667/30	Ft	133.600	1	006670730
---------------	-----------	----------------	---	-----------

Nm	80÷400	3/4	D mm	59	A mm	53	L mm	710	g	2220	1,0
----	--------	-----	------	----	------	----	------	-----	---	------	-----

667/40	Ft	321.100	1	006670740
---------------	-----------	----------------	---	-----------

Tartalék forgó alkatrészek



668N

Kioldó hengeres nyomatékkulcs
Jobb és bal oldali meghúzáshoz
Pontosság ± 3%



UNI EN ISO 6789

Nm	5÷25	Kgfm	0,5÷2,5	lbf.ft	4÷18	Ø mm	16	L mm	220	LB mm	148	LS mm	32	g	300	0,2
----	------	------	---------	--------	------	------	----	------	-----	-------	-----	-------	----	---	-----	-----

668N/2	Ft	112.100	1	006680002
---------------	-----------	----------------	---	-----------

Nm	10÷50	Kgfm	1÷5	lbf.ft	7÷37	Ø mm	16	L mm	307	LB mm	229	LS mm	32	g	590	0,5
----	-------	------	-----	--------	------	------	----	------	-----	-------	-----	-------	----	---	-----	-----

668N/5	Ft	109.700	1	006680005
---------------	-----------	----------------	---	-----------

Nm	20÷100	Kgfm	2÷10	lbf.ft	15÷75	Ø mm	16	L mm	376	LB mm	269	LS mm	32	g	670	1,0
----	--------	------	------	--------	-------	------	----	------	-----	-------	-----	-------	----	---	-----	-----

668N/10	Ft	112.100	1	006680010
----------------	-----------	----------------	---	-----------

Nm	40÷200	Kgfm	4÷20	lbf.ft	30÷150	Ø mm	16	L mm	450	LB mm	352,6	LS mm	32	g	795	2,0
----	--------	------	------	--------	--------	------	----	------	-----	-------	-------	-------	----	---	-----	-----

668N/20	Ft	121.900	1	006680020
----------------	-----------	----------------	---	-----------

Nm	60÷300	Kgfm	6÷30	lbf.ft	50÷220	Ø mm	16	L mm	588	LB mm	475,9	LS mm	32	g	1230	2,0
----	--------	------	------	--------	--------	------	----	------	-----	-------	-------	-------	----	---	------	-----

668N/30	Ft	138.500	1	006680030
----------------	-----------	----------------	---	-----------



668RG

Kioldó nyomatékkulcs, mérőskála nélkül, jobb és bal oldali meghúzáshoz
meghúzási pontosság: ± 4%
(680 - 682 modellhez)



UNI EN ISO 6789

Nm	Kgfm	lbf.ft	Ø	L	W
8÷60	0,8÷6	6÷44	mm	mm	g
			16	288	550

668RG/6	Ft	W	U
	90.400	1	006680206

Nm	Kgfm	lbf.ft	Ø	L	W
20÷100	2÷10	15÷80	mm	mm	g
			16	315	600

668RG/10	Ft	W	U
	93.200	1	006680210

Nm	Kgfm	lbf.ft	Ø	L	W
40÷200	4÷20	30÷150	mm	mm	g
			16	405	780

668RG/20	Ft	W	U
	99.100	1	006680220

Nm	Kgfm	lbf.ft	Ø	L	W
60÷300	6÷30	50÷220	mm	mm	g
			16	645	1130

668RG/30	Ft	W	U
	110.400	1	006680230

668RGC

Kioldó nyomatékkulcs, mérőskála nélkül, irányváltós racsnival
jobb oldali meghúzáshoz,
meghúzási pontosság: ± 4%
(a 680 - 682 modellhez)



UNI EN ISO 6789

Nm	Kgfm	lbf.ft	■	D	A	L	W
12÷60	1,2÷6	5÷45	mm	mm	mm	mm	g
			3/8	30	33	295	600

668RGC/6	Ft	W	U
	82.500	1	006680406

Nm	Kgfm	lbf.ft	■	D	A	L	W
20÷100	2÷10	15÷75	mm	mm	mm	mm	g
			3/8	30	33	335	700

668RGC/10	Ft	W	U
	86.100	1	006680410

Nm	Kgfm	lbf.ft	■	D	A	L	W
20÷100	2÷10	15÷75	mm	mm	mm	mm	g
			1/2	40	43	342	700

668RGC/10X	Ft	W	U
	86.100	1	006680411

Nm	Kgfm	lbf.ft	■	D	A	L	W
40÷200	4÷20	30÷150	mm	mm	mm	mm	g
			1/2	40	43	425	1000

668RGC/20	Ft	W	U
	87.950	1	006680420

669N

Kioldó nyomatékkulcs, szögletes csatlakozóval,
jobb és bal oldali meghúzáshoz,
meghúzási pontosság: ± 3%



UNI EN ISO 6789

Nm	Kgfm	lbf.ft	□	L	LB	LS	W
5÷25	0,5÷2,5	4÷18	mm	mm	mm	mm	g
			9x12	215	140	28,8	300

669N/2	Ft	W	U
	159.900	1	006690202

Nm	Kgfm	lbf.ft	□	L	LB	LS	W
10÷50	1÷5	7÷37	mm	mm	mm	mm	g
			9x12	307	226,8	28,8	590

669N/5	Ft	W	U
	123.100	1	006690205

Nm	Kgfm	lbf.ft	□	L	LB	LS	W
20÷100	2÷10	15÷75	mm	mm	mm	mm	g
			9x12	376	266,8	28,8	670

669N/10	Ft	W	U
	132.400	1	006690210

Nm	Kgfm	lbf.ft	□	L	LB	LS	W
40÷200	4÷20	30÷150	mm	mm	mm	mm	g
			9x12	450	345,6	28,8	795

669N/20	Ft	W	U
	158.700	1	006690220

Nm	Kgfm	lbf.ft	□	L	LB	LS	W
40÷200	4÷20	30÷150	mm	mm	mm	mm	g
			14x18	450	351	39,8	795

669N/20X	Ft	W	U
	167.600	1	006690221

Nm	Kgfm	lbf.ft	□	L	LB	LS	W
60÷300	6÷30	50÷220	mm	mm	mm	mm	g
			14x18	588	468,5	39,8	1230

669N/30	Ft	W	U
	176.900	1	006690230

Nm	Kgfm	lbf.ft	□	L	LB	LS	W
80÷400	8÷40	60÷295	mm	mm	mm	mm	g
			14x18	664	563	39,8	2100

669N/40	Ft	W	U
	203.600	1	006690240



671B/C5

1 nyomatékkulcs 604B/5, 1 irányváltós racsnival,
8 hatlapú dugókulcs és 4 villáskulcs



671B/C5	Ft	W	U
	447.400	1	006710001

604B/5	1+5 Nm
611	1/4
641	5-6-7-8 mm
900	4-5-5,5-6-7-8-9-10 mm

270x120x45 mm - 1,3 kg

671B/C10

1 nyomatékkulcs 604B/10, 1 irányváltós
racsnival, 8 hatlapú-dugókulcs és 4 villáskulcs



671B/C10	Ft	W	U
	447.400	1	006710002

604B/10	2+10 Nm
611	1/4
641	6-7-8-10 mm
900	4-5-5,5-6-7-8-9-10 mm

270x120x45 mm - 1,4 kg

671N/C10

668N/10 hengeres nyomatékkulcs
és tartozékai



671N/C10	Ft	W	U
	504.900	1	006710110

668N/10	100 Nm
612	■ 3/8
617	■ 3/8
642	10-13-14-17-19 mm
652	10-13-14-17-19 mm
910A	□ 3/8 8-10-11-13-14-17-19 mm
910/21	125 mm
910/22	250 mm

400x180x45 mm - 4,3 kg

671N/C20

668N/20 hengeres nyomatókkulcs és tartozékai

12" 16



671N/C20 Ft 533.600 1 006710120

668N/20	200 Nm
614	■ 1/2
619	■ 1/2
642	10-13-14-17-19 mm
652	10-13-14-17-19 mm
920A	□ 1/2 10-11-13-14-17-19-22 mm
920/20	75 mm
920/21	125 mm
920/22	255 mm

510x180x45 mm - 5,5 kg

671N/C30

668N/30 hengeres nyomatókkulcs és tartozékai

12" 16



671N/C30 Ft 507.000 1 006710130

668N/30	300 Nm
614	■ 1/2
619	■ 1/2
642	13-14-17-19 mm
652	13-14-17-19 mm
920A	□ 1/2 13-14-17-19-22-24-27 mm
920/20	75 mm
920/21	125 mm
920/22	255 mm

620x180x45 mm - 5,8 kg



674/C

Kioldó nyomatókkulcs, kerék fejű Ø 22 mm, Jobb és bal oldali meghúzáshoz
Pontosság: ± 4%,
Tokban szállítva.

22



UNI EN ISO 6789

Nm	Kgfm	lbf.ft	Ø	L	LB	LS	h	mm	mm	mm	kg	mm
100÷500	10÷50	80÷400	22	786	725	56	3,4	1,25				

674/C50 Ft 370.400 1 006740005

Nm	Kgfm	lbf.ft	Ø	L	LB	LS	h	mm	mm	mm	kg	mm
160÷800	16÷80	120÷600	22	997	915	56	4,5	2,0				

674/C80 Ft 392.700 1 006740008

Nm	Kgfm	lbf.ft	Ø	L	LB	LS	h	mm	mm	mm	kg	mm
200÷1000	20÷100	150÷750	22	997	915	56	4,5	2,5				

674/C100 Ft 398.000 1 006740010

677

önkioldó nyomatókkulcsok átnyomós racsával jobb- és bal irányú meghúzáshoz pontosság: ± 4%

34"



UNI EN ISO 6789

Nm	Kgfm	lbf.ft	D	A	L	h	mm	mm	mm	kg	mm
120÷600	12÷60	100÷450	69	55	1059	6,0	10				

677/600 Ft 415.000 1 006770006

Nm	Kgfm	lbf.ft	D	A	L	h	mm	mm	mm	kg	mm
200÷800	20÷80	150÷600	69	55	1319	6,7	10				

677/800 Ft 434.400 1 006770008

Nm	Kgfm	lbf.ft	D	A	L	h	mm	mm	mm	kg	mm
300÷1000	30÷100	200÷750	69	55	1554	7,4	20				

677/1000 Ft 465.600 1 006770010

677/C

Önkioldó nyomatókkulcs, egyszerű racsával Jobb és bal oldali meghúzáshoz
Pontosság: ± 4%
Hordozótáskában szállítva.

34"



UNI EN ISO 6789

Nm	Kgfm	lbf.ft	D	A	L	h	mm	mm	mm	kg	mm
120÷600	12÷60	100÷450	69	55	1059	6,0	10				

677/C600 Ft 489.900 1 006770607

Nm	Kgfm	lbf.ft	D	A	L	h	mm	mm	mm	kg	mm
200÷800	20÷80	150÷600	69	55	1319	6,7	10				

677/C800 Ft 510.100 1 006770612

Nm	Kgfm	lbf.ft	D	A	L	h	mm	mm	mm	kg	mm
300÷1000	30÷100	200÷750	69	55	1554	7,4	20				

677/C1000 Ft 540.500 1 006770616

Nm	Kgfm	lbf.ft	D	A	L	h	mm	mm	mm	kg	mm
700÷1500	70÷150	500÷1000	69	55	1869	9,6	25				

677/C1500 Ft 692.300 1 006770621

677/CP2000

Önkioldó nyomatókkulcs, átnyomós racsával Jobb és bal oldali meghúzáshoz, Pontosság: ± 4%
Hordozótáskában szállítva.

1"



UNI EN ISO 6789

Nm	Kgfm	lbf.ft	D	A	L	h	mm	mm	mm	kg	mm
900÷2000	90÷200	700÷1500	69	63	1940	12,75	50				

677/CP2000 Ft 1.271.300 1 006770721



Beta

678/C

Kioldó nyomatékkulcs, egyszerű racsnival
Jobb és bal oldali meghúzáshoz
Pontosság $\pm 4\%$
Hordozótáskában szállítva.

• A 678/C100 és 678/C150 modelleket hosszabbítóval szállítjuk.

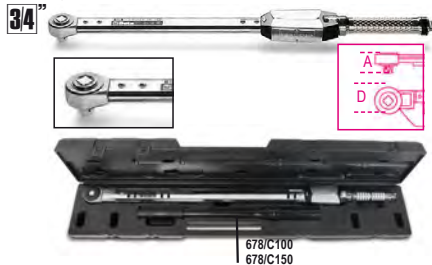

UNI EN ISO 6789

Nm	Kgfm	lbf.ft	D	A	L	kg	mm
130÷650	13÷65	100÷480	63	55	885	3,9	5,0

Ft		kg	mm
678/C65	766.400	1	006780607

Nm	Kgfm	lbf.ft	D	A	L	kg	mm
300÷1000	30÷100	220÷750	75	60	1250	6,0	10

Ft		kg	mm
678/C100	1.015.400	1	006780611

Nm	Kgfm	lbf.ft	D	A	L	kg	mm
500÷1500	50÷150	370÷1100	75	60	1570	8,5	10

Ft		kg	mm
678/C150	1.108.100	1	006780615

677/CV - 678/CV

Fémdobozok nyomatékkulcsokhoz
677-hez és 678-hoz



Ft		kg	mm
677/CV1	75.500	1	006770455
677/C600-677/C800-677/C1000	99.200	1	006770460
677/C1500-677/CP2000	71.250	1	006780455
678/CV1	80.150	1	006780500
678/C65	132.400	1	006780415
678/CV2	80.150	1	006780500
678/C100	132.400	1	006780415
678/CV3	132.400	1	006780415
677/C100-677/C150-678/C150			

680

digitális nyomatékmerő
Dynatester 680
kalibráció ellenőrzéséhez,
jobb- és bal irányú működés

- Pontosság: leolvasott érték $\pm 1\%$
- Színes LCD kijelző, 4 számjegy
- 3 mértékegység: Nm - lbf.ft. - lbf.in



	Nm	kg	Ft	kg	mm
680/3	0,1÷3	1,4	1.299.600	1	006800000
680/30	1,5÷30	1,4	1.283.400	1	006800003
680/350	10÷350	2,6	1.287.400	1	006800035
680/2100	200÷2100	3,5	1.915.000	1	006800210

682

Elektronikus nyomatékmerőkészülék
digitális kijelzővel Dynatester 682
Jobbos és balos
Nagy pontosságú elektronikus mérés.
A mérőkészülék adapter segítségével
személyi számítógéphez
csatlakoztatható az RS 232 kimeneti
ponton keresztül.

682/60
682/400
682/1500



CE

Műszaki tulajdonságok:

- Pontosság: a leolvasott érték $\pm 1\%$
- Választható mértékegység: Nm-dNm-cNm-Lbf.ft-Lbf.in-Ozf.in-Kgf.m.-kgf.cm/gf
- Hálózati feszültség: 90 - 264V AC 50/60 Hz
- Mérőkészülék: 235x185x185 mm
- Tűrésvizsgálat az ISO 6789 szerint
- Bevizsgált nyomatékkulcsok tűréshatárai.
- Display 11 nyelven választható menü
- Mellékletek
- Kalibrációs táblázat /UKAS/

	Nm	kg	Ft	kg	mm
682/60	1,2÷60	5,9	2.659.900	1	006820006
682/400	8÷400	6,1	2.700.400	1	006820040
682/1500	30÷1500	6,4	2.785.400	1	006820150

GÉPI DUGÓKULCSOK



A gépi dugókulcsok a kézi dugókulcsokhoz képest túlméretezettek, képesek elnyelni az ütvecsavarozók és nyomatéksokszorozók által létrehozott nagy nyomatékot. A hatszög profil még nagyobb tartósságot nyújt intenzív használat mellett is. Tömítőgyűrűvel és zárócsappal együtt kell használni, hogy elkerülhető legyen a meghajtóról való leválás.

A standard és hosszabbított kivitelben rendelkezésre álló klasszikus modellek mellett vékony sorozat is kapható, amely olyan helyeken történő használatra alkalmas, ahol a csavarok a standard modellekkel nem érhetők el. Jelentősen kisebb mértékű szilárdságuk miatt azonban óvatosságra van szükség használatuk során.



710

3/8"-os gépi dugókulcs, foszfátzott



UNI/ISO 2725 DIN 3129

mm	Ø mm	L mm	Ø1 mm	Ft	csomagolás	azonosító
7	12,5	28	19	3.910	3	007100007
8	13,8	28	19	3.910	3	007100008
9	15,0	28	19	3.910	3	007100009
10	16,3	28	19	3.910	3	007100010
11	17,5	30	19	3.910	3	007100011
12	19,0	30	19	3.910	3	007100012
13	20,0	30	22	4.090	3	007100013
14	21,3	30	22	4.090	3	007100014
16	23,8	30	22	4.170	3	007100016
17	25,0	30	22	4.170	3	007100017
18	26,3	30	22	4.290	3	007100018
19	27,5	30	22	4.290	3	007100019
21	30,0	32	22	4.740	3	007100021
22	32,0	32	22	5.260	3	007100022

710/C10

10 db 3/8"-os gépi dugókulcs, fémdobozban



710/C10 Ft 59.250 1 007100910

7-8-10-11-12-13
14-17-19-22 mm

130x55x40 mm - 800 g

710/16

Bővítő közbetét 3/8" és 1/2"



L mm	Ø mm	csomagolás	Ft	azonosító
32	22	3/8 1/2	10.500	3 007100810

710/20

3/8"-os toldó



L mm	Ø mm	Ft	azonosító
75	22	10.700	2 007100821

710/21

3/8"-os toldó



L mm	Ø mm	Ft	azonosító
125	22	11.750	2 007100823

710/22

3/8"-os négyszögletes toldó



L mm	Ø mm	Ft	azonosító
150	22	13.750	2 007100825

710/25

3/8"-os csukló



L mm	Ø mm	Ft	azonosító
58	24	21.850	2 007100830

710/OR... - 710/SP...

O-gyűrű, biztosító csap



710/OR1	710/OR2	710/SP1	710/SP2	Ft	azonosító
7-12	13-22	7-12	13-22	325	10 007100921
				325	10 007100922
				595	10 007100911
				595	10 007100912

720

1/2"-os gépi dugókulcs, foszfátzott



UNI/ISO 2725 DIN 3129

mm	Ø mm	L mm	Ø1 mm	Ft	csomagolás	azonosító
8	15,0	38	25	4.700	5	007200008
9	16,0	38	25	4.700	5	007200009
10	17,0	38	25	4.780	5	007200010
11	18,5	38	25	4.780	5	007200011
12	20,0	38	25	4.780	5	007200012
13	21,0	38	25	4.780	5	007200013
14	22,5	38	25	4.780	5	007200014
15	23,0	38	30	5.340	5	007200015
16	25,0	38	30	5.340	5	007200016
17	26,0	38	30	5.340	5	007200017
18	27,5	38	30	5.340	5	007200018
19	28,5	38	30	5.340	5	007200019
20	30	38	30	5.870	5	007200020
21	31,0	38	30	5.870	5	007200021
22	32,5	38	30	5.950	5	007200022
23	34,0	38	30	6.520	5	007200023
24	35,0	38	30	6.520	5	007200024
27	38,5	45	30	7.570	3	007200027
29	41	47	30	8.300	3	007200029
30	42,0	50	30	8.300	3	007200030
32	44,0	50	30	9.470	3	007200032
36	50,0	50	30	13.550	3	007200036

720/C6

Gépi dugókulcs



720/C6 Ft 48.300 1 007200910

13-14-17-19-22-24 mm

195x80x55 mm - 1100 g

720/C12

Gépi dugókulcs



720/C12 Ft 87.950 1 007200912

10-11-12-13-14-17
19-22-24-27-30-32 mm

195x80x55 mm - 2000 g

720/C24

24 gépi dugókulcs



720/C24 Ft 188.000 1 007200904

- 720 10 - 12 - 13 - 14 - 15 - 16 - 17 - 18 - 19 - 21 - 22 - 24 - 27 - 30 - 32 mm
- 720L 13 - 17 - 19 - 21 - 22 - 24 mm
- 720LC 17 - 19 - 21 mm

420x185x60 mm - 6,2 kg

720B

tizenkészsögű gépi dugókulcs



UNI/ISO 2725 DIN 3129

Ø mm	Ø mm	L mm	Ø1 mm	Ft	csomagolás	azonosító
10	17	38	25	4.780	5	007201010
11	18	38	25	4.780	5	007201011
12	19	38	25	4.780	5	007201012
13	20	38	25	4.780	5	007201013
14	22	38	25	4.780	5	007201014
15	23	38	30	5.340	5	007201015
16	24	38	30	5.340	5	007201016
17	26	38	30	5.340	5	007201017
18	27	38	30	5.340	5	007201018
19	28	38	30	5.340	5	007201019
21	30	38	30	5.870	5	007201021
22	31,8	38	30	5.950	5	007201022
23	31,8	38	30	6.520	5	007201023
24	33,8	40	30	6.520	5	007201024
27	37,8	43	30	7.570	3	007201027
30	41,8	43	30	8.300	3	007201030
32	43,8	43	30	9.470	3	007201032
36	49,8	50	30	13.550	3	007201036

720B/C12

12 db tizenkészsögű gépi dugókulcs



UNI/ISO 2725 DIN 3129

720B/C12 Ft 87.950 1 007201912

10-11-12-13-14-17
19-22-24-27-30-32 mm

195x80x55 mm - 2000 g

720MC

gépi dugókulcs,
standard sorozat,
színezett



Ø mm	Ø mm	L mm	Ft	csomagolás	azonosító
10	17,0	38	4.940	3	007202010
11	18,5	38	4.940	3	007202011
12	20,0	38	4.940	3	007202012
13	21,0	38	4.940	3	007202013
14	22,5	38	4.940	3	007202014
15	23,0	38	5.590	3	007202015
16	25,0	38	5.590	3	007202016
17	26,0	38	5.590	3	007202017
18	27,5	38	5.590	3	007202018
19	28,5	38	5.590	3	007202019
21	31,0	38	6.190	2	007202021
22	32,5	38	6.190	2	007202022
24	35,0	38	6.760	2	007202024

720MC/C13

13 gépi dugókulcs, színezett



720MC/C13 Ft 89.600 1 007202913

10-11-12-13-14-15
16-17-18-19-21-22
24 mm

335x145x60 mm - 2,4 kg

720AS

Gépi dugókulcs ütvecsavarozóhoz,
Standard-kivitel



Ø mm	Ø mm	L mm	Ø1 mm	Ft	csomagolás	azonosító
3/8	17,0	38	25	7.690	2	007200210
7/16	18,2	38	25	7.690	2	007200211
1/2	20,7	38	25	7.690	2	007200213
9/16	22,0	38	25	7.690	2	007200214
5/8	24,5	38	30	8.300	2	007200216
11/16	25,7	38	30	8.300	2	007200217
3/4	28,2	38	30	8.300	2	007200219
13/16	30,7	38	30	8.790	2	007200221
7/8	32,0	38	30	8.790	2	007200222
15/16	34,5	38	30	9.350	2	007200224
1	35,7	38	30	10.100	2	007200225
1.1/16	38,2	40	30	11.150	1	007200227
1.1/8	40,7	42	30	12.550	1	007200229
1.1/4	44,5	42	30	13.750	1	007200232

720S

kompakt gépi dugókulcs



Ø mm	Ø mm	L mm	Ø1 mm	Ft	csomagolás	azonosító
13	20,0	28,0	23,8	2.980	3	007200113
15	23,0	28,0	23,8	2.980	3	007200115
17	25,8	28,0	25,8	3.260	3	007200117
19	27,8	28,0	27,8	3.540	3	007200119
22	31,8	28,0	30,0	3.850	3	007200122
24	33,8	28,0	30,0	4.210	3	007200124



720S/SB6 Ft 25.650 1 007200906
13-15-17-19-22-24 mm

720L

1/2"-os hosszú gépi dugókulcs,
foszfátzott



UNI/ISO 2725

Ø mm	Ø mm	L mm	Ø1 mm	Ft	csomagolás	azonosító
10	17,0	80	25	8.140	2	007200310
11	18,5	80	25	8.140	2	007200311
12	20,0	80	25	8.140	2	007200312
13	21,0	80	25	8.140	2	007200313
14	22,5	80	25	8.140	2	007200314
15	23,0	80	30	9.270	2	007200315
16	25,0	80	30	9.270	2	007200316
17	26,0	80	30	9.270	2	007200317
18	27,5	80	30	9.800	2	007200318
19	28,5	80	30	9.800	2	007200319
21	31,0	80	30	10.300	2	007200321
22	32,5	80	30	10.300	2	007200322
24	35,0	80	30	10.950	2	007200324
27	38,5	80	30	13.550	2	007200327
30	42,0	80	30	16.400	2	007200330
32	44,0	80	30	16.400	2	007200332
36	50,0	80	30	21.250	2	007200336

720L/S3

3 darab hosszú gépi dugókulcs,
foszfátzott



720L/S3 Ft 29.400 1 007200355
17-19-21 mm

720LS

Gépi dugókulcs hosszú és keskeny kivitel



Ø mm	D mm	L mm	Ø1 mm	Ft	W	L
10	15,5	78	24	8.790	2	007200360
11	16,7	78	24	8.790	2	007200361
12	18,0	78	24	8.790	2	007200362
13	19,2	78	24	8.790	2	007200363
14	20,5	78	24	8.790	2	007200364
15	21,7	78	24	9.030	2	007200365
16	23,0	78	24	9.030	2	007200366
17	24,2	78	29	10.100	2	007200367
18	25,5	78	29	10.950	2	007200368
19	26,7	78	29	10.950	2	007200369
21	29,2	78	29	11.350	2	007200371
22	30,5	78	29	11.350	2	007200372
24	33,0	78	29	11.550	2	007200374
27	36,7	78	29	14.150	2	007200377
30	40,5	78	29	18.000	2	007200380
32	43,0	78	29	18.600	2	007200382
36	48,0	78	29	28.150	2	007200386

720LC

gépi dugókulcs kerékanyákhoz
színes polimer betétekkel



Ø mm	Ø mm	Ft	W	L
17	26,5	5.870	2	007200637
19	28,5	5.870	2	007200639
21	30,3	6.110	2	007200641
22	32,4	6.360	2	007200642
24	34,6	6.920	2	007200644



720LC/C3	Ft	W	L
17-19-21 mm	17.850	1	007200653

148x132x44 mm - 860 g



720LC/S5	Ft	W	L
17-19-21-22-24 mm	31.150	1	007200645

12"



720LC/PM5	Ft	W	L
17-19-21-22-24 mm	52.400	1	007200646

PM 1/2-Q5

mágneses dugókulcs tartó



PM 1/2-Q5	Ft	W	L
	21.250	1	088880233

720IC

színes polimer cserebetét a 720LC-720LCL dugókulcshoz



720IC	Ø mm	Ft	W	L
17	17	2.370	1	007200687
19	19	2.370	1	007200689
21	21	2.370	1	007200691
22	22	2.370	1	007200692
24	24	2.370	1	007200694

720LCL

gépi dugókulcs kerékanyákhoz
színes polimer betétekkel
hosszú kivitel



720LCL	Ø mm	Ft	W	L
17	26,5	9.720	1	007200737
19	28,5	9.720	1	007200739
21	30,3	9.720	1	007200741

12"



720LCL/C3	Ft	W	L
17-19-21 mm	37.100	1	007200753

210x50x150 mm - 1,65 kg

720MRC

gépi dugókulcs
polimer betéttel Mercedes kerékanya profilhoz

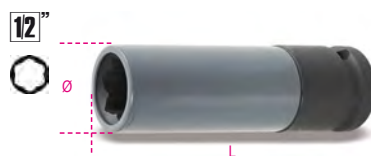

720MRC	Ø mm	L mm	Ft	W	L
17	27	85	9.510	1	007200631

720FRD

gépi dugókulcs sérült Ford
alumínium kerékanyákhoz

az ütvecsavarbehajtók miatt sérült csavarsapkákhoz ajánlott



720FRD	Ø mm	L mm	Ft	W	L
18,5÷19,5		63	9.030	1	007200633

720RNG

gépi dugókulcs sérült Jeep Renegade
alumínium kerékanyákhoz

az ütvecsavarbehajtók miatt
sérült csavarsapkákhoz ajánlott



720RNG	Ø mm	L mm	Ft	W	L
16,5÷17,5		63	9.030	1	007200634



Beta

12"



720TC/S5 Ft 51.600 1 007200779
90-100-110-120-135 Nm
260x50x175 mm - 1,35 kg

720FTX

1/2"-os gépi Torx®-dugókulcs
űtvecsavarbehajtókhoz, foszfátzott

12"



	Ø mm	L mm	Ø1 mm	Ft		
E12	15,9	38	25	7.610	2	007200412
E14	17,7	38	25	7.610	2	007200414
E16	20,0	38	25	7.610	2	007200416
E18	22,0	38	25	7.610	2	007200418
E20	25,0	40	25	8.100	2	007200420
E24	30,0	40	30	8.100	2	007200424

12"



720FTX/SB6 Ft 51.000 1 007200450
E10-E12-E14
E16-E18-E20

720TX

Gépi Torx® dugókulcs

12"



	Ø mm	L mm	L1 mm	Ft		
T30	25	78	54	6.680	3	007200460
T40	25	78	54	6.680	3	007200470
T45	25	78	54	6.800	3	007200472
T50	25	78	54	6.800	3	007200474
T55	25	78	54	7.690	3	007200476
T60	25	78	54	8.300	3	007200478

720TX/C6

6-részes gépi Torx® dugókulcs készlet
fémdobozban

12"



720TX/C6 Ft 56.300 1 007200483
T30-T40-T45-
T50-T55-T60

275x120x65 mm - 5700 g

720ME

Gépi dugókulcs

12"



mm	Ø mm	L mm	L1 mm	Ft		
5	25	78	54	6.400	3	007200505
6	25	78	54	6.400	3	007200506
8	25	78	54	6.400	3	007200508
10	25	78	54	6.400	3	007200510
12	25	78	54	6.400	3	007200512
14	25	78	54	7.170	3	007200514
17	25	78	54	7.170	3	007200517
19	25	78	54	7.170	3	007200519

720ME/C8

8 gépi dugókulcs fémdobozban

12"



720ME/C8 Ft 68.850 1 007200525
5-6-8-10-12-
14-17-19 mm

270x120x45 mm - 1710 g

9899 720ME/C8 Ft 6.190 1 098990130
Hőformált tálcá, üres



Beta

720XZN

gépi dugókulcsok
XZN® fejű csavarokhoz

12"



Ø	Ø mm	L mm	L1 mm	Ft		
M4	25	77	53	7.250	3	007201504
M5	25	77	53	7.250	3	007201505
M6	25	77	53	7.250	3	007201506
M8	25	77	53	7.250	3	007201508
M10	25	77	53	7.450	3	007201510
M12	25	77	53	7.610	3	007201512
M14	25	77	53	7.610	3	007201514
M16	25	77	53	7.810	3	007201516
M18	25	77	53	8.180	3	007201518

720XZN/C6

6 db gépi dugókulcs XZN® fejű csavarokhoz

12"



720XZN/C6 Ft 59.250 1 007201530
M8-M10-M12-M14
M16-M18

275x120x65 mm - 5700 g

720/SN

Gépi dugókulcs,
csuklós sorozat

12"



Ø	Ø mm	L mm	Ø1 mm	Ft		
17	25,7	69,6	30	33.400	2	007200087
19	28,2	73,6	30	33.400	2	007200089
24	34,5	75,6	30	37.450	2	007200094

720/15

Szűkítő közbetét 1/2" és 3/8"

12"



L	Ø			Ft		
mm	mm	1/2	3/8			
37,5	25			5.340	3	007200810



Ügyeljünk a forgató nyomatékra, fokozatosan növeljük, hogy a törést, illetve az esetleges sérülést elkerüljük.

720/16

Bővítő közbetét 1/2" - 3/4"

12"



L	Ø			Ft		
mm	mm	1/2	3/4			
44	30			9.230	3	007200814

720/20

1/2"-os toldó

12"



L	Ø			Ft		
mm	mm					
75	25			9.470	3	007200818

720/21

1/2"-os toldó

12"



L	Ø			Ft		
mm	mm					
125	25			10.300	3	007200822

720/22

1/2"-os toldó

12"



L	Ø			Ft		
mm	mm					
250	25			11.950	3	007200824

720/25

1/2"-os csukló

12"



L	Ø			Ft		
mm	mm					
64	28			17.600	2	007200831

720/OR... - 720/SP...

O-gyűrű, biztosító csap

12"



	720 Ø mm	720TX Ø mm	Ft		
720/OR1	10+14	T30+T60	610	10	007200923
720/OR2	15+36		610	10	007200924
720/SP1	10+14	T30+T60	900	10	007200913
720/SP2	15+36		900	10	007200914

727PI/16 1/2

betéttartó
727/ES16, 727/ES16TX és 727/ES16XZN
modellhez

12"



Ø	L	Ø		Ft		
mm	mm	mm	1/2			
28	42	16		15.800	2	007270015

727PI/16

Betéttartó 727/ES16
és 727/ES16TX modellhez

3/4"



Ø	L	Ø		Ft		
mm	mm	mm	3/4			
44	52	16		20.650	2	007270016

727/ES16

Csavarhúzóbetét külső
méret 16 mm

12"



mm	Ø	L	Ft		
mm	mm	mm			
10	16	40	7.000	2	007270110
12	16	40	7.000	2	007270112
13	16	40	7.000	2	007270113
14	16	40	7.000	2	007270114
16	16	40	7.530	2	007270116
17	16	40	7.530	2	007270117
18	16	40	7.850	2	007270118
19	16	40	7.850	2	007270119
22	16	40	9.030	2	007270122

727/ES16TX

Torx® csavarhúzóbetét külső
méret 16 mm

12"



Ø	Ø	L	Ft		
mm	mm	mm			
T55	16	50	10.500	2	007270355
T60	16	50	10.500	2	007270360
T70	16	50	10.500	2	007270370

727/ES16XZN

bit fejek
XZN® csavarokhoz, 16 mm

12"



Ø	Ø	L	Ft		
mm	mm	mm			
M6	16	60	12.750	2	007270606
M8	16	60	12.750	2	007270608
M10	16	60	12.750	2	007270610
M12	16	60	12.750	2	007270612
M14	16	60	12.750	2	007270614
M16	16	60	12.750	2	007270616
M18	16	60	17.600	2	007270618

727PI/22

Betéttartó 727/ES22
és 727/ES22TX modellhez



Ø mm	L mm	Ø mm	Ft	🔧	📄
54	70	22	32.000	2	007270022

727/ES22

Csavarhúzóbetét külső
méret 22 mm



mm	● mm	L mm	Ft	🔧	📄
19	22	50	9.030	2	007270219
22	22	50	9.030	2	007270222
24	22	50	9.960	2	007270224
27	22	50	11.150	2	007270227
30	22	50	13.350	2	007270230
32	22	50	14.550	2	007270232

727/ES22TX

Torx® csavarhúzóbetét külső
méret 22 mm



🔧	mm	L mm	Ft	🔧	📄
T80	22	60	14.750	2	007270480
T90	22	60	14.750	2	007270490
T100	22	60	14.750	2	007270500

727/C16

12 csavarhúzóbetét és 4 tartozék



727/C16	Ft	🔧	📄
	201.400	1	007270900

- 727PI/16
 - 727/ES16 14-17-19 mm
 - 727/ES16TX T55-T60-T70
 - 727PI/22
 - 727/ES22 22-24-27 mm
 - 727/ES22TX T80-T90-T100
 - 96BPC 3-4 mm
- 📏 335x145x60 mm - 📦 3,6 kg

727PI/32

Betéttartó
727/ES32 modellhez



Ø mm	L mm	Ø mm	Ft	🔧	📄
86	66	32	79.750	1	007270032

727/ES32

Csavarhúzóbetét,
külső méret 32 mm

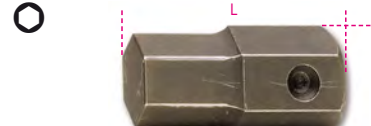

mm	● mm	L mm	Ft	🔧	📄
19	32	44	20.450	2	007270519
22	32	44	20.450	2	007270522
24	32	44	20.450	2	007270524
27	32	44	20.450	2	007270527
30	32	44	20.450	2	007270530
32	32	44	20.450	2	007270532
36	32	44	22.850	2	007270536

728

3/4"-os gépi dugókulcs, foszfátzott



UNI/ISO 2725 DIN 3129

🔧	Ø mm	L mm	Ø1 mm	Ft	🔧	📄
17	30,0	51	44	11.750	2	007280017
18	31,0	51	44	11.750	2	007280018
19	32,5	51	44	11.750	2	007280019
21	35,0	51	44	11.750	2	007280021
22	36,0	51	44	11.750	2	007280022
23	37,5	51	44	11.950	2	007280023
24	38,5	51	44	11.950	2	007280024
27	42,5	53	44	11.950	2	007280027
28	44,0	53	44	12.350	2	007280028
30	46,0	53	44	12.750	2	007280030
32	48,5	57	44	13.350	2	007280032
33	50,0	57	44	14.150	2	007280033
34	51,0	57	44	14.150	2	007280034
35	52,5	57	44	14.750	2	007280035
36	53,5	57	44	15.200	2	007280036
38	56,0	57	44	17.000	1	007280038
40	58,5	58	44	18.000	1	007280040
41	60,0	58	44	18.200	1	007280041
44	64,0	62	44	19.850	1	007280044
45	65,0	62	44	21.450	1	007280045
46	66,0	62	44	21.650	1	007280046
50	71,0	68	54	25.300	1	007280050
55	77,5	71	54	28.350	1	007280055
60	83,0	73	54	32.400	1	007280060
65	88,0	78	54	35.800	1	007280065



728/C10

10 db 3/4"-os gépi dugókulcs,
fémdobozban



728/C10	Ft	🔧	📄
17-19-22-24-27-30 32-36-41-46 mm	158.100	1	007280910

📏 275x120x65 mm - 📦 5,7 kg

728B

tizenkétszögű gépi dugókulcs



UNI/ISO 2725 DIN 3129

🔧	Ø mm	L mm	Ø1 mm	Ft	🔧	📄
17	28,5	50	38	11.750	2	007280117
19	30	52	38	11.750	2	007280119
21	32	52	38	11.750	2	007280121
22	34	52	38	11.750	2	007280122
23	35	52	38	11.950	2	007280123
24	36	52	38	11.950	2	007280124
27	40	52	40	11.950	2	007280127
29	42	52	42	12.550	2	007280129
30	44	52	44	12.750	2	007280130
32	48	52	44	13.350	2	007280132
33	50	56	44	14.150	2	007280133
34	51	56	44	14.150	2	007280134
35	52	56	44	14.750	2	007280135
36	53,5	56	44	15.200	2	007280136
38	56	56	44	17.000	1	007280138
41	60	58	44	18.200	1	007280141
46	67	63	44	21.650	1	007280146

728B/C10

10 db tizenkétszögű gépi dugókulcs



728B/C10	Ft	🔧	📄
17-19-22-24-27 30-32-36-41-46 mm	158.100	1	007280930

📏 275x120x65 mm - 📦 5,7 kg

728AS

standard dugókulcsfej



"	Ø mm	L mm	Ø1 mm	Ft	W	IT
3/4	32,0	51	41	11.750	1	007280219
13/16	35,0	51	41	11.950	1	007280221
7/8	36,0	51	41	11.950	1	007280222
15/16	38,5	51	41	11.950	1	007280224
1	40,0	53	41	12.350	1	007280225
1.1/16	42,5	53	44	13.150	1	007280227
1.1/8	44,0	53	44	13.350	1	007280230
1.1/4	48,5	57	44	13.550	1	007280232
1.5/16	50,0	57	44	14.150	1	007280233
1.7/16	53,5	57	44	15.200	1	007280236
1.1/2	56,0	57	44	16.800	1	007280238
1.5/8	60,0	58	44	18.200	1	007280241

728FTX

Gépi dugókulcs Torx®-csavarokhoz



"	Ø mm	L mm	Ø1 mm	Ft	W	IT
E20	28,5	50	44	15.800	2	007280420
E22	30,0	50	44	15.800	2	007280422
E24	32,5	50	44	15.800	2	007280424

728ME

gépi dugókulcsfej hatlapfejű csavarokhoz



mm	Ø mm	L mm	L1 mm	Ft	W	IT
12	44	100	67	13.750	3	007280712
14	44	100	67	15.400	3	007280714
17	44	100	67	15.400	3	007280717
19	44	100	67	15.400	3	007280719
22	44	100	67	18.000	3	007280722
24	44	100	67	18.000	3	007280724

728ME/C6

6 db gépi dugókulcs hatlapfejű csavarokhoz



Ft	W	IT
113.800	1	007280906

335x145x60 mm - 4,0 kg

728L

Hosszú dugókulcsfejek



"	D mm	L mm	Ø1 mm	Ft	W	IT
17	30	90	44	18.600	2	007280317
19	32,5	90	44	18.600	2	007280319
21	35,0	90	44	18.600	2	007280321
22	36,0	90	44	18.600	2	007280322
24	38,5	90	44	18.600	2	007280324
26	41,0	90	44	18.600	2	007280326
27	42,5	90	44	18.600	2	007280327
30	46,0	90	44	19.450	2	007280330
32	48,5	90	44	20.450	2	007280332
33	50,0	90	44	21.850	1	007280333
34	51,0	90	44	23.050	1	007280334
36	53,5	90	44	24.100	1	007280336
38	56,0	90	44	28.150	1	007280338
41	60,0	90	44	28.750	1	007280341
44	64,0	90	44	33.000	1	007280344
46	66,0	90	44	33.000	1	007280346
50	71,0	90	44	39.450	1	007280350
55	77,5	100	54	51.800	1	007280355



Ft	W	IT
63.950	1	007280393

728LS

Hosszú, könnyített 3/4"-os gépi dugókulcs, foszfátzott



"	D mm	L mm	Ø1 mm	Ft	W	IT
17	28,0	100	43	21.250	2	007280517
19	30,5	100	43	21.250	2	007280519
22	34,3	100	43	21.650	2	007280522
24	36,8	100	43	21.650	2	007280524
27	40,5	100	43	21.650	2	007280527
30	44,3	100	43	21.650	2	007280530
32	46,8	100	43	23.050	2	007280532
33	48,0	100	43	23.900	2	007280533
36	51,8	100	43	27.950	1	007280536

728LQ

Hosszú gépi dugókulcs

(ISUZU kerékanyához)



"	L mm	Ø mm	Ø1 mm	Ft	W	IT
19	90	35	43,5	19.000	1	007280619
21	90	42	43,5	19.000	1	007280621

728/15

Szűkítő közbetét 3/4"- 1/2", foszfátzott



L mm	Ø mm	□	■	Ft	W	IT
58	38	3/4	1/2	14.750	2	007280810



Ügyeljünk a forgató nyomatékra, fokozatosan növeljük, hogy a törést, illetve az esetleges sérülést elkerüljük.

728/16

Bővítő közbetét 3/4"-1", foszfátzott



L mm	Ø mm	□	■	Ft	W	IT
62	44	3/4	1	17.800	2	007280813

728/21

3/4"-os toldó



L mm	Ø mm	Ft	W	IT
175	44	21.850	2	007280815

728/22

3/4"-os toldó



L mm	Ø mm	Ft	W	IT
250	44	25.100	2	007280825

728/22L

Toldó Belső- és külső négyszög 3/4"



L mm	Ø mm	Ft	W	IT
330	44	32.400	1	007280826

728/25

3/4"-os csukló



L mm	Ø mm	Ft	W	IT
107,5	44	42.500	1	007280830

728/OR - 728/SP

O-gyűrű, biztosító csap

34"



	728	728FTX			
	mm	mm	Ft		
728/OR-15	728/15		895	5	007280925
728/OR	17+46	E20+E24	950	10	007280926
728/SP	17+46	E20+E24	1.260	10	007280916

729

1"-os gépi dugókulcs, foszfátzott



UNI/ISO 2725 DIN 3129

mm	D mm	L mm	Ø1 mm	Ft		
24	41,5	58	54	19.000	1	007290024
27	45,0	60	54	19.000	1	007290027
30	49,0	62	54	19.000	1	007290030
32	51,5	63	54	19.450	1	007290032
33	52,5	63	54	19.450	1	007290033
34	54,0	63	54	19.450	1	007290034
36	56,5	66	54	19.450	1	007290036
38	59,0	66	54	23.500	1	007290038
41	62,5	68	54	23.900	1	007290041
46	69,0	72	54	26.700	1	007290046
50	74,0	76	54	33.000	1	007290050
55	80,0	84	54	35.200	1	007290055
60	86,5	88	54	42.500	1	007290060
65	92,5	92	54	48.800	1	007290065
70	99,0	96	54	62.550	1	007290070
75	105,0	102	63	73.050	1	007290075
80	111,5	102	63	78.550	1	007290080

729L

Hosszú 1"-os gépi dugókulcs, foszfátzott



mm	D mm	L mm	Ø1 mm	Ft		
24	41,5	108	54	33.600	1	007290324
27	45,0	108	54	33.600	1	007290327
30	49,0	108	54	33.600	1	007290330
32	51,5	108	54	33.600	1	007290332
33	52,2	108	54	34.000	1	007290333
34	54,0	108	54	34.000	1	007290334
36	56,5	108	54	34.000	1	007290336
41	62,5	108	54	40.500	1	007290341
46	69,0	108	54	46.950	1	007290346
50	74,0	108	54	52.650	1	007290350
55	80,0	108	54	62.950	1	007290355
60	86,5	108	54	68.200	1	007290360
65	92,5	108	54	82.200	1	007290365
70	99,0	108	54	93.500	1	007290370
75	105,0	108	63	105.700	1	007290375
80	111,5	108	63	110.900	1	007290380

729LS

Hosszú könnyített 1"-os gépi dugókulcs, foszfátzott



mm	D mm	L mm	Ø1 mm	Ft		
22	36,0	108	53	33.600	1	007290522
24	38,5	108	53	33.600	1	007290524
27	46,0	108	53	33.600	1	007290527
30	50,0	108	53	35.600	1	007290530
32	50,0	108	53	35.600	1	007290532
33	52,0	108	53	35.600	1	007290533
36	56,0	108	53	35.600	1	007290536

729T

Gépi torziós dugókulcs kerékanyához



mm	L mm	Ft			
24	350	300	65.400	1	007290724
27	450	300	65.400	1	007290757
30	500	300	66.200	1	007290730
32	450	300	67.200	1	007290732
32	600	300	67.200	1	007290762
33	600	300	70.650	1	007290763
36	600	300	74.900	1	007290736

729/15

Szűrítő közbetét, 1"-3/4", foszfátzott



L mm	Ø mm	Ft		
66,5	54	22.450	1	007290810



Ügyeljünk a forgató nyomatékra, fokozatosan növeljük, hogy a törést, illetve az esetleges sérülést elkerüljük.

729/16

Bővítő közbetét 1" - 1.1/2", foszfátzott



L mm	Ø mm	Ft		
88	54,0	37.050	1	007290813

729/21

1"-os toldó



L mm	Ø mm	Ft		
175	54	34.600	1	007290815

729/21L

1"-os négyszögletes toldó



L mm	Ø mm	Ft		
250	54	42.100	1	007290826

729/22

1"-os toldó



L mm	Ø mm	Ft		
330	54	49.400	1	007290825

729/25

1"-os csukló



L mm	Ø mm	Ft		
130	54	71.450	1	007290830

729/OR... - 729/SP...

O-gyűrű, biztosító csap



	728	729-730	Ft		
	mm	mm			
729/OR1	50+60	24+70	975	5	007290927
729/OR2	75+125		1.520	5	007290928
729/SP1	50+60	24+70	920	5	007290917
729/SP2	75+125		1.520	5	007290918

852

csuklós T-szárú bitkulcs

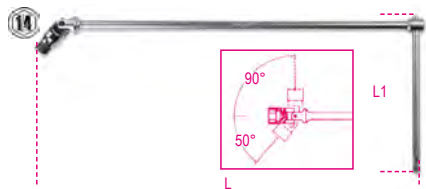

Ø	L	L1	Ft	cs	db
1/4"	400	160	21.650	2	008520006

855P

Betéttartócsavarhúzó állítható nyéllel, irányváltós racsnival, 7 betéttel



L	L1	Ft	cs	db
240	100	34.200	1	008550010

+	860PH	PH1 - PH2
+	860PZ	PZ1 - PZ2
●	860LP	LP 0,8X5,5 mm
○	860PE	4 - 5 mm

860LP

Színes csavarhúzóbetét hasítottfejű csavarokhoz



ISO 2351-1
ISO 1173 C 6,3

SxA	L	Ft	cs	db
0,5x3	25	900	5	008600005
0,6x4,5	25	900	5	008600010
0,8x5,5	25	900	5	008600015
1x5,5	25	900	5	008600020
1,2x6,5	25	900	5	008600025

860PH

Színes csavarhúzóbetét Phillips®-csavarokhoz



ISO 2351-2
ISO 1173 C 6,3

PH	L	Ft	cs	db
0	25	900	5	008600220
1	25	900	5	008600225
2	25	900	5	008600230
3	25	900	5	008600245
4	25	1.300	5	008600250

860PZ

Színes csavarhúzóbetét Pozidriv®- és Supadriv®-csavarokhoz



ISO 2351-2
ISO 1173 C 6,3

PZ	L	Ft	cs	db
1	25	900	5	008600320
2	25	900	5	008600325
3	25	900	5	008600330
4	25	1.300	5	008600335

860PE

Színes hatlapú csavarhúzóbetét



ISO 2351-3
ISO 1173 C 6,3

mm	L	Ft	cs	db
2	25	960	5	008600101
2,5	25	960	5	008600102
3	25	960	5	008600103
4	25	960	5	008600104
5	25	960	5	008600105
6	25	960	5	008600106
8	25	1.200	5	008600108
10	25	1.200	5	008600110

860TX

Színes csavarhúzóbetét Torx®-csavarokhoz



ISO 1173 C 6,3

Ø	L	Ft	cs	db
T6	25	1.200	5	008600704
T7	25	1.200	5	008600705
T8	25	1.200	5	008600710
T9	25	1.200	5	008600715
T10	25	960	5	008600720
T15	25	960	5	008600725
T20	25	960	5	008600730
T25	25	960	5	008600735
T27	25	960	5	008600740
T30	25	960	5	008600745
T40	25	960	5	008600750

860RTX

Színes csavarhúzóbetét Tamper Resistant Torx®-csavarokhoz



ISO 1173 C 6,3

Ø	L	Ft	cs	db
T9	25	1.300	5	008600550
T10	25	1.300	5	008600555
T15	25	1.300	5	008600560
T20	25	1.300	5	008600565
T25	25	1.300	5	008600570
T27	25	1.300	5	008600575
T30	25	1.300	5	008600580
T40	25	1.300	5	008600585

860/55

Átváltós racsni



L	Ø	Ft	cs	db
100	1/4"	15.400	3	008600870

860/58

betéttartó racsni forgó markolattal

- A bit mindkét oldalán behelyezhető a be- vagy kicsavaráshoz
- Kétféle anyagú markolat



L	Ø	A	Ft	cs	db
860/58	126	1/4"	27	15	35.200

860/C27

25 csavarhúzóbetét, 1 betéttartó és 1 irányváltós racsni, műanyag dobozban



860/C27	Ft	cs	db
	41.750	1	008600880

860/55	100 mm
860LP	0,5x3-1,0x5,5-1,2x6,5 mm
860PH	PH1-PH2(x2)-PH3
860PZ	PZ1-PZ2(x2)-PZ3
860PE	2-2,5-3-4-5-6 mm
860TX	T6-T8-T10-T15-T20-T25-T30-T40
892/0	● 1/4 ■ 1/4



860/C38P

1 betéttartó irányváltós racsnival és csavarhúzónyéllel, 27 csavarhúzóbetét, 8 hatlapú dugókulcs és 2 tartozék szivacsbetétes fémdobozban

Betéttartó irányváltós racsnival
Betéttartófedél
Toldó gyorsoldással, levehető



860/C38P Ft 90.300 1 008600878

	860LP	0,6x4,5-0,8x5,5-1,0x5,5-1,2x6,5 mm
	860PE	2-2,5-3-4-5 mm
	860PH	PH1-PH2-PH3
	860PZ	PZ1-PZ2-PZ3
	860TX	T10-T15-T20-T25-T30-T40
	900	5-5,5-6-7-8-9-10-13 mm
	892/0	● 1/4 ■ 1/4
	892/3	● 1/4 ■ 1/4
	855P	240 mm

270x120x45 mm

861LP

Csavarhúzóbetétek hasítottfejű csavarokhoz



ISO 2351-1

ISO 1173 C 6,3

SxA mm	L mm	Ft	10	200	1000
0,5x3	25	585	10	008610005	
0,6x4	25	585	10	008610007	
0,6x4,5	25	585	10	008610010	
0,8x5,5	25	585	10	008610015	
1x5,5	25	585	10	008610020	
1,2x6,5	25	585	10	008610025	
1,2x8	25	1.110	10	008610028	
1,6x8	25	1.110	10	008610030	

861PH

Csavarhúzóbetétek Phillips®-csavarokhoz



ISO 2351-2

ISO 1173 C 6,3

PH	L mm	Ft	10	200	1000
0	25	575	10	008610200	
1	25	575	10	008610205	
2	25	575	10	008610210	
2L	50	1.110	10	008610213	
3	25	575	10	008610215	
4	25	1.540	10	008610220	

861PH/C

Csavarhúzóbetétek Phillips®-csavarokhoz



ISO 2351-2
ISO 1173 C 6,3

PH	L mm	Ft	10	200	1000
0	25	435	200	008610250	
1	25	435	200	008610255	
2	25	435	200	008610260	
2L	50	840	100	008610263	
3	25	435	200	008610265	
4	25	1.130	100	008610270	

861PZ

Csavarhúzóbetétek Pozidriv®-Supadriv® csavarokhoz



ISO 2351-2

ISO 1173 C 6,3

PZ	L mm	Ft	10	200	1000
1	25	575	10	008610300	
2	25	575	10	008610305	
2L	50	1.110	10	008610308	
3	25	575	10	008610310	
4	25	1.540	10	008610315	

861PZ/C

Csavarhúzóbetétek Pozidriv®-Supadriv® csavarokhoz



ISO 2351-2
ISO 1173 C 6,3

PZ	L mm	Ft	10	200	1000
1	25	435	200	008610350	
2	25	435	200	008610355	
2L	50	840	100	008610358	
3	25	435	200	008610360	
4	25	1.110	100	008610365	

861PE

Imbusz-csavarhúzóbetétek



ISO 2351-3

ISO 1173 C 6,3

mm	L mm	Ft	10	200	1000
2	25	615	10	008610100	
2,5	25	615	10	008610105	
3	25	615	10	008610110	
4	25	615	10	008610115	
5	25	615	10	008610120	
6	25	615	10	008610125	
8	25	925	10	008610130	
10	25	1.230	10	008610135	

861TX

Torx® csavarhúzóbetétek



ISO 1173 C 6,3

T	L mm	Ft	10	200	1000
T5	25	815	10	008610399	
T6	25	815	10	008610400	
T7	25	815	10	008610405	
T8	25	815	10	008610410	
T9	25	815	10	008610415	
T10	25	640	10	008610420	
T15	25	640	10	008610425	
T20	25	640	10	008610430	
T25	25	640	10	008610435	
T27	25	640	10	008610440	
T30	25	640	10	008610445	
T40	25	640	10	008610450	

861TX/C

Torx® csavarhúzóbetétek



ISO 1173 C 6,3

T	L mm	Ft	10	200	1000
T10	25	495	200	008610470	
T15	25	495	200	008610475	
T20	25	495	200	008610480	
T25	25	495	200	008610485	
T27	25	495	200	008610490	
T30	25	495	200	008610495	
T40	25	495	200	008610499	

861RTX

Tamper Resistant Torx(R) csavarhúzóbetétek

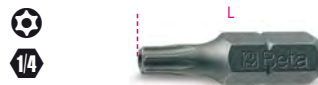

ISO 1173 C 6,3

T	L mm	Ft	10	200	1000
T6	25	1.200	10	008610537	
T7	25	1.200	10	008610538	
T8	25	1.200	10	008610540	
T9	25	1.200	10	008610500	
T10	25	1.200	10	008610505	
T15	25	1.200	10	008610510	
T20	25	1.200	10	008610515	
T25	25	1.200	10	008610520	
T27	25	1.200	10	008610525	
T30	25	1.200	10	008610530	
T40	25	1.200	10	008610535	
T45	25	2.350	10	008610539	



861TRW

1/4"-os Tri-Wing® csavarhúzó betét



ISO 1173 C 6,3

GR	L mm	Ft		
1	25	1.020	10	008610601
2	25	1.020	10	008610602
3	25	1.020	10	008610603
4	25	1.020	10	008610604
5	25	1.020	10	008610605
6	25	1.500	10	008610606

861TQS

1/4"-os Torq-Set® csavarhúzó betét



ISO 1173 C 6,3

GR	L mm	Ft		
0	25	1.020	10	008610620
1	25	1.020	10	008610621
2	25	1.020	10	008610622
3	25	1.020	10	008610623
4	25	1.020	10	008610624
5	25	1.020	10	008610625
6	25	1.020	10	008610626
8	25	1.020	10	008610628
10	25	1.020	10	008610630

861SP

Speciális csavarhúzóbetétek beállító csavarokhoz



ISO 1173 C 6,3

SP	D mm	L mm	Ft		
4	1,5	25	840	10	008610650
6	2,4	25	840	10	008610653
8	2,8	25	840	10	008610656
10	3,3	25	840	10	008610658
12	3,9	25	840	10	008610660

1483KV-PT/S7



1483KV PT/S7

180



861PHZ/A10

10 darab csavarhúzóbetét, mágneses betéttartóval, tokban



861PHZ/A10 Ft 14.050 1 008610810

+	861PH	PH1 PH2 PH3	1 3 1
+	861PZ	PZ1 PZ2 PZ3	1 3 1
	882M1	○ 1/4 ● 1/4	

861PE/A10

10 darab csavarhúzóbetét, mágneses betéttartóval, tokban



861PE/A10 Ft 14.750 1 008610820

○	861PE	2 - 2,5 3 - 4 - 5 6 - 8 mm	1 2 1
	882M1	○ 1/4 ● 1/4	

861TX/A10

10 darab csavarhúzóbetét, mágneses betéttartóval, tokban



861TX/A10 Ft 15.200 1 008610870

○	861TX	T7 - T8 - T9 - T10 - T15 - T20 T25 - T27 - T30 - T40	1
	882M1	○ 1/4 ● 1/4	

861MIX/A10

10 darab csavarhúzóbetét, mágneses betéttartóval, tokban



861MIX/A10 Ft 14.050 1 008610800

○	861LP	0,5x3 - 1x5,5 x 1,2x6,5 mm	1
+	861PH	PH1 PH2 PH3	1 2 1
+	861PZ	PZ1 - PZ2 - PZ3	1
	882M1	○ 1/4 ● 1/4	

861MIX/A31

30 darab csavarhúzóbetét, mágneses gyorskioldó betéttartóval, tokban



861MIX/A31 Ft 34.450 1 008610802

○	861LP	0,5x3 - 0,6x4,5 - 0,8x5,5 - 1,0x5,5 - 1,2x6,5 mm	
+	861PH	PH0 - PH1 - PH2 - PH3 - PH4	
○	861PE	2 - 2,5 - 3 - 4 - 5 - 6 8 - 10 mm	
+	861PZ	PZ1 - PZ2 - PZ3 - PZ4	
+	861RTX	T9 - T10 - T15 - T20 - T25 T27 - T30 - T40	
	882MSR 50	○ 1/4 ● 1/4	



861/C61P

61 csavarhúzóbetét és 1 betéttartó, mágneses

1/4



861/C61P Ft 78.050 1 008610978

	861LP	0,5x3 - 0,6x4,5 - 0,8x5,5 - 1,0x5,5 1,2x6,5 - 1,2x8 - 1,6x8 mm
	861PE	2 - 2,5 - 3 - 4 - 5 - 6 - 8 - 10 mm
	861PH	PH0 - PH1 - PH2 - PH3
	861PZ	PZ1 - PZ2 - PZ3
	861TX	T6 - T7 - T8 - T9 - T10 - T15 T20 - T25 - T27 - T30 - T40
	861RTX	T9 - T10 - T15 - T20 - T25 T27 - T30 - T40
	861TRW	1 - 2 - 3 - 4 - 5 - 6
	861TQS	0 - 1 - 2 - 3 - 4 - 5 - 6 - 8 - 10
	861SP	4 - 6 - 8 - 10 - 12
	851SR	1/4"

270x120x45 mm - 975 g

862LP

Hosszú csavarhúzóbetétek hasított fejű csavarhoz

1/4



ISO 2351-1

ISO 1173 E 6,3

SxA mm	L mm	Ft	5	10
0,5x3	50	1.680	5	008620005
0,6x4,5	50	1.680	5	008620010
0,8x5,5	50	1.680	5	008620015
1x5,5	50	1.680	5	008620020
1,2x6,5	50	1.680	5	008620025
1,2x8	50	2.060	5	008620030
1,6x8	50	2.060	5	008620035

862PH

Hosszú csavarhúzóbetétek Phillips®-csavarhoz

1/4



ISO 2351-2

ISO 1173 E 6,3

PH	L mm	Ft	5	10
1	50	1.680	5	008620200
2	50	1.680	5	008620205
3	50	1.680	5	008620210

862PH/L

Csavarhúzóbetét Phillips®-csavarhoz

+

1/4



ISO 2351-2

ISO 1173 E 6,3

PH	L mm	Ft	5	10
1	70	3.080	5	008620230
2	70	3.080	5	008620232
3	70	3.080	5	008620234

862PH-XL

csavarbehajtó betét Phillips® keresztornyos csavarokhoz

+

1/4



ISO 2351-2 ISO 1173 E 6,3

PH	L mm	Ft	5	10
1	100	3.160	5	008620250
2	100	3.160	5	008620252
3	100	3.160	5	008620254

862PZ

Hosszú csavarhúzóbetétek Pozidriv®-Supadriv® csavarhoz

+

1/4



ISO 2351-2

ISO 1173 E 6,3

PZ	L mm	Ft	5	10
1	50	1.720	5	008620300
2	50	1.720	5	008620305
3	50	1.720	5	008620310

862PE

Hosszú imbusz-csavarhúzóbetétek

+

1/4



ISO 2351-3

ISO 1173 E 6,3

mm	L mm	Ft	5	10
3	50	1.720	5	008620103
4	50	1.720	5	008620104
5	50	1.720	5	008620105
6	50	1.720	5	008620106
8	50	2.350	5	008620108

862TX

Csavarhúzóbetét Torx®-csavarokhoz

+

1/4



ISO 1173 E 6,3

T	L mm	Ft	5	10
T6	50	2.310	5	008620506
T7	50	2.310	5	008620507
T8	50	2.310	5	008620508
T9	50	2.310	5	008620509
T10	50	2.310	5	008620510
T15	50	2.310	5	008620515
T20	50	2.310	5	008620520
T25	50	2.310	5	008620525
T27	50	2.310	5	008620527
T30	50	2.310	5	008620530
T40	50	2.310	5	008620540

862TX/L

Csavarhúzóbetétek Torx®-csavarhoz

+

1/4



ISO 1173 E 6,3

T	L mm	Ft	5	10
T6	70	2.490	5	008620556
T7	70	2.490	5	008620557
T8	70	2.490	5	008620558
T9	70	2.490	5	008620559
T10	70	2.490	5	008620560
T15	70	2.490	5	008620565
T20	70	2.490	5	008620570
T25	70	2.490	5	008620575
T27	70	2.490	5	008620577
T30	70	2.490	5	008620580
T40	70	2.490	5	008620590

862TX-XL

csavarbehajtó betét Torx® csavarokhoz

+

1/4



ISO 1173 E 6,3

T	L mm	Ft	5	10
T9	100	2.730	5	008620659
T10	100	2.730	5	008620660
T15	100	2.730	5	008620665
T20	100	2.730	5	008620670
T25	100	2.730	5	008620675
T27	100	2.730	5	008620677
T30	100	2.730	5	008620680
T40	100	2.730	5	008620690



862F

Mágneses hatszögű dugókulcsbetétek



ISO 1173 E 6,3

mm	L mm	Ø mm	Ft	csomagolás	azonosító
5,5	65	11	3.140	5	008620405
6	65	11	3.140	5	008620406
7	65	11	3.140	5	008620407
8	65	13	3.140	5	008620408
10	65	15	3.400	5	008620410
12	65	18	3.790	5	008620412
13	65	18	3.990	5	008620413

862F/A7

7 hatlapú dugókulcsbetét, mágneses



862F/A7 Ft 23.700 1 008620950

862F 5,5-6-7-8-10-12-13 mm

862XP/A16

16 darabos betétkészlet, műanyag dobozban



862XP/A16 Ft 31.550 1 008620960

- PH2(x2)-PH3
- PZ2(x2)-PZ3
- T20-T25(x2)
- T30(x2)-T40(x2)
- Ø 4-5-6 mm

866LP

Csavarhúzóbetétek hasítottfejű csavarhoz



ISO 2351-1
ISO 1173 C 8

SxA mm	L mm	Ft	csomagolás	azonosító
1x5,5	41	1.720	10	008660005
1,2x6,5	41	1.720	10	008660010
1,6x8	41	1.720	10	008660015
1,6x10	41	2.350	10	008660020
2x12	41	2.910	10	008660025

866PH

Csavarhúzóbetétek Phillips®-csavarhoz



ISO 2351-2
ISO 1173 C 8

PH	L mm	Ft	csomagolás	azonosító
1	32	1.400	10	008660200
2	32	1.400	10	008660205
3	32	1.400	10	008660210
4	38	2.090	10	008660215

866PZ

Csavarhúzóbetétek Pozidriv®-Supadriv® csavarhoz



ISO 2351-2
ISO 1173 C 8

PZ	L mm	Ft	csomagolás	azonosító
1	32	1.480	10	008660300
2	32	1.480	10	008660305
3	32	1.480	10	008660310
4	38	2.190	10	008660315

866PE

Imbusz-csavarhúzóbetétek



ISO 2351-3
ISO 1173 C 8

mm	L mm	Ft	csomagolás	azonosító
3	30	1.200	10	008660100
4	30	1.200	10	008660105
5	30	1.200	10	008660110
6	30	1.200	10	008660115
7	30	1.200	10	008660117
8	30	1.200	10	008660120
10	30	1.680	10	008660125
12	30	2.350	10	008660132
14	30	3.020	10	008660134

866TX

Torx®-csavarhúzóbetét



ISO 1173 C 8

	L mm	Ft	csomagolás	azonosító
T20	30	1.520	10	008660400
T25	30	1.520	10	008660405
T27	30	1.520	10	008660410
T30	30	1.520	10	008660415
T40	30	1.520	10	008660420
T45	30	1.520	10	008660425
T50	30	1.520	10	008660430
T55	30	2.170	10	008660435
T60	30	2.910	10	008660440
T70	30	3.240	10	008660445

867PE

Hatszögű csavarhúzóbetétek



mm	L mm	Ft	csomagolás	azonosító
4	30	790	5	008670104
5	30	790	5	008670105
6	30	790	5	008670106
7	30	790	5	008670107
8	30	790	5	008670108
10	30	790	5	008670110
12	30	1.170	5	008670112

867PE/L

Hatszögű csavarhúzóbetétek



mm	L mm	Ft	csomagolás	azonosító
4	75	1.480	5	008670154
5	75	1.480	5	008670155
6	75	1.480	5	008670156
7	75	1.480	5	008670157
8	75	1.480	5	008670158
10	75	1.480	5	008670160
12	75	2.040	5	008670162

867XZN

Csavarhúzóbetétek XZN®-csavarhoz



	L mm	Ft	csomagolás	azonosító
M4	30	985	5	008670204
M5	30	985	5	008670205
M6	30	985	5	008670206
M8	30	985	5	008670208
M10	30	985	5	008670210
M12	30	1.480	5	008670212

867XZN/L

Csavarhúzóbetétek XZN®-csavarhoz



	L mm	Ft	5	10
M5	75	1.600	5	008670255
M6	75	1.600	5	008670256
M8	75	1.600	5	008670258
M10	75	1.600	5	008670260
M12	75	2.190	5	008670262

867TX

Csavarhúzóbetétek Torx®-csavarhoz



	L mm	Ft	5	10
T20	30	790	5	008670400
T25	30	790	5	008670405
T30	30	790	5	008670410
T40	30	790	5	008670415
T45	30	790	5	008670420
T50	30	790	5	008670425
T55	30	790	5	008670430

867TX/L

Csavarhúzóbetétek Torx®-csavarhoz



	L mm	Ft	5	10
T20	75	1.300	5	008670450
T25	75	1.300	5	008670455
T30	75	1.300	5	008670460
T40	75	1.300	5	008670465
T45	75	1.300	5	008670470
T50	75	1.300	5	008670475
T55	75	1.300	5	008670480

867RTX

Csavarhúzóbetétek
Tamper Resistant Torx®-csavarhoz



	L mm	Ft	5	10
T20	30	880	5	008670500
T25	30	880	5	008670505
T30	30	880	5	008670510
T40	30	880	5	008670515
T45	30	880	5	008670520
T50	30	880	5	008670525
T55	30	880	5	008670530

867RTX/L

Csavarhúzóbetétek
Tamper Resistant Torx®-csavarhoz



	L mm	Ft	5	10
T20	75	1.480	5	008670550
T25	75	1.480	5	008670555
T30	75	1.480	5	008670560
T40	75	1.480	5	008670565
T45	75	1.480	5	008670570
T50	75	1.480	5	008670575
T55	75	1.480	5	008670580

867RIBE

csavarbehajtó betét
RIBE® csavarokhoz



	L mm	Ft	5	10
M5	30	900	5	008670705
M6	30	900	5	008670706
M7	30	900	5	008670707
M8	30	900	5	008670708
M9	30	900	5	008670709
M10	30	900	5	008670710
M11	30	1.320	5	008670711
M12	30	1.320	5	008670712
M13	30	1.320	5	008670713

867RIBE/L

csavarbehajtó betét
RIBE® csavarokhoz



	L mm	Ft	5	10
M5	75	1.480	5	008670755
M6	75	1.480	5	008670756
M7	75	1.480	5	008670757
M8	75	1.480	5	008670758
M9	75	1.480	5	008670759
M10	75	1.480	5	008670760
M11	75	1.980	5	008670761
M12	75	1.980	5	008670762
M13	75	1.980	5	008670763

867/...

Betéttartó a 867-es betétekhez



	mm	mm	L mm	Ø mm	Ft	5	10
867/1	10	3/8"	38	17	2.830	5	008670600
867/2	10	1/2"	38	22	3.180	5	008670601

867/C20

18 RIBE® betét 10 mm hatlapfejű
csatlakozóval és 2 tartozékkal



867/C20	Ft	5	10
	55.850	1	008670920

867RIBE	5-6-7-8-9-10-11-12-13 mm
867RIBE/L	5-6-7-8-9-10-11-12-13 mm
867/1	
867/2	
335x145x60 mm - 1,7 kg	

867/C38

38 betét 10 mm hatlapfejű csatlakozóval és 1
csuklós T betéttartóval



867/C38	Ft	5	10
	102.900	1	008670938

852	10 mm
867PE	4-5-6-7-8-10-12mm
867PE/L	4-5-6-7-8-10-12mm
867XZN	M5-M6-M8-M10-M12
867XZN/L	M5-M6-M8-M10-M12
867TX	T20-T25-T30-T40-T45-T50-T55
867TX/L	T20-T25-T30-T40-T45-T50-T55
882	
420x185x60 mm - 3 kg	



867/C52

52 hatszögű csavarhúzóbetét,
10 mm és 2 tartozék



867/C52 Ft 63.750 1 008670901

867PE	4-5-6-7-8-10-12 mm
867PE/L	4-5-6-7-8-10-12 mm
867XZN	M5-M6-M8-M10-M12
867XZN/L	M5-M6-M8-M10-M12
867TX	T20-T25-T30-T40-T45-T50-T55
867TX/L	T20-T25-T30-T40-T45-T50-T55
867RTX	T20-T25-T30-T40-T45-T50-T55
867RTX/L	T20-T25-T30-T40-T45-T50-T55
867/1	○ 10 mm - □ 3/8"
867/2	○ 10 mm - □ 1/2"

250x170x70 mm - 2,1 kg

852



852 1/4 79,117

882

1/4" külső és 1/4" belső mérettel
rendelkező betéttartó



ISO 1173 E 6,3

L mm 57 1/4 1/4 11 Ft 7.850 5 008820001

882AN

kúpkeres hajtómű, 1/4" hatlapfejű
csatlakozó

- 10 mm és 13 mm orsójú elektromos fúrógéphez és 1/4" ütvecsavarozókhoz
- Max. fordulatszám: 3600 rpm
- Max. nyomaték: 30 Nm
- Gyors cserét biztosító betéttartóval
- Áttétel: 1:1
- A szerszámmal 1/4" hatszögű D6.3 csatlakozóval



ISO 1173 E 6,3
ISO 1173 C 6,3

L mm 137 1/4 1/4 Ft 33.800 1 008820090

882M1

1/4" külső és 1/4" belső mérettel
rendelkező betéttartó



ISO 1173 E 6,3

L mm 50 1/4 1/4 11 Ft 8.300 5 008820006

882M

1/4" külső és 1/4" belső mérettel
rendelkező betéttartó



ISO 1173 E 6,3

L mm 75 1/4 1/4 11 Ft 10.050 5 008820005

882MSR

Mágneses betéttartó, gyorslazítással



ISO 1173 E 6,3

L mm 50 75 1/4 1/4 11 Ft 8.950 10.300 5 008820205 5 008820207

882P

Mágneses betéttartó



L mm 80 1/4 1/4 10 Ft 7.290 5 008820080



892

Adapter dugókulcshoz



892/0
892/1
892/2
892/3
892/4
892/5
892/6
892/7

	□	●	L mm	Ft	5	1
892/0	1/4	1/4	25	2.570	5	008920000
892/1	1/4	5,5	50	4.900	5	008920001
892/2	3/8	5,5	50	7.250	5	008920002
892/3	1/4	1/4	50	4.900	5	008920003
892/4	3/8	1/4	50	7.250	5	008920004
892/5	1/4	5/16	75	6.720	5	008920005
892/6	3/8	5/16	75	9.880	5	008920006
892/7	1/2	1/4	75	10.300	5	008920007

* ISO 1173 A 5,5
° ISO 1173 C 6,3

895

Betéttartók 861 - 862 - 866
betétekhez 1/4", 3/8" és 1/2"



DIN 7427

	○	□	L mm	∅ mm	Ft	5	1
895/1	1/4	1/4	25,4	12	5.870	5	008950000
895/3	1/4	3/8	29	16,8	7.000	5	008950001
895/4	5/16	3/8	29	16,8	7.000	5	008950002
895/5	1/4	1/2	38	22	7.000	5	008950005
895/6	5/16	1/2	38	22	7.000	5	008950003

897

1/4"-os flexibilis betéttartó csavarhúzónyéllel



L mm 280 L1 mm 154 Ft 13.350 2 008970010

897L

Flexibilis betéttartó, nyéllel, hosszított kivitel



L mm 500 L1 mm 380 Ft 15.400 2 008970015

TÍPUSÚ RACSNIK

ÚJ DESIGN: A BETA JÓL BEVÁLT RACSNITERMÉKCSALÁDJA, AMELYET A CÉG OLASZORSZÁGI GYÁRAIBAN TERVEZTEK ÉS GYÁRTOTTAK, MOST ÚJ, STÍLUSOS MEGJELENÉST KAPOTT.

- Innovatív anyagok a kiemelkedő teljesítmény érdekében
- A racsnifejre gyakorolt kézi nyomás nem okoz irányváltást, és lehetővé teszi a szabad hajtószár mozgását
- Egykezes irányváltás

Foszfátzott négyszögletes csatlakozó

Kisebb fej méret

Ergonomikus kétkomponensű markolat

Akasztólyuk a markolaton

72



A 72-fogas gyűrűnek köszönhetően alkalmas szűk helyeken történő munkavégzéshez, legfeljebb 5°-os szögben

900

Hatlapú dugókulcs

1/4"



UNI/ISO 2725 DIN 3124

Ø mm	Ø mm	L mm	Ø1 mm	Ft	csomagolás	azonosító
3,2	6,6	25	11,8	1.820	10	009000032
4	6,8	25	11,8	1.820	10	009000040
4,5	7,4	25	11,8	1.820	10	009000045
5	8,0	25	11,8	1.820	10	009000050
5,5	8,7	25	11,8	1.820	10	009000055
6	9,3	25	11,8	1.820	10	009000060
7	10,4	25	11,8	1.820	10	009000070
8	11,8	25	12,7	1.820	10	009000080
9	12,7	25	11,8	1.820	10	009000090
10	14,2	25	12,0	1.820	10	009000100
11	15,8	25	12,5	1.820	10	009000110
12	17,2	25	13,5	1.820	10	009000120
13	18,0	25	13,5	1.840	10	009000130
14	20,0	25	15,0	1.860	10	009000140

1/4"



900/SB13

4-4,5-5-5,5-6-7-8-9
10-11-12-13-14 mm

Ft 32.200

1 csomagolás 009000150

900MB

Tizenkétszögű dugókulcs

1/4"



UNI/ISO 2725 DIN 3124

Ø mm	Ø mm	L mm	Ø1 mm	Ft	csomagolás	azonosító
4	6,7	22	11,2	3.540	5	009000160
5	7,7	25	11,2	3.540	5	009000161
5,5	8,3	25	11,2	3.540	5	009000162
6	9,0	25	11,2	3.540	5	009000163
7	10,2	25	11,2	3.540	5	009000164
8	11,3	25	12,0	3.540	5	009000165
9	13,0	25	12,0	3.540	5	009000166
10	14,3	25	12,9	3.540	5	009000167
11	16,0	25	14,3	3.540	5	009000168
12	17,4	25	16,0	3.540	5	009000169
13	18,0	25	16,4	3.930	5	009000170
14	19,3	25	17,9	4.130	5	009000171

1/4"



900MB/SB12

4-5-5,5-6-7-8-9-10
11-12-13-14 mm

Ft 51.450

1 csomagolás 009000179

900L

Hatlapú hosszú dugókulcs



UNI/ISO 2725 DIN 3124

mm	Ø	L	Ø1	Ft	csomagolás	azonosító
4	6,5	50	12,0	4.250	5	009000181
4,5	7,0	50	12,0	4.250	5	009000182
5	7,5	50	12,0	4.250	5	009000183
5,5	8,5	50	12,0	4.250	5	009000184
6	9,5	50	12,0	4.250	5	009000185
7	10,5	50	12,0	4.250	5	009000186
8	12,0	50	12,0	4.250	5	009000187
9	13,0	50	13,0	4.250	5	009000188
10	14,0	50	14,0	4.410	5	009000189
11	16,0	50	16,0	4.410	5	009000190
12	17,5	50	17,5	4.410	5	009000191
13	17,5	50	17,5	4.410	5	009000192
14	20,0	50	20,0	4.410	5	009000193



900L/SB13 Ft 64.550 1 009000203
4-4,5-5-5,5-6-7-8-9-10-11-12-13-14 mm

900MB/L

Tizenkétszögű hosszú dugókulcs



UNI/ISO 2725 DIN 3124

mm	Ø	L	Ø1	Ft	csomagolás	azonosító
5	8,0	50	12,0	6.560	3	009000211
6	9,3	50	12,0	6.560	3	009000212
7	10,9	50	12,0	6.560	3	009000213
8	11,6	50	12,0	6.560	3	009000214
9	13,0	50	12,0	6.560	3	009000215
10	14,3	50	12,8	6.960	3	009000216
11	16,0	50	14,2	6.960	3	009000217
12	17,4	50	15,5	6.960	3	009000218
13	18,0	50	16,2	7.040	3	009000219
14	19,0	50	17,1	7.170	3	009000220



900AS

Hatlapú dugókulcs



"	Ø	L	Ø1	Ft	csomagolás	azonosító
5/32	8,8	25	11,9	2.000	5	009000349
3/16	7,7	25	11,9	2.000	5	009000340
7/32	8,8	25	11,9	2.000	5	009000345
1/4	9,6	25	11,9	2.000	5	009000350
9/32	10,2	25	11,9	2.000	5	009000355
5/16	11,3	25	11,9	2.000	5	009000360
11/32	12,7	25	11,6	2.000	5	009000365
3/8	14,0	25	12,9	2.000	5	009000370
7/16	15,3	25	14,5	2.000	5	009000375
1/2	17,5	25	16,4	2.020	5	009000380
9/16	19,0	25	17,9	2.040	5	009000385



900AS/SB11 Ft 29.550 1 009000389
3/16-7/32-5/32-1/4-9/32-5/16
11/32-3/8-7/16-1/2-9/16

900AS/MB

Tizenkétszögű dugókulcs



SAE AS 954E

"	Ø	L	Ø1	Ft	csomagolás	azonosító
3/16	7,7	22	10,9	3.600	2	009000390
7/32	8,5	22	10,9	3.600	2	009000391
1/4	9,4	22	10,9	3.600	2	009000392
9/32	10,2	22	10,9	3.600	2	009000393
5/16	11,3	22	11,7	3.600	2	009000394
11/32	12,5	22	12,0	3.600	2	009000395
3/8	13,7	22	12,9	3.850	2	009000396
7/16	15,6	22	14,3	3.850	2	009000397
1/2	17,2	22	16,4	4.290	2	009000398
9/16	18,8	24	17,9	4.330	2	009000399

900AS/L

Hatlapú hosszú dugókulcs



SAE AS 954E

"	Ø	L	Ø1	Ft	csomagolás	azonosító
3/16	7,0	50	12,0	4.450	2	009000301
7/32	8,5	50	12,0	4.450	2	009000303
1/4	9,8	50	12,0	4.450	2	009000305
9/32	10,5	50	12,0	4.450	2	009000307
5/16	12,0	50	12,0	4.450	2	009000309
11/32	13,0	50	13,0	4.450	2	009000311

"	Ø	L	Ø1	Ft	csomagolás	azonosító
3/8	14,0	50	14,0	4.450	2	009000313
7/16	16,0	50	16,0	4.450	2	009000315
1/2	17,5	50	17,5	4.450	2	009000317
9/16	20,0	50	20,0	4.780	2	009000319

900AS/MBL

Tizenkétszögű hosszú dugókulcs



"	Ø	L	Ø1	Ft	csomagolás	azonosító
5/32	6,8	50	12,0	6.920	2	009000325
3/16	8,0	50	12,0	6.920	2	009000326
7/32	8,5	50	12,0	6.920	2	009000327
1/4	9,8	50	12,0	6.920	2	009000328
9/32	10,9	50	12,0	6.920	2	009000329
5/16	11,6	50	12,0	6.920	2	009000330
11/32	13,0	50	12,0	6.920	2	009000331
3/8	14,3	50	12,8	7.410	2	009000332
7/16	16,0	50	14,2	7.410	2	009000333
1/2	18,0	50	16,2	7.410	2	009000334
9/16	19,0	50	17,1	7.410	2	009000335

900U

multifunkciós dugókulcsok



mm	"	csomagolás	Ø	Ø1	Ft	csomagolás	azonosító
4	5/32	E5	M5	1.920	5	009001702	
4,5	3/16	E6		1.920	5	009001703	
5	13/64		M6	1.920	5	009001704	
5,5	7/32	E7		1.920	5	009001705	
6	1/4	E8	M8	1.920	5	009001706	
7	9/32			1.920	5	009001707	
8	5/16	E10	M10	1.920	5	009001708	
9	11/32			1.920	5	009001709	
10	3/8	E12	M12	1.920	5	009001710	
11	7/16	E14	M14	1.920	5	009001711	
12	15/32	E16		1.920	5	009001712	
13	1/2		M16	1.940	5	009001713	
14	9/16	E18	M18	1.960	5	009001714	



900U/SB13 Ft 33.550 1 009001750
4-4,5-5-5,5-6-7-8-9
10-11-12-13-14 mm

900FTX

Dugókulcs Torx®-csavarokhoz



	Ø mm	L mm	Ø1 mm	Ft		
E4	5,4	22	11,2	3.380	5	009000404
E5	6,7	22	11,2	3.380	5	009000405
E6	7,7	22	11,2	3.380	5	009000406
E7	8,3	22	11,2	3.380	5	009000407
E8	9,6	22	11,2	3.380	5	009000408
E10	11,3	22	12,0	3.380	5	009000410
E11	12,1	22	12,5	4.620	5	009000411
E12	12,9	23	12,9	4.620	5	009000412
E14	14,0	25	14,0	4.620	5	009000414



900FTX/SB9
E4-E5-E6-E7-E8
E10-E11-E12-E14

Ft 40.550 1 009000419

900LP

Csavarhúzó-dugókulcs hasítottfejű csavarokhoz, krómozott, barnított hegy

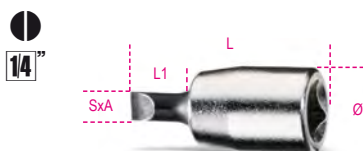

SxA mm	Ø mm	L mm	L1 mm	Ft		
0,8x4	12	28	9	4.090	5	009000605
1x5,5	12	28	9	4.090	5	009000610
1,2x6,5	12	28	9	4.090	5	009000615
1,2x8	13	28	8	4.090	5	009000620
1,6x10	14	28	8	4.090	5	009000625

900MC/LP

dugókulcs hasítottfejű csavarokhoz, színezett

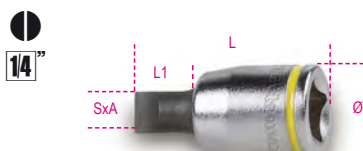

SxA mm	Ø mm	L mm	L1 mm	Ft		
0,8x4	12	28	9	6.400	3	009002605
1,2x6,5	12	28	9	6.400	3	009002615
1,2x8	13	28	8	6.400	3	009002620

900PH

Csavarhúzó-dugókulcs Phillips(R)-csavarokhoz, krómozott, barnított hegy



PH	Ø mm	L mm	L1 mm	Ft		
1	12	28	12	4.450	5	009000701
2	12	28	12	4.450	5	009000702
3	12	28	12	4.450	5	009000703
4	13	28	11	4.450	5	009000704



900PH/SB4
PH1-PH2-PH3-PH4

Ft 21.600 1 009000708

900MC/PH

dugókulcs keresztfejű Phillips® csavarokhoz, színezett

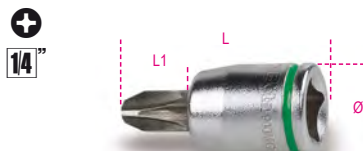

PH	Ø mm	L mm	L1 mm	Ft		
1	12	28	12	6.680	3	009002701
2	12	28	12	6.680	3	009002702
3	12	28	12	6.680	3	009002703

900PZ

dugókulcs keresztfejű Pozidriv®-Supadriv® csavarokhoz



PZ	Ø mm	L mm	Ft		
1	12	28	4.700	3	009000711
2	12	28	4.700	3	009000712
3	12	28	4.700	3	009000713

900ME

1/4"-os imbusz-dugókulcs, krómozott, barnított hegy



mm	Ø mm	L mm	L1 mm	Ft		
2,5	12	25	4,5	3.850	5	009000502
3	12	25	5,0	3.850	5	009000503
4	12	25	5,6	3.850	5	009000504
5	12	25	6,3	3.850	5	009000505
6	12	25	7,6	3.850	5	009000506
7	13	25	7,2	3.850	5	009000507
8	13	25	8,0	3.850	5	009000508
10	13	25	8,7	4.780	5	009000510



900ME/SB8
2,5-3-4-5-6-7-8-10 mm

Ft 37.600 1 009000518

900PE/AS

Imbusz dugókulcs készlet 1/4"-os krómozott, barnított betétek



"	Ø mm	L mm	Ft		
1/8	11,9	25	8.790	5	009000521
5/32	11,9	25	8.790	5	009000522
3/16	11,9	25	8.790	5	009000523
7/32	11,9	25	8.790	5	009000524
1/4	11,9	25	8.790	5	009000525
9/32	13,1	25	8.790	5	009000526
5/16	13,1	25	8.790	5	009000527

900PT

Ótlapú csavarhúzó-dugókulcs



	Ø mm	L mm	L1 mm	Ft		
PT10	12	28	12	8.180	5	009000750
PT15	12	28	12	8.180	5	009000755
PT20	12	28	12	8.180	5	009000760
PT25	12	28	12	8.180	5	009000765
PT27	12	28	12	8.180	5	009000767
PT30	12	28	12	8.180	5	009000770

900TX

1/4"-os Torx(R)-imbusz dugókulcs, krómzott, fekete hegyek



Ø	L	L1	Ft	5	10
mm	mm	mm			
T6	12	28	12	5.950	5 009000717
T7	12	28	12	5.950	5 009000718
T8	12	28	12	6.030	5 009000719
T9	12	28	12	6.030	5 009000720
T10	12	28	12	6.030	5 009000721
T15	12	28	12	6.030	5 009000722
T20	12	28	12	6.030	5 009000723
T25	12	28	12	6.030	5 009000724
T27	12	28	12	6.030	5 009000725
T30	12	28	12	6.030	5 009000726
T40	12	28	12	6.030	5 009000727



900TX/SB8	Ft	1	10
T9-T10-T15-T20 T25-T27-T30-T40	54.150	1	009000730

900MC/TX

dugókulcs
Torx® csavarokhoz, színezett



Ø	L	L1	Ft	3	10
mm	mm	mm			
T10	12	28	12	6.920	3 009002721
T15	12	28	12	6.920	3 009002722
T20	12	28	12	6.920	3 009002723
T25	12	28	12	6.920	3 009002724
T27	12	28	12	6.920	3 009002725
T30	12	28	12	6.920	3 009002726
T40	12	28	12	6.920	3 009002727

900/16

Bővítő közbetét 1/4" - 3/8"



UNI/ISO 3316 DIN 3123

L	Ø	1/4	3/8	Ft	5	10
mm	mm					
28	13,0	1/4	3/8	3.140	5	009000814

900/...

Toldók

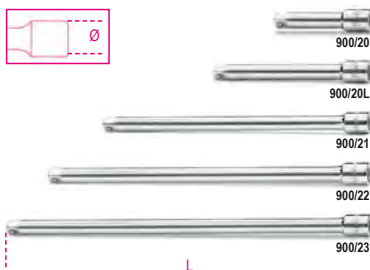

UNI/ISO 3316 DIN 3123

	L	Ø	Ft	5	10
	mm	mm			
900/20	50	11,5	3.990	5	009000818
900/20L	100	11,5	4.090	5	009000819
900/21	150	11,5	4.290	5	009000822
900/22	250	11,5	6.280	5	009000823
900/23	350	11,5	7.530	5	009000824

900AN

1/4"-os gömbvégű toldó

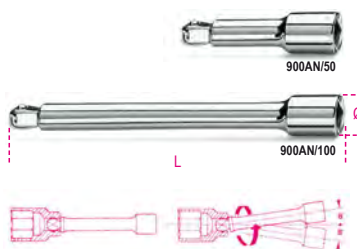

	L	Ø	Ft	3	10
	mm	mm			
900AN/50	50	11,5	4.330	3	009000825
900AN/100	100	11,5	4.780	3	009000826

900FL

1/4"-os flexibilis toldó, krómzott

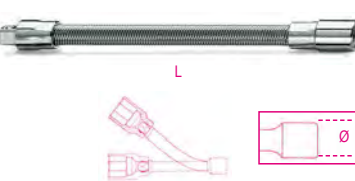

L	Ø	Ft	3	10
mm	mm			
150	12	6.360	3	009000828

900/25

1/4"-os csuklós



UNI/ISO 3316 DIN 3123

L	Ø	Ft	5	10
mm	mm			
41	12,5	7.730	5	009000830

900BG/30C

1/4"-os hajtószer

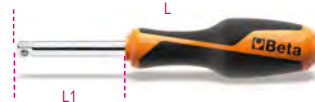

UNI/ISO 3315 DIN 3122

L	L1	Ft	5	10
mm	mm			
128	20	3.810	5	009000833

900BG/30

1/4"-os hajtószer

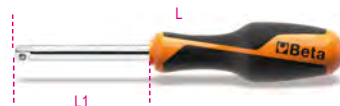

UNI/ISO 3315 DIN 3122

L	L1	Ft	5	10
mm	mm			
176	68	3.990	5	009000834

900/32

1/4"-os flexibilis hajtószer



L	L1	Ft	2	10
mm	mm			
280	154	9.190	2	009000839

900/35A

1/4"-os csuklós hajtószer, krómzott



UNI/ISO 3315 DIN 3122

L	L1	Ft	5	10
mm	mm			
148	84	13.150	5	009000840

900M/35

1/4"-os csuklós fém hajtószer



UNI/ISO 3315
DIN 3122

L	Ft	3	10
mm			
130	16.800	3	009000845

900/40

1/4"-os csuklós T-hajtósár

1/4"

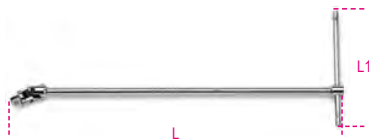

L	L1	Ft	3	009000843
mm	mm			
390	145	17.600		

900/42

1/4"-os csúszkás T-hajtósár

1/4"



UNI/ISO 3315 DIN 3122

L	A	Ft	5	009000854
mm	mm			
115	22	4.370		

900T/44

hajlított 1/4" hajtósár
működető markolattal

1/4"



L	L1	Ft	2	009000860
mm	mm			
238	105	6.600		

900/55

1/4" irányváltós racsní, 48 fogas mechanizmus

1/4"

48



UNI/ISO 3315 DIN 3122

L	Ø	A	Ft	5	009001155
mm	mm	mm			
127	25	29	21.450		

900/55Z

1/4" irányváltós racsní, 72 fogas mechanizmus

1/4"

72



L	Ø	A	Ft	3	009000882
mm	mm	mm			
126	25	23	20.850		

900M/55

1/4"-os irányváltós fémracsní

1/4"

20



UNI/ISO 3315
DIN 3122

L	Ø	A	Ft	3	009000905
mm	mm	mm			
110	22	18	26.900		

Tartalék forgó alkatrészek



900/58

Irányváltós racsní

1/4"

52 fogú

- Hajtósár
- Nyitó és rögzítő gomb
- Irányváltás a fejen lévő műanyag gyűrű jobbra és balra forgatásával
- Bimateriál-nyél

1/4"

52



L	Ø	A	Ft	2	009000884
mm	mm	mm			
126	28	28,5	31.800		

900/C39N

11 hatlapfejű dugókulcs, 21 csavarhúzóbetét és 7 tartozék

1/4"

1/4"



900/C39N	Ft	1	009000947
	94.100		

861LP	0,6x4,5 - 1,2x6,5 - 1,2x8 mm
861PH	PH1-PH2-PH3
861PZ	PZ1-PZ2-PZ3
861PE	2,5-3-4-5-6 mm
861RTX	T10-T15-T20-T25-T27-T30-T40
900	5-5,5-6-7-8-9-10-11-12-13-14 mm
900/20	50 mm
900/20L	100 mm
900/25	
900BG/30C	128 mm
892/0	
895/1	
900/55Z	126 mm

900/C39U

11 multifunkciós dugókulcs, 21 csavarhúzóbetét és 7 tartozék

1/4"

1/4"



900/C39U	Ft	1	009001947
	95.200		

861LP	0,6x4,5 - 1,2x6,5 - 1,2x8 mm
861PH	PH1-PH2-PH3
861PZ	PZ1-PZ2-PZ3
861PE	2,5-3-4-5-6 mm
861RTX	T10-T15-T20-T25-T27-T30-T40
900U	○ 5-5,5-6-7-8-9-10-11-12-13-14 mm " 13/64-7/32-1/4-9/32-5/16 11/32-3/8-7/16-15/32-1/2-9/16 ⊗ E7-E8-E10-E12-E14-E16-E18 ○ M6-M8-M10-M12-M14-M16-M18
900/20	50 mm
900/20L	100 mm
900/25	
900BG/30C	128 mm
892/0	
895/1	
900/55Z	126 mm



900/C11

11 hatlapú dugókulcs,
20 csavarhúzóbetét és 8 betéttartó

1/4"

1/4"



900/C11 Ft 103.000 1 009000971

	861LP	0,5x3 - 0,8x5,5 1x5,5 - 1,2x6,5 mm
	861PE	3 - 4 - 5 - 6 - 8 mm
	861PH	0 - 1 - 2 - 3
	861TX	T8 - T10 - T15 - T20 T25 - T30 - T40
	895/1	
	900	5 - 5,5 - 6 - 7 - 8 - 9 - 10 11 - 12 - 13 - 14 mm
	900/16	□ 1/4 - ■ 3/8
	900/20	50 mm
	900/21	150 mm
	900/25	
	900BG/30	176 mm
	900/42	
	900/55	

≡ 270x120x45 mm - 1,2 kg

9899 900C11 Ft 6.190 1 098990132
Hőformált tálcá, üres

900/C11Z

11 hatlapú dugókulcs,
20 csavarhúzóbetét és 8 tartozék

1/4"

1/4"



900/C11Z Ft 102.400 1 009000984

	861LP	0,5x3 - 0,8x5,5 - 1x5,5 - 1,2x6,5 mm
	861PE	3 - 4 - 5 - 6 - 8 mm
	861PH	0 - 1 - 2 - 3
	861TX	T8 - T10 - T15 - T20 T25 - T30 - T40
	895/1	
	900	5 - 5,5 - 6 - 7 - 8 - 9 - 10 11 - 12 - 13 - 14 mm
	900/16	□ 1/4 - ■ 3/8
	900/20	50 mm
	900/21	150 mm
	900/25	
	900BG/30	176 mm
	900/42	
	900/55Z	

≡ 350x150x50 mm - 1,2 kg

9899 900C11 Ft 6.190 1 098990132
Hőformált tálcá, üres

900/C12MR

12 hatlapú dugókulcs,
20 csavarhúzóbetét és 7 tartozék
szivacsbetétes fémdobozban

1/4"

1/4"



900/C12MR Ft 114.400 1 009000962

	900	4-5-5,5-6-7-8-9-10-11-12-13-14 mm
	900/20	50 mm
	900/21	150 mm
	900/25	
	900/42	115 mm
	900BG/30	128 mm
	900/58	
	895/1	
	861TX	T8-T10-T15-T20-T25-T30-T40
	861PH	PH0-PH1-PH2-PH3
	861LP	0,5-0,8-1-1,2 mm
	861PE	3-4-5-6-8 mm

≡ 350x150x50 mm 1,3 kg

900/C12MZ

12 darab hatlapú dugókulcs,
20 darab csavarhúzóbetét és 7 tartozék
szivacsbetétes fémdobozban

1/4"

1/4"



900/C12MZ Ft 103.500 1 009000983

	900	4-5-5,5-6-7-8-9-10-11-12-13-14 mm
	900/20	50 mm
	900/21	150 mm
	900/25	
	900/42	115 mm
	900BG/30	176 mm
	900/55Z	
	895/1	
	861TX	T8-T10-T15-T20-T25-T30-T40
	861PH	PH0-PH1-PH2-PH3
	861LP	0,5x3 - 0,8x5,5 - 1x5,5 - 1,2x6,5 mm
	861PE	3-4-5-6-8 mm

≡ 350x150x50 mm - 1,2 kg

900/C13-5

13 hatlapú dugókulcs és 5 tartozék,
fémdobozban

1/4"



900/C13-5 Ft 83.650 1 009000953

	900	4 - 4,5 - 5 - 5,5 - 6 - 7 - 8 - 9 10 - 11 - 12 - 13 - 14 mm
	900/21	150 mm
	900/25	
	900BG/30	
	900/42	
	900/55	

≡ 270x120x45 mm - 1 kg

9899 900/C13-5 Ft 6.190 1 098990131
Hőformált tálcá, üres

900/C13-8

13 hatlapú dugókulcs és 8 tartozék,
fémdobozban

1/4"



900/C13-8 Ft 101.300 1 009000954

	900	4 - 4,5 - 5 - 5,5 - 6 - 7 - 8 - 9 10 - 11 - 12 - 13 - 14 mm
	900/16	□ 1/4 - ■ 3/8
	900/20	50 mm
	900/21	150 mm
	900/25	
	900BG/30	
	900/35A	
	900/42	
	900/55	

≡ 270x120x45 mm - 1,1 kg



900MB/C19

11 tizenkétszögű dugókulcs és 8 tartozék, fémdobozban

1/4"



900MB/C19 Ft 117.400 1 009000977

	900MB	5 - 5,5 - 6 - 7 - 8 - 9 - 10 - 11 12 - 13 - 14 mm
	900/16	□ 1/4 - ■ 3/8
	900/20	50 mm
	900/21	150 mm
	900/25	
	900BG/30	
	900/35A	
	900/42	
	900/55	
≡ 270x120x45 mm - 📦 1,1 kg		

900MB/C28

11 tizenkétszögű dugókulcs, 11 csavarhúzó-dugókulcs és 6 tartozék fémdobozban

1/4"



900MB/C28 Ft 146.000 1 009000979

	900MB	5 - 5,5 - 6 - 7 - 8 - 9 - 10 - 11 12 - 13 - 14 mm
	900LP	0,8x4 - 1,2x6,5 - 1,2x8 mm
	900PH	PH1 - PH2 - PH3
	900ME	3 - 4 - 5 - 6 - 8 mm
	900/20	50 mm
	900/21	150 mm
	900/25	
	900BG/30	
	900/42	
	900/55	
≡ 270x120x45 mm - 📦 1,1 kg		

900MC/C32

11 színezett dugókulcs, 20 színezett bit és 7 tartozék

1/4"



900MC/C32 Ft 108.000 1 009002963

	900MC	4 - 5 - 6 - 7 - 8 - 9 - 10 - 11 - 12 - 13 - 14 mm
	860LP	0,5x3 - 0,8x5,5 - 1,0x5,5 - 1,2x6,5 mm
	860PH	0 - 1 - 2 - 3
	860PE	3 - 4 - 5 - 6 - 8 mm
	860TX	T8 - T10 - T15 - T20 - T25 - T30 - T40
	895/1	
	900/20	
	900/21	
	900/25	
	900BG/30	
	900/42	
	900/55	
≡ 270x120x45 mm - 📦 1,2 kg		

900/C24

13 hatlapú dugókulcs, 11 csavarhúzó-dugókulcs és 6 tartozék, fémdobozban

1/4"



900/C24 Ft 129.800 1 009000956

	900	4 - 4,5 - 5 - 5,5 - 6 - 7 - 8 - 9 10 - 11 - 12 - 13 - 14 mm
	900LP	0,8x4 - 1,2x6,5 - 1,2x8 mm
	900PH	PH1 - PH2 - PH3
	900ME	3 - 4 - 5 - 6 - 8 mm
	900/20	50 mm
	900/21	150 mm
	900/25	
	900BG/30	
	900/42	
	900/55	
≡ 270x120x45 mm - 📦 1,1 kg		

900MC/C24

11 hatlapú dugókulcs, 13 színezett dugókulcs és 6 tartozék

1/4"



900MC/C24 Ft 170.600 1 009002960

	900MC	4 - 5 - 6 - 7 - 8 - 9 10 - 11 - 12 - 13 - 14 mm
	900MC/PH	PH1 - PH2 - PH3
	900MC/TX	T10 - T15 - T20 - T25 - T27 - T30 - T40
	900MC/LP	0,8x4 - 1,2x6,5 - 1,2x8 mm
	900/20	50 mm
	900/21	150 mm
	900/25	
	900BG/30	
	900/42	
	900/55	
≡ 270x120x45 mm - 📦 1,1 kg		

900U/C12M

12 multifunkciós dugókulcs, 20 csavarhúzóbetét és 7 tartozék, puha habszivacs tálcában

1/4"



900U/C12M Ft 105.300 1 009001792

	900U	○ 4-5-5,5-6-7-8-9-10-11-12-13-14 mm " 5/32-3/16-13/64-7/32-1/4-9/32-5/16 11/32-3/8-7/16-15/32-1/2-9/16 ◎ E5-E6-E7-E8-E10-E12-E14-E16-E18 ○ M5-M6-M8-M10-M12-M14-M16-M18
	900/20	50 mm
	900/21	150 mm
	900/25	
	900/42	115 mm
	900BG/30	176 mm
	900/55	
	895/1	○ 1/4 - □ 1/4
	861LP	0,5x3 - 0,8x5,5 - 1,0x5,5 - 1,2x6,5 mm
	861PE	3-4-5-6-8 mm
	861PH	PH0-PH1-PH2-PH3
	861TX	T8-T10-T15-T20-T25-T30-T40
≡ 350x150x50 mm - 📦 1,2 kg		

900AS/C10 - /MB-C17

10 hatlapú dugókulcs és 7 tartozék fémdobozban

14"



900AS/C10 Ft 94.450 1 009000961

	○ 900AS	3/16 - 7/32 - 1/4 - 9/32 - 5/16 11/32 - 3/8 - 7/16 - 1/2 - 9/16
	900/20	50 mm
	900/21	150 mm
	900/25	
	900BG/30	
	900/35A	
	900/42	
	900/55	

270x120x45 mm - 1,1 kg

900AS/MB-C17 Ft 112.300 1 009000981

	○ 900AS/MB	3/16 - 7/32 - 1/4 - 9/32 - 5/16 11/32 - 3/8 - 7/16 - 1/2 - 9/16
	900/20	50 mm
	900/21	150 mm
	900/25	
	900BG/30	
	900/35A	
	900/42	
	900/55	

270x120x45 mm - 1,1 kg

900AS/C17-MBM

10 tizenkétszögű dugókulcs és 7 tartozék repülőgép karbantartásához

14"



900AS/C17-MBM Ft 121.400 1 009000982

	○ 900AS/MB	3/16 - 7/32 - 1/4 - 9/32 - 5/16 11/32 - 3/8 - 7/16 - 1/2 - 9/16
	900/20	50 mm
	900/21	150 mm
	900/25	
	900BG/30	
	900M/35	
	900/42	
	900M/55	

270x120x45 mm - 1,2 kg

900/C11HR

11 hatlapfejű dugókulcs, 20 csavarbehajtó betét és 7 tartozék kemény hőformázott tálcában, lemezdobozban

• forgó markolatos racsni

14"

14"



900/C11HR Ft 113.300 1 009000980

	● 861LP	0,5x3-0,8x5,5-1x5,5-1,2x6,5 mm
	● 861PH	PH0-PH1-PH2-PH3
	○ 861PE	3-4-5-6-8 mm
	○ 861TX	T8-T10-T15-T20-T25-T30-T40
	895/1	
	○ 900	5-5,5-6-7-8-9-10-11-12-13-14 mm
	900/16	□ 1/4 - ■ 3/8
	900/20	50 mm
	900/21	150 mm
	900/25	
	900/42	
	900BG/30	
	900/58	

350x150x50 mm - 1,3 kg

902R/C6

6 adapter a dugókulcshoz



902R/C6 Ft 50.100 1 009020814

	900/16	□ 1/4 - ■ 3/8
	910/15	□ 3/8 - ■ 1/4
	910/16	□ 3/8 - ■ 1/2
	920/15	□ 1/2 - ■ 3/8
	920/16	□ 1/2 - ■ 3/4
	928/15	□ 3/4 - ■ 1/2

170x100x35 mm - 600 g

902A/C22

22 hatlapú dugókulcs és 6 tartozék fémdobozban

14"

12"



902A/C22 Ft 165.300 1 009020807

	○ 900	5-5,5-6-7-8-9-10-11-12-13 mm
	900/20	50 mm
	900/25	
	900/55	
	○ 920A	10-13-14-15-17-18-19 22-24-27-30-32 mm
	920/21	125 mm
	920/25	
	920/55	

420x185x60 mm - 3,5 kg

9899 902A/C22 Ft 6.190 1 098990133

Hőformált tálcá, üres

910A

Hatlapú dugókulcs

38"

38"



UNI/ISO 2725 DIN 3124

mm	Ø mm	L mm	Ø1 mm	Ft	1
6	9,5	28	16,7	2.940	5 009100006
7	10,7	28	16,7	2.940	5 009100007
8	12,1	28	16,7	2.940	5 009100008
9	13,2	28	16,7	2.940	5 009100009
10	14,6	29	16,7	2.940	5 009100010
11	15,8	29	16,7	2.940	5 009100011
12	17,2	30	17,7	3.040	5 009100012
13	18,4	31	17,0	3.040	5 009100013
14	19,7	32	17,5	3.040	5 009100014
15	20,9	32	18,0	3.040	5 009100015
16	22,2	33	18,5	3.400	5 009100016
17	23,2	33	19,0	3.400	5 009100017
18	24,7	34	20,0	3.400	5 009100018
19	25,8	35	21,0	3.400	5 009100019
20	27,2	35	22,0	3.640	5 009100020
21	28,2	36	23,0	3.640	5 009100021
22	29,7	37	24,0	3.700	5 009100022

38"

38"



910A/SB17 Ft 65.200 1 009100030

6-7-8-9-10-11-12
13-14-15-16-17
18-19-20-21-22 mm

910B

Tizenkétszögű dugókulcs



UNI/ISO 2725 DIN 3124

mm	Ø	L	Ø1	Ft	csomagolás
6	9,5	28	16,7	2.940	5 009100106
7	10,7	28	16,7	2.940	5 009100107
8	12,1	28	16,7	2.940	5 009100108
9	13,2	28	16,7	2.940	5 009100109
10	14,6	29	16,7	2.940	5 009100110
11	15,8	29	16,7	2.940	5 009100111
12	17,2	30	17,7	3.040	5 009100112
13	18,4	31	17,0	3.040	5 009100113
14	19,7	32	17,5	3.040	5 009100114
15	20,9	32	18,0	3.040	5 009100115
16	22,2	33	18,5	3.400	5 009100116
17	23,2	33	19,0	3.400	5 009100117
18	24,7	34	20,0	3.400	5 009100118
19	25,8	35	21,0	3.400	5 009100119
20	27,2	35	22,0	3.640	5 009100120
21	28,2	36	23,0	3.640	5 009100121
22	29,7	37	24,0	3.700	5 009100122



910B/SB17	Ft	csomagolás
6-7-8-9-10-11-12 13-14-15-16-17 18-19-20-21-22 mm	65.200	1 009100130

910AL

Hatlapú dugókulcs,
hosszított kivétel



UNI/ISO 2725 DIN 3124

mm	Ø	L	Ø1	Ft	csomagolás
8	12,0	55	17	6.110	3 009100158
9	13,0	55	17	6.110	3 009100159
10	14,5	55	17	6.110	3 009100160
11	16,0	55	17	6.110	3 009100161
12	17,0	55	17	6.110	3 009100162
13	18,0	55	17	6.680	3 009100163
14	20,0	55	18	6.680	3 009100164
15	21,0	55	20	6.680	3 009100165
16	22,0	55	20	6.680	3 009100166
17	23,5	55	22	6.680	3 009100167
18	24,5	55	23	7.290	2 009100168
19	25,0	55	24	7.290	2 009100169
21	27,0	65	26	7.850	2 009100171
22	29,0	65	28	7.850	2 009100172



910AL/SB14	Ft	csomagolás
8-9-10-11-12-13-14 15-16-17-18-19-21-22 mm	103.500	1 009100174

910BL

Tizenkétszögű hosszú dugókulcs



UNI/ISO 2725 DIN 3124

mm	Ø	L	Ø1	Ft	csomagolás
8	12,0	55	17	6.110	3 009100308
9	13,0	55	17	6.110	3 009100309
10	14,5	55	17	6.110	3 009100310
11	16,0	55	17	6.110	3 009100311
12	17,0	55	17	6.110	3 009100312
13	18,0	55	17	6.680	3 009100313
14	20,0	55	18	6.680	3 009100314
15	21,0	55	20	6.680	3 009100315
16	22,0	55	20	6.680	3 009100316
17	23,5	55	22	6.680	3 009100317
18	24,5	55	23	7.290	2 009100318
19	25,0	55	24	7.290	2 009100319
21	27,0	65	26	7.850	2 009100321
22	29,0	65	28	7.850	2 009100322



910BL/SB14	Ft	csomagolás
8-9-10-11-12-13 14-15-16-17-18 19-21-22 mm	103.500	1 009100340

910B/SN

Tizenkétszögű csuklós dugókulcs

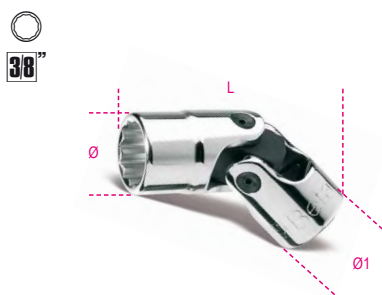

mm	Ø	L	Ø1	Ft	csomagolás
10	14,5	48,5	19	15.800	2 009100230
11	15,8	49,5	19	15.800	2 009100231
12	17,0	50,0	19	15.800	2 009100232
13	18,3	51,0	19	15.800	2 009100233
14	19,5	51,0	19	17.600	2 009100234
15	20,8	53,5	19	17.600	2 009100235
16	22,0	53,5	19	17.600	2 009100236
17	23,3	54,5	19	17.600	2 009100237
18	24,5	54,5	19	17.600	2 009100238
19	25,8	56,5	19	17.600	2 009100239

910A/AS

Hatlapú dugókulcs



"	Ø	L	Ø1	Ft	csomagolás
1/4	10,3	26	17,3	3.460	5 009100276
5/16	11,9	26	17,3	3.460	5 009100278
11/32	13,3	26	17,3	3.460	5 009100279
3/8	13,9	26	17,3	3.460	5 009100280
7/16	15,8	26	17,3	3.460	5 009100281
1/2	17,9	26	17,3	3.540	5 009100283
9/16	19,5	27	18,5	3.540	5 009100284
19/32	20,6	27	19,5	3.540	5 009100285
5/8	21,9	28	20,0	3.810	5 009100286
11/16	24,6	30	22,5	3.810	5 009100287
3/4	25,9	30	23,5	3.810	5 009100289
13/16	27,9	32	26,0	4.290	5 009100291
7/8	29,6	32	26,5	4.410	5 009100292



910A-AS/SB13	Ft	csomagolás
1/4-5/16-11/32-3/8-7/16 1/2-9/16-19/32-5/8-11/16 3/4-13/16-7/8	56.800	1 009100295

910AS

Tizenkétszögű dugókulcs



"	Ø	L	Ø1	Ft	csomagolás
1/4	9,5	28	16,7	3.460	5 009100201
5/16	12,1	28	16,7	3.460	5 009100202
11/32	13,2	28	16,7	3.460	5 009100203
3/8	14,6	29	16,7	3.460	5 009100204
7/16	15,8	29	16,7	3.460	5 009100205
1/2	18,4	31	17,0	3.540	5 009100206
9/16	19,7	32	17,5	3.540	5 009100207
19/32	20,9	32	18,0	3.540	5 009100208
5/8	22,2	33	18,5	3.810	5 009100209
11/16	24,7	34	20,0	3.810	5 009100210
3/4	25,8	35	21,0	3.810	5 009100211
13/16	28,2	36	23,0	4.290	5 009100212
7/8	29,7	37	24,0	4.410	5 009100213



910AS/SB13	Ft	csomagolás
1/4-5/16-11/32-3/8-7/16 1/2-9/16-19/32-5/8-11/16 3/4-13/16-7/8	56.800	1 009100215

910AS/L

Tizenkétszögű hosszú dugókulcs

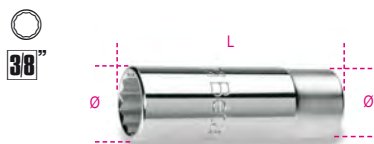

"	Ø mm	L mm	Ø1 mm	Ft	🔧	📦
1/4	10	55	17	7.690	3	009100350
5/16	12	55	17	7.690	3	009100351
3/8	14	55	17	7.690	3	009100352
7/16	16	55	17	7.690	3	009100353
1/2	18	55	17	8.540	3	009100354
9/16	20	55	18	8.540	3	009100355
19/32	21	55	20	8.790	3	009100356
5/8	22	55	20	8.790	3	009100357
11/16	23	55	22	8.790	3	009100359
3/4	25	55	24	9.350	3	009100360
13/16	27	65	26	10.950	3	009100362
7/8	29	65	28	10.950	3	009100363



"	Ft	🔧	📦
910ASL/SB12 1/4-5/16-3/8-7/16 1/2-9/16-19/32-5/8-11/16 3/4-13/16-7/8	113.700	1	009100365

910AS/SN

Tizenkétszögű csuklós dugókulcs



* SAE AS 954E

"	Ø mm	L mm	Ø1 mm	Ft	🔧	📦
* 3/8	14,0	48,0	19	17.400	2	009100260
* 7/16	15,8	51,0	19	17.400	2	009100261
* 1/2	18,3	51,0	19	17.400	2	009100262
* 9/16	19,5	51,0	19	17.600	2	009100263
* 5/8	22,0	53,5	19	17.600	2	009100264
11/16	24,5	54,5	19	18.600	2	009100265
3/4	25,8	56,5	19	18.600	2	009100266

910FTX

Dugókulcs Torx®-csavarokhoz



"	Ø mm	L mm	Ø1 mm	Ft	🔧	📦
E4	6,2	26	17,3	4.090	5	009100404
E5	7,0	26	17,3	4.090	5	009100405
E6	8,3	26	17,3	4.090	5	009100406
E7	8,9	26	17,3	4.090	5	009100407
E8	9,9	26	17,3	4.090	5	009100408
E10	12,0	26	17,3	4.090	5	009100410
E11	13,3	26	17,3	4.090	5	009100411

"	Ø mm	L mm	Ø1 mm	Ft	🔧	📦
E12	14,5	26	17,3	4.090	5	009100412
E14	15,8	26	17,3	4.090	5	009100414
E16	18,0	26	17,3	4.090	5	009100416
E18	19,5	26	18,5	4.490	3	009100418
E20	21,9	26	20,0	4.490	3	009100420



"	Ft	🔧	📦
910FTX/SB9 E4-E5-E6-E7-E8 E10-E12-14-E16	43.200	1	009100430

910FTX/L

Hosszú dugókulcs Torx®-csavarokhoz



"	Ø mm	L mm	Ø1 mm	Ft	🔧	📦
E4	6,2	55	17,3	9.230	3	009100440
E5	7,0	55	17,3	9.230	3	009100441
E6	8,3	55	17,3	9.230	3	009100442
E7	8,9	55	17,3	9.230	3	009100443
E8	9,9	55	17,3	9.230	3	009100444
E10	12,0	55	17,3	9.230	3	009100445



"	Ft	🔧	📦
910FTX-L/SB6 E4-E5-E6 E7-E8-E10	60.250	1	009100449

910FTX/XL

extra hosszú hatszögű dugókulcs Torx®-csavarokhoz



"	Ø mm	L mm	Ø1 mm	Ft	🔧	📦
E6	8,0	200	18	8.300	2	009100766
E7	8,0	200	18	8.300	2	009100767
E8	10,0	200	18	8.300	2	009100768
E10	14,0	200	18	8.300	2	009100770
E11	14,0	200	18	8.300	2	009100771
E12	14,0	200	18	8.300	2	009100772
E14	17,0	200	18	9.030	2	009100774
E16	18,6	200	18	9.030	2	009100776
E18	21,5	200	18	9.550	2	009100778
E20	21,5	200	18	9.550	2	009100780

910FTX-XL/C10

10 részes hosszú dugókulcs szerszám készlet Torx®-csavarokhoz műanyag dobozban



"	Ft	🔧	📦
910FTX/XL-C10 E6-E7-E8-E10-E11- E12-E14-E16-E18-E20	86.950	1	009100976

255x195x62 mm - 2,3 kg

910LP

Csavarhúzó-dugókulcs hasítottfejű csavarokhoz, krómozott, barnított fej



SxA mm	Ø mm	L mm	L1 mm	Ft	🔧	📦
1x5,5	18,5	54	24	7.210	2	009100452
1,2x6,5	18,5	54	24	7.210	2	009100453
1,2x8	18,5	54	24	7.210	2	009100454
1,6x9	18,5	54	24	7.210	2	009100456

910PH

Csavarhúzó-dugókulcs Phillips®-csavarokhoz, krómozott, barnított fej

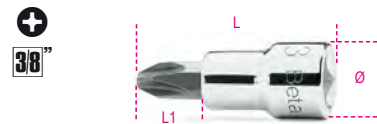

PH	Ø mm	L mm	L1 mm	Ft	🔧	📦
1	18,5	48	18	6.720	2	009100471
2	18,5	48	18	6.720	2	009100472
3	18,5	48	18	6.720	2	009100473
4	18,5	48	18	6.720	2	009100474



"	Ft	🔧	📦
910PH/SB4 PH1-PH2-PH3-PH4	30.700	1	009100478



910PE

3/8"-os imbusz-dugókulcs, krómozott, fekete hegygel



DIN 7422

mm	Ø mm	L mm	L1 mm	Ft	csomagolás
3	18,5	50	20	5.870	5 009100490
4	18,5	50	20	5.870	5 009100492
5	18,5	50	20	5.870	5 009100494
6	18,5	50	20	5.870	5 009100496
7	18,5	50	20	5.870	5 009100497
8	18,5	50	20	5.870	5 009100498
9	18,5	50	20	5.870	5 009100499
10	18,5	50	20	5.870	5 009100500



910PE/SB7
3-4-5-6-7-8-10 mm
Ft 46.450 1 009100503

910BP

hatlapfejű külső dugókulcs gömbölyű véggel



mm	L mm	I1 mm	Ft	csomagolás
4L	92	62	7.000	3 009100584
5L	92	62	7.000	3 009100585
6L	92	62	7.000	3 009100586
7L	92	62	7.000	3 009100587
8L	92	62	7.000	3 009100588
10L	132	102	7.570	3 009100590



910BP/SB6L
4L-5L-6L-7L-8L-10L mm
Ft 47.450 1 009100596

910ME

3/8"-os imbusz-dugókulcs, krómozott



mm	Ø mm	L mm	L1 mm	Ft	csomagolás
4	18	62	15	7.040	5 009100504
5	18	62	15	7.040	5 009100505
6	18	62	15	7.040	5 009100506
7	18	62	15	7.170	5 009100507
8	19	62	15	7.170	5 009100508
10	20	62	15	7.170	5 009100510
12	20	62	15	7.170	5 009100512

3/8"



910ME/SB5
4-5-6-8-10 mm
Ft 39.800 1 009100515

910PE/AS

imbusz dugókulcs



"	Ø mm	L mm	L1 mm	Ft	csomagolás
1/8	18,5	50	20	10.100	2 009100531
5/32	18,5	50	20	10.100	2 009100532
3/16	18,5	50	20	10.100	2 009100533
7/32	18,5	50	20	10.100	2 009100534
1/4	18,5	50	20	10.100	2 009100535
5/16	18,5	50	20	10.100	2 009100536
3/8	18,5	50	20	11.150	2 009100537

910PT

Ótlapú imbusz dugókulcs



"	Ø mm	L mm	L1 mm	Ft	csomagolás
PT40	20	50	20	9.350	3 009100540
PT45	20	50	20	9.550	3 009100545
PT50	20	50	20	11.350	3 009100550

1/4"



910PT/SB8
PT10-PT15-PT20-PT25
PT30-PT40-PT45-PT50
Ft 77.000 1 009100558

910TX

3/8"-os Torx® imbusz-dugókulcs, krómozott, fekete hegy



"	Ø mm	L mm	L1 mm	Ft	csomagolás
T15	18,5	50	20	7.690	5 009100519
T20	18,5	50	20	7.690	5 009100520
T25	18,5	50	20	7.690	5 009100521
T27	18,5	50	20	7.690	5 009100522
T30	18,5	50	20	7.690	5 009100523
T40	18,5	50	20	7.690	5 009100524
T45	18,5	50	20	7.690	3 009100525
T50	18,5	50	20	7.690	3 009100526

3/8"



910TX/SB6
T15-T20-T25
T27-T30-T40
Ft 51.000 1 009100530

910XZN

dugókulcs XZN® profilú



"	L mm	Ft	csomagolás
M4	50	8.300	3 009100559
M5	50	8.300	3 009100560
M6	50	8.300	3 009100561
M8	50	8.300	3 009100563
M10	50	8.790	3 009100565

910CF

3/8"-os villás dugókulcs



mm	A mm	L mm	Ft	csomagolás
10	21,3	32,3	4.980	2 009100135
11	23,1	34,3	4.980	2 009100136
12	25,5	36,2	5.630	2 009100137
13	26,9	37,4	5.630	2 009100138
14	30,2	40,0	5.950	2 009100139
15	33,3	41,3	6.230	2 009100140
16	33,3	41,3	6.760	2 009100141
17	38,1	46,5	7.850	2 009100142
18	38,1	46,5	7.850	2 009100143
19	39,6	48,0	8.540	2 009100144

3/8"



910CF/SB10
10-11-12-13-14-15
16-17-18-19 mm
Ft 71.600 1 009100147

910/15

Szűkítő közbetét 3/8" és 1/4"



UNI/ISO 3316 DIN 3123

L mm	Ø mm	Ft	csomagolás
30	17,0	4.330	5 009100810



Ügyeljünk a forgató nyomatékra, fokozatosan növeljük, hogy a törést, illetve az esetleges sérülést elkerüljük.

910/16

Bővítő közbetét 3/8" és 1/2"



UNI/ISO 3316 DIN 3123

L mm	Ø mm	3/8"	1/2"	Ft	3	009100814
32	18,0			4.490	5	009100814

910/20 - 910/21 - 910/22

3/8"-os toldó

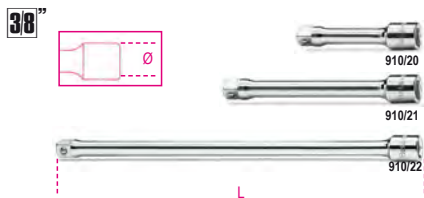

UNI/ISO 3316 DIN 3123

	L mm	Ø mm	Ft	3	009100820
910/20	75	17	3.700	5	009100820
910/21	125	17	5.340	5	009100822
910/22	250	17	7.040	5	009100826

910AN

3/8"-os gömbvégű toldó

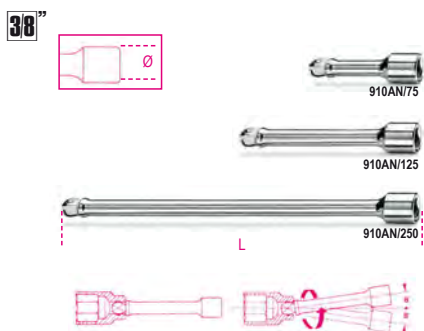

	L mm	Ø mm	Ft	3	009100827
910AN/75	75	17	5.260	3	009100827
910AN/125	125	17	6.560	3	009100828
910AN/250	250	17	9.800	3	009100829

910/25

3/8"-os csukló



UNI/ISO 3316 DIN 3123

L mm	Ø mm	Ft	3	009100830
54,6	19	9.680	5	009100830

910M/35

3/8"-os csuklós fém hajtószár



UNI/ISO 3315 DIN 3122

L mm	Ft	3	009100839
250	26.700	3	009100839

910/36A

3/8"-os csuklós hajtószár, krómzott



UNI/ISO 3315 DIN 3122

L mm	L1 mm	Ft	3	009100845
255	154	18.600	3	009100845

910/40

3/8"-os csuklós T-hajtószár, krómzott



L mm	L1 mm	Ft	3	009100850
420	175	20.050	3	009100850

910/42

3/8"-os csúszkás T-hajtószár

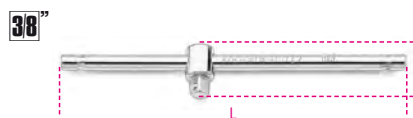

UNI/ISO 3315 DIN 3122

L mm	A mm	Ft	5	009100854
210	30,5	6.360	5	009100854

910/46

3/8"-os forgattyús hajtószár, krómzott

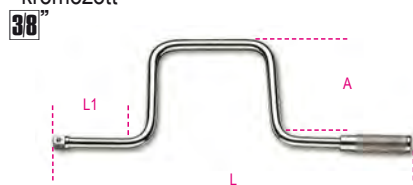

UNI/ISO 3315 DIN 3122

L mm	L1 mm	A mm	Ft	1	009100862
315	80	115	12.550	1	009100862

910/55

3/8" irányváltós racsní, 72 fogas mechanizmus



UNI/ISO 3315 DIN 3122

L mm	Ø mm	A mm	Ft	3	009101155
207	31	33	23.050	3	009101155

Tartalék forgó alkatrészek

111

910M/55

3/8"-os irányváltós fémracsní



DIN 3122 - UNI ISO 3315

L mm	Ø mm	A mm	Ft	2	009100875
178	30	26	31.150	2	009100875

910M/56

3/8"-os irányváltós csuklós fémracsní



L mm	Ø mm	A mm	Ft	2	009100887
265	31	29	42.500	2	009100887



910/58

Írányváltós racsni
3/8"
52 fogú

- Hajtószár
- Nyitó és rögzítő gomb
- Írányváltás a fejen lévő műanyag gyűrű jobbra és balra forgatásával
- Bimateriál-nyél

38"



L mm	Ø mm	A mm	Ft	1	009100884
222	37	38,5	35.000		

910.../C10

10 dugókulcs és 2 tartozék fémdobozban

38"



910A/C10	Ft	1	009100909
	74.400		

910A	6 - 7 - 8 - 10 - 11 - 12 13 - 14 - 17 - 19 mm
910/21	125 mm
910/55	

270x120x45 mm - 1,3 kg

910B/C10	Ft	1	009100910
	74.400		

910B	6 - 7 - 8 - 10 - 11 - 12 13 - 14 - 17 - 19 mm
910/21	125 mm
910/55	

270x120x45 mm - 1,3 kg



910A/C16...

16 dugókulcs és 5 tartozék fémdobozban

38"



910A/C16	Ft	1	009100936
	120.000		

910A	6 - 7 - 8 - 9 - 10 - 11 - 12 - 13 14 - 15 - 16 - 17 - 18 - 19 21 - 22 mm
910/21	125 mm
910/22	250 mm
910/25	
910/42	
910/55	

335x145x60 mm - 2,3 kg

9899 910C16	Ft	1	098990134
Hőformált tálcá, üres	6.190		

910B/C16...

16 dugókulcs és 5 tartozék fémdobozban

38"



910B/C16	Ft	1	009100937
	120.000		

910B	6 - 7 - 8 - 9 - 10 - 11 - 12 - 13 14 - 15 - 16 - 17 - 18 - 19 21 - 22 mm
910/21	125 mm
910/22	250 mm
910/25	
910/42	
910/55	

335x145x60 mm - 2,3 kg

9899 910C16	Ft	1	098990134
Hőformált tálcá, üres	6.190		

910A/C17

17 hatlapú dugókulcs
és 9 tartozék fémdobozban

38"



910A/C17	Ft	1	009100938
	179.100		

910A	6 - 7 - 8 - 9 - 10 - 11 - 12 - 13 14 - 15 - 16 - 17 - 18 - 19 - 20 21 - 22 mm
910/15	□ 3/8 - ■ 1/4
910/16	□ 3/8 - ■ 1/2
910/21	125 mm
910/22	250 mm
910/25	
910/36A	
910/42	
910/46	
910/55	

420x280x60 mm - 4,0 kg

910.../C29

17 dugókulcs 12 csavarhúzó-dugókulcs és 5
tartozék fémdobozban

38"



910A/C29	Ft	1	009100944
	204.700		

910A	6 - 7 - 8 - 9 - 10 - 11 - 12 - 13 14 - 15 - 16 - 17 - 18 - 19 - 20 21 - 22 mm
910LP	1x5,5 - 1,2x6,5 - 1,2x8 mm
910PH	PH1 - PH2 - PH3
910PE	3 - 4 - 5 - 6 - 8 - 10 mm
910/21	125 mm
910/22	250 mm
910/25	
910/42	
910/55	

420x185x60 mm - 3,5 kg

910B/C29	Ft	1	009100945
	204.700		

910B	6 - 7 - 8 - 9 - 10 - 11 - 12 - 13 14 - 15 - 16 - 17 - 18 - 19 - 20 21 - 22 mm
910LP	1x5,5 - 1,2x6,5 - 1,2x8 mm
910PH	PH1 - PH2 - PH3
910PE	3 - 4 - 5 - 6 - 8 - 10 mm
910/21	125 mm
910/22	250 mm
910/25	
910/42	
910/55	

420x185x60 mm - 3,5 kg



910AS/C13...

13 dugókulcs és 5 tartozék fémdobozban

38"



910AS/C13 Ft 120.700 1 009100925

910AS	1/4 - 5/16 - 11/32 - 3/8 - 7/16 1/2 - 9/16 - 19/32 - 5/8 - 11/16 3/4 - 13/16 - 7/8
910/21	125 mm
910/22	250 mm
910/42	
910/25	
910/55	
335x145x60 mm - 2,3 kg	

910AS/MBM-C18

13 db-os inch-es dugókulcs készlet
5 tartozékkal, fémdobozban

38"



910AS/MBM-C18 Ft 125.500 1 009100926

910AS	1/4 - 5/16 - 11/32 - 3/8 - 7/16 1/2 - 9/16 - 19/32 - 5/8 - 11/16 3/4 - 13/16 - 7/8
910/21	125 mm
910/22	250 mm
910/25	
910/42	
910M/55	
335x145x60 mm - 2,5 kg	



910A/C16HR

16 hatlapú dugókulcs és 5 tartozék
szivacsbetétes fémdobozban

38"



910A/C16HR Ft 132.000 1 009100935

• forgó markolatot racsni

910A	6 - 7 - 8 - 9 - 10 - 11 - 12 - 13 14 - 15 - 16 - 17 - 18 - 19 21 - 22 mm
910/21	125 mm
910/22	250 mm
910/25	
910/42	210 mm
910/58	
335x145x60 mm - 2,4 kg	

920A

Hatlapú dugókulcs

12"



UNI/ISO 2725 DIN 3124

Ø	Ø	L	Ø1	Ft	1	009200008
mm	mm	mm	mm			
8	12,4	38	21,7	2.960	10	009200008
9	13,5	38	21,7	2.960	10	009200009
10	14,9	38	21,7	2.960	10	009200010
11	16,1	38	21,7	2.960	10	009200011
12	17,5	38	21,7	2.960	10	009200012
13	18,7	38	21,7	3.080	10	009200013
14	20,1	38	21,7	3.080	10	009200014
15	21,5	38	22,5	3.080	10	009200015
16	22,7	38	23,7	3.460	10	009200016
17	24,1	38	23,1	3.460	10	009200017
18	25,3	39	24,0	3.460	10	009200018
19	26,6	39	24,0	3.460	10	009200019
20	27,8	40	25,0	3.770	5	009200020
21	28,8	40	25,0	3.770	5	009200021
22	29,9	41	26,0	3.770	5	009200022
23	30,8	42	26,0	4.410	5	009200023
24	32,2	43	27,0	4.410	5	009200024
25	33,2	44	27,0	4.410	5	009200025
26	34,7	45	28,0	4.530	5	009200026
27	36,2	46	29,0	4.530	5	009200027
28	37,2	47	30,0	4.530	5	009200028
29	38,6	48	31,0	4.780	5	009200029
30	40,2	48	32,0	4.780	5	009200030
32	42,3	49	34,0	4.980	5	009200032

12"



920A/SB13 Ft 52.000 1 009200040
10-11-12-13-14-15-16
17-18-19-20-21-22 mm

12"



920A/SB8 Ft 42.650 1 009200042
23-24-25-26-27-28-30-32 mm

920MC

hatszögű dugókulcs,
színezett

12"



Ø	Ø	L	Ø1	Ft	5	009202008
mm	mm	mm	mm			
8	13,2	38	22	3.260	5	009202008
10	15,3	38	22	3.260	5	009202010
11	16,5	38	22	3.260	5	009202011
12	17,8	38	22	3.260	5	009202012
13	19,0	38	22	3.360	5	009202013
14	20,3	38	22	3.360	5	009202014
15	21,6	38	22	3.360	5	009202015
16	23,0	38	23	3.770	5	009202016
17	23,9	38	24	3.770	5	009202017
18	25,0	38	25	3.770	5	009202018
19	26,5	38	24	3.770	5	009202019
21	28,8	38	27	4.130	3	009202021
22	29,9	40	28	4.130	3	009202022
24	32,8	40	30	4.820	3	009202024

920B

1/2"-os tizenkétszögű dugókulcs

12"



UNI/ISO 2725 DIN 3124

Ø	Ø	L	Ø1	Ft	10	009200108
mm	mm	mm	mm			
8	12,4	38	21,7	2.960	10	009200108
9	13,5	38	21,7	2.960	10	009200109
10	14,9	38	21,7	2.960	10	009200110
11	16,1	38	21,7	2.960	10	009200111
12	17,5	38	21,7	2.960	10	009200112
13	18,7	38	21,7	3.080	10	009200113
14	20,1	38	21,7	3.080	10	009200114
15	21,5	38	22,5	3.080	10	009200115
16	22,7	38	23,7	3.460	10	009200116
17	24,1	38	23,1	3.460	10	009200117
18	25,3	39	24,0	3.460	10	009200118
19	26,6	39	24,0	3.460	10	009200119
20	27,8	40	25,0	3.770	5	009200120
21	28,8	40	25,0	3.770	5	009200121
22	29,9	41	26,0	3.770	5	009200122
23	30,8	42	26,0	4.410	5	009200123
24	32,2	43	27,0	4.410	5	009200124
25	33,2	44	27,0	4.410	5	009200125
26	34,7	45	28,0	4.530	5	009200126
27	36,2	46	29,0	4.530	5	009200127
28	37,2	47	30,0	4.530	5	009200128
29	38,6	48	31,0	4.780	5	009200129
30	40,2	48	32,0	4.780	5	009200130
32	42,3	49	33,9	4.980	5	009200132

12"



920B/SB13 Ft 52.000 1 009200140
10-11-12-13-14-15-16
17-18-19-20-21-22 mm

12"



920B/SB8
23-24-25-26-27
28-30-32 mm
Ft 42.650 1 009200142

920AL

Hatlapú dugókulcs,
hosszított kivitel

12"



UNI/ISO 2725 DIN 3124

mm	Ø mm	L mm	Ø1 mm	Ft	1
10	14,7	77	21	7.890	5 009200626
12	17,8	77	21	7.890	5 009200627
13	19,0	77	22	7.890	5 009200628
14	20,3	77	22	7.890	5 009200629
15	21,5	77	22	7.890	5 009200630
16	22,8	77	22	8.460	5 009200631
17	24,0	77	23	8.460	5 009200632
18	25,0	77	24	8.910	5 009200633
19	26,5	77	25	8.910	5 009200634
21	29,0	77	27	9.880	5 009200635
22	30,0	77	28	9.880	5 009200636
23	31,5	77	29	9.880	5 009200637
24	32,8	77	30	11.350	5 009200638
27	36,5	77	33	11.750	3 009200639
30	40,0	77	36	14.150	3 009200640
32	42,8	77	38	14.550	3 009200641
36	48,0	77	41	23.500	3 009200642

12"



920AL/SB11
10-12-13-14-15-16
17-18-19-21-22 mm
Ft 101.700 1 009200644

920BL

Tizenkétszögű hosszú dugókulcs

12"



UNI/ISO 2725 DIN 3124

mm	Ø mm	L mm	Ø1 mm	Ft	1
10	14,7	77	21	7.890	5 009200310
12	17,8	77	21	7.890	5 009200312
13	19,0	77	22	7.890	5 009200313
14	20,3	77	22	7.890	5 009200314
15	21,5	77	22	7.890	5 009200315
16	22,8	77	22	8.460	5 009200316
17	24,0	77	23	8.460	5 009200317
18	25,0	77	24	8.910	5 009200318
19	26,5	77	25	8.910	5 009200319
21	29,0	77	27	9.880	5 009200321
22	30,0	77	28	9.880	5 009200322
23	31,5	77	29	9.880	5 009200323
24	32,8	77	30	11.350	5 009200324
27	36,5	77	33	11.750	3 009200327
30	40,0	77	36	14.150	3 009200330
32	42,8	77	38	14.550	3 009200332
36	48,0	77	41	23.500	3 009200336

12"



920BL/SB11
10-12-13-14-15-16-17-18
19-21-22 mm
Ft 101.700 1 009200338

920A/AS

Hatlapú dugókulcs

12"



mm	Ø mm	L mm	Ø1 mm	Ft	1
3/8	14,6	37	21	3.480	2 009200270
7/16	16,5	37	21	3.480	3 009200272
1/2	19,0	37	22	3.600	3 009200273
9/16	20,3	37	22	3.600	3 009200274
19/32	21,0	37	22	3.850	3 009200275
5/8	22,8	37	22	3.850	3 009200276
11/16	25,0	37	24	3.990	3 009200277
3/4	26,5	38	25	3.990	3 009200279
25/32	28,0	38	26	4.490	3 009200280
13/16	29,0	38	27	4.490	3 009200281
7/8	30,0	40	28	4.490	3 009200282
15/16	32,8	42	30	4.780	3 009200284
1	35,0	42	32	4.780	3 009200285
1.1/16	36,5	43	33	5.260	2 009200287
1.1/8	39,0	43	35	5.380	2 009200289
1.3/16	41,0	46	36	5.790	2 009200290
1.1/4	42,8	46	38	5.870	2 009200292

12"



920A-AS/SB11
3/8-7/16-1/2-9/16-5/8
11/16-3/4-13/16-7/8
15/16-1
Ft 52.250 1 009200295

920AS

Tizenkétszögű dugókulcs

12"



mm	Ø mm	L mm	Ø1 mm	Ft	1
3/8	14,9	38	21,7	3.480	3 009200201
7/16	16,1	38	21,7	3.480	3 009200202
1/2	18,7	38	21,7	3.600	3 009200203
9/16	20,1	38	21,7	3.600	3 009200204
5/8	22,7	38	22,5	3.850	3 009200206
19/32	21,5	38	23,7	3.850	3 009200207
11/16	25,3	39	24,0	3.990	3 009200208
3/4	26,6	39	24,0	3.990	3 009200209
25/32	27,8	40	25,0	4.490	3 009200210
13/16	28,8	40	25,0	4.490	3 009200211
7/8	29,9	41	26,0	4.490	3 009200212
15/16	32,2	43	27,0	4.780	3 009200214
1	34,2	45	28,0	4.780	3 009200216
1.1/16	36,2	46	29,0	5.260	2 009200217
1.1/8	38,6	48	31,0	5.380	2 009200218
1.3/16	40,2	48	32,0	5.790	2 009200219
1.1/4	42,3	49	33,5	5.870	2 009200220

12"



920AS/SB11
3/8-7/16-1/2-9/16-5/8
11/16-3/4-13/16-7/8
15/16-1
Ft 52.250 1 009200225

920AS/L

Tizenkétszögű hosszú dugókulcs

12"



mm	Ø mm	L mm	Ø1 mm	Ft	1
1/2	19,0	77	22	10.950	2 009200352
9/16	20,3	77	22	10.950	2 009200353
5/8	22,8	77	22	10.950	2 009200355
11/16	25,0	77	24	11.550	2 009200357
3/4	26,5	77	25	11.750	2 009200358
13/16	29,0	77	27	13.950	2 009200360
7/8	30,0	77	28	13.950	2 009200361
15/16	32,8	77	30	14.550	2 009200362
1	35,0	77	32	14.950	2 009200363
1.1/16	36,5	77	33,0	16.200	2 009200364
1.1/8	37,8	77	34	16.800	2 009200365

12"



920ASL/SB11
1/2-9/16-5/8-11/16
3/4-13/16-7/8-15/16
1-1.1/8-1.1/16
Ft 154.300 1 009200369

920U

multifunkciós dugókulcsok

12"



mm	"	E	M	L mm	Ft	1
10	3/8	E12	M12	38	3.120	5 009201710
11	7/16	E14	M14	38	3.120	5 009201711
12	15/32	E16		38	3.120	5 009201712
13	1/2		M16	38	3.260	5 009201713
14	9/16	E18	M18	38	3.260	5 009201714
15	19/32			38	3.260	5 009201715
16	5/8	E20		38	3.620	5 009201716
17				38	3.620	5 009201717
18		E22		38	3.620	5 009201718
19	3/4	E24		38	3.620	5 009201719
20	25/32			38	3.990	3 009201720
21				38	3.990	3 009201721
22	7/8			38	3.990	3 009201722
24	15/16			38	4.620	3 009201724
27	1.1/16			42	4.780	3 009201727
30	1.1/8			44	5.060	3 009201730
32	1.1/4			44	5.300	3 009201732

12"



920U/SB13
10-11-12-13-14-15-16
17-18-19-20-21-22 mm
Ft 54.350 1 009201740

12"



920U/SB4
24-27-30-32 mm

Ft
23.550

1 009201744

12"



920FTX-LSB6
E10-E12-E14
E16-E18-E20

Ft
65.100

1 009200409

920FTX

Dugókulcs Torx®-csavarokhoz

12"



	Ø mm	L mm	Ø1 mm	Ft		
E10	13,2	36	21	4.780	5	009200380
E12	15,0	37	21	4.780	5	009200381
E14	16,3	37	21	4.780	5	009200382
E16	18,8	37	22	4.780	5	009200383
E18	20,4	37	22	4.780	5	009200384
E20	22,9	37	22	5.220	5	009200385
E22	25,0	37	24	6.030	3	009200387
E24	26,5	40	25	6.800	3	009200388

12"



920FTX/SB6
E10-E12-E14
E16-E18-E20

Ft
33.950

1 009200390

12"



920FTX/C8
E10-E12-E14-E16
E18-E20-E22-E24

Ft
57.300

1 009200391

270X120X45 mm - 1 kg

920FTX/L

Hosszú dugókulcs Torx®-csavarokhoz

12"



	Ø mm	L mm	Ø1 mm	Ft		
E10	13,2	77	21,0	10.050	5	009200400
E12	15,0	77	21,0	10.050	5	009200401
E14	16,3	77	21,0	10.050	5	009200402
E16	18,8	77	21,8	10.050	3	009200403
E18	20,4	77	21,8	10.050	3	009200404
E20	22,9	77	22,0	10.050	3	009200405

12"

920LP

Csavarhúzó-dugókulcs hasítottfejű csavarokhoz, krómozott, barnított fej

12"



SxA mm	Ø mm	L mm	L1 mm	Ft		
1x5,5	22,5	62	24	7.810	3	009200452
1,2x6,5	22,5	62	24	7.810	3	009200453
1,2x8	22,5	62	24	7.810	3	009200454
1,6x9	22,5	62	24	7.810	3	009200456
2x12	22,5	62	24	7.810	3	009200458

920PH

Csavarhúzó-dugókulcs Phillips®-csavarokhoz, krómozott, barnított fej

12"



PH	Ø mm	L mm	L1 mm	Ft		
1	22,5	56	18	6.840	3	009200471
2	22,5	56	18	6.840	3	009200472
3	22,5	56	18	6.840	3	009200473
4	22,5	56	18	6.840	3	009200474

12"



920PH/SB4
PH1-PH2-PH3-PH4

Ft
31.200

1 009200479

920LH/SB7

Csavarhúzó-dugókulcs készlet Phillips(R)-csavarokhoz krómozott, barnított fej

12"



		Ft		
920LH/SB7		57.150	1	009200478
920LP	1,2x6,5 - 1,2x8 1,6x9 - 2x12 mm			
920PH	PH2 - PH3 - PH4			

920PE

1/2"-os imbusz-dugókulcs, krómozott, barnított hegy

12"

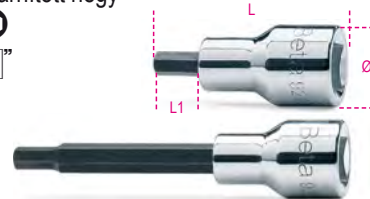

DIN 7422

mm	Ø mm	L mm	L1 mm	Ft		
3	22,5	58	20	6.230	5	009200410
4	22,5	58	20	6.230	5	009200412
5	22,5	58	20	6.230	5	009200414
5L	22,5	100	62	6.800	5	009200415
6	22,5	58	20	6.230	5	009200417
6L	22,5	100	62	6.800	5	009200418
7	22,5	58	20	6.230	5	009200420
7L	22,5	100	62	6.800	5	009200421
8	22,5	58	20	6.230	5	009200423
8L	22,5	100	62	6.800	5	009200424
9	22,5	58	20	6.230	5	009200425
9L	22,5	140	102	7.170	5	009200426
10	22,5	58	20	6.230	5	009200428
10L	22,5	140	102	7.170	5	009200429
12	23,0	58	20	7.250	5	009200432
12L	22,5	140	102	8.300	5	009200433
14	23,0	58	20	7.250	5	009200434
14L	22,5	140	102	8.300	5	009200435
17	29,5	60	22	8.870	5	009200437
19	29,5	60	22	8.870	5	009200439

12"

Ft
65.150

1 009200441

920PE/SB9
4-5-6-8-10 mm
5L-6L-8L-10L mm

12"

Ft
85.000

1 009200443

920PE/C10
4-5-6-7-8-10
12-14-17-19 mm

270X120X45 mm - 1,5 kg

9899 920PE/C10
Hőformált tálcá, üres
Ft 6.190 1 098990135



920PE/AS

Hatlapú imbusz-dugókulcs



"	Ø mm	L mm	L1 mm	Ft	📦	📄
1/8	22,5	58	20	7.290	2	009200460
3/16	22,5	58	20	7.290	2	009200461
1/4	22,5	58	20	7.290	2	009200463
3/8	22,5	58	20	7.290	2	009200464
1/2	22,5	60	20	7.980	2	009200465
3/4	22,5	60	20	8.540	1	009200468



920PE-AS/SB6
1/8-3/16-1/4-3/8-1/2-3/4
Ft 50.500 1 009200469

920BP

Hatlapú gömbfejű imbusz-dugókulcs

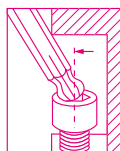
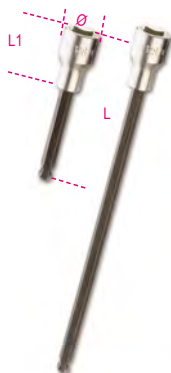

mm	Ø mm	L mm	L1 mm	Ft	📦	📄
5L	22,5	100	62	7.850	5	009200490
5XL	22,5	240	202	10.100	1	009200495
6L	22,5	100	62	7.850	5	009200491
6XL	22,5	240	202	10.100	1	009200496
7L	22,5	100	62	7.850	5	009200492
8L	22,5	100	62	7.850	5	009200493
8XL	22,5	240	202	10.100	1	009200497
10L	22,5	140	102	8.540	5	009200494



920BP/SB8
5L-6L-7L-8L-10L mm
5XL-6XL-8XL mm
Ft 76.250 1 009200500

920ME

1/2"-os imbusz-dugókulcs, krómozott



mm	Ø mm	L mm	L1 mm	Ft	📦	📄
5	21	75	15,5	7.290	5	009200505
6	21	75	15,5	7.290	5	009200506
7	21	75	15,5	7.290	5	009200507
8	21	75	15,5	7.290	5	009200508
10	23	75	15,5	7.610	5	009200510
12	24	75	15,5	8.790	5	009200512
14	24	75	15,5	9.030	5	009200514
17	24	75	15,5	9.030	5	009200517



920ME/SB7
5-6-8-10-12-14-17 mm
Ft 61.700 1 009200519



920ME/C7
5-6-8-10-12-14-17 mm
Ft 69.650 1 009200518
250X100X35 mm - 1,4 kg

920TX

1/2"-os Torx® imbusz-dugókulcs, krómozott, barnított hegy



mm	Ø mm	L mm	L1 mm	Ft	📦	📄
T20	22,5	58	20	7.610	5	009200520
T20L	22,5	120	82	9.760	3	009200530
T25	22,5	58	20	7.610	5	009200521
T25L	22,5	120	82	9.760	3	009200531
T27	22,5	58	20	7.610	5	009200522
T27L	22,5	120	82	9.760	3	009200533
T30	22,5	58	20	7.610	5	009200523
T30L	22,5	120	82	9.760	3	009200534
T40	22,5	58	20	7.610	5	009200524
T40L	22,5	120	82	9.760	3	009200535
T45	22,5	58	20	7.610	5	009200525
T45L	22,5	120	82	9.760	3	009200537
T50	22,5	58	20	7.610	5	009200526
T50L	23,0	140	102	9.760	3	009200538
T55	23,0	58	20	10.100	3	009200527
T55L	23,0	140	102	13.750	3	009200539
T60	23,0	58	20	10.100	3	009200528
T60L	23,0	140	102	13.750	3	009200540
T70L	23,0	120	82	13.750	3	009200541



920TX/SB9
T20-T25-T27-T30-
T40-T45-T50-T55-T60
Ft 79.900 1 009200532



920TX-L/SB10
T20L-T25L-T27L-T30L-T40L-
T45L-T50L-T55L-T60L-T70L
Ft 116.800 1 009200545



920TX/C9
T20-T25-T27-T30-T40
T45-T50-T55-T60
Ft 88.900 1 009200546

270X120X45 mm - 1,2 kg

9899 920TX/C9
Hőformált tálcá, üres
Ft 6.190 1 098990136

920RTX

Tamper Resistant Torx® imbusz-dugókulcs



mm	Ø mm	L mm	L1 mm	Ft	📦	📄
T20	22,5	58	20	8.140	5	009200370
T25	22,5	58	20	8.140	5	009200371
T27	22,5	58	20	8.140	5	009200372
T30	22,5	58	20	8.140	5	009200373
T40	22,5	58	20	8.140	5	009200374



920RTX/SB5
T20-T25-T27-T30-T40
Ft 45.000 1 009200378



920XZN

1/2"-os XZN®-profilú
imbusz-dugókulcs, krómozott,
barnított fej

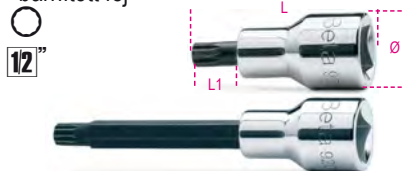

DIN 2324

Ø	Ø mm	L mm	L1 mm	Ft	🔧	📄
M4	22,5	58	20	8.180	3	009200559
M5	22,5	58	20	8.180	3	009200560
M6	22,5	58	20	8.180	3	009200561
M6L	22,5	100	62	9.350	3	009200562
M8	22,5	58	20	8.180	3	009200563
M8L	22,5	100	62	9.350	3	009200564
M9	22,5	58	20	8.180	3	009200582
M9L	22,5	100	62	9.350	3	009200583
M10	22,5	58	20	8.300	3	009200565
M10L	22,5	100	62	9.350	3	009200566
M12	22,5	58	20	8.540	3	009200568
M12L	22,5	100	62	9.550	3	009200569
M14	23,0	58	20	8.540	3	009200571
M14L	23,0	100	62	9.550	3	009200572
M16	23,0	58	20	10.700	3	009200573
M18	23,0	58	20	10.950	3	009200574



920XZN/SB7	Ft	🔧	📄
M4-M5-M6-M8 M10-M12-M14	63.450	1	009200579



920XZN/SB12	Ft	🔧	📄
M5-M6-M8-M10-M12 M14-M16-M6L-M8L M10L-M12L-M14L	116.100	1	009200577



920XZN-L/S5	Ft	🔧	📄
M6L-M8L-M10L M12L-M14L	47.150	1	009200578

920ES

1/2"-os speciális imbusz-dugókulcs,
krómozott, fekete hegy



UNI 9326

Ø mm	🔧	L mm	L1 mm	Ft	🔧	📄
7	(6R)	58	20	11.350	5	009200587
7XL	(6R)	240	202	16.000	1	009200607
9	(8R)	58	20	11.350	5	009200589
9XL	(8R)	240	202	16.000	1	009200609
10	(8S)	58	20	11.350	5	009200590
10XL	(8S)	240	202	16.000	1	009200610
11	(10R)	58	20	11.350	5	009200591
11XL	(10R)	240	202	16.000	1	009200611
12L	(10S)	100	62	12.950	3	009200592

Ø mm	🔧	L mm	L1 mm	Ft	🔧	📄
12XL	(10S)	240	202	17.600	1	009200612
14L	(12S)	100	62	12.950	3	009200594
14XL	(12S)	240	202	17.600	1	009200614
16L	(14R)	100	62	12.950	3	009200596
16XL	(14R)	240	202	17.600	1	009200616



920ES/SB7	Ft	🔧	📄
7-9-10-11-12L-14L-16L	89.550	1	009200598



920ES-XL/SB7	Ft	🔧	📄
7XL-9XL-10XL-11XL 12XL-14XL-16XL	122.200	1	009200618

PM 1/2-Q5



PM 1/2-Q5	Ft
	72,570

920/15

Szűkítő közbetét 1/2" és 3/8"



UNI/ISO 3316 DIN 3123

L mm	🔧	Ø mm	Ft	🔧	📄
42	1/2	3/8	22,0	4.900	5 009200810



Ügyeljünk a forgató nyomatékra,
fokozatosan növeljük, hogy a törést,
illetve az esetleges sérülést elkerüljük.

920/16

Bővítő közbetét 1/2" és 3/4"



UNI/ISO 3316 DIN 3123

L mm	🔧	Ø mm	Ft	🔧	📄
46	1/2	3/4	26	6.400	5 009200814

920/20=920/23

1/2"-os toldó



UNI/ISO 3316 DIN 3123

	L mm	Ø mm	Ft	🔧	📄
920/20	75	22	5.950	5	009200818
920/21	125	22	7.290	5	009200822
920/22	255	22	8.300	5	009200826
920/23	375	22	11.150	2	009200827

920AN

1/2"-os gömbvégű toldó

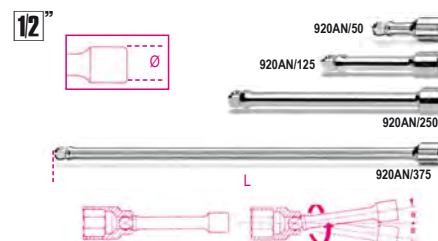

	L mm	Ø mm	Ft	🔧	📄
920AN/50	50	22	6.400	5	009200833
920AN/125	125	22	8.830	5	009200834
920AN/250	250	22	12.550	3	009200835
920AN/375	375	22	16.400	3	009200836

920/25

1/2"-os csukló



UNI/ISO 3316 DIN 3123

L mm	Ø mm	Ft	🔧	📄
75	27	11.550	5	009200830

920/35A

1/2"-os csuklós hajtósár



UNI/ISO 3315 DIN 3122

L mm	L1 mm	Ft	🔧	📄
285	160	23.050	3	009200846

920M/35

1/2"-os csuklós fémhajtósár



UNI/ISO 3315 DIN 3122

L	Ft	Icons
mm 380	33.200	2 009200845

920M/35L

1/2"-os csuklós fém hajtósár,
hosszított kivitel



L	Ft	Icons
mm 600	50.200	1 009200843



Ügyeljünk a forgató nyomatékra,
fokozatosan növeljük, hogy a törést,
illetve az esetleges sérülést elkerüljük.

920/36A

1/2"-os csuklós hajtósár, krómozott



UNI/ISO 3315 DIN 3122

L	L1	Ft	Icons
mm 408	mm 283	26.100	2 009200847

920/38

1/2" csuklós kihúzható külső négyszögű
hajtósár
markolattal



L	L max	Ft	Icons
mm 262	mm 402	39.450	1 009200839

920/40

1/2"-os csuklós T-hajtósár,
krómozott



L	L1	Ft	Icons
mm 490	mm 230	27.100	2 009200850

920/42

1/2"-os csúszkás T-hajtósár

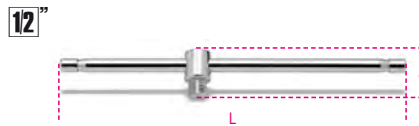

UNI/ISO 3315 DIN 3122

L	A	Ft	Icons
mm 305	mm 42	8.180	5 009200854

920/44

1/2"-os hajlított hajtósár, krómozott



UNI/ISO 3315 DIN 3122

L	L1	Ft	Icons
mm 230	mm 60	11.950	3 009200858

920/46

1/2"-os forgattyús hajtósár,
krómozott

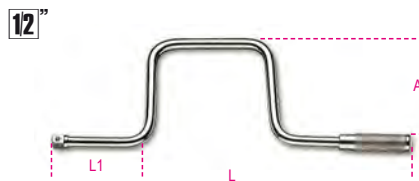

UNI/ISO 3315 DIN 3122

L	L1	A	Ft	Icons
mm 385	mm 110	mm 160	14.950	1 009200862

920/50

1/2" átnyomós racsní, 72 fogas mechanizmus



UNI/ISO 3315 DIN 3122

L	Ø	A	Ft	Icons
mm 271	mm 40	mm 40	26.300	3 009201150

920/50F

1/2" racsní, 72 fogas mechanizmus



UNI/ISO 3315 DIN 3122

L	Ø	A	Ft	Icons
mm 271	mm 40	mm 24	24.300	2 009201151

920/55

1/2" irányváltós racsní, 72 fogas mechanizmus



UNI/ISO 3315 DIN 3122

L	Ø	A	Ft	Icons
mm 271	mm 40	mm 41	28.150	3 009201155

920/55Q

1/2" irányváltós racsní, 48 fogas mechanizmus



UNI/ISO 3315 DIN 3122

L	Ø	A	Ft	Icons
mm 271	mm 40	mm 41	28.150	3 009201156

920/55X

1/2" irányváltós racsní, 72 fogas mechanizmus



UNI/ISO 3315 DIN 3122

L	Ø	A	Ft	Icons
mm 207	mm 31	mm 33	24.100	3 009201158



920/55LC

1/2" irányváltós racsni, Locking System, 72 fogas mechanizmus

12"



UNI/ISO 3315 DIN 3122

L	Ø	A	Ft	1	009201159
mm	mm	mm			
271	40	41	32.800	2	009201159

920M/55

1/2"-os irányváltós fémracsni

12"



24

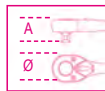

L	Ø	A	Ft	1	009200893
mm	mm	mm			
253	38	35	35.600	1	009200893

920/56A

1/2"-os csuklós irányváltós racsni, 72 fogú, krómazott

12"

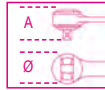

L	Ø	A	Ft	1	009200911
mm	mm	mm			
315	40	43	45.350	1	009200911

920M/56

1/2"-os irányváltós csuklós fémracsni

12"



24

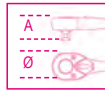

L	Ø	A	Ft	2	009200894
mm	mm	mm			
330	38	35,7	47.350	2	009200894



920/58

Írányváltós racsni
1/2",
52-fogú

- Hajtószár
- Nyitó és rögzítő gomb
- Irányváltás a fején lévő műanyag gyűrű jobbra és balra forgatásával
- Bimateriál-nyél

12"

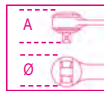

L	Ø	A	Ft	1	009200926
mm	mm	mm			
281	42,5	45	41.700	1	009200926

Tartalék forgó alkatrészek

111

920.../C11

11 dugókulcs és 2 tartozék fémdobozban

12"



920A/C11	Ft	1	009200921
920A	88.950	1	009200921

920A	10 - 12 - 13 - 14 - 15 - 16
920/22	17 - 18 - 19 - 21 - 22 mm
920/50	255 mm

335x145x60 mm - 2,5 kg

920B/C11	Ft	1	009200922
920B	88.950	1	009200922

920B	10 - 12 - 13 - 14 - 15 - 16
920/22	17 - 18 - 19 - 21 - 22 mm
920/50	255 mm

335x145x60 mm - 2,5 kg

920.../C12...

12 dugókulcs és 5 tartozék fémdobozban

12"



920A/C12X	Ft	1	009200933
920A	129.700	1	009200933

920A	10 - 11 - 12 - 13 - 14 - 17 - 19
920/21	22 - 24 - 27 - 30 - 32 mm
920/22	125 mm
920/25	255 mm
920/42	
920/55	

420x185x60 mm - 4,2 kg

9899 920C12	Ft	1	098990116
Hőformált tálcá, üres	6.190	1	098990116

920A/C12	Ft	1	009200931
920A	127.900	1	009200931

920A	10 - 11 - 12 - 13 - 14 - 17 - 19
920/21	22 - 24 - 27 - 30 - 32 mm
920/22	125 mm
920/25	255 mm
920/42	
920/50	

420x185x60 mm - 4,2 kg

9899 920C12	Ft	1	098990116
Hőformált tálcá, üres	6.190	1	098990116

920B/C12X	Ft	1	009200934
920B	129.700	1	009200934

920B	10 - 11 - 12 - 13 - 14 - 17 - 19
920/21	22 - 24 - 27 - 30 - 32 mm
920/22	125 mm
920/25	255 mm
920/42	
920/55	

420x185x60 mm - 4,0 kg

9899 920C12	Ft	1	098990116
Hőformált tálcá, üres	6.190	1	098990116

920B/C12	Ft	1	009200932
920B	127.900	1	009200932

920B	10 - 11 - 12 - 13 - 14 - 17 - 19
920/21	22 - 24 - 27 - 30 - 32 mm
920/22	125 mm
920/25	255 mm
920/42	
920/50	

420x185x60 mm - 4,0 kg

9899 920C12	Ft	1	098990116
Hőformált tálcá, üres	6.190	1	098990116

920MC/C14

14 színezett hatszögű dugókulcs
és 5 tartozék

12"



920MC/C14 Ft 136.600 1 009202964

- 920MC
 - 920/21
 - 920/22
 - 920/25
 - 920/42
 - 920/55
- 420x185x60 mm - 4,2 kg

920.../C20...

20 dugókulcs és 5 tartozék fémdobozban

12"



920A/C20X Ft 160.700 1 009200950

- 920A
 - 920/21
 - 920/22
 - 920/25
 - 920/42
 - 920/55
- 420x185x60 mm - 5,1 kg

9899 920C20 Ft 6.190 1 098990121
Hőformált tálcá, üres

920A/C20 Ft 158.900 1 009200948

- 920A
 - 920/21
 - 920/22
 - 920/25
 - 920/42
 - 920/50
- 420x185x60 mm - 5,1 kg

9899 920C20 Ft 6.190 1 098990121
Hőformált tálcá, üres

920A/C20Q Ft 160.700 1 009200955

- 920A
- 920/21
- 920/22
- 920/25
- 920/42
- 920/55Q

420x185x60 mm - 5,1 kg

9899 920C20 Ft 6.190 1 098990121
Hőformált tálcá, üres

920B/C20 Ft 158.900 1 009200949

- 920B
- 920/21
- 920/22
- 920/25
- 920/42
- 920/50

420x185x60 mm - 5,0 kg

9899 920C20 Ft 6.190 1 098990121
Hőformált tálcá, üres

920B/C20X Ft 160.700 1 009200951

- 920B
- 920/21
- 920/22
- 920/25
- 920/42
- 920/55

420x185x60 mm - 5,0 kg

9899 920C20 Ft 6.190 1 098990121
Hőformált tálcá, üres

920.../C21...

21 dugókulcs és 5 tartozék fémdobozban

12"



920A/C21 Ft 184.800 1 009200952

- 920A
- 920/21
- 920/22
- 920/25
- 920/42
- 920/46
- 920/50

420x280x60 mm - 6,5 kg

920B/C21 Ft 184.800 1 009200953

- 920B
- 920/21
- 920/22
- 920/25
- 920/42
- 920/46
- 920/50

420x280x60 mm - 6,4 kg

920B/C21X Ft 186.600 1 009200984

- 920B
- 920/21
- 920/22
- 920/25
- 920/42
- 920/46
- 920/55

420x280x60 mm - 6,4 kg

920B/C300

30 dugókulcs és 5 tartozék
fémdobozban

12"



920B/C300 Ft 261.700 1 009200975

- 920B
- 920BL
- 920/21
- 920/22
- 920/25
- 920/42
- 920/55Q

420x280x60 mm - 7,6 kg



Beta

920.../C33

20 dugókulcs, 13 csavarhúzó-dugókulcs és 5 tartozék fémdobozban

12"



920A/C33 Ft 256.800 1 009200985

	920A	10 - 11 - 12 - 13 - 14 - 15 - 16 17 - 18 - 19 - 20 - 21 - 22 - 23 24 - 26 - 27 - 28 - 30 - 32 mm
	920LP	1,2x8 - 1,6x9 - 2x12 mm
	920PH	PH2 - PH3 - PH4
	920PE	4 - 5 - 6 - 8 - 10 - 12 - 14 mm
	920/21	125 mm
	920/22	255 mm
	920/25	
	920/42	
	920/55	

420x280x60 mm - 6,7 kg

920B/C33 Ft 256.800 1 009200986

	920B	10 - 11 - 12 - 13 - 14 - 15 - 16 17 - 18 - 19 - 20 - 21 - 22 - 23 24 - 26 - 27 - 28 - 30 - 32 mm
	920LP	1,2x8 - 1,6x9 - 2x12 mm
	920PH	PH2 - PH3 - PH4
	920PE	4 - 5 - 6 - 8 - 10 - 12 - 14 mm
	920/21	125 mm
	920/22	255 mm
	920/25	
	920/42	
	920/55	

420x280x60 mm - 6,7 kg

920A/C17M

17 hatlapú dugókulcs és 5 tartozék fémdobozban

12"



920A/C17M Ft 147.200 1 009200924

	920A	10-11-12-13-14-15-16-17-18 19-20-21-22-24-27-30-32 mm
	920/21	125 mm
	920/22	255 mm
	920/25	
	920/42	305 mm
	920/55	

420x185x60 mm - 5 kg

9899 920C17 Ft 11.350 1 098990147
Puha modul, üres

920A/C17MR Ft 160.800 1 009200937

	920/21	125 mm
	920/22	255 mm
	920/25	
	920/42	305 mm
	920/58	

420x185x60 mm 5,1 kg

920/C37

37 dugókulcs és 5 tartozék fémdobozban

12"



920/C37 Ft 242.400 1 009200988

	920B	10 - 11 - 12 - 13 - 14 - 15 - 16 17 - 18 - 19 - 20 - 21 - 22 - 23 24 - 26 - 27 - 28 - 30 - 32 mm
	920AS	3/8 - 7/16 - 1/2 - 9/16 - 19/32 5/8 - 11/16 - 3/4 - 25/32 - 13/16 7/8 - 15/16 - 1 - 1.1/16 - 1.1/8 1.3/16 - 1.1/4
	920/21	125 mm
	920/22	255 mm
	920/25	
	920/42	
	920/55	

420x280x60 mm - 7,5 kg

920AS/C10

10 tizenkétszögű dugókulcs és 2 tartozék fémdobozban

12"



920AS/C10 Ft 92.200 1 009200919

	920AS	3/8 - 7/16 - 1/2 - 9/16 - 5/8 11/16 - 3/4 - 13/16 - 7/8 - 15/16
	920/22	255 mm
	920/50	

335x145x60 mm - 2,6 kg

920AS/C15

15 tizenkétszögű dugókulcs és 6 tartozék fémdobozban

12"



920AS/C15 Ft 171.800 1 009200947

	920AS	3/8 - 7/16 - 1/2 - 9/16 - 5/8 - 11/16 3/4 - 13/16 - 7/8 - 15/16 - 1 1.1/16 - 1.1/8 - 1.3/16 - 1.1/4
	920/21	125 mm
	920/22	255 mm
	920/25	
	920/42	
	920/46	
	920/50	

420x280x60 mm - 5,9 kg

920AS/C17X

17 dugókulcs és 5 tartozék fémdobozban

12"



920AS/C17X Ft 160.500 1 009200942

	920AS	3/8 - 7/16 - 1/2 - 9/16 - 19/32 - 5/8 11/16 - 3/4 - 25/32 - 13/16 - 7/8 15/16 - 1 - 1.1/16 - 1.1/8 - 1.3/16 - 1.1/4
	920/21	125 mm
	920/22	255 mm
	920/25	
	920/42	
	920/55	
		420x185x60 mm - 4,8 kg

920TX/C17

6 csavarhúzóbetét, 6 dugókulcs Torx®-csavarokhoz és 4 tartozék fémdobozban



12"



920TX/C17 Ft 148.800 1 009200989

	861TX	T8 - T10 - T15 - T20 - T25 - T27
	897	
	920TX	T27 - T30 - T40 - T45 - T50
	920FTX	E10 - E12 - E14 - E16 - E18 - E20
	920/20	75 mm
	920/22	255 mm
	920/55	
		420x185x60 mm - 2,9 kg

928A

Hattlapú dugókulcs



UNI/ISO 2725
DIN 3124

mm	Ø mm	L mm	Ø1 mm	Ft	5	1
19	29,2	50	34	7.570	5	009280019
21	30,0	51	34	7.690	5	009280021
22	31,3	53	34	7.690	5	009280022
23	33,3	53	34	7.850	5	009280023
24	34,5	53	34	7.980	5	009280024
26	36,8	55	35	8.540	5	009280026
27	38,0	56	35	8.540	5	009280027
28	39,0	57	35	9.030	3	009280028
29	40,2	58	35	9.230	3	009280029
30	41,5	58	37	9.470	3	009280030
32	44,3	60	37	9.960	3	009280032
33	45,8	60	37	10.500	3	009280033
34	46,8	60	37	10.700	3	009280034
35	48,1	62	38	10.700	3	009280035
36	49,5	64	38	10.700	3	009280036
38	52,0	68	40	11.750	3	009280038
41	56,0	71	40	13.150	3	009280041
46	62,3	75	43	16.200	3	009280046
50	67,4	80	43	19.450	3	009280050
55	73,7	84	48	23.900	1	009280055
60	80,0	87	48	27.550	1	009280060

920AS/MBM-C21

16 dugókulcs és 5 tartozék fémdobozban

12"



920AS/MBM-C21 Ft 162.600 1 009200944

	920AS	3/8 - 7/16 - 1/2 - 9/16 19/32 - 5/8 - 11/16 - 3/4 25/32 - 13/16 - 7/8 - 15/16 1 - 1.1/16 - 1.3/16 - 1.1/4
	920M/55	
	920/21	125 mm
	920/22	255 mm
	920/25	
	920/42	
		420x185x60 mm - 5,0 kg

920A/C17HR

17 hattlapfejű dugókulcs és 5 tartozék kemény hőformázott tálcában, lemezdobozban

• forgó markolatos racsni

12"



920A/C17HR Ft 164.800 1 009200939

	920A	10-11-12-13-14-15-16-17-18 19-20-21-22-24-27-30-32 mm
	920/21	125 mm
	920/22	255 mm
	920/25	
	920/42	
	920/58	
		420x185x60 mm - 5,1 kg

928B

Tizenkétszögű dugókulcs



UNI/ISO 2725
DIN 3124

mm	Ø mm	L mm	Ø1 mm	Ft	5	1
19	29,2	50	34	7.570	5	009280119
21	30,0	51	34	7.690	5	009280121
22	31,3	53	34	7.690	5	009280122
23	33,3	53	34	7.850	5	009280123
24	34,5	53	34	7.980	5	009280124
26	36,8	55	35	8.540	5	009280126
27	38,0	56	35	8.540	5	009280127
28	39,0	57	35	9.030	3	009280128
29	40,2	58	35	9.230	3	009280129
30	41,5	58	37	9.470	3	009280130
32	44,3	60	37	9.960	3	009280132
33	45,8	60	37	10.500	3	009280133
34	46,8	60	37	10.700	3	009280134
35	48,1	62	38	10.700	3	009280135
36	49,5	64	38	10.700	3	009280136
38	52,0	68	40	11.750	3	009280138
41	56,0	71	40	13.150	3	009280141
46	62,3	75	43	16.200	3	009280146
50	67,4	80	43	19.450	3	009280150
55	73,7	84	48	23.900	1	009280155
60	80,0	87	48	27.550	1	009280160

928AS

Hatlapú dugókulcs



"	Ø mm	L mm	Ø1 mm	Ft	🔧	📄
7/8	32,0	53	34	8.540	1	009280202
15/16	34,5	53	34	8.540	1	009280203
1	36,2	55	35	9.030	1	009280204
1.1/16	38,0	56	35	9.350	1	009280205
1.1/8	40,2	58	35	9.550	1	009280206
1.1/4	44,2	60	37	10.300	1	009280208
1.5/16	45,8	60	37	10.950	1	009280209
1.3/8	48,1	62	38	11.350	1	009280210
1.7/16	49,5	64	38	11.750	1	009280211
1.1/2	52,0	68	40	12.950	1	009280212
1.5/8	56,0	71	40	13.950	1	009280214
1.11/16	58,8	74	40	16.000	1	009280215
1.13/16	62,3	75	43	18.000	1	009280217
1.7/8	65,0	78	43	19.450	1	009280218
2	68,3	80	43	22.250	1	009280219
2.1/16	71,5	83	48	25.900	1	009280220

928ME

Imbusz-dugókulcs, krómozott

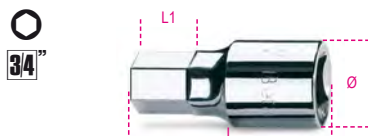

mm	Ø mm	L mm	L1 mm	Ft	🔧	📄
14	35	75	15,5	17.400	2	009280514
17	35	75	15,5	17.400	2	009280517
19	35	75	15,5	17.400	2	009280519
22	35	75	22,5	17.400	2	009280522

928/15

Szűkítő közbetét 3/4"- 1/2",
krómozott



UNI/ISO 3316
DIN 3123

L mm	Ø mm	□	■	Ft	🔧	📄
51,5	34	3/4	1/2	9.030	5	009280801



Ügyeljünk a forgató nyomatékra,
fokozatosan növeljük, hogy a törést,
illetve az esetleges sérülést elkerüljük.



928/16

Bővítő közbetét 3/4"-1",
krómozott



UNI/ISO 3316
DIN 3123

L mm	Ø mm	□	■	Ft	🔧	📄
65	34	3/4	1"	10.950	5	009280807

928/20 - 928/21 - 928/22

3/4"-os toldó

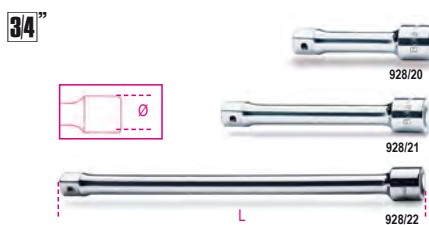

UNI/ISO 3316
DIN 3123

	L mm	Ø mm	Ft	🔧	📄
928/20	100	34	10.700	3	009280810
928/21	200	34	14.150	3	009280815
928/22	380	34	20.850	3	009280825

928/25

Csukló 3/4"



UNI/ISO 3316 DIN 3123

L mm	Ø mm	Ft	🔧	📄
108	40	35.800	1	009280830

928/36A

3/4"-os csuklós hajtószer, krómozott



DIN 3122 - UNI ISO 3315

L mm	Ft	🔧	📄
545	42.900	1	009280844

928/42

3/4"-os csúszkás T-hajtószer,
krómozott

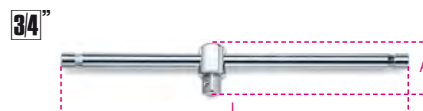

UNI/ISO 3315 DIN 3122

L mm	A mm	Ft	🔧	📄
450	62,5	22.650	3	009280850

928/55

3/4" irányváltós racsn, 72 fogas mechanizmus



DIN 3122 - UNI ISO 3315

L mm	Ø mm	A mm	Ft	🔧	📄
504	58	59	73.900	2	009281155

Tartalék forgó alkatrészek

📄 111



928.../C12

12 hatlapú dugókulcs és 5 tartozék, fémdobozban

3/4"



928A/C12	Ft	1	009280955
389.600			

928A	22 - 24 - 27 - 30 - 32 - 34 - 36
928/21	200 mm
928/22	380 mm
928/25	
928/42	
928/55	

530x220x80 mm - 13,5 kg

928B/C12	Ft	1	009280957
389.600			

928B	22 - 24 - 27 - 30 - 32 - 34 - 36
928/21	200 mm
928/22	380 mm
928/25	
928/42	
928/55	

530x220x80 mm - 13,5 kg

928AS/C12

12 hatlapú dugókulcs és 5 tartozék, fémdobozban

3/4"



928AS/C12	Ft	1	009280968
401.400			

928AS	7/8-15/16-1.1/16-1.1/8-1.1/4-1.5/16-1.7/16-1.1/2-1.11/16-1.13/16-1.7/8-2.1/16
928/21	200 mm
928/22	380 mm
928/25	
928/42	
928/55	

530x220x80 mm - 13,5 kg

929

Hatlapú dugókulcs

1"



UNI/ISO 2725 DIN 3124

mm	Ø mm	L mm	Ø1 mm	Ft	1	009290036
36	51	65	48	15.800		
41	57	70	48	16.800		
46	65	75	48	18.600		
50	70	80	48	21.650		
55	76	85	54	25.300		
60	82	90	54	27.100		
65	88	95	54	35.000		
70	92	100	60	41.900		
75	99	110	60	45.350		
80	106	120	60	52.000		

929/15

Szűkítő közbetét, 1"-3/4", krómozott

1"



UNI/ISO 3316 DIN 3123

L mm	Ø mm	1"	3/4"	Ft	2	009290801
65	47			18.600		



Ügyeljünk a forgató nyomatékra, fokozatosan növeljük, hogy a törést, illetve az esetleges sérülést elkerüljük.

929/21 - 929/22

1"-os toldó

1"



UNI/ISO 3316 DIN 3123

	L mm	Ø mm	Ft	1	009290815
929/21	200	47	24.100		
929/22	400	47	35.000		

929/42

1"-os csúszkás T-hajtószar, krómozott

1"



UNI/ISO 3315 DIN 3122

L mm	Ft	1	009290850
535	44.950		

929/55

1"-os irányváltós racsni, 72 fogú, krómozott

1"

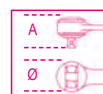

UNI/ISO 3315 DIN 3122

L mm	Ø mm	A mm	Ft	1	009290860
770	62	63	96.950		

929/55PR

Toldó a 929/55 racsnihoz



L mm	Ø mm	Ø1 mm	Ft	1	009290868
540	32	26	20.650		

929/C8

8 dugókulcs és 5 tartozék, fémdobozban

1"



929/C8	Ft	1	009290925
566.000			

929	46 - 50 - 55 - 60 - 65
929/15	70 - 75 - 80 mm
929/21	□ 1" - ■ 3/4"
929/22	200 mm
929/22	400 mm
929/42	
929/55	

560x290x120 mm - 29 kg



9899 CV/A

táska, üres



9899 CV/A Ft 15.400 1 098990001

583/C31-671B/C5-671B/C10-720ME/C8
860/C38P-861/C61P-900/C11-900AS/C10-/MB-C17
900/C24-900/C13-8-900/C13-5-900MB/C19-900MB/C28
900/C11HR-900AS/C10-/MB-C17-900AS/C17-MBM
900/C11Z-900MC/C24-900MC/C32-910.../C10
971/C8-920TX/C-920PE/C-920FTX/C-910.../C10

≡ 270x120x45 mm

9899 CV/B

táska, üres



9899 CV/B Ft 17.800 1 098990002

352C/U-720MC/C13-727/C16-867/C20-900/C12MR
900/C12MZ-900U/C12M-910AS/C13...-910AS/MBM-C18
910A/C16...-910B/C16...-910A/C16HR
910A/C16...-910B/C16...-920AS/C10-920.../C11-1433/C11
1494/C14A-1529-1545/C5M

≡ 335x145x60 mm

9899 CV/C

táska, üres



9899 CV/C Ft 21.850 1 098990003

920A/C17HR-920A/C17MR-920.../C12...
920A/C17M-910.../C29-902A/C22-867/C38
720/C24-450/C15-353N/C6-960KPC-920MC/C14
920U/C17M-920TX/C17-920.../C20...
920AS/MBM-C21-920AS/C17X-1547/C6-1495/C6
1489/C14-1461/C11A-1608/C9-1606A/C9-1602/C9

≡ 420x185x60 mm

900/R55

14" 40



900/R55 Ft 15.800 1 009000871
666N/2-666/2-666LBF.FT/2

900/RN55

14" 40



900/RN55 Ft 15.800 1 009001115
900/55

900/R55-Z

14" 72



900/R55-Z Ft 15.800 1 009000872

900M/R55

14" 72



900M/R55 Ft 8.300 1 009000888
900M/55

910/R55

38" 72



910/R55 Ft 15.400 1 009100879
599DGT/6-606/6-606/10-612-665/6-665/10-665LB/6
665LB/10-666N/5-666N/10-666N LBF.IN/5-666NLBF.IN/10
666/6-666/10-668RGC/6-668RGC/10-666/5
666HS/5-666HS/10-666 LBF.FT/5-666 LBF.FT/10

910/RN55

38" 72



910/RN55 Ft 15.400 1 009101115
910/55

910M/R55

38" 40



910M/R55 Ft 8.540 1 009100888
910M/55-910M/56

910/R55X

38" 40



910/R55X Ft 15.400 1 009100897
666N/2X-666/2X-666 LBF.FT/2X

920/R50

12" 72



920/R50 Ft 15.200 1 009200866
614/50-667/20-667/30
667N/20-667N/30

920/RN50

12" 72



920/RN50 Ft 15.200 1 009201130
920/50

920/RN50F

12" 72



920/RN50F Ft 15.200 1 009201131
920/50F

920/R55

12" 72



920/R55 Ft 18.400 1 009200879
606/20-606/30-666/20-666/30-920/56A- 599DGT/20-
599DGT/30
599DGT-AN/20-665/20-665/30-665LB/20
665LB/30-666N/20-666N/30
666N LBF.IN/20-666N LBF.IN/30-668RGC/20
666 LBF.FT/20-666 LBF.FT/30

920/RN55



12"
172

920/RN55
920/55

Ft 18.400 1 009201125

920M/R55



12"

920M/R55
920M/55-920M/56

Ft 9.550 1 009200888

920/RN55Q



12"
172

920/RN55Q
920/55Q

Ft 18.400 1 009201126

920/R55X



12"
172

920/R55X
606/10X-612X
666/10X-599DGT/10X-599DGT-AN/10
665/10X-665LB/10X-666N10X-666N LBF.IN/10X
668RGC/10X-666 LBF.FT/10X
666HS/20LC-666HS/30LC

Ft 15.200 1 009200878

920/RN55X



12"
172

920/RN55X
920/55X

Ft 15.200 1 009201128

920/R55LC



12"
172

920/R55LC
666HS/20LC-666HS/30LC

Ft 19.450 1 009200887

920/RN55LC



12"
172

920/RN55LC
920/55LC "Locking System"

Ft 19.450 1 009201129

928/RN55



3/4"
172

928/RN55
928/55

Ft 30.750 1 009281115

928/R55X



3/4"
172

928/R55X
614X

Ft 19.650 1 009280858

929/R55



1"
172

929/R55
929/55

Ft 35.400 1 009290859

930

Erősített tizenkétszögű csőkulcs,
krómozott



UNI 6745

Ø mm	L mm	Ø mm	Ø1 mm	Ft	1	1
6x7	100	9,5	11,0	6.190	3	009300006
8x9	108	12,5	14,0	7.810	3	009300010
10x11	116	15,0	16,5	8.140	3	009300014
12x13	124	17,5	19,0	9.550	3	009300018
14x15	132	20,0	21,5	10.300	3	009300023
16x17	140	23,0	24,0	11.950	3	009300027
18x19	148	25,0	26,5	13.350	3	009300032
20x22	156	28,0	30,0	14.750	2	009300036
21x23	163	29,0	31,5	15.600	2	009300040
24x26	173	33,0	35,5	19.850	2	009300044
25x28	182	34,5	38,0	21.450	2	009300048
27x29	191	37,0	39,5	24.500	2	009300052
30x32	200	40,5	43,0	29.550	2	009300056



930/S8
6x7-8x9-10x11-12x13-14x15
16x17-18x19-20x22 mm

Ft 88.250 1 009300081

940/1 - /2
930/S13 205.500 1 009300083

6x7-8x9-10x11-12x13-14x15-16x17
18x19-20x22-21x23-24x26
25x28-27x29-30x32 mm
940/1 - /2 - /3



930/C13 236.700 1 009300098

6x7-8x9-10x11-12x13
14x15-16x17-18x19
20x22-21x23-24x26
25x28-27x29-30x32 mm
940/1 - /2 - /3

932

Tizenkétszögű pipakulcs, fényes
krómozott

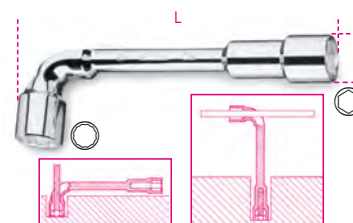

NF E 74.303

Ø mm	Ø mm	L mm	Ft	5	1
6x6	11,5	110	6.960	5	009320006
7x7	12,5	116	7.040	5	009320007
8x8	13,0	120	7.290	5	009320008
9x9	14,0	125	7.570	5	009320009
10x10	16,5	133	7.890	5	009320010
11x11	17,5	143	8.580	5	009320011
12x12	19,0	148	9.150	5	009320012
13x13	19,5	154	9.510	5	009320013
14x14	21,5	167	10.100	5	009320014
15x15	22,5	182	10.500	5	009320015
16x16	24,5	193	11.150	5	009320016
17x17	26,0	198	11.150	5	009320017
18x18	26,5	215	12.350	5	009320018
19x19	29,0	220	13.350	5	009320019
20x20	30,5	222	14.150	3	009320020
21x21	30,5	236	16.200	3	009320021
22x22	32,5	250	17.800	2	009320022
23x23	33,5	256	19.850	2	009320023
24x24	35,0	272	21.250	2	009320024
25x25	36,5	282	22.450	2	009320025
26x26	37,5	296	24.700	2	009320026
27x27	39,0	296	25.900	2	009320027
28x28	39,0	314	29.350	2	009320028
30x30	42,5	348	35.200	2	009320030
32x32	45,5	364	39.050	2	009320032



	Ft	🔧	📦
932/S11 6-7-8-10-11-12 13-14-17-19-22 mm	108.800	1	009320080
932/S17 6-7-8-9-10-11-12 13-14-15 16-17-18-19-20-21-22 mm	180.800	1	009320081
932/S25 6-7-8-9-10-11-12-13 -14-15-16-17-18-19 20-21-22-23-24-25 -26-27-28-30-32 mm	398.600	1	009320082

933

Hatlapú pipakulcs fényes, krómozott

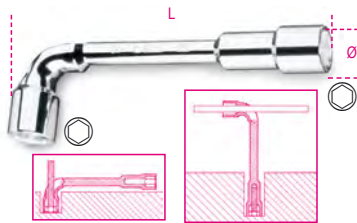

NF E 74.303

mm	Ø mm	L mm	Ft	🔧	📦
6x6	11,5	110	6.960	5	009330006
7x7	12,5	116	7.040	5	009330007
8x8	13,0	120	7.290	5	009330008
9x9	14,0	125	7.570	5	009330009
10x10	16,5	133	7.890	5	009330010
11x11	17,5	143	8.580	5	009330011
12x12	19,0	148	9.150	5	009330012
13x13	19,5	154	9.510	5	009330013
14x14	21,5	167	10.100	5	009330014
15x15	22,5	182	10.500	5	009330015
16x16	24,5	193	11.150	5	009330016
17x17	26,0	198	11.150	5	009330017
18x18	26,5	215	12.350	5	009330018
19x19	29,0	220	13.350	5	009330019
20x20	30,5	222	14.150	3	009330020
21x21	30,5	236	16.200	3	009330021
22x22	32,5	250	17.800	2	009330022
23x23	33,5	256	19.850	2	009330023
24x24	35,0	272	21.250	2	009330024
25x25	36,5	282	22.450	2	009330025
26x26	37,5	296	24.700	2	009330026
27x27	39,0	296	25.900	2	009330027
28x28	39,0	314	29.350	2	009330028
30x30	42,5	348	35.200	2	009330030
32x32	45,5	364	39.050	2	009330032



	Ft	🔧	📦
933/S11 6-7-8-10-11-12-13-14-17-19-22 mm	108.800	1	009330080
933/S17 6-7-8-9-10-11-12-13-14-15-16-17 18-19-20-21-22 mm	180.800	1	009330081
933/S25 6-7-8-9-10-11-12-13-14-15-16-17-18-19 20-21-22-23-24-25-26-27-28-30-32 mm	398.600	1	009330082

935

Könnyített hatlapú csőkulcs, krómozott



UNI 6746 DIN 896

mm	L mm	Ft	🔧	📦
6x7	100	3.580	5	009350105
8x9	110	3.850	5	009350111
10x11	120	4.290	5	009350115
12x13	130	4.860	5	009350117
14x15	140	5.670	5	009350126
16x17	150	6.190	5	009350128
18x19	160	7.290	5	009350131
20x22	170	8.870	3	009350138
21x23	180	9.840	3	009350141
24x26	190	11.150	3	009350144
25x28	200	12.350	2	009350150
27x29	210	14.550	2	009350153
30x32	220	15.600	2	009350156



	Ft	🔧	📦
935/S8 6x7-8x9-10x11-12x13-14x15-16x17 18x19-20x22 mm	50.750	1	009350181
940/1 - /2 935/S13 6x7-8x9-10x11-12x13-14x15-16x17 18x19-20x22-21x23-24x26-25x28 27x29-30x32 mm	120.600	1	009350183
940/1 - /2 - /3			

937

Hatlapú-tizenkétszögű pipakulcs, krómozott

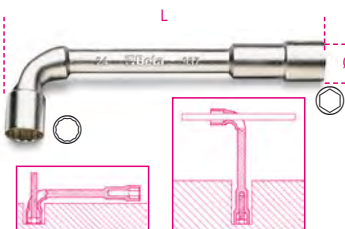

mm	Ø mm	L mm	Ft	🔧	📦
6x6	11,5	110	3.850	5	009370006
7x7	12,5	116	4.010	5	009370007
8x8	13,0	120	4.170	5	009370008
9x9	14,0	125	4.410	5	009370009
10x10	16,5	133	4.620	5	009370010
11x11	17,5	143	4.860	5	009370011
12x12	19,0	148	5.430	5	009370012
13x13	19,5	154	5.590	5	009370013
14x14	21,5	167	6.110	5	009370014
15x15	22,5	182	6.720	5	009370015
16x16	24,5	193	7.250	5	009370016
17x17	26,0	198	7.530	5	009370017
18x18	26,5	215	7.690	5	009370018
19x19	29,0	220	8.020	5	009370019
20x20	30,5	222	9.070	3	009370020
21x21	30,5	236	9.920	3	009370021
22x22	32,5	250	10.500	2	009370022
23x23	33,5	256	11.550	2	009370023
24x24	35,0	272	11.950	2	009370024
25x25	36,5	282	15.400	2	009370025
26x26	37,5	296	15.800	2	009370026
27x27	39,0	296	16.000	2	009370027
28x28	39,0	314	19.450	2	009370028
30x30	42,5	348	20.650	2	009370030
32x32	45,5	364	23.500	2	009370032



	Ft	🔧	📦
937/S11 6-7-8-10-11-12 -13-14-17-19-22 mm	64.700	1	009370080
937/S17 6-7-8-9-10-11-12 -13-14-15-16-17 18-19-20-21-22 mm	109.800	1	009370081

940

Hajtószár a 930 és 935 típusú csőkulcsokhoz, krómozott

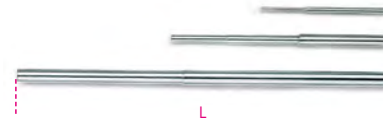

	mm	L mm	Ft	🔧	📦
940/1	6-13	100	2.670	5	009400001
940/2	14-22	170	3.500	5	009400002
940/3	21-32	290	6.320	5	009400003

941

T-szárú dugókulcs, 12 x 6, műanyag markolattal

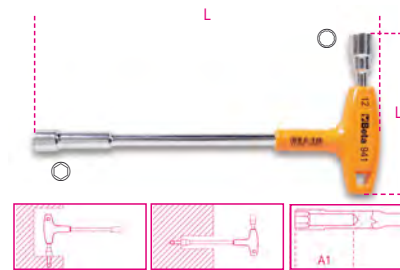

mm	L mm	L1 mm	A1 mm	Ft	🔧	📦
7x7	200	91	35	12.950	2	009410107
8x8	220	107	50	14.150	2	009410108
9x9	220	109	50	14.150	2	009410109
10x10	236	111	50	14.550	2	009410110
11x11	236	114	50	15.200	2	009410111
12x12	255	122	50	16.800	2	009410112
13x13	255	124	55	17.000	2	009410113



	Ft	🔧	📦
941/S7 7-8-9-10-11-12-13 mm	104.900	1	009410170





DUGÓKULCS- CSAVARHÚZÓK MARKOLATTAL

Gyors, ismételt csavarozási műveletekhez alkalmas. A vékonyított hatlapú fej kis helyekhez is hozzáférést biztosít.

A belső üreg a kiálló menetes részek esetén is könnyű csavarozást tesz lehetővé.

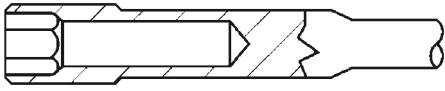

Ez különösen a 944BX típusú mély, nagy nyomatékú dugókulcs-csavarhúzókra érvényes.

A fejen található hármas jelölés megkönnyíti a szükséges méret beazonosítását.

A 943FL modell flexibilis éle, melynek acél magját egy köpeny védi, akkor is lehetővé teszi a nyomaték átadását, ha a csavar elmozdult.

942BX

Rövid hatlapú dugókulcs-csavarhúzó



UNI 6750

Ø mm	L mm	L1 mm	A1 mm	Ft	🔧	📦
4	190	70	13,0	6.440	5	009420003
5	190	70	14,0	6.440	5	009420004
5,5	190	70	12,5	7.290	5	009420005
6	190	70	14,5	7.290	5	009420006
7	190	70	15,5	7.650	5	009420007
8	202	70	18,5	7.650	5	009420008
9	202	70	19,5	7.650	5	009420009
10	202	70	20,5	8.140	3	009420010
11	202	70	21,5	8.140	3	009420011
12	202	70	22,5	8.140	3	009420012
13	202	70	23,5	9.230	3	009420013
14	202	70	24,5	9.230	3	009420014



942BX/S12 Ft 93.250 1 009420030
4-5-5,5-6-7-8-9
10-11-12-13-14 mm

943BX

Hosszú hatlapú dugókulcs-csavarhúzó



ISO 2236 UNI 6750

Ø mm	L mm	L1 mm	A1 mm	Ft	🔧	📦
4	270	150	13,0	7.170	5	009430003
5	270	150	14,0	7.170	5	009430004
5,5	270	150	12,5	7.690	5	009430005
6	270	150	14,5	7.690	5	009430006
7	270	150	15,5	8.260	5	009430007
8	282	150	18,5	8.260	5	009430008
9	282	150	19,5	8.260	5	009430009
10	282	150	20,5	8.990	3	009430010
11	282	150	21,5	8.990	3	009430011
12	282	150	22,5	8.990	3	009430012
13	282	150	23,5	9.550	3	009430013
14	282	150	24,5	9.550	3	009430014



943BX/S12 Ft 100.600 1 009430030
4-5-5,5-6-7-8-9
10-11-12-13-14 mm



943BX/D6 Ft 49.900 1 009430026
5-6-7-8-10-13 mm

943FL

Flexibilis dugókulcs-csavarhúzó, krómzott



Ø mm	L mm	L1 mm	Ø mm	Ft	🔧	📦
5	265	150	8	10.100	2	009430304
5,5	265	150	8	10.100	2	009430305
6	265	150	9	10.100	2	009430306
7	265	150	11	10.100	2	009430307
8	265	150	12	10.500	2	009430308
10	290	175	14	11.350	2	009430310



943FL/S6 Ft 62.350 1 009430320
5-5,5-6-7-8-10 mm

944BX

Hosszú hatlapú dugókulcs-csavarhúzó



ISO 2236 UNI 6750

Ø mm	L mm	L1 mm	A1 mm	Ft	🔧	📦
4	245	125	20	7.450	3	009440003
5	245	125	25	7.450	3	009440004
5,5	245	125	30	9.070	3	009440005
6	245	125	35	9.070	3	009440006
7	245	125	35	9.070	3	009440007
8	257	125	50	9.800	3	009440008
9	257	125	50	9.800	3	009440009
10	257	125	50	10.100	3	009440010
11	257	125	50	10.100	3	009440011
12	257	125	50	11.150	3	009440012
13	257	125	55	11.150	3	009440013
14	257	125	55	11.150	3	009440014



944BX/S12 Ft 115.300 1 009440062
4-5-5,5-6-7-8-9
10-11-12-13-14 mm



944BX/D6 Ft 56.650 1 009440056
5-6-7-8-10-13 mm

949

T szárú egyszerű kulcs mély hatlapfejű dugóvéggel

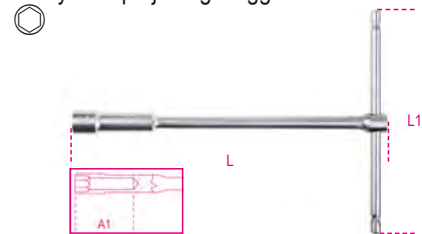

Ø mm	L mm	L1 mm	Ft	🔧	📦
8	220	160	13.550	2	009490008
10	230	160	14.150	2	009490010
12	240	175	14.750	2	009490012
13	244	175	15.200	2	009490013
14	250	190	16.000	2	009490014
17	264	200	18.400	2	009490017



949/S6	Ft		
8-10-12-13-14-17mm	92.100	1	009490076

950

T-szárú dugókulcs, krómozott

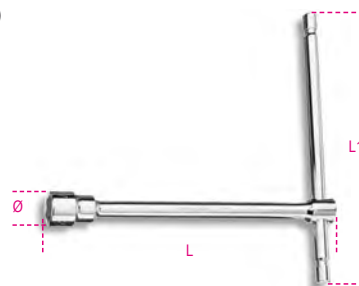

UNI 6742 DIN 3112

mm	L	Ø	L1	Ft		
6	210	10,1	145	9.390	3	009500006
7	212	11,2	145	9.390	3	009500007
8	220	12,4	160	10.100	3	009500008
9	223	13,5	160	10.100	3	009500009
10	230	14,9	160	10.950	3	009500010
11	233	16,1	160	10.950	3	009500011
12	240	17,5	175	11.950	3	009500012
13	244	19,7	175	11.950	3	009500013
14	250	20,1	190	13.550	3	009500014
15	254	21,5	190	14.150	3	009500015
16	260	22,7	200	15.600	3	009500016
17	264	24,1	200	16.000	3	009500017
19	274	26,6	230	19.850	3	009500019
22	290	29,9	290	23.900	2	009500022
24	300	32,2	320	26.900	2	009500024
27	315	36,2	370	31.800	2	009500027



950/S9	Ft		
7-8-10-11-12 13-14-17-19 mm	114.700	1	009500079
950/S14	Ft		
6-7-8-9-10-11-12-13 14-15-16-17-19-22 mm	187.800	1	009500082

951 -ES TÍPUSÚ T-KULCSOK HATSZÖG ALAKÚ VÉGEKKEL



Amikor ezt a kulcsot még 1980-ban piacra dobták, forradalmiak számított. Nagy ellenállású csavarokkal végzett munkára tervezték, és neve összefort a gyors kezeléssel, a pontos illeszkedéssel és a rugalmas használhatósággal.

A hatszög alakú T-szár igény szerint állítható. A hatszög alakú végeket úgy tervezték, hogy a lehető legnagyobb nyomatékot továbbítsák a csavarra. A rúd hossza lehetővé teszi figyelemre méltó nyomaték könnyedén történő átadását a csavarokra.

A gyártás folyamatos fejlesztése többek között homokfúvott felületeket és éles szélű hatszög alakú végeket eredményezett, amelyek bármilyen csavarra pontosabb illeszkedést tesznek lehetővé, még sérült csavarok esetén is. A lézeres jelölés szilárdabb rudat eredményez.

A lézeres jelölés szilárdabb rudat eredményez.

Az új 951GP modellt a MotoGP és Superbike technikusaival és szerelőivel együttműködésben fejlesztettük ki, a be és kicsavarozási sebesség növelése érdekében.

951

T-szárú imbuszkulcs, krómozott



mm	L	L1	Ø	Ft		
2	125	63	4,0	8.580	5	009510521
2,5	150	63	4,0	8.580	5	009510525
3	150	63	4,0	8.580	5	009510530
3,5	175	76	5,5	8.870	5	009510535
4	175	76	5,5	8.870	5	009510540
4,5	195	87	6,5	9.720	5	009510545
5	195	87	6,5	9.720	5	009510550
6	215	99	8,0	11.150	5	009510560
7	230	109	9,0	11.950	5	009510570
8	250	122	10,0	11.950	5	009510580
9	265	132	11,0	15.200	5	009510590
10	280	142	12,0	15.200	5	009510610
12	305	160	15,0	20.450	3	009510620
14	330	178	17,0	24.500	3	009510640

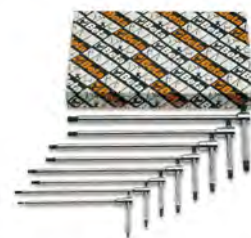

951/S6	Ft		
2,5-3-4-5-6-8 mm	58.800	1	009510687
951/S8	Ft		
2-2,5-3-3,5-4-4,5-5-6 mm	74.050	1	009510693
951/S14	Ft		
2-2,5-3-3,5-4-4,5 5-6-7-8-9-10-12-14 mm	173.200	1	009510695



951/SP6	Ft		
3-4-5-6-8-10 mm	75.200	1	009510696
951/SPV	Ft		
	13.750	1	009510697



951AS

T-szárú imbuszkulcs, a végeken hatszögprofil

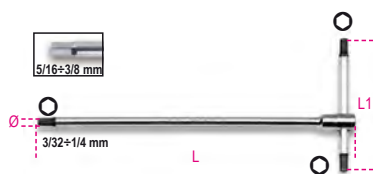

"	L mm	L1 mm	Ø mm	Ft	🔧	📦
3/32	125	63	4,0	11.550	2	009510750
7/64	150	63	4,0	11.550	2	009510751
1/8	150	63	4,0	11.550	2	009510752
9/64	175	76	5,5	11.950	2	009510753
5/32	175	76	5,5	11.950	2	009510754
3/16	195	86	6,5	13.150	2	009510755
7/32	215	99	8,0	13.150	2	009510757
1/4	230	109	9,0	14.950	2	009510758
5/16	250	122	10,0	15.200	2	009510759
3/8	280	142	12,0	18.400	2	009510760



951AS/S6X
1/8-3/16-7/32-1/4-5/16-3/8

Ft 86.450 1 009510771

9516P

T-szárú imbuszkulcsok

A Beta 9516P imbuszkulcs gyors és pontos munkavégzést tesz lehetővé.

A versenysportok világában fontos követelményeknek megfelelően terveztük, így nagy nyomaték mellett gyors csavarozást biztosít.

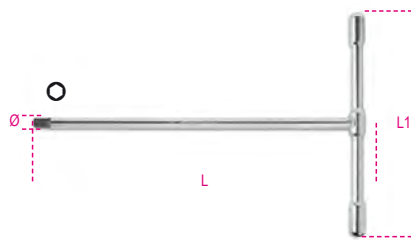

mm	L mm	L1 mm	Ø	Ft	🔧	📦
3	185	130	5	8.460	3	009511530
4	214	150	5	8.910	3	009511540
5	240	165	6	10.300	3	009511550
6	271	180	7	11.750	3	009511560
8	300	200	10	15.200	3	009511580
10	310	200	12	18.600	3	009511610



9516P/S6
3-4-5-6-8-10 mm

Ft 73.250 1 009511687

951TX

T-szárú imbuszkulcs, a végeken négyszögprofil Torx®-csavarhoz

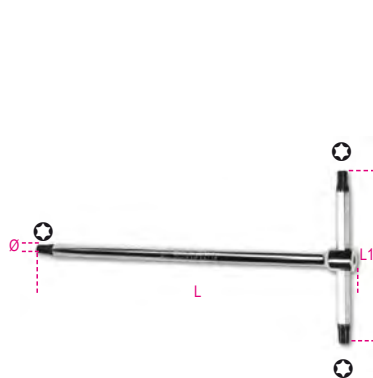

🔧	L mm	L1 mm	Ø mm	Ft	🔧	📦
T6	125	63	4	10.700	3	009510806
T7	125	63	4	10.700	3	009510807
T8	125	63	4	10.950	3	009510808
T9	125	63	4	10.950	3	009510809
T10	150	63	4	11.150	3	009510810
T15	150	63	4	11.150	3	009510815
T20	175	76	5	11.750	3	009510820
T25	175	76	5	11.750	3	009510825
T27	195	87	6	12.550	3	009510827
T30	195	87	6	12.550	3	009510830
T40	215	99	7	14.550	3	009510840
T45	230	109	8	15.400	3	009510845
T50	250	122	9	16.400	3	009510850

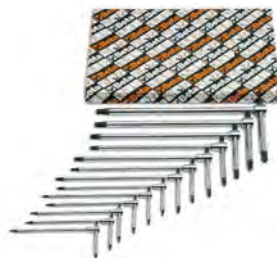

951TX/S6
T8-T10-T15-T20-T25-T30

Ft 69.250 1 009510866

951TX/S13
T6-T7-T8-T9-T10-T15-T20-T25
T27-T30-T40-T45-T50

Ft 160.500 1 009510863



952 -ES TÍPUSÚ T-KULCSOK CSUKLÓS HATSZÖG ALAKÚ DUGÓKULCSOKKAL

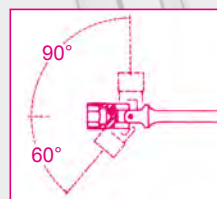

A kulcs sikerének titka a megbízható, pontos illesztés. A csukló sok éves használat alatt is megőrzi működését, nincs szükség beállításra. A dugókulcs forgási szöge: 60°.

Rögzített állásban 90°-ban is használható. Csúszó T-fogantyú, amely a rúd teljes hosszán bárhol megállítható a kívánt helyzetben. A fejen háromszoros méretjelölés található.

952

Csuklós T-kulcs, krómozott

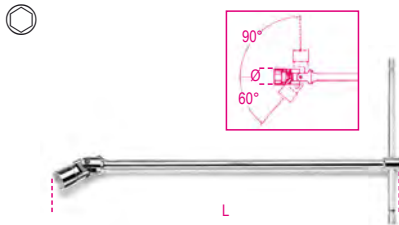

UNI 6743

Ø mm	Ø mm	L mm	Ft	🔧	📦
6	9,5	395	14.550	5	009520006
7	10,7	395	14.550	5	009520007
8	12,1	395	14.550	5	009520008
9	13,2	395	14.550	5	009520009
10	14,6	400	15.600	5	009520010
11	15,8	400	15.600	5	009520011
12	17,0	400	15.600	5	009520012
13	18,7	432	16.800	5	009520013
14	19,7	432	16.800	5	009520014
15	20,9	450	20.450	3	009520015
16	22,0	450	20.450	3	009520016
17	23,4	450	20.450	3	009520017
18	24,7	450	20.450	3	009520018
19	26,0	500	24.900	3	009520019
20	27,4	500	24.900	3	009520020
21	28,5	500	24.900	3	009520021
22	29,7	500	24.900	3	009520022
24	32,4	500	24.900	3	009520024



952/S7 8-10-11-13-14-17-19 mm	Ft 124.700	🔧	📦	1	009520074
952/S10 7-8-10-11-12-13-14-15-17-19 mm	Ft 175.300	🔧	📦	1	009520080
952/S18 6-7-8-9-10-11-12-13-14-15-16-17-18-19-20-21-22-24 mm	Ft 344.900	🔧	📦	1	009520083



952/D7 7-8-10-12-13-14-17 mm	Ft 114.400	🔧	📦	1	009520079
--	----------------------	---	---	---	-----------

852



852 1/4	Ft 79,85	🔧	📦	1	009520120
----------------	--------------------	---	---	---	-----------

952AS

Csuklós T-kulcs

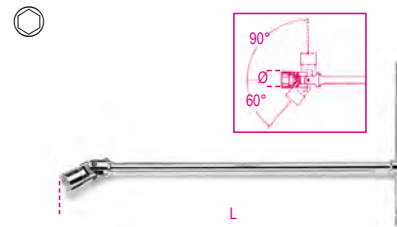

Ø mm	Ø mm	L mm	Ft	🔧	📦
1/4	9,5	395	15.800	2	009520256
5/16	12,1	395	15.800	2	009520258
3/8	14,6	400	17.000	2	009520260
7/16	15,8	400	17.000	2	009520261
1/2	18,7	432	19.250	2	009520263
9/16	19,7	432	20.450	2	009520264
5/8	22,0	450	21.850	2	009520266
11/16	23,4	450	21.850	2	009520267
3/4	26,0	500	27.100	2	009520269

952L

Csuklós T-kulcs, hosszított kivitel, krómozott

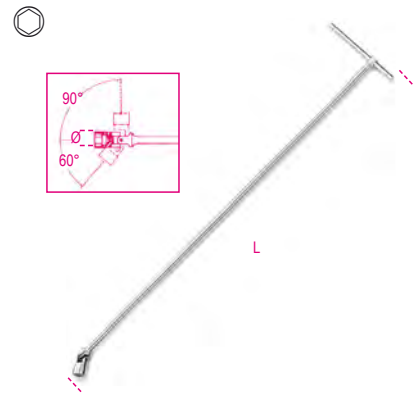

Ø mm	Ø mm	L mm	Ft	🔧	📦
10	14,6	930	39.650	1	009520410
12	17,0	1063	39.650	1	009520412
13	18,7	1100	39.650	1	009520413
14	19,7	1100	39.650	1	009520414
15	20,9	1100	44.550	1	009520415
16	22,0	1100	44.550	1	009520416
17	23,4	1100	44.550	1	009520417
18	24,7	1100	44.550	1	009520418
19	26,0	1100	51.600	1	009520419

952FTX

Csuklós Torx® T-kulcs, krómozott

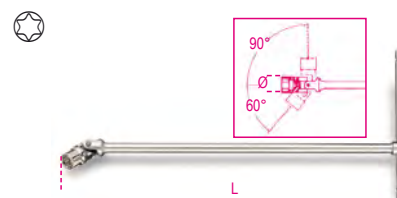

Ø mm	Ø mm	L mm	Ft	🔧	📦
E6	8	392	17.000	2	009520106
E7	9	392	17.000	2	009520107
E8	10	395	19.650	2	009520108
E10	13	400	20.050	2	009520110
E12	15	440	24.100	2	009520112
E14	17	490	29.350	2	009520114
E16	19	490	29.350	2	009520116
E18	21	490	29.350	2	009520118
E20	23	490	29.350	2	009520120



952FTX/S9 E6-E7-E8-E10-E12 E14-E16-E18-E20	Ft 215.200	🔧	📦	1	009520141
---	----------------------	---	---	---	-----------

953

Csuklós T-szárú imbuszkulcs, krómozott

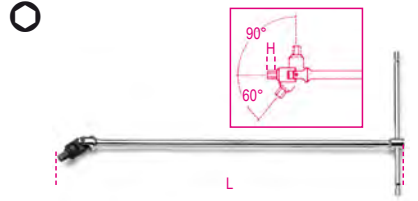

UNI 6754

mm	H mm	L mm	Ft	🔧	📦
3	5	395	14.950	5	009530130
3,5	6	395	14.950	3	009530135
4	6	395	14.950	5	009530140
4,5	7	395	14.950	3	009530145
5	7	395	14.950	5	009530150
6	9	400	16.000	5	009530160
7	10	425	17.800	3	009530170
8	11	425	17.800	5	009530180
10	13	440	21.250	5	009530200



953/S5 3-4-5-6-8 mm	Ft 78.750	🔧	📦	1	009530305
953/S9 3-3,5-4-4,5 5-6-7-8-10 mm	Ft 147.800	🔧	📦	1	009530301

953TX

Csuklós T-Torx®-imbuszkulcs, krómozott, fekete hegy

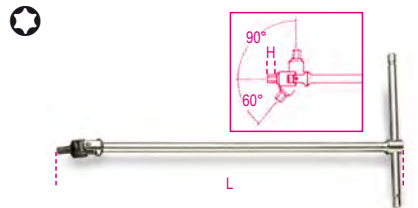

Ø mm	H mm	L mm	Ft	🔧	📦
T20	11	396	18.200	2	009530020
T25	11	396	18.200	2	009530025
T27	11	396	18.200	2	009530027
T30	13	400	20.050	2	009530030
T40	13	400	20.050	2	009530040
T45	13	426	20.450	2	009530045
T50	14	442	24.100	2	009530050
T55	14	442	24.300	2	009530055



953TX/S8 T20-T25-T27-T30 T40-T45-T50-T55	Ft 163.600	🔧	📦	1	009530060
---	----------------------	---	---	---	-----------

Járműjavító szerszámainkat, amelyeket a legigényesebb szakemberek használnak, a világ legmagasabb követelményeinek megfelelően fejlesztettük és gyártottuk, és rendszeresen teszteljük a legnagyobb terhelést jelentő üzemi körülmények között.

Több mint 50 éve büszkén dolgozunk együtt a legnagyobbakkal, akik segítenek termékeink folyamatos fejlesztésében és biztosítják a legmagasabb minőségi színvonalnak való megfelelést.

A járműjavító eszközök az alábbi szakaszokban találhatóak:

DIAGNOSZTIKA	1464T/N - 1465 1498SM - 1499 1758VT - 1760/IR 1600
MOTOR	955 - 960SN 1440 - 1462/KEP 1472 - 1485TC 1737 - 1759TT
OLAJ ÉS SZŰRŐK	1488/1 - 1496/C 1877 - 1889N
ELEKTROMOS RENDSZER	1489/33 - 1489Y 1497D - 1497RC
GYORSINDÍTÓK	1498BC/12 - 1498DG1100E
ERŐÁTVITEL	1884 - 1885/X C60 1438 - 1438DSG 1566N - 1569/F
FELFÜGGESZTÉS	1550U - 1567
FÉKEK	1466/C5 - 1471T/C5
KEREKEK	720MRC - 729T 962 - 989B 1530/C5 - 1531/C7
KAROSSZÉRIA	1065F5 - 1068 1302 - 1369/C11 1478 - 1479U/32 1505V - 1539 1763 - 1768
EGYÉB BERENDEZÉSEK	1875LT - 3067
EMELÉSTECHNIKA	3006 - 3069

955 Gyertyakulcs, krómozott, hatlapú



mm - "	D mm	L mm	Ft	3	009550016
16	21	86	7.410		
5/8					

956C 1/2"-os gyertya-dugókulcs, krómozott, hatlapú



ISO 11168

mm - "	D mm	L mm	Ft	3	009560008
14	18,8	70	13.750		
9/16					
16	21,4	70	13.750	3	009560010
5/8					
17,8	23,6	70	13.750	3	009560011
11/16					
20,8	27,0	70	13.750	3	009560012
13/16					

956E 3/8"-os gyertya-dugókulcs, krómozott, hatlapú



ISO 11168

mm - "	D mm	L mm	Ft	3	009560018
14	18,8	70	15.200		
9/16					
16	21,4	70	15.200	3	009560020
5/8					
17,8	23,6	70	15.200	3	009560021
11/16					
20,8	27,0	70	15.200	3	009560022
13/16					

956F dugókulcs 3/8" négyzögű belső csatlakozóval gyújtógyertyákhoz

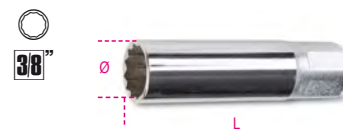

mm - "	Ø mm	L mm	Ft	1	009560114
14	18,8	70	17.000		
9/16					
16	20,5	70	20.850	1	009560116
5/8					

956L 1/2"-os gyertyakulcs, tizenkétszög-profil, hosszított kivitel



mm - "	Ø mm	L mm	Ft	2	009560214
14	19,0	250	28.350		
9/16					
16	21,0	250	29.150	2	009560216
5/8					

957 Rövid csuklós T-gyertyakulcs, krómozott

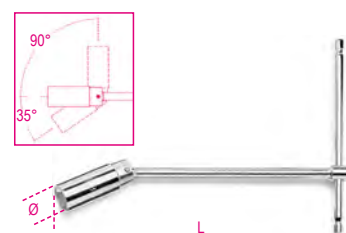

ISO 11168

mm - "	D mm	L mm	Ft	3	009570000
16	21,4	275	21.250		
5/8					
20,8	27,0	275	24.900	3	009570001
13/16					



959

Csuklós T-gyertyakulcs, krómozott

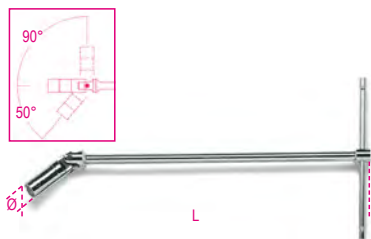

ISO 11168

mm -"	D mm	L mm	Ft	📦	📄
14 9/16	18,8	483	24.700	3	009590009
16 5/8	21,4	483	27.300	3	009590010
20,8 13/16	27,0	527	36.450	3	009590011

959R

Rugós gumibetét a 956C-956E-957-959-hez

	Ft	📦	📄
959R/14 956C/14-956E/14	2.530	3	009590223
959R/16 956C/16-956E/16 957/16-959/16	2.530	3	009590224
959R/17,8 956C/17,8-956E/17,8	2.530	3	009590225
959R/20,8 956C/20,8-956E/20,8 957/20,8-959/20,8-959L	2.530	3	009590226

960A

1/2"-os nyitott dízel porlasztócsúcs kiesző dugókulcs, krómozott, tizenkétszögű

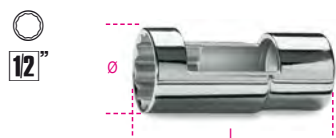

mm	D mm	L mm	Ft	📦	📄
27	36,5	77	23.500	2	009600017

960ER

csúszókalapácsos szerszám befecskendező alátétek kiszéréséhez lépcsős fúrészár

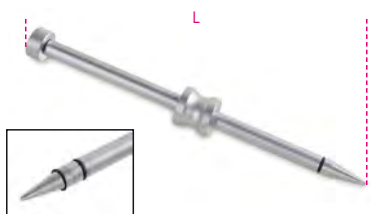

L mm	Ft	📦	📄
350	28.750	1	009600726

960SL

1/2"-os lambda-szonda dugókulcs, krómozott, nyitott hatlapú fej



	Ø mm	Ft	📦	📄
960SL 85 ○ 22xL= 85 mm	33	27.950	2	009600085
960SL 110 ○ 22xL= 110 mm	33	31.550	2	009600110

960SN

Izzítógyertya kulcs dízel motorokhoz, krómozott



mm	D mm	□	L mm	Ft	📦	📄
8	12,0	1/4	60	23.700	2	009600834
9	13,3	1/4	60	23.700	2	009600835
10	14,5	3/8	70	28.150	2	009600836

960T/C11

dugókulcs készlet érzékelők eltávolításához/beszereléséhez

Készlet tartalma:

- 1 kétoldalas hatlapú dugókulcs, méret: 1" - 11/16" olajnyomás érzékelőkhöz
- 1 nyitottvégű hatlapú dugókulcs, 29 mm, oxigénérzékelőkhöz
- 1 nyitottvégű tizenkétszögű dugókulcs, 27 mm, injektorokhoz
- 1 nyitottvégű hatlapú dugókulcs, 22 mm, vákuumkapcsolókhöz
- 1 nyitottvégű hatlapú dugókulcs, 22 mm, 80 mm hosszú, oxigénérzékelőkhöz
- 1 nyitottvégű hatlapú dugókulcs, 22 mm, 90 mm hosszú, oxigénérzékelőkhöz
- 1 nyitottvégű hatlapú dugókulcs, 22 mm, kompakt, 30 mm hosszú, oxigénérzékelőkhöz
- 1 nyitottvégű hatlapú dugókulcs, 22 mm, kompakt, 50 mm hosszú, oxigénérzékelőkhöz
- 1 nyitottvégű hatlapú és tizenkétszögű dugókulcs, 22 mm, kompakt, 34 mm hosszú, oxigénérzékelőkhöz
- 1 nyitottvégű hatlapú dugókulcs, 22 mm, cső formájú
- 1 menetfúró M18x1,5



○ 22 - 29 mm

	Ft	📦	📄
960T/C11 ≡ 330x270x25 mm	92.100	1	009600031

960/C6

3/8" dugókulcsok kipufogógáz hőmérséklet érzékelő szenzor eltávolításához/beszereléséhez

Készlet tartalma:

- 3 rövid, 13, 14, 17 mm
- 3 hosszú, 13, 14, 17 mm



	Ft	📦	📄
960/C6 ≡ 170x120x50 mm	39.050	1	009600055

960AVE

Dízel porlasztócsúcs vizsgáló Common Rail rendszerhez



	Ft	📦	📄
960AVE ≡ 430x310x50 mm - 2,0 kg	124.300	1	009600245

960EPC/L

izzítógyertya elektródavég lehúzó készlet

M8x1 - M9x1 - M10x1 - M10x1.25



	Ft	📦	📄
960EPC/L ≡ 270x230x80 mm - 2 kg	408.500	1	009600890

960E-PI/P

befecskendezőalátét lehúzó

- M10 menetes csavar a csúszókalapácsos lehúzóval (Beta 1540) történő használathoz



960E-PI/P Ft 32.000 1 009600706
 300x90x60 mm

960KC-M8/M9/M10

Szerszámkészlet törött és sérült izzítógyertya szereléséhez

- Gyertyamenetek: M8-M9-M10



960KC-M8/9/10 Ft 206.500 1 009600801
 380x290x50 mm - 2,3 kg

960KPC

Izzítógyertya Vibro-kihajtó, jobbos és balos, beállítható nyomaték

1/4"
CE



960KPC Ft 148.900 1 009600780
 8-9-10-11-12 mm
 420x185x60 mm - 2,8 kg

960UC

szerszám készlet beszorult, deformált hegyű izzítógyertyák kihúzásához M8-M9-M10



960UC Ft 236.800 1 009600900
 270x230x80 mm - 2,6 kg

960P

Vákum és nyomásmérő pisztoly tartozékkal és adapterekkel



960P Ft 122.700 1 009600777
 350x320x95 mm - 1,9 kg

960PI

Injektor fészekmaró készlet műanyagdobozban

- Injektor fészek tisztításához
- Fészekmaró Ø 19 - 15 mm injektorokhoz
 - Fészekmaró Ø 17 - 17 mm Delphi/Bosch (BMW/PSA/Renault/ Ford) injektorokhoz
 - Fészekmaró Ø 19 - 17 mm Bosch (Mercedes CDI) injektorokhoz
 - Sarokmaró Ø 21 - 17 mm Fiat/Iveco injektorokhoz
 - Nyél



960PI Ft 57.100 1 009600215
 250x130x50 mm - 600 g

960PI/C19

19 darabos szerszámkészlet befecskendező fészek tisztításához

A készlet a következőket tartalmazza:

- 11 lapos furatköszörű, Ø: 14/14 mm - 15,5/15,5 mm - 15/19 mm - 17/19 mm - 17/17,5 mm - 17/19 mm - 17/19,5 mm - 17/20 mm - 18/21 mm - 19 mm - 20/21 mm
- 4 sarok furatköszörű, Ø: 15,5/15,5 mm - 17/17 mm - 17,5/20,5 mm - 17/21 mm
- Markolat és tartozékok csiszolók használatához



960PI/C19 Ft 142.900 1 009600217
 360x230x60 mm

960PI/K36

Injektorfészek-tisztító kefékészlet

1/4"



DIN 3126 E6,3

960PI/K36 Ft 89.850 1 009600218
 350x255x74 mm - 1253 g

960PI/S

befecskendező fészek tisztító készlet

A készlet a következőket tartalmazza:

- 3 db acélkefe, Ø 18, 22, 25 mm, a befecskendező fészek tisztításához
- 2 db kefe, Ø 14 és 16 mm, a befecskendező fészek alapos tisztításához
- 6 db égéstéri furat lezáró dugó
- 1 db csőkefe égéstéri furat tisztításához
- 1 db rugalmas bittartó markolattal



960PI/S Ft 75.500 1 009600214
 360x140x50 mm - 700 g

960VTC

hengerfej szívárgásvizsgáló
benzinmotorhoz

miután a hengerbe sűrített levegőt juttatunk, a mérőműszer
kimutatja az esetleges szívárgást



960VTC	Ft		
	131.600	1	009600261
373x295x70,6 mm - 2,3 kg			

960RPI

fúvó eszköz befecskendező fészek
tisztításához

A következő izzítógyertyákkal szerelt motorokhoz
M8x1 - M9x1 - M10x1 - M10x1.25



960RPI	Ft		
	91.100	1	009600940

960PMC

Dízel porlasztócsúcs vizsgáló
készülék, könnyűfém test,
ütésálló műanyagtartály



Bar max.	Ft		
600	359.500	1	009600200

961N

Elektronikus videószkóp
hajlékony, elforgatható szondával

- 5" TFT LCD kijelző
- SD kártyával bővíthető
- Videó- és képrögzítés
- 4 LED
- USB csatlakozó (beépített akkumulátor)
- Elforgatható szonda
- Nagy felbontás



CE

MŰSZAKI ADATOK

- Maximális felbontás: 1920X1080
- Szonda hossza: 1500 mm
- Kameraátmérő: 6 mm
- Videóformátum: AVI
- Képfarmátum: JPEG
- Látószög: 0+180°
- Szonda elforgathatósága: 0+360°
- Szonda védettségi szint: IP67
- Adatkimenet: USB-C kábel és SD kártya
- Tápegység: 3,7V 2000 mAh akkumulátor

961N	Ft		
	213.800	1	009610030

961P6/S

hajlékony szonda, 6 mm
a 961p6-os videószkóphoz



	L mm	Ft		
961P6/S 1	1000	153.000	1	009610006
961P6/S 2	2000	171.700	1	009610262
961P6/S 3	3000	193.900	1	009610263

962

Gumiabroncs szerelővas, krómozott



L mm	A mm	Ft		
300	21	11.350	5	009620003
400	25	13.550	5	009620004
500	27	17.600	3	009620005
600	27	22.850	3	009620006

962C



962C				270
------	--	--	--	-----

962P

gumiabroncs szerelővas
gumi karcolásvédővel



L mm	A mm	Ft		
490	25	42.700	1	009620049

962M

gumiabroncs leszerelő/felszerelő eszköz

különösen alkalmas Runflat és
alacsony vállú gumi típusokhoz

- karcolásvédő befogópofák a tárcsákra rögzítéshez
- fészek a gumiabroncs szerelővas elhelyezésére



962M	Ft		
	153.000	1	009620501

963

Feszítővas hegyes
és hajlított lapos véggel



L mm	A mm	Ft		
400	23	17.400	5	009630001

964

Feszítővas hegyes és emeltyűs
véggel



L mm	A mm	Ft		
400	46	15.800	5	009640001

965

Feszítővas nyéllel



L mm	A mm	L1 mm	Ft		
300	16	185	8.060	2	009650013
450	20	312	11.350	2	009650014
600	20	462	13.350	2	009650016





965/S3 Ft 32.750 1 009650019

966/C3

3 darabos feszítővas készlet, széles és hajlított állítható fejjel

- 200°-kal elfordítható fej
- A kiválasztott pozíciót automatikusan rögzíti



966/C3 Ft 60.300 1 009660103
L=200-250-300 mm
355x140x65 mm - 1,8 kg

720LS

Gépi dugókulcs hosszú és keskeny kivitel



720LS 36 Ft 28.150 2 007200386
D L Ø1
mm mm mm mm

969B

Kerékgyszerező dugókulcs

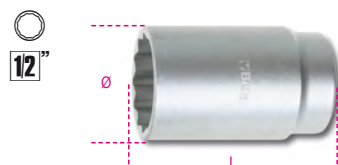

Ø mm	Ø mm	L mm	Ft	1	009690124
24	36,0	76	10.100	1	009690124
27	36,0	76	10.300	1	009690127
30	40,0	76	10.700	1	009690130
31	42,0	76	11.150	1	009690131
32	42,5	76	11.750	1	009690132
34	45,0	76	13.150	1	009690134
35	46,0	76	13.350	1	009690135
36	49,0	76	15.400	1	009690136



969/C5

5 darabos dugókulcskészlet kerékagy szereléséhez műanyag kofferban



969/C5 Ft 64.350 1 009690201

969B 30-32-34-35-36

970B

Kerékgyszerező dugókulcs Fiat Daily

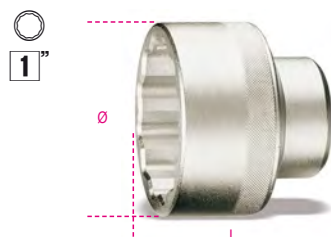

970B Ft 49.800 1 009700010
Ø mm 65
Ø mm 88
L mm 75

970IVECO

körmös dugókulcs
Iveco Daily kerékagy anyaghoz
2014-es és későbbi modellekhez

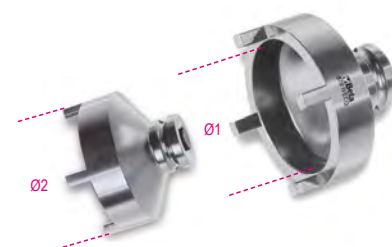

970IVECO Ft 30.150 1 009700011
Ø1 mm 61,5
Ø2 mm 74,8

971/C8

nyomatéksavarhúzó tartozékokkal a guminyomás ellenőrző rendszerrel rendelkező gumiabroncs szelepek ellenőrzött meghúzásához



971/C8 Ft 189.300 1 009710108

583/6	1,2+6 Nm
892/0	
862TX	T10-T15-T20
900L	11-12 mm
986 78	

972/C4BMW

sérült kerékőr leszerelő készlet BMW és Mini gépjárművekhez



972/C4 BMW Ft 109.700 1 009720004

516x145x66 mm - 3,8 kg

972/C10

sérült kerékanya leszedő készlet

biztonsági és hagyományos anyákhoz



972/C10 Ft 138.500 1 009720010

290x250x60 mm - 2,4 kg



973

4 db gumiabroncs tároló zsák

a következő felíkhöz:
14" ÷ 18" cikkszám 009730014
19" ÷ 22" cikkszám 009730019



- megvédi az abroncsot a karcosítástól és portól
- megakadályozza a nyári és téli gumik polimerjeinek korai fáradását tárolás során
- a kerékabroncs pozíció azonosítását segítő ikon (bal/jobbs első/hátsó)
- hordozófüllel
- anyag: mosható nejlón

	Ft		
973 14-18	48.400	1	009730014
973 19-22	53.650	1	009730019

978 - 979

Keresztkulcs, hatlapú

12"

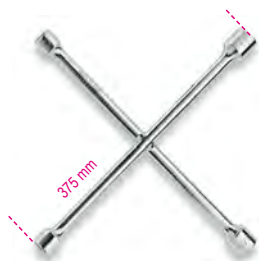

UNI/ISO 6788 DIN 3119

	Ft		
978 17x19x21x22 mm	30.750	2	009780001
979 17x19x22x1/2 mm	30.750	2	009790001

982

Keresztkulcs, hatlapú, krómozott

34"



UNI/ISO 6788 DIN 3119

	Ft		
24x27x32x3/4 mm	74.300	1	009820001

983PM

dörzskéfe kerékagy tisztításhoz

14"

12"



Ø1 mm	Ø2 mm	Ft		
90	150	35.800	1	009830010

983 PM/R-DA

csiszolókorong pár a 983PM modellhez



Ø mm	Ft		
150	33.200	1	009830050

984

műanyag kerékanya burkolat fogó



L mm	H mm	Ft		
195	4	12.350	1	009840005

985/B7

7 db vezetőcsap készlet kerék szereléshez

- Méretetek:
- M12X1,25 külső
 - M12x1,25 belső
 - M12x1,5 külső
 - M12x1,5 belső
 - M14x1,25 külső
 - M14x1,5 külső
 - M16x1,5 külső



C985/B7	Ft		
	47.550	1	009850007

985M

külső vezetőcsap kerék szereléshez



	L mm	Ft		
985M M12X1,25	150	6.190	1	009850101
985M M12X1,50	150	6.190	1	009850102
985M M14X1,25	150	6.400	1	009850103
985M M14X1,50	150	6.400	1	009850104
985M M16X1,50	150	7.040	1	009850105

985F

belső vezetőcsap kerék szereléshez



	L mm	Ft		
985F M12X1,25	150	8.300	1	009850106
985F M12X1,50	150	8.790	1	009850107

986 48

Szelepbehúzó szerszám, rövid kivitel

Automatikus szelepbehúzás



L mm	L1 mm	Ft		
18	48	7.040	1	009860048

986 78

Szelepbehúzó szerszám

Automatikus szelepbehúzás



L mm	L1 mm	Ft		
18	78	7.040	1	009860078



986PT

előkalibrált csavarhúzó 0,4 Nm
gumiabroncs szelepekhez

automatikus szelep megtartás
a csúszómechanizmus lehetővé teszi,
hogy ne sérüljön a szelep
magjának tömitése



L mm	L1 mm	Ft		
19	120	24.700	1	009860140

987

Gumiabroncs túszelep szerelő szerszám, védő
gumibevonattal



L mm	Ft		
310	14.550	1	009870001

987AR

gumiabroncs szelep szerelőszerszám
karcolásvédő bevonattal

- gumi és nylon talp
ötvezőtt és vas kerékabroncsokhoz
- gyors szelepcsatlakozó,
nincs szükség becsavarásra



L mm	Ft		
305	47.550	1	009870021

987P

Gumiabroncs túszelep szerelő szerszám,
műanyagból

A szerelés közben a szelepet megtartja



L mm	Ft		
335	11.950	1	009870011

988/K4

4 darabos vésőkészlet kemény műanyagból

- Különösen alkalmas az ólomsúly eltávolításához a
könnyűfémfelnikről
- 3 vágóéllel sokoldalú felhasználást biztosít



988/K4	Ft		
A= 19-21-25-38 mm	12.750	1	009880104

989

Keréksúlyszerelő fogó, krómozott



L mm	Ft		
250	22.850	2	009890001

989A

keréksúlyszerelő fogó öntapadó súlyokhoz



A befogó pófa úgy van kialakítva,
hogy a súlyok eltávolítása során az abronccsal ne érintkezzen

989A	L mm	Ft	
	220	15.600	1 009890011

989B

keréksúlyszerelő
kombinált fogó

funkciók:

- öntapadó súlyok eltávolítása fém felnikről
- súlyok eltávolítása vas felnikről
- levehető PE-HD fejű kalapács öntapadó súlyokhoz és
vasfelnikhez
- keréksúly fogó pófák acélfelnikhez



L mm	Ft		
230	29.550	1	009890015

990

Egyenes csipesz lekerekített
heggyel, fogazott, rozsdamentes
acélból, polírozott



L mm	Ft		
130	5.670	5	009900001

991

Hajlított végű csipesz lekerekített
fogazott heggyel, rozsdamentes
acélból, polírozott



L mm	Ft		
130	6.800	5	009910001

992

Egyenes csapos csipesz
lekerekített fogazott heggyel,
rozsdamentes acélból, polírozott



L mm	Ft		
150	7.170	5	009920001

993

Hajlított végű csapos csipesz
lekerekített fogazott heggyel,
rozsdamentes acélból, polírozott



L mm	Ft		
145	7.690	5	009930001

993PL

Műanyag bevonatú hajlított csipesz
fogazott rozsdamentes acélból,
PVC-bevonattal



L mm	Ft		
150	7.690	3	009930010



993G

Hajlított csapos csipesz sarkított, lekerekített, fogazott hegygel, rozsdamentes acélból, polírozott



L mm 160 Ft 7.040 3 009930030

994

Egyenes csipesz, erősen lekerekített, fogazott hegygel, rozsdamentes acélból polírozott



L mm 150 Ft 5.870 5 009940001

994PL

Műanyag bevonatú egyenes csipesz erősen lekerekített fogazott hegygel, rozsdamentes acélból, PVC-bevonattal



L mm 150 Ft 7.040 3 009940010

994TF

Egyenes csipesz teflonbevonattal, nem mágneses, saválló, erősen lekerekített, fogazott hegygel, rozsdamentes acélból, polírozott



L mm 150 Ft 9.390 3 009940020

996

Szélesfejű csipesz rozsdamentes acélból, polírozott



L mm 150 Ft 6.230 5 009960001

998

Önzáró csipesz, fogazott, rozsdamentes acélból, polírozott



L mm 155 Ft 10.700 5 009980001

999

Csipesz, nem mágneses, saválló, lapos lekerekített hegygel, rozsdamentes acélból, polírozott



L mm 115 Ft 8.540 3 009990011

999A

Egyenes csipesz, nem mágneses, saválló, hegyes végű, rozsdamentes acélból, polírozott



L mm 120 Ft 7.410 3 009990015

999B

Egyenes csipesz, nem mágneses, saválló, keskeny hegyű, rozsdamentes acélból, polírozott



L mm 120 Ft 7.570 3 009990017

999C

Egyenes csipesz, nem mágneses, saválló, tűhegyes, rozsdamentes acélból, polírozott



L mm 110 Ft 8.300 3 009990019

999D

Hajlított csipesz, nem mágneses, saválló, tűhegyes, rozsdamentes acélból, polírozott



L mm 115 Ft 9.150 3 009990021

999E

Hajlított csipesz, nem mágneses, saválló, keskeny hegygel, rozsdamentes acélból, polírozott



L mm 120 Ft 8.300 3 009990023

999G

Egyenes csipesz, nem mágneses, saválló, záró-szerkezettel, tűhegyes, rozsdamentes acélból, polírozott



L mm 140 Ft 8.300 3 009990027

999/B6N

6 darabos csipeszkészlet, saválló, nem mágneses



Ft 53.300 1 009990060
999-B6N
999-999A-999B
999C-999D-999E

1002

önzáró fogó lekerekített, recézett pofával, rozsdamentes acélból



L mm 160 Ft 13.350 2 010020001

1008

Hosszú laposfogó
PVC-bevonattal



ISO 5745

L mm	L1 mm	Ft		
160	51,5	12.350	5	010080006

1008BM

Hosszú laposfogó, krómozott,
gumibetétes műanyag nyéllel



ISO 5745

L mm	L1 mm	Ft		
160	51,5	14.950	3	010080036

1009

Extra hosszú, félkerekcsőrű műszerészfogó
kétrétegű csúszásmentes PVC-bevonattal



ISO 5745

L mm	L1 mm	Ft		
160	56,5	12.350	2	010090006

1009L/A

Extra hosszú, egyenes, félkerekcsőrű
műszerészfogó, különleges munkákhoz
PVC-bevonattal



L mm	L1 mm	Ft		
283	80	14.950	2	010090008

1009L/B

Extra hosszú 45°-os hajlított,
félkerekcsőrű műszerészfogó
Különleges munkákhoz
PVC-bevonattal



L mm	L1 mm	Ft		
273	73	15.200	2	010090009

1009L/C

Extra hosszú 90°-os hajlított,
félkerekcsőrű műszerészfogó,
különleges munkákhoz
PVC-bevonattal



L mm	L1 mm	Ft		
253	45	16.000	2	010090010

1009L/D

extrahosszú, félkerekcsőrű recézett
műszerészfogó kettős csuklóval
kétrétegű, csúszásgátló PVC bevonatú nyéllel



L mm	L1 mm	Ft		
342	71	17.800	1	010090058

1009L/DP

extrahosszú, 45° hajlított félkerekcsőrű,
recézett, kétcsuklós műszerészfogó
2 réteg csúszásmentes PVC bevonatú nyéllel



L mm	L1 mm	Ft		
336	66	17.800	1	010090059

1009L/DP-S2

Kettős működésű, extra hosszú, félkerekcsőrű
2 darabos fogókészlet, recézett pofa



1009L/DP-S2	Ft		
	35.600	1	010090060

1010

Hosszú kerekcsőrű fogó
PVC-bevonattal



ISO 5745

L mm	L1 mm	Ft		
160	51,5	12.350	2	010100006

1010BM

Hosszú kerekcsőrű fogó, krómozott,
gumibetétes műanyag nyéllel



ISO 5745

L mm	L1 mm	Ft		
160	51,5	14.950	2	010100036



TÖKÉLETES ILLESZTÉS

A tesztek kimutatták, hogy vállalatunk kizárólagos, hidegen sajtolt, különleges fordított kúpos kialakításának köszönhetően a Seeger-gyűrűk (rögzítőgyűrűk) kiválóan illeszkednek a Beta Seeger-fogóiba.



NEHEZEBBEN TÖRŐ CSÚCSOK

A hidegen sajtolt csúcsoknak köszönhetően a Beta fogók a versenytársak hasonló termékeihez képest nagyobb tartósságot biztosítanak munka közben és véletlen leesés esetén is.



1031/S4

4 darabos Seeger-fogó készlet



1031/S4	Ft	1	010310000
1032 180	19 ÷ 60 mm		
1034 170	19 ÷ 60 mm		
1036 175	19 ÷ 60 mm		
1038 175	19 ÷ 60 mm		

1032

Egyenes belső Seeger-fogó, barnított, PVC-bevonattal



UNI 7914 DIN 5256

L mm	∅ mm	Ft	5	010320013
140x0,9	8÷12	11.550		
140x1,3	12÷25	11.350		
180	19÷60	12.350		
225	40÷100	15.200		
300	85÷200	21.250		

1033

45°-os hajlított belső Seeger-fogó, barnított, PVC-bevonattal



UNI 7914 DIN 5256

L mm	∅ mm	Ft	5	010330013
140x0,9	8÷12	13.150		
140x1,3	12÷25	12.750		
180	19÷60	13.350		
225	40÷100	16.400		

1034

90°-os hajlított belső Seeger-fogó, barnított, PVC-bevonattal



UNI 7914 DIN 5256

L mm	∅ mm	Ft	5	010340013
130x0,9	8÷12	13.150		
130x1,3	12÷25	12.750		
170	19÷60	13.350		
210	40÷100	16.400		
290	85÷200	23.500		

1034L

90°-os hajlított hosszúsórú Seeger-fogó, krómozott, PVC-bevonatú nyéllel



L mm	∅ mm	Ft	2	010340320
190	40÷100	33.600		

1036

Egyenes külső Seeger-fogó, barnított, PVC-bevonattal



UNI 7915 DIN 5254

L mm	∅ mm	Ft	5	010360013
140x0,9	3÷10	12.550		
140x1,3	10÷25	12.350		
175	19÷60	12.750		
225	40÷100	16.000		
300	85÷200	25.100		

1037

45°-os hajlított külső Seeger-fogó, barnított, PVC-bevonattal



UNI 7915 DIN 5254

L mm	∅ mm	Ft	5	010370013
140x0,9	3÷10	13.950		
140x1,3	10÷25	13.350		
175	19÷60	13.950		
225	40÷100	17.200		

1038

90°-os hajlított külső Seeger-fogó, barnított, PVC-bevonattal



UNI 7915 DIN 5254

L mm	∅ mm	Ft	5	010380013
135x0,9	3÷10	13.950		
135x1,3	10÷25	13.350		
175	19÷60	13.950		
220	40÷100	17.200		
300	85÷200	27.100		

1039

Egyenescsőrű állítható, külső, belső Seeger-fogó, barnított, PVC-bevonattal



L	∅ mm	∅ mm	Ft	📦	🏠
150	10÷15	6÷25	29.350	2	010390015

1558/C4

belső és külső seeger gyűrűkhöz használható szerszám csavaros működéssel

a négyszög csatlakozónak köszönhetően mindkét használati módban nagy erőt alkalmazás történik
Szállított hegyek:
∅ 2,5-3-3,5 mm



∅ mm	∅ mm	Ft	📦	🏠
1558/C4 5,5 ÷ 77	5,5 ÷ 77	79.350	1	015580100

330x220x50 mm - 900 g

1044N

Vízpumpafogó, barnított, villás csúszásálló PVC bevonattal

• 8 állású modell



L	A max	L1	Ft	📦	🏠
250	46	48	13.550	5	010440025

1047

Vízpumpafogó, stifttel állítható, dupla csúszásálló PVC-bevonattal

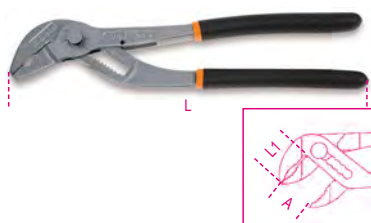

L	A max	L1	Ft	📦	🏠
180	30	29	19.850	2	010470180
240	36	35	21.250	2	010470240
300	50	48	30.550	1	010470300

1048N

POLIGRIP VÍZPUMPAFOGÓ

KIEMELKEDŐ FOGÁS ÉS EGYEDÜLÁLLÓAN KÖNNYŰ KEZELHETŐSÉG



- A fogak kialakítása miatt jobb fogás a kerek, illetve hatszögletű felületeken
- Az indukciós edzésű fogak tartósabbak
- A fej/ markolat közötti nagyobb szög jobb ergonomikus fogást tesz lehetővé
- Becsípődés elleni védelem a balesetek megelőzésére
- Innovatív, csúszásmentes, PVC bevonatú nyél
- A markolat nagyobb érintkezési felülete páratlanul könnyű fogást és kényelmet biztosít



1048N

vízpumpafogó, csúszásmentes PVC bevonatú nyéllel



ISO 8976

L	A max	L1	S	Ft	📦	🏠
175	36	31	11	14.550	3	010480910
250	46	38	13	15.600	5	010480915
300	60	44	14.8	23.050	2	010480920
400	96	81	19	36.050	1	010480940

1048N/D3

vízpumpafogó készlet

foszfátózott fej



1048N/D3	Ft	📦	🏠
175-250-300 mm	53.250	1	010480923

1048BM

Vízpumpafogó, villás, bimateriál nyél

- Új modell új pozíciókkal
- Bimateriál-nyél



ISO 8976

L	A max	L1	Ft	📦	🏠
250	48	39	20.850	3	010480215

1048VN

vízpumpafogó, állítható, narancssárgára lakkozott



ISO 8976

L	A max	L1	Ft	📦	🏠
175	36	31	12.350	3	010480111
250	46	38	13.950	5	010480116
300	60	44	20.450	2	010480121

1050

Kettős állítású önzáró fogó, krómozott

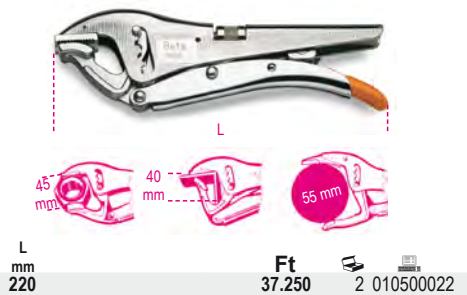

1051XL

Kettős állítású önzáró fogó, széles tartományú, extrahosszú pofa



1055

Ívelt pofájú önzáró fogó, krómozott, speciális pofaprofil

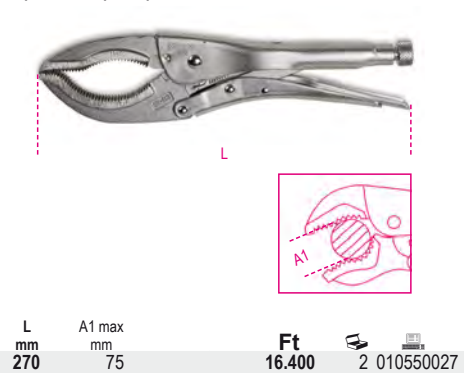

1051

Kettős állítású önzáró fogó, hosszú kivitel, krómozott

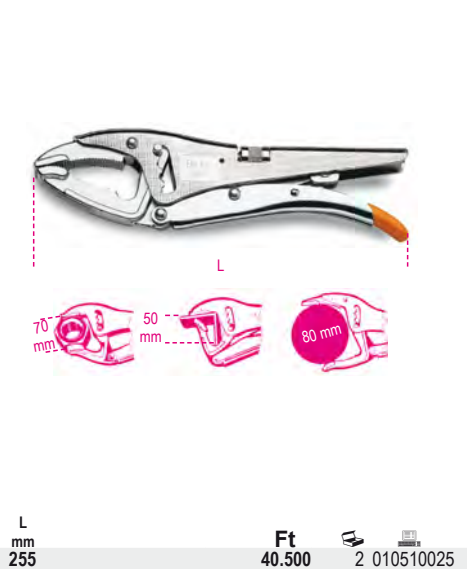

1052

Állítható önzáró fogó, homorú pofájú, krómozott

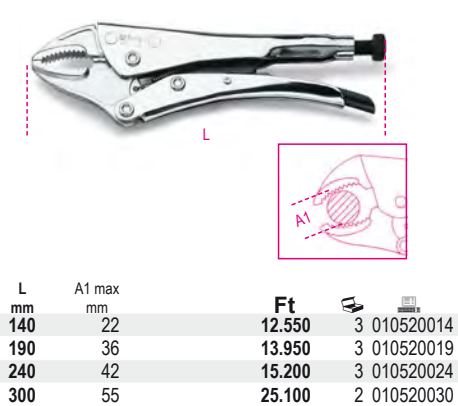

1055D

Állítható önzáró fogó, anyacsavarokhoz és hengeres profilokhoz

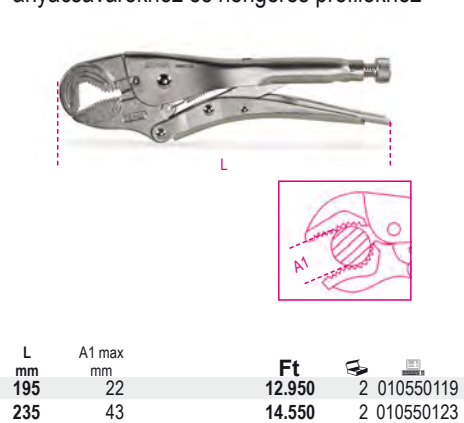

10516M

Kettős állítású önzáró fogó, önbeálló fej, krómozott

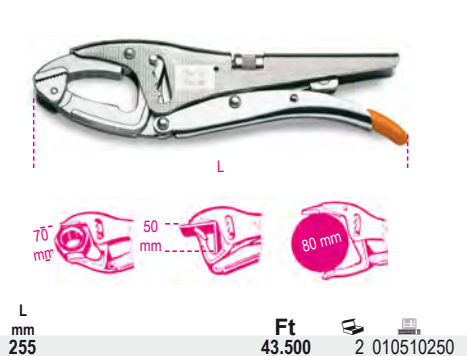

1053

Önbeálló pofájú önzáró fogó, krómozott

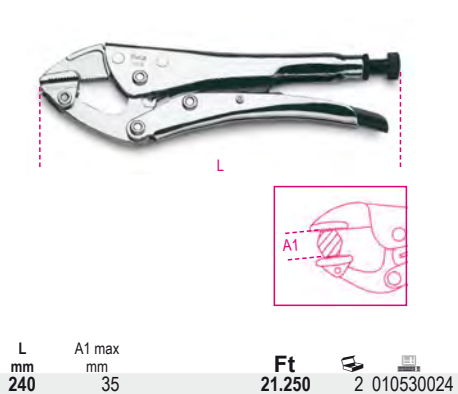

1056

Állítható hűtőszerelő önzáró fogó

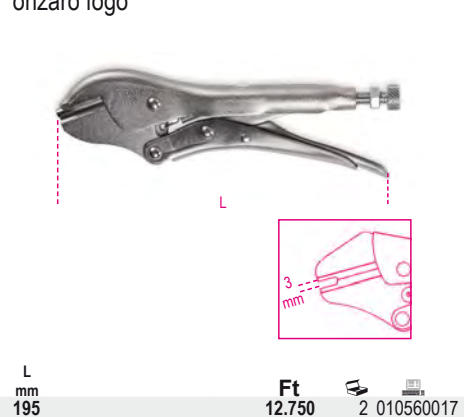

1051L

Kettős állítású önzáró fogó, széles tartományú

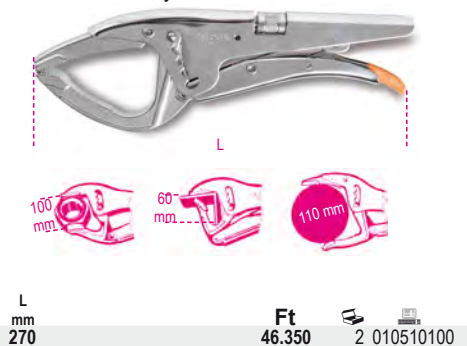

1054

Egyenes pofájú önzáró fogó, krómozott

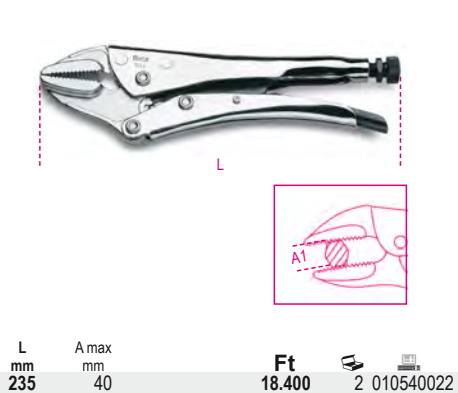

1057A

Önzáró fogó szabályozható feszítőerővel

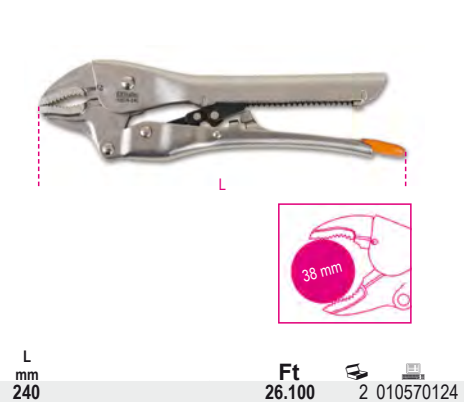

1058

Hosszú pófájú önzáró fogó, krómozott

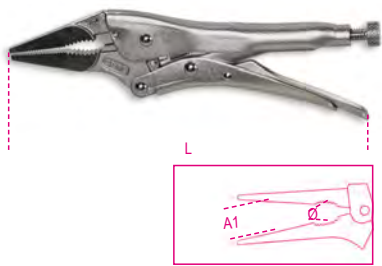

L mm	A1 max mm	Ø max mm	Ft	🔧	📦
175	34	26	15.800	2	010580017
225	46	31	19.000	2	010580025

1059

Csúszópofás önzáró fogó, krómozott

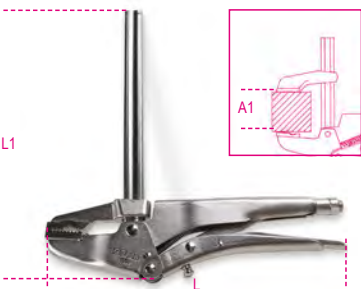

L1 mm	L mm	A1 mm	Ft	🔧	📦
160	255	120	28.350	1	010590016
270	255	220	29.550	1	010590027

1060

Hegesztőfogó szögvashoz, krómozott

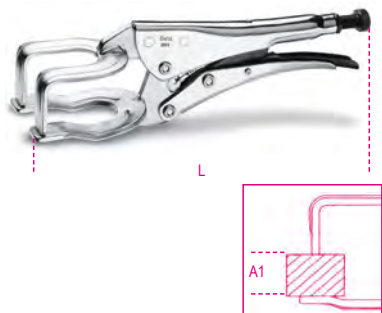

L mm	A1 max mm	Ft	🔧	📦
200	50	20.050	2	010600020
280	80	25.300	2	010600028

1061

Csőhegesztő önzáró fogó, krómozott

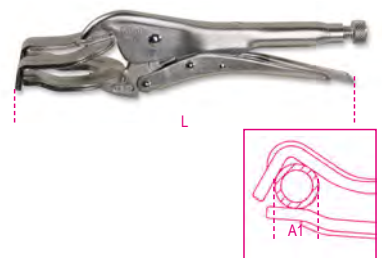

L mm	A1 max mm	Ft	🔧	📦
275	80	21.850	2	010610027

1062

C-pofás önzáró fogó, krómozott

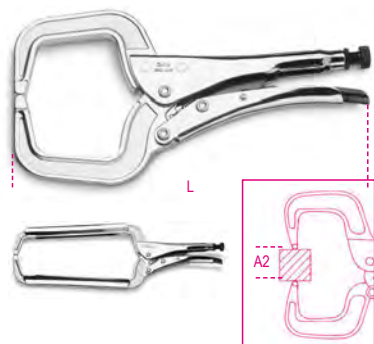

L mm	A1 max mm	Ft	🔧	📦
170	50	15.600	2	010620017
290	120	20.650	2	010620029
460	255	29.350	1	010620045

1062AL

C-pofás önzáró fogó, krómozott, alumíniumpófák

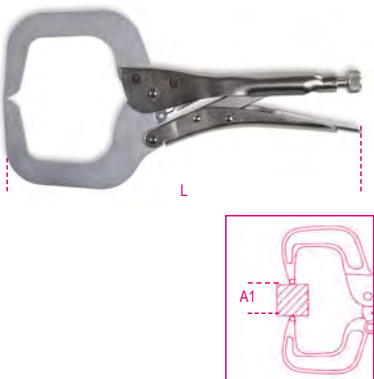

L mm	A1 max mm	Ft	🔧	📦
275	88	27.300	2	010620327

1062GM

C-pofás önzáró fogó, krómozott



L mm	A1 max mm	Ft	🔧	📦
170	45	17.000	2	010620217
290	88	24.100	2	010620229
460	255	33.800	1	010620245

1063

Bádgos önzáró fogó, krómozott

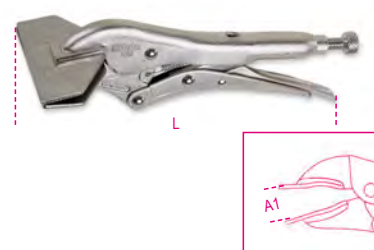

L mm	A1 max mm	Ft	🔧	📦
200	31	20.250	2	010630021

1064

Láncos önzáró fogó, krómozott

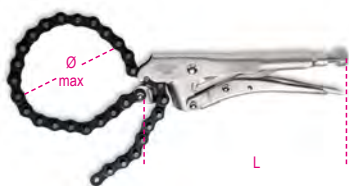

L mm	Ø mm	Ft	🔧	📦
230	150	28.950	2	010640023

1065F

Lyukasztófogó, alumínium test, bélyeg és matrica acélból



Ø mm	L mm	Ft	🔧	📦
5	228	55.450	1	010650010
6	228	55.850	1	010650015

1065P

Peremezőfogó, acélmatrica, alumíniumtest



L mm	Ft	🔧	📦
228	57.100	1	010650020

1066

állítható önzáró fogó,
90° zárási szög

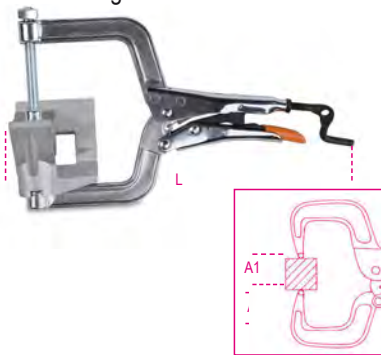

L mm	A1 max mm	g	Ft		
210	55	500	38.250	1	010660021

1067

állítható önzáró fogó,
csuklós csőfogó pófával

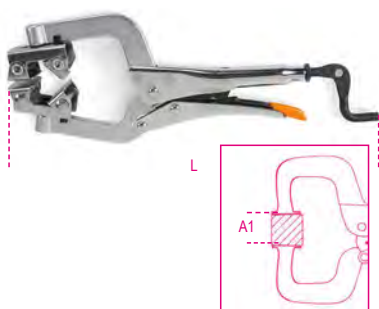

L mm	A1 max mm	Ft		
285	76	24.300	1	010670285
380	89	24.900	1	010670380

1068



1068	161
------	-----

1077

Egyenes szélescsőrű bádgos fogó,
barnított, PVC-bevonattal



L mm	A mm	L1 mm	Ft		
280	60	53	24.900	1	010770026

1078

45°-os hajlított szélescsőrű bádgos fogó,
barnított, PVC-bevonattal



L mm	A mm	L1 mm	Ft		
280	60	77	25.300	1	010780026

1080D

Oldalsípőfogó,
szárak kétrétegű, csúszásmentes PVC-
bevonattal

műanyag vágásához

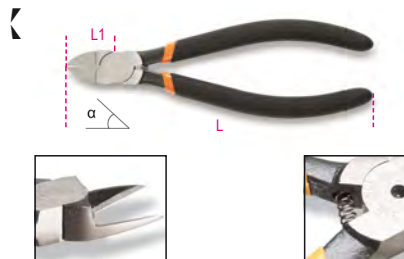

	L mm	L1 mm	Ft		
15°	160	22	13.350	3	010800015
45°	160	22	16.000	3	010800045

1081

csípőfogó félkör vágóélel
a szárak 2 rétegű
csúszásmentes PVC réteggel burkoltak
• Erőteljes mikromechanikai és elektronikai használathoz



L mm	L1 mm	Ft		
125	16	13.750	3	010810130

1082

oldalsípőfogó,
krómozott,
csúszásmentes kétrétegű PVC bevonatú
markolat



UNI/ISO 5749					
L mm	L1 mm	mm	Ft		
140	20	1,6	11.950	5	010820004
160	22	1,6	12.550	5	010820006

1082G

oldalsípőfogó,
csúszásmentes kétrétegű PVC bevonatú
markolat
ipari kivitel



UNI/ISO 5749					
L mm	L1 mm	mm	Ft		
140	20	1,6	10.300	5	010820064
160	22	1,6	10.700	5	010820066

1082BM

oldalsípőfogó,
kétkomponensű markolat



UNI/ISO 5749					
L mm	L1 mm	mm	Ft		
140	20	1,6	14.950	3	010820034
160	22	1,6	16.200	3	010820036

1082GBM

oldalsípőfogó,
kétkomponensű markolat
ipari kivitel



UNI/ISO 5749					
L mm	L1 mm	mm	Ft		
140	20	1,6	13.150	3	010820264
160	22	1,6	14.750	3	010820266

1084

erősített oldalsípőfogó,
krómozott,
csúszásmentes kétrétegű PVC bevonatú
markolat



UNI/ISO 5749					
L mm	L1 mm	mm	Ft		
160	22	1,6	13.950	5	010840006
200	28	2,0	17.400	3	010840010

1084G

erősített oldalsípőfogó,
csúszásmentes kétrétegű PVC bevonatú
markolat
ipari kivitel



UNI/ISO 5749					
L mm	L1 mm	mm	Ft		
140	20	1,6	12.350	5	010840066
200	28	2,0	15.200	3	010840070

1084BM

erősített oldalcsípőfogó,
krómozott,
kétkomponensű markolat



UNI/ISO 5749

L mm	L1 mm	≠ mm	Ft	🔧	📦
160	22	1,6	17.000	3	010840036
200	28	2,0	21.850	3	010840040

1084GBM

erősített oldalcsípőfogó,
kétkomponensű markolat
ipari kivitel



INDUSTRIAL
FINISHING

UNI/ISO 5749

L mm	L1 mm	≠ mm	Ft	🔧	📦
160	22	1,6	18.600	3	010840266
200	28	2,0	24.100	3	010840270

1088

Erősített homlokcsípőfogó
PVC-bevonattal



UNI/ISO 5748

L mm	L1 mm	≠ mm	Ft	🔧	📦
160	9	1,6	17.200	2	010880006
200	11	2,0	22.450	2	010880010

1088BM

Erősített homlokcsípőfogó, krómozott,
gumibetétes műanyag nyéllel



UNI/ISO 5748

L mm	L1 mm	≠ mm	Ft	🔧	📦
160	9	1,6	20.850	2	010880036
200	11	2,0	28.750	2	010880040

1092V

Áttételes erősített homlokcsípőfogó,
lakkozott



UNI/ISO 5748

L mm	L1 mm	≠ mm	Ft	🔧	📦
180	8	2,0	68.600	2	010920280
200	9	2,5	72.450	2	010920310

1094V

Áttételes erősített oldalcsípőfogó,
lakkozott



UNI/ISO 5749

L mm	L1 mm	≠ mm	Ft	🔧	📦
200	23	2,5	68.600	2	010940200

1095N

Áttételes oldalcsípőfogó, barnított,
krómozott



L mm	L1 mm	≠ mm	Ft	🔧	📦
195	26	1,6	24.300	2	010950010

1096

Harapófogó, lakkozott



ISO 9243

L mm	L1 mm	Ft	🔧	📦
160	21	9.230	5	010960016
200	23	10.700	5	010960020
250	30	14.550	5	010960025

1098

Rabitz-fogó, lakkozott



ISO 9242 DIN 5242

L mm	L1 mm	Ft	🔧	📦
190	12	9.230	5	010980190
220	13	10.300	5	010980220
250	15	12.550	5	010980250
280	18	13.750	5	010980280

1098PL

Rabitz fogó, PVC borítású nyél,
lakkozott



ISO 9242 DIN 5242

L mm	L1 mm	Ft	🔧	📦
220	13	11.550	5	010980320
250	15	13.350	5	010980350
280	18	14.750	5	010980380

1101

Csapszegvágó, vágókés foszfátzott,
lakkozott nyél gumibevonattal



L mm	L mm	Ft	🔧	📦
300	12	27.300	2	011010030
350	14	33.400	2	011010035
450	18	40.900	1	011010045
600	24	56.050	1	011010060
750	30	72.450	1	011010075
900	36	96.950	1	011010090

L mm	R = 80 Kg/mm² Ø mm	R = 140 Kg/mm² Ø mm	g	🔧
300	5	4	745	🔧
350	6	5	1043	🔧
450	7	6	1537	🔧
600	9	7	2540	🔧
750	11	8	3870	🔧
900	12	9	6170	🔧

1101R

Tartalékfej 1101-hez, foszfátzott



mm	1101	Ft	🔧	📦
300	300	16.200	1	011010130
350	350	19.000	1	011010135
450	450	24.300	1	011010145
600	600	32.800	1	011010160
750	750	40.500	1	011010175
900	900	53.650	1	011010190

1102

Mini csapszegvágó, foszfátzott, száruk lakkozottak

R= \approx 80 Kgf/mm²



L mm	\approx mm	Ft		
230	4	20.250	3	011020020

1103

csapszegvágó 90 fokos vágóélel rúdvashoz, csapszeghez és elektromosan hegesztett betonhálóhoz

max. \varnothing = 12 mm
max. \varnothing (HRC 48) = 6 mm



L mm	Ft		
950	72.850	1	011030090

1103R

tartalék fej a 1103 termékhez



1103R 950	Ft		
	43.100	1	011030190

1104

Drótkötélvágó, szárvég hőkezelt műanyag bevonattal



R=80 Kgf/mm²

L mm	\approx mm	Ft		
420	12	70.450	1	011040004
600	16	102.800	1	011040006

1104R

Tartalékkész a 1104-hez



mm	Ft		
420	43.700	1	011040014
600	60.700	1	011040016

1105

Tömítéskivágó, barnított acélból



D mm	L mm	Ft		
2	27	7.040	1	011050002
3	27	7.040	1	011050003
4	27	7.040	1	011050004
5	27	7.040	1	011050005
6	27	7.040	1	011050006
7	27	7.040	1	011050007
8	27	7.040	1	011050008
9	27	7.040	1	011050009
10	27	7.040	1	011050010
12	27	8.620	1	011050012
14	27	8.620	1	011050014
16	27	8.620	1	011050016
18	27	8.620	1	011050018
20	27	8.620	1	011050020
22	32	10.700	1	011050022
24	32	10.700	1	011050024
26	32	10.700	1	011050026
28	32	10.700	1	011050028
30	32	10.700	1	011050030
32	37	13.950	1	011050032
34	37	13.950	1	011050034
36	37	13.950	1	011050036
38	37	13.950	1	011050038
40	37	13.950	1	011050040
42	42	16.400	1	011050042
44	42	16.400	1	011050044
46	42	16.400	1	011050046
48	42	16.400	1	011050048
50	42	16.400	1	011050050

1105T20

nyél az 1105-höz
 \varnothing 2-20 mm



L mm	Ft		
110	35.000	1	011050200

1105T30

Nyél a 1105-höz
 \varnothing 3-30 mm



L mm	Ft		
175	75.300	1	011050205

1105T50

Nyél a 1105-höz
 \varnothing 2-50 mm



L mm	Ft		
175	74.300	1	011050207

1105AD-50

Adapter a 1105T50-hez



\varnothing mm	Ft		
57	46.950	1	011050210

1105/C10T

10 darabos tömitéskivágó készlet,
 \varnothing 3-20 mm, egy tartozékkal



1105C/10T	Ft		
	78.150	1	011050250

1105 3 - 4 - 6 - 8 - 10 - 12 - 14 - 16 - 18 - 20 mm
1105T20
135x92x32 mm

1105/C16T

15 darabos tömitéskivágó készlet,
 \varnothing 3-30 mm, egy tartozékkal



1105C/16T	Ft		
	141.300	1	011050255

1105 3 - 4 - 6 - 8 - 10 - 12 - 14 - 16 - 18 - 20 - 22 - 24 - 26 - 28 - 30 mm
1105T30
240x210x60 mm

1105/C32T

29 darabos tömítés kivágó készlet,
Ø 2-50 mm, 3 tartozékkal



1105C/32T **Ft** 275.700 1 011050257

1105	2 - 3 - 4 - 5 - 6 - 7 - 8 - 9 - 10 - 12 - 14 - 16 - 18 - 20 - 22 - 24 - 26 - 28 - 30 - 32 - 34 - 36 - 38 - 40 - 42 - 44 - 46 - 48 - 50 mm
1105T50	
1105AD-50	
455x380x115 mm	

1112

Bádigos olló amerikai modell,
krómzott, nyél PVC-bevonattal

R = $\frac{1}{16}$ 60 Kg/mm²



L mm	L1 mm	S mm	A mm	Ft	1	2
200	50	0,5	26	12.350	2	011120020
250	62	0,8	33	14.750	2	011120025
300	76	1,0	37	19.000	2	011120030
375	76	1,2	44	27.950	1	011120037

1114

Bádigos olló amerikai modell,
keskeny, egyenes éllel

R = 60 Kg/mm²

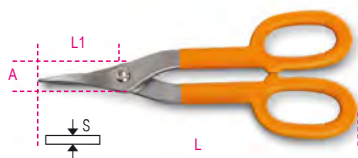

L mm	L1 mm	S mm	A mm	Ft	1	2
250	58	0,5	15	13.150	1	011140265
350	76	1	22	17.200	1	011140340

1118

Lemezolló acélszalag vágásához

Fe = Normálacél
Inox = rozsdamentes acél



L mm	L1 mm	Fe S mm	Inox S mm	Ft	1	2
310	42	1	0,8	21.450	2	011180001

1120A

Lemezolló

Fe = normál acél



L mm	Fe S mm	Ft	1	2
280	1,2	34.200	1	011200101

1120ARL - ARG

Tartalék az 1120A-hoz



1120ARL	Ft	1	2
	8.540	1	011200110
1120ARG	Ft	1	2
	10.700	1	011200120

1122

Áttételes egyenes lemezolló

Inox = rozsdamentes acél



L mm	L1 mm	Inox S mm	A mm	Ft	1	2
250	40	1	24	16.400	2	011220020

1122L

Hosszú élű, egyenes lemezolló

Inox = rozsdamentes acél



L mm	L1 mm	Inox S mm	Ft	1	2
288	98	1	17.000	2	011220035

1123

Áttételes jobbos lemezolló

Inox = rozsdamentes acél



L mm	L1 mm	Inox S mm	A mm	Ft	1	2
250	40	1	24	16.400	2	011230020

1124

Áttételes balos lemezolló

Inox = rozsdamentes acél



L mm	L1 mm	Inox S mm	A mm	Ft	1	2
250	40	1	24	16.400	2	011240020

1125

Erősített áttételes jobbos lemezolló

Inox = rozsdamentes acél

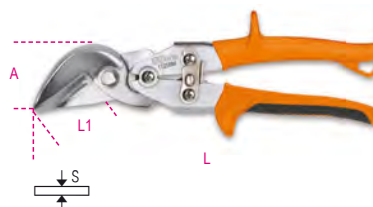

L mm	L1 mm	Inox S mm	A mm	Ft	1	2
250	35	1	46	25.900	2	011250020

1126

Erősített áttételes balos lemezolló

Inox = rozsdamentes acél

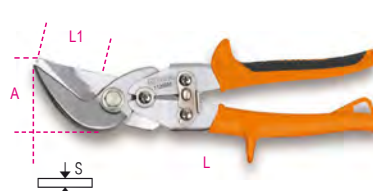

L mm	L1 mm	Inox S mm	A mm	Ft	1	2
250	35	1	46	25.900	2	011260020

1122 - 1125MOL

1122 MOL	1122 - 1124	Ft	1	2
		740	1	011220010
1123 MOL	1123	Ft	1	2
		625	1	011230010
1125 MOL	1125 - 1126	Ft	1	2
		625	1	011250040



1128FXS TÍPUSÚ MŰSZERÉSZ OLLÓ SKÁLABEOSZTÁSOS MARÓPROFILOKKAL

A műszerész olló újratervezéséhez megfigyeltük a szakembereket munka közben. Olyan univerzális szerszámot alkottunk, amely 4 fő funkciót egyesíti egy eszközben.

VÁGÁS Gyors és éles, akár 50 mm átmérőjű kábelekhez is, kábelvágó horonnyal és mikrofogazatú pengével a biztosabb fogáshoz.

BLANKOLÁS Az érzékeny, kilazulásbiztos csapnak köszönhetően a legvékonyabb kábel is pontosan blankolható.

KRIMPELÉS Biztonságos és tartós, kábelcsukhoz.

SÜLLYESZTÉS A maróprofilal pontosan és formásan mélyíthetők az átvezetődobozok furatai.



KETTŐS HATÁSÚ VILLANSZERELŐ OLLÓ LÉPCSŐS PROFILLAL, rozsdamentes DLC bevonattal

A 1128BAX ollók DLC-bevonatukkal tűnnek ki. A DLC (diamond-like carbon) egy újszerű, szénalapú bevonat: a nagyfokú keménység és az alacsony súrlódási együttható a felületen a grafit és gyémánt formában lerakódott szénnek köszönhető.

- A penge nagy felületi keménysége - kopásállóság és időtálló pengeélesség
- Alacsony súrlódási együttható - gördülékenység és tapadásgátlás

Lépcsős profil: 13 és 25 mm közötti furatok tágitására alkalmas műanyagokon.



+ NAGYOBB KEMÉNYSÉG
- KISEBB SÚRLÓDÁSI EGYÜTTHATÓ

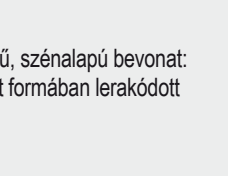

1127

Drótvágó olló egyenes élű, krómozott, PVC-bevonattal



L	L1	Ft	5	011270001
mm	mm			
150	35	7.170		

1128BAX

kettős hatású villanszerelő olló, lépcsős profil, rozsdamentes acél, DLC bevonat

kettős hatású vágás: egy különleges bütyökkel a forgásponton létrejön a pengék hosszirányú elmozdulása, amely a zárási fázisban megnöveli a vágási teljesítményt.
lépcsős profil: 13 és 24 mm közötti furatok tágitására létrehozva műanyagokon.

DLC bevonat; A DLC (diamond-like carbon) egy újszerű, szénalapú bevonat: a nagyfokú keménység és az alacsony súrlódási együttható a felületen a grafit és gyémánt formában lerakódott szénnek köszönhető.

- nagy felületi keménység a pengénél (nagy kopásállóság és időtálló pengeélesség)
- alacsony súrlódási együttható (gördülékenység és vágási teljesítmény)
- kilazulásbiztos excentrikus csap
- széles markolat csőfogó nyakkal
- rugalmas műanyag tokkal

SZABADALMI OLTALOM ALATT ÁLL.



L	L1	mm ²	Ft	5	011280088
mm	mm				
150	50	50	15.800		

1128BMX

Egyenes élű műszerész olló rozsdamentes acélból, mikrofogazattal



L	L1	Ft	5	011280051
mm	mm			
147	58,2	8.420		

1128BMX/F

rugalmas műanyag tok a 1128BMX modellhez



1128BMX/F	Ft	1	011280059
	850		

1128BSX

Műszerész olló lépcsős maróprofilal tokban



L	L1	Ft	5	011280061
mm	mm			
148	58,2	14.550		

1128FX

műszerész olló, egyenes rozsdamentes acél él, mikrofogazattal, kábelvágó és krimpelő kábelcsukhoz és csövekhez

- Rugalmas, övre akasztható tokkal
- Bimateriál nyél
- Kilazulásbiztos csap



L	L1	mm ²	Ft	5	011280090
mm	mm				
145	52	50	15.400		



1128FXS

műszerész olló lépcsős maróprofilal, egyenes rozsdamentes acél él, mikrofogazattal, kábelvágó és krimpelő kábelsarukhoz és csövekhez

- Rugalmas, övre akasztható tokkal
- Bimateriál nyél
- Kilazulásbiztos csap

• Profil és maró: műanyagon fúrt lyukak tágitásához, 13-21 mm között.



L	L1	mm ²	Ft	csomagolás	azonosító
mm	mm				
145	52	50	18.200	5	011280095

1128BM

Egyenes élű műszerész olló



L	L1	Ft	csomagolás	azonosító
mm	mm			
145	50	7.290	5	011280000

1130BMX

univerzális olló rozsdamentes acél, egyenes élekkel mikrofogazattal



L	L1	Ft	csomagolás	azonosító
mm	mm			
185	60	9.430	1	011300002

1131CK

Kevlar®- és optikai szál vágó olló



L	L1	Ft	csomagolás	azonosító
mm	mm			
203	75	37.850	1	011310001

1132

Kábelvágó szigetelt réz és alumínium kábelhez PVC-bevonattal



UNI 8791

L	mm	mm ²	Ft	csomagolás	azonosító
-					
170	14	50	23.500	2	011320107
230	18	95	28.750	2	011320113

1132BM

Kábelvágó, krómozott, gumibetétes műanyag nyéllel



UNI 8791

L	mm	mm ²	Ft	csomagolás	azonosító
-					
170	14	50	28.750	2	011320137
230	18	95	35.200	2	011320143

1133

Kábelvágó réz kábel vágásához

325 mm²-ig



L	mm	mm ²	Ft	csomagolás	azonosító
-					
600	30	325	79.950	1	011330001

1133RL

Tartalékcsap az 1133 modellhez



1133RL	Ft	csomagolás	azonosító
	60.100	1	011330011

1135

Kábelvágó acélkábelhez



L	Ft	csomagolás	azonosító
mm			
190	19.250	2	011350001

1142BM

Kábelcsupaszoló fogó, krómozott, gumibetétes műanyag nyéllel



UNI 7923

L	mm ²	mm	Ft	csomagolás	azonosító
mm					
160	0,5÷6	0-2,8	19.000	3	011420036

1143

Vágó és csupaszoló fogó



L	mm ²	mm	Ft	csomagolás	azonosító
-					
165	0,5÷6	1-3,2	37.250	1	011430001

1143R

Tartalékcsap 1143-hoz

1143R	Ft	csomagolás	azonosító
	9.390	1	011430011

1144D

Kábelcsupaszoló



L	mm ²	mm	Ft	csomagolás	azonosító
mm					
170	4,5÷240	2,5-18	44.750	1	011440010

1144D/RG

Tartalékcsap a 1144D-hez



1144D/RG	Ft	csomagolás	azonosító
	14.950	1	011440012

1144D/RL

Tartalékcsap a 1144D-hez

1144D/RL	Ft	csomagolás	azonosító
	22.850	1	011440011



1144G

huzalsupaszító

állítható pengével a keresztirányú és hosszirányú vágásokhoz



L			Ft		
140	6÷75	2.8-12 mm	24.900	1	011440004

1144G/RL

cserepenge a 1144G fogóhoz



1144G/RL	Ft		
	5.510	1	011440005

1144L

kábelcsupaszoló állítható pengével kereszt- és hosszirányú blankoláshoz

sima és horog alakú visszahúzó pengével



L			Ft		
145	6-150	4-28 mm	14.550	1	011440050

1144T

kábelcsupaszoló, zsebben elfér, kábelvágóval



L			Ft		
112	3,5 ÷ 9	40 g	10.050	1	011440060

1148A

Automata kábelcsupaszoló fogó

10 mm² (8 AWG) hajlékony vezeték esetén
1,5 mm² (16 AWG) nem hajlékony vezeték esetén



L			Ft		
190	0,02 ÷ 10	0-4 mm	76.300	1	011480100

1148A/R

Tartalékpofa a 1148A-hoz



1148A/R	Ft		
	32.800	1	011480102

1148B

Automata vágó és csupaszoló fogó



L			Ft		
190	4÷16	2-5 mm	89.650	1	011480200

1148B/R

Tartalékpofa a 1148B-hoz



1148B/R	Ft		
	40.900	1	011480202

1148P

automata kábelcsupaszoló fogó



L			Ft		
165	0.2-6	0-3.5 mm	21.450	1	011480300



1149F

Automata vágó- és csupaszoló fogó



L		Ft		
175	0,2 ÷ 6	8.300	1	011490010

1150

Kombinált fogó
Kromozott, polírozott
PVC-bevonattal

• Az eltolt csap növeli az erőkart, így csökkentve a vágáshoz szükséges erőt, amivel növeli a hatékonyságot.



ISO 5746

L	L1		Ft		
mm	mm	mm			
160	42	1,6	10.500	5	011500046
180	46	1,8	11.550	5	011500048
200	50	2,0	12.550	5	011500050
220	50	2,0	13.750	2	011500052

1150G

robuztus kombinált fogó
csúszásmentes kétrétegű PVC bevonatú
markolat
ipari kivitel

• Kimagasló minőség/ár arány
• Az eltolt csap növeli az erőkart, így csökkentve a vágáshoz szükséges erőt, amivel növeli a hatékonyságot.



ISO 5746

L	L1		Ft		
mm	mm	mm			
160	42	1,6	9.880	5	011500066
180	46	1,8	10.700	5	011500068
200	50	2,0	11.950	5	011500070
220	50	2,0	12.550	2	011500072



INDUSTRIAL FINISHING

1150HPC STRAPABÍRÓ KOMBINÁLTFOGÓ

M2 SZINTERACÉLBÓL KÉSZÜLT VÁGÓÉLEKKEL

- A decentralizált csap közelebb viszi a forgáspontot a vágási ponthoz, így módon növelve az erőkar hatását.
- A tökéletesen illeszkedő vágóélnek és a vékony kialakításnak köszönhetően a fogó rendkívül szűk helyeken is használható.
- A fogótest fokozott rugalmasságot és szilárdságot eredményező robusztus, hőedzett molibdén-acél ötvözet, amely minden körülmények között biztonságos tapadást biztosít.

Nyírófeszültség - statikus tesz =

-73%

Vágóélek átlagos élettartama (ISO 5744 szerinti vizsgálat) =

+127%

M2 acél vágóélek keménysége =

65HRC

RENDKÍVÜL INNOVATÍV

KRÓMOZOTT GYÖNGYHÁZ FELÜLET

KIEMELKEDŐ VÁGÓTELJESÍTMÉNY

szabadalmi oltalom alatt áll.



1150HPC

robusztus kombinált fogó integrált vágóélel és decentralizált csappal kétkomponensű markolat szabad csukló

integrált vágóél
acél: M2
vastagság: 0,20 mm
nyitási szög: 62°
keménység: 63+65 HRC



ISO 5746

szabadalmi oltalom alatt áll.

L mm	L1 mm	mm	Ft		
180	42	1,8	30.750	2	011500618

1150BM

Kombinált fogó, krómozott, polírozott, gumibetétes műanyag nyélel

- Az eltolt csap növeli az erőkart, így csökkentve a vágáshoz szükséges erőt, amivel növeli a hatékonyságot.



ISO 5746

L mm	L1 mm	mm	Ft		
160	42	1,6	13.150	3	011500146
180	46	1,8	14.550	3	011500148
200	50	2,0	15.800	3	011500150
220	50	2,0	17.000	2	011500152

1150GBM

robusztus kombinált fogó kétkomponensű markolat ipari kivitel

- Az eltolt csap növeli az erőkart, így csökkentve a vágáshoz szükséges erőt, amivel növeli a hatékonyságot.
- Kimagasló minőség/ár arány



ISO 5746

L mm	L1 mm	mm	Ft		
160	42	1,6	12.350	3	011500266
180	39	1,8	13.150	3	011500268
200	50	2,0	14.950	3	011500270
220	50	2,0	15.800	2	011500272

1153

Állítható kombináltfogó, krómozott, PVC bevonattal



UNI ISO 9343

L mm	L1 mm	Ft		
200	34	11.950	2	011530120

1162

extra hosszú laposfogó, krómozott, csúszásmentes kétrétegű PVC bevonatú markolat



ISO 5745

L mm	L1 mm	mm	Ft		
160	58	1,6	12.550	5	011620006
200	86	1,6	14.550	5	011620010



1162G

extra hosszú laposfogó,
csúszásmentes kétrétegű PVC bevonatú
markolat
ipari kivitel

• Kimagasló minőség/ár arány



ISO 5745

L	L1	≡	Ft		
mm	mm	mm			
160	58	1,6	10.500	5	011620066
200	86	1,6	12.350	5	011620070

1162BM

extra hosszú laposfogó,
krómozott,
kétkomponensű markolat



ISO 5745

L	L1	≡	Ft		
mm	mm	mm			
160	58	1,6	15.200	3	011620036
200	86	1,6	17.000	3	011620040

1162GBM

extra hosszú laposfogó,
kétkomponensű markolat
ipari kivitel

• Kimagasló minőség/ár arány



ISO 5745

L	L1	≡	Ft		
mm	mm	mm			
160	58	1,6	13.150	3	011620266
200	86	1,6	15.400	3	011620270

1164

Hajlított extra hosszú laposfogó
PVC-bevonattal



ISO 5745

L	L1	≡	Ft		
mm	mm	mm			
160	54	1,6	13.550	5	011640006
200	76	1,6	15.200	5	011640010

1164BM

Hajlított extra hosszú laposfogó,
krómozott, gumibetétes műanyag
szárral



ISO 5745

L	L1	≡	Ft		
mm	mm	mm			
160	54	1,6	16.400	3	011640036
200	76	1,6	18.600	3	011640040

1166

egyenes extra hosszú félkerekcsőrű fogó,
krómozott,
csúszásmentes kétrétegű PVC bevonatú
markolat



ISO 5745

L	L1	≡	Ft		
mm	mm	mm			
160	56	1,6	12.550	5	011660006
200	76	1,6	14.550	5	011660010

1166G

egyenes extra hosszú félkerekcsőrű fogó,
csúszásmentes kétrétegű PVC bevonatú
markolat
ipari kivitel

• Kimagasló minőség/ár arány



ISO 5745

L	L1	≡	Ft		
mm	mm	mm			
160	56	1,6	10.500	5	011660066
200	76	1,6	12.350	5	011660070

1166BM

egyenes extra hosszú félkerekcsőrű fogó,
krómozott,
kétkomponensű markolat



ISO 5745

L	L1	≡	Ft		
mm	mm	mm			
160	56	1,6	15.200	3	011660036
200	76	1,6	17.000	3	011660040

1166GBM

egyenes extra hosszú félkerekcsőrű fogó,
kétkomponensű markolat
ipari kivitel

• Kimagasló minőség/ár arány



ISO 5745

L	L1	≡	Ft		
mm	mm	mm			
160	56	1,6	13.150	3	011660266
200	76	1,6	15.400	3	011660270

1168

hajlított extra hosszú félkerekcsőrű fogó,
krómozott,
csúszásmentes kétrétegű PVC bevonatú
markolat

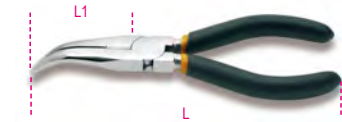

ISO 5745

L	L1	≡	Ft		
mm	mm	mm			
160	54	1,6	13.550	5	011680006
200	76	1,6	15.200	5	011680010

1168G

hajlított extra hosszú félkerekcsőrű fogó,
csúszásmentes kétrétegű PVC bevonatú
markolat
ipari kivitel

• Kimagasló minőség/ár arány



ISO 5745

L	L1	≡	Ft		
mm	mm	mm			
160	54	1,6	11.550	5	011680066
200	76	1,6	13.150	5	011680070

1168BM

hajlított extra hosszú félkerekcsőrű fogó,
krómozott,
kétkomponensű markolat



ISO 5745

L	L1	mm	Ft	csomagolás	gyártási kód
160	54	1,6	16.400	3	011680036
200	70	1,6	18.600	3	011680040

1168GBM

hajlított extra hosszú félkerekcsőrű fogó,
kétkomponensű markolat
ipari kivitel

• Kimagasló minőség/ár arány



ISO 5745

L	L1	mm	Ft	csomagolás	gyártási kód
160	54	1,6	14.750	3	011680266
200	70	1,6	16.400	3	011680270

1169/D3

1 kombinált fogó, 1 hosszú félkerekcsőrű fogó,
1 oldalcsipőfogó



1169/D3	Ft	csomagolás	gyártási kód
1082 160mm	36.650	1	011690053
1150 180mm			
1166 160mm			

1169G/D3

1 kombinált fogó,
1 hosszú félkerekcsőrű fogó,
1 oldalcsipőfogó, csúszásmentes kétrétegű
PVC bevonattal, ipari kivitel

• Kimagasló minőség/ár arány



1169G/D3	Ft	csomagolás	gyártási kód
1082G 160mm	32.000	1	011690073
1150G 180mm			
1166G 160mm			

1169BM/D3

1 kombinált fogó, 1 hosszú félkerekcsőrű fogó,
1 oldalcsipőfogó
Bimateriális nyél



1169BM/D3	Ft	csomagolás	gyártási kód
1082BM 160mm	45.950	1	011690133
1150BM 180mm			
1166BM 160mm			

1169GBM/D3

1 kombinált fogó,
1 hosszú félkerekcsőrű fogó,
1 oldalcsipőfogó, kétkomponensű markolat,
ipari kivitel

• Kimagasló minőség/ár arány



1169GBM/D3	Ft	csomagolás	gyártási kód
1082GBM 160mm	41.100	1	011690273
1150GBM 180mm			
1166GBM 160mm			

1169N/D4

1 robusztus kombinált fogóból,
1 hosszú félkerekcsőrű fogóból, 1
oldalcsipőfogóból, és 1 vízpumpafogóból álló
készlet, krómozott,
foszfátózott



1169N/D4	Ft	csomagolás	gyártási kód
1082 160 mm	52.200	1	011690024
1150 180 mm			
1166 160 mm			
1048N 250 mm			

1171BM

Elektronikai laposfogó, polírozott
bimateriális szár



ISO 9655

L	L1	A	B	Ft	csomagolás	gyártási kód
130	18	12	8	20.650	2	011710101

1172BM

Elektronikai laposfogó, hosszított kivitel,
polírozott
bimateriális szár

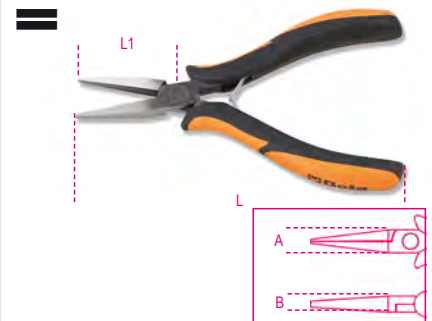

ISO 9655

L	L1	A	B	Ft	csomagolás	gyártási kód
140	40	12	8	20.650	2	011720101

1172BM/P

Hajlított elektronikai laposfogó, hosszított kivitel, polírozott bimateriális szár



L	L1	A	B	Ft	Icon 1	Icon 2
~ 140	mm 38	mm 12	mm 13	23.900	2	011720102

1173BM

Elektronikai kerekcsőrű fogó, rövid kivitel, bimateriális szár



L	L1	A	B	Ft	Icon 1	Icon 2
~ 125	mm 22	mm 12	mm 8	20.650	2	011730101

1175BM

Elektronikai félkerekcsőrű fogó, rövid kivitel, polírozott bimateriális szár



L	L1	A	B	Ft	Icon 1	Icon 2
~ 140	mm 29	mm 12	mm 8	20.650	2	011750101

1177BM

Elektronikai félkerekcsőrű fogó, hosszított kivitel, bimateriális szár

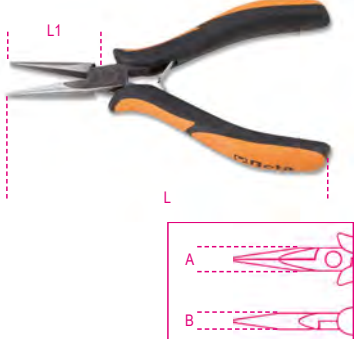

L	L1	A	B	Ft	Icon 1	Icon 2
~ 140	mm 38	mm 12	mm 8	20.650	2	011770101

1177BM/Z

Elektronikai félkerekcsőrű fogó, hosszított kivitel, recézett bimateriális szár



L	L1	A	B	Ft	Icon 1	Icon 2
~ 140	mm 39	mm 12	mm 8	23.900	2	011770113

1178BM

Elektronikai félkerekcsőrű fogó, hosszított kivitel, polírozott bimateriális szár



L	L1	A	B	Ft	Icon 1	Icon 2
~ 140	mm 37	mm 12	mm 8	23.900	2	011780101

1178BM/P

Elektronikai hajlított félkerekcsőrű fogó, hosszított kivitel, polírozott bimateriális szár



L	L1	A	B	Ft	Icon 1	Icon 2
~ 140	mm 36,5	mm 12	mm 12	23.900	2	011780102

Rézvágó csípőfogók. Intenzívebb igénybevétel esetén lásd a 1081-es számú terméket.

1182BM

Speciális elektronikai oldalcsípőfogó, keskeny pófával bimateriális szár



L	L1	A	Cu	Ft	Icon 1	Icon 2
mm 120	mm 11	mm 10	mm 1	23.900	2	011820101



1183BM

Speciális elektronikai oldalcsípőfogó, lekerekített pófával bimateriális szár



ISO 9654

L mm	L1 mm	A mm	Cu mm	Ft	🔧	📦
120	11	10	1	23.900	2	011830101
130	13	12,5	1,25	23.900	2	011830102

1184BM

Speciális elektronikai oldalcsípőfogó, lekerekített pófával bimateriális szár



ISO 9654

L mm	L1 mm	A mm	Cu mm	Ft	🔧	📦
120	11	10	1	23.900	2	011840101
130	13	12,5	1,25	23.900	2	011840102

1185BM

Speciális elektronikai oldalcsípőfogó, keskeny pófával bimateriális szár



ISO 9654

L mm	L1 mm	A mm	Cu mm	Ft	🔧	📦
120	11	10	1	23.900	2	011850101
130	13	12,5	1,25	23.900	2	011850102

1186BM

Speciális elektronikai oldalcsípőfogó, keskeny nyújtott pófával bimateriális szár



ISO 9654

L mm	L1 mm	A mm	Cu mm	Ft	🔧	📦
120	11	10	1	23.900	2	011860101
130	13	12,5	1,25	23.900	2	011860102

1188BM

Elektronikai oldalcsípőfogó középvágással bimateriális szár



ISO 9654

L mm	L1 mm	A mm	Cu mm	Ft	🔧	📦
125	12	12	1,25	23.900	2	011880101
130	17	15	2	23.900	2	011880102

1190BM

Speciális elektronikai homlokcsípőfogó bimateriális szár



ISO 9654

L mm	L1 mm	A mm	Cu mm	Ft	🔧	📦
120	12	12	1,25	23.900	2	011900113

1191BM

Speciális elektronikai homlokcsípőfogó, ferde vágóélel bimateriális szár



ISO 9654

L mm	L1 mm	A mm	Cu mm	Ft	🔧	📦
130	8	12	0,8	23.900	2	011910101

1191BM/L

Speciális elektronikai homlokcsípőfogó, ferde vágóélel, hosszított kivitel, keskeny pófával bimateriális szár



ISO 9654

L mm	L1 mm	A mm	Cu mm	Ft	🔧	📦
130	18	12	1	23.900	2	011910110

1191R/5-M

tartalék rugó készlet elektronikai fogókhoz és csípőfogókhoz (Cikkszámok: 1171...1191)

	Ft	🔧	📦
1191R/5-M	4.700	1	011910995

1200MS

Mágnesező/mágnesmentesítő

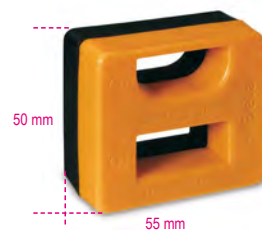

	Ft	🔧	📦
1200MS	7.450	5	012000000

Beta **evox**

A CSAVARHÚZÓ EVOLÚCIÓJA!

Az ergonomikus markolat tökéletesen illeszkedik a kézbe. A nagy érintkezési felületnek köszönhetően kis erőfelfejtéssel is nagy erőátvitel érhető el.

A Beta kipróbált pengéi egyedi rugalmasságot, keménységet és kopásállóságot biztosítanak a felső kategóriás professzionális szerszámoknak.

A nyolcszögű markolat megakadályozza az elgurulást.

A precíziósan kialakított fejnél fogva a csavarhúzó az ujjak között is gyorsan forgatható.

A markolaton elhelyezett lyuknál felakasztva a csavarhúzó könnyebben tárolható.

Az új, hőkezelt gumi még az intenzív munkáknál is kényelmes fogást biztosít.

A fej típusa és mérete a kerek markolatvégre van nyomtatva, így gyorsan beazonosítható.

A Beta kipróbált pengéi egyedi rugalmasságot, keménységet és kopásállóságot biztosítanak a felső kategóriás professzionális szerszámoknak.

Az ergonomikus markolat tökéletesen illeszkedik a kézbe. A nagy érintkezési felületnek köszönhetően kis erőfelfejtéssel is nagy erőátvitel érhető el.

A nyolcszögű szakasz megakadályozza az elgurulást.

A precíziósan kialakított fejnél fogva a csavarhúzó az ujjak között is gyorsan forgatható.

Az új, hőkezelt gumi még az intenzív munkáknál is kényelmes fogást biztosít.



A fej típusa és mérete a kerek markolatvégre van nyomtatva, így gyorsan beazonosítható.

A markolaton elhelyezett lyuknál felakasztva a csavarhúzó könnyebben tárolható.

1201E

csavarhúzó hasítottfejű csavarokhoz



ISO 2380

SxAxL mm	L1 mm	Ø mm	Ft	☞	☞
0,4x2,5x50	146	2,5	1.840	5	012011003
0,4x2,5x75	166	2,5	1.920	5	012011006
0,5x3x75	171	3,0	1.940	5	012011009
0,5x3x100	196	3,0	2.090	5	012011012
0,6x3,5x75	171	3,5	2.090	5	012011018
0,6x3,5x100	196	3,5	2.150	5	012011021
0,8x4x100	196	4,0	2.170	5	012011030
0,8x4x125	221	4,0	2.290	5	012011033
0,8x4x150	246	4,0	2.470	5	012011036
1,0x5,5x100	209	5,0	2.710	5	012011039
1,0x5,5x125	234	5,0	2.850	5	012011040
1,0x5,5x150	259	5,0	2.890	5	012011042
1,2x6,5x100	220	6,0	3.240	5	012011048
1,2x6,5x125	234	6,0	3.340	5	012011050
1,2x6,5x150	270	6,0	3.400	5	012011051
1,2x8x150	282	8,0	4.370	3	012011057
1,2x8x200	332	8,0	4.740	3	012011060
1,6x10x200	332	9,5	5.470	3	012011066



Ft	☞	☞
18.800	1	012011206

1201E/S6
0,5x3x75-0,6x3,5x100
0,8x4x100-1,0x5,5x100
1,2x8x150-1,6x10x200 mm

1201EN

csavarhúzó hasítottfejű csavarokhoz, extra rövid



ISO 2380

SxAxL mm	L1 mm	Ø mm	Ft	☞	☞
0,8x4x30	86,5	4	2.650	3	012011103
1,2x6,5x30	86,5	6	2.810	3	012011106

1201E/DZ

csavarhúzó Dzus® fejű csavarokhoz



L mm	L1 mm	Ft	☞	☞
53	173	6.560	2	012011501

1202E

csavarhúzó keresztfejű Phillips® csavarokhoz



UNI-ISO 8764

PHxDxL mm	L1 mm	Ft		
0x3x60	156	1.920	5	012021003
0x3x100	200	2.150	5	012021006
1x4,5x80	189	2.450	5	012021009
1x4,5x120	229	2.790	5	012021012
2x6x100	220	3.340	5	012021018
2x6x150	270	3.580	5	012021021
3x8x150	282	4.570	3	012021024
4x9,5x200	332	6.030	3	012021027



	Ft		
1202E/S4 PH0x3x60-PH1x4,5x120 PH2x6x150-PH3x8x150 mm	12.850	1	012021204

1202EN

csavarhúzó keresztfejű Phillips® csavarokhoz, extra rövid



UNI-ISO 8764

PHxDxL mm	L1 mm	Ft		
1x4,5x30	86,5	2.650	3	012021103
2x6x30	86,5	2.810	3	012021106

1202EL

hosszú csavarhúzó keresztfejű Phillips® csavarokhoz



UNI-ISO 8764-1

PHxDxL mm	L1 mm	Ft		
0x3x300	400	3.400	3	012021303
1x4,5x300	400	3.720	3	012021305
1x4,5x400	508	4.530	3	012021306
2x6x400	519	5.220	3	012021309

1203E/D

csavarhúzó készlet



	Ft		
1203E/D5	14.250	1	012031001

1201E	0,6x3,5x100-1,0x5,5x150 1,2x6,5x150 mm
1202E	PH1x4,5x80-PH2x6x100 mm

	Ft		
1203E/D5PZ	13.750	1	012031003

1201E	0,5x3x75-0,8x4x125 1,0x5,5x150 mm
1209E/PZ	PZ1x4,5x80-PZ2x6x100 mm

	Ft		
1203E/D6	14.650	1	012031006

1202E	PH1x4,5x80-PH2x6x100 mm
1204E	0,4x2,5x60-0,5x3x100 0,8x4x100-1,0x5x125 mm

	Ft		
1203E/D7	17.950	1	012031007

1201E	0,5x3x75-0,8x4x100 1,0x5,5x100-1,2x6,5x150 mm
1202E	PH0x3x60-PH1x4,5x80 PH2x6x100 mm

	Ft		
1203E/D8	22.800	1	012031008

1201E	0,5x3x75-0,8x4x125 1,0x5,5x150-1,2x6,5x150 mm
1202E	PH0x3x60-PH1x4,5x80 PH2x6x100-PH3x8x150 mm

	Ft		
1203E/D8P	19.750	1	012031018

1201E	2,5x50-3x75-4x100 5,5x100-6,5x150 mm
1202E	PH0x60-PH1x80-PH2x100 mm

	Ft		
1203E/D10	28.700	1	012031010

1201E	0,4x2,5x50-0,5x3x75 0,8x4x100-1,0x5,5x100 1,2x6,5x150-1,2x8x150 mm
1202E	PH0x3x60-PH1x4,5x80 PH2x6x100-PH3x8x150 mm

	Ft		
1203E/D10N	25.250	1	012031019

1201E	0,4x2,5x50-0,5x3x75-0,8x4x100- 1,0x5,5x150-1,2x6,5x150 mm
1201EN	0,8x4x30 mm
1202E	PH0x3x60 - PH1x4,5x80 - PH2x6x100 mm
1202EN	PH1x4,5x30 mm



1203E/S

Beta EVOLX



	Ft		
1203E/S8	19.900	1	012031009

1201E	2,5x50-3x75-4x100 5,5x125-6,5x150 mm
1202E	PH0x3x60-PH1x4,5x80 PH2x6x100 mm

	Ft		
1203E/S10	29.000	1	012031021

1201E	0,4x2,5x50-0,5x3x75 0,8x4x125-1,0x5,5x150 1,2x6,5x150-1,2x8x150 mm
1202E	PH0x3x60-PH1x4,5x80 PH2x6x100-PH3x8x150 mm

1204E

csavarhúzó henyőcsavarokhoz



ISO 2380

SxDxL mm	L1 mm	Ft		
0,4x2,5x60	156	1.900	5	012041003
0,6x3x75	175	1.940	5	012041006
0,5x3x100	196	1.980	5	012041009
0,8x4x100	196	2.230	5	012041012
0,8x4x125	233	2.350	5	012041015
1x5x125	234	2.730	5	012041018
1x5x150	258	2.960	5	012041021
1,2x6,5x150	270	3.240	5	012041024



	Ft		
1204E/S5	12.100	1	012041205

1204E/S5	0,4x2,5x60-0,5x3x100 0,8x4x100-1x5x125 1,2x6,5x150 mm
----------	---

1204EL

hosszú csavarhúzó hernyócsavarokhoz



ISO 2380

SxDxL mm	L1 mm	Ft	📦	📄
0,5x2,5x200	300	2.810	3	012041303
0,5x3x300	400	3.340	3	012041306
0,8x4x400	508	4.090	3	012041309
1x5x400	508	4.370	3	012041315
1,2x6,5x400	519	5.630	3	012041318

1205E/ES

hatlapú imbusz csavarhúzó



mm	L mm	L1 mm	Ft	📦	📄
1,5	100	200	2.390	3	012051315
2	100	200	2.450	3	012051320
2,5	100	200	2.470	3	012051325
3	100	200	2.570	3	012051330
4	100	208	2.940	3	012051340
5	100	219	3.520	3	012051350
6	125	244	3.600	3	012051360
8	150	277	4.820	2	012051380



1205E/ES-S8	Ft	📦	📄
1,5-2-2,5-3-4-5-6-8 mm	24.750	1	012051408

1206E/BP

gömbfejű hatlapú csavarhúzó



mm	L mm	L1 mm	∅ mm	Ft	📦	📄
2	100	198	2,5	2.670	3	012061320
2,5	100	198	3,0	2.710	3	012061325
3	100	198	3,5	2.750	3	012061330
4	100	209	5,0	3.100	3	012061340
5	100	220	6,0	3.720	3	012061350
6	125	245	7,0	3.830	3	012061360
8	150	287	9,5	5.140	2	012061380



1206E/BP-S7	Ft	📦	📄
2-2,5-3-4-5-6-8 mm	23.900	1	012061407

1207E/TX

imbusz-csavarhúzó Torx®-csavarokhoz



	L mm	L1 mm	∅ mm	Ft	📦	📄
T5	50	150	3	2.850	5	012071005
T6	60	156	4	3.040	5	012071006
T7	60	156	4	3.100	5	012071007
T8	60	156	4	3.140	5	012071008
T9	60	156	4	3.300	5	012071009
T10	80	189	5	3.720	5	012071010
T15	80	189	5	3.770	5	012071015
T20	100	209	5	3.830	5	012071020
T25	100	209	5	3.950	5	012071025
T27	100	220	6	4.170	5	012071027
T30	100	220	6	4.210	5	012071030
T40	130	262	7	5.020	2	012071040
T45	130	262	8	5.510	2	012071045



1207E/TX-D7	Ft	📦	📄
T6-T8-T10-T15 T20-T25-T30	25.650	1	012071207
1207E/TX-S13	Ft	📦	📄
T5-T6-T7-T8-T9-T10-T15 T20-T25-T27-T30-T40-T45	49.600	1	012071213

1208E/RTX

csavarhúzó a Tamper Resistant Torx®-csavarokhoz



∅	L mm	L1 mm	∅ mm	Ft	📦	📄
T9	60	156	4	3.340	5	012081009
T10	80	189	5	3.720	5	012081010
T15	80	189	5	3.950	5	012081015
T20	100	209	5	4.010	5	012081020
T25	100	209	5	4.090	5	012081025
T27	100	220	6	4.450	5	012081027
T30	100	220	6	4.700	5	012081030
T40	130	262	7	5.590	2	012081040



Beta EVOX

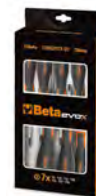

1208E/RTX-D7	Ft	📦	📄
T9-T10-T15-T20 T25-T27-T30	28.250	1	012081207

1209E/PZ

csavarhúzó keresztfejű Pozidriv®-Supadriv® csavarokhoz



UNI-ISO 8764

PZ	L mm	L1 mm	Ft	📦	📄
0	60	156	2.230	5	012091000
1	80	189	2.890	5	012091003
2	100	220	3.720	5	012091006
3	150	282	5.710	3	012091009
4	200	327	6.230	3	012091012



Beta EVOX



1209E/PZ-S4	Ft	📦	📄
PZ0-PZ1-PZ2-PZ3	14.550	1	012091204

1209EN/PZ

csavarhúzó keresztfejű Pozidriv®-Supadriv® csavarokhoz, extra rövid



ISO 8764

PZ	L mm	L1 mm	Ft	📦	📄
1	30	87	2.650	3	012091103
2	30	87	2.810	3	012091106

BETA EVOX-E ELEKTROMOS CSAVARHÚZÓ

A Beta Evox-E elektromos csavarhúzójával minimális erőfeszítéssel és gyorsan dolgozhatunk. Nagy pontosságú munkákhoz ideális.



PRAKTIKUM

A kisebb méretének és a szár melletti beépített LED-eknek köszönhetően kis, gyengén világított helyen is használható.

ERGONOMIKUS DESIGN

A markolat tökéletesen illeszkedik a tenyérbe, így stabil és kényelmes fogást biztosít.

1/4



USB-C



Akkumulátor üzemidő

Hosszú élettartamú 3.7V 2300mAh lítium akkumulátor, töltési ciklusonként akár 1 000 behajtás 1,2 Nm nyomattékkal.

Két változatban elérhető:

- 1210E/GE elektromos csavarhúzó betétekkel



- 1211E/GE elektromos csavarhúzó 1000 V szigetelt betétekkel



⚡ 1000 V



1210E/GE

Evox-E elektromos csavarhúzó

- 4-5 mm
- ⊕ PH2
- ⊕ PZ2
- ⊛ T25 - T30



L mm	Ft	1	012100701
150	78.350		

1211E/GE

Evox-E elektromos csavarhúzó

- 3,5x0,6 - 5,5x1 mm
- ⊕ PH2
- ⊕ PZ2
- ⊕ PH2/SL
- ⊕ PZ2/SL



L mm	Ft	1	012110701
150	83.600		

1229LP/S



1229LP/A6	Ft	1	012290300
1,2-1,4-1,8-2-2,4-3 mm	11.950		

1229LPH/A6

6 műszerész csavarhúzó, műanyag dobozban



1229LPH/A6	Ft	1	012290310
1229LP	1,4-2,0-2,4-3 mm		
1229PH	PH0-PH1		

1236B

Sarokcsavarhúzó hasítottfejű csavarokhoz

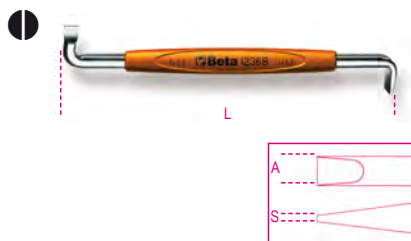

UNI 7079 DIN 5200

SxA mm	L mm	Ft		
0,8x4	100	3.400	5	012360201
1x5,5	125	3.990	5	012360202
1,2x8	150	4.940	5	012360204

1238B

Sarokcsavarhúzó Phillips®-csavarokhoz



UNI 7083 DIN 5208

PH	L mm	Ft		
1-2	125	4.050	5	012380201
3-4	200	6.600	5	012380203

1241

Üthető acélfejű csavarhúzó hasítottfejű csavarokhoz



ISO 2380

SxAxL mm	L1 mm	Ft		
1x5,5x100	202	5.340	5	012410039
1,2x6,5x125	240	5.910	5	012410050
1,2x8x150	268	7.210	3	012410057
1,6x10x175	300	9.030	2	012410065
1,6x10x200	325	9.230	2	012410066
2,0x12x200	325	9.720	2	012410067
2,5x14x250	375	10.700	2	012410076



1242

Üthető acélfejű csavarhúzó Phillips® csavarokhoz

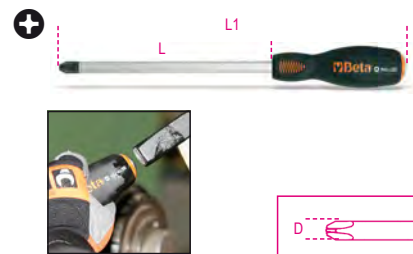

UNI/ISO 8764

PHxDxL mm	L1 mm	Ft		
1x4,5x100	202	5.260	5	012420209
2x6x100	215	6.230	5	012420218
3x8x150	268	7.980	3	012420221
4x11x200	325	10.300	2	012420224

1243LP/D6

6 darabos acélfejű csavarhúzó készlet hasítottfejű csavarokhoz



	Ft		
1243LP/D6	47.950	1	012430016
1241			

1243/D7

7 darabos üthető csavarhúzó készlet



	Ft		
1243/D7	47.150	1	012430017
1241			
1242			

1243/S11

11 darabos acélfejű csavarhúzó készlet



	Ft		
1243/S11	86.950	1	012430021
1241			
1242			

1250

Csavarartó csavarhúzó

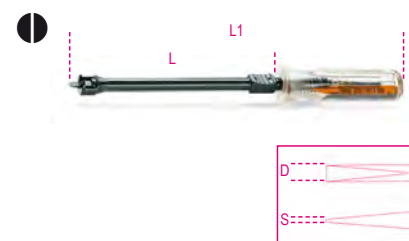

SxDxL mm	L1 mm	Ft		
0,5x3x125	190	7.610	5	012500030
0,6x4x125	225	8.180	5	012500040
0,7x5x150	255	9.680	5	012500050

1251

Phillips® csavarartó csavarhúzó

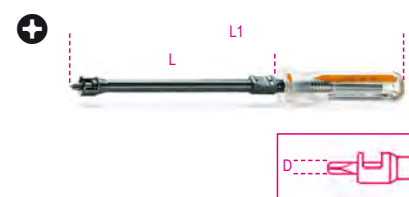

PHxDxL mm	L1 mm	Ft		
0x4x125	225	8.540	5	012510000
1x5x125	225	9.880	5	012510010
2x6x175	280	11.350	5	012510020

1252/S5



	Ft		
1252/S5	46.700	1	012520001
1250			
1251			

1253

Fáziskereső csavarhúzó - 150/250V

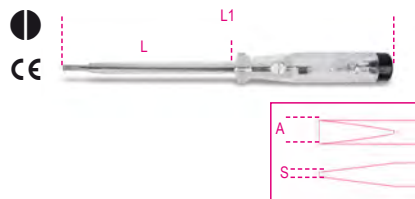

SxAxL mm	L1 mm	Ft	5	1
0,5x3,5x100	190	4.570		012530001

1253A

Fáziskereső csavarhúzó - 125/250V, dupla szigeteléssel



SxAxL mm	L1 mm	Ft	5	1
0,5x3x15	150	3.260		012530010

1254

Próbalámpa 6-24 V

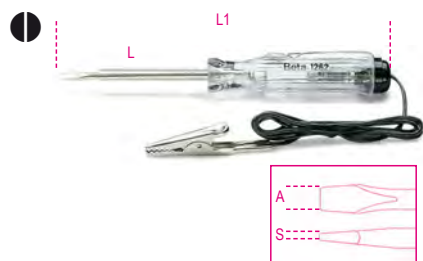

SxAxL mm	L1 mm	Ft	5	1
0,5x3x44	123	5.020		012540001

1256/C36-2

Műszerész csavarhúzó 36 cserélhető 4 mm-es bit-tel és mágneses hosszabbítóval



1256/C36-2	Ft	1	1
	32.400		012560100

	1256TX	T3 - T4 - T5 - T6 - T7 T8 - T9 - T10 - T15
	1256RTX	T6 - T7 - T8 - T9 - T10
	1256LP	0,8 - 1,2 - 1,5 - 1,8 - 2 - 2,5 3 - 3,5 - 4 mm
	1256PE	0,7 - 0,9 - 1,3 - 1,5 - 2 mm
	1256PH	PH000 - PH00 - PH0 - PH1
	1256PZ	PZ000 - PZ00 - PZ0 - PZ1
	1256/20	
	1256/30	
130x60x35 mm - 200 g		



1256LP

Csavarhúzóbetét 4 mm hasítottfejú csavarokhoz

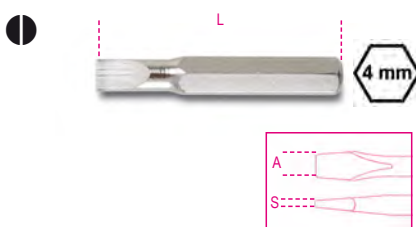

SxA	L	Ft	5	1
0,25x0,8	27	625		012560001
0,25x1,2	27	625		012560002
0,3x1,5	27	625		012560003
0,35x1,8	27	625		012560004
0,4x2,0	27	625		012560005
0,4x2,5	27	625		012560006
0,5x3,0	27	625		012560007
0,6x3,5	27	625		012560008
0,8x4,0	27	625		012560009

1256PH

Csavarhúzóbetét 4 mm Phillips®-csavarokhoz



PH	L	Ft	5	1
000	27	625		012560011
00	27	625		012560012
0	27	625		012560013
1	27	625		012560014

1256PZ

4 mm betét Pozidriv® - Supradriv® illesztésű csavarokhoz



PZ	L	Ft	5	1
000	27	625		012560061
00	27	625		012560062
0	27	625		012560063
1	27	625		012560064

1256PE

Csavarhúzóbetét 4 mm hatszögű csavarokhoz



mm	L	Ft	5	1
0,7	27	625		012560021
0,9	27	625		012560022
1,3	27	625		012560023
1,5	27	625		012560024
2,0	27	625		012560025

1256TX

Csavarhúzóbetét 4 mm Torx®-csavarokhoz



T	L	Ft	5	1
T3	27	655		012560041
T4	27	655		012560042
T5	27	655		012560043
T6	27	655		012560044
T7	27	655		012560045
T8	27	655		012560046
T9	27	655		012560047
T10	27	655		012560048
T15	27	655		012560049

1256RTX

Csavarhúzóbetét 4 mm Tamper Resistant Torx®-csavarokhoz



T	L	Ft	5	1
T6	27	785		012560051
T7	27	785		012560052
T8	27	785		012560053
T9	27	785		012560054
T10	27	785		012560055

1256/20

Toldó, belső- és külső hatszög 4 mm



1256/20	Ft	5	1
	3.950		012560092

1256/30

Betéttartó nyéllal 4 mm



L	Ft	2	1
110	4.700		012560097

1257LP

Műszerész csavarhúzó hasítottfejú csavarhoz



SxD mm	L mm	Ft	📦	📄
0,25x1,2	60	2.490	5	012570012
0,23x1,5	60	2.490	5	012570015
0,3x1,8	60	2.490	5	012570018
0,4x2	60	2.490	5	012570020
0,4x2,5	60	2.490	5	012570024
0,5x3	60	2.490	5	012570030
0,6x3,5	60	2.490	5	012570035
0,8x4	60	2.490	5	012570040



1257LP/S8	Ft	📦	📄
0,2x1,2-0,25x1,5 0,3x1,8-0,4x2-0,4x2,5 0,5x3-0,6x3,5-0,8x4 mm	31.250	1	012570200

1257PH

Phillips(R) műszerész csavarhúzó



PH	L mm	Ft	📦	📄
00	60	2.490	5	012570060
0	60	2.490	5	012570063
1	60	2.490	5	012570066



1257LPH/S8



1257LPH/S8	Ft	📦	📄
1257PH PH00-PH0-PH1 1257LP 0,4x2-0,4x2,5-0,5x3 0,6x3,5-0,8x4 mm	31.250	1	012570210

1257ES

Műszerész csavarhúzó - hatszögű



mm	L mm	Ft	📦	📄
0,9	60	2.810	5	012570045
1,3	60	2.810	5	012570046
1,5	60	2.810	5	012570047
2	60	2.810	5	012570048
2,5	60	2.810	5	012570049
3	60	2.810	5	012570050

1257ESB/S8



1257ESB/S8	Ft	📦	📄
1257ES 0,9-1,3-1,5-2-2,5-3 mm 1257BE 4-5 mm	35.600	1	012570230

1257TX

Torx® műszerész csavarhúzó



♻️	L mm	Ft	📦	📄
T5	60	2.960	5	012570075
T6	60	2.960	5	012570076
T7	60	2.960	5	012570077
T8	60	2.960	5	012570078
T9	60	2.960	5	012570079
T10	60	2.960	5	012570080
T15	60	2.960	5	012570081
T20	60	2.960	5	012570082



1257TX/S8	Ft	📦	📄
T5-T6-T7-T8 T9-T10-T15-T20	34.950	1	012570220

1257BE

Műszerész csavarhúzó - hatszögű



♻️	L mm	Ft	📦	📄
3,2	60	3.700	5	012570085
4	60	3.700	5	012570086
5	60	3.700	5	012570087
5,5	60	3.700	5	012570088





A BetaGrip csavarhúzócsalád a Beta sok éves tapasztalatának és a motorsport csapatokkal való szoros együttműködésének gyümölcse.

A legigényesebb szakembereket is kielégítő új, egyedi műszaki megoldások kialakítása során a kiemelkedő ergonómiát, szilárdságot és anyagminőséget tartottuk szem előtt.

- A csavarhúzó éle speciális, magas szilícium, króm és vanádium tartalmú acélból készült, ami jobb csavaró- és hajlítoszilárdságot biztosít. Nem csillogó, matt krómozást kapott.
- A csavarhúzó fej formáját úgy tervezték, hogy az éle tökéletesen illeszkedjen a csavarfejbe. A foszfátzott kivitel megakadályozza a fej oxidálódását és biztosítja a profil pontosságát.
- A markolat textúráját a versenygumik futófelülete ihlette, mely minden felületen maximális tapadást biztosít. A csavarhúzó így minden munkakörülmény között hatékony fogást biztosít, amikor a fejet a csavarra illesztjük.

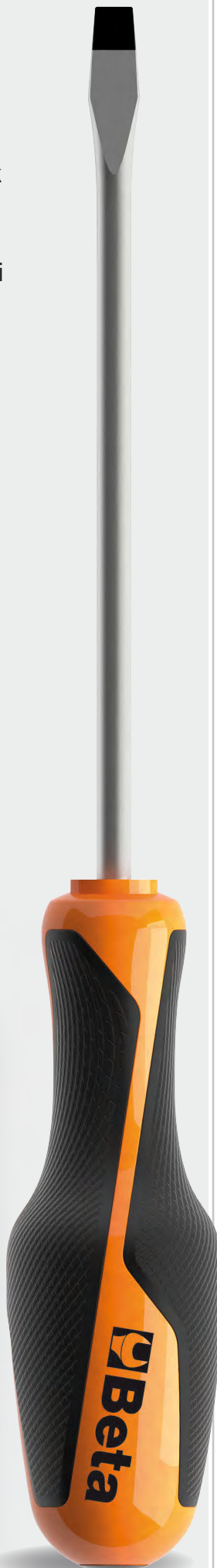

1260

Csavarhúzó hasítottfejű csavarokhoz



ISO 2380

SxAxL mm	L1 mm	Ø mm	Ft	☺	☹
0,4x2,5x50	150	2,5	2.570	5	012600003
0,4x2,5x75	175	2,5	2.670	5	012600006
0,5x3x75	175	3,0	2.730	5	012600009
0,5x3x100	200	3,0	2.830	5	012600012
0,6x3,5x75	175	3,5	2.910	5	012600018
0,6x3,5x100	200	3,5	2.960	5	012600021
0,8x4x100	208	4,0	3.240	5	012600030
0,8x4x125	233	4,0	3.360	5	012600033
0,8x4x150	258	4,0	3.500	5	012600036
1x5,5x100	208	5,0	3.700	5	012600039
1x5,5x125	233	5,0	3.790	5	012600040
1x5,5x150	258	5,0	4.130	5	012600042
1,2x6,5x100	219	6,0	4.450	5	012600048
1,2x6,5x125	244	6,0	4.620	5	012600050
1,2x6,5x150	269	6,0	4.820	5	012600051
1,2x8x150	277	8,0	5.870	3	012600057
1,2x8x200	327	8,0	6.070	3	012600060
1,6x10x200	327	9,5	7.330	3	012600066
2x12x250	377	10	8.740	3	012600069
2x14x250	377	10	9.230	2	012600073



Ft	☺	☹
23.800	1	012600306

0,4x2,5x75-0,5x3x75-0,8x4x125
1x5,5x150-1,2x6,5x150-1,2x8x200 mm

1260N

Csavarhúzó hasítottfejű csavarokhoz, extra rövid penge



ISO 2380

SxAxL mm	L1 mm	Ø mm	Ft	☺	☹
0,8x4x30	87	4	3.400	5	012600103
1,2x6,5x30	87	6	3.790	5	012600106



1260E

Csavarhúzó hasítottfejú csavarokhoz, hatszögű penge



ISO 2380

SxAxL mm	L1 mm	Ø mm	Ft		
1,2x6,5x150	269	6,0	6.230	3	012600156
1,2x8x175	301	8,0	7.650	3	012600157
1,6x10x200	327	9,5	8.870	2	012600159
2x12x250	377	9,5	10.300	2	012600162

1260MC

csavarhúzó hasítottfejú csavarokhoz, színezett



SxAxL mm	L1 mm	Ø mm	Ft		
0,4x2,5x50	150	2,5	2.790	3	012602003
0,6x3,5x75	175	3,5	2.870	3	012602018
0,8x4x100	208	4,0	3.400	3	012602030
1x5,5x150	233	5,0	4.370	5	012602040
1,2x6,5x150	269	6,0	5.020	5	012602051

1262

Phillips®-csavarhúzó



UNI/ISO 8764

PHxDxL mm	L1 mm	Ft		
0x3x60	160	2.730	5	012620003
0x3x100	200	2.890	5	012620006
1x4,5x80	188	3.580	5	012620009
1x4,5x120	228	3.910	5	012620012
2x6x100	219	4.410	5	012620018
2x6x150	269	4.860	5	012620021
3x8x150	277	6.520	3	012620024
4x10x200	327	8.300	3	012620027



1262/S4	Ft		
PH0x3x60-PH1x4,5x80 PH2x6x100-PH3x8x150 mm	17.250	1	012620304

1262N

Phillips®-csavarhúzó, extra rövid penge



UNI/ISO 8764

PHxDxL mm	L1 mm	Ft		
1x4,5x30	87	3.400	5	012620103
2x6x30	87	3.790	5	012620106

1262E

Phillips®-csavarhúzó, hatszögű penge



UNI/ISO 8764

PHxDxL mm	L1 mm	Ft		
2x6x150	269	6.230	3	012620153
3x8x175	302	7.570	3	012620156
4x10x200	327	9.510	2	012620159

1262L

Phillips®-csavarhúzó, hosszú penge



UNI/ISO 8764-1

PHxDxL mm	L1 mm	Ft		
0x3x300	400	4.740	3	012620203
1x4,5x300	400	5.670	3	012620205
1x4,5x400	508	6.560	3	012620206
2x6x400	519	8.540	3	012620209

1262MC

csavarhúzó keresztfejú Phillips® csavarokhoz, színezett



PHxDxL mm	L1 mm	Ft		
0x3x60	160	2.870	3	012622003
1x4,5x80	188	3.720	3	012622009
2x6x100	219	4.620	3	012622018

1263/D...

Csavarhúzókészlet



1263/D6	Ft		
1260	22.550	1	012630006

0,5x3x75-0,8x4x100
1x5,5x125-1,2x6,5x150 mm
1262 PH1x4,5x80-PH2x6x100 mm

1263/D7	Ft		
1262	23.250	1	012630017

PH0x3x60
PH1x4,5x80
PH2x6x100 mm
1264 0,5x2,5x60-0,6x3x100
0,8x4x125-1x5x125 mm

1263/D7PZ	Ft		
1260	27.000	1	012630007

0,5x3x75-0,8x4x100
1x5,5x150-1,2x6,5x150 mm
1269PZ PZ0 - PZ1 - PZ2

1263/D8	Ft		
1260	27.850	1	012630008

0,4x2,5x50-0,5x3x75
0,8x4x100-1x5,5x125
1,2x6,5x150 mm
1262 PH0x3x60-PH1x4,5x80
PH2x6x100 mm

1263/D10	Ft		
1260	35.500	1	012630010

0,5x3x75-0,6x3,5x100
0,8x4x125-1x5,5x150
1,2x6,5x150 mm
1260N 0,8x4x30
1262 PH0x3x60-PH1x4,5x80
PH2x6x100 mm
1262N PH1x4,5x30

1263/S12

12 darabos csavarhúzókészlet



1263/S12 Ft 50.850 1 012630112

1260 0,4x2,5x50-0,5x3x75
0,6x3,5x100-0,8x4x125
1x5,5x125-1,2x6,5x150
1,2x8x200-1,6x10x200 mm
1262 PH0x3x60-PH1x4,5x80
PH2x6x100-PH3x8x150 mm

1263MC/D8

8 darabos színes csavarhúzókészlet



1263MC/D8 Ft 29.650 1 012632008

1260MC 0,4x2,5x50-0,5x3x75
0,8x4x100-1x5,5x125
1,2x6,5x150 mm
1262MC PH0x3x60-PH1x4,5x80
PH2x6x100 mm

1264

Csavarhúzó hernyócsavarokhoz



SxAxL mm	L1 mm	Ft		
0,5x2,5x60	160	2.570	5	012640003
0,6x3x75	175	2.730	5	012640006
0,6x3x100	200	2.830	5	012640009
0,8x4x100	208	3.240	5	012640012
0,8x4x125	233	3.360	5	012640015
1x5x125	233	3.790	5	012640018
1x5x150	258	3.990	5	012640021
1,2x6,5x150	269	4.820	5	012640024



1264/S5 Ft 17.150 1 012640305
0,5x2,5x60-0,6x3x75
0,8x4x100-1x5x125-1,2x6,5x150 mm

1264L

Csavarhúzó hernyócsavarokhoz, hosszú penge

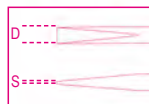

SxAxL mm	L1 mm	Ft		
0,5x2,5x200	300	3.830	3	012640203
0,6x3x300	400	4.490	3	012640206
0,8x4x400	508	5.870	3	012640209
1x5x400	508	6.560	3	012640215
1,2x6,5x400	519	7.980	3	012640218

1265ES

Hatlapú imbusz csavarhúzó



mm	L mm	L1 mm	Ft		
1,5	100	200	3.140	3	012650015
2	100	200	3.200	3	012650020
2,5	100	200	3.320	3	012650025
3	100	200	3.500	3	012650030
4	100	208	3.850	3	012650040
5	100	219	4.450	3	012650050
6	125	244	5.020	3	012650060
8	150	277	6.680	2	012650080



1265ES/S8 Ft 33.150 1 012650308
1,5-2-2,5-3-4-5-6-8 mm

1266BP

Hatlapú gömbfejű imbusz csavarhúzó

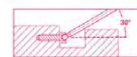

mm	L mm	L1 mm	Ft		
2	100	200	3.400	3	012660020
2,5	100	200	3.540	3	012660025
3	125	225	3.700	3	012660030
4	125	233	4.130	3	012660040
5	120	239	4.820	3	012660050
6	140	259	5.590	3	012660060
8	160	287	7.000	2	012660080
10	160	287	8.420	2	012660100



1266BP/S8 Ft 40.600 1 012660308
2-2,5-3-4-5-6-8-10 mm

1267TX

Imbusz csavarhúzó Torx®-csavarokhoz



T	L mm	L1 mm	Ø mm	Ft		
T5	50	150	3	3.830	5	012670005
T6	50	150	3	3.990	5	012670006
T7	50	150	3	4.130	5	012670007
T8	60	160	3	4.330	5	012670008
T9	60	167	4	4.490	5	012670009
T10	80	188	4	4.700	5	012670010
T15	80	188	4	4.940	5	012670015
T20	100	208	4,5	5.220	5	012670020
T25	100	208	5	5.670	5	012670025
T27	115	234	6	5.870	5	012670027
T30	115	234	6	6.190	5	012670030
T40	130	257	7	7.170	2	012670040
T45	130	257	8	7.890	2	012670045





1267TX/D7
T6-T8-T10-T15
T20-T25-T30

Ft 35.050 1 012670307



1267TX/S13
T5-T6-T7-T8-T9
T10-T15-T20-T25
T27-T30-T40-T45

Ft 68.400 1 012670312

1267MC/TX

Imbusz csavarhúzó Torx® csavarokhoz, nyéllel, színes



Ø	L mm	L1 mm	Ø mm	Ft	5	1
T6	50	150	3	4.210	5	012672006
T8	60	160	3	4.450	5	012672008
T10	80	188	4	4.900	5	012672010
T15	80	188	4	5.220	5	012672015
T20	100	208	4,5	5.590	5	012672020
T25	100	208	5	5.830	3	012672025
T30	115	234	6	6.400	3	012672030



1267MC/TX-D7
T6-T8-T10-T15
T20-T25-T30

Ft 36.600 1 012672307

1268RTX

Imbusz csavarhúzó Tamper Resistant Torx® csavarokhoz



Ø	L mm	L1 mm	Ø mm	Ft	3	5
T9	60	167	4,0	4.900	3	012680009
T10	80	188	4,0	5.060	3	012680010
T15	80	188	4,0	5.220	3	012680015
T20	100	208	4,5	5.670	3	012680020
T25	100	208	5,0	5.790	3	012680025
T27	115	234	6,0	6.190	3	012680027
T30	115	234	6,0	6.280	3	012680030
T40	130	257	7,0	7.250	2	012680040



1268RTX/S8
T9-T10-T15-T20
T25-T27-T30-T40

Ft 46.350 1 012680307

1269PZ

Csavarhúzó Pozidriv® és Supadriv® csavarokhoz



UNI/ISO 8764

PZ	L mm	L1 mm	Ft	5	3
0	60	160	3.120	5	012690000
1	80	188	4.050	5	012690001
2	100	219	4.900	5	012690002
3	150	277	7.000	3	012690003
4	200	327	8.950	3	012690004



1269PZ/S4
PZ0-PZ1-PZ2-PZ3

Ft 19.050 1 012690304

1269N/PZ

Csavarhúzó Pozidriv® és Supadriv® csavarokhoz, extra rövid penge



UNI/ISO 8764

PZ	L mm	L1 mm	Ft	5	5
1	30	87	3.400	5	012690011
2	30	87	3.790	5	012690012

1281BG

Csavarhúzónyél cserélhető szárhoz



L mm	Ø mm	Ft	5	1
118	10	5.750	5	012810280

1281PM

Mágneses betéttartó szár



L mm	Ft	5	1
165	9.800	5	012810292

1281PB

Dugókulcstartó szár 1/4"



L mm	Ft	5	1
175	7.850	5	012810293

1281LP

Cserélhető csavarhúzószár hasítottfejű csavarokhoz



	Ft	5	1
1281LP/1 0,8x4-1,2x6,5 mm	5.020	5	012810302
1281LP/2 1x5-1,2x6,5 mm	5.020	5	012810304

1281PH

Cserélhető csavarhúzószár Phillips®-csavarokhoz



PH	Ft	5	012810310
1-2	5.020		
2-3	5.020		012810312

1281LPH

Cserélhető csavarhúzószár hasítottfejű és Phillips®-csavarokhoz



	Ft	5	012810321
1281LPH/1 PH0-0,8x4 mm	5.020		
1281LPH/2 PH1-1x5,5 mm	5.020		012810322
1281LPH/3 PH2-1,2x6,5 mm	5.020		012810323

1281PZ

Cserélhető csavarhúzószár Pozidriv®- és Supadriv®-csavarokhoz



PZ	Ft	5	012810330
1-2	5.020		
2-3	5.020		012810332

1281PE

Cserélhető csavarhúzószár gömbölyű fejfel



mm	Ft	5	012810342
2,5	4.940		
3	4.940		012810343
4	4.940		012810344
5	4.940		012810345
6	4.940		012810346

1281TX

Cserélhető csavarhúzószár Torx®-csavarokhoz



	Ft	5	012810349
1281TX/1 T6-T8	5.510		
1281TX/2 T7-T9	5.510		012810350
1281TX/3 T10-T15	5.510		012810351
1281TX/4 T20-T25	5.510		012810352
1281TX/5 T30-T40	5.510		012810353

1281RTX

Cserélhető csavarhúzószár Tamper Resistant Torx®-csavarokhoz



	Ft	5	012810361
1281RTX/3 T10-T15	5.630		
1281RTX/4 T20-T25	5.630		012810362
1281RTX/5 T30-T40	5.630		012810363

1281BG/A9

9 darabos csavarhúzószár készlet 1 csavarhúzónyél, tokban



1281BG/A9	Ft	1	012810520
	58.500		

1281BG	
1281LPH/1	PH0-0,8x4 mm
1281LPH/2	PH1-1x5,5 mm
1281LPH/3	PH2-1,2x6,5 mm
1281PZ/1	PZ1-PZ2
1281PE	2,5 mm
1281PE	3 mm
1281PE	4 mm
1281PE	5 mm
1281PE	6 mm

1281BG-TX/A8

8 darabos csavarhúzószár készlet 1 csavarhúzónyél, tokban



1281BG-TX/A8	Ft	1	012810530
	56.300		

1281BG	
1281LPH/1	PH0-0,8x4 mm
1281LPH/2	PH1-1x5,5 mm
1281LPH/3	PH2-1,2x6,5 mm
1281TX/1	T6-T8
1281TX/2	T7-T9
1281TX/3	T10-T15
1281TX/4	T20-T25
1281TX/5	T30-T40

1281BG/B28NA

16 megfordítható csavarhúzószár, 9 dugókulcs 1/4", 2 tartozék és 1 csavarhúzónyél, műanyag tasakban



1281BG/B28NA	Ft	1	012810511
	129.700		

900	4 - 4,5 - 5 - 5,5 6 - 7 - 8 - 9 - 10 mm
1281BG	
1281PB	1/4"
900/25	
1281LP/1	0,8x4 - 1,2x6,5 mm
1281LP/2	1,0x5,5 - 1,2x6,5 mm
1281PH/1	PH1 - PH2
1281PH/2	PH2 - PH3
1281PZ/1	PZ1 - PZ2
1281PZ/2	PZ2 - PZ3
1281PE	2,5 - 3 - 4 - 5 - 6 mm
1281TX/1	T6 - T8
1281TX/2	T7 - T9
1281RTX/3	T10 - T15
1281RTX/4	T20 - T25
1281RTX/5	T30 - T40

2002/BV7-ZIP	Ft	1	020020060
	9.270		



A BetaMax csavarhúzó számos jellemzőjét úgy alakítottuk, hogy a munka még könnyebb legyen.

- A markolatot a háromszögletű rész ihlette, ami a csukló maximális elfordulásának megfelelően 120°-ban optimális csavarozást tesz lehetővé.
- A kialakítás gyorscsavarozás és megszorítás esetén is kiemelkedően ergonomikus tulajdonságokkal bír.
- A krómozatlan fej tökéletes illeszkedést biztosít a csavarra, a foszfátréteg pedig megvédi az oxidációtól.



1290

Phillips®-csavarhúzó



ISO 2380

SxAxL mm	L1 mm	Ø mm	Ft		
0,4x2,5x50	146	2,5	3.300	5	012900003
0,4x2,5x75	171	2,5	3.400	5	012900006
0,5x3x75	171	3,0	3.480	10	012900009
0,5x3x100	196	3,0	3.640	10	012900012
0,6x3,5x75	171	3,5	3.950	10	012900018
0,6x3,5x100	196	3,5	4.010	10	012900021
0,8x4x100	196	4,0	4.050	10	012900030
0,8x4x125	221	4,0	4.170	10	012900033
0,8x4x150	246	4,0	4.450	10	012900036
1x5,5x100	209	5,0	4.530	10	012900039
1x5,5x150	259	5,0	5.020	10	012900042
1,2x6,5x100	220	6,0	5.670	10	012900048
1,2x6,5x150	270	6,0	5.950	10	012900051
1,2x8x150	282	7,0	7.490	3	012900057
1,2x8x200	332	7,0	7.940	3	012900060
1,6x10x200	332	8,0	9.310	3	012900066
2x12x250	382	10	12.550	2	012900069

1290/S

Csavarhúzókészlet



1290/S5	Ft		
1290	26.000	1	012900305
			0,5x3x75-0,8x4x100 -1x5,5x150 1,2x6,5x150 -1,2x8x150 mm
1290/S9X	Ft		
1290	48.850	1	012900319
			0,4x2,5x75 - 0,5x3,5x100 0,8x4x125 - 1x5,5x150 1,2x6,5x150 - 1,2x8x200 1,6x10x200 mm
1290N			0,8x4x30 -1,2x6,5x30 mm

1290N

Extra rövid csavarhúzó hasítottfejú csavarokhoz



ISO 2380

SxAxL mm	L1 mm	Ø mm	Ft		
0,8x4x30	86	4	4.290	5	012900103
1,2x6,5x30	86	6	4.780	5	012900106

1292

Csavarhúzó Phillips®-csavarokhoz



UNI/ISO 8764

PHxDxL mm	L1 mm	Ft		
0x3x60	156	3.140	10	012920003
0x3x100	196	3.580	5	012920006
1x4,5x80	189	4.330	10	012920009
1x4,5x120	229	4.820	10	012920012
2x6x100	220	5.750	10	012920018
2x6x150	270	6.150	10	012920021
3x8x150	282	7.850	3	012920024
4x10x200	332	10.700	3	012920027



1292/S4	Ft		
PH0x3x60-PH1x4,5x80 PH2x6x100-PH3x8x150 mm	21.050	1	012920304

1292N

Extra rövid csavarhúzó Phillips®-csavarokhoz



UNI/ISO 8764

PHxDxL mm	L1 mm	Ft		
1x4,5x30	86	4.090	5	012920103
2x6x30	86	4.490	5	012920106

1292L

Hosszú csavarhúzó Phillips®-csavarokhoz



UNI/ISO 8764-1

PHxDxL mm	L1 mm	Ft		
0x3x300	396	7.000	3	012920203
1x4,5x400	509	8.620	3	012920206
2x6x400	520	10.500	3	012920209

1293/D...

Csavarhúzókészlet

Betamax
MAXIMUM PERFORMANCE



1293/D6 Ft 1 012930401

1290 0,6x3,5x75-1x5,5x150
1,2x6,5x150 mm
1292 PH0x3x60 -PH1x4,5x80
PH2x6x100 mm

1293/D8 Ft 1 012930403

1290 0,5x3x75-0,8x4x100
1x5,5x150-1,2x6,5x150
1,2x8x150 mm
1292 PH0x3x60 -PH1x4,5x80
PH2x6x100 mm

1293/S...

Csavarhúzókészlet

Betamax
MAXIMUM PERFORMANCE



1293/S8 Ft 1 012930208

1290 2,5x50-3x75-4x100-5,5x150
6,5x150 mm
1292 PH0x3x60 -PH1x4,5x80
PH2x6x100 mm

1293/S10 Ft 1 012930201

1290 0,4x2,5x50 -0,6x3,5x100
1x5,5x100-1,2x6,5x150
1,2x8x150-1,6x10x200 mm
1292 PH0x3x60 -PH1x4,5x80
PH2x6x100-PH3x8x150 mm

1293/S12 Ft 1 012930203

1290 0,5x3x75-0,8x4x125
1x5,5x150-1,2x6,5x150
1,2x8x200 mm
1290N 0,8x4x30 mm
1292 PH0x3x60 -PH1x4,5x80
PH2x6x100-PH3x8x150 mm
1292N PH1x4,5x30-PH2x6x30 mm

1293/S7 Ft 1 012930207

1292 PH0x3x60 -PH1x4,5x80
PH2x6x100 mm
1294 0,5x2,5x60-0,6x3x75
0,8x4x100-1x5x125 mm

1293ES

Hatlapú imbusz csavarhúzó

Betamax
MAXIMUM PERFORMANCE



	L	L1	Ø	Ft		
mm	mm	mm	mm			
2	100	196	3	4.450	5	012930001
2,5	100	196	4	4.450	5	012930002
3	100	196	4	4.570	5	012930003
4	100	196	5	5.180	5	012930004
5	100	209	6	5.750	5	012930005
6	125	245	7	6.520	5	012930006
8	150	282	10	8.620	2	012930008

Betamax
MAXIMUM PERFORMANCE



1293ES/S7 Ft 1 012930057

2-2,5-3-4-5-6-8 mm

1293BP

Hatlapú imbusz csavarhúzó

Betamax
MAXIMUM PERFORMANCE



	L	L1	Ft		
mm	mm	mm			
2	100	196	4.490	5	012930501
2,5	100	196	4.490	5	012930502
3	100	196	4.620	5	012930503
4	100	196	5.180	5	012930506
5	100	209	5.750	5	012930509
6	125	245	6.640	5	012930512
8	150	282	9.030	2	012930515

Betamax
MAXIMUM PERFORMANCE



1293BP/S7 Ft 1 012930558

2-2,5-3-4-5-6-8 mm

1294

Csavarhúzó henyőcsavarokhoz

Betamax
MAXIMUM PERFORMANCE



SxDxL	L1	Ft		
mm	mm			
0,5x2,5x60	156	3.080	5	012940003
0,6x3x75	171	3.260	5	012940006
0,6x3x100	196	3.340	5	012940009
0,8x4x100	196	4.050	5	012940012
0,8x4x150	246	5.300	5	012940015
1x5x125	234	5.060	5	012940018
1,2x6,5x150	282	6.030	5	012940027

Betamax
MAXIMUM PERFORMANCE



1294/S5 Ft 1 012940305

0,5x2,5x60-0,6x3x100
0,8x4x100-1x5x125
1,2x6,5x150 mm

1294L

Hosszú csavarhúzó henyőcsavarokhoz

Betamax
MAXIMUM PERFORMANCE



SxDxL	L1	Ft		
mm	mm			
0,6x3x300	396	6.720	3	012940206
0,8x4x400	496	7.940	3	012940209
1x5x400	509	9.720	3	012940215
1,2x6,5x400	532	10.950	3	012940218

1295

Útvevcsavarhúzó

12"

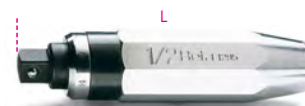

L Ft 1 012950001

130 28.750



1295/C14

Útvecsavarhúzó készlet 14 betéttel és betéttartóval



1295/C14 Ft 75.550 1 012950108

	866LP	1,2x6,5 - 1,6x10 mm
	866PH	PH2 - PH3
	866PZ	PZ2 - PZ3
	866PE	5 - 6 mm
	866TX	T27 - T30 - T40 - T45 - T50 - T55
	895/6	□ 1/2 - ○ 5/16
	1295	■ 1/2

170x100x35 mm - 1,3 kg

1297TX

Imbusz csavarhúzó Torx®-csavarokhoz



Ø	L mm	L1 mm	Ø mm	Ft	1	012970006
T6	50	146	3,0	5.830	5	012970006
T7	50	146	3,0	5.910	5	012970007
T8	60	156	3,0	5.950	5	012970008
T9	60	169	4,0	6.190	5	012970009
T10	80	189	4,0	6.600	5	012970010
T15	80	189	4,0	6.640	5	012970015
T20	100	209	4,5	6.800	5	012970020
T25	100	209	5,0	7.040	5	012970025
T27	115	235	6,0	7.250	5	012970027
T30	115	235	6,0	7.650	5	012970030
T40	130	262	7,0	8.500	2	012970040
T45	130	262	8,0	9.680	2	012970045



1297TX/S12 Ft 84.050 1 012970312
T6-T7-T8-T9-T10
T15-T20-T25-T27
T30-T40-T45

Betamax



1297TX/D6 Ft 42.000 1 012970409
T10-T15-T20
T25-T27-T30

1297TX/L

imbusz csavarhúzó Torx® csavarokhoz, hosszú



Ø	L mm	L1 mm	Ø mm	Ft	1	012970115
T15	210	319	4,0	7.410	2	012970115
T20	210	319	4,5	7.610	2	012970120
T25	210	319	5,0	7.850	2	012970125
T30	210	330	6,0	8.420	2	012970130
T45	210	342	8,0	9.150	2	012970145

Betamax

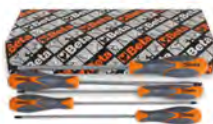

1297TX/L-S5 Ft 40.450 1 012970325
TX/L15-TX/L20-TX/L25-
TX/L30-TX/L45

1298RTX

Imbusz csavarhúzó Tamper Resistant Torx®-csavarokhoz



Ø	L mm	L1 mm	Ø mm	Ft	1	012980009
T9	60	169	4,0	6.800	5	012980009
T10	80	189	4,0	6.960	5	012980010
T15	80	189	4,0	7.410	5	012980015
T20	100	209	4,0	7.450	5	012980020
T25	100	209	4,5	7.610	5	012980025
T27	115	235	5,5	8.180	5	012980027
T30	115	235	6,0	8.500	5	012980030
T40	130	262	7,0	9.150	2	012980040

Betamax



1298RTX/S8 Ft 62.050 1 012980308
T9-T10-T15-T20
T25-T27-T30-T40

1299PZ

Csavarhúzó Pozidriv®- és Supadriv®-csavarokhoz



UNI/ISO 8764

PZ	L mm	L1 mm	Ft	1	012990000
0	60	156	4.530	5	012990000
1	80	189	5.340	5	012990003
2	100	220	7.250	5	012990006
3	150	282	10.500	2	012990009
4	200	332	14.950	2	012990012

Betamax



1299PZ/S6 Ft 38.600 1 012990306
1299PZ PZ0-PZ1-PZ2-PZ3
1299N/PZ PZ1-PZ2

1299N/PZ

Extra rövid csavarhúzó Pozidriv®- és Supadriv®-csavarokhoz



UNI/ISO 8764

PZ	L mm	L1 mm	Ft	1	012990021
1	30	86	5.180	5	012990021
2	30	86	5.750	5	012990024



Járműjavító szerszámainkat, amelyeket a legigényesebb szakemberek használnak, a világ legmagasabb követelményeinek megfelelően fejlesztettük és gyártottuk, és rendszeresen teszteljük a legnagyobb terhelést jelentő üzemi körülmények között.

Több mint 50 éve büszkén dolgozunk együtt a legnagyobbakkal, akik segítenek termékeink folyamatos fejlesztésében és biztosítják a legmagasabb minőségi színvonalnak való megfelelést.

A járműjavító eszközök az alábbi szakaszokban találhatóak:

DIAGNOSZTIKA	1464T/N - 1465 1498SM - 1499 1758VT - 1760/IR 1600
MOTOR	955 - 960SN 1440 - 1462/KEP 1472 - 1485TC 1737 - 1759TT
OLAJ ÉS SZŰRŐK	1488/1 - 1496/C 1877 - 1889N
ELEKTROMOS RENDSZER	1489/33 - 1489Y 1497D - 1497RC
GYORSINDÍTÓK	1498BC/12 - 1498DG1100E
ERŐÁTVITEL	1884 - 1885/X C60 1438 - 1438DSG 1566N - 1569/F
FELFÜGGESZTÉS	1550U - 1567
FÉKEK	1466/C5 - 1471T/C5
KEREKEK	720MRC - 729T 962 - 989B 1530/C5 - 1531/C7
KAROSSZÉRIA	1065F5 - 1068 1302 - 1369/C11 1478 - 1479U/32 1505V - 1539 1763 - 1768
EGYÉB BERENDEZÉSEK	1875LT - 3067
EMELÉSTECHNIKA	3006 - 3069

1302

Konvex egyengető idom, kerek, sima



g 770 Ft 44.550 1 013020001

1303

Hajlított egyengető idom



g 1350 Ft 33.600 1 013030001

1304

Egyengető alátét idom



g 875 Ft 42.300 1 013040001

1305

Egyengető idom



g 1190 Ft 26.900 1 013050001

1305Z

Rovátkás egyengető idom



g 1065 Ft 31.800 1 013050002

1306

Sarok egyengető idom

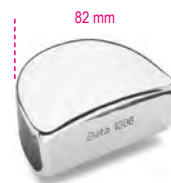

g 1040 Ft 25.100 1 013060001

1307

Normál egyengető idom

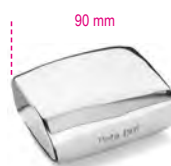

g 1100 Ft 49.400 1 013070001

1308

Ovális egyengető idom

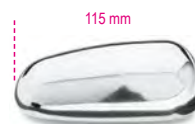

g 1100 Ft 46.150 1 013080001

1310

Univerzális idom



g 1225 Ft 28.550 1 013100001

1312

Üllő idom



g 1220 Ft 60.950 1 013120001

1314

Konvex és lapostetejű idom



g 760 Ft 27.100 1 013140001

1326

Kanálvas



g 560 Ft 24.300 1 013260001

1327

Erősített kanálvas



g 1075 Ft 33.800 1 013270001

1328

Emelő kanálvas



g 935 Ft 30.750 1 013280001

1329

Kettős kanálvas



g 1800 Ft 93.700 1 013290001

1330

Hosszú kettős kanálvas



g 2125 Ft 100.000 1 013300001

1331

Hajlítóvas bőr betéttel



g 1100 Ft 55.450 1 013310001

1335BM

Műanyag nyeles karosszéria reszelő



g 500 Ft 16.200 2 013350010

1337/S5

5 darabos karosszériareszelő készlet, acélból

japán típus
(25-50-75-100-125 mm)



L mm 25-50-75-100-125 Ft 6.230 1 013370015

1338A - 1338B

Karosszériareszelő reszelőlappal



L mm 360 Ft 45.750 2 013380001
1338B 12 360 48.400 2 013380002

1338

Karosszériareszelő az 1338R típusú reszelőlaphoz



1338 Ft 24.900 2 013380003

1338R9 - 1338R12

Reszelőlappal az 1338A-B típusú karosszériareszelőhöz



1338R9 9 Ft 20.850 2 013380004
1338R12 12 23.500 2 013380005

1342

Extravékony laposvágó, krómozott



L mm 235 Ft 14.550 5 013420001

1342PM

Extra-vékony laposvágó kézvédővel

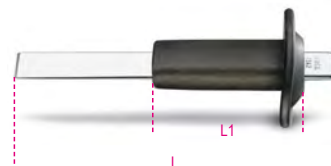

L mm 235 L1 mm 118 Ft 20.500 2 013420002

1342PMR

Tartalék kézvédő az 1342 típusú laposvágóhoz



1342PMR Ft 5.950 1 013420003

1343

Oldalvágó, krómozott



L mm 200 Ft 15.200 5 013430001

1344A/VW

célszerszám
a VW ajtókilincs szereléséhez



L
mm
260

Ft
7.980

1 013440100

1345

Karosszérialapács,
kerekek domború fejjel, fanyéllal



1345

Ft
21.450

2 013450010

1351

Karosszérialapács,
kerekek lapos fejjel, fanyéllal



1351

Ft
21.450

2 013510010

1353

Karosszérialapács,
kerekek lapos fejjel, fanyéllal



1353

Ft
21.450

2 013530010

1357Z/45

Karosszérialapács lapos,
kerekek rovátkás és sima négyszög fejjel,
fanyéllal



1357Z/45

Ft
35.000

2 013570045

1359T

Karosszérialapács, kerek lapos
és horizontális fejjel, fanyéllal



1359 T

Ft
21.450

2 013590010

1360/K6

sík kerek fejú alumínium kalapács,
cserélhető műanyag hegyek és metszőtű

a következő tartozékokkal:

- 4 műanyag hegy
- 1 darab, 2 különböző hosszúságra állítható metszőtű a kalapácsra illeszthető



L
mm
320

Ø
mm
34

Ft
40.500

1 013600006

1360/KP3

gömbfejű kalapács, cserélhető
hegyek és metszőtűk, műanyag

Készlet tartalma:

- 1 210 g súlyú kalapács Ø 30 mm fejjel
- 1 290 g súlyú kalapács Ø 40 mm fejjel
- 1 75 g tűske 5 mm hegygel



1360/KP3

Ft
39.050

1 013600503

1361/C12

Teflon® rúd készlet
karosszériajavító műhelyek számára



1361/C12

Ft
60.950

1 013610012

275x160x57 mm

1361/K9

8 rúdból álló készlet karosszériahorpadás
javításához

A készlet tartalma:

- gömbölyű fejú rúd, Ø 31 mm, hossz 110 cm
- csúcsos rúd, hossz 62 cm
- széles fejú rúd, hossz 112 cm
- horgos rúd, hossz 27 cm
- lapos, kerek fejú rúd, hossz 50 cm
- gömbölyű fejú rúd, Ø 19 mm, hossz 52 cm
- széles fejú rúd, hossz 27 cm
- kerek széles fejú rúd, hossz 28 cm
- vászonzsák markolatokkal

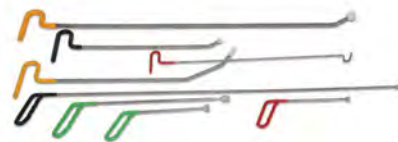

1361/K9

Ft
143.700

1 013610030

1364SE

állítható karosszériatartó állvány

Jellemzők:

- 4 forgókerék, 2 fékezhető
- az állvány 1 400 mm szélességig állítható
- az állvány 1 315 mm magasságig állítható
- rögzíthető
- az érintkező felület eltávolítható gumiborítással rendelkezik

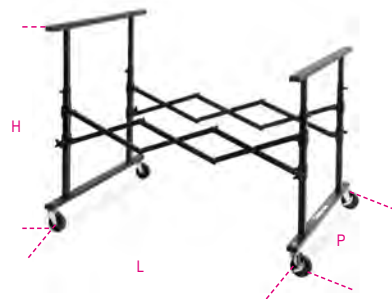

L
mm
215÷1400

H
mm
780÷1315

P
mm
890

Ft
190.300

1 013640001

1364SV

karosszériatartó állvány
tálcával

Jellemzők:

- polietilénnel fedett érintkező felület
- tálca méretei: 340x845x40 mm
- összehajtható



H
mm
1000

Ft
108.100

1 013640002

1364SCP

forgatható karosszériatartó állvány

különösen alkalmas motorháztetőkhöz, sárvédőkhöz és ajtókhöz

4 kerék, ebből 2 fékezhető forgókerék

• maximum 180°-ban elforgatható



H mm	L mm	P mm	Ft		
1300	1100	680	173.300	1	013640003

1364SP

karosszéria tartó állvány tapadókorongokkal

különösen alkalmas ablakokhoz

4 tapadókoronggal szállítva, Ø 95 mm

a szélessége láncsal állítható

polietilénrel burkolt cső



H mm	L mm	Ft		
1250	950	86.450	1	013640004

1364SR

kerékes adagoló
tekerces maszkoló papírhoz

Jellemzők:

- 2 kerék
- 3 papírtekerces tartó, beépített vágópengével
- beépített papírszalag tartó
- max. papírtekerces méret: 350 - 650 - 1050 mm



L mm	P mm	H mm	H1 mm	Ft	
1530	520	1080	960	110.500	1 013640005

1365/K13

10 t hidrodinamikus szivattyú és tartozék
készlet karosszéria javításhoz
húzható táskában

A készlet a következőket tartalmazza:

- 10 tonnás hidrodinamikus szivattyú 1,5 méteres hajlékony csővel, 1/2" csatlakozóval
- dugattyú
- sárvédő húzó fogó, terhelhetőség 500 kg
- támasztó talp 150x90 mm
- "L" alap 50x50 mm
- 4 pontos lyukasztó
- Ø 50 mm kerek recézett lyukasztó
- 43 mm kúpos lyukasztó
- hosszabbító 170 mm
- hosszabbító 300 mm
- hosszabbító 400 mm
- hosszabbító 530 mm
- gumi fej
- külső-külső csatlakozó tartozék szereléshez



1365/K13	Ft		
900x420x180 mm	374.500	1	013650013

1365P10

hidrodinamikus szivattyú

1,5 méteres hajlékony cső, 1/2" csatlakozó



1365P10	Ft		
	167.200	1	013650110

1366A

buborék eltávolító szerszám
19 műanyag gombás készlettel

a következőkhöz ideális:

- jégverés buborékok
- ajtó rányitás okozta horpadások
- kisebb általános horpadások



1366A	Ft		
	42.100	1	013660200

1366B

csúszókalapács
horpadáskihúzó gombákhoz

a csúszókalapács súlya: 500 g



L mm	Ft		
440	23.700	1	013660250

1366KF

19 műanyag gombából álló
készlet a 1366A cikkszámhoz



1366/KF	Ft		
	15.400	1	013660205

1366/K5

1,1 kg csúszókalapácsos pneumatikus
horpadás kihúzó

A készlet a következőket tartalmazza:

- 1 db Ø 75 mm tapadókorong
- 1 db Ø 100 mm tapadókorong
- 1 db Ø 125 mm tapadókorong
- 1 horog



1366/K5	Ft		
610x240x90 mm	110.500	1	013660010

1068

állítható önzáró fogó csúszókalapáccsal

a csúszókalapács súlya: 1 kg

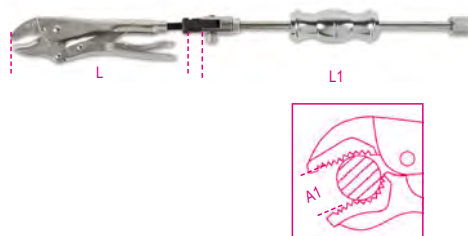

L mm	L1 mm	A1 Max mm	Ft	
260	365	19	56.900	1 010680000

1366SH

multifunkcionális spotter
karosszéria javításhoz

- mikroprocesszor segíti a hegesztési paraméterek kezelését
- kontakt és manuális hegesztési ciklus indítás
- automatikus ponthegesztési időbeállítási funkció
- gyorscsatlakozós hegesztőpisztollyal és 2,2 m földelt kábellel szállítva

A tartozék készlet tartalma:

- kihúzó kalapács
- 3 pontos alátét lemez
- 10 3 pontos alátét
- szélelektroda
- elektroda alátétekhez



Műszaki adatok:

- Tápellátás: 230V
- 50% teljesítmény: 2,5 KVA
- Csúcsteljesítmény: 13 KVA
- Amper teljesítmény: 2850 (2%) A
- Max. Amper teljesítmény: 3200A

1366SH Ft 943.300 1 013660400

1366SH/C

kocsi a 1366SH spotterhez



1366SH/C Ft 184.200 1 013660410

1366SL

húzókar
lemez helyreállításhoz

többhorgos csuklós fej
hullámhuzalal történő használathoz



L Ft
mm 700 111.300 1 013660002

1366S/R1

3 pontos alátét
befogó



1366S/R1 Ft 11.150 1 013660501

1366S/R2

3 pontos alátét
lemez kihúzáshoz



1366S/R2 Ft 11.150 1 013660502

A jelzett árak 20 darabra vonatkoznak

1366S/R3

elektroda alátétekhez
Ø 8x16x1,5 mm



1366S/R3 Ft 13.350 1 013660503

1366S/R4

horog Ø 8x16x1,5 mm alátétekhez



1366S/R4 Ft 11.550 1 013660504

1366S/R5

alátétek Ø 8x16x1,5mm



1366S/R5 Ft 6.360 1 013660505
A jelzett árak 100 darabra vonatkoznak

1366S/R6

elektroda M5-M6 csavarokhoz



1366S/R6 Ft 12.750 1 013660506

1366S/R7

100 önmetsző csap 5x18 mm



1366S/R7 Ft 11.150 1 013660507

1366S/R8

100 önmetsző csap 5x25 mm



1366S/R8 Ft 15.200 1 013660508

1366S/R9

100 menetes csap M5 x 18 mm



1366S/R9 Ft 10.100 1 013660509

1366S/R10

10 peremes alátét



1366S/R10 Ft 7.040 1 013660510

1366S/R11

elektroda peremes alátétekhez



1366S/R11 Ft 35.800 1 013660511

1366S/R12

10 peremes alátét 90°



1366S/R12 Ft 13.950 1 013660512

1366S/R13

lemezmelegítő
szénelektroda



1366S/R13	Ft 25.900			1 013660513
-----------	--------------	--	--	-------------

A jelzett árak 5 darabra vonatkoznak

1366S/R14

elektroda huzalhegyezéshez



1366S/R14	Ft 12.550			1 013660514
-----------	--------------	--	--	-------------

1366S/R21

hullámhuzal húzókar
és húzó keresztartó használatához



1366S/R21	Ft 8.740			1 013660551
-----------	-------------	--	--	-------------

A jelzett árak 10 darabra vonatkoznak

1366S/R22

mágneses tartó
hullámhuzal részére



1366S/R22	Ft 30.150			1 013660552
-----------	--------------	--	--	-------------

1366S/R24

M4 húzógyűrű



1366S/R24	Ft 34.800			1 013660554
-----------	--------------	--	--	-------------

A jelzett árak 5 darabra vonatkoznak

1366S/R25

M5 húzógyűrű



1366S/R25	Ft 34.800			1 013660555
-----------	--------------	--	--	-------------

A jelzett árak 5 darabra vonatkoznak

1366S/R26

M6 húzógyűrű



1366S/R26	Ft 34.800			1 013660556
-----------	--------------	--	--	-------------

A jelzett árak 5 darabra vonatkoznak

1367/K4

Rögzítő bilincs készlet, íves kivitel



Maximális pofanyílás: 6,5 mm

1367/K4	L mm	H mm	S mm	Ft			1 013670010
	62	40÷58	15,7	31.150			

1367/K10

kivágó készlet parkolásérzékelők
felszereléséhez

Készlet tartalma:

• méretek: 17 - 18 - 18,2 - 19 - 20 - 22,5 - 24 - 26 - 26,7 - 32 mm



Ø 12 mm

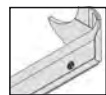

1367/K10	Ft			1 013670200
	85.400			

190x130x58 mm

1368

műanyagjavító készlet

• lehetővé teszi a műanyag alkatrészekben a repedések és törések gyors javítását

Tápfeszültség: 220÷240 V Shuko csatlakozóval

Hőpisztoly kábel hossza: 3,5 m

Tápvezeték hossza: 1,35 m

2 teljesítmény szint: 35-75 W

Hőpisztoly rézterminálokkal, 2 féle rögzítőkapocs beillesztő szöggel: 0°-90°

Bemeneti védelem: hőmegszakító

Kimeneti védelem: 10 A biztosíték

Fémzseb a pisztoly elhelyezésére

CE



1368	Ft			1 013680001
	200.000			

1368G/K400

400 rögzítőkapocs készlet
a 1368 készülékhez



1368G/K400	Ft			1 013680140
	34.150			

1368G/OD

hullámos egyenes rögzítőkapcsok a 1368
modellhez



1368G/OD	Ft			1 013680100
	8.540			

A megadott árak 100 darabra vonatkoznak.

1368G/SD

spirális egyenes rögzítőkapcsok a 1368
modellhez



1368G/SD	Ft			1 013680110
	8.540			

A megadott árak 100 darabra vonatkoznak.

1368G/CV

rögzítőkapcsok konvex szögekhez a 1368
modellhez



1368G/CV	Ft			1 013680120
	8.540			

A megadott árak 100 darabra vonatkoznak.

1368G/C2U

rögzítőkapcsok konkáv szögekhez a 1368
modellhez



1368G/C2U	Ft			1 013680130
	8.540			

A megadott árak 100 darabra vonatkoznak.





KALAPÁCSNYELEK

Hikori fából készült kalapácsnyelek:

A hikori fa kiváló tulajdonságokkal rendelkezik, amely tökéletesen megfelel kalapácsnyélnek. Hosszú szálszerkezete elnyeli a rezgést és rendkívül ellenállóvá teszi töréssel szemben. Abban a valószínűtlen esetben, ha egyes szálak elszakadnak, a fej hirtelen leválásának kockázata mindenképp elenyésző.

Elhasználódás esetén a nyél cserélhető.

Mivel a fa természetes anyag, megőrzi saját nedvességtartalmát. Ezért a kalapácsot ne tárolja túl száraz helyen.

Üvegszálból készült kalapácsnyelek:

Az üvegszál maggal ellátott kalapácsnyelek egyaránt tartósak és biztonságosak; a törés és sérülés kockázata minimális.

Ellenállnak az időjárásnak és a leggyakoribb vegyi anyagoknak.



• Kivételes keménységű üvegszálás mag

• Ergonomikus polipropilén váz

• Csúszásmentes, kényelmes elasztomer bevonat

1369/C11

11 darabos szerszámkészlet



1369/C11 Ft 399.200 1 013690033

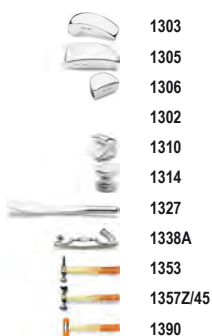

470x340x70 mm - 15,2 kg

1370

Lakatos kalapács német modell, fanyéllal



HICKORY

UNI 7778 DIN 1041

g	A mm	L mm	L1 mm	Ft		
100	15	260	82	5.670	5	013700051
200	19	280	95	6.360	5	013700052
300	23	300	105	7.250	5	013700053
400	25	310	112	8.260	5	013700054
500	27	320	118	8.870	5	013700055
600	30	330	122	10.300	5	013700056
800	33	350	130	11.550	4	013700058
1000	36	360	135	13.750	4	013700060
1500	42	380	145	15.800	2	013700065
2000	47	400	155	18.600	1	013700070

1370/MR...

Tartalék nyél a 1370-hez



	Ft		
1370MR 100 1370/100	2.530	4	013700081
1370MR 200 1370/200	2.830	4	013700082
1370MR 300 1370/300	3.080	4	013700083
1370MR 400 1370/400	3.300	4	013700084
1370MR 500 1370/500	3.600	4	013700085
1370MR 600 1370/600	3.990	4	013700086
1370MR 800 1370/800	4.170	4	013700088
1370MR 1000 1370/1000	4.450	4	013700090
1370MR 1500 1370/1500	5.020	4	013700095
1370MR 2000 1370/2000	5.670	4	013700100

1370T

Lakatos kalapács német modell műanyag nyéllal



g	A mm	L mm	L1 mm	Ft		
200	19	280	95	9.800	5	013700620
300	23	300	105	10.700	5	013700630
500	27	320	118	11.750	5	013700650
800	33	350	130	12.550	4	013700680
1000	36	360	135	15.800	4	013700700
1500	42	365	145	18.400	2	013700750

1370F

Biztonsági lakatos kalapács, francia modell, fanyéllal



NF E 71.014

A mm	L mm	L1 mm	Ft		
24	260	77	280	9.840	2 013700424
26	260	80	310	10.300	2 013700426
28	280	86	400	11.150	2 013700428
30	280	92	450	11.550	2 013700430
32	300	100	550	12.350	2 013700432
36	300	104	720	15.800	2 013700436
40	330	110	1065	17.400	2 013700440
42	330	116	1080	18.400	2 013700442
50	380	138	1760	19.450	2 013700450
60	380	160	2585	24.100	2 013700460

1370F/MR...

Tartaléknyél a 1370F-hez



	Ft	☞	☞
1370F/MR 24	2.490	2	013700474
1370F/24-26			
1370F/MR 28	2.710	2	013700478
1370F/28-30			
1370F/MR 32	3.140	2	013700482
1370F/32-36			
1370F/MR 40	3.950	2	013700490
1370F/40-42			
1370F/MR 50	4.450	2	013700495
1370F/50			
1370F/MR 60	5.380	2	013700496
1370F/60			

1370FT

Lakatos kalapács, francia modell, műanyag nyéllel



A mm	L mm	L1 mm		Ft	☞	☞
28	280	86	530	16.000	1	013700528
30	280	92	625	16.800	1	013700530
32	300	100	750	17.400	1	013700532
36	300	104	930	20.650	1	013700536
40	330	110	1150	21.850	1	013700540
42	330	116	1250	22.450	1	013700542
50	380	138	2100	25.300	1	013700550
60	380	160	2750	27.300	1	013700560

1374F

Asztaloskalapács, francia modell, fanyélllel



NF E 71.012

A mm	L mm	L1 mm		Ft	☞	☞
16	250	80	180	7.890	2	013740416
20	270	86	250	8.790	2	013740420
22	290	92	335	9.030	2	013740422
26	290	103	425	10.100	2	013740426
28	310	108	510	10.700	2	013740428
30	310	117	580	11.350	2	013740430

1374F/MR...

Tartaléknyél a 1374F-hez



	Ft	☞	☞
1374F/MR 16	2.310	2	013740456
1374F/16			
1374F/MR 20	2.370	2	013740460
1374F/20			
1374F/MR 22	2.410	2	013740462
1374F/22-26			
1374F/MR 28	2.710	2	013740468
1374F/28			
1374F/MR 30	2.910	2	013740470
1374F/30			

1375

Ácskalapács, fanyélllel



g	L1 mm	Ø mm	L mm	Ft	☞	☞
300	95	25	300	9.030	3	013750000

1375/MR

Tartaléknyél a 1375-höz



	Ft	☞	☞
1375/MR	4.130	2	013750003

1375A

ácskalapács, műanyag és üvegszál nyél



oz	g	L mm	L1 mm	Ft	☞	☞
16	450	330	130	13.150	3	013750016
20	570	330	130	13.750	3	013750020

1375B

Ácskalapács, acélnyéllel



oz	g	L mm	L1 mm	Ft	☞	☞
16	450	330	130	11.950	3	013750026
20	570	330	130	12.350	3	013750030

1376X

Szögletes fejű ácskalapács épületasztalosoknak, fanyélllel



g	A mm	L1 mm	L mm	Ft	☞	☞
250	20	125	450	8.620	3	013760125
300	25	130	450	9.150	3	013760130
400	27	132	450	10.050	3	013760140

1376X/MR

Tartalék nyél 1376X-hez



	Ft	☞	☞
1376X/MR	4.860	2	013760161

1376XT

Szögletes fejű ácskalapács épületasztalosoknak, műanyag nyéllel



g	A mm	L1 mm	L mm	Ft	☞	☞
250	20	125	500	10.300	3	013760525
300	25	130	500	11.150	3	013760530
400	27	132	500	11.750	3	013760540

1376XT/MR

Tartaléknyél a 1376XT modellhez



	Ft	☞	☞
1376MR/XT	5.630	2	013760585

1377

Gömbfejű lakatos kalapács, amerikai modell, fanyélllel



HICKORY

g	L mm	L1 mm	Ft	☞	☞
340	330	95	13.150	2	013770134
450	350	102	13.750	2	013770145
570	350	110	15.800	2	013770157
680	360	116	16.400	2	013770168
900	380	120	17.200	2	013770190

1377/MR...

Tartaléknyél a 1377-hez



	Ft	☞	☞
1377MR 340	2.870	2	013770234
1377/340			
1377MR 450	3.300	2	013770245
1377/450			
1377MR 570	3.640	2	013770257
1377/570			
1377MR 680	3.700	2	013770268
1377/680			
1377MR 900	4.620	2	013770290
1377/900			

1377T

kerekfejű és gömbfokú kalapács kazánkovácsok és bádigosok számára
Faser nyél



g	L mm	L1 mm	Ft	🔧	📄
340	330	95	12.350	2	013770534
450	350	102	14.750	2	013770545
570	350	110	16.000	2	013770557
680	360	116	17.200	2	013770568
900	380	120	19.650	2	013770590

1378

Gömbfejű lakatos kalapács szimmetrikus véggel, amerikai modell, fanyéllal



HICKORY

g	L mm	L1 mm	Ø mm	Ft	🔧	📄
340	330	100	27	11.950	2	013780134
570	350	115	32	15.800	2	013780157

1378/MR...

Tartaléknyél a 1378-hoz



	Ft	🔧	📄
1378MR 340 1378/340	2.710	2	013780234
1378MR 570 1378/570	3.790	2	013780257

1379F

Műszerész kalapács, francia modell, fanyéllal



HICKORY

NF E 71.011

A mm	L mm	L1 mm	Ft	🔧	📄
16	250	126	7.850	2	013790416
18	250	135	8.540	2	013790418
20	260	142	9.030	2	013790420

1379F/MR...

Tartaléknyél a 1379F-hez



	Ft	🔧	📄
1379F/MR 16 1379F/16-18	2.450	2	013790426
1379F/MR 20 1379F/20	2.710	2	013790430

1380

Ráverő kalapács, fanyéllal



HICKORY

UNI 7777 DIN 6475

g	A mm	L mm	L1 mm	Ft	🔧	📄
800	38	260	90	10.050	2	013800208
1000	40	260	95	10.700	2	013800210
1250	43	260	100	11.350	2	013800212
1500	45	280	110	13.150	2	013800215
2000	50	300	120	17.000	2	013800220

1380/MR...

Tartaléknyél a 1380-hoz



	Ft	🔧	📄
1380MR 800 1380/800-1000-1250	3.180	2	013800238
1380MR 1500 1380/1500	3.400	2	013800245
1380MR 2000 1380/2000	3.910	2	013800250

1380S

Ráverő kalapács nyélvédővel, fanyéllal



g	A mm	L mm	L1 mm	Ft	🔧	📄
800	36	260	90	11.150	2	013800400
1000	39	260	95	12.350	2	013800405
1250	43	260	100	13.150	2	013800410
1500	45	260	110	14.750	2	013800415

1380S/MR...

Tartaléknyél a 1380S-hez



	Ft	🔧	📄
1380S/MR 800 1380S/800-1000-1250	3.300	2	013800417
1380S/MR 1500 1380S/1500	3.600	2	013800419

1380T

Ráverőkalapács, műanyag nyéllal



g	A mm	L mm	L1 mm	Ft	🔧	📄
800	35	260	85	15.400	2	013800308
1000	40	260	100	15.600	2	013800310
1250	42	260	110	16.400	2	013800312
1500	45	260	120	17.600	2	013800315
2000	49	295	120	21.450	1	013800320

1381

Hosszú ráverő kalapács Hickory nyéllal



HICKORY

g	A mm	L mm	L1 mm	Ft	🔧	📄
3000	55	800	142	40.900	1	013810030
4000	60	900	152	45.750	1	013810040
5000	70	900	162	51.800	1	013810050
8000	80	900	185	89.650	1	013810080

* = kórisfa nyél

1381/MR...

Tartaléknyél a 1381-hez



	Ft	🔧	📄
1381MR 3-4 1381/3000-4000	20.250	2	013810730
1381MR 5 1381/5000	21.250	2	013810750
1381MR 8 1381/8000	21.250	2	013810780

1381T

Ráverőkalapács, műanyagnyél



g	A mm	L mm	L1 mm	Ft	🔧	📄
3000	55	900	142	44.550	1	013810330
4000	60	900	152	48.800	1	013810340
5000	70	900	162	55.650	1	013810350
8000	82	920	180	102.800	1	013810380

1385

Bronzkalapács, fanyéllal



g	A mm	L mm	L1 mm	Ft		
400	26	260	75	15.600	2	013850404
600	32	270	80	22.450	2	013850406
800	34	280	90	29.550	2	013850408
1000	37	280	100	36.850	2	013850410
1500	43	280	110	54.050	2	013850415
2000	48	300	120	72.850	1	013850420

1385/MR

Tartaléknyél a 1385 modellhez



	Ft		
1385MR 400 1385 400	4.450	2	013850464
1385MR 600 1385 600	4.570	2	013850466
1385MR 800 1385 800	4.740	2	013850468
1385MR 1000 1385 1000	5.060	2	013850470
1385MR 1500 1385 1500	5.670	1	013850475
1385MR 2000 1385 2000	5.790	1	013850480

1390

Műanyag kalapács, cserélhető végekkel, fanyéllal



UNI 7784

Ø mm	L mm	L1 mm	Ft		
22	260	70	8.870	5	013900022
28	280	85	10.950	5	013900028
35	310	95	14.950	5	013900035
45	320	107	23.900	4	013900045
60	380	128	40.300	2	013900060

1390/MR...

Tartaléknyél a 1390-hez



	Ft		
1390MR 22 1390/22	2.170	2	013900222
1390MR 28 1390/28	2.490	2	013900228
1390MR 35 1390/35	2.960	2	013900235
1390MR 45 1390/45	3.600	2	013900245
1390MR 60 1390/60	4.450	2	013900260

1390R

Tartalék végek 1390-hez



Ø mm	Ft		
22	1.400	4	013900122
28	2.150	4	013900128
35	2.870	4	013900135
45	4.860	4	013900145
60	8.420	4	013900160

1390N

Kalapács cserélhető Nylon-végekkel, fanyéllal

Középkemény végek: 75 Shore
Olaj- és kopásálló
Lemezek és fémek megmunkálására alkalmas



UNI 7784

Ø mm	L mm	L1 mm	Ft		
22	260	70	8.870	3	013900522
28	280	85	10.950	3	013900528
35	310	95	14.950	3	013900535
45	320	107	23.900	2	013900545
60	380	128	40.300	2	013900560

1390NR

Tartalék Nylon-végek 1390N modellhez



Ø mm	Ft		
22	1.400	4	013900622
28	2.150	4	013900628
35	2.870	4	013900635
45	4.860	4	013900645
60	8.420	4	013900660

1391

Gumikalapács



Ø mm	L mm	L1 mm	Ft		
35	280	90	13.550	2	013910135
50	320	105	17.600	2	013910150
55	355	110	20.850	2	013910155
65	380	130	28.750	2	013910165

1391A

Csempéző kalapács, fehér gumiból



g	Ø mm	L mm	L1 mm	Ft		
500	45	290	100	12.750	2	013910205
1000	60	300	120	17.000	2	013910210

1392

Útéselyelő műanyag kalapács, cserélhető végekkel, acélnyéllal



Ø mm	L mm	L1 mm	Ft		
30	300	105	22.850	2	013920030
35	305	115	24.500	2	013920035
40	310	125	28.350	2	013920040
50	325	135	33.200	2	013920050
60	385	155	51.200	2	013920060

1392R

Tartalék végek az 1392-hez



Ø mm	Ft		
30	3.080	4	013920230
35	4.490	4	013920235
40	6.800	4	013920240
50	9.070	4	013920250
60	13.550	4	013920260

1393

Gumikalapács



Ø mm	L mm	L1 mm	Ft		
50	315	90	6.030	3	013930050
60	340	110	6.800	3	013930060
70	370	130	8.180	2	013930070

Járműjavító szerszámainkat, amelyeket a legigényesebb szakemberek használnak, a világ legmagasabb követelményeinek megfelelően fejlesztettük és gyártottuk, és rendszeresen teszteljük a legnagyobb terhelést jelentő üzemi körülmények között.

Több mint 50 éve büszkén dolgozunk együtt a legnagyobbakkal, akik segítenek termékeink folyamatos fejlesztésében és biztosítják a legmagasabb minőségi színvonalnak való megfelelést.

A járműjavító eszközök az alábbi szakaszokban találhatók:

DIAGNOSZTIKA	
1464T/N - 1465	1498SM - 1499
1758VT - 1760/IR	1600
MOTOR	
955 - 960SN	1440 - 1462/KEP
1472 - 1485TC	1737 - 1759TT
OLAJ ÉS SZŰRŐK	
1488/1 - 1496/C	1877 - 1889N
ELEKTROMOS RENDSZER	
1489/33 - 1489Y	1497D - 1497RC
GYORSINDÍTÓK	
1498BC/12 - 1498DG	1100E
ERŐÁTVITEL	
1884 - 1885/X C60	1438 - 1438DSG
1566N - 1569/F	
FELFÜGGESZTÉS	
1550U - 1567	
FÉKEK	
1466/C5 - 1471T/C5	
KEREKEK	
720MRC - 729T	962 - 989B
1530/C5 - 1531/C7	
KAROSSZÉRIA	
1065F5 - 1068	1302 - 1369/C11
1478 - 1479U/32	1505V - 1539
1763 - 1768	
EGYÉB BERENDEZÉSEK	
1875LT - 3067	
EMELÉSTECHNIKA	
3006 - 3069	

1410/M Gumigyűrű kiszedő szerszám



Ø mm	Ft	📦	🏠
3,5	8.660	2	014100051

1428 Sérültfejű csavar kiszedő



Ø mm	□	L mm	○	Ft	📦	🏠
8	3/8	36	17	8.620	2	014280008
10	3/8	36	17	8.620	2	014280010
11	3/8	36	17	8.620	2	014280011
12	3/8	36	19	8.620	2	014280012
13	3/8	36	19	8.620	2	014280013
14	3/8	36	19	8.620	2	014280014
15	1/2	38	21	9.150	2	014280015
16	1/2	38	21	9.150	2	014280016
17	1/2	38	21	9.150	2	014280017
18	1/2	38	26	9.150	2	014280018
19	1/2	38	26	9.150	2	014280019
20	1/2	38	26	10.100	2	014280020
21	1/2	38	26	10.100	2	014280021
22	1/2	38	26	11.150	2	014280022
24	1/2	38	26	11.150	2	014280024
27	1/2	38	26	11.550	2	014280027



Model	Ft	📦	🏠
1428/SB11 8-10-11-12-13-14 15-16-17-18-19 mm	105.200	1	014280111
1428/SB5 20-21-22-24-27 mm	58.400	1	014280115

1428L/B3



Model	Ft	📦	🏠
1428L/B3 17-19-21 mm	68.800	1	014280303

1429 Törtcsavarkiszedő



mm	□	L mm	Ft	📦	🏠
2	3/8	60	5.710	3	014290002
3	3/8	60	5.710	3	014290003
4	3/8	60	5.710	3	014290004
5	3/8	60	6.030	2	014290005
6	3/8	60	6.030	2	014290006
8	1/2	70	6.560	2	014290008
10	1/2	70	6.680	2	014290010



Model	Ft	📦	🏠
1429/SB7 2-3-4-5-6-8-10 mm	47.800	1	014290107

1430/... Törtcsavarkiszedő

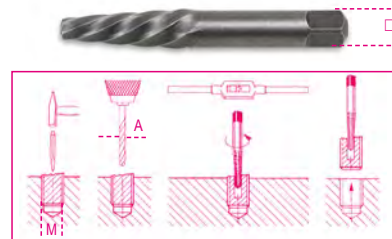

Model	M	A mm	□	Ft	📦	🏠
1430/1	3÷6	2,5	3,0	1.600	10	014300006
1430/2	6÷8	3,0	4,0	1.780	10	014300008
1430/3	8÷11	4,5	5,0	2.150	10	014300011
1430/4	11÷14	6,0	6,3	2.830	10	014300014
1430/5	14÷18	8,0	8,8	3.180	10	014300018
1430/6	18÷24	11,0	11,7	6.230	5	014300024
1430/7	24÷33	14,0	14,8	9.350	5	014300033
1430/8	33÷50	21,0	20,0	11.950	5	014300050



Model	Ft	📦	🏠
1430/S5 1430/1-1430/2-1430/3 1430/4-1430/5	11.950	1	014300105
1430/S6 1430/1-1430/2-1430/3 1430/4-1430/5-1430/6	17.200	1	014300106
1430/S8 1430/1-1430/2-1430/3 1430/4-1430/5-1430/6 1430/7-1430/8	38.450	1	014300108

1431/...

kúpos le húzószerszám törött csavarok és csapok eltávolításához

Stabilan nem megfogható csavarok és csapok eltávolításához, ütőmechanizmus

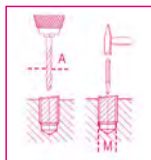

	M	A	L	□	Ft		
	mm	mm	mm	mm			
1431/3	3÷6	2,5	59	5	2.870	10	014310051
1431/5	6÷8	5,0	68	5	2.870	10	014310052
1431/6	8÷11	6,0	72	6	3.400	10	014310053
1431/8	11÷14	8,0	77	8	3.700	10	014310054
1431/9	14÷18	9,0	82	9	3.990	10	014310055

1431/C5

kúpos le húzószerszám törött csavarok és csapok eltávolításához

Ütőmechanizmus

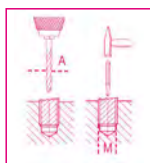

	M	A	Ft		
	mm	mm			
1431/C5	3÷18	2,5÷9	17.000	1	014310005

1433

Göggös töcsavarkihajtó

3/8"

1/2"

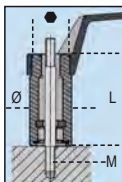

M	∅	L	●	□	Ft		
mm	mm	mm	mm	mm			
5	21	60	19	3/8	6.360	2	014330005
6	24	60	21	1/2	6.360	2	014330006
7	24	60	21	1/2	6.360	2	014330007
8	24	60	21	1/2	6.360	2	014330008
9	28	70	21	1/2	7.570	2	014330009
10	28	70	21	1/2	7.570	2	014330010
10,5	28	70	21	1/2	7.570	2	014330021
11	28	70	21	1/2	7.570	2	014330011
12	28	70	21	1/2	7.570	2	014330012
14	36	72	24	-	11.950	2	014330014
16	36	72	24	-	11.950	2	014330016

1433/C11

1/2"-os töcsavarkihajtó

3/8"

1/2"



	Ft		
1433/C11	123.500	1	014330311
M5 - M6 - M7 - M8 - M9 - M10 - M10,5			
M11 - M12 - M14 - M16			
∅ 340x135x56 mm - ∅ 3,0 kg			

1435

Excenteres töcsavarkihajtó, krómozott

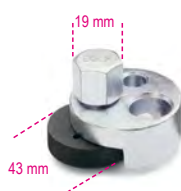

∅ mm	Ft		
4÷20	46.350	1	014350001

1435R

Tartalék kerék az 1435 típusú excenteres töcsavarkihajtóhoz



	Ft		
1435R	14.550	1	014350010

1435/1

Excenteres töcsavarkihajtó, krómozott



∅ mm	Ft		
19÷26	57.500	1	014350002

1435/1R

Tartalék kerék az 1435/1 típusú excenteres töcsavarkihajtóhoz

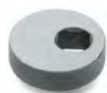

	Ft		
1435/1R	14.950	1	014350011

1438

Kuplungtárcsa központosító



	Ft		
1438	24.900	1	014380001

1438R

Tartalék betétek az 1438 típusú központosítóhoz, műanyagból



∅ mm	Ft		
14÷18	1.700	5	014380101
18÷21	1.700	5	014380102

1438EVO

univerzális kuplungtárcsa központosító készlet

Az alkatrészek teljes mértékben fémből készültek



	Ft		
1438EVO	110.900	1	014380011
∅ 290x200x60 mm - ∅ 2 kg			

1438DSG

a VAG csoport kettős tengelykapcsolós DSG sebességváltó reteszelés/kioldás kar



	Ft		
1438DSG	15.200	1	014380200

1439/K7

Sarokcsavarhúzó 90°, hosszított kivétel, betéttel, dobozban



1439K7	Ft	1	014390101
500x120x60 mm 825 g			

1440/...

Dugattyúgyűrű szorító szalag



	Ø mm	L mm	Ft	1	014400000
1440/0	40÷75	50	13.750	1	014400000
1440/1	57÷125	80	18.000	1	014400010
1440/1A	57÷125	100	20.450	1	014400011
1440/2	90÷175	80	21.850	1	014400020
1440/2A	90÷175	100	22.850	1	014400021
1440/3	90÷175	165	33.400	1	014400030

1445/1 - 1445/2

Dugattyúgyűrű fogó, nikkelezett műanyag bevonatú szárral



	Ø mm	Ft	1	014450001
1445/1	50÷100	19.000	1	014450001
1445/2	90÷150	24.300	1	014450002

1452K

Szeleprugó feszítő fogó három pófával

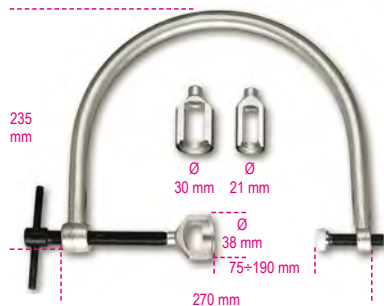

1452K	Ft	1	014520100
71.850			

1452PN/K

Pneumatikus szerszám motorszeleprugóhoz

1400 N



Ø mm	L mm	L1 mm	Ft	1	014520110
16-19-23	230	185	153.000	1	014520110
25-30-42					

1454P

kaparó tömítés és tömítőanyag maradék eltávolítására

különösen fejek és lapos felületek tisztításához ajánlott



L mm	L1 mm	± mm	Ft	1	014540010
210	32	3,3	20.050	1	014540010

1455SVP

Pneumatikus szelepcsiszoló

• Nyomás: 6 bar

CE



1455SVP	Ft	1	014550001
174.900			

1455SVP/R...

Tartalék tappancsok, alkatrészek az 1455SVP típusú szelepcsiszolóhoz



	Ft	5	014550501
1455SVP/R1	3.140	5	014550501
1455SVP/R2	3.140	5	014550502
1455SVP/R3	3.140	5	014550503

1457/B4

Rilsan csatlakozó kioldó eszköz készlet

Tartalmazott méretek:

- 6x8
- 10x12
- 15x16
- 18x1/2



1457/B4	Ft	1	014570024
23.450			

1458

Biztosítógyűrűfogó, krómozott, PVC-bevonatú szárral



DIN 5417

Ø mm	Ft	2	014580001
30÷100	34.200	2	014580001

1460F

Szeleptömítés kiszedő, nikkelezett, fekete pófákkal



1460F	Ft	1	014600010
29.350			



1462CF/C6

6 darabos nyitott sokszögkulcs készlet
üzemanyag befecskendező csatlakozókhoz

méretek:
12-14-16-17-18-19 mm



1462CF/C6 Ft 45.600 1 014620006
☞ 260x145x60 mm - 📦 1,2 kg

1462CF

nyitott sokszögkulcs
üzemanyag befecskendező csatlakozókhoz



mm	Ft	📦	🏠
12	7.250	1	014620012
14	7.330	1	014620014
16	7.490	1	014620016
17	7.650	1	014620017
19	8.060	1	014620019
18	7.850	1	014620018

1462/KEP

Pneumatikus dízel injektor kihúzó szerszám

A tartozék csatlakozókkal könnyen csatlakoztatható
pneumatikus emelő a befecskendező menetes fészékhez.
A távvezérlés biztonságos működést garantál, az emelővel
pedig nagy (akár 1200 bpm) fúvóerő fejthető ki.

- Jellemzők:
- Távvezérelt működés
 - Praktikus pozicionáló markolat
 - M18x1,5 menetes csatlakozó
 - Csúszókalapács lökethossz: 35 mm
 - Csúszókalapács sebesség: 1200 bpm

- A készletben található adapterek:
- M14X1.5 Delphi injektorhoz
 - M17X1.0 Bosch injektorhoz
 - M20X1.0 Denso injektorhoz
 - M25X1.0 Siemens injektorhoz
 - M27X1.0 Siemens injektorhoz



1462/KEP Ft 178.100 1 014620250
☞ 385x300x110 mm - 📦 4,8 kg

1462/KI

Dízel porlasztócsúcs kiszedő szerszámkészlet
Common-Rail rendszerhez
DELPHI-BOSCH-SIEMENS-DENSO porlasztócsúcs
kiszedéséhez



1462/KI Ft 1.186.200 1 014620235
☞ 530x470x140 mm - 📦 2,0 kg

1462/MB

csúszókalapácsos injektor
kihúzó készlet

- Készlet tartalma:
- 1 db 4 kg-os csúszókalapács, hossz: 400 mm
 - 1 db csuklós adapter, csavar M10x1,5, anya M22x1,5 mm
 - 1 db adapter, csavar M22x1,5, anya M13x1,4 mm
 - 1 db adapter, csavar M14x1,5, anya M27x1 mm
 - 1 db adapter, csavar M14x1,5, csavar M25x1 mm
 - 1 db adapter, csavar M14x1,5, csavar M27x1 mm
 - 1 db adapter, csavar M14x1,5, anya M14x1,5 mm
 - 1 db adapter, csavar M14x1,5, csavar M20x1 mm
 - 1 db adapter, csavar M14x1,5, csavar M17x1 mm



1462/MB Ft 142.500 1 014620110
☞ 500x250x80 mm - 📦 7,2 kg

1462/EI

univerzális vibrációs injektor kihúzó szerszám

- A hengerfej és az injektorok sérülése nélkül segíti a beragadt injektorok eltávolítását a foglalatból.
- Bármilyen injektor kihúzó készlettel használható, csúszókalapáccsal vagy anélkül.
- A szerszám rezgése közvetlenül a injektorra csatlakoztatott kihúzórudra hat.
- A rezgés intenzitása a szabályozószeleppel állítható az adott munkának megfelelően.



1462/EI Ft 313.000 1 014620240

1464T/N

Digitális teszter nyomás és kompresszió
méréséhez

- nagy, háttérvilágítású digitális kijelző
- tölthető polimer lítium-akkumulátor
- 80 baros érzékelővel (alacsony nyomás)
- vezeték nélküli kapcsolódás
- mérés és szoftverfrissítés Wi-Fi kapcsolatban keresztül
- ütészálló táská
- motor nyomás és kompresszió mérésére az 1464 készletekkel együtt használható



- Műszaki adatok:
- Kijelző: 8"
 - Felbontás: 800x840 px
 - Processzor: Dual core 240 MHz
 - Memória: 32 Mb
 - Szoftver: 32 bites

L H P Ft
mm mm mm 454.300 1 014640090

1464T/SP80

nyomásérzékelő, 80 bar,
a 1464T, 960TP és 1464T/N termékhez



1464T/SP80 Ft 142.900 1 014640053

1464CBD

teljes körű adapterkészlet diesel- és
benzinmotorok kompresszióméréséhez
az 1464T és 1464T/N teszterhez

Lehetővé teszi a motorhoz történő csatlakozást a
dieselmotorok kompresszió ellenőrzéséhez a 1464T digitális
teszter részére

- Tartalom:
- 8 próba gyújtógyertya visszacsapószeleppel
 - 44 próba izzógyertya visszacsapószeleppel
 - 1 állítható próba befecskendező személygépjárművekhez, kamionokhoz, hajómotorokhoz és mezőgazdasági gépekhez
 - 1 90° adapter, nyomáscsökkentő szelep és csatlakozótömlő
 - a 1464T teszternek fenntartott hely



1464CBD Ft 339.700 1 014640300
☞ 510x410x140 mm - 📦 5,5 kg

1464APD

Készlet common rail dízelmotorok nagynyomású rendszerének vizsgálatához (az 1464T és 1464T/N egységgel együtt használható)

Lehetővé teszi a nagy nyomású szivattyú és injektorcső összekötését a common rail rendszer nyomásának ellenőrzéséhez.

Ha nincs nyomás, a készletben található áll szabályozók segítségével meghatározható, hogy a probléma a magas nyomású szivattyúból vagy a szabályozóból ered.

Készlet tartalma:

- nagy nyomású cső készlet:
- csatlakozók
- 2000 baros érzékelő
- áll szabályozó készlet
- készlet az injektor üzemanyag csatlakozójához



Tartozék tömlő méretek:

- T12X12-M1.5
- T12x14-M1.5
- T12x16-M1.5
- T12-M1.5

Bosch, Delphi, Denso és Siemens nyomásszabályozókhoz javasolt

1464APD Ft 423.100 1 014640100

510x415x130 mm - 4,7 kg

1464APB

Kiegészítő a 1464T és 1464T/N teszterhez. Az FSI motorok nagynyomású benzines rendszerének vizsgálatára szolgáló készlet

egy 200 báros érzékelőt és csatlakozó elemeket tartalmaz



1464APB Ft 185.000 1 014640500

240x210x50 mm - 0,5 kg

1464BP

Csatlakozókészlet alacsony nyomás ellenőrzéséhez (az 1464T és 1464T/N egységgel együtt használható)

A 1464T/N készülékhez kapcsolt gyorscsatlakozókkal gyorsan ellenőrizhető a dízel- és benzinmotorok alacsony üzemanyagnyomása, valamint AdBlue® és TDI nyomása.



1464BP Ft 222.700 1 014640200

510x415x130 mm - 2,6 kg

1464PO

Csatlakozókészlet olajnyomás ellenőrzéséhez (az 1464T és 1464T/N egységgel együtt használható)

A digitális teszterrel és a tartozék csatlakozókkal ellenőrizhető a motorolaj nyomása.



Készlet tartalma:

- 10 motorolaj nyomáscsatlakozó
- 4 turbó olajnyomás csatlakozó
- 90° csatlakozó
- gumi hosszabbító gyorscsatlakozóval

1464PO Ft 97.950 1 014640270

350x290x90 mm - 1,3 kg

1464FAP

gázolaj részecskeszűrő (DPF) nyomás ellenőrző készlet a 1464T és 1464T/N egységhez

Tartozékok:

- 500 mbar érzékelő
- 8 mm adapter gyorscsatlakozóval és T-szerelvénnyel
- 3 m hosszú RJ45 kábel



MŰSZAKI ADATOK
Nyomásméret: 0+500 mbar
Lépték: 1 mbar

1464FAP Ft 91.700 1 014640610

240x210x50 mm - 0,5 kg

1464PT

Turbónyomás ellenőrző készlet, a 1464T egységhez

érezkelőt és

csatlakozó kábelt tartalmaz



1464PT Ft 80.750 1 014640550

240x210x50 mm - 380 g

1464VD

Vákuum teszter készlet a 1464T és 1464T/N egységhez

A maximális vákuum érték méréséhez és tárolásához

Tartozékok:

- 800 mbaros érzékelő
- 6 és 8 mm-es adapterek
- 3-m hosszú RJ45 kábel

MŰSZAKI ADATOK

Vákuum teszt: 0+800 mbar

Lépték: 1 mbar

Maximum érték tárolása



1464VD Ft 91.700 1 014640570

240x210x50 mm





1465 motor hatásfokmérő

A berendezést a jármű akkumulátorára kötve a célszoftverrel az endoterm motor kompresszió másodperceken belül ellenőrizhető a motorhoz csatlakoztatás nélkül



COMPRESIONE RELATIVA RELATIVE COMPRESSION	POTENZA ELETTRICA ASSORBITA ABSORBED ELECTRIC POWER
Max.	1300 W
90%	1000 W
80%	750 W
70%	500 W
60%	250 W

1. lépés: motor fordulatszám kalkuláció
 2. lépés: akkumulátor feszültségváltozásának ellenőrzése az egyes fordulatok alatt
 3. lépés: az önindító működéséből kiszámított elnyelt erő és a kompresszió hengerenkénti megjelenítése
 4. lépés: akkumulátor töltés és teljesítmény ellenőrzése
- MŰSZAKI ADATOK**
 Üzemi feszültség: 12V DC (akkumulátor)
 Méretek: 140x75x30 mm
 Kapcsos kábel hossza: 1300 mm
 Súly: 215 g

1465 Ft 556.700 1 014650010

1466/C5

5 kulcsos készlet fém légtelenítéshez

a készlet a következőket tartalmazza:

- 5 kulcs 7-8-9-10-11 mm méret
- 1 leeresztő cső visszacsapó szeleppel



1466/C5 Ft 60.950 1 014660100

260x170x50 mm - 600 g

1467 Fékfolyadékleszívó



Min.nyomás: 5 bar - Max. nyomás 11,5 bar

1467 Ft 162.800 1 014670001

1467/RK1

pótcső készlet az 1467 készülékhez



1467/RK1 Ft 12.350 1 014670501

1467LF/2

elektromos fékfolyadékcsereelő készülék

„pulzáló” funkcióval



- A készülék automatikusan zár, ha a tartályban nincs fékfolyadék, így megakadályozza a levegősödést
 - A tartály maximális irtartalma: 20 l
 - Üzemi nyomás: 0,4+3,5 bar
 - Tápellátás: 230V
- Tartozékok:
 • Fékolaj leeresztő tartály
 • 1 E20 standard dugó

1467LF/2 Ft 848.200 1 014670099

1467LF/RC tartály gyűjtőcsővel az 1467/LF készülékhez



1467LF RC Ft 51.400 1 014670125

1467TU

Záróelem fékfolyadék tartályokhoz

- a tartályok 90%-hoz alkalmazható
- a 1467LF cikkszámú Beta termékhez



1467TU Ft 31.800 1 014670090

1467T/C6

záróelem adapter készlet fékfolyadéktartályokhoz, a BETA 1467LF és 1467LF/2 modellhez

Készlet tartalma:

- 1 adapter Toyota gépjárművekhez
- 1 adapter Ford, Hyundai, Mazda, Mitsubishi, Nissan, Subaru gépjárművekhez
- 1 adapter Honda gépjárművekhez
- 1 adapter Mazda és Suzuki gépjárművekhez
- 1 adapter Nissan gépjárművekhez
- 1 fékfolyadék kieresztő adapter európai gépjárművekhez



1467T/C6 Ft 129.100 1 014670080

350x240x85 mm - 1,8 kg

1470

Dobfékrugófogó, nikkelezett



L mm	Ft	1	014700001
210	19.000	1	014700001
330	24.300	1	014700002
540	72.850	1	014700010

1470FT

Dobfékrugófogó

Pofa 40° -ban hajlított
Nehezen hozzáférhető helyekre

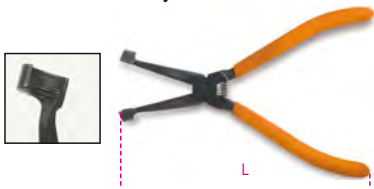

L mm 184 Ft 20.050 1 014700000

1471

Dobfékrugófogó, nikkelezett,
PVC-bevonatú szárral



L mm 330 Ft 37.050 1 014710001

1471GF

hajlítható horog pár a féknyereg
megtartásához fékbetét csere közben



1471GF Max kg 5 Ft 6.800 1 014710310

1471M/C22

Levegős tárcsafékdugattyú szerelő szerszám,
jobb és balmenetes, tartozékkal



1471M/C22 Ft 145.300 1 014710101
350x310x85 mm - 3,5 kg

1471M/50

Levegős fékdugattyú szerelő készülék, jobb és
balmenetes

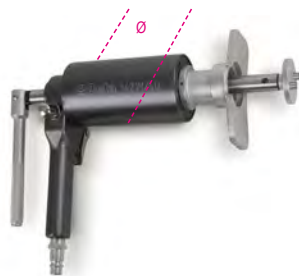

Ø mm 50 Kg 150 Bar 5÷8 Ft 79.950 1 014710069

1471C

racsnis fékdugattyú visszanyomó szerszám



L 245 A min+Max 40÷65 Ft 29.350 1 014710330

1471CF

Ötszögű dugókulcs fékszereléshez



mm 14 Ft 8.540 1 014710314
19 Ft 8.540 1 014710319

1471CM

Ötszögű dugókulcs fékszereléshez



mm 10 Ft 8.540 1 014710360

1471CM/E11

Hatlapú dugókulcs, 11 mm,
Mercedes ML (széria 166) fékszereléshez



mm 11 Ø mm 24 L mm 75 L1 mm 15,5 Ft 9.030 1 014710361

1471PT/C5

gépi dugókulcs készlet fékhez

a Volkswagen, Audi és Porsche csoport járműveihez
• 3 db 10 szögű dugókulcs: 11,5 mm - 15 mm - 20 mm
• 2 db 7 szögű dugókulcs: Ø 14 mm - 22 mm



1471PT/C5 Ft 34.800 1 014710367

1471D2

első tárcsafék fék munkahenger visszanyomó
zárt fékbetétekénél

két talppár a 2 és 4 dugattyús
fék munkahengereken végzett műveletekhez



mm 10 Ft 37.450 1 014710301
250x170x60 mm 1,5 kg

1471T/C5

5 ütőkulcs kamion féknyereghez

nyomatékkulcsokkal használható
megszorításhoz
méretek:
• E18, E20, E24 Torx dugókulcs
• M24, M26 csillagkulcs



1471T/C5 Ft 120.200 1 014710400
275x220x60 mm - 3,1 kg

1472

Tömőbilincsfogó, nikkelezett



1472 Ft 21.250 1 014720001

1472AU

Önzáró tömlőbilincsfogó, barnított, PVC-bevonatú szárral



Ø mm 18+53 Ft 61.950 1 014720100

1472R/AU

póthegek az 1472AU fogóhoz



1472AU/R Ft 23.900 1 014720101

1472AU/P

Automata tömlőbilincsfogó hosszított, barnított, PVC-bevonatú zárral



Ø mm 18+54 L mm 630 Ft 54.650 1 014720105

1472AU/RP

póthuzal az 1472AU/P fogóhoz



1472AUP/R Ft 13.350 1 014720106

1472B/RNLT

kettős beosztású dugókulcs, kifejezetten Renault motorokon alkalmazott szívócső bilincsekhez



1472B/RNLT Ft 8.620 1 014720250

1472FC

Rugós bilincsfogó



1472FC Ft 19.650 1 014720090

1472FC/GE

nagyhatású fogó Clic(R) bilincsekhez

különösen javasolt nagyméretű bilincsekhez



L mm 230 Ft 34.200 1 014720093

1472FC/L

360°-ban állítható fejű fogó flexibilis hosszabbítóval, Clic® bilincsekhez



L mm 630 Ft 52.400 1 014720095

1472FCL/RP

póthuzal az 1472FC/L fogóhoz



1472FCL/RP Ft 23.500 1 014720096

1472PU

kombinált bilincs- és tömlőbilincsfogó

a 45°-ban megdöntött pófák a kereskedelmi forgalomban kapható legtöbb bilincs szerelésére alkalmasak



Ø mm 0+65 L mm 228 Ft 32.600 1 014720120

1472PU/P

kombinált bilincs- és tömlőbilincsfogó hosszabbítóval

a kombinált fej a kereskedelmi forgalomban kapható legtöbb bilincs szerelésére alkalmas



Ø mm 3+58 L mm 228 L1 mm 630 Ft 48.150 1 014720121

1472VW

Önzáró tömlőbilincsfogó

Volkswagen és Mercedes



1472 VW Ft 22.050 1 014720051

1473

OETIKER® bilincsfogó barnított, PVC-bevonatú szárral



1473 275 Ft 60.950 1 014730001

1473A

OETIKER® szemesbilincs összehúzó fogó, barnított, PVC-bevonatú szárral



1473A Ft 46.350 1 014730010

1473P

OETIKER® bilincsfogó alacsony profilus



1473P Ft 17.200 1 014730020

1473FN

Bilincs összehúzó és vágó szerszám nemes acélból

Használható Panduit®-tal és ehhez hasonló bilincsel



1473FN Ft 31.800 1 014730501

1474L

Gyertyakiszedő fogó, 15°-os hajlított pófával, hosszított kivitel, krómozott, PVC-bevonatú szárral

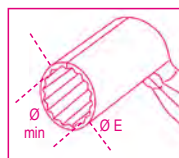

1474L Ft 39.050 2 014740010

1474DL

Hosszú gyertyakiszedő fogó, PVC-bevonattal



1474DL Ft 18.600 1 014740015

1474G

hosszú hajlított csőrű fogó izzítógyertya sapkához



1474G Ft 20.850 1 014740200

1476

Állítható kipufogócsővágó fogó, krómozott



1476 Ft 37.450 1 014760002

1476/RC

Tartalék vágólánc az 1476 típusú fogóhoz



1476/RC Ft 18.400 1 014760012

1476A

Kipufogócsővágó fogó, PVC-bevonatú szárral



1476A Ft 47.550 1 014760005

1476A/RC

Tartalék vágólánc az 1476A típusú fogóhoz



1476A/RC Ft 40.900 1 014760015

1476C/1

Kipufogócső tágitó szerszám



1476C/1 Ft 18.000 1 014760101
Ø 30=42 mm
L = 131 mm
L1 = 51 mm

1476GT

fogó gumi tartóbetétek eltávolításához kipufogó csöveknél



1476GT Ft 16.400 1 014760050

1476PSA

fogó kipufogó rögzítő csapos bilincshez, PSA csoport a csőrök formája és az automatikus fogasléc rögzítés lehetővé teszi a műveletet a csap kihúzása nélkül



1476PSA Ft 20.250 1 014760060

1477/C10

9 darabos sarokcsillagkulcs készlet
ékszíjtárcsaanyához

1 sarokcsillagkulcs betéttartóval
4 dupla tizenkétszögű betét: 12x14 - 13x15 - 16x17 - 18x19 mm
5 betét Torx®-csavarokhoz: E10 - E12 - E14 - E16 - E18



1477/C10 Ft 78.350 1 014770310
530x110x55 mm

1477/C38

Csuklós racsnis kulcs készlet szíjfészítőkhöz
való rövid dugókulcsokkal

Készlet tartalma:

- csuklós hajtókar 500-mm hosszú irányváltós racsnival
- rövid dugókulcsok Torx® csavarokhoz: E10-E12-E14-E16-E18
- rövid hatlapfejű dugókulcsok: 8-9-10-11-12-13-14-15-16-17-18-19-24
- bitek Torx® csavarokhoz: T20-T25-T27-T30-T40-T45-T50-T55-T60
- bitek keresztfejű Phillips® csavarokhoz: PH2
- hatlapfejű bitek: 4-5-6-7-8-10 mm
- mágneses bittartó
- 3/8" hosszabbító, 75 mm



1477/C38 Ft 106.900 1 014770338
630x130x55 mm - 2 kg

1477D/S5

5 darabos sarokcsillagkulcs készlet
ékszíjtárcsaanyához



1477D/S5 Ft 70.150 1 014770200
13-15-16-17-19 mm
600x200x70 mm - 2,2 kg

1478

Áttételes kárpitpatent kiszedő
fogó, krómozott, PVC-bevonatú
szárral



1478 Ft 27.100 1 014780001

1478NSS

3 kioldópontos
műanyag csap fogó



L mm 180 Ft 19.650 1 014780163

1478T

állítható fejű fogó műanyag
nyomáscsipesz csapokhoz

90°-ban állítható fej

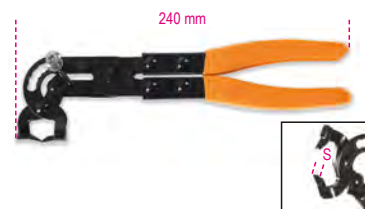

S mm 4,5 Ft 21.250 1 014780101

1478/K3

csapkiszedő fogó készlet műanyag csapokkal

készlet tartalma:

- 1 db laposfogó
- 1 db 90°-ban hajlított fogó
- 625 db műanyag kapocs 16 különböző méretben
- kapcsok 3 db rakatható PPL tárolóban

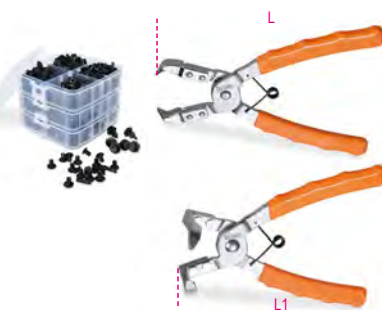

L mm 180 L1 mm 170 Ft 49.200 1 014780160

1478SP

625 darab műanyag patent

16 különböző típus



1478SP Ft 11.750 1 014780201

1479

Kárpitpatent kiszedő, krómozott,
műanyag szárral



1479 Ft 11.950 2 014790001

1479/B27

27 darabos nylon szerszámkészlet
kárpitpatentekhez, és műanyagokon és
tömítéseken történő munkavégzéshez
felfüggeszhető tartóban



1479/B27 Ft 37.450 1 014790407

1479LB/C5

5 darabos fém kárpitpatent kiszedő készlet



1479LB/C5 Ft 51.000 1 014790150
215x165x50 mm

1479L/S2

Teflon® multifunkciós kar pár



1479L/S2 Ft 17.150 1 014790510

1479LV/S3

3 darabos multifunkciós bontórúd készlet, fém

méretek:
1479LV/1: 10x12 mm
1479LV/2: 4,8x9,6 mm
1479LV/3: 2,8x6 mm



1479LV/S3 Ft 14.550 1 014790100

1479L/K4

4 darabos bontórúd készlet műszerfalhoz és kényes alkatrészekhez



1479L/K4 Ft 16.200 1 014790604

1479N/S5

5 darabos műanyag patentkiszedő készlet



1479N/S5 Ft 19.450 1 014790251

1479RB/1

Egyenes kárpitpatent kiszedő szerszám



1479RB/1 Ft 13.350 1 014790315

1479RB/2

Hajlított kárpitpatent kiszedő szerszám



1479RB/2 Ft 13.350 1 014790320

1479RB/3

Egyenes széles kárpitpatent kiszedő szerszám



1479RB/3 Ft 15.200 1 014790310

1479U/13

Kárpitpatent kiszedő szerszám, villa nemes acélból



1479U/13 Ft 12.350 2 014790010

1479U/32

Kárpitpatent kiszedő szerszám, villa nemes acélból



1479U/32 Ft 14.550 2 014790015

1480

gázolajszűrő feltöltő készlet elektromos szivattyú nélküli autókhoz

• Gumibroncsfújó pisztollyal is használható

A készlet az alábbiakat tartalmazza:

- GM gyorscsatlakozók
- Renault, GM, Fiat 6 mm belső Ø gyorscsatlakozók
- Renault, GM, Fiat 7 mm belső Ø gyorscsatlakozók
- Ford gyorscsatlakozók
- PSA 6 mm belső Ø gyorscsatlakozók
- PSA 7 mm belső Ø gyorscsatlakozók
- Ford gyorscsatlakozók
- 2 kúpos adapter gyorscsatlakozó nélküli gépkocsikhoz



1480 Ft 181.800 1 014800010

410x320x70 mm



Beta



1481/C12

6 darab tömlőzáró fogó

A készlet áll:

- 2 különböző fogó 1/4"
- 2 különböző fogó 3/8"
- 2 különböző fogó 5/16"
- 6 darab rögzítő gumipánt



1481/C12	Ft	1	014810312
370x270x59 mm	57.500		

1481K/S4

4 db önzáró csatlakozó csövek lezárásához

méret: 5/16" - 3/8" - 1/2" és hurok



1481K/S4	Ft	1	014810400
	14.550		

1481PL/A

Tömlőzáró fogó

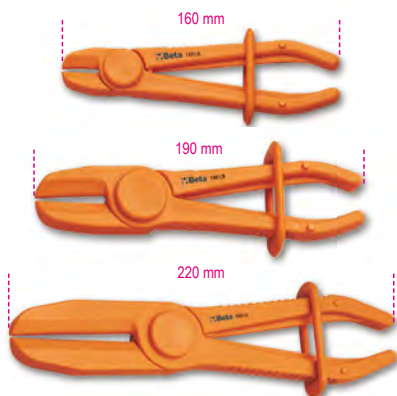

1481PL/A	8÷15	Ft	3	014810110
1481PL/B	15÷25	11.150	3	014810120
1481PL/C	25÷45	14.950	3	014810130

1481PL/S3

3 darabos tömlőzáró fogó készlet



1481PL/S3	Ft	1	014810200
1481PL-A Ø 8÷15 mm	35.950		
1481PL-B Ø 15÷25 mm			
1481PL-C Ø 25÷45 mm			

1481T/C12

üzemanyagcső elzáró dugó

3 pár elzáró dugó gyorscsatlakozóval üzemanyagcső lezárására



1481T/C12	Ft	1	014810212
275x220x45 mm - 540 g	59.500		

1482

Állítható kulcs az üzemanyagtartály szereléséhez



Ø mm	Ft	1	014820001
89÷170	53.450		
89÷200	55.850	1	014820002

1482A/1B

3 lábás kulcs, alumíniumból készült üzemanyag tartály, úszó gyűrűhöz

A 2011 óta a Fiat, Volkswagen, Opel, Chevrolet, Mercedes és BMW csoportnál alkalmazott alumínium gyűrűk szereléséhez



Ø mm	Ft	1	014820004
185	37.050		

1482A/3

kulcs a PSA csoportnál használt üzemanyag tartály úszó gyűrűhöz

a kialakítás lehetővé teszi a decentralizált tengely segítségével történő gyűrű eltávolítást, a kényes úszó sérülése nélkül



Ø mm	Ft	1	014820007
157	42.100		

1482/8 - 1482/10

Benzincső lehúzó fogó, barnított, PVC-bevonatú szárral



1482/8	Ø mm	Ft	2	014820008
1482/10	10	18.400	2	014820010

1482B

Benzincső lehúzó fogó



1482B	Ft	1	014820021
	22.050		

1482SN

benzincső lehúzó fogó csuklós pófával



L mm	Ft	1	014820110
260	28.350		

1482C

2 pár kúp a Fiat, Volkswagen, Jeep, Chrysler és Volvo csoportnál a gázolajszűrő csatlakozó kioldásához

gyors szűrőcsere a csatlakozók helyrehozhatatlan sérülése nélkül



1482C	Ft 29.350	1	014820022
-------	--------------	---	-----------

1483KV-PT/S7

ötszög bitfej készlet

méretek:
PT10 - PT15 - PT20 - PT25 - PT27 - PT30 - PT40



1483KV PT/S7	Ft 5.870	1	014830117
--------------	-------------	---	-----------

1484

'2 darabos szerszámkészlet ékszíj szereléséhez

Gyors és korrekt szerelést biztosít az ékszíj sérülése nélkül



1484	Ft 59.100	1	014840010
------	--------------	---	-----------

1485BP

félköríves szerszám fogas ékszíjtárcsák reteszeléséhez

fordítható nyéllel állítható, kívülről szorítja és blokkolja a szíjtárcsát, nem veszélyezteti a környező érzékelőket



A Max mm	Ft	1	014850000
130	105.300		

1485FCA/K2

vezérműsij csapágy előfeszítő szerszám pár FCA csoport 1.2, 1.4 8/16 V és 1.4 Multiair motorokhoz javasolt

- 1 db 175 mm hosszú szerszám 13,5 mm hegyekkel
- 1 db 305 mm hosszú csuklós szerszám 13,5 mm hegyekkel



1485FCA/K2	Ft 48.100	1	014850220
------------	--------------	---	-----------

1485TC

feszítőkar Ford, PSA, FCA motorokba szerelt segédhajtás szíjakhoz



L mm	Ft	1	014850330
475	22.850		

1485/KIT

Vezérműsij feszességmérő készlet



1485/KIT	Ft 85.200	1	014850100
☞ 230x140x75 mm - 📦 580 g			

1485R

Vezérműtengely tárcsa forgató szerszám kovácsolt acélból 2 pár hegygel szállítva



∅ mm	∅1 mm	L mm	Ft	1	014850025
30÷120	10 - 17	500	73.500		

1485R/P10

Hegyek (párban)



1485R/P10	Ft 7.890	1	014850035
-----------	-------------	---	-----------

1485R/P17

Hegyek (párban)



1485R/P17	Ft 7.890	1	014850038
-----------	-------------	---	-----------

1488 - 1488L

Olajszűrőleszedő dupla láncsal, krómzott



	∅ mm	Ft	1	014880001
1488	60÷110	43.700		
1488L	60÷160	47.950		014880050

1488/1

1/2"-os láncos olajszűrőleszedő dugókulcs, krómzott



∅ mm	Ft	1	014880010
60÷110	50.600		

1488R...

pótlánc



	L mm	Ft	1	014880101
1488RC	1488	350	18.000	
1488R/L	1488/L	520	28.950	014880150
1488RC/1	1488/1		24.900	014880110

1489/33

Ékszjártárcsakulcs



1489/33	33	Ft	1	014890010
		7.850		

1489/Y

Ékszjártárcsakulcs Nippondenso



1489/Y	32	Ft	1	014890040
		8.990		

1490

Szíjas olajsűrőleszedő, nikkelezett, PVC-bevonatú nyéllel

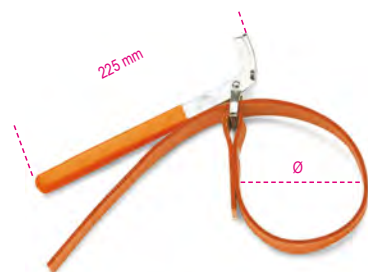

1490/1	160	Ft	1	014900001
1490/2	240	18.600	1	014900002

1490/R1 - 1490/R2

textil csereszíj a 1490 modellhez



1490/R1	160	Ft	1	014900101
1490/R2	240	10.300	1	014900102

1490F

szíjas szűrőkulcs



1490F	200	H	50	Ft	1	014900201
				12.750		

1491

Állítható fémszalagos olajsűrőleszedő, könnyűfémtest



1491	65÷110	Ft	2	014910001
		22.450		

1491R

Tartalékszalag az 1491 típusú olajsűrőleszedőhöz



1491R	10	Ft	4.130	014910010

1491A

állítható olajsűrő leszedő

Pontos beállítás a feszítőkerettel



1491A	L	Ø min - Max	Ft	1	014910040
	345	55 ÷ 140	15.400		

1491T

állítható teherautó olajsűrő leszedő

Pontos beállítás a feszítőkerettel Száritósűrítőkhöz



1491T	L	Ø min - Max	Ft	1	014910050
	500	70÷200	35.800		

1492/1 - 1492/2

Állítható acélpántos olajsűrőleszedő, nikkelezett, PVC-bevonatú nyéllel



1492/1	60÷80	Ft	1	014920001
1492/2	80÷110	22.250	1	014920002

1492T

Sűrőleszedő kulcs



1492T	Ø	H	Ft	1	014920540
1492T 40	125÷145	40	16.400		
1492T 75	120÷140	75	28.950	1	014920575

1493B

sokszögű olajsűrőleszedő kulcs nehezen hozzáférhető helyekhez



1493B	mm	Ft	1	014930524
	24	9.270		
	27	9.680	1	014930527
	32	9.880	1	014930532
	36	10.500	1	014930536
	38	10.700	1	014930538

1493

Olajsűrőleszedő



1493	Ø	N	Ft	1	014930200
	65	14	5.260		
	73	14	5.260	1	014930208
	74	14	5.260	1	014930209
	76	14	5.260	1	014930218
	76-74	15	5.710	1	014930220
	78	15	5.710	1	014930224
	80	15	5.830	1	014930226
	82-80	15	5.830	1	014930228
	86	16	6.190	1	014930230
	100	15	7.040	1	014930248
	106	15	7.290	1	014930250
	108	15	7.290	1	014930252
	135	18	11.750	1	014930256

1493/PF

Purflux®-olajszűrőleszedő betét

12"



Ø mm	N	Ft		
66	6	5.260	1	014930202
76	12	5.260	1	014930216
76	30	5.710	1	014930222
86	18	6.190	1	014930232
93	36	6.190	1	014930240
93	45	6.190	1	014930242
108	18	7.890	1	014930254

1493/C30

28 darabos olajszűrőleszedő dugókulcskészlet

12"



A készletben található méretek (Ø mm)
1493:

65/14 - 68/14 - 73/14 - 74/15
76/15 - 75.77/15 - 76/14 - 76/8 - 78/15 - 80/15
82/15 - 86/16 - 90/15 - 92/10 - 93/15 - 95/15
100/15 - 106/15 - 108/15

1493PF (Purflux)

66/6 - 76/12 - 76/30 - 86/18
93/36 - 93/45 - 96/18 - 108/18

- 1 állítható univerzális kulcs Ø 65+120 mm

1493/C30	Ft		
	127.500	1	014930000

530x400x110 mm - 4 kg

1493AL

olajszűrőleszedő dugókulcs

N= oldalak száma

38"

12"



Ø mm	N	•	□	Ft		
64	14	27	1/2"	7.890	1	014930310
66,5	14	27	1/2"	7.040	1	014930315
74	14	27	1/2"	8.540	1	014930320
84	14	27	3/8"	8.540	1	014930330
92	15	27	3/8"	8.540	1	014930340
100,5	15	27	3/8"	8.540	1	014930350

1493AL 4S

olajszűrőleszedő dugókulcs ázsiai autókhoz

4 szakaszos profil

38"

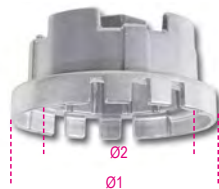

Ø1 mm	Ø2 mm	H	Ft		
70	64,5	27	8.540	1	014930304
80	64,5	27	7.890	1	014930305

1493AL CF

olajszűrőleszedő hatlapfejű dugókulcs

12"



Ø mm	H mm	•	Ft		
24	34	27	5.060	1	014930424
30	34	27	5.060	1	014930430
32,5	34	27	5.260	1	014930432
38	34	27	5.260	1	014930438

1493/C19

18 darabos olajszűrőleszedő dugókulcskészlet.
különösen ajánlott ázsiai autókhoz

Ø mm Lapsz.

63-64	14
66,5	14
74	14
79	15
84	14
87	16
92	15
94,5	15
100,5	15
64,5	14 körcikkes Toyota modellekhez
64,5	14 körcikkes Lexus modellekhez
6 db hatlapfejű dugókulcs, méret: 24-27-30-32,5-36-38 mm szűrőbetétekhez	
A készlet tartalmaz 1 állítható univerzális kulcsot Ø 58+93 mm	

12"

38"



1493/C19	Ft		
	111.300	1	014930019

490x450x60 mm - 4 kg

1493DSG

kulcs a DSG sebességváltó olajszűrő kiszéréséhez/beszéréséhez

12"



Ø mm	Ft		
24	17.600	1	014930800

1493FF/2

csuklós racsnis olajszűrő-leszedő

lehetővé teszi a PSA-csoporthoz tartozó és FORD olajszűrők műanyag házának eltávolítását/beszérését

12"



Ø	L	Ft		
27	245	50.400	1	014930128

1493J

Olajszűrőleszedő Multijet

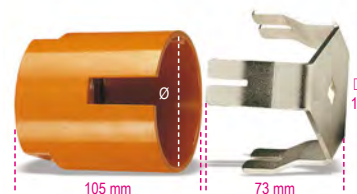

Ø mm	Ft		
90	55.850	1	014930080

1493/C7

háromkaros önszabályozó kulcs jobbmenetes/balmenetes olajszűrőkhöz cserélhető karokkal

csúszásmentes gyémántozott felület
2 sorozat karral:

- 1 sorozat 20 mm hasznos hosszal
- 1 sorozat 38 mm hasznos hosszal

38"



1493/C7	Ø mm	Ø mm	Ft		
	50=100	16	54.050	1	014930079

210x150x50 mm

1493H

3-karú önbeálló olajsűrő leszedő,
jobbos-balos

Recézett befogópofa

38"

12"

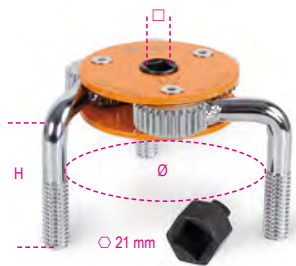

	Ø mm	H mm	Ft		
1493H	72÷127	62	13.350	1	014930077

1493/S-U

Jobb és balmenetes önzáró háromkörös
olajsűrőleszedőkulcs



	□	Ø mm	Ft		
1493/S	3/8-1/2	80-115	40.500	1	014930074
1493/U	1/2	105-165	88.650	1	014930076

1493X

önzáró kulcs
balmenetes olajsűrőkhöz

38"



	Ø mm	± mm	Ft		
1493X/1	60÷80	2,9	15.400	1	014930105
1493X/2	80÷98	2,9	15.400	1	014930110

1493Y

önzáró kulcs
jobbmenetes-balmenetes olajsűrőkhöz
nehéz változat

a 1493Y/2 cikkszámú termék
szárító szűrőkhöz is használható

12"



	Ø mm	± mm	Ft		
1493Y/1	80÷110	7,3	52.400	1	014930120
1493Y/2	104÷145	7,3	79.950	1	014930122

1494T/C5

speciális kulcskészlet
műanyag olajdugókhöz

Készlet tartalma:

- 1 kulcs a VAG csoport olajdugóihoz
- 1 kulcs BMW olajdugókhöz
- 1 kulcs a PSA és Ford csoport olajdugóihoz
- 1 kulcs Mercedes olajdugókhöz
- 1 T-szárú kulcs

38"



	Ft		
1494T/C5	34.800	1	014940350

173x125x50 mm - 360 g

1494BMW

speciális tok olajleeresztő dugók számára
BMW motorokhoz

38"



	Ft		
1494BMW	6.720	1	014940315

1494FPC

speciális tok olajleeresztő dugók számára
Ford, Peugeot és Citroën motorokhoz

38"



	Ft		
1494FPC	7.610	1	014940320

1494VW

különleges kulcs műanyag olajdugóhoz
Volkswagen csoport motorok

lehetővé teszi az olajteknőből a műanyag dugó
eltávolítását és felszerelését.
A Volkswagen csoport TFSI és TDI motorjaihoz készült

38"



	Ft		
1494VW	10.500	1	014940305

1494MRC

speciális kulcs műanyag olajdugókhöz,
Mercedes motorokhoz

38"



	Ft		
1494MRC	7.410	1	014940325

1494MAN

speciális kulcs műanyag olajdugóhoz,
DAF és MAN motorok

38"



	Ft		
1494MAN	7.410	1	014940330

1494

Olajleeresztő dugókulcs-betét, négyszög

12"



mm	Ft		
10	4.410	1	014940280

1494E

Olajleeresztő dugókulcs-betét, külső hatszög

12"



mm	Ft		
8	4.410	1	014940208
9	4.410	1	014940209
10	4.410	1	014940210
11	4.410	1	014940211
12	4.410	1	014940212
14	4.410	1	014940214
17	4.410	1	014940217



1494Q

Olajleeresztő dugókulcs-betét, külső négyszög

12"



mm	Ft	1	014940258
8	4.410	1	014940258
9,5	4.410	1	014940259
12	4.410	1	014940262
13	4.410	1	014940263

1494T

Olajleeresztő dugókulcs-betét, külső háromszög

12"



mm	Ft	1	014940289
9,5	4.410	1	014940289

1494XZN

Olajleeresztő dugókulcs betét XZN®-csavarokhoz

12"



M	Ft	1	014940296
16	5.260	1	014940296

1494VW/K

motorolaj cserélő készlet VAG járművekhez



Készlet tartalma:

- 1 speciális tok olajleeresztő dugók számára
- 6 műanyag dugó olajteknőhöz

1494VW/K	Ft	1	014940310
	13.750	1	014940310

1494VW/KT

6 darabos műanyag sapka készlet az 1494VW/K termékhez



1494VW/KT	Ft	1	014940311
	11.950	1	014940311

1494/C14A

14 darabos szerszámkészlet olajcseréhez

12"



1494/C14A	Ft	1	014940150
	62.750	1	014940150

- 1494E 8-9-10-11-12-14-17
- 1494Q 8-9,5(3/8")-12-13
- 1494 10
- △ 1494T 9,5(3/8")
- 1494XZN M16

380x305x40 mm - 1,7 kg

1494M

hatszögű olajdugó szerszám mágneses és hajlékony

lehetővé teszi az olajleeresztő dugó eltávolítását égésveszély és bepiszkolódás nélkül



L mm	F kg	Ø mm	Ft	1	014940401
293	2,5	19	11.350	1	014940401

1495/C6

Olajleeresztő menetjavító készlet



•A nem megfelelő menetet 1495M megfelelő menetfúrójával átvágjuk.

•A javítás olajleeresztés után történik.

A készlet tartalma:

- 1 menetfúró M13x1,25 + 6 csavar+ 12 alátét
- 1 menetfúró M13x1,5 + 6 csavar+ 12 alátét
- 1 menetfúró M15x1,5 + 6 csavar+ 12 alátét
- 1 menetfúró M20x1,5 + 6 csavar+ 12 alátét
- 1 menetfúró M22x1,5 + 6 csavar+ 12 alátét

1495/C6	Ft	1	014950500
	136.400	1	014950500

420x185x60 mm - 2,1 kg

1495M

Túlméretes menetfúró



M	Ft	1	014950553
13x1,25	8.180	1	014950553
13x1,50	6.720	1	014950563
15x1,50	7.290	1	014950565
17x1,50	8.180	1	014950567
20x1,50	9.030	1	014950570
22x1,50	11.750	1	014950572

1495T

6 olajleeresztő csavar és alátét



M	Ft	1	014950503
13x1,25	9.550	1	014950503
13x1,50	9.550	1	014950513
15x1,50	9.550	1	014950515
17x1,50	10.500	1	014950517
20x1,50	11.950	1	014950520
22x1,50	15.600	1	014950522

1496/C

Olajleeresztő kulcs, krómozott



8 x 10 mm	Ft	3	014960010
	10.300	3	014960010

1497D

Egyenes pófájú fogó relé szereléséhez

Biztonságos lehúzás minden típusú reléhez törésveszély nélkül



A min=Max mm	Ft	1	014970150
15÷50	15.800	1	014970150

1497BS

egyenes pófájú, vékony fogó relé és biztosíték szereléséhez

a hosszú és rendkívül vékony pófákkal a relé vagy biztosíték szűk helyen is biztonságosan lehúzható

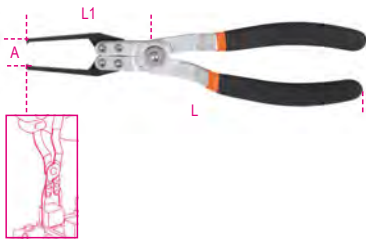

L mm	L1 mm	A min	Ft	1	014970190
230	45	14	10.950		

1497P

60°-ban hajlított pófájú fogó relé szereléséhez

Biztonságos lehúzás minden típusú reléhez törésveszély nélkül



A min+Max mm	Ft	1	014970160
15±50	16.200		

1497SS

önzáró fogó vezeték forrasztásához

A felső szorító párral a forrasztandó vezeték könnyedén rögzíthető és egymáshoz közel hozható.

A beépített reteszelőnek köszönhetően a vezeték 6 különböző pozícióban helyezhető el.



L mm	A min+Max mm	Ft	1	014970195
245	14±70	9.960		

1497TE

elektromos csatlakozó leszedő fogó

a vékony csőrnek köszönhetően a bilincs a csatlakozók sérülése nélkül nyitható



L mm	A Max mm	Ø mm	Ft	1	014970180
215	63	4	11.350		



1497/C23

23 darabos szerszámkészlet az elektromos dugasz szerelésére



1497/C23	Ft	1	014970200
440x250x70 mm - 1,7 kg	106.500		

1497/C94

94 darabos készlet a járművek tesztelésére alkalmas diagnosztikai készülékekhez

- 2 Kábelgyorscsatlakozó
- 2 Potencióméter
- 2 Kontroll-lámpa
- 2 SRS csatlakozó
- 2 Krokodilcsipesz
- 2 Tűszonda
- 2 Mérőcsúcs
- 2 Duplabanándugó
- 4 Banándugó
- 24 Lapos kábelsaru 0.6±6 mm
- 12 Csatlakozó dugasz 1.6±3.9 mm
- 24 Hüvelyes kábelcsatlakozó 0.6±6 mm
- 12 Csatlakozó hüvely 1.6±3.9 mm



1497/C94	Ft	1	014970300
430x390x100 mm - 3 kg	187.400		

1497RC

elektromos gyorscsatlakozó pár

- vezeték keresztmetszet: 1,5+3,5 mm
- feszültség: 0+330 V
- legnagyobb áramerősség 5 A



1497RC	Ft	1	014970351
	35.600		

1498

Feszültségvizsgáló műszer 3-48V

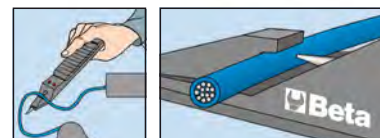

3÷48V	Ft	2	014980100
	23.700		



JÁRMŰJAVÍTÁS

Járműjavító szerszámokat, amelyeket a legigényesebb szakemberek használnak, a világ legmagasabb követelményeinek megfelelően fejlesztettük és gyártottuk, és rendszeresen teszteljük a legnagyobb terhelést jelentő üzemi körülmények között.

Több mint 50 éve büszkén dolgozunk együtt a legnagyobbakkal, akik segítenek termékeink folyamatos fejlesztésében és biztosítják a legmagasabb minőségi színvonalnak való megfelelést.

A járműjavító eszközök az alábbi szakaszokban találhatóak:

DIAGNOSZTIKA	1464T/N - 1465 1498SM - 1499 1758VT - 1760/IR 1600
MOTOR	955 - 960SN 1440 - 1462/KEP 1472 - 1485TC 1737 - 1759TT
OLAJ ÉS SZŰRŐK	1488/1 - 1496/C 1877 - 1889N
ELEKTROMOS RENDSZER	1489/33 - 1489Y 1497D - 1497RC
GYORSINDÍTÓK	1498BC/12 - 1498DG1100E
ERŐÁTVITEL	1884 - 1885/X C60 1438 - 1438DSG 1566N - 1569/F

FELFÜGGESZTÉS	1550U - 1567
FÉKEK	1466/C5 - 1471T/C5
KEREKEK	720MRC - 729T 962 - 989B 1530/C5 - 1531/C7
KAROSSZÉRIA	1065F5 - 1068 1302 - 1369/C11 1478 - 1479U/32 1505V - 1539 1763 - 1768
EGYÉB BERENDEZÉSEK	1875LT - 3067
EMELÉSTECHNIKA	3006 - 3069

GYORSINDÍTÓK, AKKUMULÁTOR TÖLTŐK ÉS VIZSGÁLÓMŰSZEREK

Beta
CHARGING

2023 januárjában a Beta Csoport sikeresen felvásárolta a Helvi S.p.A. vállalatot, amely a fémhegesztéshez szükséges professzionális berendezések egyik fő piaci szereplője.

A kínálatban megtalálhatók hordozható gyorsindítók személygépkocsikhoz és teherautókhoz, hagyományos és elektronikus – köztük kerekes – akkumulátortöltők, és vizsgálóműszerek.

A Beta a Helvi gyártási szakértelmére építve egyre szélesebb és speciálisabb termékválasztékot kínál a legigényesebb szakemberek számára.



1498BC/12

többfunkciós külső gyorsindító, 12V

Műszaki adatok:

- Indítóáram: 600A
- Indítócsúcs: 1500A
- Akkumulátor típus: 4 cella, LifePo4
- Akkumulátorkapacitás: 25000mAh
- Polaritáscsere, rövidzárlat, túláram, túltöltés és túlmelegedés elleni védelem



CE



Tartozékok:

- Védőtok
- Indítókábel akkucsiszesszel
- USB csatlakozó elektronikus eszközök töltéséhez
- LED akkumulátor töltésjelző
- USB és USB-C kábel
- Hálózati tápegység
- Multifunkciós LED zseblámpa

	L	P	H		
	mm	mm	mm	Ft	
1498BC/12	225	100	40	155.900	1 014980040

1498MN/12-C

tápkábel csipeszekkel az 1498BC/12 eszközhöz



		Ft	
1498MN/12-C		27.950	1 014980005

1498MN/12-R

hálózati adapter az 1498BC/12 mini gyorsindítóhoz



		Ft	
1498MN/12-R		20.450	1 014980003

1498MN/12-P

szivargyújtó csatlakozó az 1498BC/12 mini gyorsindítóhoz



1498MN/12-P	Ft		
	12.550	1	014980004

1498LT/12

hordozható nagyteljesítményű ultrakönnyű gyorsindító



CE

A mikroprocesszor teljes védelmet nyújt a következők ellen:
 - fázis felcserélés - rövidzárlat- hibás feszültség- túlterhelés-
 alultöltés- túltöltés- túlmelegedés

MŰSZAKI ADATOK
 Üzemi feszültség: 12 V
 Folyamatos áramerősség: 800 A
 Legnagyobb indítási áramerősség: 2000 A
 Csúcs áramerősség: 4000 A
 Vezetékek hossza: 500 mm
 Akkumulátor típus: 4 cellás LifePo4
 Memória Mentés funkció: IGEN
 Méretek: 260 x 135 x 72 mm
 Nettó súly: 2,5 kg
 12 V 1,3 A töltőegységgel rendelkezik

1498LT/12	Ft		
	396.800	1	014980012

1498LT/12-SF

fali rögzítőkengyel a 1498LT/12 csavarbehajtóhoz



1498LT/12-SF	Ft		
	66.000	1	014980013

1498LT/12-R7

hálózati adapter a 1498LT/12 gyorsindítóhoz



1498LT/12-R7	Ft		
	28.750	1	014980657

1498LT/12-24

hordozható nagy teljesítményű gyorsindító, 12-24 V, ultrakönnyű,

használható személygépkocsikhoz, haszongépjárművekhez és tehergépjárművekhez



CE

A mikroprocesszor teljes védelmet nyújt a következők ellen:

- fázis felcserélés
 - rövidzárlat
 - hibás feszültség
 - túlterhelés
 - alultöltés
 - túltöltés
 - túlmelegedés
- MŰSZAKI ADATOK
 Üzemi feszültség: 12/24V
 Folyamatos áramerősség: 2000/1000 A
 Legnagyobb indítási áramerősség: 5000/2500 A
 Csúcs áramerősség: 10000/5000 A
 csipesz áramerősség: 1000 A
 Kábelhossz: 160 cm
 Kábelátmérő: 25 mm²
 Automatikus tápellátás: 4 Amp
 Memória mentés funkció
 Méretek: 350x240x140 mm
 Súly: 5 kg

1498LT/12-24	Ft		
	787.400	1	014980014



1498EL/12

Külső gyorsindító, 12V

- minden típusú benzines és dízelüzemű, GT és kiskategóriás autó gyorsindítására, 12V
- töltés automatikus elektronikus tápon keresztül
- töltés szivargyújtón keresztül
- beépített védőbiztosíték
- LED akkumulátor töltés állapotjelző
- vállpánttal
- hermetikusan zárt ólomakkumulátor elektrolittal (AGM)



CE



Műszaki adatok:

- Indítócsúcs: 1800A
- Akkumulátorkapacitás: 22 Ah
- Kábelhossz: 1 m
- Tömeg: 9,8 kg

H	L	P	Ft		
mm	mm	mm	229.600	1	014980712

1498EL/12-24

Külső gyorsindító, 12/24V

- személygépkocsikhoz és kishasznajárműhöz, 12/24V
- töltés automatikus elektronikus tápon keresztül
- töltés szivargyújtón keresztül
- beépített védőbiztosíték
- LED akkumulátor töltés állapotjelző
- vállpánttal
- hermetikusan zárt ólomakkumulátor elektrolittal (AGM)



CE



Műszaki adatok:

- Indítócsúcs: 3600A 12V - 1800A 24V
- Akkumulátorkapacitás: 2x 22 Ah
- Kábelhossz: 2 m
- Tömeg: 18,5 kg

H	L	P	Ft		
mm	mm	mm	440.900	1	014980724

1498EL/12-R01

Tartalék akkumulátor, 12V,
az EL/12V és EL/12-24V gyorsindítóhoz

CE



1498EL/12-R01 Ft 80.150 1 014980713

1498/12-24 R20

hálózati adapter 1498/12 és 1498/24
gyorsindítóhoz



1498/12-24 R20 Ft 34.800 1 014980520

1498PRO/12

Külső gyorsindító, 12V, Pro

- minden típusú benzines és dízelüzemű, GT és kiskategóriás autó gyorsindítására, 12V
- grafikus kijelző ampermérővel és töltésállapot jelzéssel
- töltés automatikus elektronikus tápon keresztül
- töltés szivargyújtón keresztül
- beépített védőbiztosíték
- vállpánttal
- hermetikusan zárt ólomakkumulátor elektrolittal (AGM)

ELÉRHETŐ
JÚNIUSTÓL



- Műszaki adatok:
- Indítóáram: 3200A
 - Akkumulátorkapacitás: 25 Ah
 - Kábelhossz: 2 m
 - Tömeg: 15,8 kg

L mm 255 P mm 210 H mm 380 Ft 311.700 1 014980812

1498PRO/12-R01

Tartalék akkumulátor, 12V,
az 1498PRO/12V gyorsindítóhoz



C58K/4PF-2,1M Ft 155.900 1 014980813

1498PRO/12-24

Külső gyorsindító, 12/24V, Pro

- minden típusú gépjármű gyorsindítására, 12V vagy 24V akkumulátorhoz
- grafikus kijelző ampermérővel és töltésállapot jelzéssel
- töltés automatikus elektronikus tápon keresztül
- töltés szivargyújtón keresztül
- beépített védőbiztosíték
- vállpánttal
- hermetikusan zárt ólomakkumulátor elektrolittal (AGM)

ELÉRHETŐ
JÚNIUSTÓL



Műszaki adatok:

- Indítóáram: 5000A 12V - 2500A 24V
- Akkumulátorkapacitás: 2 x 18 Ah
- Kábelhossz: 2 m
- Tömeg: 19,8 kg

L mm 255 P mm 210 H mm 380 Ft 623.500 1 014980824

1498PRO/12-24 R01

Tartalék akkumulátor, 12V,
az 1498PRO/12-12V gyorsindítóhoz



C58K/4PF-2,1M Ft 69.000 1 014980825

1498/2A

12 V elektronikus motorkerékpár
akkumulátor töltő

lehetővé teszi minden
Pb Wet, Agm, Gel, Mf, Vrla
típusú akkumulátor, és
a Litium LiFePo4 akkumulátor töltését



- két egyedi akkumulátor töltési típus a Litiumos és az ólom akkumulátorokhoz
- automatikus többfázisú töltési ciklus
- polaritáscsere és rövidzárlat elleni védelem
- IP65 védelmi fok
- csipeszes vezetékkel és alátétgyűrűs vezetékkel szállítva
- tápfeszültség: 220-240 V

MŰSZAKI ADATOK

- töltőáram: 1A
- törlőkapacitás: 2 Ah-40A h
- frekvencia: 50-60 Hz
- az akkumulátor feszültsége: 12 V
- méretek: 180x80x40 mm
- súly: 0,5 Kg

1498/2A Ft 61.550 1 014980102

1498SA/2A-4A

szivargyújtós csatlakozó
a 1498/2A és 1498/4A készülékekhez



1498SA/2A-4A Ft 15.600 1 014980120

1498/4A-8A CO

gyűrűs vezeték a 1498/4A és 8A
készülékekhez



1498/4A-8A-CO Ft 7.530 1 014980114

1498/4A-8A CP

csipeszes vezeték a 1498/4A és 8A
készülékekhez



1498/4A-8A-CP Ft 9.680 1 014980118

1498/2A-8A-PR

hosszabbító a 1498/2A/4A/8A modellhez



1498/2A-8A-PR Ft 18.000 1 014980119



1498H/4A

Többfunkciós elektronikus akkumulátortöltő,

6-12V

Jellemzők:

- LCD kijelző • 3 fényerősségű LED
- Töltés és töltésfenntartás
- Polaritáscsere, rövidzárlat, túlmelegedés, túltöltés és hőmérséklet-túllépés elleni védelem
- Szikravédelem
- 9 töltési lépés
- Cseppöntő rendszer
- Funkciók: akkumulátor helyreállítás, tesztelés és kéntelenítés
- Csipesztartó
- Fekvő rögzítőkampó
- Tartozékok: csipeszes kábel, alátétgyűrűs kábel

6-12V
5Ah - 120Ah



IP65

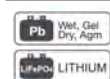

Műszaki adatok:

- Tápfeszültség: 230V - 50/60Hz
- Töltőáram: 1-4A
- Akkumulátor típusok: Pb - GEL - Ca/Ca - AGM - Start/Stop - Lithium (LiFePO4)
- Töltőkapacitás: 5-80Ah (LiFePO4 1-80Ah)
- Fenntartási kapacitás: 5-120Ah (LiFePO4 1-120Ah)
- Kimeneti feszültség: 6-12V
- Védelmi fokozat: IP65 védettség

L	P	H	Ft	1
mm	mm	mm		
181	91	58	71.250	1 014980204

1498H/8A

Többfunkciós elektronikus akkumulátortöltő,
12-24V

Jellemzők:

- LCD kijelző
- 3 fényerősségű LED
- Töltés, töltésfenntartás és tápellátás
- Polaritáscsere, rövidzárlat, túlmelegedés, túltöltés és hőmérséklet-túllépés elleni védelem
- Szikravédelem
- 9 töltési lépés
- Cseppöntő rendszer
- Funkciók: akkumulátor helyreállítás, tesztelés és kéntelenítés
- Csipesztartó
- Fekvő rögzítőkampó
- Tartozékok: csipeszes kábel, alátétgyűrűs kábel

12-24V
10Ah - 250Ah



IP65

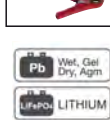

Műszaki adatok:

- Tápfeszültség: 230V - 50/60Hz
- Töltőáram: 2-8A
- Akkumulátor típusok: Pb - GEL - Ca/Ca - AGM - Start/Stop - Lithium (LiFePO4)
- Töltőkapacitás: 10-160Ah (LiFePO4 2-160Ah)
- Fenntartási kapacitás: 10-250Ah (LiFePO4 2-250Ah)
- Tápellátás (DC): 13.8V - 5A
- Kimeneti feszültség: 12-24V
- Védelmi fokozat: IP65 védettség

L	P	H	Ft	1
mm	mm	mm		
223	112	68	87.650	1 014980208

1498H/16A

Többfunkciós elektronikus akkumulátortöltő,
12-24V

Jellemzők:

- LCD kijelző
- 3 fényerősségű LED
- Töltés, töltésfenntartás és tápellátás
- Polaritáscsere, rövidzárlat, túlmelegedés, túltöltés és hőmérséklet-túllépés elleni védelem
- Szikravédelem
- 9 töltési lépés
- Cseppöntő rendszer
- Funkciók: akkumulátor helyreállítás, tesztelés és kéntelenítés
- Csipesztartó
- Fekvő rögzítőkampó
- Tartozékok: csipeszes kábel, alátétgyűrűs kábel

12-24V
20Ah - 550Ah



IP20

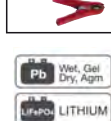

Műszaki adatok:

- Tápfeszültség: 230V - 50/60Hz
- Töltőáram: 4-16A
- Akkumulátor típusok: Pb - GEL - Ca/Ca - AGM - Start/Stop - Lithium (LiFePO4)
- Töltőkapacitás: 20-360Ah (LiFePO4 4-360Ah)
- Fenntartási kapacitás: 20-550Ah (LiFePO4 4-550Ah)
- Tápellátás (DC): 13.8V - 12A
- Kimeneti feszültség: 12-24V
- Védelmi fokozat: IP20

L	P	H	Ft	1
mm	mm	mm		
298	152	88	129.100	1 014980216



1498H/25A

Többfunkciós elektronikus akkumulátortöltő,
12-24V

Jellemzők:

- LCD kijelző
- 3 fényerősségű LED
- Töltés, töltésfenntartás és tápellátás
- Polaritáscsere, rövidzárlat, túlmelegedés, túltöltés és hőmérséklet-túllépés elleni védelem
- Szikravédelem
- 9 töltési lépés
- Cseppöntő rendszer
- Funkciók: akkumulátor helyreállítás, tesztelés és kéntelenítés
- Csipesztartó
- Fekvő rögzítőkampó
- Tartozékok: kábel csipeszszel



IP20

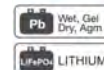

Műszaki adatok:

- Tápfeszültség: 230V - 50/60Hz
- Töltőáram: 6-24A
- Akkumulátor típusok: Pb - GEL - Ca/Ca - AGM - Start/Stop - Lithium (LiFePO4)
- Töltőkapacitás: 30-550Ah (LiFePO4 6-550Ah)
- Fenntartási kapacitás: 30-800Ah (LiFePO4 6-800Ah)
- Tápellátás (DC): 13.8V - 20A
- Kimeneti feszültség: 12-24V
- Védelmi fokozat: IP20

L	P	H	Ft	1
mm	mm	mm		
298	152	88	138.100	1 014980225

1498/PR14

Hagyományos akkumulátortöltő, 6/12V

Jellemzők:

- Ólom-savas akkumulátorokhoz
- Feszültség/áramerősség választó
- Ampermérő
- Automatikus termikus túlterhelés-védelem
- Fordított polaritás elleni védelem



Műszaki adatok:

- Tápfeszültség (1 fázis): 230 V - 50/60 Hz
- Teljesítmény: 140 W
- Feszültség: 6/12 V
- Maximális áramerősség: 11 A
- Töltőáram: 7,5 A
- Töltőkapacitás: 112 Ah 15h
- Töltési pozíció: 2

L	P	H	Ft	1
mm	mm	mm		
260	200	175	62.750	1 014980730

1498/PR17

Hagyományos akkumulátortöltő, 12/24V

Jellemzők:

- Ólom-savas akkumulátorokhoz
- Feszültség/áramerősség választó
- Ampermérő
- Automatikus termikus túlterhelés-védelem
- Fordított polaritás elleni védelem



CE

Műszaki adatok:

- Tápfeszültség (1 fázis): 230 V - 50/60 Hz
- Teljesítmény: 300 W
- Feszültség: 12/24 V
- Maximális áramerősség: 12,5 A
- Töltőáram: 8,5 A
- Töltőkapacitás: 128 Ah 15h
- Töltési pozíció: 2

L	P	H	Ft		
mm	mm	mm			
260	200	175	69.450	1	014980731

1498/PR25

Hagyományos akkumulátortöltő, 6/12/24 V

Jellemzők:

- Nagy töltőállomásokhoz
- Ólom-savas akkumulátorokhoz
- Feszültség/áramerősség választó
- Ampermérő
- Automatikus termikus túlterhelés-védelem



CE

Műszaki adatok:

- Tápfeszültség (1 fázis): 230 V - 50/60 Hz
- Teljesítmény: 620 W
- Feszültség: 6/12/24 V
- Maximális áramerősség: 25 A
- Töltőáram: 17 A
- Töltőkapacitás: 255 Ah 15h
- Töltési pozíció: 6

L	P	H	Ft		
mm	mm	mm			
250	245	435	186.600	1	014980733

1498/AM30

Automatikus hagyományos akkumulátortöltő, 12/24 V

Jellemzők:

- AGM, zselés, ólom-savas és Start/Stop akkumulátorokhoz
- Elektronikus vezérlésű töltőáram
- Töltési állapotjelző lámpa
- Potenciométerrel szabályozható töltőáram
- Automatikus töltés funkció
- Töltésfenntartás funkció



CE

Műszaki adatok:

- Tápfeszültség (1 fázis): 230 V - 50/60 Hz
- Teljesítmény: 720 W
- Feszültség: 12/24 V
- Maximális áramerősség: 30 A
- Töltőáram: 20 A
- Töltőkapacitás: 300 Ah 15h
- Töltési pozíció: ∞

L	P	H	Ft		
mm	mm	mm			
220	235	335	264.400	1	014980740

1498/PR20

Hagyományos akkumulátortöltő, 12/24V

Jellemzők:

- Ólom-savas akkumulátorokhoz
- Feszültség/áramerősség választó
- Ampermérő
- Automatikus termikus túlterhelés-védelem
- Fordított polaritás elleni védelem



CE

Műszaki adatok:

- Tápfeszültség (1 fázis): 230 V - 50/60 Hz
- Teljesítmény: 390 W
- Feszültség: 12/24 V
- Maximális áramerősség: 16 A
- Töltőáram: 11 A
- Töltőkapacitás: 165 Ah 15h
- Töltési pozíció: 2

L	P	H	Ft		
mm	mm	mm			
260	200	175	93.500	1	014980732

1498/PR35B

Hagyományos akkumulátortöltő, 6/12/24/36/48 V

Jellemzők:

- Nagy töltőállomásokhoz
- Ólom-savas akkumulátorokhoz
- Feszültség/áramerősség választó
- Ampermérő
- Automatikus termikus túlterhelés-védelem



CE

Műszaki adatok:

- Tápfeszültség (1 fázis): 230 V - 50/60 Hz
- Teljesítmény: 1830 W
- Feszültség: 6/12/24/36/48 V
- Maximális áramerősség: 38 A
- Töltőáram: 25 A
- Töltőkapacitás: 375 Ah 15h
- Töltési pozíció: 12

L	P	H	Ft		
mm	mm	mm			
250	245	435	351.800	1	014980734

1498/SP150

Hagyományos akkumulátortöltő / gyorsindító, 12V

Jellemzők:

- Ólom-savas akkumulátorokhoz
- Töltőáram választó
- Ampermérő
- Hosszú indítás elleni termosztatikus védelem
- Rövidzárlat ellen védő biztosíték
- Fordított polaritás elleni védelem



CE

Műszaki adatok:

- Tápfeszültség (1 fázis): 230 V - 50/60 Hz
- Teljesítmény: 190 W
- Feszültség: 12 V
- Maximális áramerősség: 15 A
- Töltőáram: 11 A
- Max. gyorsítóáram: 120 Acc
- Indítóáram: 85 A
- Töltőkapacitás: 165 Ah 15h
- Töltési pozíció: 2 + boost

L	P	H	Ft		
mm	mm	mm			
260	200	175	89.050	1	014980745

1498/SP250

Hagyományos akkumulátortöltő / gyorsindító, 12/24V

Jellemzők:

- Ólom-savas akkumulátorokhoz
- Töltőáram választó
- Ampermérő
- Hosszú indítás elleni termostatikus védelem
- Rövidzárlat ellen védő biztosíték
- Fordított polaritás elleni védelem



CE

Műszaki adatok:

- Tápfeszültség (1 fázis): 230 V - 50/60 Hz
- Teljesítmény: 650 W
- Feszültség: 12/24 V
- Maximális áramerősség: 27 A
- Töltőáram: 18 A
- Max. gyorsítóáram: 200 Acc
- Indítóáram: 135 A
- Töltőkapacitás: 270 Ah 15h
- Töltési pozíció: 2 + boost

L	P	H	Ft		
mm	mm	mm			
220	235	335	141.300	1	014980746

1498/RP480

Hagyományos akkumulátortöltő / gyorsindító, 12/24V

Jellemzők:

- Ólom-savas akkumulátorokhoz
- Töltőáram választó
- Ampermérő
- Hosszú indítás elleni termostatikus védelem
- Rövidzárlat ellen védő biztosíték
- Fordított polaritás elleni védelem



CE

Műszaki adatok:

- Tápfeszültség (1 fázis): 230 V - 50/60 Hz
- Teljesítmény: 1320 W
- Feszültség: 12/24 V
- Maximális áramerősség: 55 A
- Töltőáram: 36 A
- Max. gyorsítóáram: 450 Acc
- Indítóáram: 315 A
- Töltőkapacitás: 450 Ah 15h
- Töltési pozíció: 6 + boost

L	P	H	Ft		
mm	mm	mm			
250	245	435	259.100	1	014980751

1498/SC441

Kerek akkumulátortöltő / gyorsindító, 12/24V

Jellemzők:

- Ólom-savas akkumulátorokhoz
- Lassú/gyors töltőáram választó
- Ampermérő
- Hosszú indítás elleni termostatikus védelem
- Rövidzárlat ellen védő biztosíték
- Fordított polaritás elleni védelem



CE

Műszaki adatok:

- Tápfeszültség (1 fázis): 230 V - 50/60 Hz
- Teljesítmény: 1320 W
- Feszültség: 12/24 V
- Maximális áramerősség: 55 A
- Töltőáram: 36 A
- Max. gyorsítóáram: 380 Acc
- Indítóáram: 260 A
- Töltőkapacitás: 450 Ah 15h
- Töltési pozíció: 3 + boost

L	P	H	Ft		
mm	mm	mm			
260	395	770	230.800	1	014980756

1498/RP380

Hagyományos akkumulátortöltő / gyorsindító, 12/24V

Jellemzők:

- Ólom-savas akkumulátorokhoz
- Töltőáram választó
- Ampermérő
- Hosszú indítás elleni termostatikus védelem
- Rövidzárlat ellen védő biztosíték
- Fordított polaritás elleni védelem



CE

Műszaki adatok:

- Tápfeszültség (1 fázis): 230 V - 50/60 Hz
- Teljesítmény: 900 W
- Feszültség: 12/24 V
- Maximális áramerősség: 38 A
- Töltőáram: 25 A
- Max. gyorsítóáram: 280 Acc
- Indítóáram: 200 A
- Töltőkapacitás: 270 Ah 15h
- Töltési pozíció: 2 + boost

L	P	H	Ft		
mm	mm	mm			
220	235	335	186.600	1	014980750

1498/SC341

Kerek akkumulátortöltő / gyorsindító, 12/24V

Jellemzők:

- Ólom-savas akkumulátorokhoz
- Lassú/gyors töltőáram választó
- Ampermérő
- Hosszú indítás elleni termostatikus védelem
- Rövidzárlat ellen védő biztosíték
- Fordított polaritás elleni védelem



CE

Műszaki adatok:

- Tápfeszültség (1 fázis): 230 V - 50/60 Hz
- Teljesítmény: 1080 W
- Feszültség: 12/24 V
- Maximális áramerősség: 45 A
- Töltőáram: 30 A
- Max. gyorsítóáram: 340 Acc
- Indítóáram: 200 A
- Töltőkapacitás: 375 Ah 15h
- Töltési pozíció: 3 + boost

L	P	H	Ft		
mm	mm	mm			
260	395	770	212.100	1	014980755

1498/SC540

Kerek akkumulátortöltő / gyorsindító, 12/24V

Jellemzők:

- Ólom-savas akkumulátorokhoz
- Lassú/gyors töltőáram választó
- Ampermérő
- Hosszú indítás elleni termostatikus védelem
- Rövidzárlat ellen védő biztosíték
- Fordított polaritás elleni védelem
- Töltés időzítő



CE

Műszaki adatok:

- Tápfeszültség (1 fázis): 230 V - 50/60 Hz
- Teljesítmény: 1440 W
- Feszültség: 12/24 V
- Maximális áramerősség: 60 A
- Töltőáram: 40 A
- Max. gyorsítóáram: 480 Acc
- Indítóáram: 330 A
- Töltőkapacitás: 525 Ah 15h
- Töltési pozíció: 6 + boost

L	P	H	Ft		
mm	mm	mm			
350	465	840	314.600	1	014980757

1498/SC640

Kerekes akkumulátortöltő / gyorsindító, 12/24V

Jellemzők:

- Ólom-savas akkumulátorokhoz
- Lassú/gyors töltőáram választó
- Ampermérő
- Hosszú indítás elleni termostatikus védelem
- Rövidzárlat ellen védő biztosíték
- Fordított polaritás elleni védelem
- Töltés időzítő

CE



Műszaki adatok:

- Tápfeszültség (1 fázis): 230 V - 50/60 Hz
- Teljesítmény: 1800 W
- Feszültség: 12/24 V
- Maximális áramerősség: 75 A
- Töltőáram: 50 A
- Max. gyorsítóáram: 550 Acc
- Indítóáram: 400 A
- Töltőkapacitás: 600 Ah 15h
- Töltési pozíció: 6 + boost

L	P	H	Ft		
mm	mm	mm			
350	465	840	346.600	1	014980758

1498/AT500

Akkumulátortöltő / gyorsindító, 12/24 V

A CPS (Car Protection System - a gépjármű elektronikáját védő rendszer) technológiával felszerelt készülék, amely lehetővé teszi a gyorsító funkció teljesen automatikus aktiválását és deaktiválását a jármű fedélzeti elektronikájának védelme érdekében.

Jellemzők:

- Ólom-savas akkumulátorokhoz
- Töltőáram választó
- Ampermérő
- Hosszú indítás elleni termostatikus védelem
- Rövidzárlat ellen védő biztosíték
- Fordított polaritás elleni védelem

CE



Műszaki adatok:

- Tápfeszültség (1 fázis): 230 V - 50/60 Hz
- Teljesítmény: 890 W
- Feszültség: 12/24 V
- Maximális áramerősség: 37 A
- Töltőáram: 30 A
- Max. gyorsítóáram: 450 Acc
- Indítóáram: 320 A
- Töltőkapacitás: 540 Ah 15h
- Töltési pozíció: 6 + boost

L	P	H	Ft		
mm	mm	mm			
250	345	280	268.800	1	014980761

1498/AT701

Kerekes akkumulátortöltő / gyorsindító, 12/24V

A CPS (Car Protection System - a gépjármű elektronikáját védő rendszer) technológiával felszerelt készülék, amely lehetővé teszi a gyorsító funkció teljesen automatikus aktiválását és deaktiválását a jármű fedélzeti elektronikájának védelme érdekében.

Jellemzők:

- Ólom-savas akkumulátorokhoz
- Töltőáram választó
- Ampermérő
- Hosszú indítás elleni termostatikus védelem
- Rövidzárlat ellen védő biztosíték
- Fordított polaritás elleni védelem

CE



CE



Műszaki adatok:

- Tápfeszültség (1 fázis): 230 V - 50/60 Hz
- Teljesítmény: 300 W
- Feszültség: 12 V
- Maximális áramerősség: 25 A
- Töltőáram: 20 A
- Max. gyorsítóáram: 300 Acc
- Indítóáram: 210 A
- Töltőkapacitás: 375 Ah 15h
- Töltési pozíció: 2 + boost

L	P	H	Ft		
mm	mm	mm			
250	345	280	219.400	1	014980760

1498/AT1001

Kerekes akkumulátortöltő / gyorsindító, 12/24V

A CPS (Car Protection System - a gépjármű elektronikáját védő rendszer) technológiával felszerelt készülék, amely lehetővé teszi a gyorsító funkció teljesen automatikus aktiválását és deaktiválását a jármű fedélzeti elektronikájának védelme érdekében.

Jellemzők:

- Ólom-savas akkumulátorokhoz
- Töltőáram választó
- Ampermérő
- Hosszú indítás elleni termostatikus védelem
- Rövidzárlat ellen védő biztosíték
- Fordított polaritás elleni védelem

CE



Műszaki adatok:

- Tápfeszültség (1 fázis): 230 V - 50/60 Hz
- Teljesítmény: 2200 W
- Feszültség: 12/24 V
- Maximális áramerősség: 90 A
- Töltőáram: 60 A
- Max. gyorsítóáram: 980 Acc
- Indítóáram: 560 A
- Töltőkapacitás: 1350 Ah 15h
- Töltési pozíció: 14 + boost

L	P	H	Ft		
mm	mm	mm			
350	465	840	706.500	1	014980763

1498/AT1300

Kerekes akkumulátortöltő / gyorsindító, 12/24V

A CPS (Car Protection System - a gépjármű elektronikáját védő rendszer) technológiával felszerelt készülék, amely lehetővé teszi a gyorsító funkció teljesen automatikus aktiválását és deaktiválását a jármű fedélzeti elektronikájának védelme érdekében.

Jellemzők:

- Ólom-savas akkumulátorokhoz
- Töltőáram választó
- Ampermérő
- Hosszú indítás elleni termostatikus védelem
- Rövidzárlat ellen védő biztosíték
- Fordított polaritás elleni védelem

CE



Műszaki adatok:

- Tápfeszültség (1 fázis): 230 V - 50/60 Hz
- Teljesítmény: 2900 W
- Feszültség: 12/24 V
- Maximális áramerősség: 120 A
- Töltőáram: 80 A
- Max. gyorsítóáram: 1280 Acc
- Indítóáram: 850 A
- Töltőkapacitás: 1800 Ah 15h
- Töltési pozíció: 12 + boost

L	P	H	Ft		
mm	mm	mm			
575	330	770	1.210.500	1	014980764

1498/AT2000

Kerekes akkumulátortöltő / gyorsindító, 12/24V

A CPS (Car Protection System - a gépjármű elektronikáját védő rendszer) technológiával felszerelt készülék, amely lehetővé teszi a gyorsító funkció teljesen automatikus aktiválását és deaktiválását a jármű fedélzeti elektronikájának védelme érdekében.

Jellemzők:

- Ólom-savas akkumulátorokhoz
- Töltőáram választó
- Ampermérő
- Hosszú indítás elleni termostatikuss védelem
- Rövidzárlat ellen védő biztosíték
- Fordított polaritás elleni védelem



CE

Műszaki adatok:

- Tápfeszültség (1 fázis): 230 V - 50/60 Hz
- Teljesítmény: 3600 W
- Feszültség: 12/24 V
- Maximális áramerősség: 150 A
- Töltőáram: 120A
- Max. gyorsítóáram: 2000 Acc
- Indítóáram: 1100 A
- Töltőkapacitás: 2250 Ah 15h
- Töltési pozíció: 12 + boost

L	P	H	Ft		
mm	mm	mm			
575	330	770	1.708.500	1	014980765

1498/DG540E

Elektronikus akkumulátortöltő / gyorsindító, 12/24V, kerekes

A CPS (Car Protection System - a gépjármű elektronikáját védő rendszer) technológiával felszerelt készülék, amely lehetővé teszi a gyorsító funkció teljesen automatikus aktiválását és deaktiválását a jármű fedélzeti elektronikájának védelme érdekében.

Jellemzők:

- Ólom-savas, AGM, zselés, Ca/Ca és Start/Stop akkumulátorokhoz
- Mikroprocesszoros elektronikus töltésvezérlés
- Töltési idő beállítás
- Digitális kijelző
- Töltési állapotjelző LED-ek
- Vezérlő rendszer: polaritás váltás, túláram, akkumulátor meghibásodás jelző, biztonságos indítás, védett indítás



CE

Műszaki adatok:

- Tápfeszültség (1 fázis): 230 V - 50/60 Hz
- Teljesítmény: 1320 W
- Feszültség: 12/24 V
- Maximális áramerősség: 55 A
- Töltőáram: 36 A
- Max. gyorsítóáram: 380 Acc
- Indítóáram: 260 A
- Töltőkapacitás: 810 Ah 15h
- Töltési pozíció: 4 + boost

L	P	H	Ft		
mm	mm	mm			
395	260	770	424.700	1	014980770

1498/DG1100E

Elektronikus akkumulátortöltő / gyorsindító, 12/24V, kerekes

A CPS (Car Protection System - a gépjármű elektronikáját védő rendszer) technológiával felszerelt készülék, amely lehetővé teszi a gyorsító funkció teljesen automatikus aktiválását és deaktiválását a jármű fedélzeti elektronikájának védelme érdekében.

Jellemzők:

- Ólom-savas, AGM, zselés, Ca/Ca és Start/Stop akkumulátorokhoz
- Mikroprocesszoros elektronikus töltésvezérlés
- Töltési idő beállítás
- Digitális kijelző
- Töltési állapotjelző LED-ek
- Vezérlő rendszer: polaritás váltás, túláram, áramkimaradás jelző, biztonságos indítás, védett indítás



CE

Műszaki adatok:

- Tápfeszültség (1 fázis): 230 V - 50/60 Hz
- Teljesítmény: 2400 W
- Feszültség: 12/24 V
- Maximális áramerősség: 100 A
- Töltőáram: 70 A
- Max. gyorsítóáram: 580 Acc
- Indítóáram: 400 A
- Töltőkapacitás: 5000 Ah 15h
- Töltési pozíció: 4 + boost + supply

L	P	H	Ft		
mm	mm	mm			
465	350	840	562.800	1	014980771

1498SM

Adattároló egység 12 V

Személyautó-komputer tárolja az adatokat a karbantartás és akkumulátorcsere közben



CE



Műszaki adatok:

- Automatikus
- Belső akkumulátor Pb 5 Ah
- 12 Volt
- Profesionális csatlakozás OBD dugással

	Ft		
1498SM	119.000	1	014980020

1498TB/12-24N

Digitális akkumulátor vizsgálo, 12-24V, beépített nyomtatóval

A következő tesztek elvégzését teszi lehetővé: akkumulátor, generátor, indítómotor és rendszer

- fordított polaritás elleni védelem
- telepített szoftver PC csatlakoztatáshoz
- hátsó megvilágítású kijelző
- kompakt, ütészérvet szerkeszt
- 9 választható nyelv



CE

Műszaki adatok:

- Alkalmazások: 12V és 24V akkumulátor
- Működési tartomány: 100-2000 CCA
- Referencia szabványok: CCA,SAE,DIN,EN,IEC,JIS, MCA, GB, BCI, CA
- Támogatott akkumulátorok: PB, WET, GEL, AGM, AGM FLAT, EFB, SLI
- Voltmérő: 9V-30V
- Kábelhossz: 1800 mm
- Támogatott nyelvek: angol, francia, holland, lengyel, magyar, német, olasz, portugál, spanyol
- Tartozékok: USB kábel, 3 nyomtató papírtekerccs

	Ft		
1498TB/12-24N	164.800	1	014980402

1498TB/6-12

analóg 6-12V akkumulátor vizsgálo

6V és 12V akkumulátorokhoz maximum 1000CCA-ig



Kábelhossz: 500 mm

L	L1	P	Ft		
mm	mm	mm			
290	170	75	27.550	1	014980420

1498ST/TB ROT

tartalék papír
1498TB/12-24N tesztelőhöz



	Ft		
1498ST/TB ROT	5.510	2	014980411

1498PC

feszültségstabilizátor 12 - 24 V

Nélkülözhetetlen a vezérlőegységek védelméhezhegesztés és gyorsindítóval történő indítás közben



1498PC	Ft	1	014980801
	47.150		

1499

Sztetoszkóp, acélszonda és fülhallgató, nylon nyüllel



1499	Ft	1	014990001
	47.550		

1500/...

Kétkörmös univerzális csapáglehúzó, galvanizált

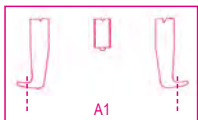
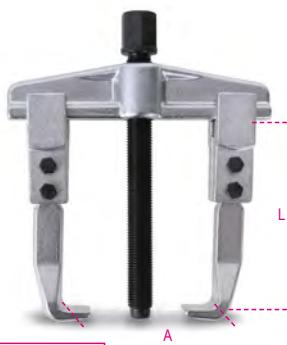

L mm	Ft		
1500/1	39.850	1	015000301
1500/2	41.700	1	015000302
1500/3	69.250	1	015000303
1500/4	95.150	1	015000304
1500/5	172.900	1	015000305
1500/6	202.800	1	015000306
1500/7	303.200	1	015000307
1500/8	485.400	1	015000308

	A min+max mm	A1 min+max mm
1500/1	25÷80	70÷130
1500/2	25÷130	80÷180
1500/3	50÷160	105÷220
1500/4	60÷200	120÷270
1500/5	80÷250	160÷330
1500/6	80÷350	160÷420
1500/7	110÷520	195÷600
1500/8	170÷640	260÷715



1500/SP5	Ft	1	015000325
1500/1-1500/2-1500/3	447.600		
1500/4-1500/5			
1500/SPV	39.050	1	015000001

1500G/...

1 pár normál lehúzókörm az 1500 és az 1580/8I modellhez



	mm	1500	Ft		
1500G/1	35	/1-2	25.700	1	015000311
1500G/3	35	/3-4	37.850	1	015000313
1500G/5	35	/5-6-7	76.900	1	015000315
1500G/8	50	/8	94.350	1	015000317
		1580/8I			

1500N/...

Kétkörmös univerzális csapáglehúzó

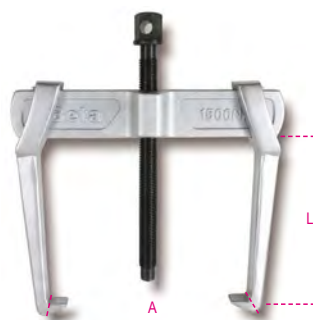

	A min+max mm	L mm	Ft		
1500N0	18÷65	70	35.600	1	015000600
1500N1	23÷70	100	37.250	1	015000601
1500N2	23÷100	100	40.300	1	015000602
1500N3	35÷140	150	67.000	1	015000603
1500N4	35÷190	150	72.050	1	015000604
1500N5	43÷250	205	138.900	1	015000605
1500N6	43÷320	205	150.600	1	015000606



1500N/SP6	Ft	1	015000626
1500N/0-1500N/1-1500N/2-1500N/3	391.100		
1500N/4-1500N/5			
1500N/SPV	47.150	1	015000006

1500N/G...

Lehúzókörm 1500N típusú csapáglehúzóhoz



	mm	1500N	Ft		
1500N/G0	10	/0	11.750	2	015000650
1500N/G1-2	12	/1-2	12.550	2	015000651
1500N/G3-4	17	/3-4	22.050	2	015000653
1500N/G5-6	23	/5-6	43.500	2	015000655

1501/1 - 2 - 3

Keskeny kétkörmös csapáglehúzó, galvanizált, barnított körömhegyek

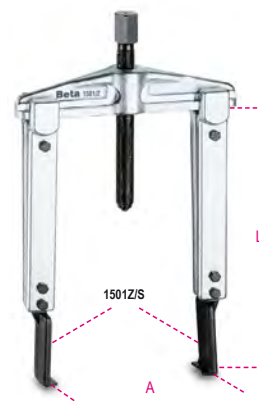

L mm	Ft		
1501/1	89.650	1	015010101
1501/2	95.150	1	015010102
1501/3	100.000	1	015010103

A min+Max mm	Ft		
1501/1	25÷130	1	015010101
1501/2	25÷130	1	015010102
1501/3	25÷130	1	015010103



1501G/1 - 2 - 3

Keskeny köröm az 1501 modellhez, galvanizált



	L mm	Ft		
1501G/1	100	49.400	1	015010111
1501G/2	200	57.500	1	015010112
1501G/3	250	62.350	1	015010113

1501Z/S - P - R

Keskeny körömhegy az 1501G típusú körömhöz, barnított



	± 0.05 mm	D mm	A mm	Ft		
1501Z/S	2.0	27	8	17.600	2	015010211
1501Z/P	3.6	27	8	18.000	2	015010212
1501Z/R	3.6	14	8	20.250	2	015010213

1502/...

kétkörömös univerzális csapáglehúzó gyors beállítással és zárással

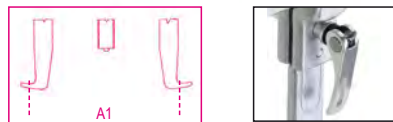
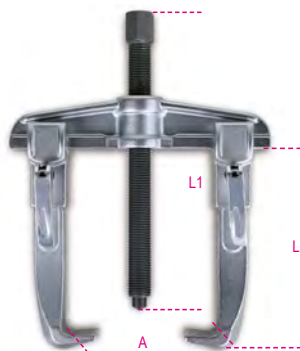

	L mm	L1 mm	Ft		
1502/0	100	166	59.100	1	015020000
1502/1	100	166	64.150	1	015020001
1502/2	150	247	101.600	1	015020002
1502/3	150	247	112.600	1	015020003
1502/4	200	321	193.100	1	015020004

	A min+Max mm	A1 min+Max mm
1502/0	40÷90	80÷130
1502/1	50÷130	90÷170
1502/2	65÷150	115÷210
1502/3	65÷190	125÷260
1502/4	70÷235	170÷335

1505V

ablaktörő és hátsó ablaktörő kar lehúzó

kivehető furatolt sárgaréz hegy beépített ablakmosó fúvókával szerelt ablaktörő karok lehúzásához



	A Max mm	L mm	Ft		
1505V	43	37	20.650	1	015050001

1506

Önzáró kétkörömös csapáglehúzó, galvanizált

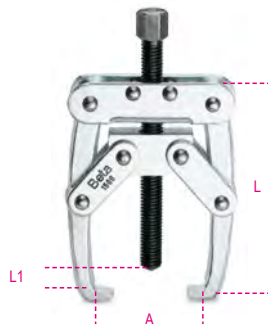

	A min+Max mm	L mm	L1 mm	Ft		
1506	10÷50	80	40	21.450	1	015060001

1508/1 - 1508/2

Könnyített kétkörömös csapáglehúzó, galvanizált

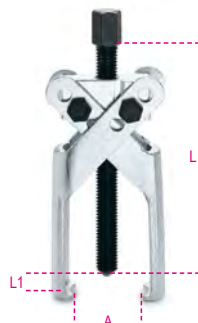

	L mm	Ft		
1508/1	105	71.450	1	015080001
1508/2	130	85.000	1	015080002

	A min+Max mm	L1 mm
1508/1	6÷100	85
1508/2	10÷140	120

Beta

1511/1 - 2 - 3

Átfordítható, kétkörömös kettős működésű csapáglehúzó, galvanizált

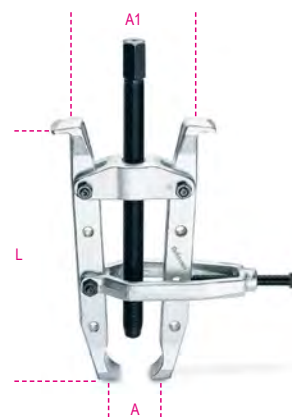

	L mm	Ft		
1511/1	235	121.100	1	015110001
1511/2	330	151.400	1	015110002
1511/3	405	187.900	1	015110003

	A min+Max mm	A1 min+Max mm
1511/1	20÷100	65÷95
1511/2	40÷150	103÷190
1511/3	40÷150	103÷175

1515/1 - 2 - 3

Allítható kétkörömös csapáglehúzó, galvanizált



	L mm	Ft		
1515/1	85	15.800	1	015150101
1515/2	85	16.800	1	015150102
1515/3	105	25.100	1	015150103

	A Max mm	L1 mm
1515/1	60	105
1515/2	70	105
1515/3	90	105

1516/1 - 2 - 3

Állítható háromkörmös csapágylehúzó, galvanizált



	L mm	Ft		
1516/1	85	22.850	1	015160001
1516/2	85	24.500	1	015160002
1516/3	105	34.800	1	015160003

	A Max mm	L1 mm
1516/1	60	85
1516/2	70	85
1516/3	90	105

1517

Állítható háromkörmös csapágylehúzó

- Nagy teljesítményű.
- Önzáró.

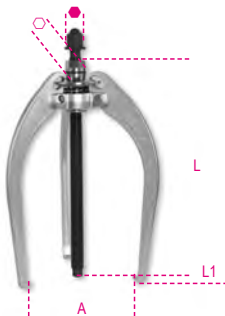

	L mm	L1 mm	Ø mm	Ft		
1517/90	182	60	22	124.300	1	015170000
1517/150	242	115	22	127.500	1	015170010
1517/200	307	150	22	147.000	1	015170020
1517/260	395	180	30	170.400	1	015170030

	● mm	A mm	Max kg	N
1517/90	19	18÷90	6000	59000
1517/150	19	25÷150	6000	59000
1517/200	19	40÷200	6000	59000
1517/260	27	50÷260	8000	78500

1517C

KÉT-/HÁROMKÖRMÖS ÖNZÁRÓ CSAPÁGYLEHÚZÓ KÜLSŐ LEHÚZÁSRA

A Beta 1517C csapágylehúzójának önzáró mechanizmusát a keresztartón lévő rugó biztosítja. Ez megkönnyíti a lehúzó pozicionálását és zárását a lehúzendó alkatrészen. A lehúzó pozicionálása után a körmöket a gyűrűsanyával rögzíthetjük.

Az egyedi keresztartón elhelyezkedő négy fészeknek köszönhetően a 1517C csapágylehúzó könnyebb, gyorsabb munkákhoz kétkörmös illetve erősebb fogást kívánó munkákhoz háromkörmös változatban is használható.

A csavarfejen lévő biztonsági csapszeg a megengedett legnagyobb nyomaték túllépése esetén eltörik, így védve a lehúzót a túlterheléstől.



1517C/...

két-/háromkörmös önzáró csapágylehúzó

- két- és háromkörmös használatra
- önzáró



	L mm	L1 mm	Ft		
1517C/0	145	250	105.300	1	015170500
1517C/1	200	300	129.100	1	015170501
1517C/2	270	300	160.300	1	015170502

	A min+max mm	● mm
1517C/0	12÷140	18
1517C/1	20÷180	18
1517C/2	30÷280	18

1518/...

Háromkörmös csapágylehúzó, galvanizált



	L mm	Ft		
1518/1	105	38.450	1	015180001
1518/2	135	49.200	1	015180002
1518/3	235	87.050	1	015180003
1518/4	270	129.600	1	015180004
1518/5	270	152.200	1	015180005
1518/6	270	159.500	1	015180006

	A min+Max mm	L1 mm
1518/1	24÷100	105
1518/2	32÷160	150
1518/3	40÷220	220
1518/4	80÷250	240
1518/5	80÷300	350
1518/6	80÷350	400



1518U/...

háromkörmös univerzális csapáglehúzó

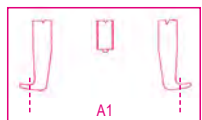
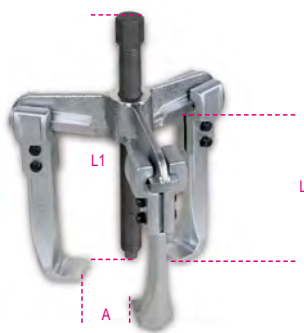

	L mm	L1 mm	Ft		
1518U/0	100	166	72.650	1	015180500
1518U/1	100	166	77.750	1	015180501
1518U/2	150	247	118.200	1	015180502
1518U/3	150	247	123.500	1	015180503
1518U/4	200	321	178.100	1	015180504

	A min+Max mm	A1 min+Max mm	● mm
1518U/0	40÷90	80÷130	17
1518U/1	50÷130	90÷170	17
1518U/2	65÷150	115÷210	22
1518U/3	65÷190	125÷260	22
1518U/4	70÷235	170÷335	27

1519/...

háromkörmös univerzális csapáglehúzó
gyorsan állítható és zárható

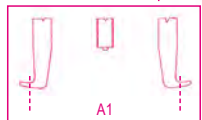
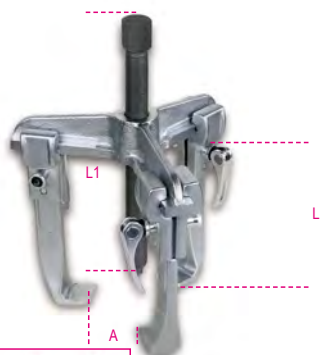

	L mm	L1 mm	Ft		
1519/0	100	166	83.800	1	015190000
1519/1	100	166	88.850	1	015190001
1519/2	150	247	127.100	1	015190002
1519/3	150	247	134.400	1	015190003

	A min+Max mm	A1 min+Max mm	● mm
1519/0	40÷90	80÷130	17
1519/1	50÷130	90÷170	17
1519/2	65÷150	115÷210	22
1519/3	65÷190	125÷260	22

1520/1 - 1520/2

Átfordítható, kétkörmös
csapáglehúzó, galvanizált



	L mm	Ft		
1520/1	135	36.450	1	015200101
1520/2	235	62.350	1	015200102

	A Max mm	L1 mm
1520/1	110	85
1520/2	160	140

1521/1 - 1521/2

Átfordítható, háromkörmös
csapáglehúzó, galvanizált



	L mm	Ft		
1521/1	135	47.150	1	015210101
1521/2	235	83.000	1	015210102

	A Max mm	L1 mm
1521/1	110	90
1521/2	160	140

1528

önzáró féktárcsa
lehúzó



Ø 19 mm

	A min+Max mm	Ft		
1528	170÷380	84.200	1	015280000

480x240x60 mm - 4,8 kg

1529

Ékszíjtárcsalehúzó készlet



	A min+Max mm	L min+Max mm	L1 min+Max mm	Ft		
1529	24÷240	60÷95	90÷135	123.500	1	015290000

260x210x60 mm - 2,6 kg

1529PI

univerzális befecskendező szivattyú szíjtárcsa
lehúzó

- lehetővé teszi az üzemanyag befecskendező szivattyú szíjtárcsa gyors és pontos kiszérelését.
 - különösen a Fiat, Ford, Volkswagen, Citroen és Peugeot gyártmányokhoz javasolt
- 3 csavarpárt tartalmaz a lehúzóknak a szíjtárcsához történő rögzítéséhez:
M6 x 1.0 x 49 mm
M7 x 1.0 x 75 mm
M8 x 1.25 x 76 mm



	Ft		
1529PI	51.400	1	015290051

1530/C5

Kerékagy lehúzó készlet
3, 4, 5 körmös

- Szerszámkészlet tartalmaz:
1 Univerzális karima 96÷138 mm
1 Hidraulikus működtetésű lehúzóengely 12 t
1 2,8 kg-os lendítő kerék, ne legyen feszítő csapszeg a kerékagy közepén



	Ft		
1530/C5	259.500	1	015300300

760x320x120 mm - 11,5 kg

1531/C7

kerékcsapágy belső gyűrű levezető készlet

méretek:

- 1 fogó Ø 40÷45 mm
- 1 fogó Ø 45÷51 mm
- 1 fogó Ø 50÷55 mm
- 1 fogó Ø 55÷61 mm



1531/C7 Ft 351.000 1 015310107

390x315x96 mm - 4,3 kg

1532

Tömítésleszedő szerszám



1532 Ft 8.140 2 015320001

1533/...

Lehúzókegyl a szétválasztóhoz (1534), galvanizált



	L mm	Ft		
1533/2	150	53.050	1	015330002
1533/3	210	100.800	1	015330003
1533/4	315	159.900	1	015330004
1533/5A	305	193.100	1	015330006

	A min=Max mm	L1 mm		
1533/2	45÷140	110		
1533/3	55÷205	175		
1533/4	90÷260	175		
1533/5A	100÷360	235		

1533PR/1 - 2 - 3

Toldal a levezetőkegylhez (1533), barnított



	Ft		
1533PR/1	11.550	1	015330011
1533/2			
1533PR/2	12.550	1	015330012
1533/3			
1533PR/3	13.150	1	015330013
1533/4 - 1533/5A			

1534/...

Szétválasztó, galvanizált

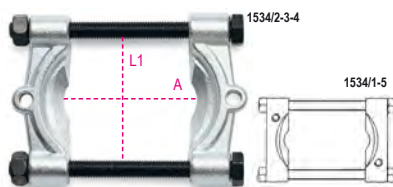

		Ft		
1534/1	1533/2	46.150	1	015340001
1534/2	1533/2	54.650	1	015340002
1534/3	1533/3	90.700	1	015340003
1534/4	1533/4	152.200	1	015340004
1534/5A	1533/5A	313.400	1	015340006

	A min=Max mm	L1 mm		
1534/1	5÷60	63		
1534/2	12÷75	75		
1534/3	22÷115	118		
1534/4	25÷155	154		
1534/5A	30÷220	180		

1535/C...

Levezető készlet, fémdobozban



1535/C1 Ft 148.200 1 015350001

- 1533/2
- 1533PR/1
- 1534/1

260x180x40 mm - 2,5 kg

1535/C2 Ft 156.700 1 015350002

- 1533/2
- 1533PR/1
- 1534/2

260x180x40 mm - 2,8 kg

1535/C3 Ft 256.700 1 015350003

- 1533/3
- 1533PR/2
- 1534/3

380x280x55 mm - 8,0 kg

1535/C4 Ft 396.400 1 015350004

- 1533/4
- 1533PR/3
- 1534/4

420x380x65 mm - 14,8 kg

1535/C5A Ft 599.400 1 015350006

- 1533/5A
- 1533PR/5A
- 1534/5A

530x510x85 mm - 27,2 kg

1539

Lemezcsúszató kalapács, krómozott



1539 Ft 80.550 1 015390001

1540

Levezetőkalapács, galvanizált

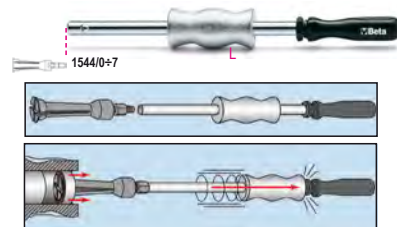

1540 L mm 390 1544 M10 0÷7 Ft 45.150 1 015400001

1542/1 - 1542/2

Ellentartó belső csapágylevezetőkhöz galvanizált



	A min=Max mm	1544	Ft	
1542/1	35÷75	0÷7	39.050	1 015420001
1542/2	60÷130	9C-10C	58.500	1 015420002

	L mm	L1 mm
1542/1	140	140
1542/2	175	160



1544/...

Kétkörmös belső csapáglehúzó, barnított

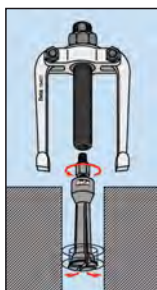

	C mm	M	Ft	1	015440100
1544/0 A= 5÷7	0,25	M10	34.200	1	015440100
1544/A A= 7÷9	0,80	M10	35.600	1	015440105
1544/1 A= 9÷12	0,80	M10	36.450	1	015440110
1544/2 A= 13÷17	1,15	M10	37.450	1	015440120
1544/2B A= 14÷19	1,00	M10	38.250	1	015440121
1544/3 A= 16÷21	1,70	M10	39.450	1	015440130
1544/4 A= 20÷25	1,65	M10	43.700	1	015440140
1544/5 A= 25÷30	2,00	M10	46.750	1	015440150
1544/6 A= 30÷37	3,00	M10	58.500	1	015440160
1544/7 A= 38÷45	3,80	M10	66.400	1	015440170
1544/9C A= 40÷75	2,60	G 3/8"	96.150	1	015440189
1544/10C A= 70÷115	7,30	G 3/8"	132.800	1	015440199

1545/C5M

Belső csapáglehúzó készlet 1542/1 ellentartó 5 darab 1544 típusú belső lehúzóval, fémdobozban



1545/C5M	Ft	1	015450011
	260.700	1	015450011

1542/1	● 24 mm
1544/1	9÷12 mm
1544/2	13÷17 mm
1544/3	16÷21 mm
1544/4	20÷25 mm
1544/5	25÷30 mm
☞ 265x180x45 mm - 2,4 kg	

1547/C6

Csapáglehúzó sérült csapágyakhoz



1547/C6	Ft	1	015470006
	134.000	1	015470006
☞ 420x185x60 mm - 3 kg			

1547KP

3 darabos csapáglehúzó készlet



	∅ mm	Ft	1	015470106
1547KP/1	9-11-12,5	21.250	1	015470106
1547KP/2	5-6-8	14.750	1	015470206

1547P

Hatszögű toldók



	L mm	∅	Ft	1	015470101
1547P/1	205	1547/1	4.570	1	015470101
1547P/2	102	1547/2	2.910	1	015470201

1547PC/2

Toldók, kerek és rövid

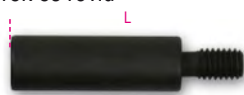

	L mm	∅	Ft	1	015470202
1547PC/2	42	1547/2	2.370	1	015470202

1547PL/2

Toldók, kerek és hosszú



	L mm	∅	Ft	1	015470203
1547PL/2	106	1547/2	2.630	1	015470203

1550U

pneumatikus lengéscillapító kiserelő eszköz gépjárművekhez, SUV modellekhez és haszonjárművekhez

CE

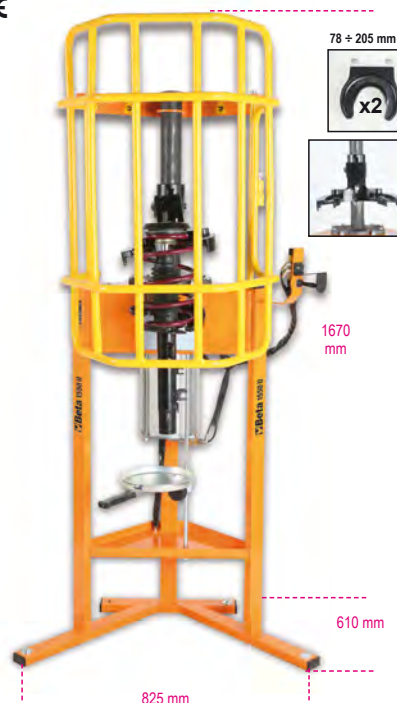

NAGYOBB TELJESÍTMÉNY: legnagyobb nyomóteljesítmény 2 t (10 bár)
UNIVERZÁLIS FELSŐ FOGÓ RENDSZER: egy beállítható felső talp segítségével lehetővé teszi az akár jobbmertes, akár balmertes összes rugóátmérő összenyomását
AKTÍV RUGÓBIZTONSÁGI RENDSZER: a biztonsági horog és a 3 rögzítőszelap segítségével biztosított a rugó elhelyezése/illesztése, végig megtartva ezt a helyzetet az összenyomási művelet során.
 A rugó "nem megfelelő" elhelyezése esetén a rendszer leállítja a gépet.
"FULL BODY" VÉDŐRÁCS: a munkavégzési terület maximális biztonságát és védelmét biztosítja
MŰKÖDTETÉS VEZÉRLŐ KARRAL: nagyobb pontosság és érzékenység az összenyomási fázisban
MUNKAVÉGZÉSI HELYZET: munkavégzési magasság a hátsó kengyelen akár 875 mm-es magasságig

2 alsó kengyellel szállítva 78-205 mm átmérőhöz

MŰSZAKI ADATOK

Nyomóteljesítmény: 2 t (10 bár) - 1.6 t (8 bár) - 1.2 t (6 bár)
 Rugó összenyomás úthossza: 335 mm

1550U	Ft	1	015500010
	1.408.900	1	015500010

1550U/CGS-R

süllyesztett felső befogópofa pár a 1550U készülékhez



1550U/CGS-R Ft 270.900 1 015500035

1550U/MRC-ABE

különleges kengyel a 1550U eszközhöz egyedi kivitel a Mercedes A-B-E osztályokhoz



1550U/MRC-ABE Ft 279.400 1 015500031

1550U/MRC-C

különleges kengyel a 1550U eszközhöz egyedi kivitel a Mercedes C osztályhoz



1550U/MRC-C Ft 245.300 1 015500032

1550U/S...

alsó kengyel az 1550U eszközhöz



	Ø mm	Ft		
1550U/S 130	78÷130 mm	177.700	1	015500014
1550U/S 182	105÷182 mm	177.700	1	015500015
1550U/S 205	125÷205 mm	177.700	1	015500016

1550U/SS187

balmenetes kengyel az 1550U eszközhöz

különösen az olyan bal profilú rugókhöz javasolt, mint a Nissan Qashqai és Renault Koleos típusok



1550U/SS 187 Ft 177.700 1 015500018

1550U/M

szorító satu az 1550U lengéscsillapító kiserelő eszközhöz lehetővé teszi a lengéscsillapító szár rögzítését



1550U/M Ft 168.800 1 015500021

1551/C20

toronycsapágy szerelőkészlet

Készlet tartalma:

- 7 hatlapú dugókulcs, méretek: 16 - 17 - 18 - 19 - 21 - 22 - 24
- 1 hosszabbító, hossz: 120 mm
- 3 belső nyílású bit, méretek: 8x5 - 8x6 - 11x8
- 1 belső imbusz bit, méret: 10 mm
- 1 XZN® bit, méret: M10
- 1 Torx® bit, méret: T50
- 4 imbusz bit, méret: 5 - 6 - 7 - 8
- 1 bittartó hosszabbító, hossz: 95 mm
- 1 bittartó hosszabbító, hossz: 190 mm



○ 8 - 21 mm

1551/C20 Ft 74.300 1 015510020

320x245x71 mm - 2,6 kg

1552/C9

készlet lengéscsillapító, lengőkar gömbfej és kormány csukló foglalat szétválasztásához

az egyes vagy kettős visszahúzófej (pl. a VAG csoportnál használt) kettős csuklókon is lehetővé teszi a munkát



○ 13 mm

1552/C9 Ft 59.100 1 015520020

195x140x40 mm - 1,0 kg



1555/Q

Rugóösszehúzó Mac-Pherson-hoz.

Nyomóerő: 1500 kg

CE □ 1/2

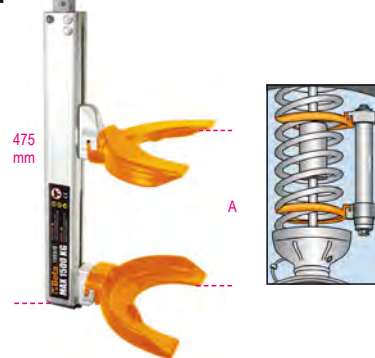

A min+Max mm	Ø min+Max mm	Ft		
65÷354	80÷195	384.600	1	015550006

1555/QS

Rugóösszehúzó Mac-Pherson-hoz

CE □



A min+Max mm	Ø min+Max mm	Ft		
70÷300	80÷200	473.700	1	015550005

1555S/BMW-RNT

Tányérok a rugóösszehúzóhoz BMW E39, E46 és Renault Mégane II 1555DS-hez és 1555/QS-hez



1555S/BMW-RNT Ft 148.600 1 015550303

1556/1A

Lengéscsillapító rugóösszehúzó

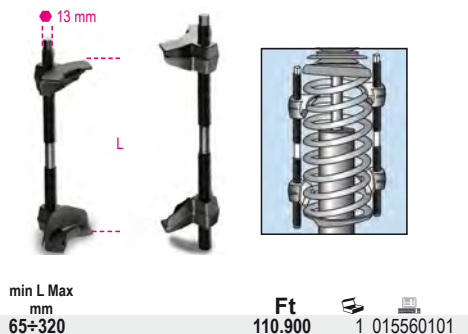

1558P

seegergyűrű hegypár a 1558 eszközhöz

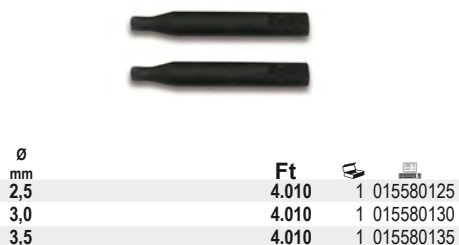

1558/C13

Belső és külső seeger gyűrűkhöz használható szerszámkészlet, csavaros működéssel

A négyzög csatlakozónak köszönhetően mindkét használati módban nagy erő fejthető ki

szállított hegyek:

- egyenes: Ø 2,5 - 3 - 3,5 - 3,8 mm
- 45°: Ø 2,5 - 3 - 3,5 - 3,8 mm
- 90°: Ø 2,5 - 3 - 3,5 - 3,8 mm



1559

Könnyített gömbfejlehúzó, galvanizált



	A Max mm	Ø mm	Ft	1	015590001
1559/22	50	18÷22	40.900	1	015590001
1559/36	90	36	188.300	1	015590036
1559/45	115	45	282.200	1	015590045

1559V/8T

Hidraulikus orsó a 1559/36 és az 1559/45 típusú gömbfejlehúzóhoz

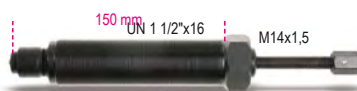

Nm	t	Ft	1	015590145
80000	8	142.500	1	015590145

1560/2

Gömbfejlehúzó, professzionális, galvanizált

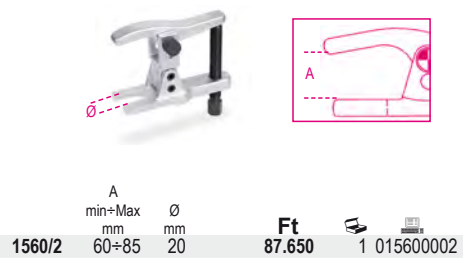

1560A

Gömbfejlehúzó, galvanizált

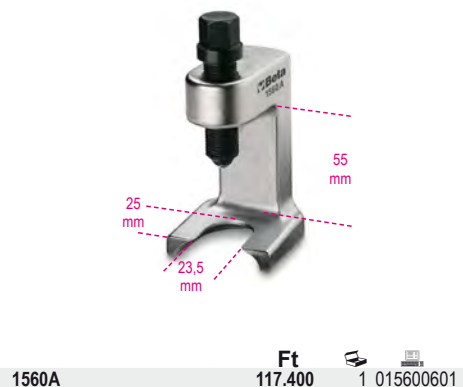

1561/...

Gömbfejlehúzó, galvanizált

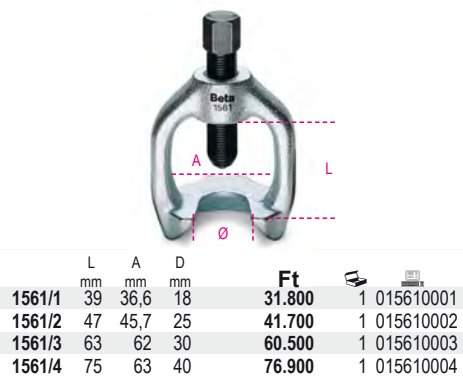

1562D

Gömbfejlehúzó

Alkalmos kormány gömbfej leszereléséhez 2 orsó és csavar segítségével



1556/2A

Lengéscsillapító rugóösszehúzó

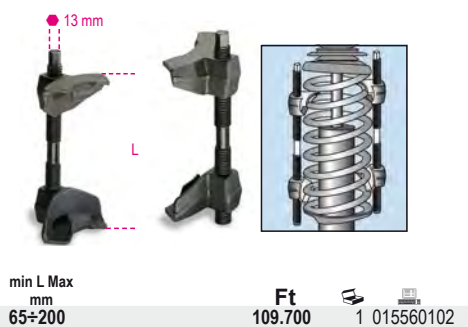

1557/S3

3 részes lengéscsillapító szerelő készlet, krómozott



1558/C4

belső és külső seeger gyűrűkhöz használható szerszám csavaros működéssel

a négyzög csatlakozónak köszönhetően mindkét használati módban nagy erőt alkalmazás történik Szállított hegyek: Ø 2,5-3-3,5 mm



1565/1 - 2 - 3

Gömbfejszerelő villa, galvanizált



	D mm	L1 mm	Ft		
1565/1	18	65	36.250	1	015650001
1565/2	23	65	40.900	1	015650002
1565/3	30	88	42.700	1	015650003

1566N

Célszerszám kormánykar szereléséhez



$\emptyset \times L$ mm	\emptyset mm	\square mm	Ft		
28÷35 x 400	27	12	57.900	1	015660005
35÷45 x 400	27	12	64.950	1	015660010

1566R

állítható célszerszám kormánykar szereléséhez



\emptyset mm	Ft		
27÷43	11.150	1	015660015

1566/G01

homokinetikus csukló lehúzó

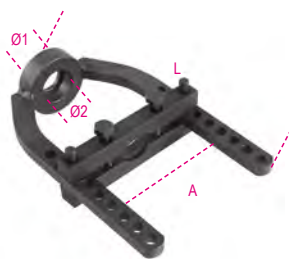

L mm	A mm	Ø1 mm	Ø2 mm	Ft		
250	115	29	36	69.000	1	015660052

1566/VAG

XZN® gépi dugókulcs készlet
VAG-csoporthoz tartozó járművek féltengely
csavarjaihoz

A készletben foglalt méretek:
• XZN® M12 L 77 mm gépi dugókulcs
• XZN® M12 L 120 mm gépi dugókulcs



\emptyset	L1	L2	Ft		
M12	77	120	19.550	1	015660060

1567

lengőkar gömbfejet és lengéscsillapítót a
toronyról lehúzó kar

A szerelő egyedül használhatja



A mm	B min÷Max mm	Ft		
1060	100÷300	158.700	1	015670001

1568

sűrített levegős
szilikon féltengely-gumiharang tágitó
8 tágitókar
maximális tágitás: 145 mm



L mm	L1 mm	Ft		
420	195	113.000	1	015680001

1569/F

szerszámkészlet Fiat Panda, Fiat 500 és Ford
Ka szilentblokkok lehúzásához és
behelyezéséhez



1569/F	Ft		
	208.900	1	015690021

1569/SB

szerszámkészlet a hátsó tengely szilentblokk,
a forgattyústengely és
kerékcspagy tömítésének szereléséhez

• a perselyek közvetlenül használhatók mind a járműhöz mind
a hidraulikus préshoz is
Pos. \emptyset mm H mm



1569/SB	Ft		
	117.000	1	015690016
☞ 425x365x100 mm - 13 kg			

1569CP

beütős beillesztő
kúpos csapágyakhoz és olajvédőkhöz

gyors beállítás



	\emptyset min÷Max mm	L mm	Ft		
1569CP/50	9,5÷50	130	61.950	1	015690750
1569CP/90	18÷90	145	76.900	1	015690790

1570/3

Hidraulikus prés



t	L mm	L1 mm	mm	Ft		
30	243	36	19	114.200	1	015700003

1580/8I

Kétkörmös csapáglehúzó hidraulikus rásegítéssel, galvanizált

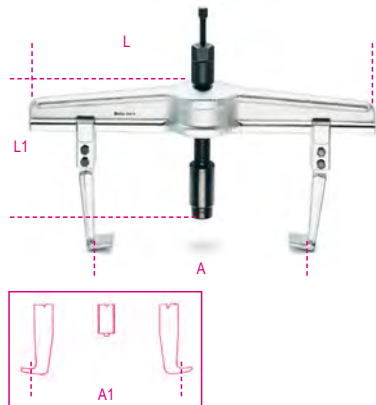

1580/8I	Ft		
	730.800	1	015800008

	A min+Max mm	L mm	L1 mm	A1 min+Max mm	N Max
1580/8I	170÷640	715	280	260÷715	180000

1580GL

Lehúzó karok, hosszú kivitel, 1580/8I-hez



	L mm	Ft		
1580GL/8A	300	82.400	1	015800227
1580GL/8B	400	91.700	1	015800228
1580GL/8C	500	117.000	1	015800229

1585/5I - 6I - 7I

Háromkörmös csapáglehúzó hidraulikus rásegítéssel, galvanizált

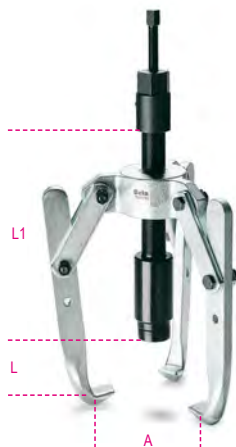

	Ft		
1585/5I	508.100	1	015850005
1585/6I	534.400	1	015850006
1585/7I	550.600	1	015850007

	A min+Max mm	L1 mm	L mm	N Max
1585/5I	50÷350	135	280	150000
1585/6I	50÷350	235	280	150000
1585/7I	50÷350	335	280	150000

1585GI/5 - 6 - 7

Körök az 1585I típusú csapáglehúzóhoz, galvanizált

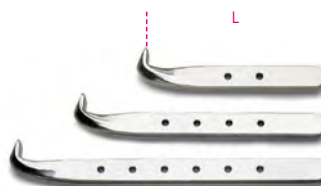

	L mm	Ft		
1585GI/5	135	46.150	1	015850205
1585GI/6	235	54.650	1	015850206
1585GI/7	335	66.200	1	015850207

1589VI

Hidraulikus lehúzótengegy, barnított

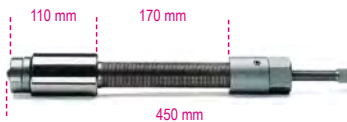

1589VI	Ft		
	299.200	1	015890001

1589PI/50 - 100 - 150

Toldat a hidraulikus lehúzó tengegyhez



	L mm	L1 mm	Ft		
1589PI/50	50	70	27.100	1	015890005
1589PI/100	100	120	29.750	1	015890010
1589PI/150	150	170	32.600	1	015890015

1590

Univerzális párhuzamszorító, horganyzott



A max mm	L1 mm	Ft		
60	55	12.550	2	015900305
100	65	20.050	2	015900310
150	95	33.200	2	015900315

1591

Párhuzamszorító, horganyzott



A ~	A max mm	L1 mm	Ft		
200	200	80	13.150	2	015910020
300	310	85	16.000	2	015910030
400	410	85	17.400	2	015910040
500	500	95	23.500	2	015910050
600	600	95	23.900	2	015910060
800	800	95	28.950	2	015910080
1000	1000	110	36.250	2	015910100

1593

Gyors párhuzamszorító, horganyzott

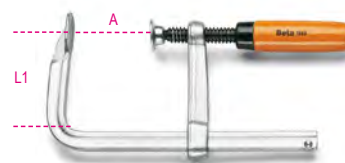

A ~	A max mm	L1 mm	Ft		
160	170	80	15.600	2	015930016
200	240	100	23.900	2	015930020
300	320	145	33.400	2	015930030

1594

Emeltyűs gyors párhuzamszorító, horganyzott

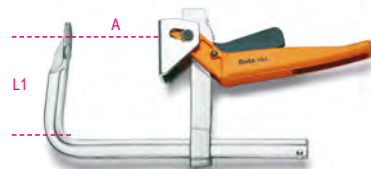

A ~	A max mm	L1 mm	Ft		
200	240	145	51.800	1	015940020
250	290	145	53.850	1	015940025
300	340	145	57.700	1	015940030
400	430	150	60.300	1	015940040
500	530	150	63.550	1	015940050
600	630	150	66.600	1	015940060



1595

Gyors párhuzamszorító, horganyzott

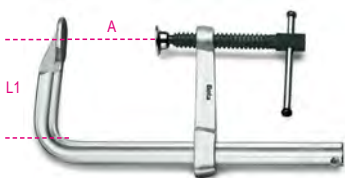

A	A max	L	Ft		
mm	mm	mm			
200	230	100	24.700	2	015950020
250	270	120	26.900	2	015950025
300	330	120	34.200	2	015950030
400	420	120	38.450	2	015950040
500	520	125	41.900	2	015950050
600	620	125	44.350	2	015950060
800	820	125	52.650	1	015950080
1000	1030	125	58.300	1	015950100

1599F

kovácsolt párhuzamsatu munkapadhoz

Acélöntésű. Mart és edzett pófák. Elülső nyílás. Nagy befogási mélység.



L1	BxH	Ø	A MAX	Ft		
mm	mm	mm	mm			
100	92x46	11	125	153.800	1	015990100
125	108x54	13	150	196.400	1	015990125
150	125x62	13	200	275.700	1	015990150
175	140x70	15	220	376.500	1	015990175

1599GI

párhuzamsatu cserélhető pófákkal

- négyzögletes vezetőlappal a nagy igénybevételt jelentő munkákhoz
- cserélhető szorítófóák keményített felülettel



L1	BxH	Ø	A MAX	Ft		
mm	mm	mm	mm			
100	92x46	11	125	118.600	1	015990200
125	108x54	13	150	163.200	1	015990225
150	125x62	13	200	222.700	1	015990250
175	140x70	15	220	297.200	1	015990275

1599GR

szorítófópár és tartaléksavar a 1599GI satuhoz



	A	Ft		
	mm			
1599GR 100	100	11.350	1	015990920
1599GR 125	125	14.150	1	015990925
1599GR 150	150	17.400	1	015990950
1599GR 175	175	20.250	1	015990975

1599P

párhuzamsatu munkapadhoz

Edzett pófák. Lakkozott üllő. Négyzögletes acél alap.

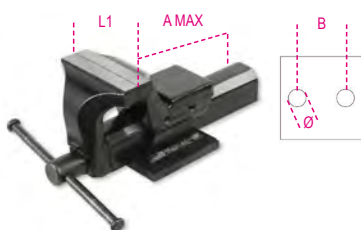

L1	B	Ø	A MAX	Ft		
mm	mm	mm	mm			
100	92	11	111	134.800	1	015990000
125	108	13	130	161.900	1	015990025
150	130	15	170	225.900	1	015990050

1599B

Forgóalapp a 1599P satuhoz



	1599P	Ft		
1599B 100	100	56.250	1	015990810
1599B 125	125	64.150	1	015990812
1599B 150	150	79.350	1	015990815

1599T

gépsatu

Speciális öntöttvas satu edzett és csiszolt pófákkal. Kis és közepes, oszlopos fűrőgépekhez.

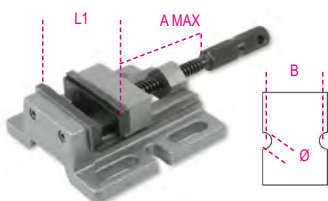

L1	B	Ø	A MAX	Ft		
mm	mm	mm	mm			
80	111	11	65	76.100	1	015990480
100	120	13	87	94.350	1	015990500

1599G

Szorítófópár alumíniumból

- Teljes hosszában mágneses
- Belső marással a menetes részek stabil rögzítésére

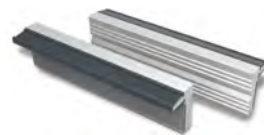

A	Ft		
mm			
100	24.700	1	015990910
125	25.700	1	015990912
150	28.150	1	015990915
180	31.150	1	015990917

1600Q 8

négyágú keresztkulcs (kapcsolószekrényekhez)

négyzög 5 / 6 / 7-8 mm
háromszög 7/9 mm
szárnyas kulcs 3-5 mm
hatszög 1/4"
hasítottfejű 1.0x7 mm + keresztfejű PH2

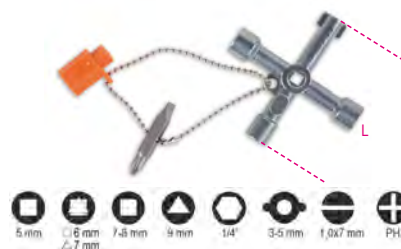

L	Ft		
mm			
76	13.750	1	016000008

1600Q 10

nyolcágú csuklós csavarkulcs, vezérlőpanel kezelőknek

négyzög 5 / 6-7 / 8-9 mm
háromszög 5-6-7 / 8-9 / 10 mm
szárnyas kulcs 3-5 mm
hatszög 1/4"
hajtószár 1/4"



L	Ft		
mm			
125	17.600	1	016000010

TANÚSÍTÁSI SZOLGÁLTATÁS MÉRŐMŰSZEREKHEZ

A mérőműszerek tanúsítása elengedhetetlen azokban az ágazatokban vagy alkalmazási területeken, ahol pontos, egyértelmű és felismerhető mérésekre van szükség. A tanúsítás magában foglalja az Accredia tanúsítvány kiadását:

A Beta Utensili S.p.A. kérésre vállalja a tolómérők, digitális tolómérők, mérőórák, mikrométerek és mérőidomok tanúsítását. A szolgáltatás igénybevételéhez keresse márkakereskedésünket.



1650

Tolómérő acélból, tokban, pontosság 0.05 mm

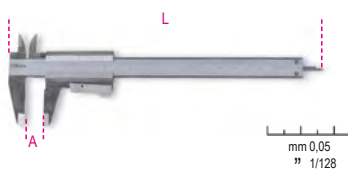

UNI EN ISO 13385-1DIN 862

A max mm	L mm	Ft	📦	💻
150	235	28.750	1	016500001
200	290	37.850	1	016500002

1650FD

Tolómérő féktárcsához, rozsdamentes acélból, pontosság 0.1 mm

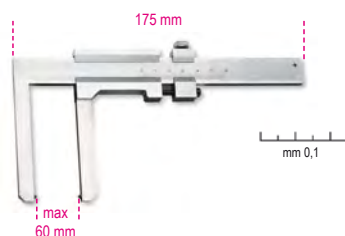

1650FD	Ft	📦	💻
	102.000	1	016500050

1651DGTB

digitális tolómérő, pontosság: 0,01 mm

Jellemzők:

- pontosság: 0,01 mm
- csúszerész csavarral állítható
- mm/coll megjelenítés
- bármely helyzetben nullázható
- 300 mm-ig kihúzható négyzetleges mélységmérő rúd
- kemény műanyag dobozban

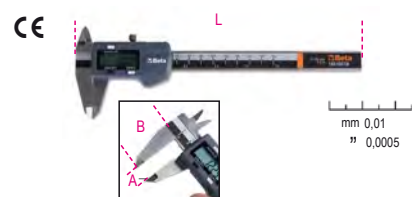

UNI EN ISO 13385-1DIN 862CE

A Max mm	L mm	B mm	Ft	📦	💻
150	235	40	48.600	1	016510211
200	285	50	63.150	1	016510212
300	400	60	82.600	1	016510213



1651DGTB/IP

digitális tolómérő, pontosság: 0,01 mm, IP67 védelem

- pontosság: 0,01 mm
- csúszerész csavarral állítható
- mm/coll megjelenítés
- csúsztatásra automatikusan bekapcsol
- bármely helyzetben nullázható
- HOLD funkció
- abszolút és inkrementális mérés

Az IP67 védelmi fokozat garantálja a teljes védelmet a por és a folyadékok ellen, vízhatlan

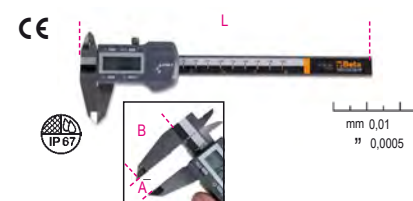

UNI EN ISO 13385-1 DIN 862CE

A Max mm	L mm	B mm	Ft	📦	💻
150	235	40	79.350	1	016510711

📏 270x115x35 mm - 📦 450 g

1652

Órák tolómérő nemesített acélból kemény műanyag dobozban, pontosság 0.02 mm



UNI EN ISO 13385-1DIN 862

1652	Ft	📦	💻
	60.700	1	016520016

1654

Tolómérő rozsdamentes acélból, tokban, pontosság 0.02 mm



UNI EN ISO 13385-1DIN 862

A max mm	L mm	Ft	📦	💻
200	330	133.200	1	016540020
300	410	181.000	1	016540030



1654DGT

Digitális tolómérő
Pontosság: 1/100 mm

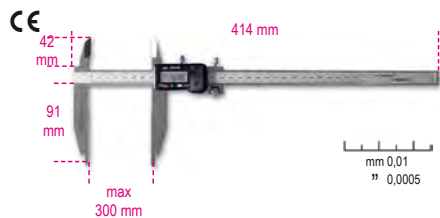

UNI EN ISO 13385-1DIN 862CE

1654DGT Ft 305.300 1 016540111

1656

Mélységmérő rozsdamentes acélból,
tokban, pontosság 0.02 mm



UNI EN ISO 13385-2DIN 862

A max mm	L mm	Ft	1	016560020
200	260	63.150	1	016560020
300	360	92.900	1	016560030

1657DGT/2

Digitális mélységmérő rozsdamentes
acélból, fadobozban,
pontosság: 0.01 mm

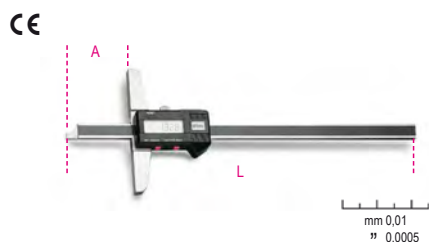

UNI EN ISO 13385-2DIN 862CE

1657DGT/2 Ft 117.400 1 016570002



1658/...

Mikrométer kemény műanyag
dobozban, pontosság 0.01 mm



DIN 863/II

A mm	Ft	1	016580025
1658/25 0÷25	36.250	1	016580025
1658/50 25÷50	39.450	1	016580050
1658/75 50÷75	44.550	1	016580075
1658/100 75÷100	48.800	1	016580100

1658/C4

4-részes mikrométer készlet,
fadobozban



DIN 863

1658/C4 Ft 146.200 1 016580001

1658/25	0÷25 mm
1658/50	25÷50 mm
1658/75	50÷75 mm
1658/100	75÷100 mm
365x245x35 mm - 2,5 kg	

1658DGTB

Digitális külső mikrométer, IP65, pontosság:
0,001 mm

- pontosság: 0,001 mm
- edzett acél mérőfelület
- csúszórész rögzítőkarral állítható
- mm/coill megjelenítés
- bármely helyzetben nullázható
- abszolút és inkrementális mérés
- kalibrálókulccsal szállítva



DIN 863CE

1658DGTB 25 Ft 99.200 1 016580525
1658DGTB 50 123.500 1 016580550

1658SP/1

Mikrométer-állvány



1658SP/1 Ft 25.100 1 016580910

1659

Mérőórás vastagsgmérő,
pontosság 0.01 mm

C = mérési tartomány



1659 C mm Ft 93.300 1 016590001

1662/1 - 1662/2

Mérőóra, kemény műanyag
dobozban, pontosság 0.01 mm
C = mérési tartomány



DIN 878

1662/1 C mm Ft 42.700 1 016620001
1662/2 0÷10 52.000 1 016620010

1662DGT/A

digitális mérőóra
század pontosságú mérés
C = Mérés tartomány



1662DGT/A C mm Ft 129.600 1 016620311

1662AN

Mérőóra tapintóval
Pontosság: 1/100 mm

C=Mérési tartomány



DIN 2270

	C mm	Ft		
1662AN	0÷0,8	101.000	1	016620200

1662SPO

Állítható mágneses állvány



	Ft		
1662SPO	36.050	1	016620800

1662SP2

Állítható mágneses állvány



	Ft		
1662SP2	65.200	1	016620910

1666

Precíziós derékszög rozsdamentes acélból, köszörült és tükrösített



DIN 875/0

L mm	L1 mm	Ft		
100	70	29.550	1	016660210
150	100	42.900	1	016660215
200	130	51.400	1	016660220
250	165	66.600	1	016660225
300	200	84.000	1	016660230

1666A

Talpas precíziós derékszög rozsdamentes acélból, köszörült és tükrösített



DIN 875/0

L mm	L1 mm	Ft		
100	70	43.500	1	016660110
150	100	58.700	1	016660115
200	130	82.800	1	016660120
250	170	102.800	1	016660125
300	200	130.000	1	016660130

1668

talpas precíziós derékszög normalizált acélból köszörült



DIN 875/2

L mm	L1 mm	Ft		
100	70	13.150	2	016680210
150	100	17.400	2	016680215
200	130	22.650	2	016680220
250	165	33.000	1	016680225
300	174	40.500	1	016680230

1668A

Talpas precíziós derékszög normalizált acélból, köszörült



DIN 875/2

L mm	L1 mm	Ft		
100	70	15.600	2	016680110
150	100	24.100	2	016680115
200	130	30.550	2	016680120
250	165	43.900	1	016680125
300	176	52.400	1	016680130

1670

Precíziós derékszög acélból, köszörült



L mm	L1 mm	Ft		
100	70	8.140	3	016700010
150	100	8.500	3	016700015
200	130	9.550	3	016700020
250	160	10.500	3	016700025
300	175	11.550	3	016700030
400	230	17.200	2	016700040
500	280	19.250	2	016700050
600	330	20.250	2	016700060
800	395	27.550	1	016700080
1000	500	33.000	1	016700099

1670A

Talpas precíziós derékszög acélból, köszörült



L mm	L1 mm	Ft		
100	70	10.700	3	016700110
150	100	11.550	3	016700115
200	130	12.550	3	016700120
250	165	15.200	3	016700125
300	175	17.800	3	016700130
400	230	23.500	2	016700140
500	280	31.150	2	016700150
600	330	35.000	2	016700160
800	420	41.500	1	016700180
1000	500	51.400	1	016700199

1672

Állítható szögsablon csúszo szárral, a szár és az alaplap acélból készült, krómozott

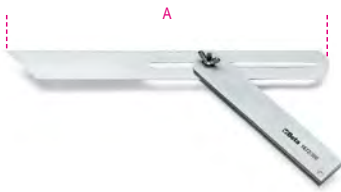

A mm	Ft	db	gép
300	24.900	2	016720030

1672A

Állítható szögsablon csúszo szárral a szár krómozott acélból, az alaplap alumíniumból készült

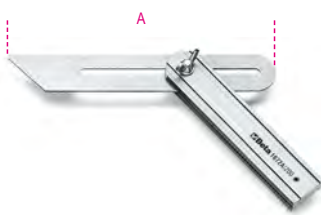

A mm	Ft	db	gép
200	12.950	3	016720120
300	14.150	3	016720130

1674A

Asztalos derékszög, a szár acélból, az alaplap alumíniumból készült



L mm	L1 mm	Ft	db	gép
300	169	12.350	2	016740130
400	214	15.400	2	016740140

1674C

Asztalos derékszög acélból, vízmértékkel

- Kettős mm skála
- Vízmérték

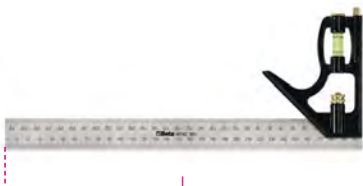

L mm	Ft	db	gép
300	8.950	2	016740230

1676

Szögmérő, rozsdamentes acélból

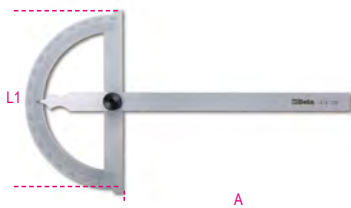

A	A mm	L1 mm	G mm	Ft	db	gép
120	120	80	1°	19.450	2	016760012
150	165	120	1°	22.250	2	016760015
200	210	150	1°	26.900	2	016760020
300	310	200	1°	36.250	1	016760030

1678/C3

Dőlésszögmérő, rozsdamentes acélból, kemény dobozban



1678/C3	L Max mm	D mm	Ft	db	gép
	300	70	138.100	1	016780030

1679

Univerzális görgős mérőeszköz, rozsdamentes acélból, pontosság 0.1 mm

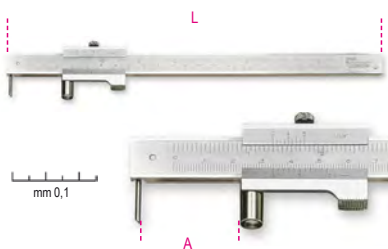

L mm	A Max mm	Ft	db	gép
235	200	41.700	1	016790020

1679/PR

cserhegy a 1679 tolómérőhöz



1679/PR	Ft	db	gép
	6.720	1	016790021

1680

Jelölő körző, edzett acélest és hegyek

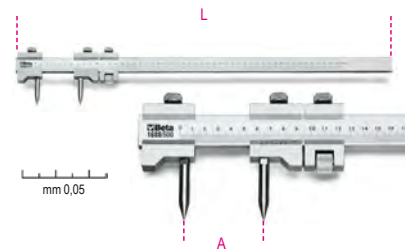

L mm	A Max mm	Ft	db	gép
660	500	138.100	1	016800050

1680A

Belső jelölő körző, edzett acélhegyek

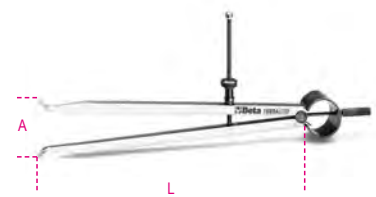

L mm	A Max mm	Ft	db	gép
150	144	8.990	2	016800115
200	200	11.150	2	016800120
250	245	13.550	1	016800125
300	300	15.600	1	016800130

1680B

Külső jelölő körző, edzett acélhegyek



L mm	A Max mm	Ft	db	gép
150	155	8.990	2	016800215
200	190	11.150	2	016800220
250	235	13.550	1	016800225
300	280	15.600	1	016800230

1680C

Precíziós jelölő körző, egyenes edzett acélhegyek



L mm	A Max mm	Ft	db	gép
150	138	8.990	2	016800315
200	190	11.150	2	016800320
250	235	13.550	1	016800325
300	280	15.600	1	016800330

1682

Rugalmas skálás vonalzó,
rozsdamentes acélból



L mm	H mm	\pm mm	Ft		
150	13	0,5	1.480	5	016820015
200	13	0,5	1.580	5	016820020
250	13	0,5	1.980	5	016820025
300	13	0,5	2.450	5	016820030
500	13	0,5	5.510	2	016820050
1000	13	0,5	14.550	2	016820100

1683

Félmerev skálás vonalzó,
rozsdamentes acélból

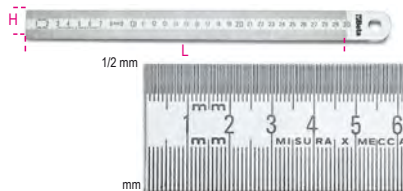

L mm	H mm	\pm mm	Ft		
300	30	1	4.330	5	016830030
500	30	1	7.250	2	016830050
1000	30	1	18.200	2	016830100
1500	30	1	40.700	1	016830150

1685/C7

7-részes mérő- és jelölő készlet



1685/C7	Ft		
	140.000	1	016850110

	1650	160 mm
	1658/25	0÷25 mm
	1670	100 mm
	1680C	150 mm
	1682	150 mm
	1688BC	165 mm
	1688BC/R	
320x210x37 mm - 1,2 kg		

1687A

90°-ban hajlított rajztű



1687A	L mm	L1 mm	Ft		
	153	80	3.060	1	016870120

1687AC

Rövid 45°-ban hajlított rajztű



1687AC	L mm	L1 mm	Ft		
	153	80	3.060	1	016870125

1687D

Egyenes rajztű



1687D	L mm	L1 mm	Ft		
	153	80	3.060	1	016870110

1687U

Hajlított rajztű



1687U	L mm	L1 mm	Ft		
	153	80	3.060	1	016870115

1687/S4

4 darabos rajztű készlet



1687/S4	Ft		
1687A-1687AC 1687D-1687U	12.200	1	016870150

1688

Rajztű, edzett acélból

1688	L mm	\emptyset mm	Ft		
	250	2	4.010	5	016880020

1688A

Rajztű, edzett acélból

1688A	L mm	\emptyset mm	Ft		
	200	4	7.250	5	016880120

1688PC

rajztű
edzett acél, krómozott

1688PC	L mm	\emptyset mm	Ft		
	150	1	17.200	1	016880300

1688PC/R

pótegy az 1688PC rajztűhöz

1688PC/R	Ft		
	5.020	1	016880310

1688M

Ácsceruza

1688M	L mm	Ft		
	180	525	50	016880880

1690F

Üvegszálás colstok
Pontossági osztály: III

1690F/2	L mm	S mm	Ft		
	2	17	5.790	5	016900220

1690L

Colstok nyírfából
Pontossági osztály: III

1690L/2	L mm	S mm	Ft		
	2	17	6.320	5	016900200

1691BM

mérőszalag
kétkomponensű, ütésálló ABS ház
acélszalag
II. pontossági osztály



	L m	S mm	Ft		
1691BM/5	5	25	7.570	1	016910205
1691BM/8	8	32	11.350	1	016910208
1691BM/10	10	32	13.750	1	016910210

1691MG

mágneses mérőszalag
ütésálló ABS ház,
acélszalag,
II. pontossági osztály



	L m	S mm	Ft		
1691MG/5	5	25	6.800	1	016910405
1691MG/8	8	25	9.510	1	016910408
1691MG/10	10	25	10.100	1	016910410

1692

Mérőszalag, ütésálló bimateriál ABS-ház,
acélszalag, pontossági osztály: II



	L m	S mm	Ft		
1692/2	2	16	3.680	5	016920052
1692/3	3	16	4.570	5	016920053
1692/5	5	19	6.560	5	016920055
1692/8	8	25	9.430	5	016920058

1693

lézeres távolságmérő,
20 m

MÉRÉSEK:

- egyedi távolságmérés
- folyamatos mérés vagy minimum mérés
- automatikus kikapcsolás
- elem üzemidő: akár 4 000 mérés



CE
IP54

MŰSZAKI ADATOK

Mérési tartomány: 0,05 ÷ 20m (0,2ft ÷ 66 ft)

Lépték: m, in, ft

Mérési pontosság: ±1,5 mm (± 0,06 in)

Lézerosztály: 2

Elemek: AAA 2 x 1,5V

	H mm	L mm	S mm	Ft		
1693 20	100	36	23	58.100	1	016930020

1693L

multifunkciós lézeres távolságmérő,
40 m,
pozicionáló szintekkel

MÉRÉSEK:

- egyedi távolságmérés
 - folyamatos mérés vagy minimum mérés
- FUNKCIÓK:
- összeadás/kivonás
 - területmérés
 - térfogatmérés
 - változók közvetett mérése (Pythagorasz mérés módszer)
 - dőlésmérés

automatikus kikapcsolás

elem üzemidő: akár 5 000 mérés

puha szövet tartóval szállítva



CE
IP54

Műszaki adatok:

• Mérési tartomány: 0.05 ÷ 40 m (0.2in ÷ 131ft)

• Lépték: m, in, ft

• Mérési pontosság: ±1,5 mm (± 0,06 in)

• Lézerosztály: 2

• Max. tárhely: 99 egység

• Elemek: AAA 2 x 1,5V

	H mm	L mm	S mm	Ft		
1693L 40	115	50	25	70.650	1	016930040

1693M

multifunkciós lézeres távolságmérő, 80m

MÉRÉSEK:

- egyedi távolságmérés
 - folyamatos mérés vagy minimum mérés
- FUNKCIÓK:
- összeadás/kivonás
 - területmérés
 - térfogatmérés
 - közvetett mérés (Pythagorasz mérés módszer)
 - dőlésmérés

Automatikus kikapcsolás

Puha szövet tartóval szállítva

Elem üzemidő: akár 4 000 mérés



CE
IP54

MŰSZAKI ADATOK

Mérési tartomány: 0,05 ÷ 80 m (0,2ft ÷ 229 ft)

Lépték: m, in, ft

Mérési pontosság: ±1,5 mm (± 0,06 in)

Lézerosztály: 2

Max. tárhely: 99 egység

Elemek: AAA 2 x 1,5V

	H mm	L mm	S mm	Ft		
1693M 80	115	48	29	98.600	1	016930080

1694/L

Mérőszalag, ütésálló ABS-ház,
PVC-borítású üvegszál szalag,
pontossági osztály: III

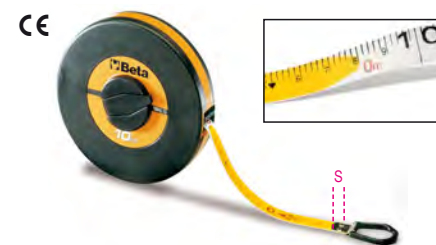

	L m	S mm	Ft		
1694L10	10	13	6.110	1	016940110
1694L20	20	13	7.570	1	016940120



1694A/L

Fogantyús mérőszalag,
ütésálló ABS-ház,
PVC borítású üvegszál szalag,
Pontossági osztály: III



	L m	S mm	Ft		
1694A/L30	30	13	15.200	1	016940230
1694A/L50	50	13	19.850	1	016940250

1694B/L

Fogantyús mérőszalag, alumínium ház,
lakkozott acélszalag,
pontossági osztály: II



	L m	S mm	Ft		
1694B/L50	50	12,5	30.350	1	016940350

1695XS

Zseb vízmérték V-formájú mérőfelülettel,
mágneses, profilozott alumínium
2 törésbiztos libella
Pontosság: 1 mm/m



L mm	H mm	S mm	Ft		
70	48,5	20	6.110	5	016950250

1696

Vízmérték eloxált alumíniumból,
2 törésbiztos libella,
pontosság: 1 mm/m



L mm	H mm	S mm	Ft		
200	50	19	10.300	2	016960002
400	50	19	11.750	2	016960004
500	50	19	12.950	2	016960005
600	50	19	13.750	2	016960006
800	50	19	17.200	2	016960008
1000	50	19	19.250	2	016960010

1696A

Vízmérték présöntött alumíniumból,
1 mérőfelület, 2 törésbiztos libellával,
pontosság: 1 mm/m



L mm	H mm	S mm	Ft		
300	43	23	14.750	2	016960103
400	43	23	15.600	2	016960104
500	43	23	17.000	2	016960105
600	43	23	18.400	2	016960106
1000	43	23	37.250	1	016960110

1696B

Mágneses vízmérték eloxált
alumíniumból, 2 törésbiztos libella,
pontosság: 1 mm/m



L mm	H mm	S mm	Ft		
200	49	22	15.800	2	016960202
300	49	22	16.400	2	016960203
400	49	22	17.400	2	016960204
500	49	22	21.250	2	016960205
600	49	22	22.250	2	016960206

1696D

Vízmérték présöntött alumíniumból
fogantyúval
4 finoman megmunkált mérőfelület és 3
törésbiztos libella
Pontosság: 1 mm/m



L mm	H mm	S mm	Ft		
300	47	25	13.750	2	016960353
400	47	25	15.600	2	016960354
500	47	25	17.000	2	016960355
600	47	25	19.250	2	016960356

1696S

Szintezőléc alumíniumból
2 törésbiztos libellával



L mm	H mm	S mm	Ft		
1500	90	25	48.800	1	016960415
2000	90	25	58.100	1	016960420
2500	90	25	72.450	1	016960425
3000	90	25	81.800	1	016960430

1696T

mágneses vízmérték,
profilozott alumíniumból,
3 törésbiztos libellával

- V-profilú alap
- pontosság: 0,5 mm/m
- függőleges libella ablakkal

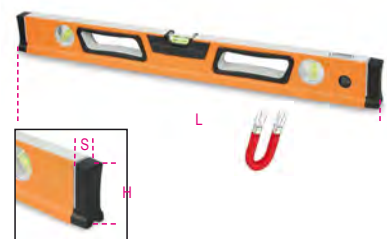

L mm	H mm	S mm	Ft		
600	66	28	35.600	2	016960506
800	66	28	39.650	2	016960508
1000	66	28	41.900	1	016960510
1200	66	28	52.000	1	016960512

1697

keresztlézeres szintező,
30 méter, zöld fényű,
mágneses talppal és fali konzollal,
tokban

MŰSZAKI ADATOK

- önbeálló kereszt
- kézi használathoz az önbeálló funkció kikapcsolható
- lézerdíóda 515 Nm, 2. lézerezstály
- hatósugár: 30 m
- pontosság: 5 m-en ± 1 mm
- önbeálló tartomány: $3^\circ \pm 0.5^\circ$

- ABS és csúszásmentes gumi test
- 1/4"-os csatlakozó
- 2xAA elem
- elem üzemidő: 4 óra

TALP:

- mágneses talp egyedi és kombinált felhasználásra, 1/4"-os csatlakozó
- az állítható rögzítőkonzollal különböző fa- és fémprofilokhoz rögzíthető (a mágneses talppal együtt alkalmazva)
- gyors, 90°-os vízszintes és függőleges beállítás

CE



IP55

H mm	L mm	S mm	Ft	1	016970030
82	57	89,5	120.600	1	016970030

320x230x90 mm

1699L

Precíziós vízmérték, vasöntvény,
köszörült prizmaalaplappal,
2 törésbiztos libella, fadobozban,
pontosság: 0.05 mm/m



DIN 877

1699L	L mm	A mm	Ft	1	016990002
1699L	200	49	146.200	1	016990002

1699L/1

Precíziós vízmérték kokillaöntvény,
köszörült prizmaalaplappal,
2 törésbiztos libella, fadobozban,
pontosság: 0.02 mm/m



DIN 877

1699L/1	L mm	A mm	Ft	1	016990005
1699L/1	200	49	155.500	1	016990005

1699Q

Precíziós keretes vízmérték,
vasöntvény, 2 prizmaalakú,
és 2 köszörült lapos alappal,
2 törésbiztos libella,
pontosság: 0.05 mm/m

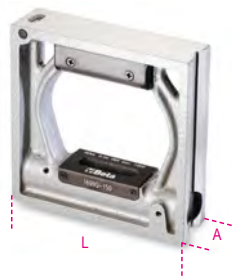

DIN 877

L mm	A mm	Ft	1	016990015
150	40	207.300	1	016990015
200	48	258.700	1	016990020

1700N

Hegyes véső



L mm	S mm	Ft	5	017000005
250	16	7.650	5	017000005
300	16	8.300	5	017000006

1700N/PM

Hegyes véső
kézvédővel



L mm	S mm	Ft	2	017000105
250	16	10.300	2	017000105
300	16	11.950	2	017000106

1701N

Laposvéső



L mm	A mm	S mm	Ft	5	017010001
250	23	16	8.260	5	017010001
300	23	16	8.870	5	017010003

1701N/PM

Laposvéső
kézvédővel



L mm	A mm	S mm	Ft	2	017010101
250	23	16	10.700	2	017010101
300	23	16	11.950	2	017010103

1701PMR

Tartalék kézvédő az 1700N-hez
és az 1701N-hez



D mm	L mm	Ft	1	017010206
16	115	4.940	1	017010206

1701NE/...

Villanszerelő laposvéső



1701NE3	SxL mm	Ft	5	017010406
1701NE3	10x200	5.060	5	017010406
1701NE4	10x250	5.380	5	017010409

1702N

Széles laposvéső



A mm	SxH mm	Ft	2	017020005
50	13x23	10.700	2	017020005
70	13x23	11.150	2	017020007

1702N/PM

Széles laposvéső
kézvédővel



A mm	SxH mm	Ft	2	017020105
50	13x23	13.150	2	017020105
70	13x23	14.550	2	017020107



A szerszámot utóélelés közben
hűteni kell!

1702PMR

Tartalék kézvédő a 1702N-hez



L mm	Ft	1	017020200
115	3.830	1	017020200

1704

Feszítővas, hajlított végű

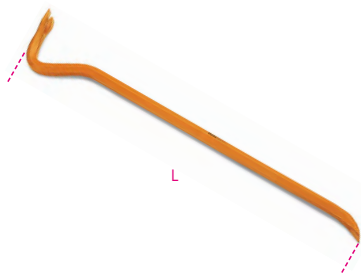

L mm	6 mm	M mm	mm	Ft	csomagolás	azonosító
500	16	35	28	13.750	2	017040050
600	16	34	26	15.600	2	017040060
800	18	38	29	21.850	2	017040080

1704A

Feszítővas lapos és hegyes véggels

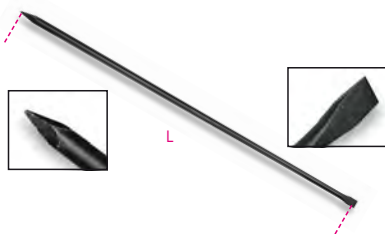

L mm	Ø mm	mm	Ft	csomagolás	azonosító
1500	25	45	46.750	1	017040110
2000	25	55	55.050	1	017040120

1704C

Feszítővas lapos és hegyes véggel
kovácsolt acélból, lakkozott



L mm	8 mm	min-MAX mm	mm	Ft	csomagolás	azonosító
1200	21-31	39	47.150	1	017040210	
1400	31-37	42	56.450	1	017040212	
1600	25-37	42	70.250	1	017040215	

1705

Csapózsínor alumíniumból



L m	Ft	csomagolás	azonosító
1705	30	9.270	4 017050001

1705PT

Jelölő por

- Tartály adagolóval
- Kék



g	Ft	csomagolás	azonosító
250	5.950	5	017050025

1706DGT

Digitális gumiprofil-mélységmérő



1706DGT	Ft	csomagolás	azonosító
	17.400	1	017060011

1707

Menetsablon

Az ISO-szabvány szerinti 60°-os metrikus
és 55° Whitworth menetekhez



P (ISO)	W	Ft	csomagolás	azonosító
0,25÷6	62÷4x1"	8.180	5	017070001

1707A/1 - 2 - 3

Rádiusz-sablon



	R mm	L mm	n	Ft	csomagolás	azonosító
1707A/1	1,0÷7,0	70	34	12.550	2	017070007
1707A/2	7,5÷15	85	32	13.550	2	017070015
1707A/3	15,5÷25	85	30	13.550	2	017070025

1708/8 - 13 - 20

Metrikus hézagmérő

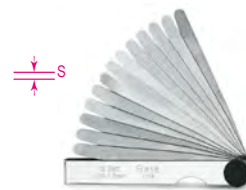

	S	Ft	csomagolás	azonosító
1708/8	S = 0,05±0,50 mm	3.120	5	017080008
1708/13	S = 0,05±1,00 mm	3.520	5	017080013
1708/20	S = 0,05±1,00 mm	5.710	5	017080020

1709/10 - 1709/18

Csavaranyavágó, galvanizált



	L mm	A max mm	Ft	csomagolás	azonosító
1709/10	82,5	17 (M10)	25.100	1	017090010
1709/18	107,8	24 (M16)	27.950	1	017090018

1710

Hidraulikus csavaranyavágó,
galvanizált



	A min mm	A max mm	Ft	csomagolás	azonosító
7(M4)	7	22(M14)	115.800	1	017100001

1712E/1 - 2 - 3

Flexibilis mágneses csavarkiszedő

F = mágneserő



	L mm	D mm	F kg	Ft	csomagolás	azonosító
1712E/1	420	7,5	0,5	14.950	2	017120011
1712E/2	530	15	1,8	19.000	2	017120012
1712E/3	532	19	3,0	23.500	2	017120013

1712TF

Flexibilis teleszkópos mágneses
csavarkiszedő

- Autó ablakmosó fúvóka tisztítóval
- F = Mágneserő



L mm	D mm	F kg	Ft	csomagolás	azonosító
150÷590	11	1	9.880	1	017120600

1712TFS

Flexibilis mágneses csavarkiszedő

F = mágneserő



L	D	F	Ft	Icon	Icon
mm	mm	kg			
135÷570	5	0,4	8.460	1	017120595

1713M

Flexibilis csavarkiszedő

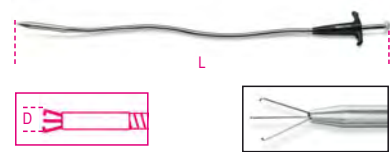

L	D	Ft	Icon	Icon
mm	mm			
500	7	20.650	2	017130011
1000	7	36.450	1	017130015

1713M/K7

7 darabos vizsgáló készlet
1/4" hatlapfejű csatlakozóval

Készlet tartalma:

- 1 db teleszkópos fogantyú (hossz: 185-660 mm)
- 1 db négyzetes vizsgálótűk, 65x43 mm
- 1 db kerek vizsgálótűk, Ø 52 mm
- 1 db mágnes, Ø 16,3 mm
- 1 db ultrafényes LED lámpa
- 1 db flexibilis csavarkiszedő (1713M termék)
- 1 db mágneses, rozsdamentes acél tálca
- 3 db LR44 gombelem



1713M/K7	Ft	Icon	Icon
	73.500	1	017130100

297x165x52 mm - 0,8 kg

1714

Vizsgálótűk



L	D	Ft	Icon	Icon	
mm	mm				
1714	155	25	1.820	5	017140001

1715

Teleszkópos csuklós vizsgálótűk



1715	L	D	Ft	Icon	Icon
	mm	mm			
	180÷540	30	15.600	1	017150001

1715FL/A

Flexibilis négyzet alakú vizsgálótűk



1715FL/A	L	A	B	Ft	Icon	Icon
	mm	mm	mm			
	600	53	90	18.600	1	017150110

1715R/FL

2 darabos póttűk készlet az 1715FL/A és 1715FL/B eszközhöz

1715R/FL	Ft	Icon	Icon
	3.950	1	017150151

1715FL/B

Világító flexibilis téglalap alakú vizsgálótűk

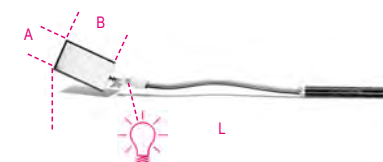

1715FL/B	L	A	B	Ft	Icon	Icon
	mm	mm	mm			
	553	53	90	22.250	1	017150115

1715B/R5L

5 darabos pótgő készlet az 1715FL/B eszközhöz

1715B/R5L	Ft	Icon	Icon
	3.200	1	017150152

1715I

Teleszkópos csuklós vizsgálótűk
5x nagyítással

- Csúszásálló PVC bevonattal
- Rozsdamentes acél vizsgálótűk és nyél



1715I	L	D	Ft	Icon	Icon
	mm	mm			
	250÷720	55	14.550	1	017150020

1715L

Teleszkópos csuklós vizsgálótűk
LED lámpával

- Rozsdamentes acél test
- Csiptetős, zsebben elfér
- 3 db L736F elemmel szállítva

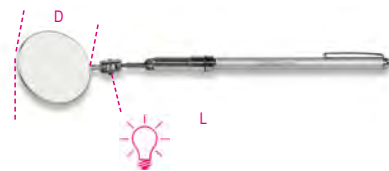

1715L	L	D	Ft	Icon	Icon
	mm	mm			
	265÷765	50	22.650	1	017150005

1716A

Szögletes hegyű ár általános használatra

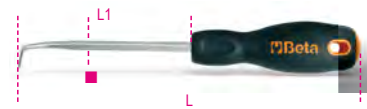

1716A	L	L1	■	Ft	Icon	Icon
	mm	mm	mm			
	240	125	6	5.340	3	017160040

1716P

Hántoló tömítéshez



1716P	L	L1	●	Ft	Icon	Icon
	mm	mm	mm			
	250	125	6	6.560	3	017160020

1716R

Kerekhegyű ár



1716R	L	L1	D	Ft	Icon	Icon
	mm	mm	mm			
	215	100	6	4.570	5	017160001

1716U

Hajlított hegyű ár általános használatra



1716U	L	L1	D	Ft	Icon	Icon
	mm	mm	mm			
	195	80	6	5.340	3	017160025

1717A

Kétélű hántoló, lakkozott, fanyéllal



L mm	L1 mm	L2 mm	Ft		
150	70	260	10.100	2	017170015
250	100	360	11.950	2	017170025

1717B

Háromélű hántoló, lakkozott, fanyéllal



L mm	L1 mm	L2 mm	Ft		
150	75	260	8.740	2	017170115
200	85	310	10.100	2	017170120

1717C

Lapos hántoló, lakkozott fanyéllal



L mm	S mm	L1 mm	Ft		
150	18	270	8.620	2	017170215
200	20	320	9.680	2	017170220
250	25	370	10.700	2	017170225

1717D

Lapos hántoló vágóéllel, lakkozott fanyéllal



L mm	S mm	L1 mm	Ft		
150	150	23 240	11.750	2	017170320

1717T

háromélű hántoló, 2 pengével



L mm	Ft		
1717T 310	5.510	1	017170610

1717T RT

tartalék háromszögű penge



L mm	Ft		
1717T RT 65	1.140	1	017170660

1717T RS

tartalék profilos penge



Ft		
1717T RS 1.140	1	017170661

1717V

festékkaparók, több oldalon használható pengék



L mm	A mm	Ft		
1717V 38 200	38	3.700	1	017170703
1717V 65 285	65	7.940	1	017170706

1717V R

tartalék penge a 1717V termékhez



L mm	Ft		
1717V R38 38	1.140	1	017170753
1717V R65 65	1.620	1	017170756

RESZELŐPROFILOK

EGYENGETŐ

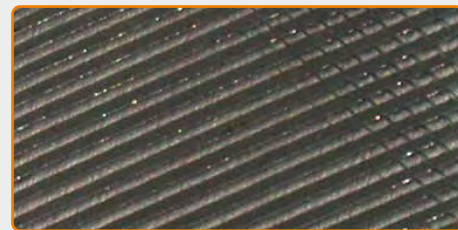

NAGYOLÓ



SIMÍTÓ

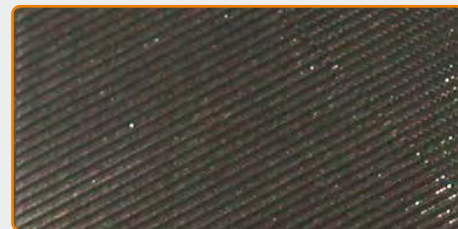

1718D...Q

szögletes nagyoló reszelő markolat nélkül

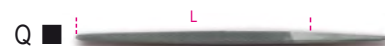

L mm	L1 mm	Ft		
1718D6/Q 150	6	4.330	5	017180121
1718D8/Q 200	8	5.180	5	017180131
1718D10/Q 250	10	7.040	5	017180141

1718A...Q

szögletes egyengető reszelő markolat nélkül

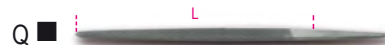

L mm	L1 mm	Ft		
1718A6/Q 150	6	4.410	5	017180021
1718A8/Q 200	8	5.340	5	017180031
1718A10/Q 250	10	7.330	5	017180041

1718D...T

háromszög nagyoló reszelő markolat nélkül

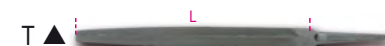

L mm	L1 mm	Ft		
1718D6/T 150	6	5.220	5	017180123
1718D8/T 200	8	6.640	5	017180133
1718D10/T 250	10	8.790	5	017180143



1718A...T

háromszög egyengető reszelő markolat nélkül



	L mm	L' "	Ft		
1718A6/T	150	6	5.340	5	017180023
1718A8/T	200	8	6.800	5	017180033
1718A10/T	250	10	9.190	5	017180043

1718D...P

lapos nagyoló reszelő markolat nélkül



	L mm	L' "	Ft		
1718D6/P	150	6	4.090	5	017180125
1718D8/P	200	8	4.820	5	017180135
1718D10/P	250	10	6.440	5	017180145

1718A...P

lapos egyengető reszelő markolat nélkül



	L mm	L' "	Ft		
1718A6/P	150	6	4.330	5	017180025
1718A8/P	200	8	4.980	5	017180035
1718A10/P	250	10	7.040	5	017180045

1718D...M

félkerek nagyoló reszelő markolat nélkül



	L mm	L' "	Ft		
1718D6/M	150	6	5.750	5	017180127
1718D8/M	200	8	7.090	5	017180137
1718D10/M	250	10	9.190	5	017180147

1718A...M

félkerek egyengető reszelő markolat nélkül



	L mm	L' "	Ft		
1718A6/M	150	6	5.830	5	017180027
1718A8/M	200	8	7.250	5	017180037
1718A10/M	250	10	9.680	5	017180047

1718D...R

kerek nagyoló reszelő markolat nélkül



	L mm	L' "	Ft		
1718D6/R	150	6	4.090	5	017180129
1718D8/R	200	8	4.820	5	017180139
1718D10/R	250	10	6.320	5	017180149

1718A...R

kerek egyengető reszelő markolat nélkül



	L mm	L' "	Ft		
1718A6/R	150	6	4.330	5	017180029
1718A8/R	200	8	4.980	5	017180039
1718A10/R	250	10	6.680	5	017180049

1718D...S5

5 darabos nagyoló reszelő készlet markolat nélkül



	L mm	L' "	Ft		
1718D6/S5	150	6	23.500	1	017180130
1718D8/S5	200	8	28.550	1	017180140
1718D10/S5	250	10	37.750	1	017180150

- Q
- ▲ T
- ▮ P
- M
- R

1718A...S5

5 darabos egyengető reszelő készlet markolat nélkül



	L mm	L' "	Ft		
1718A6/S5	150	6	24.250	1	017180030
1718A8/S5	200	8	29.350	1	017180040
1718A10/S5	250	10	39.900	1	017180050

- Q
- ▲ T
- ▮ P
- M
- R

1719BMD...Q

szögletes nagyoló reszelő markolattal



	L mm	L' "	Ft		
1719BMD6/Q	150	6	5.910	5	017190191
1719BMD8/Q	200	8	6.560	5	017190221
1719BMD10/Q	250	10	8.990	5	017190241
1719BMD12/Q	300	12	11.750	3	017190325

1719BMA...Q

szögletes egyengető reszelő markolattal



	L mm	L' "	Ft		
1719BMA6/Q	150	6	5.950	5	017190021
1719BMA8/Q	200	8	7.170	5	017190052
1719BMA10/Q	250	10	9.350	5	017190071
1719BMA12/Q	300	12	13.750	3	017190311

1719BMX...Q

szögletes simító reszelő markolattal



	L mm	L' "	Ft		
1719BMX6/Q	150	6	6.360	5	017190022
1719BMX8/Q	200	8	8.260	5	017190053
1719BMX10/Q	250	10	11.150	5	017190072

1719BMD...T

háromszög nagyoló reszelő markolattal



	L mm	L' "	Ft		
1719BMD6/T	150	6	7.090	5	017190193
1719BMD8/T	200	8	8.100	5	017190223
1719BMD10/T	250	10	10.950	5	017190243
1719BMD12/T	300	12	15.600	3	017190326

1719BMA...T

háromszög egyengető reszelő markolattal



	L mm	L' "	Ft		
1719BMA6/T	150	6	7.090	5	017190023
1719BMA8/T	200	8	8.790	5	017190054
1719BMA10/T	250	10	11.350	5	017190073
1719BMA12/T	300	12	16.200	3	017190313

1719BMX...T

háromszög simító reszelő markolattal



	L mm	L' "	Ft		
1719BMX6/T	150	6	8.380	5	017190024
1719BMX8/T	200	8	10.950	5	017190055
1719BMX10/T	250	10	13.950	5	017190074

1719BMD...P

lapos nagyoló reszelő markolattal



	L mm	L "	Ft	☒	☒
1719BMD6/P	150	6	5.910	5	017190195
1719BMD8/P	200	8	6.230	5	017190225
1719BMD10/P	250	10	8.830	5	017190245
1719BMD12/P	300	12	11.550	3	017190327

1719BMA...P

lapos egyengető reszelő markolattal



	L mm	L "	Ft	☒	☒
1719BMA6/P	150	6	6.230	5	017190025
1719BMA8/P	200	8	7.090	5	017190056
1719BMA10/P	250	10	9.150	5	017190075
1719BMA12/P	300	12	13.150	3	017190315

1719BMX...P

lapos simító reszelő markolattal



	L mm	L "	Ft	☒	☒
1719BMX6/P	150	6	6.360	5	017190026
1719BMX8/P	200	8	8.380	5	017190057
1719BMX10/P	250	10	10.950	5	017190076

1719BMD...M

félkerek nagyoló reszelő markolattal



	L mm	L "	Ft	☒	☒
1719BMD6/M	150	6	7.810	5	017190197
1719BMD8/M	200	8	8.380	5	017190227
1719BMD10/M	250	10	11.350	5	017190247
1719BMD12/M	300	12	15.800	3	017190328

1719BMA...M

félkerek egyengető reszelő markolattal



	L mm	L "	Ft	☒	☒
1719BMA6/M	150	6	8.100	5	017190027
1719BMA8/M	200	8	9.470	5	017190058
1719BMA10/M	250	10	12.350	5	017190077
1719BMA12/M	300	12	17.400	3	017190317

1719BMX...M

félkerek simító reszelő markolattal



	L mm	L "	Ft	☒	☒
1719BMX6/M	150	6	8.620	5	017190028
1719BMX8/M	200	8	10.700	5	017190059
1719BMX10/M	250	10	14.950	5	017190078

1719BMD...R

kerek nagyoló reszelő markolattal



	L mm	L "	Ft	☒	☒
1719BMD6/R	150	6	5.910	5	017190199
1719BMD8/R	200	8	6.150	5	017190229
1719BMD10/R	250	10	8.580	5	017190249
1719BMD12/R	300	12	11.350	3	017190329

1719BMA...R

kerek egyengető reszelő markolattal



	L mm	L "	Ft	☒	☒
1719BMA6/R	150	6	6.280	5	017190029
1719BMA8/R	200	8	7.000	5	017190060
1719BMA10/R	250	10	8.910	5	017190079
1719BMA12/R	300	12	11.950	3	017190319

1719BMX...R

kerek simító reszelő markolattal



	L mm	L "	Ft	☒	☒
1719BMX6/R	150	6	7.250	5	017190031
1719BMX8/R	200	8	8.100	5	017190061
1719BMX10/R	250	10	10.950	5	017190081

1719BMA...B5

5 darab egyengető reszelő, tartóban



	L mm	L "	Ft	☒	☒
1719BMA8/B5	200	8	39.500	1	017190297
1719BMA10/B5	250	10	51.100	1	017190298

1719BMD...B5

5 darab nagyoló reszelő, tartóban



	L mm	L "	Ft	☒	☒
1719BMD8/B5	200	8	35.400	1	017190303
1719BMD10/B5	250	10	48.650	1	017190305

1719BMD...S5

5 darabos nagyoló reszelő készlet markolattal

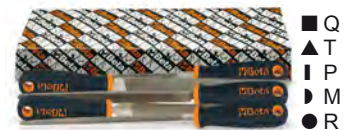

	L mm	L "	Ft	☒	☒
1719BMD6/S5	150	6	32.650	1	017190200
1719BMD8/S5	200	8	35.400	1	017190230
1719BMD10/S5	250	10	48.650	1	017190250
1719BMD12/S5	300	12	66.000	1	017190363

1719BMA...S5

5 darabos egyengető reszelő készlet markolattal



	L mm	L "	Ft	☒	☒
1719BMA6/S5	150	6	33.650	1	017190030
1719BMA8/S5	200	8	39.500	1	017190070
1719BMA10/S5	250	10	51.100	1	017190080
1719BMA12/S5	300	12	72.450	1	017190361

1719BMX...S5

5 darabos simító reszelő készlet markolattal



	L mm	L "	Ft	☒	☒
1719BMX6/S5	150	6	36.950	1	017190032
1719BMX8/S5	200	8	46.400	1	017190069
1719BMX10/S5	250	10	61.950	1	017190082

1719BMB/P

Laposreszelő, műanyag nyéllel

L		L		Ft	5	017190152
mm	"	mm	"			
250	10	13.950	5	017190152		
300	12	16.400	5	017190153		

1719BMC

Félkerek és laposreszelő, műanyag nyéllel

L		L		Ft	6	017190252
mm	"	mm	"			
250	10	9.350	4	017190253		
300	12	11.750	4	017190262		
250	10	7.410	6	017190262		
300	12	9.150	4	017190263		

UNI 5569 - UNI 5568

1719BM/RL

Lapos reszelő
1 egyengető oldal,
1 nagyoló oldal
műanyag markolat

L		L		Ft	5	017190360
mm	"	mm	"			
200	8	7.410	5	017190360		

1719BM/RR

Kerek reszelő, műanyag markolattal

L		L		Ft	5	017190351
mm	"	mm	"			
200	8	7.730	5	017190351		

1719BM/RG

Félkerek reszelő markolattal

L		L		Ft	5	017190353
mm	"	mm	"			
200	8	7.650	5	017190353		

1719BM/RP

Lapos reszelő markolattal

L		L		Ft	5	017190352
mm	"	mm	"			
200	8	7.890	5	017190352		

1719BMR/B3

Egyengető reszelő készlet markolattal,
felfüggeszthető tartóban

L		L		Ft	1	017190358
mm	"	mm	"			
200	8	23.250	1	017190358		

1719BMR

Tartaléknyél a reszelőhöz

L		A		Ft	10	017190950
mm	mm	mm	mm			
95	25	1.700	10	017190950		
110	29	1.700	10	017190955		
110	29	1.700	10	017190951		
110	29	1.700	10	017190953		
123	31	1.700	10	017190952		
123	31	1.700	10	017190954		

1719BMR/0	100/150	4/6	▲▲
1719BMR/0B	100/150	6/8	●●
1719BMR/1	150/200	6/8	▲▲
1719BMR/1B	150/200	6/8	●●
1719BMR/2	250/300	10/12	▲▲
1719BMR/2B	250/300	10/12	●●



1720/...

egyengető tűreszelők,
szár Ø 3 mm

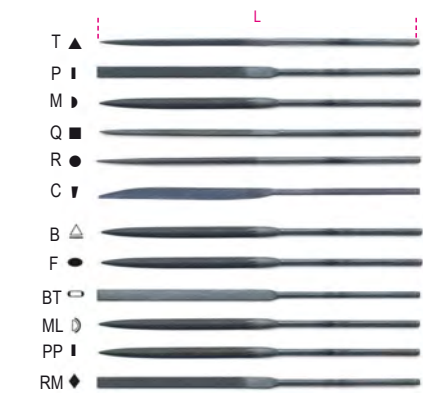

UNI 5569 UNI 5670

	L	Ft	5	017200004
1720T	mm			
1720P	160	3.400	5	017200006
1720M	160	3.400	5	017200008
1720Q	160	3.400	5	017200009
1720R	160	3.400	5	017200010
1720C	160	3.400	5	017200012
1720B	160	3.400	5	017200005
1720ML	160	3.400	5	017200007
1720BT	160	3.400	5	017200011
1720F	160	3.400	5	017200013
1720PP	160	3.400	5	017200014
1720RM	160	3.400	5	017200015

R ●		Ft	1	017200000
T ▲	P I			
1720/S3		10.200	1	017200000

1720/B

Ft		1	017200002
1720/B6	21.450		
1720/B12	40.800	1	017200003

1720D/...

gyémánt tűreszelők
D126 szemcseméret

L		Ft	2	017200104
mm	mm			
1720D/T	160	22.050	2	017200104
1720D/P	160	22.050	2	017200106
1720D/M	160	22.050	2	017200108
1720D/Q	160	22.050	2	017200109
1720D/R	160	22.050	2	017200110
1720D/C	160	22.050	2	017200112



1720/B6	Ft	1	017200120
	133.400		

1721/B6

6 részes kontaktreszelő készlet



1721/B6	Ft	1	017210010
	11.350		

1723

Rugóbeakasztó, krómzott



1723	L mm	Ft	5	017230001
	210	7.410		

1725

Fűrész, fűrészkeret krómzott acélból, nyél könnyűfémből, bimetal fűrészlappal



1725	L mm	L1 mm	Ft	4	017250001
	420	300	10.100		

1725CR

Mini fűrész, lakozott alumíniumból



1725CR	L mm	L1 mm	Ft	5	017250010
	250	150	5.590		

1726

Fűrész, fűrészkeret lakozott acélból, nyél könnyűfémből, bimetal fűrészlappal

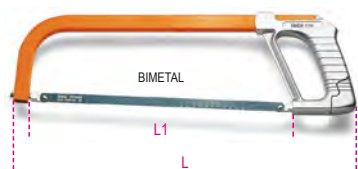

1726	L mm	L1 mm	Ft	4	017260001
	440	300	13.550		

1726BM

Fűrész fűrészlapfesztítővel, gyorslazítóval

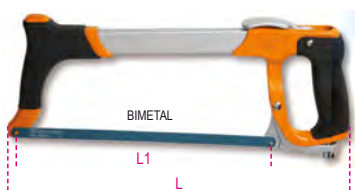

1726BM	L mm	L1 mm	Ft	1	017260050
	400	300	21.850		

1727

Erősített fűrész, fűrészkeret lakozott acélból, fanyéllal, bimetal fűrészlappal

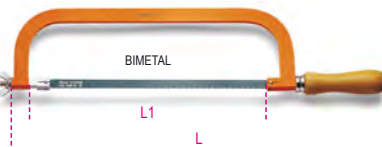

1727	L mm	L1 mm	Ft	4	017270001
	515	300	9.350		

1727BM

Egykezes fűrész



1727BM	L mm	L1 mm	Ft	5	017270020
	315	300	11.350		

1728...

Fűrészlap



1728LA	Ft	100	017280001
1725CR			
1725MQ			
1728BM	665	100	017280010
1725-1726	1.680	100	017280010
1727-1727M			
1728CO	2.310	50	017280030
1725-1726			
1727-1727M			

1729CG

Gipszkartonfűrész



1729CG	L mm	L1 mm	Ft	2	017290200
	310	160	11.150		

1729DM 450

Fafűrész

Közepes fogazat, 12 fog/coll



1729DM 450	L mm	L1 mm	Ft	4	017290450
	450	400	12.750		

1729J

Japán húzófűrész

17 fog/coll (TPI)



	L mm	L1 mm	Ft	4	017290400
	405	235	17.000		

1729MF

Univerzális fűrész fémhez, gipszkartonhoz, fához és műanyaghoz

Készlet tartalma:

- 24 fog/coll (TPI) penge fémhez
- 6 fog/coll (TPI) penge gipszkartonhoz
- dupla élű penge, egyik él: 11 fog/coll (TPI) műanyaghoz, másik él: 16 fog/coll (TPI) fához



1729MF	Ft	1	017290500
	11.150		

1729MF/CG

Tartalék pengék az 1729MF univerzális fűrészhez



1729MF/CG	Ft	4	017290502
	5.340		

1729MF/J

Tartalék pengék az 1729MF univerzális fűrészhez



1729MF/J	Ft	4	017290501
	8.020		

1729MF/M

Tartalék pengék az 1729MF univerzális fűrészhez



1729MF/M	Ft	4	017290503
	5.790		

1730

univerzális spakli rozsdamentes acél pengével és nyéllal



S mm	L mm	L1 mm	Ft	2	017300038
38	210	85	2.830		
63	220	95	3.360		017300063
75	220	95	3.640		017300075
100	220	95	4.210		017300100

1736A

reszelőtisztító kefe rozsdamentes acél drót, drót Ø: 0,5 mm



1736A	L mm	Ft	10	017360010
	240	5.140		

1737

sárgaréz hullámos drótkefe drót Ø: 0,2 mm



1737	L mm	Ft	10	017370001
	145	2.490		

1737NX

rézzel bevont acél drótkefe drót Ø: 0,3 mm



1737NX	L mm	Ft	5	017370010
	270	2.980		

1737AC

acél drótkefe, 5 soros drót Ø: 0,3 mm



1737AC	L mm	Ft	5	017370020
	275	2.850		

1737B

akkusaru és pólus tisztító acél drótkefe drót Ø: 0,3 mm



1737B	Ft	1	017370050
	7.000		

1738

Sörtésecset



1738	L mm	H mm	Ft	10	017380001
	210	30	4.090		

1739C

Harmonikás popszegecszúzó, 5 darab cserélhető betéttel



Ø mm	3,2	4	4,8	5	6	6,4
aluminium	•	•	•	•	•	•
Rozsdamentes acél	•	•	•	•		

1739C	L max mm	Ft	1	017390152
	810	59.500		



1740AN

Erősített kétkezes szegecszúzó 5 darab tartalék betéttel • Popszegecs tartállyal



Ø mm	3,2	4	4,8	5	6	6,4
aluminium	•	•	•	•	•	•
Rozsdamentes acél	•	•	•	•		

1740AN	L mm	Ft	1	017400103
	530	54.050		

1740B

Alumínium Acél Rozsdamentes acél

Alumínium Acél Rozsdamentes acél



Ø mm	2,4	3	3,2	3,2	4,8
aluminium	•	•	•	•	•
Acél	•	•	•	•	•
Rozsdamentes acél	•	•	•	•	•

1740B 280	L mm	Ft	1	017400280
	280	35.000		

Ø mm	2,4	3,2	4,0	4,8	6,4
aluminium	•	•	•	•	•
rozsdamentes acél	•	•	•	•	•
Inox	•	•	•	•	•

1740B 330	L mm	Ft	1	017400330
	330	40.500		



1741

popszegecsűző könnyűfémötvözetből

4 cserélhető betéttel



266 mm

Ø mm	2,4	3,2	4	4,8	5
Alumínium	•	•	•	•	•
Acél	•	•	•	•	•
Rozsdamentes acél	•	•	•		

1741 Ft 17.600 1 017410003

1741/C5

1741 típusú popszegecsűző készlet 700 alumínium szegeccsel



1741/C5 Ft 57.700 1 017410035

	Ø mm	L mm	n.
1741RV2,9K	3,0	6	200
1741RV3,2K	3,2	8	200
1741RV3,8K	4,0	10	100
1741RV4K	4,0	12	100
1741RV4,8K	4,8	12	100

420x160x60 mm - 3150 g

1741P

erősített, kétkézes szegecsűző

4 cserélhető betéttel



260 mm

Ø mm	2,4	3,2	4	4,8	5
Alumínium	•	•	•	•	•
Acél	•	•	•	•	•
Rozsdamentes acél	•	•	•		

1741P Ft 24.500 1 017410303

1741TR

Popszegecsűző, elforgatható fejjel, 4 db cserélhető betéttel

4 db cserélhető betéttel



285mm



Ø mm	2,4	3	3,2	4	4,8
Alumínium	•	•	•	•	•
Acél	•	•	•	•	•
Rozsdamentes acél	•	•	•		

1741TR Ft 19.250 1 017410410

1741U

Rozsdamentes acél

3 betét: a szegecses fix tartására



200 mm

Ø mm	2,4	3	3,2	4	4,8
Alumínium	•	•	•	•	•
Acél	•	•	•	•	•
Nemesacél	•	•	•		

1741U Ft 21.850 1 017410450

1741RV...K

Alumínium szegecses

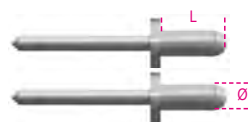

	Ft	1	017410191
1741RV 2,9K ØxL = 3x6 mm	9.270		
1741RV 3,2K ØxL = 3,2x8 mm	9.550		
1741RV 3,8K ØxL = 4x10 mm	11.950		
1741RV 4K ØxL = 4x12 mm	13.150		
1741RV 4,8K ØxL = 4,8x12 mm	16.200		

A megadott árak 500 darabra vonatkoznak.

1742N

Szegecsnyaroppantó, 4 db tartalék betéttel és 4 pinnel (1x, M3, M4, M5, M6)



250 mm

1742N Ft 61.350 1 017420002

	Ø mm	L mm
3	5	11
4	6	11
5	7	13
6	9	17

1742N/KR

4 db tartalék betét a 1742AN modellhez



	Ft	1	017420063
M3	26.300		
M4	26.300		
M5	26.300		
M6	26.300		

1742R-AL/M...

Alumínium szegecses a 1742-1742A-1946KF modellhez



	Ft	1	017420023
1742R-AL M3 ØxL = 5x10 mm M = 3	2.290		
1742R-AL M4 ØxL = 6x12 mm M = 4	2.350		
1742R-AL M5 ØxL = 7x13 mm M = 5	2.510		
1742R-AL M6 ØxL = 9x15 mm M = 6	3.060		

A megadott árak 20 darabra vonatkoznak.



1742R-A/M...

Acél szegecses a 1742-1742A-1946KF modellhez

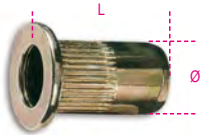

	Ft	📦	🏠
1742R-A M3 ØxL = 5x11 mm M = 3	2.430	1	017420013
1742R-A M4 ØxL = 6x11 mm M = 4	2.470	1	017420014
1742R-A M5 ØxL = 7x13 mm M = 5	2.610	1	017420015
1742R-A M6 ØxL = 9x17 mm M = 6	3.120	1	017420016
1742R-A M8 ØxL = 11x17 mm M = 8	2.960	1	017420018
1742R-A M10 ØxL = 13x24 mm M = 10	3.540	1	017420020
1742R-A M12 ØxL = 12x24 mm M = 12	3.990	1	017420022

A megadott árak 20 darabra vonatkoznak
• A megadott árak 10 darabra vonatkoznak

1742N/C4

1742N Szegecsnyaroppantó 400 db acélszegeccsel



	Ft	📦	🏠
1742N/C4	137.100	1	017420006

	M	Ø mm	n.
1742R-A/M3	3	5	100
1742R-A/M4	4	6	100
1742R-A/M5	5	7	100
1742R-A/M6	6	9	100

415x155x60 mm - 2,9 kg

1742AN

Erősített szegecsnyaroppantó 7 darab cserélhető fejjel



	Ft	📦	🏠
1742AN	193.900	1	017420101

M	Ø mm	L mm
3	5	13
4	6	13
5	7	13
6	9	17
8	11	17
10	13	24
12	15	24

1742AN/KR

4 db cserélhető betét a 1742AN modellhez



		Ft	📦	🏠
1742AN/KR M3	M3	17.800	1	017420153
1742AN/KR M4	M4	17.800	1	017420154
1742AN/KR M5	M5	17.800	1	017420155
1742AN/KR M6	M6	17.800	1	017420156
1742AN/KR M8	M8	17.800	1	017420158
1742AN/KR M10	M10	17.800	1	017420160
1742AN/KR M12	M12	17.800	1	017420162

1742AN/C

Erősített szegecsnyaroppantó 80 db acélszegeccsel



	Ft	📦	🏠
1742AN/C	225.500	1	017420106

	M	Ø mm	n.
1742R-A/M3	3	5	5
1742R-A/M4	4	6	10
1742R-A/M5	5	7	20
1742R-A/M6	6	9	20
1742R-A/M8	8	11	10
1742R-A/M10	10	13	10
1742R-A/M12	12	15	5

420x240x80 mm - 2,5 kg

1749

Kinyomópisztoly lakkozott fémlémezről



	L min mm	Ft	📦	🏠
1749	340	6.560	2	017490001

1749A

Kinyomópisztoly, profi modell, alumíniumcső



	L min mm	Ft	📦	🏠
1749A	360	20.450	1	017490010

1749A/RB

pótcső az 1749A eszközhöz

	Ft	📦	🏠
1749A/RB	475	1	017490051

1749A/RT

becsavarható homlokdugó az 1749A eszközhöz

	Ft	📦	🏠
1749A/RT	1.040	1	017490052

1749AC

Magas nyomású kinyomópisztoly



	L min mm	Ft	📦	🏠
1749AC	360	18.200	1	017490005

1750

karosszívó

a 1750CG zsírpattonnal vagy ömlesztett zsírral is használható



	Ft	📦	🏠
1750 500	20.250	1	017500500
1750 750	23.900	1	017500750

1750R/1 - 1750R/2

Flexibilis tartalék zsírcső,
műanyagból



	L mm	Ft		
1750R/1	310	3.200	2	017500030
1750R/2	410	3.560	2	017500040

1750RC

Merev hajlított zsírcső



	L mm	M mm	Ft	
1750RC	150	10x1	2.630	2 017500050

1750RT

"Hydraulic 4-pofás tartalék zsírféj



	M mm	Ft	
1750RT	10x1	2.370	5 017500110

1750RP/1 - 1750RP/2

Zsírféj lapos zsírgombokhoz



	Ø mm	M mm	Ft	
1750RP/1	16	10x1	5.830	2 017500115
1750RP/2	22	10x1	13.150	2 017500120

1750PF

Univerzális kenőzsír patron az 1750
karoszsírcső

• Felhasználási hőmérséklet: -20 °C ÷ +130 °C



g	Ft	
400	7.130	18 017500141
550	8.910	18 017500161

1750KG10

karos zsírcsőkészülék, 10 kg térfogat,
2 m nagynyomású csővel

forgatható csatlakozóval rendelkezik a cső megtörésének
elkerülésére
fröccsöntött alumínium szivattyútest légtelenítő szeleppel

3 különböző nyomás szint beállítási lehetőség:
-4 gr 275 bárnál
-7 gr 206 bárnál
-9 gr 137 bárnál



	Ft	
1750KG10	91.100	1 017500100

1750TA

nagynyomású 6 tűs
önzáró zsírféj

az elhelyezése után tengelyirányban és a zsírcsőszemhez
rögzítve marad, nem szükséges a helyén tartani, mint a
közönséges zsírféjeket
könnyű leválasztás nyomás alatt álló zsírféjénél is
M10x1 menet: mindenféle zsírcsőszemmel alkalmas:
elektromos, pneumatikus, kézi, stb.
550 bárig nem deformálódik



	Ft	
1750TA	21.450	1 017500111

1750TLA

nagynyomású 6 tűs önzáró hosszú zsírféj

Az elhelyezése után tengelyirányban és a zsírcsőszemhez
rögzítve marad
Könnyű leválasztás nyomás alatt álló zsírféjénél is
M10x1 menet: mindenféle zsírcsőszemmel alkalmas:
elektromos, pneumatikus, kézi, stb.
550 barig nem deformálódik



	Ft	
1750TLA	28.750	1 017500112

1750M

Mini-zsírcső

- Mikrofúvókával
- Elsősorban pneumatikus szerszámokhoz használható



	cc	D mm	L mm	Ft	
1750M	100	43	145	10.700	1 017500025

1750M3

Mini zsírcső 3 zsírféjfel

- Három cserélhető zsírféj: 0,7 - 1,0 - 1,4 mm
- Elsősorban pneumatikus szerszámokhoz
- Ömlesztett zsírral is használható
- Akár NLGI 2 konzisztenciaosztályú zsírral is használható



	cc	Ø mm	L mm	Ft	
1750M3	85	42	160	13.950	1 017500003

1751CR

Olajozó fémkanna,
merev csővel



cc	D mm	L mm	Ft	
200	62	140	7.210	4 017510202
300	75	140	7.810	4 017510203
500	85	140	8.300	4 017510205
700	100	140	9.030	2 017510207
1000	100	140	9.840	2 017510210

1751N

olajozó fémkanna,
flexibilis csővel



cc	D mm	L mm	Ft		
200	62	140	7.610	4	017510020
300	75	140	8.300	4	017510030
500	85	140	8.660	4	017510050
700	100	140	9.430	2	017510075
1000	100	140	10.300	2	017510100

1752

pumpás olajozó műanyag kanna, merev csővel



cc	D mm	L mm	Ft		
200	67	140	4.940	4	017520002
300	77	140	5.340	4	017520003
500	95	140	5.630	4	017520005

1754

Pumpás olajozó műanyag kanna,
flexibilis, műanyag csővel



cc	D mm	L mm	Ft		
150	60	130	4.490	5	017540015
250	65	130	5.060	5	017540025

1755C

Olajozó műanyagkanna,
ívelt csővel



cc	L mm	A mm	Ft		
125	110	46	2.040	5	017550112
250	110	60	2.810	5	017550125
500	110	74	3.180	4	017550150

1755P

Olajozó műanyagkanna



cc	L mm	A mm	Ft		
1755P 50	50	35	55	4.010	1 017550050
1755P 80	80	35	45	4.700	1 017550080

1756

olajbefecskendező

ásványi olajokhoz is alkalmas



cc	L mm	Ft		
5	140	10.700	2	017560001

1756B

olajbefecskendező

- recézett felülettel
- felhasználási hőmérséklet: -10 °C - +60 °C
- minimum SAE 10 viszkozitású olaj



cc	L mm	Ft		
500	280	10.500	2	017560220

1756V

Polipropilén
olajbefecskendező 200 ml

- olajhoz és fékfolyadékhoz
- működési hőmérséklet: +0 °C ÷ +50 °C
- üzemanyaghoz és gyúlékony folyadékokhoz nem használható
- legkisebb olajviszkozitás: SAE30-nál alacsonyabb



1756V	Ft		
	18.400	1	017560504

1756D

Polipropilén olajbefecskendező 1500 ml

- Dupla tömítés NBR
- Üzemeltetési hőmérséklet: +0 - +50 °C
- NEM alkalmas üzemanyaghoz

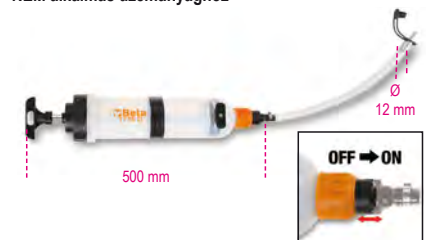

1756D	Ft		
	37.250	1	017560515

1756E

Benzin befecskendező



1756E	Ft		
	19.250	1	017560610

1756G

gázolaj befecskendező
űrtartalom: 1,5 l

- Felhasználás:
- gázolajszűrők feltöltése
 - adalékartály feltöltése



- Készlet tartalma:
- 2 cső mama gyorscsatlakozóval gázolaj olajcsövek csatlakoztatásához
 - 2 papa gyorscsatlakozó, fém
 - 1 kúp alakú adapter gumitömítőkhöz

1756G	Ft		
	57.100	1	017560615

1756V-20R

O-gyűrű pár az 1756V olajbefecskendezőhöz



1756V-20R	Ft		
	5.340	1	017560505

1756D-20R

O-gyűrű pár az 1756D befecskendezőhöz

1756D-20R	Ft		
	3.520	1	017560516

1757

Deszillált víz tartó flakon, műanyagból



cc	D mm	Ft		
250	60	1.680	4	017570002
500	75	2.020	4	017570004
1000	90	2.790	2	017570006

1757A

Akkumulátorsav feltöltő kanna, műanyagból



cc	Ft		
2000	20.450	1	017570020

1758

önbeálló tölcser

különösen alkalmas azoknál az autóknál, amelyek nem rendelkeznek mélyedéssel a töltőfedélben



1758	Ft		
	25.700	1	017580020

1758ADB-D



1758 ADB-D	I Max	Ft		
	1	16.400	1	017580050

1758ADB-45°

visszafolyásgátló tölcser AdBlue®-hoz, 45°-os csatlakozóval



1758 ADB-45	I Max	Ft		
	1	17.600	1	017580060

1758B

visszafolyásgátló tölcser gyorscsatlakozóval
Különösen alkalmas a VAG modellekhez



1758B	Ft		
	17.200	1	017580030

1758B-1,6

visszafolyásgátló tölcser, 1600 ml, gyorscsatlakozóval
gyorscsatlakozó VAG modellekhez



1758B-1,6	H1 mm	H2 mm	Ø mm	Ft		
	125	100	155	19.250	1	017580033

1758B-RNT

gyorscsatlakozó a 1758B-1758B-1,6 visszafolyásgátló tölcserhez
Renault 1.5 dCi motorhoz



1758B-RNT	Ft		
	12.350	1	017580035

1758B/K5

gyorscsatlakozó adapter készlet a 1758B - 1758B-1,6 visszafolyásgátló tölcserhez

- Készlet tartalma:
- 1 adapter 1.5 dCi Renault, Dacia és Nissan motorokhoz
 - 1 adapter 1.5/1.6 dCi Renault, Dacia és Nissan motorokhoz
 - 1 adapter 3.0 BMW dízel motorhoz
 - 1 adapter a VAG csoport 1.5/2.0 benzin motorjaihoz
 - 1 csapos csatlakozó adapter a visszafolyásgátló tölcserhez



1758B/K5	Ft		
	48.800	1	017580040

1758RD

Hűtőfolyadék tölcser
gyorscsatlakozóval



H mm	Ø mm	Ft	📦	🚚
248	172	53.050	1	017580070

1758S

Falitartó a 1758 modellhez



1758S	Ft	📦	🚚
	39.650	1	017580080

1758LG

formálható alumínium lemez gumiburkolattal,
a folyadékok csatornázásához



L mm	H mm	Ft	📦	🚚
365	168	21.850	1	017580006

1758M

Tölcser



1758M	L mm	Ft	📦	🚚
	350	6.440	1	017580000

1758R

folyadék tartály

praktikus levehető rugalmas kiöntőcső



	lt	Ft	📦	🚚
1758R 1	1	4.050	1	017580201
1758R 2	2	4.860	1	017580202
1758R 3	3	8.620	1	017580203
1758R 5	5	10.500	1	017580205

1758VT

Hengerfejvizsgáló készülék

A széndioxid kibocsátás mértékének gyors kijelzése



1758VT	Ft	📦	🚚
	83.000	1	017580100

290x190x50 mm - 1kg

1758VT/L

kontrasztfolyadék hengerfej vizsgálatához



1758VT/L	Ft	📦	🚚
	23.900	1	017580101

1759

Optikai fagyálló-, akkumulátorsav-,
tárcsamosó- és AdBlue®-folyadék vizsgáló
készülék

Erősített tokban szállítva

Automatikus hőmérsékletkompenzáció

Akkumulátorsav: Mérési tartomány:

1,1 - 1,3 kg/l

Propilén hűtőfolyadék:

-25°C - -50°C

Etilén hűtőfolyadék: -25°C - -50°C

Tárcsamosófolyadék: -25°C - -40°C

AdBlue: Karbamidmérés: 30 %-45 %



1759	Ft	📦	🚚
	76.900	1	017590251

1759A

Fagyállóvizsgáló, üvegest



1759A	L mm	Ft	📦	🚚
	340	32.400	1	017590001

1759B

Savsűrűségmérő



1759B	L mm	Ft	📦	🚚
	280	21.250	1	017590005

1759HD/3

Hűtőrendszer tömítettségét ellenőrző készülék

- Lehetővé teszi a nyomás alatt lévő rendszer esetleges szivárgásának vizsgálatát (csövek, csatlakozók, szivattyúk és hűtők) és a rendszer gyors feltöltését levegősődés nélkül



1759HD/3 Ft 270.900 1 017590063
600x500x140 mm - 6,5 kg

1759LR

hűtőrendszer átmósó pisztoly

sűrített levegős,
a magas víznyomás hatékony átmósást
biztosít

- 6 db csatlakozóadapterrel szállítva
- rögzíthető működtető kar folyamatos használathoz
- vizes gyorscsatlakozóval szállítva



1759LR L Ft 208.100 1 017590070
402 mm
390x330x100

1759HD/RR

Hűtőtöltőkészülék

- Lehetővé teszi a berendezés gyors feltöltését levegősődés nélkül



1759HD/RR Ft 83.000 1 017590064
450x310x110 mm - 2,2 kg

1759HD/TRUCK

teherautó hűtőrendszer ellenőrző és tömítő
készülék



1759HD/TRUCK Ft 188.300 1 017590065
440x330x100 mm - 3 kg

1759TT

4 pár dugó turbókör teszteléséhez
tömlőfúvatóval
használható



1759TT Ft 100.000 1 017590300
400x160x100 mm - 1,8 kg

TANÚSÍTÁSI SZOLGÁLTATÁS ELEKTRONIKUS MŰSZEREKHEZ

Az elektronikus mérőműszerek, így a multiméterek, lakatfogók, **tachométerek és hőmérők** tanúsítása elengedhetetlen azokban az ágazatokban vagy alkalmazási területeken, ahol pontos, egyértelmű és felismerhető mérésekre van szükség. Infravörös hőmérők esetén 4 pontos kalibrációs jegyzőkönyv (minimum, maximum és két közbenső pont) kiadására kerül sor ENAC szerinti nyomon követhetőséggel.

A Beta Utensili S.p.A. kérésre tanúsítási szolgáltatást biztosít. A szolgáltatás igénybevételéhez keresse márkakereskedésünket.

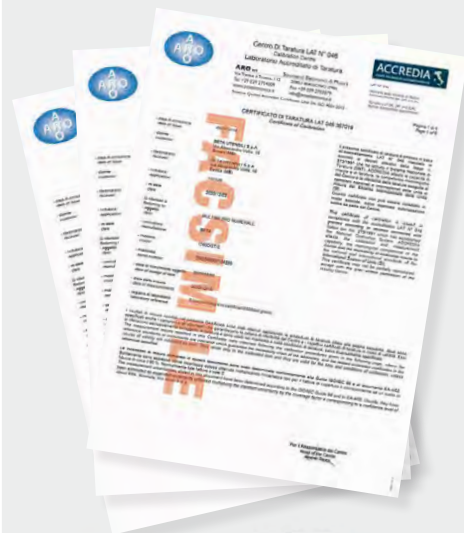

1760DGT

Automotív univerzális digitális multiméter



Műszaki adatok
RPM (Tacho):
2- és 4-hengeres motorokhoz
RPM4 600 - 4000 U/perc
RPM4 600 - 12000 U/perc(x10 U/perc)
RPM2/DIS 300 - 4000 U/perc
RPM2/DIS 300 - 6000 U/perc (x10 U/perc)
Dwell-Winkel/Pillanatnyi állás: 4-8 CYL
Feszültség DC: 400mV-4/40/400/1000V
Feszültség AC: 4/40/400/700V
Egyenáram DC: 40/400mA-4/20A
Váltakozó AC: 40/400mA-4/20A
Ellenállás: 400Ω-4/40/400kΩ-4/40MΩ
Kapacitás: 40/400nF-4/40/100μF
Frekvencia: 5/50/500Hz-50/500-10MHz
Kitöltési tényező: 0,1 - 99,9%
Impulzustényező: 1 - 10ms
Diódateszt: Jelteszt 0,3mA
Folytonosság teszt: <150Ω - Jelteszt <0,3mA
Kijelző: LCD folyadékkristályos kijelző, 4-soros, rejtett világítással
Érintésvédelem: Kategória II 1000V
Automatikus kikapcsolás: 30 perc
Áramforrás: 1 9V elem (együtt szállítva)
Indukciós csipesz (együtt szállítva)
2 mérőcsúcs (együtt szállítva)
Tok (együtt szállítva)
Használati utasítás

1760DGT Ft 127.100 1 017600005

Beta



1760DGT/2

digitális hordozható multiméter gépkocsikhoz, 2-csatornás oszcilloszkóppal és hullámgenerátorral



MŰSZAKI ADATOK
Kijelző: 2.8" színes TFT
Felbontás: 320 x 240 pixel
Tápellátás: 100V-240V AC, 50Hz-60Hz; DC BEMENET 5V DC-2A
Akkumulátor: 2 x 2600 mAh

MULTIMÉTER MŰSZAKI ADATOK
Teszt lehetőségek: feszültség, áramerősség, ellenállás, kapacitás, diódateszt, be-ki
Max. feszültség: 600V AC-DC
Max. áramerősség: 10A AC-DC
Max. áramerősség: 40MOHM
Max. kapacitás: 100μF

OSZCILLOSZKÓP MŰSZAKI ADATOK
Függőleges
Sávszélesség: 40MHz
Mintavételi frekvencia tartomány: 250MSa/s (egy csatorna) - 125MSa/s (két csatorna)
SEC/DIV tartomány: 5ns/div + 500s/div 1,2,5 sorozat
Vertikális
VOLTS/DIV tartomány: 10mV/div+10V/div BNC bemenettel
Választható analóg, sávszélesség limit, jellemző: 20MHz
Alsó frekvenciament (-3db): ≤10Hz a BNC
DC erősítés pontosság: ± 3% normál vagy közepes üzemmód, 10V/div + 10 mV/div
Trigger: Edge
mód: Auto, Normál, Egyedi
Lejtő: Emelkedő, Eső, Emelkedő és Eső
Forrás: CH1, CH2
Bemenet
csatolás: DC, AC vagy GND
Támogatott mérőszonda csillapítási tényezők: 1X, 10X, 100X, 1000X
Hullámforma generátor
Hullámforma frekvencia: Szinusz (1Hz+25MHz), Négyszög (1Hz+10MHz), Fűrészfog (1Hz+1MHz), EXP (1Hz+5MHz)
Szélesség: 2.5Vpp (50Ω) - 5Vpp (magas impedancia)
Kimeneti impedancia: 50Ω

Méret: 199 x 98 x 40 mm
Súly: 624g

1760DGT/2 Ft 354.300 1 017600008

1760B

Univerzális digitális multiméter



VÉGREHAJTHATÓ MÉRÉSEK
Feszültség DC: 200 mV-2/20/200/1000V
Feszültség AC: 2-20/200/700V
Áram DC: 2/20/200 mA-20 A
Áram AC: 2/200 mA- 20 A
Ellenállás: 200Ω - 2/20/200 kΩ - 2/20 MΩ
Kapacitás: 2/20/200 nF - 2/200 μF
Hőmérséklet: -20° + 1000°C/ -4 °F ~ +2000°F
Frekvencia: 20kHz
Tápegység: 1 9V-elem (együtt szállítva)

1760B Ft 82.000 1 017600012

17600HM/2

Megaohmméter magasfeszültségű szigetelés vizsgáló

Jellemzők:
• Szigetelés vizsgálat 100 GΩ-ig 1000V feszültség mellett
• Nagy, háttérvilágítású, közvetlen leolvasást lehetővé tévő kijelző
• Vízilátsági védelem osztály: IP67
• Gumí alap a kényelmes kezelhetőség érdekében
• Duplán szigetelt CAT IV 600V, CAT III 1000V csatlakozók
• Elektromos és hibrid járművekhez ideális



Műszaki adatok:

Mérési tartomány
Bázisprecízió
Feszültség AC: 10V - 600V ±(1.5% +5)
Feszültség DC: 0V - ±600V ±(1.5% +5)
Ellenállás: 0.01Ω - 200Ω ±(2% +5)
Szigeteléseszt
@1000V: 0.01 - 100GΩ ±(1.5% +5)
Frekvencia: 1~1KHz ±(0.1% +3)

17600HM/2 Ft 173.700 1 017600027

1760/RMS

Diódateszt 3V DC $\pm 10\%$ rdg

EN61010-1
EN61326-1



CE

Mérési tartomány
Feszültség AC/DC 110mV - 600 V $\pm 0,8\%$ - $\pm 2\%$ rdg
Áramerősség AC/DC 110 μ A - 10A $\pm 1,5\%$ - $\pm 2\%$ rdg
Ellenállás 110 Ω - 40M Ω $\pm 1,2\%$ - $\pm 2,5\%$ rdg
Kapacitás 11nF-40nF $\pm 5\%$ - $\pm 10\%$ rdg (11mF-ig)
Frekvencia 1100 Hz - 110 MHz $\pm 1,2\%$ - $\pm 1,5\%$ rdg
Hőmérséklet - 32 °C - 1000 °C $\pm 3\%$ - $\pm 5\%$ rdg
Diódateszt 3V DC $\pm 10\%$ rdg
Folytonosság teszt <30 Ω

1760/RMS Ft 140.900 1 017600020

1760S

digitális multiméter, kompakt kivitel

TRUE RMS (effektív érték) mérés



CE

Végrehajtható mérések:
Feszültség DC: 200 mV-2/20/200/600V
Feszültség AC: 100/600 V
Áram DC: 200 mA-10 A
Áram AC: 0,01-10 A
Ellenállás: 200 Ω - 2/20/200 k Ω - 2 M Ω
Dióda mérés: 0,4 \div 0,7
Tápellátás: 2 db 1,5V elem, AAA

1760S Ft 40.500 1 017600022

153x75x42 mm

1760PA/80

AC/DC Lakatfógo 80A

Speciális készülék a járművek alacsony áramvesztés vagy áramfelvétel mérésére



CE

1760PA/80 Ft 105.700 1 017600002

1760PA/AC

Lakatfógo

A: AC
V: AC/DC

CE



PARAMÉTEREK
Feszültség DC 400 mV - 4/40/400/600 V
Feszültség AC 400 mV - 4/40/400/600 V
Váltóáram AC 40/400/1000 A
Ellenállás 400 Ω - 4/40/400 k Ω - 4/40 M Ω
Frekvencia 5/50/500 Hz - 5/50/500 kHz - 5/10 MHz
Teljesítmény 40/400 nF - 4/40/100 F
Hőmérséklet - 20 °C 1000 °C / - 4 °F 1832 °F
Áramforrás 1 9V-elem (együtt szállítva)

1760PA/AC Ft 86.450 1 017600050

1760PA/AC-DC

Lakatfógo és digitális multiméter

A: AC/DC
V: AC/DC

CE



A: AC/DC
V: AC/DC

VÉGREHAJTHATÓ MÉRÉSEK:
Feszültség DC: 0.1mV \div 600V
Feszültség AC: 0.1mV \div 600V
Áram AC: 0.01A \div 1000A
Áram DC: 0.01A \div 1000A
Ellenállás: 0.1 Ω \div 40M Ω
Teljesítmény: 0.001nF \div 40 μ F
Frekvencia: 0.001kHz \div 4kHz
Hőmérséklet: -40°C \div 1000 °C
-40°F \div 1832°F

1760PA/AC-DC Ft 156.700 1 017600000

1760PA/AC-DC2000

lakatfógo és digitális multiméter Bluetooth csatlakozással

TRUE RMS funkció AC tartományban

A: AC/DC
V: AC/DC

CE



Végrehajtható mérések:
• Feszültség DC: 0.1mV \div 1000V
• Feszültség AC: 0.1mV \div 1000V
• Áram AC: 0.01A \div 2000A
• Áram DC: 0.01A \div 2000A
• Ellenállás: 0.1 Ω \div 60M Ω
• Teljesítmény: 1nF \div 6000 μ F
• Frekvencia: 10kHz \div 20kHz
• Hőmérséklet: -20 °C \div 1000 °C
-4 °F \div 1832 °F
• Tápellátás: 3 db 1,5V elem, AA (a csomag tartalma)
• Bluetooth kapcsolat (4.0 verzió)

H mm 300 L mm 110 P mm 43 Ft 308.900 1 017600003
380x280x100 mm - 1,78 kg

1760DGT-R3

póthegek digitális multiméterekhez és lakatfóókhoz



1760DGT-R3 Ft 10.950 1 017600603

1760/RSE

jeldetektor

Lehetővé teszi a részegységek, így a közös nyomócsöves elektronikus injektorok, benzin/LPG elektronikus injektorok, piezoelektromos injektorok, áramlásszabályozó szolenoid szelepek, EGR szolenoid szelepek és tekercsek tápellátásának tesztelését



A villamos rendszer egyes részeinek diagnosztizálásához a szondát csak az ellenőrizendő komponens közelébe kell tartani. A vezérlőegységgel ellátott elektromechanikus/elektronikus komponenseket tartalmazó rendszerben az eszköz a következők ellenőrzését teszi lehetővé:

- a vezérlőegység tápellátása és a vezérlőfunkciók megfelelő működése
- a vezérlőegység és vezérelt komponens közötti kábelek hatékonysága
- a tesztelt komponens nincs-e kikapcsolva
- a komponens esetleges rövidzárata
- a komponens megfelelő elektronikus működése

1760/RSE Ft 219.400 1 017600170



Beta



1760/TC2

Digitális fordulatszámérő műszer



A műszerrel mérhető:

- Fordulatszám (Fordulat/perc-RPM)
- Forgási sebesség (Fordulat/perc-RPM)
- Kerületi sebesség (m/perc vagy ft/perc)
- Műszaki adatok
- LCD kijelző (1-5)
- Méréstartomány:
- Abstand 2,5 + 99.999 fordulat/perc
- Érintkezési csúcsos mérés 0,5 + 19.999 fordulat/perc
- Kerületi sebesség 0,05 + 1.999,9 m/perc
- Érzékelési idő: 0,8 mp
- Tápegység: 4 db 1,5 V-os elem (AA) vagy 6 V (külön kell megrendelni)
- Együtt szállítva:
- Adapter érintkező csúcsos méréshez
- Külső (érintkező) gumicsúcs 2 db
- Belső (érintkező) gumicsúcs 1 db
- Kerületméréshez 1 db kerék
- Fényviszaverő címke
- Gépkönyv
- Műanyag tok

1760/TC2 L 230 mm H 74 mm Ft 109.700 1 017600161

1760R/TC2

Fényviszaverő címke 1760/TC2 modellhez



1760R/TC2 Ft 9.720 1 017600561

1760K

AC érintés nélküli feszültségérzékelő, mini LED lámpával

tartomány: 200 - 1000 Vac 50/60Hz
 CAT III - 1000 V
 2 db AAA elemmel működik (együtt szállítva)



1760K Ft 17.600 1 017600140

1760PT/N

Feszültség és folytonosság teszt, 1000V

önteszt funkció: az eszköz nem igényel magas feszültséget a kalibrálásához



Jellemzők

- Feszültség: 24+1000VAC / 6+1000VDC
- Oszlopos feszültség megjelenítés: 6-12-24-50-120-230-400-690-1000
- Pontosság: ± (3% + 3V)
- Válaszidő: < 1s (09%)
- Maximum áramelnyelés 1000 V-on: < 3,5mA
- Érintésmentes feszültség észlelés: > 90VAC
- Fázisforgatás teszt: 100+1000VAC (50/60Hz)
- Fázisetelődés: 120° ±5°
- Folytonosságteszt: 0±1.3 MΩ
- Áram (folytonosságteszt): ≤5 μA
- Szennyezési szint:
- Tápfeszültség:

1760PT/N H 250 mm L 70 mm P 30 mm Ft 53.450 1 017600155

1760/IR500

digitális infrahőmérő kettős célzólézerrel

nem alkalmas testhőmérséklet mérésére



MŰSZAKI ADATOK

Hőmérséklet-tartomány: -50 + 500 °C (-22 + 932 °F)
 Hőmérséklet kijelzési lépték: 0,1 °C (0,1 °F)
 Emissziófaktor: 0,1 + 1 állítható
 Pontosság: -50 °C + 20 °C (+/- 3 °C); 20 + 500 °C (+/-2% vagy 2 °C)
 Távolság/mért felület aránya (D:S): 12:1
 Automatikus kikapcsolás: kb. 10 másodperc
 Működési hőmérséklet tartomány: 0 °C + 50 °C
 Tárolási hőmérséklet: -20 °C + 60 °C
 Tápellátás: 1 db 9V elem

1760/IR500 Ft 75.500 1 017600350

1760/IR1000

digitális infrahőmérő kettős célzólézerrel

nem alkalmas testhőmérséklet mérésére



CE

MŰSZAKI ADATOK

Hőmérséklet-tartomány: $-50\text{ }^{\circ}\text{C} + ^{\circ}\text{1000 }^{\circ}\text{C}$ ($-58\text{ }^{\circ}\text{F} + ^{\circ}\text{1832 }^{\circ}\text{F}$)
Hőmérséklet kijelzési lépték: $0.1\text{ }^{\circ}\text{C}$ ($0.1\text{ }^{\circ}\text{F}$)
Emissziófaktor: $0.1 + 1$ állítható
Pontosság: $-50\text{ }^{\circ}\text{C} + 20\text{ }^{\circ}\text{C}$ ($\pm 3.5\text{ }^{\circ}\text{C}$); $20\text{ }^{\circ}\text{C} + 300\text{ }^{\circ}\text{C}$ ($\pm 1\%$ vagy $1\text{ }^{\circ}\text{C}$); $300\text{ }^{\circ}\text{C} + 1000\text{ }^{\circ}\text{C}$ ($\pm 1.5\%$)
Távolság/mért felület aránya (D:S): 20:1
Működési hőmérséklet tartomány: $0\text{ }^{\circ}\text{C} + 50\text{ }^{\circ}\text{C}$
Tárolási hőmérséklet: $-10\text{ }^{\circ}\text{C} + 60\text{ }^{\circ}\text{C}$
Tápellátás: 2 db 1,5V AAA típusú elem

1760/IR1000 Ft 124.700 1 017600400

1760/IR1600

lézeres digitális infrahőmérő Lézerpointerrel

nem alkalmas testhőmérséklet mérésére



CE

MŰSZAKI PARAMÉTEREK

Mérési tartomány: $-50\text{ }^{\circ}\text{C}$ - $1600\text{ }^{\circ}\text{C}$ / $-58\text{ }^{\circ}\text{F}$ - $2912\text{ }^{\circ}\text{F}$
Mértékegység: $^{\circ}\text{C}/^{\circ}\text{F}$
Mérési pontosság: $\pm 1,5\%$ vagy $\pm 2\text{ }^{\circ}\text{C}$ $20\text{ }^{\circ}\text{C}$ -nál
Lézer teljesítmény: $<1\text{mW}$
Visszajelzés: 1 másodperc
Emissziófaktor: 0,10-1,0 beállítható
Távolság/mért felület aránya: (D:S) 50:1
Üzemeltetési hőmérséklet: $0\text{ }^{\circ}\text{C} + 50\text{ }^{\circ}\text{C}$ / $32\text{ }^{\circ}\text{F} + 122\text{ }^{\circ}\text{F}$
Relatív páratartalom: 10%-90% RH
LCD-kijelző rejtett világitással
Adatmegőrző funkció
Automatikus kikapcsolás
Áramforrás: 1 9V-elem (együtt szállítva)
Védőburkolat háromlábú alumínium állvánnyal
Használati utasítás

1760/IR1600 mm mm Ft 348.600 1 017600461

1760LX

hordozható digitális luxmérő

EN61010-1
EN61326-1



CE

Műszaki adatok:

Mérési tartomány Alapvető pontosság
Lux mérési tartomány: $0-200000\text{ } \pm 3\%$
FC mérési tartomány: $0-20000\text{ } \pm 3\%$
Tápellátás: 1 x 9V

1760LX L mm Ft 47.550 1 017600820

1760TMC

infravörös hőkamera

kompakt hőkamera érintésmentes hőmérséklet méréshez, alkalmazható az építőiparban, mechanikus, elektromos és fűtőberendezéseknél

LCD TFT kijelző, 2", 240x320
érzékelő, 32x32 pixel
adat rögzítési frekvencia 7Hz
érzékenység $<347\text{mK}$
forró és hideg pontok automatikus rögzítése
képfarmat: .bmp (max. 100 kép)
állítható emissziós tényező
tápellátás: 3 AAA alkáli elem
USB interfész
IP54
hőmérséklettartomány: $-20\text{ }^{\circ}\text{C} + ^{\circ}\text{600 }^{\circ}\text{C}$
infravörös sáv: $6.5\text{ } \pm 14\mu\text{m}$
látható és infravörös kép egyesítés: 0,5; 1; 2m
riasztás funkció, elfogadható maximum- és minimumhőmérséklet választás



CE

1760TMC 600 Ft 399.200 1 017600710

1760WM

digitális légkereskes légáramlásmérő

EN61010-1
EN61326-1



CE

Műszaki adatok:

Mérési tartomány Alapvető pontosság
m/s légsebesség tartomány: $0.4-30\text{ } \pm 2\%$
k/n légsebesség tartomány: $1.4-108\text{ } \pm 2\%$
ft/m légsebesség tartomány: $80-5900\text{ } \pm 2\%$
mil/h légsebesség tartomány: $0.8-58\text{ } \pm 2\%$
CFM légáramlás tartomány: $0-99990\text{ } \pm 0.9999\text{ ft}^2$
CMM légáramlás tartomány: $0-99990\text{ } \pm 0.9999\text{ m}^2$
CMS légáramlás tartomány: $0-99990\text{ } \pm 0.9999\text{ m}^2$

1760WM L mm Ft 38.450 1 017600800

1761

huzalfeszítő fogó
automatikus beállással



L mm Ft 30.950 1 017610101

1761RS/1

átfordítható huzalfeszítő fogó
automatikus beállással



L mm Ft 55.250 1 017610130



1762

Bőrlukasztó fogó



Ø mm	L mm	Ft		
2-2,5-3 3,5-4-4,5	210	14.550	2	017620001

1763

autókárpitos kapocsfogó



1763	Ft		
	17.000	1	017630001

1763G/S500

500 autókárpitos kapocs



1763G/S500	Ft		
	31.800	1	017630105

1764/K5

kézi szegecselő műanyag szegecszekhez

4x10 különböző méretű szegeccsel szállítva

készlet tartalma:

- 10 db szegecs, Ø 5x17.2 mm
- 10 db szegecs, Ø 5x15.8 mm
- 10 db szegecs, Ø 6.3x25.2 mm
- 10 db szegecs, Ø 6.6x17.2 mm



1764/K5	Ft		
	24.700	1	017640001

1764/K5-R

20 db műanyag szegecs
a 1764/K5 modellhez



	mm	Ft		
1764/K5-R1	5X17,2	6.760	1	017640003
1764/K5-R2	5X15,8	6.760	1	017640004
1764/K5-R3	6,3X25,2	6.760	1	017640005
1764/K5-R4	6,6X17,2	6.760	1	017640006

1766

Kéttappancsos vákuumos üvegfogó

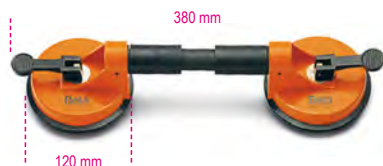

max kg	Ft		
50	57.500	2	017660001

1766A

Egytappancsos vákuumos üvegfogó



max kg	Ft		
30	14.750	2	017660005



1766/8

8 darabos szélvédőkivágó készlet



1766/8	Ft		
	213.800	1	017660100

1766ER

üvegtömítő elem kihúzó
markolattal

lehetővé teszi az üvegtömítő elem hatékony eltávolítását
sérülésveszély nélkül



1766ER	Ft		
	10.300	1	017660501

1766ER/VW

kis profilú üvegtömítő elem kihúzó

elsősorban a VAG csoport
nehezen hozzáférhető üvegtömítőihez

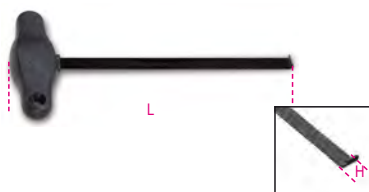

L mm	H mm	Ft		
215	4	7.410	1	017660510

1766I

Külső szélvédőkívágó, fémnyéllel

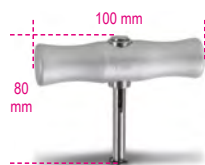

1766I Ft 23.500 2 017660020

1766G

Acélkabel tárcsához

Négyzet keresztmetszetű



50 m Ft 20.650 1 017660025

1766T

acéldrót üvegekhez

háromszög keresztmetszet



50 m Ft 24.100 1 017660026

1767A

teleszkópos rúd

- fáradt támasztóteleszkópos motorháztetők és csomagtartófedelek megtartására
- használható a blokkolt pedálok megtartására



L mm Ft 640 ÷ 1090 32.600 1 017670000

1767B

pedál- és kormányrögítő

az állító mechanizmus pontos beállítást biztosít, amikor a jármű gázpedálja le van nyomva



1767B Ft 69.650 1 017670100

490x285x95 mm - 2,4 kg

1767PMC

Műanyagtálca kis tárgyak elhelyezésére, mágneses, kerek



1767PMC Ft 10.100 1 017670020

1767PMR

Műanyagtálca kis tárgyak elhelyezésére, mágneses, téglalap alakú



1767PMR Ft 20.650 1 017670010

1768

alumínium fellépő küszöb

csúszásmentes bevonattal
maximális teherbírás: 200 kg



L mm Ft 960 89.650 1 017680010
L1 mm 300
H mm 475

1770

Dekorkés extra lapos letörhető pengével, 9 mm széles



1770 L mm Ft 140 7.810 10 017700001
A mm 9

1770A

Dekorkés letörhető pengével 3 tartalékpengével



1770A L mm Ft 135 2.910 10 017700025
A mm 9

1770RL

Letörhető dekokéspenge, 9 mm széles



1770RL Ft 2.590 5 017700010

1771

Dekorkés, 18 mm, 3 tartalékpengével szállítva



1771 Ft 4.410 10 017710000



1771BM

Dekorkés 6 tartalékpengével



1771BM	L mm	A mm	Ft		
	170	18	9.680	10	017710050

1772H

Kés behúzható pengével,
1 tartalék pengével



1772H	L mm	A mm	Ft		
	170	18	8.580	5	017720029

1773S/RL

3 db kerek penge, Ø 28 mm
a 1773S modellhez



1773S/RL	Ft		
	1.780	5	017730110

1771HD

dekorkés, 18 mm,
6 tartalékpengével
• automatikus penge csere
• csavaros rögzítés



1771HD	L mm	A mm	Ft		
	190	18	10.950	5	017710100

1772RL/2

Egyenes hosszított tartalékpenge a 1772H,
1772M, 1772R, 1774, 1777BMT, 1777T típusú
késhez 10 darabos egységcsomagban



1772RL/2	Ft		
	2.060	5	017720017

1773U

többfunkciós szerszám szilikonos munkákhoz

Tartalom:
• 5 különböző elhúzó gumi
• tartalék hántoló penge



	L mm	Ft		
min 190 - max 215		11.150	1	017730500

1771RL

Letörhető dekorkéspenge,
18 mm széles
1771HD



1771RL	Ft		
	3.720	5	017710010

1773A

Dekorkés letörhető
dekorkéspengével, 25 mm széles



1773A	L mm	A mm	Ft		
	180	25	8.580	10	017730000

1773U/R

Tartalék készlet a szilikonos munkákhoz való
1773U többfunkciós szerszámhoz

• 5 db különböző elhúzó gumi
• Tartalék hántoló penge



1773U/R	Ft		
	4.450	2	017730510

1772M

kés behúzható biztonsági pengével
3 pengével szállítjuk

automatikus rugós pengebehúzás
• fröccsöntött fém test
• nyélbe épített kapcsolóhúzó



1772M	L mm	A mm	Ft		
	170	18	8.830	5	017720040

1773RL

Letörhető dekorkéspenge,
25 mm széles



1773RL	Ft		
	8.420	5	017730015

1772R

Behúzható pengéjű kés
5 pengével szállítva



1772R	L mm	A mm	Ft		
	125	18	8.140	5	017720006

1773S

Dekorkés kerek pengével

• Fő penge Ø 28 mm
• Második penge: fóliákhoz
• Függeszűrkampó



1773S	L mm	A mm	Ft		
	190	28	4.010	1	017730100

1774

Hántolókés műanyagból
pengevédővel



1774	L mm	L1 mm	Ft		
	155	60	2.000	5	017740001

1774A

Hántoló bimateriális nyélrel



1774A	L mm	A mm	Ft		
	300	40	6.230	1	017740011

1774A/RL

10 penge a 1774A és 1774S hántolóhoz

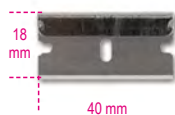

1774A/RL	Ft	1	017740511
	2.960		

1774S

matricakaparó



1774S	A mm	L mm	Ft	2	017740021
	40	100	3.360		

1777BM

Behajtható pengéjű kábelblankoló kés, penge nemesacélból, a kábelek csupaszításához



1777BM	L mm	L1 mm	A mm	Ft	5	017770100
	190	80	16	5.630		

1777T

Behúzható pengéjű kés acélból, 5 tartalékpengével szállítva



1777T	L mm	A mm	L1 mm	Ft	5	017770030
	160	19	65	12.350		

1777BMT

Dekorkés egyenes pengével 4 pozícióba állítható penge 4; 9,5; 15,5; 21,5 mm 3 pengével szállítva



1777BMT	L mm	L1 mm	A mm	Ft	5	017770050
	170	80	19	13.150		

1778AN

behajtható pengéjű kés, rozsdamentes acél penge, könnyű eloxált alumínium markolat • tokban



1778AN	L mm	A mm	L1 mm	Ft	5	017780065
	204	26	84	15.200		

1778AX

behajtható pengéjű kés, fogazott rozsdamentes acél penge, alumínium nyél, könnyebb nyitást biztosító fogazás • tokban



1778AX	L mm	A mm	L1 mm	Ft	5	017780026
	189	26	80	16.400		

1778BS

Behajtható pengéjű kés, kettős biztonsági rögzítővel, fogazott rozsdamentes acél penge, carbon look kivitel



1778BS	L mm	A mm	L1 mm	Ft	10	017780035
	200	29	85	16.400		

1778CM

behajtható pengéjű kés, terepszínű hőkezelt acél penge tokban



1778CM	L mm	A mm	L1 mm	Ft	5	017780099
	195	24	80	15.600		

1778M7

behajtható pengéjű kés, rozsdamentes acél mini penge, üvegszál betétes markolat • tokban



1778M7	L mm	A mm	L1 mm	Ft	5	017780015
	163	24	68	13.350		

1778P

behajtható pengéjű kés, rozsdamentes acél penge, alumínium nyél, nyomógombos nyitómechanizmus • tokban



1778P	L mm	A mm	L1 mm	Ft	5	017780088
	193	29	72	17.800		

1778SCL

behajtható pengéjű kés soft carbon look kivitel penge edzett acélból tokkal szállítva



1778SCL	L mm	A mm	L1 mm	Ft	5	017780089
	180	22	78	14.750		

1778SOS

autós elsősegély kés ablaktörő kalapács és biztonsági öv vágó funkcióval tokban



1778SOS	L mm	A mm	L1 mm	Ft	5	017780080
	205	25	85	15.600		

1778V18

behajtható pengéjű kés
alumínium nyél
• tokban



	L mm	A mm	L1 mm	Ft		
1778V18	195	25	85	14.750	5	017780018

1778X

hajós kés rozsdamentes acélból, alumínium nyéllel



	L mm	L1 mm	S mm	Ft		
1778X	185	85	25	14.150	2	017780050



1778MT – MULTIFUNKCIÓS SZERSZÁM

A BETA multifunkciós szerszámát a BETA-ra jellemző tulajdonságok - a páratlan minőségű fogó, korszerű anyagok és a legújabb technológia - különböztetik meg a kereskedelmi forgalomban kapható más termékektől. A piacon legnépszerűbb kialakítású csavarokhoz való 11 betét minden környezetben és helyzetben - a kempingezéstől a hajózáson és barkácsoláson át a vadászatig - ideális.



22 FUNKCIÓ

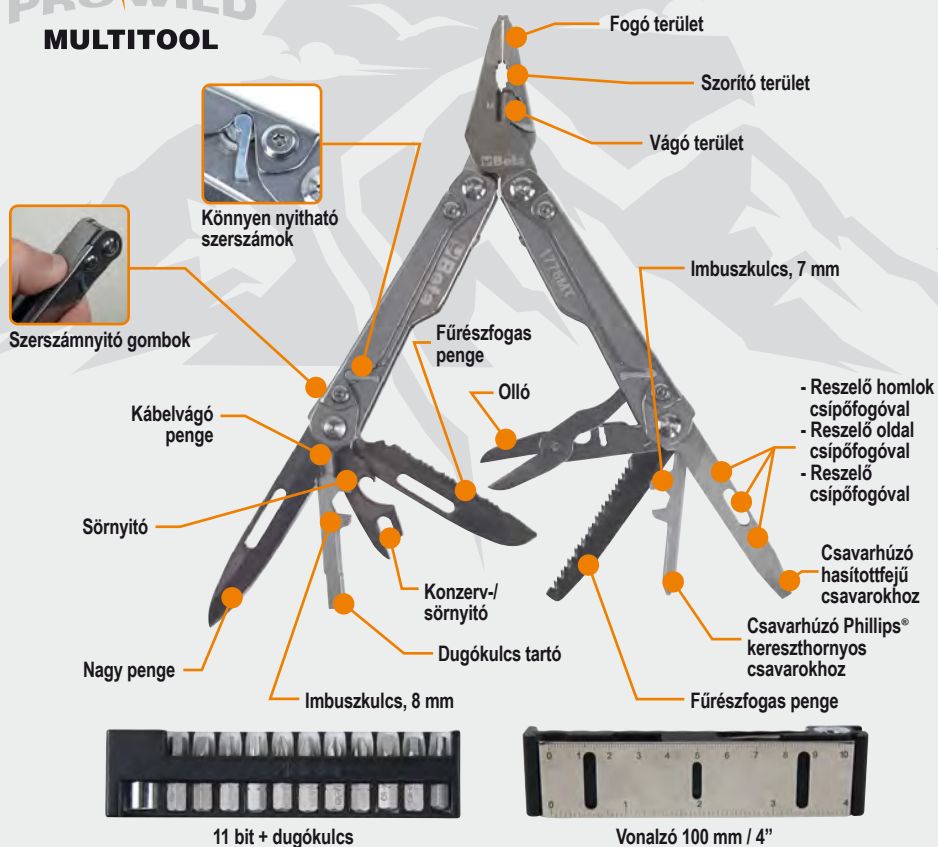

1778MT

multifunkciós szerszám
csavarhúzó betétekkel és tokkal
9 szerszám
22 funkció



	L mm	L1 mm	Ft		
	180	115	46.750	1	017780055

1781

Hosszú élű drótvágó olló, krómozott



	L mm	Ft		
1781	132	8.620	2	017810001

1783

Olló, könnyített kivitel



	L mm	Ft		
	215	7.170	5	017830021
	240	8.020	5	017830024

Beta

1784

Erősített olló, nyél PVC-bevonattal



L	Ft		
mm			
175	10.300	2	017840017
200	13.750	2	017840020
250	18.200	2	017840025
300	24.700	2	017840030

1800/100

Emelőpárna (Max. 100 kg)

- Emel, szinten tart
- Ajtó és ajtószárny rögzítése • Ajtók és ablakok szerelésénél



A	B	S	Ft		
mm	mm	mm			
160	150	2÷55	27.950	3	018000000



Beta



VILÁGÍTÁS

A világítási termékcsalád olyan termékek széles választékát tartalmazza, amelyeket a felhasználók minden igényének kielégítésére terveztek, a kis méretű csövek ellenőrzésétől a nagy munkaterületek megvilágításáig.

ZSEBLÁMPÁK

Az új, magával ragadó kialakítás, a technikai fejlesztések és a nagy méretválaszték lehetővé teszi a legmegfelelőbb zseblámpa kiválasztását olyan kritériumok alapján, mint a fényerő, az akkumulátor élettartama és a teljesítmény.



LÁMPÁK ÉS SPOTLÁMPÁK

A továbbfejlesztett LED-technológiának, az akkumulátorok hosszabb élettartamának, a rövidebb töltési időnek, az anyagokra való alapos odafigyelésnek és az innovatív megoldások folyamatos keresésének köszönhetően a Beta munkalámpái a tervezés, a funkcionalitás és a teljesítmény kiemelkedő kombinációját jelentik. Olyan átfogó termékpalalettát kínálunk, amely célja, hogy a szakemberek a legjobb tudásuk szerint dolgozhassanak, bármilyen szektorban és bármilyen körülmények között.



VEZETÉK NÉLKÜL



Wireless charging

A Beta vezeték nélküli lámpái innovatív megoldást nyújtanak a munkahelyi világításban, megszüntetve a kábelek szükségességét, amelyek zavaróak vagy akár balesetveszélyesek is lehetnek. A termékpalalettában könnyedén tölthető zseblámpák, fejlámpák, hagyományos és LED reflektorok is megtalálhatók, amelyeket a vezeték nélküli töltőállomás segítségével tölthetünk. A falra szerelhető két töltőhelyes állomás nemcsak helytakarékos, de praktikus is, mivel a lámpák mindig elérhetőek maradnak. Továbbá, a töltőállomás egy kihúzható tartóval rendelkezik, amely mobiltelefonok töltését is lehetővé teszi, így még kényelmesebbé téve a munkafolyamatokat. Ez a megoldás különösen hasznos lehet szakemberek számára, akiknek gyakran kell különböző helyeken gyorsan reagálni, és szükségük van megbízható, hordozható világításra.

CRI - Color Rendering Index - Színvisszaadási index

CCT - Correlated Color Temperature - Korrelált színhőmérséklet

SPOT LÁMPÁK

TERMÉK	LUMEN	AKKUMULÁTOR	TÖLTÉSI IDŐ	ÉLETTARTAM	IP/IK	CCT	CRI
1837C/2100	500 - 1000 - 2100	Li-Ion 11.1V; 4400 mAh	4.0h	9 - 2.5h	IP65 - IK07	6500K	80+
1837C/4300	1100 - 2100 - 4300	Li-Ion 11.1V; 5200 mAh	4.0h	6 - 1.5h	IP65 - IK07	6500K	80+
1838FLASH	360 - 720	Li-Ion 7.4 V; 4000 mAh	4.0h	4 - 8h	IP65	6300K	-
1838POCKET	160 - 400 - 800	Li-Ion 3.7 V; 2600 mAh	4.0h	3 - 9h	IP65	6500K	80+

LÁMPÁK

TERMÉK	LUMEN	AKKUMULÁTOR	TÖLTÉSI IDŐ	ÉLETTARTAM	IP/IK	CCT	CRI
1838/11LED	320	Li-Ion 3.7V; 4200 mAh	4.0h	4h	IP65	6500K	
1838AM	60 - 700 120 (spot)	Li-Ion 3.7V; 2600 mAh	4.0h - USB-C	2.5 - 16h 10h (spot)	IP54 - IK07	6500K	80+ 70+
1838COMPACT	120 - 150 - 300	Li-Ion 3.7V; 1500 mAh	2.5h	7 - 6 - 3.5h	IP65 - IK07	6500K	80+
1838PN	120 - 175 - 350	Li-Ion 3.7V; 1600 mAh	3h	6 - 3h	IP65 - IK07	6000 - 6500K	80+
1838SLIM	100 - 200 180 (back) 80 (spot)	Li-Ion 3.7 V; 700 mAh	2.5h - USB-C	2 - 4h 2h (back) 3h (spot)	IP54 - IK07	6500K	80
1838SW	250 - 500 - 1000	Li-Ion 3.6V; 3350 mAh	4.5 - 6.5h	3 - 7h	IP65 - IK07	6500K	80+
1838E	500 - 1000 - 2000	Li-Ion 3.6V; 3350 mAh	4.5 - 6.5h	3 - 9h	IP20 - IK07	5500K	80+

FEJLÁMPÁK

TERMÉK	LUMEN	AKKUMULÁTOR	TÖLTÉSI IDŐ	ÉLETTARTAM	IP/IK	CCT	CRI
1836B	125 - 250	Li-Ion 3.8V; 1600 mAh	3.0h	5h	IP65 - IK07	6000K	80+
1836AW	30 - 200 - 400	Li-Ion 3.7V; 1500 mAh	2.5h	4-18h	IP65 - IK07	6500K	80+

ELEMLÁMPÁK

TERMÉK	LUMEN	AKKUMULÁTOR	TÖLTÉSI IDŐ	ÉLETTARTAM	IP/IK	VILÁGÍTÓ TÁVOLSÁG
1833XS/1	100	1 x AAA	-	5h	IP66	85m
1833XS/2	200	2 x AAA	-	10h	IP66	112m
1833S	500	2 x AA	-	10h	IP66	140m
1833M	700	3 x AAA	-	7.5h	IP66	170m
1833L	1100	3 x AA	-	8.5h	IP66	330m
1833XSW	80 - 250	Li-Ion 3.7V 2600 mAh	2.0 h	2.0-8.0h	IP54 - IK07	50m
1833MW	5 - 30 - 400 - 1000	Li-Ion 3.7V; 2600 mAh	4.0 - 6.0 h	2.0- 200.0h	IP68 - IK07	150m
1833XL	1500	3xD	-	22h	IP66	290m
1837F/USB	600	Li-Ion 3.7 V; 2900 mAh	4.0h - USB-C	10h	IP66	280m

1833XS/1

LED lámpa,
robosztus eloxált alumíniumból

- 100 lumen
- állítható gyújtópont
- elemek: 1xAAA (nem tartozék)
- IP66
- elem üzemidő: 5 óra
- világító távolság: 85 m



L mm 92 Ft 9.390 3 018330000

1833S

LED zseblámpa intenzív fényerővel,
robosztus eloxált alumíniumból,
500 lumenig

- állítható gyújtópont
- 2 fényerősség beállítás
- elemek: 2xAA (nem tartozék)
- elem üzemidő: 10 óra
- IP66
- világító távolság: 140 m



L mm 150 Ft 17.600 1 018330002

1833L

LED zseblámpa intenzív fényerővel,
robosztus eloxált alumíniumból,
1 100 lumenig

- állítható gyújtópont
- 2 fényerősség beállítás
- elemek: 3xAA (nem tartozék)
- alacsony töltés jelző (<15%)
- elem üzemidő: 8,5 óra
- IP66
- világító távolság: 330 m



L mm 196 Ft 36.850 1 018330004

1833XS/2

LED lámpa,
robosztus eloxált alumíniumból

- 200 lumen
- állítható gyújtópont
- elemek: 2xAAA (nem tartozék)
- IP66
- akkumulátor üzemidő: 10 óra
- világító távolság: 112 m



L mm 133 Ft 10.300 3 018330001

1833M

LED zseblámpa intenzív fényerővel,
robosztus eloxált alumíniumból,
700 lumenig

- állítható gyújtópont
- 2 fényerősség beállítás
- elemek: 3xAAA (nem tartozék)
- alacsony töltés jelző (<15%)
- elem üzemidő: 7,5 óra
- IP66
- világító távolság: 170 m



L mm 162 Ft 22.050 1 018330003

1833XL

LED zseblámpa intenzív fényerővel,
robosztus eloxált alumíniumból,
1 500 lumenig

- állítható gyújtópont
- 2 fényerősség beállítás
- elemek: 3xD (nem tartozék)
- alacsony töltés jelző (<15%)
- elem üzemidő: 22 óra
- IP66
- világító távolság: 290 m



L mm 300 Ft 46.150 1 018330005

1833XSW

LED lámpa, vezeték nélküli, újratölthető

- Két fényerősség beállítás: LED SMD, 250 - 80 Lumen
- Újratölthető elem: 3.7V 700 mAh, 2.59 Wh Li-ion
- Két töltési mód:
1839BRW vezeték nélküli töltőállomás
USB-C csatlakozós tápegység
- Töltési idő:
vezeték nélküli töltő állomáson: 2 óra
tápegységről: 2 óra
- Elem üzemidő: 2-9 óra
- LED akkumulátor töltöttségi szint kijelző
- Mágneses talp és hátoldal
- Övve csatlakozó
- IP54
- IK07
- USB-C kábellel szállítva



L mm 145 Ft 22.050 1 018330011

1833MW

LED zseblámpa intenzív fényerővel, tölthető,
vezeték nélküli

- Négy fényerősség beállítás: LED SMD, 1000 - 400 - 30 - 5 Lumen
- Újratölthető elem: 3.7V 2600 mAh, 9.62 Wh Li-ion
- Két töltési mód:
1839BRE vezeték nélküli töltőállomás
USB-C kábellel
- Töltési idő:
vezeték nélküli töltő állomáson: 6 óra
USB-C kábellel: 4 óra
- Akkumulátor üzemidő: 2-200 óra
- 3-LED akkumulátor töltöttségi szint kijelző
- Mágneses hátoldal
- IP68
- IK07
- USB-C kábellel szállítva



L mm 160 Ft 40.300 1 018330013

1836AW

tölthető, vezeték nélküli LED fejlámpa,
kettős fényerővel

- kettős világítás:
elől: 3 fényerősség, LED COB, 30 - 200 - 400 lumen
fejlámpa (reflektor): LED COB, 400 lumen
- újratölthető elem: Li-Ion 3,7 V, 1500 mAh, 5,55 Wh
- USB-C csatlakozó
- USB-C kábellel szállítva
- töltési idő: 2,5 óra
- elem üzemidő:
elől: 4-18 óra
fejlámpa (reflektor): 4 óra
- IP 65
- IK 07



1836AW Ft 33.200 1 018360051

1836B

Tölthető LED fejlámpa,
kettős fényerővel és ON/OFF érzékelővel

- Érintkezés nélküli ON/OFF érzékelő
- USB/mini jack kábellel és töltővel szállítva
- 250 lumen
- Működési idő: 3-6 óra
- IP65

CE



1836B	Ft		
	60.100	1	018360200

1837F/USB

Tölthető, mágneses flexibilis lámpa intenzív
fényű LED-ekkel,
robosztus eloxált alumíniumból,
600 lumen

- Állítható fókusz
- 2 fényerősség beállítás
- Működési idő: 10 óra
- Alacsony töltés jelző <15%
- USB-C csatlakozón tölthető
- USB-C kábellel szállítva
- IP66



L	Ft		
460	59.100	1	018370060

1837RB-F/USB

tartalék akkumulátor a 1837F/USB termékhez

1837RB-F/USB	Ft		
	17.400	1	018370960



1838/11LED

Rendkívül nagy fényerejű tölthető LED lámpa
lítium-polimeres akkumulátorral

- Kompakt csúszásmentes gumitest
- Egyszerűen cserélhető homloküveg
- Állítható kampó
- 110-230 Vac töltőkészülékkel
- 340 Lumen
- Fejrérszi led a többirányú világításhoz



1838/11LED	Ft		
	76.100	1	018380111

1838RA/10-11LED

pót tápegység az 1838/10LED és 1838/11LED
lámpához

CE

1838RA/10-11LED	Ft		
	16.000	1	018380903

1838RB/10LED

póttakkumulátor az 1838/10LED és
1838/11LED lámpákhoz

1838RB/10LED	Ft		
	25.700	1	018380902

1838RR/11LED

töltőtálp az 1838/11LED lámpához

1838RR/11LED	Ft		
	17.000	1	018380914

1838RV/11LED

karcvédő üveg a 1838/11LED lámpához



1838RV/11LED	Ft		
	2.350	2	018380905

1838SW

tölthető csuklós LED szerelőlámpa
vezeték nélküli töltővel

- kettős világítás:
- elől: LED COB , 3 fényerősség: 250 - 500 -1000 lumen
- spot (fej): LED SMD, 200 lumen
- újratölthető 3,6V 3.350mAh Li-ion elem
- 2 töltési mód: vezeték nélküli 1839BRW töltő állomás
USB-C csatlakozós tápegység
- töltési idő: vezeték nélküli töltő állomáson 6,5 óra
tápegységről 4,5 óra
- elem üzemidő: elől: 3-5 óra
spot (fej): 7 óra
- 3-LED elem töltöttségi szint kijelző
- 180°-ban elforgatható talp
- csúszásmentes gumitest
- kettős kampó
- 3 mágnes a hátoldalon
- 1 mágnes a talpon
- IP65
- IK07
- USB-C kábellel szállítva



1838SW	L	I	S	Ft		
	260	53	40	44.750	1	018380142



1838AM

tölthető LED szerelőlámpa, kettős fénykibocsátással, csuklós, 180°-ban elforgatható, mágneses forgótalppal és kampóval

- kettős fénykibocsátás: elől: LED COB, 60-700 lumen, potenciométerrel szabályozható spot (fej): LED SMD, 120 lumen, KI-BE kapcsoló
- újratölthető 3,6V 2600mAh Li-ion elem
- USB-C csatlakozó
- 100-240V / 50-60Hz töltővel szállítva
- töltési idő: 4 óra
- elem üzemidő: elől: 2,5-16 óra spot (fej): 10 óra
- 3-LED elem töltöttségi szint kijelző

- csuklós, 180°-ban elforgatható (a tengelyhez képest ± 90°-ban)
- mágneses talp (neodimium mágnes), 90°-ban elforgatható
- forgó alap és kampó

- IP54
- IK07

CE
IP54
IK07



L	I	S	L1	Ft	1	
mm	mm	mm	mm			
1838AM	405	40	45	175	49.800	1 018380400

1838COMPACT

Tölthető, kompakt LED lámpa

- kettős világítás: fő lámpa és reflektor
- 3 fényerősség: fő lámpa COB LED 300 - 120 lumen reflektor SMD LED 150 lumen
- újratölthető akkumulátor: 3.7 V, 1500 mAh Li-ion akkumulátor
- töltési idő: 2,5 óra
- akkumulátor üzemidő: fő lámpa: 7/3,5 óra reflektor: 6 óra
- felakasztható, csúszásmentes, ütészálló gumitest
- 360°-ban elforgatható horog
- 180°-ban elforgatható mágneses talp
- övkapocs/zseb
- IP65 védettség
- IK07 ütészállóság
- USB-C kábel

CE

IP65
IK07



L	Ft	1	
mm			
1838COMPACT	120	28.950	1 018380011

1838PN

Tölthető LED toll lámpa

- kettős világítás: fő lámpa és reflektor
- 3 fényerősség: fő lámpa COB LED 350 - 175 lumen reflektor: SMD LED 120 lumen
- újratölthető akkumulátor: 3.7 V, 1600 mAh Li-ion akkumulátor
- töltési idő: 2,5 óra
- akkumulátor üzemidő: fő lámpa: 6/3 óra reflektor: 6 óra
- mágneses talp
- övkapocs/mágneses zseb
- IP65 védettség
- IK07 ütészállóság
- USB-C kábel

CE

IP65
IK07



L	Ft	1	
mm			
1838PN	175	25.900	1 018380008

1838POCKET

Állítható, csuklós LED zseblámpa kettős világítással, vezeték nélkül tölthető

- Kettős világítás: fő lámpa: LED COB, 3 fényerősség: 160 - 400 - 800 lumen reflektor: LED SMD, 250 lumen
- Világítási szög: fő lámpa: 160° reflektor: 18°
- Újratölthető 3,7V 2600 mAh Li-ion elem
- 2 töltési mód: 1839BRW vezeték nélküli töltőállomás USB-C csatlakozós tápegység
- Töltési idő: vezeték nélküli töltő állomáson 4,5 óra tápegységre 4 óra
- Működési idő: fő lámpa: 3-9 óra reflektor: 4,5 óra
- 3-LED-es elem töltöttségi szint kijelző
- 210°-ban elforgatható
- Csúszásmentes gumitest
- Mágneses talp
- 1 mágnes a talpon
- IP65
- IK07
- USB-C kábelrel szállítva

CE

IP65
IK07



L	I	S	Ft	1	
mm	mm	mm			
1838POCKET	98	82	39	31.350	1 018380080

1838FLASH

Ultrakompakt feltölthető lámpa, legjobb megoldás mindenféle körülmények között.

INTENZÍV EGYENLETES FÉNY: max. fényerő 720 lumen, akkumulátorról és hálózatról egyaránt működtethető
BÁRMILYEN POZÍCIÓBAN RÖGZÍTHETŐ:
-felületekre: három oldalon csúszásmentes gumival vagy 1/4"-os belsőmenetes állvánnyal (Fényképezőgép Standard-állvány)
- fémekre: mágnessel vagy 360°-ban forgó horoggal
KOMPAKT: Csak 85x100x155 mm-es hely szükséges ahhoz, hogy a lámpát a szerszámtáskában is könnyen elhelyezhessük és szűk helyen használhassuk
ROBOSZTUS: Nehéz mechanikai kihívásoknak is megfelel. Tartós, hosszú élettartamú

CE

IP65



L	Ft	1
mm		
1838FLASH	155.500	1 018380300

1838RB/FLASH

Tartalék akkumulátor 1838/FLASH modellhez

L	Ft	1
mm		
1838RB/FLASH	33.800	1 018380930

1837C

tölthető LED reflektor az építőipar számára

- 3 fényerősség
- akkumulátortöltő: bemenet: 100-240V AC - 50/60Hz; kimenet: 15V 1,5A
- töltési idő: 4 óra
- 3-LED töltésjelző
- 180°-ig elforgatható
- IP65 víz- és porvédelem
- IK07 ütészállóság



IP65
IK07

LxHxI mm	Lm	h	Ft		
220x225x70	2100	2.5	87.650	1	018370210
	1000	5.0			
	500	9.0			
266x236.6x59	4300	1.5	128.700	1	018370430
	2100	3.0			
	1100	6.0			

1837C/RA2100-4300

	Ft		
1837C/RA2100-4300	12.550	1	018370970

1837S

háromlábú teleszkópos állvány munkalámpához

- fémből készült
- állítható magasság: 70+155 cm
- A 1837C és 1838FLASH modellel kompatibilis



h cm	Ft		
70±170	28.550	1	018370500

1838E

tölthető motortér bevilágító LED lámpa

- három fényerősség: 500/1000/2000 lumen
 - 360°-ban elforgatható
 - állítható hossz: 116 ± 188 cm
 - alumínium test
 - csúszásmentes gumikampó
 - USB-C töltés
 - 2 töltési mód:
- lámpa USB csatlakozóján keresztül
belső akkumulátor USB csatlakozóján keresztül
- töltővel szállítva
 - bemeneti teljesítmény: 100-240V ~ 50/60Hz
 - kimeneti teljesítmény: DC 5V - 2000 mA
 - elem üzemidő: 3-9 óra
 - IP20
 - IK07

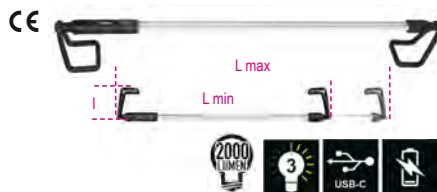

IP20
IK07

L min mm	L max mm	I mm	Ft		
1170	1880	150	85.200	1	018380270

1838E-BT

tölthető akkumulátor az 1838E lámpához,
USB-C csatlakozóval

- Li-Ion 3,6V
- DC 5V - 2000 mA

CE

	Ft		
1838E-BT	24.100	1	018380271

1839BRW

vezeték nélküli töltő állomás,
a 1838POCKET és 1838SW szerelőlámpával
kompatibilis

- két mágneses töltőhely egyidejű használathoz
- kihúzható támasz a vezeték nélküli mobiltelefon töltéshez
- LED töltési állapotjelző
- max. teljesítményfelvétel: 10W x2
- bemenet: AC 100-240V 50/60Hz
- kimenet: DC 12V 1,5A
- DC 9V 2A
- DC 5V 3A
- USB-C csatlakozó
- falra szerelhető: 3 erős mágnes a hátoldalon
2 csavarlyuk

- IP20
- IK07



L mm	I mm	S mm	Ft		
1839BRW	101	290	28	42.300	1 018390002

1839/R5

USB-C QC 3.0 kábel, tartalék a 1838POCKET
és 1839BRW modellhez

	Ft		
1839/R5	3.850	1	018390505

1839/R6

USB Q C3.0 gyors töltő transzformátor, tartalék
a 1838POCKET és 1839BRW modellhez

	Ft		
1839/R6	11.350	1	018390506

1839/R1

USB kimenetes transzformátor, pótalkatrész
az 1833L/USB, 1836B, 1837F/USB,
1838COB, 1838P, 1838S, 1838SLIM, 1838UV,
1838AM, 1838E, 1838COMPACT, 1838PN
lámpához

CE

	Ft		
1839/R1	11.150	1	018390501

1839/R2

USB/jack 3.5 mm-es vezeték, pótalkatrész az
1836B; 1838P; 1838COB; 1838UV lámpához

	Ft		
1839/R2	4.290	1	018390502

1839/R4

USB/USB-C kábel, tartalék a 1833L/USB,
1833F/USB, 1838SLIM, 1838S, 1838AM,
1838E, 1838COMPACT, 1838PN termékhez

	Ft		
1839/R4	3.790	1	018390504



1842LED/BM

nagy fényerejű LED lámpa, 230 Vac

- 10 m vezeték
- kompakt test csúszásálló gumiból
- könnyen cserélhető homloküveg
- állítható horog
- 340 Lumen
- a fejrészen LED a többirányú megvilágításért

CE

IP65



1842LED/BM L mm 230 Ft 62.950 1 018420301

1842LED/ABM

nagy fényerejű LED lámpa, 24 V

- 10 m vezeték
- kompakt test csúszásálló gumiból
- könnyen cserélhető homloküveg
- állítható horog
- 340 Lumen
- a fejrészen LED a többirányú megvilágításért

CE

IP65



1842LED/ABM L mm 230 Ft 59.700 1 018420311

KÁBELDOBOK



A Beta új, változatos és átfogó kábeldobjait úgy terveztük és fejlesztettük, hogy minden szakember igényeit a legmesszebbmenők kielégítsék.

- A kábeldob családban számos különféle hosszúságú és típusú kábel megtalálható, köztük LED lámpával és SCHUKO aljzattal és dugókkal szerelt változatok.
- Tömlődobjainkra 8 mm és 10 mm átmérőjű tömlőket csévélünk.

A nagy ellenállású rugó kiváló tartósságot és kiemelkedően egyenletes csévélést biztosít. A vastag polipropilén dob rendkívül ütésálló.

Az automatikus visszacsévélést leállító retesz könnyen kikapcsolható, lehetővé téve a folyamatos behúzást.

Mindegyik kábeldob 180°-ban elforgatható fali konzolt, valamint a fali tartóra való gyors rögzítést és leszerelést biztosító kiegészítő konzolt tartalmaz.

KÁBELDOBOK

A nem kevesebb, mint 18 változattól álló termékcsaládot úgy terveztük, hogy minden munkahelyzetben megállja a helyét és a legigényesebb felhasználókat is kielégítse. A kábeldobokba modelltől függően 10-30 méteres, 2x1,0 mm² és 5Gx1,5mm² keresztmetszet közötti H05VV-F és H07RN-F típusú kábelek kerülnek. Az összes kábeldob – 3Gx2,5mm² keresztmetszetig – hővédő kapcsolót is tartalmaz, mely az áramkör túlterhelése esetén kapcsol be.



TÖMLŐDOBOK

pag. 339

A pneumatikus szerszámokhoz használható tömlőcsalád 10-15 méteres hosszúságban és 8, 10, illetve 12 mm átmérővel érhető el. A termékeink szívárgásmentesek, ezért vízzel is használhatók.

Termék	Ábr.	Vezetők	Keresztmetszet	Kábeltípus	Hossz	Dob	Hővédő kapcsoló	Tartozék
1842 15-H05/LED	018420821	2x	1,0 mm ²	H05VV-F	15+1 m	Kicsi	NEM	LED lámpa
1843 15-H05	018430215	2x	1,5 mm ²	H05VV-F	15+1 m	Kicsi	IGEN	
1844 10-H05	018440310	3G	1,5 mm ²	H05VV-F	10+1 m	Kicsi	IGEN	-
1844 15-H05	018440315			H05VV-F	15+1 m	Kicsi	IGEN	-
1844 15-H07	018440317			H07RN-F	14+1 m	Kicsi	IGEN	-
1844 30-H05	018440330			H05VV-F	30+2 m	Közepes	IGEN	-
1844 15-H05/SCK	018440316	3G	1,5 mm ²	H05VV-F	15+1 m	Kicsi	IGEN	SCHUKO
1844 15-H07/SCK	018440318			H07RN-F	14+1 m	Kicsi	IGEN	SCHUKO
1845 12-H05	018450365	3G	2,5 mm ²	H05VV-F	12+1 m	Kicsi	IGEN	
1845 15-H07	018450367			H07RN-F	15+1 m	Közepes	IGEN	
1845 25-H07	018450377			H07RN-F	25+1,5 m	Közepes	IGEN	
1846 10-H05	018460405	4G	1,5 mm ²	H05VV-F	10+1 m	Kicsi	NEM	
1846 10-H07	018460407			H07RN-F	10+1 m	Kicsi	NEM	
1846 15-H05	018460415			H05VV-F	15+1 m	Kicsi	NEM	
1847 10-H05	018470420	4G	2,5 mm ²	H05VV-F	10+1 m	Közepes	NEM	
1847 15-H07	018470427			H07RN-F	15+1 m	Közepes	NEM	
1848 10-H05	018480510	5G	1,5 mm ²	H05VV-F	10+1 m	Közepes	NEM	
1848 15-H07	018480517			H07RN-F	15+1 m	Közepes	NEM	



1842

LED lámpával szerelt automata kábeldob,
100-240 Vac

- 230/12V biztonsági transzformátorral
- H05VV-F 2x1,0 mm²kábel
- feltekert kábelhossz: 15 m
- 1,5 m tápkábel SCHUKO csatlakozóval
- dobon kívüli kábel hossza: 1 m
- a reteszelő mechanizmus kikapcsolható, így a kábel folyamatos visszahúzását teszi lehetővé
- 180°-os elforgatható konzollal és kiegészítő gyorscsatlakozó konzollal szállítva

CE



IP42
IP65

L=15 m

1842 15-H05/LED	H05VV-F	L m	Ft	1	018420821
		15+1	157.100		

1846R-LED/BM

LED pótlámpa

12-24 V - AC-DC



1846LED/BM R	Ft	1	018460331
	43.100		

1843

automata kábeldob 2x1,5 mm² kábellel

- H05VV-F 2x1,5 mm² kábel
- hővédő kapcsolóval
- feltekert kábelhossz: 15 m
- dobon kívüli kábel hossza: 1 m
- tápkábel nélkül szállítva
- a reteszelő mechanizmus kikapcsolható, így a kábel folyamatos visszahúzását teszi lehetővé
- max. teljesítmény (felcsévéelve): 1300W (230V-20°C)
- max. teljesítmény (kiengedve): 2300W (230V-20°C)
- 180°-os elforgatható konzollal és kiegészítő gyorscsatlakozó konzollal szállítva

CE



IP42

1843 15-H05	H05VV-F	L m	Ft	1	018430215
		15+1	104.900		

1844

automata kábeldob 3Gx1,5 mm² kábellel

- 3Gx1,5 mm² kábel
- hővédő kapcsolóval
- dobon kívüli kábel hossza: 1 m (kivéve a 1844 30-H05, 2 m)
- tápkábel nélkül szállítva
- a reteszelő mechanizmus kikapcsolható, így a kábel folyamatos visszahúzását teszi lehetővé
- max. teljesítmény (felcsévéelve): 1500W (230V-20°C)
- max. teljesítmény (kiengedve): 2500W (230V-20°C)
- 180°-os elforgatható konzollal és kiegészítő gyorscsatlakozó konzollal szállítva

CE



IP42

1844 10-H05	H05VV-F	L m	Ft	1	018440310
1844 15-H05	H05VV-F	15+1	102.400	1	018440315
1844 15-H07	H07RN-F	14+1	111.300	1	018440317
1844 30-H05	H05VV-F	30+2	196.800	1	018440330

1844SCK

automata kábeldob 3Gx1,5 mm² kábellel és
SCHUKO csatlakozóval

- 3Gx1,5 mm² kábel
- hővédő kapcsolóval
- dobon kívüli kábel hossza: 1 m
- 1,5 m tápkábellel és SCHUKO csatlakozóval szállítva
- a reteszelő mechanizmus kikapcsolható, így a kábel folyamatos visszahúzását teszi lehetővé
- max. teljesítmény (felcsévéelve): 1500W (230V-20°C)
- max. teljesítmény (kiengedve): 2500W (230V-20°C)
- 180°-os elforgatható konzollal és kiegészítő gyorscsatlakozó konzollal szállítva

CE



IP42

1844 15-H05/SCK	H05VV-F	L m	Ft	1	018440316
1844 15-H07/SCK	H07RN-F	14+1	115.800	1	018440318



1845

automata kábeldob 3Gx2,5 mm² kábellel

- 3Gx2,5 mm² kábel
- hővédő kapcsolóval
- dobon kívüli kábel hossza: 1 m (kivéve a 1845 25-H07RN-F, 1,5 m)
- tápkábel nélkül szállítva
- a reteszelő mechanizmus kikapcsolható, így a kábel folyamatos visszahúzását teszi lehetővé
- max. teljesítmény (felcsévéelve): 2000W (230V-20°C)
- max. teljesítmény (kiengedve): 3000W (230V-20°C)
- 180°-os elforgatható konzollal és kiegészítő gyorscsatlakozó konzollal szállítva

CE



IP42

1845 12-H05	H05VV-F	L m	Ft	1	018450365
1845 15-H07	H07RN-F	15+1	210.900	1	018450367
1845 25-H07	H07RN-F	25+1,5	266.400	1	018450377

1846

automata kábeldob 4Gx1,5 mm² kábellel

- 4Gx1,5 mm² kábel
- hővédő kapcsoló nélkül
- dobon kívüli kábel hossza: 1 m
- tápkábel nélkül szállítva
- a reteszelő mechanizmus kikapcsolható, így a kábel folyamatos visszahúzását teszi lehetővé
- max. teljesítmény (felcsévéelve): 1400W (230V-20°C)
- max. teljesítmény (kiengedve): 1900W (230V-20°C)
- 180°-os elforgatható konzollal és kiegészítő gyorscsatlakozó konzollal szállítva

CE



IP42

1846 10-H05	H05VV-F	L m	Ft	1	018460405
1846 10-H07	H07RN-F	10+1	117.400	1	018460407
1846 15-H05	H05VV-F	15+1	117.400	1	018460415

1847

automata kábeldob 4Gx2,5 mm² kábelrel

- 4Gx2,5 mm²kábel
- hővédő kapcsoló nélkül
- dobon kívüli kábel hossza: 1 m
- tápkábel nélkül szállítva
- a reteszelő mechanizmus kikapcsolható, így a kábel folyamatos visszahúzását teszi lehetővé
- max. teljesítmény (felcsévélve): 2000W (230V-20°C)
- max. teljesítmény (kiengedve): 2700W (230V-20°C)
- 180°-os elforgatható konzollal és kiegészítő gyorscsatlakozó konzollal szállítva

CE

IP42



	L m	Ft		
1847 10-H05	H05VV-F 10+1	121.900	1	018470420
1847 15-H07	H07RN-F 15+1	227.100	1	018470427

1848

automata kábeldob 5G2x1,5 mm² kábelrel

- 5Gx1,5 mm²kábel
- hővédő kapcsoló nélkül
- dobon kívüli kábel hossza: 1 m
- tápkábel nélkül szállítva
- a reteszelő mechanizmus kikapcsolható, így a kábel folyamatos visszahúzását teszi lehetővé
- max. teljesítmény (felcsévélve): 1400W (230V-20°C)
- max. teljesítmény (kiengedve): 1900W (230V-20°C)
- 180°-os elforgatható konzollal és kiegészítő gyorscsatlakozó konzollal szállítva

CE

IP42



	L m	Ft		
1848 10-H05	H05VV-F 10+1	127.100	1	018480510
1848 15-H07	H07RN-F 15+1	242.100	1	018480517

1852R1750

hordozható indukciós hevítő készülék



CE

- felmelegíti és kioldja a különösen megszorult csavarokat, anyákat, kerékagyakat és csapágyakat, láng használata nélkül - lehetővé teszi bármilyen ferromágneses fém felmelegítését

Tartozékok:

- két homlokzati tekercs 19 és 26 mm átmérővel anyák kioldásához
- egy lapos fűtőtekercs felületek melegítéséhez
- egy 800 mm hosszú rugalmas fűtőtekercs
- műanyag táskában szállítva

Műszaki adatok:

- bemeneti feszültség: 230V AC, 50/60 Hz
- bemeneti áramerősség: max. 7,5A
- teljesítmény: max. 1.75 kW

OPCIÓK

Ezen kívül további fűtőtekercs méretek is rendelhetők

ELŐNYÖK

Idő megtakarítás: gyors és nagy pontosságú melegítés
Tűzvédelem: nem hoz létre lángot, maximális biztonság a kezelő számára
Praktikus: egy kézzel használható, és a fűtőtekercsek könnyen cserélhetők

FELHASZNÁLÁSI TERÜLETEK

- Autóipar
- Ipari karbantartás
- Légijármű ipar
- Hajóipar
- Petrolkémia ipar

	Ft		
1852R1750	718.600	1	018520175

480x370x130 mm - 4,5 kg

1852S-CNT

tekercs



	Ft		
1852S-CNT	52.850	1	018520520

1852S-CC

tekercs



	Ft		
1852S-CC	42.300	1	018520521

1852S-KR/CNT

tartalék alkatrész készlet tekercshez



	Ft		
1852S-KR/CNT	22.850	1	018520522

1852S-L

oldalsó fűtőtekercs



	Ø mm	M	L mm	Ft		
1852S-L 19	19	M6	220	21.450	1	018520501
1852S-L 20	20	M8	220	21.450	1	018520502
1852S-L 23	23	M10	220	21.450	1	018520503
1852S-L 26	26	M12	220	21.450	1	018520504
1852S-L 32	32	M16	220	21.450	1	018520505
1852S-L 38	38	M20	220	24.500	1	018520506
1852S-L 45	45	M22	220	26.900	1	018520507

1852S-F

homlokzati fűtőtekercs



	Ø mm	M	L mm	Ft		
1852S-F 19	19	M6	220	21.450	1	018520508
1852S-F 20	20	M8	220	21.450	1	018520509
1852S-F 23	23	M10	220	21.450	1	018520510
1852S-F 26	26	M12	220	21.450	1	018520511
1852S-F 32	32	M16	220	21.450	1	018520512
1852S-F 38	38	M20	220	24.500	1	018520513
1852S-F 45	45	M22	220	26.100	1	018520514

1852S-FLESS

Rugalmas tekercs



	L mm	Ft		
1852S-FL750	750	15.800	1	018520519
1852S-FL800	800	40.100	1	018520515
1852S-FL1000	1000	51.400	1	018520517
1852S-FL1500	1500	60.700	1	018520518

1852 S-PIATTE

lapos fűtőtekercs



	Ft		
1852S-PIATTE	24.500	1	018520516



1808

Forrasztópáka acélezott hegygel, komplettírozva egy egyenes kemény hegygel 1824R8



W	V	Ft	1	018080001
20/130	230	38.650	1	018080001

1812 150

pillanatforrasztó páka



W	V	Ft	1	018120015
150	230	55.450	1	018120015

1814M

Forrasztópáka kemény hegygel



W	V	Ft	1	018140225
25	230	31.150	1	018140225
30	230	32.800	1	018140230
40	230	35.600	1	018140240

1820

forrasztópáka



W	V	Ft	1	018200003
1820 30	30W	22.850	1	018200003
1820 60	60W	26.300	1	018200006
1820 80	80W	37.250	1	018200008



1822

nagyteljesítményű forrasztópáka



W	V	Ft	1	018220012
1822 120	120W	56.900	1	018220012
1822 180	180W	60.100	1	018220018
1822 320	320W	74.900	1	018220032

1823 60

digitális vezérlésű forrasztóállomás forrasztópákaival

- Folyamatos hőmérséklet szabályozás 160°C és 480°C között, ±1%-os pontossággal.
- Memória funkció a kikapcsolás pillanatában kijelölt hőmérséklet mentésére.
- 3 gyorsválasztó gomb (200-300-400°C).



W	V	Ft	1	018230060
60	230	219.800	1	018230060

1823R/60

cseré forrasztópáka a 1823 60 modellhez



W	V	Ft	1	018230066
1823R 60	60W	43.500	1	018230066



1824R

Tartalék forrasztópákahegyek

Model	W	V	Ft	1	018240100
1824R 08	8W	230	16.400	1	018240100
1824R 12	12W	230	2.230	1	018240301
1824R 14-M25	14W	230	2.230	1	018240152
1824R 14-M30	14W	230	2.230	1	018240153
1824R 14-M40	14W	230	2.230	1	018240154
1824R 20	20W	230	2.940	1	018240302
1824R 60	60W	230	2.940	1	018240303
1824R 80	80W	230	4.250	1	018240304
1824R 120-180	120-180W	230	34.600	1	018240305
1824R 320	320W	230	43.900	1	018240307
1824R ST-60	60W	230	6.070	1	018240308

1825B

forrasztóon huzal, antioxidáns

- 1mm² huzal, 250g
- Sn 99.3%; Cu 0.7%



Model	W	V	Ft	1	018250251
1825B	250g	230	32.400	1	018250251

1827

Gázzal működő forrasztópáka, beállítható



Model	W	V	Ft	1	018270001
1827	24W	230	69.450	1	018270001

1827PC

Kúpos hegy az 1827-hez



Model	W	V	Ft	1	018270501
1827PC 1,6	1.6mm	230	14.550	1	018270501
1827PC 3,2	3.2mm	230	14.550	1	018270502

1827PCL

Késszerű hegy az 1827-hez



Model	W	V	Ft	1	018270503
1827PCL 2,4	2.4mm	230	14.550	1	018270503

1827PFL

Tartalékhegy az 1827-hez



1827PFL Ft 14.550 1 018270504

1827/K

Gázzal működő forrasztópáka 7 tartozékkal PUR-habszivaccsal bélelt kofferban



- Teljesítmény: 30 Watt-125 Watt
- Forrasztóhegy hőmérséklet beállítható 250 °C-500 °C között
- Gázáteresztés szabályozó
- Felfűtési idő: 15 másodperc a bekapcsolás után
- A tartály 120 percre elegendő gázt tartalmaz
- Áttetsző tartály a gázmennyiség figyeléséhez
- Butángázzal újratölthető

1827/K Ft 107.700 1 018270100

1827F

butángázos forrasztó készülék

tartály 35 g

- három csereszabatos fúvóka, 550°C; 1000°C és 1300°C
- merev táskában, állvánnyal szállítva



1827F Ft 76.300 1 018270200

1830T

Önszipantó antisztatikus hegygel



L mm 190 Ft 8.180 5 018300021



7041LCD/4S

LCD hegesztőpajzs automatikus sötétedéssel, ívhegesztéshez; MIG/MAG, TIG és plazmahegesztéshez.

4 érzékelő

TRUE COLOR szűrő

szolárcellák és lítium akkumulátorok biztosítják az LCD filter áramellátását és hosszú élettartamát

- Látómező: 98x80 mm
- Sötétedési tartomány: 5+8.5/ 9-13, belső beállítás
- UV/IR-védelem: DIN16
- Sötétedési idő: 1/25000 s
- Világosodási idő: 0,1-2,0s
- Állítható sötétedés érzékenység és késleltetés
- Automatikus be- és kikapcsolás
- Köszörülés üzemmód
- Alacsony töltöttség kijelző

- Ergonomikus kialakítás, könnyű súly, kiegyensúlyozott
- Állítható gyűrűsanya



7041LCD/4S Ft 139.700 1 070410001

7041LCD/4S-VE

karcálló üveg a 7041LCD/4S modellhez

7041LCD/4S-VE Ft 3.400 2 070410101

7041LCD/4S-VI

belső üveg a 7041LCD/4S modellhez

7041LCD/4S-VI Ft 1.720 2 070410102

7042LCD

LCD-hegesztő pajzs automatikus sötétedéssel az ívhegesztéshez MIG/MAG; TIG és plazmahegesztéshez.

Áramellátás szolárcellákkal és Lithium-akkumulátorokkal, hosszú élettartamú LCD-filterekkel

- Látómező 98x43 mm
- Sötétedési szakasz DIN 9-13 külső beállítás
- UV/IR-védelem
- Sötétedési idő: 1/25000 s
- Világosodási idő: 0.25-1s
- Sötétedés érzékenysége és késedelve beállítható
- Automatikus be- és kikapcsolás
- Köszörülési üzemmód
- Optimális forma problémamentes légzés



7042LCD Ft 97.950 1 070420001

7042LCD/RV

karcálló üveg a 7042LCD, 7043 modellhez

7042LCD/RV Ft 1.540 2 070420101

7042LCD/RV-INT

belső üveg a 7042LCD, 7043 modellhez

7042LCD/RV-INT Ft 1.360 2 070420102

7043

LCD hegesztőpajzs automatikus sötétedéssel, ívhegesztéshez; MIG/MAG, TIG és plazmahegesztéshez, napelemes tápegység

- látómező: 92x43 mm
- sötétedési tartomány: DIN 9-13, külső beállítás
- UV/IR védelem
- sötétedési idő: 1/1000 s
- világosodási idő: 0,1-1,0 mp
- állítható sötétedés késleltetés
- automatikus be- és kikapcsolás
- köszörülés üzemmód
- az optimalizált kialakításnak köszönhetően könnyebb lélegezni leeresztett rostállyal



7043 Ft 56.900 1 070430001

Járműjavító szerszámainkat, amelyeket a legigényesebb szakemberek használnak, a világ legmagasabb követelményeinek megfelelően fejlesztettük és gyártottuk, és rendszeresen teszteljük a legnagyobb terhelést jelentő üzemi körülmények között.

Több mint 50 éve büszkén dolgozunk együtt a legnagyobbakkal, akik segítenek termékeink folyamatos fejlesztésében és biztosítják a legmagasabb minőségi színvonalnak való megfelelést.

A járműjavító eszközök az alábbi szakaszokban találhatóak:

DIAGNOSZTIKA	
	1464T/N - 1465 1498SM - 1499 1758VT - 1760/IR 1600
MOTOR	
	955 - 960SN 1440 - 1462/KEP 1472 - 1485TC 1737 - 1759TT
OLAJ ÉS SZŰRŐK	
	1488/1 - 1496/C 1877 - 1889N
ELEKTROMOS RENDSZER	
	1489/33 - 1489Y 1497D - 1497RC
GYORSINDÍTÓK	
	1498BC/12 - 1498DG1100E
ERŐÁTVITEL	
	1884 - 1885/X C60 1438 - 1438DSG 1566N - 1569/F
FELFÜGGESZTÉS	
	1550U - 1567
FÉKEK	
	1466/C5 - 1471T/C5
KEREKEK	
	720MRC - 729T 962 - 989B 1530/C5 - 1531/C7
KAROSSZÉRIA	
	1065F5 - 1068 1302 - 1369/C11 1478 - 1479U/32 1505V - 1539 1763 - 1768
EGYÉB BERENDEZÉSEK	
	1875LT - 3067
EMELÉSTECHNIKA	
	3006 - 3069

1875LT

vizes takarítógép szőnyeghez/kárpithoz

Ideális textil felületek mélytisztításához.

A nagynyomású mosószeres vizet a szennyeződéssel együtt visszaszívja, így a felület szinte teljesen száraz marad.

Kiegészítők:

- 1 tömlő ergonómikus fogantyúval
- 1 adagolóegység
- 2 merev cső
- 1 kis fúvóka
- 1 nagy fúvóka
- 6 méteres hálózati kábel, reteszlelővel

CE



1875LT Ft 268.000 1 018750000

1875SP/K3

kárpittisztító kefe készlet

- 1 lapos kefe Ø 48 mm
- 1 lapos kefe Ø 100 mm
- 1 félgömb alakú kefe Ø 90 mm
- 1/4" gépi dugókulcs

1/4"



ISO 1173 E 6,3

1875SP/K3 Ft 8.620 1 018750010

1877

kocsis fáradtolaj gyűjtő
90 literes tartállyal

- szintjelző
- nagy átmérőjű teknő szűrőcsepegtető ráccsal, úrtartalom 12 l
- pneumatikus tartályürítés 1,8 m hosszú csővel
- szerszámtartó tál

CE



1877 Ft 333.600 1 018770008

1877A

kocsis fáradtolaj gyűjtő/elszívó,
90 literes tartállyal és előkamrával

- szintjelző
- nagy átmérőjű teknő szűrőcsepegtető ráccsal, úrtartalom 12 l
- átlátszó előkamra, úrtartalom 9,5 l
- szívócső hossza 1,8 m
- pneumatikus tartályürítés 1,8 m hosszú csővel
- szerszámtartó tál

A következő tartozékokkal szállítva:

- 1 merev szonda Ø 5x700 mm
- 1 flexibilis szonda Ø 5x700 mm
- 1 merev szonda Ø 6x600 mm
- 1 flexibilis szonda Ø 6x700 mm
- 1 merev szonda Ø 7x700 mm
- 1 flexibilis szonda Ø 8x700 mm
- VW, BMW, CITROËN adapterek

CE



1877A Ft 591.100 1 018770080

1877F

fáradtolaj gyűjtő
1 literes palackokhoz

- egyszerre 4 palackhoz
- 2 db 2 literes marmonkannával szállítva



H mm 405 L mm 270 P mm 240 Ft 45.350 1 018770100

1877P

Kocsis fárdtolaj gyűjtő
polietilén tartállyal

- tartálykapacitás: 40 l
- nagy méretű PP teknő
- szintjelző
- pneumatikus tartályűrités



	H	min-Max	H1	Ft		
	mm	mm	mm			
1877P	1030-1630	900	40	258.300	1	018770180

1878 2

folyadékgyűjtő tartály

- Maximális űrtartalom: 2 l
- Különösen alkalmas
- robogók olajcseréjéhez



	l	H	Ft		
		mm			
1878 2	2	85	6.800	1	018780002

1878 4

folyadékgyűjtő tartály,
hordozható

- motorkerékpárokhoz alkalmazható
- maximális űrtartalom: 4 l
- fröccsenésgátló



	l	H	Ft		
		mm			
1878 4	4	100	14.550	1	018780004

1878 8

folyadékgyűjtő tartály

- motorkerékpárokhoz alkalmazható magasság
- maximális űrtartalom: 8 l



	l	H	Ft		
		mm			
1878 8	8	110	7.690	1	018780008

1878 11

Folyadékgyűjtő tartály

- Max. űrtartalom 11 l
- Folyadékleeresztő csavar
- A belső fal megakadályozza a folyadék kicsapódását szállítás közben



	l	Ft		
1878 11	11	17.200	1	018780011

1878 30

Folyadéktartály

- Maximális űrtartalom: 30 l
- Fröccsenésgátló
- 4 guruló görgő

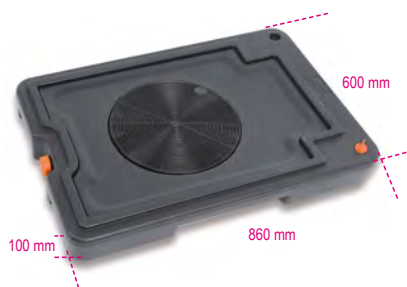

	l	Ft		
1878 30	30	66.600	1	018780030

1879

Kézi és pneumatikus folyadékelszívó, 9,5 l



	l	Ft		
1879 9,5	9,5	143.700	1	018790001

1879 6

kézi folyadékelszívó,
6 l



	Ft		
1879 6	105.300	1	018790000

1879R/K4

4 pótcsőből álló készlet az 1879
folyadékelszívóhoz



	Ft		
1879R/K4	27.950	1	018790504

1879/FUEL

kézi folyadékelszívó,
6 l
szénhidrogénekhez



	Ft		
1879/FUEL	62.350	1	018790010

1880

karos hordópumpa

- olajhoz
- nem használható vízbázisú folyadékokhoz, savakhoz, dízelolajhoz, benzínhez és hasonló folyadékokhoz
- tartozék: hordócsatlakozó, teleszkópos szívószár és kifolyó
- 60, 100 és 200 literes hordóhoz



	gr	Ft		
1880	240	27.100	1	018800001

1880ADB

forgódugattyús AdBlue® szivattyú

- 20 fordulatonként 5 liter átételés
- hordó bővítők 1,20 méterig
- 1 db finom menetes hordó csatlakozó, finom menetes
- 1 nagy menetemelkedésű hordó csatlakozó



1880ADB Ft 62.950 1 018800101

1881

Pneumatikus pumpa 3:1

CE



1881 l/min 18 Ft 231.200 1 018810001

1882N

Olajozó pisztoly flexibilis kifolyóval és csepegésgátlóval



1882N Ft 69.450 1 018820110

1883N

Digitális olajfolyás-számláló



1883N Ft 98.150 1 018830036

1883NC

Adepter, külső menet 1/2"
1882N és 1883N modellehez



1883NC Ft 6.110 1 018830135

1884

Olajfeltöltő berendezés
kézi és automatikus sebességváltóhoz és
differenciálműhöz

Komplett 12 adapterrel a direkt csatlakoztatáshoz



1884 Ft 228.300 1 018840010

AT-101	FORD
AT-102	UNIVERSAL (Bmw, Honda, Nissan...)
AT-103	VW-AUDI
AT-104	VW-AUDI-PORSCHE
AT-105	VW-AUDI-MINI COOPER
AT-106	MERCEDES
AT-107	DSG
AT-108	VW-AUDI CVT
AT-109	VOLVO
AT-110	TOYOTA-LEXUS
AT-111	SKODA
AT-112	VW Passat/Tiguan <2007



1884N/C8

8 darabos adapterkészlet az 1884
berendezéshez

készlet tartalma:

- 1 adapter - Infiniti, 7-sebességes, M8x1.0
- 1 adapter - Honda, Hyundai, Kia 5x8x200 mm
- 1 adapter - Skoda M18x1.5
- 1 adapter - Mini M14x1.5
- 1 adapter - Nissan M10x1.5
- 1 adapter - Nissan Juke M12x1.25
- 1 adapter - GM M12x1.75
- 1 adapter - VAG csoport, 7-sebességes



1884N/C8 Ft 55.450 1 018840200
200x145x40 mm - 400 g

1889N

Acél hordótartó 2 db
200 literes hordó szállítására és raktározására

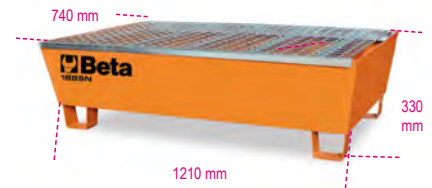

1889N Ft 379.800 1 018890220

1889CF

univerzális kulcs hordók nyitásához

- 1 belső hatszög Ø 38 mm
- 1 profil 4 szegmessel Ø 42 mm
- 1 penge 16,5x4 mm



L mm 270 Ft 16.000 1 018890010

1885

automata sebességváltó karbantartó állomás

Az egyszerű, irányított eljárásnak köszönhetően minden fajta automata sebességváltó teljes mosási ciklusa biztonságosan elvégezhető.

Megakadályozza az automata sebességváltó váltóolajának elöregedéséből eredő károsodását, így könnyen és gyorsan megelőzhető a jellemző meghibásodások, például: zajos váltó, beszülő fogaskerekek, hirtelen kapcsolt fogaskerekek, hosszú váltási idő.



CE



FUNKCIONÁLIS SPECIFIKÁCIÓK

Automata üzemmód

Lépcsőként követhető eljárás integrált adatbázissal

A befecskendezett olaj és kiengedett olaj mennyiségi

kiegyenlítésével biztosítja, hogy a rendszerben mindig azonos mennyiségű olaj legyen

Áramlásmérő az olajmennyiség vizuális nyomonkövetéséhez

Minden műveletről nyomtatható rekord

AUTOMATIKUS SPECIFIKÁCIÓK

Oldószer befecskendezés (opcionális)

Sebességváltó rendszer atmoszája

Olaj leeresztés az olajteknőből

Olaj leürítése a nyomaték váltóból

Olaj befecskendezése a nyomaték váltóba

MŰSZAKI ADATOK

Tápellátás: 220V - 50 Hz

Hátsó megvilágítású olajvizsgáló 2 fehér fényű LED-del

2 digitális mérleg

Digitális mérleg, lépték +/- 10 g

Elektronikus kártya háttérvilágítású grafikus kijelzővel

1885 Ft 4.040.500 1 018850010

1885/C1-R1

Land Rover Freelander sebességváltó alkatrészek a 1885 modellhez
lc01430



1885/C1-R1 Ft 30.150 1 018850111

1885/C1-R2

DP0 sebességváltó alkatrész a 1885 modellhez
lc0990



1885/C1-R2 Ft 52.400 1 018850112

1885/C1-R6

AISIN TG82 sebességváltó alkatrészek a 1885 modellhez
lc01820



1885/C1-R6 Ft 57.900 1 018850116

1885/C1-R8

Renault-Nissan sebességváltó alkatrészek a 1885 modellhez
lc02150



1885/C1-R8 Ft 57.900 1 018850118

1885/C2-R1

Audi 8HP sebességváltó alkatrészek a 1885 modellhez
lc0993



1885/C2-R1 Ft 56.900 1 018850121

1885/C2-R6

Audi Q5-Q7 sebességváltó alkatrészek a 1885 modellhez
lc0680



1885/C2-R6 Ft 54.050 1 018850126

1885/C2-R7

Audi 0B5 sebességváltó alkatrész a 1885 modellhez
lc01720



1885/C2-R7 Ft 32.600 1 018850127

1885/C3-R3

Toyota IQ sebességváltó alkatrészek a 1885 modellhez
lc0991



1885/C3-R3 Ft 57.900 1 018850133

1885/C3-R4

Mazda sebességváltó alkatrészek a 1885 modellhez
lc02130



1885/C3-R4 Ft 57.900 1 018850134

1885/C3-R5

Renault Laguna-Esp sebességváltó alkatrészek a 1885 modellhez
lc02150



1885/C3-R5 Ft 57.900 1 018850135

1885/C3-R6

Nissan Juke sebességváltó alkatrészek a 1885 modellhez
lc02140



1885/C3-R6 Ft 57.900 1 018850136



1885/C3-R7

AISIN TF71 FV sebességváltó alkatrészek a 1885 modellhez
lc01420



1885/C3-R7 Ft 57.900 1 018850137

1885/C3-R8

AISIN TF71 FP sebességváltó alkatrészek a 1885 modellhez
lc001420/1



1885/C3-R8 Ft 57.900 1 018850138

1885/C3-R9

AISIN TF71 FO sebességváltó alkatrészek a 1885 modellhez
lc001420/2



1885/C3-R9 Ft 57.900 1 018850139

1885/C3-R10

AISIN TF71 FS sebességváltó alkatrészek a 1885 modellhez
lc001420/3



1885/C3-R10 Ft 57.900 1 018850140

1885/XC60

Volvo XC60 sebességváltó kiegészítők a 1885 modellhez



1885/XC60 Ft 62.150 1 018850151

1893/134A

automata töltőállomás R134a hűtőközeggel működő légkondicionáló berendezésekhez

Teljesen automatikus modell, gázmennyiségeket tartalmazó személy- és tehergépjármű adatbázissal, kompresszor olaj mennyiségekkel és típusokkal, öndiagnosztizáló szoftver a rutin karbantartási feladatokhoz.

Az adatbázis a szoftveren keresztül frissíthető.

A berendezés mind manuális és teljesen automatikus üzemmódban is üzemeltethető (az első esetben a kezelőnek kell az egyes lépéseket végrehajtani, míg az utóbbi esetben nincs szükség kezelőre).



R134A (250 ml)

CE

FUNKCIONÁLIS SPECIFIKÁCIÓK

Automata üzemmód

Személy- és tehergépjármű lista hűtőközeg mennyiségekkel,

illetve kompresszor olaj mennyiségekkel és típusokkal

A csőben lévő hűtőközeg automatikus visszanyerése

A nem kondenzálható hűtőközeg automatikus leürítése

A csövekben az újratöltött hűtőközeg mennyiség kompenzálása

Meghibásodások és szükséges karbantartások automatikus jelentése

Méret ø 80 mm

Digitális vákuummérő

MŰSZAKI ADATOK

Gáztartály: 15 kg

Vákuumszivattyú: 75 l/perc

Digitális mérleg: 50 kg

Elektronikus kártya háttérvilágítású kijelzővel

Kinyerési sebesség: 500 fordulat/perc

Tápellátás: 220 V

1893/134A Ft 2.939.300 1 018930001



1893/1234YF

automata töltőállomás R1234yf hűtőközeggel működő légkondicionáló berendezésekhez

Teljesen automatikus modell, gázmennyiségeket tartalmazó személy- és tehergépjármű adatbázissal, kompresszor olaj mennyiségekkel és típusokkal, öndiagnosztizáló szoftver a rutin karbantartási feladatokhoz.

Az adatbázis a szoftveren keresztül frissíthető.

A berendezés mind manuális és teljesen automatikus üzemmódban is üzemeltethető (az első esetben a kezelőnek kell az egyes lépéseket végrehajtani, míg az utóbbi esetben nincs szükség kezelőre).



R1234YF (250 ml)

CE

FUNKCIONÁLIS SPECIFIKÁCIÓK

Automata üzemmód

Személy- és tehergépjármű lista hűtőközeg mennyiségekkel,

illetve kompresszor olaj mennyiségekkel és típusokkal

A csőben lévő hűtőközeg automatikus visszanyerése

A nem kondenzálható hűtőközeg automatikus leürítése

A nem kondenzálható hűtőközeg automatikus leürítése

Meghibásodások és szükséges karbantartások automatikus jelentése

Méret ø 80 mm

Digitális vákuummérő

MŰSZAKI ADATOK

Gáztartály: 15 kg

Vákuumszivattyú: 75 l/perc

Digitális mérleg: 50 kg

Elektronikus kártya háttérvilágítású kijelzővel

Kinyerési sebesség: 500 fordulat/perc

Tápellátás: 220 V

1893/1234YF Ft 3.032.400 1 018930012

1893TR/134A

R134a gáz szivárgáskereső



1893TR/134A ml 250 Ft 20.450 1 018930901

1893TR/1234YF

R1234yf gáz szivárgáskereső



1893TR/1234YF ml 250 Ft 23.700 1 018930902

1893TR/CI

hibrid kompresszor jelölő folyadék



1893TR/CI ^{ml} 250 ^{Ft} 24.500 ¹ 018930903

1895GSI

Vezérlőjel generátor (benzines és LPG üzemű) elektronikus befecskendezéshez

A frekvencia és időparaméterek beállítása lehetővé teszi az elektronikus befecskendezők aktiválását, így hatékony diagnosztikát és tisztítást biztosít ultrahangos mosóberendezésekben



Műszaki jellemzők:

- Tápfeszültség: 110V o 220V
- Ellenőrzési idő: 0-99 min.
- Fordulatszám: 600-4000

1895GSI ^{Ft} 66.800 ¹ 018950810

1895/S

1895 típusú ultrahangos mosóberendezéshez való állítható tartó

Segíti az injektorok megfelelő elhelyezését az ultrahangos mosóberendezésben



1895S ^{A mm} 340 ^{B mm} 140 ^{Ft} 51.800 ¹ 018950501

Beta

1895 6

ultrahangos mosótál,
6 literes

speciális gáztalanító funkcióval



- a folyadék fűtésével és az ultrahang alkalmazásával lehetővé teszi az alkatrészek, és általában a fém munkadarabok hatékony tisztítását (befecskendezők, karburátorok, szelepek, stb.)
- digitális kijelző a mosási hőmérséklet és idő beállításával
- kettős mosófunkció: „soft” és „normál”
- egy általános tisztításhoz elég 50/60°C hőmérsékletű víz használata
- egy alaposabb tisztítás érdekében adjon hozzá kifejezetten ultrahangos tálakhoz ajánlott habzásmentes mosóoldatot
- a gáztalanító funkció meggyorsítja a levegő eltávolítását a mosótál teljes térfogatán belül, növelve ezzel az ultrahang hatékonyságát

MŰSZAKI ADATOK

Mosótál térfogat: 6 liter
 Úritó csap
 Teljesítmény: 150 Watt
 Fűtésteljesítmény: 300 Watt
 Hőmérséklet szabályozás: 0+80 °C
 Mosási idő szabályozás: 0-99 perc
 Frekvencia: 40 kHz
 Tápfeszültség: 220/230 V
 Teljes méret: 530x330x380 mm
 Tál mérete: 300x155x150 mm
 Kosár mérete: 250x105x100 mm
 Max. teherbírás: 5,5 kg

1895 6 ^{Max} 5,5 ^{Ft} 338.500 ¹ 018950060

1895 13

ultrahangos mosótál,
13 literes

speciális gáztalanító funkcióval



- a folyadék fűtésével és az ultrahang alkalmazásával lehetővé teszi az alkatrészek, és általában a fém munkadarabok hatékony tisztítását (befecskendezők, karburátorok, szelepek, stb.)
- digitális kijelző a mosási hőmérséklet és idő beállításával
- kettős mosófunkció: „soft” és „normál”
- egy általános tisztításhoz elég 50/60°C hőmérsékletű víz használata
- egy alaposabb tisztítás érdekében adjon hozzá kifejezetten ultrahangos tálakhoz ajánlott habzásmentes mosóoldatot
- a gáztalanító funkció meggyorsítja a levegő eltávolítását a mosótál teljes térfogatán belül, növelve ezzel az ultrahang hatékonyságát

MŰSZAKI ADATOK

Mosótál térfogat: 13 liter
 Úritó csap
 Teljesítmény: 300 Watt
 Fűtésteljesítmény: 400 Watt
 Hőmérséklet szabályozás: 0+80 °C
 Mosási idő szabályozás: 0-99 perc
 Frekvencia: 40 kHz
 Tápfeszültség: 220/230 V
 Teljes méret: 350x325x320 mm
 Tál mérete: 325x235x145 mm
 Kosár mérete: 257x185x100 mm
 Max. teherbírás: 12 kg

1895 13 ^{Max} 12 ^{Ft} 524.300 ¹ 018950130

1895 27

ultrahangos mosótál
27 literes

speciális gáztalanító funkcióval



- a folyadék fűtésével és az ultrahang alkalmazásával lehetővé teszi az alkatrészek, és általában a fém munkadarabok hatékony tisztítását (befecskendezők, karburátorok, szelepek, stb...)
- digitális kijelző a mosási hőmérséklet és idő beállításával
- kettős mosófunkció: „soft” és „normál”
- egy általános tisztításhoz elég 50/60°C hőmérsékletű víz használata
- egy alaposabb tisztítás érdekében adjon hozzá egyedi, ultrahangos tálakhoz ajánlott habzásmentes mosóoldatot
- a gáztalanító funkció meggyorsítja a levegő eltávolítását a mosótál teljes térfogatán belül, növelve ezzel az ultrahang hatékonyságát

MŰSZAKI ADATOK

Mosótál térfogat: 27 liter
 Úritó csap
 Teljesítmény: 500 Watt
 Fűtésteljesítmény: 500 Watt
 Hőmérséklet szabályozás: 0+80°C
 Mosási idő szabályozás: 0-99 perc
 Frekvencia: 40 kHz
 Tápfeszültség: 220/230 V
 Méretek: 530x330x380 mm

1895 27 ^{Max} 25 ^{Ft} 730.800 ¹ 018950270



Beta



1895 157

Ultrahangos mosóberendezés, 13 literes

- A folyadék fűtésével és az ultrahang alkalmazásával lehetővé teszi a fém munkadarabok (hengergej, váltó, katalizátor, stb.) hatékony tisztítását
- AISI304 rozsdamentes acél tartály
- Idő/frekvenciavezérlés
- Hőszabályozó termosztát
- 4 kerék (2 fékező) a mozgathoz
- Tartály tápkábel 3P+N+T (3 fázis + nulla + föld) ipari csatlakozóval
- Vezérlő tápkábel Schuko csatlakozóval



Műszaki adatok:

- Tartálykapacitás: 157 liter
- Űritő csap
- Teljesítmény: 2160 Watt
- Fűtésteljesítmény: 5000 Watt
- Hőmérséklet szabályozás: 30+110 °C
- Mosási idő szabályozás: 0-59 perc
- Dupla frekvencia: 28 kHz and 40 kHz
- Tápfeszültség: 220-380V / 240-415V
- Méret: 840x640x750 mm
- Tartály mérete: 700x500x450 mm
- Kosár mérete: 680x480x200 mm
- Max. teherbírás: 62 kg
- Generátor tápfeszültség: 220 V
- Generátor teljesítmény: 2400 Watt
- Generátor frekvencia: 40 kHz

	L	P	H	Ft		
	mm	mm	mm			
1895 157	840	640	750	3.364.400	1	018950357

9882R



9882R 1 (1-2)	578
9882R 1 (3)	578

1898/K40

kézi alkatrészmosó mechanikus alkatrészek tisztításához, fertőtlenítéséhez, melegített folyadék keringésével

- megtakarítható az oldószerek és szénhidrogének ártalmatlanítási költsége
- a Beta enzim- és baktériumalapú ökológiai tisztítószere eltávolítja az olajmaradékokat a mechanikus alkatrészekből
- az enzimátikus folyamat elősegíti az olajos rész és koszos szilárd rész szétválasztását; a baktériumok szén-dioxidra és vízre bontja, így regenerálva a tisztítószert



BERENDEZÉS:

- hosszúsörtyű ecset és csatlakozó cső
- jobb és bal kézzel üzemeltethető
- perforált rozsdamentes acél rács
- fékező kerekek
- üzemi hőmérséklet kijelzés és alacsony szint figyelmeztetés

EGYÜTT SZÁLLÍTOTT TARTOZÉKOK:

- 2 kanna 20 literes környezetbarát folyékony tisztítószer és 2 csomag baktérium

MŰSZAKI ADATOK

- Max. szivattyú kapacitás: 10 l/perc
- Tartálykapacitás: 40 l
- Üzemi hőmérséklet: +5 °C + +40 °C
- Méretek: 900 x 1000 x 750 mm
- Súly: 50 kg (üresen)

	Ft		
1898/K40	2.166.000	1	018980004

FIGYELEM!

A 1898/K40 termék a következő országokban forgalmazható: Ausztria, Belgium, Franciaország (2021-től), Magyarország, Olaszország, Hollandia, Lengyelország, Portugália, Spanyolország, Egyesült Királyság.

1898/B

egy flakon baktérium, 300 ml az 1898/K40 alkatrészmosóhoz



	Ft		
1898/B	44.550	1	018980904

FIGYELEM:

Az 1898/B termék a következő országokban forgalmazható: Ausztria, Belgium, Egyesült Királyság, Franciaország, Hollandia, Lengyelország, Magyarország, Olaszország, Portugália, Spanyolország

1898/C

Kerekos permetező, 25 l

Számos iparágban és területen alkalmazható: repülőipar, mezőgazdaság, autóipar, takarítás, építkezés és utépités, vegyipar, gyáripár, bányászati, tartálykocsik és ipari járművek, hajóépítés és vasúti szállítás

- kettős funkció: permetezés és habképzés
- festett acéltartály
- rozsdamentes acél fűvoka
- csavarodásmentes tömlő
- tartálynyomásmérő
- tartály szintjelző



Műszaki adatok:

- Tartálykapacitás: 25 l
- Tömlő hossz: 5 m
- Maximális üzemi nyomás: 4-5 bar
- Fűvoka hossza: 0,65 m
- Tartály maximum nyomás: 8 bar

	H	L	P	Ft		
1898/C	810	360	360	115.800	1	018980904

1898/D

20 literes környezetbarát tisztítófolyadék az 1898/K40 alkatrészmosóhoz



	Ft		
1898/D	88.650	1	018980920

FIGYELEM:

Az 1898/D termék a következő országokban forgalmazható: Ausztria, Belgium, Egyesült Királyság, Franciaország, Hollandia, Lengyelország, Magyarország, Olaszország, Portugália, Spanyolország

1895/RC

tartókeret 1895 típusú ultrahangos mosóberendezéshez



	L	L1	A	Ft		
	mm	mm	mm			
1895/RC6	250	105	100	21.450	1	018950506
1895/RC13	257	185	100	33.800	1	018950513
1895/RC27	450	250	150	57.100	1	018950527

9881U



9881U 1 (1-2)	578
9881U 1 (3)	578

1898/M

túlnyomásos permetező
1,5 literes tartállyal

- állítható fúvóka: egyenes sugár - ködpermetezés
- fokozatbeosztás 0,5 l - 1 l - 1,5 l
- egyenes sugárhoz záróbillentyű
- szénhidrogénnel nem használható



H mm	l	Ft		
340	1,5	7.170	1	018980930

1898/S

kézi permetező
5 literes tartállyal

- rozsdamentes acél fúvóka
- egyenes sugárhoz záróbillentyű
- állítható fúvóka: egyenes sugár - ködpermetezés
- vállpánt a könnyű szállításához
- fúvóka beakasztó
- 1,2 méteres tömlő
- szénhidrogénnel nem használható



H mm	l	Ft		
415	5	12.550	1	018980932

1899A

DPF/FAP® rendszer tisztító berendezés

A korom- és hamulerakódás miatt károsodott DPF és FAP® rendszerek időszakos tisztítására és regenerálására szolgáló speciális mosószer



Tartozékok:

- 1 db 2 méteres adagolócső
 - 1 db gyorscsatlakozó + fúvóka a nyomásérzékelőhöz
 - 1 db menetes csőcsatlakozó (M18x1,5) tömlős fúvóka a lambda szonda közvetlen csatlakoztatásához
 - 1 hosszabbító tömlő
 - 1 db DPF/FAP® fúvóka
 - 1 db mágneses lándzsatarató
 - 1 DPF/FAP® vezeték beállító kábellel, tömszelencés menetes csőcsatlakozó (M14/16/18 mm) a lambda szondához
- Műszaki jellemzők:
- Üzemi feszültség: 12 V
 - tápkábel hossza: 3,9 m
 - tartálykapacitás: 1 l

1899A	Ft		
	591.100	1	018990010

1899SI

2-in-1 injektor és szívócsont tisztító berendezés

a gázolaj- és benzinüzemű motorok befecskendezőinek és szívócsontjainak időszakos tisztításához használt speciális mosószerrel eltávolítható a lerakódott szén és égéstermék



- Jellemzők:
- Üzemi feszültség: 12V
 - 2 db tömlő gyorscsatlakozóval
 - 2 tartály (kapacitás: 1 l/tartály)

1899SI	Ft		
	2.210.500	1	018990030

2080/VG

ABS szerszámtáska kifordítható tálcákkal

- Felső rendszerző kis alkatrészeknek (145 mm átmérőjű) és 4 kifordítható tálcá:
- 1 db 305 mm átmérőjű tálca
- 3 db 445 mm átmérőjű tálca
- A 3 nagyobb tálcahoz szállított 12 elválasztóval tálcánként maximum 8 rekesz hozható létre



2080/VG	Ft		
	79.750	1	020800100
	445x445x550 mm	3,4 kg	

2250-0

forgatható ülés tálcával



2250-0	Ft		
	51.200	1	022500011

2251N

forgatható ülés fiókokkal

- forgatható kerek ülőlap, gázdugattyús magasság állítás (445-580 mm)
- négyszögletű szerszámszekerény (380 mm) kétoldalt (2+1) fiókkal
- fiók méret: 350x180x90 mm
- tálca méretek: 2X 190x190mm - 1X 380x190mm
- 4 forgókerék, Ø 75 mm



2251N	L	L1	H min+Max	Ft		
	380	380	445+580	69.000	1	022510012



2252

Kerekos ülőke



2252-G	Ft 86.250	1	022520002
--------	--------------	---	-----------

2252KR4

Tartalékkeerek az ülőkéhez



2252KR4	Ft 28.950	1	022520900
---------	--------------	---	-----------

2258N-0

Gurulós szerelőszek fiókkal



2258N-0	Ft 88.650	1	022580021
---------	--------------	---	-----------

2258RR

Tartalék kerék a 2258N modellhez



2258RR	Ft 4.900	1	022580111
--------	-------------	---	-----------

2254A

autóponyva, kültéri használatra, víztaszító és UV-álló

A ponyva megvédi a javításra váró sérült járművet

Műszaki jellemzők

- UV védelemmel ellátott külső
- puha, nem karcoló belső
- 6 zsinórral biztosítható a ponyva feszes felfekvése
- az első ajtóknál elhelyezett 2 cipzár megnyitásával a ponyva eltávolítása nélkül is be lehet szállni
- tükörzsebek
- tükörzsebek



3 változatban kapható:

- az M méretet kompakt autókhoz ajánljuk
- az L méretet szedánokhoz és kombikhoz ajánljuk
- az XL méretet SUV-okhoz ajánljuk

	LxPxH mm	Ft	1	022540002
/M	4400x1450x1300	72.050	1	022540002
/L	5300x1450x1150	80.550	1	022540000
/X	4700x1450x1580	73.900	1	022540001

2254C

tapadókorongos karosszéria védőpanel

lágysított szövet, a felső részén 4 tapadókoronggal



	L1 mm	L2 mm	Ft	1	022540200
2254C	1150	650	23.700	1	022540200



2254F

személyautó komplett első rész védőtakaró

Lehetővé teszi a jármű teljes elülső részének védelmét, meghagyva a fényszóró és a radiátor nyílásokat



- Vízhatlan
- Olaj és zsír álló
- Rögzítés zsinórok segítségével
- Anyaga: 98% poliamid/nylon, 2% poliuretán

2254F	Ft 40.300	1	022540150
-------	--------------	---	-----------

2254K

Újrafelhasználható ülés, kormány és sebességváltó gomb védőhuzat

A legtöbb jármű üléshez, kormányhoz és sebességváltó gombhoz használható



2254K	Ft 13.750	1	022540101
-------	--------------	---	-----------

2254SM

aláfekvő szivacs, EVA

Kettős kivitel:

- 1 oldal puha EVA
- 1 oldal kemény karbon a jobb csúszásért



2254SM	Ft 31.800	1	022540033
--------	--------------	---	-----------

2254T

térdvédő szőnyeg

Csúszásgátló EVA anyagból



2254T	Ft	1	022540047
	13.950		

3000L

Aláfekvő ágy

- PVC és habosított gumibevonattal, magas komfort

Három állásban rögzíthető fejtámla

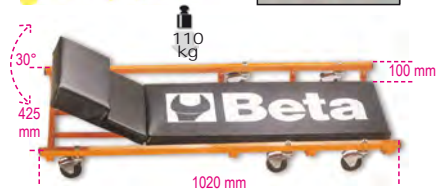

3000L	Ft	1	030000210
	81.550		

3000L/RLS

Tartalékkerekek az aláfekvő ágyhoz



3000L/RLS	Ft	6	030000212
	5.910		

3002

Aláfekvő ágy és ülőke

- Acélváz
- Szivacsos párna PVC-bevonattal
- Gyors átalakítás: aláfekvő ágy vagy ülőke



3002	Ft	1	030020001
	54.050		

3002/RLS

6 pótkerék 3002 aláfekvő ágyhoz



3002/RLS	Ft	1	030020501
	13.950		

3003

Ütésálló műanyag aláfekvő ágy

- Kerék Ø: 76 mm



3003	Ft	1	030030001
	42.100		

3003/RLS

6 pótkerék 3003 aláfekvő ágyhoz



3003/RLS	Ft	1	030030501
	21.850		

3003C

ütésálló műanyag aláfekvő

Részeli:

- szénzásal fej- és derékrész
- felső félemelek mágneses tartozékok tárolására
- 6 db Ø 79 mm gumikerék
- Max. teherbírás: 120 kg
- Súly: 5,5 kg



3003C	Ft	1	030030100
	114.200		

3003C/RLS

6 tartalék kerék a 3003C aláfekvő ágyhoz



3003C/RLS	Ft	1	030030600
	45.750		

3003PRO

ütésálló műanyag aláfekvő

Részeli:

- ergonomikus fejpárna
- puha hátvédő
- 2 db 178 mm kettőscsapágyú kerék az egyenetlen felületeken, csöveken/kábeleken való zavartalan mozgásért
- 1 forgókerék
- két magassági beállítás: 38 vagy 76 mm
- 2 hordozható LED lámpa (250 lumen) rögzítőmágnissal
- teherbírás: 200 kg
- súly: 7,7 kg



C max	H min	H Max	H1	Ft	1	030030150
200	170	230	230	159.900		

3003PRO/SP

falra szerelhető műanyag tartó a 3003PRO aláfekvőhöz

falra, előre, fiókos szekrényre vagy más berendezésre rögzíthető, így az aláfekvő biztonsági zárral felszerelt gyorsrögzítő rendszerhez rögzíthető



3003PRO/SP	Ft	1	030030151
	42.700		

3003PRO/PM

mágneses szerszámtartó, kerék, 3003PRO aláfekvőhöz

az aláfekvő keréktárcsájához rögzítve megtartja a kis tárgyakat



3003PRO/PM	Ft	1	030030152
	4.570		

3003PRO/RCR

hátsó tartalék kerék pár a 3003PRO aláfekvő ágyhoz



3003PRO/RCR	Ft	1	030030650
	33.800		

3003PRO/RRG

első tartalék kerék a 3003PRO aláfekvő ágyhoz



3003PRO/RRG Ft 10.500 1 030030651

3003PRO/RT

LED szerelőlámpa pótmágnesekkel a 3003PRO aláfekvő ágyhoz

- 250 lumen
- Elemek: 4xAAA (nem tartozék)



3003PRO/RT Ft 7.690 1 030030652

3004

kerékék

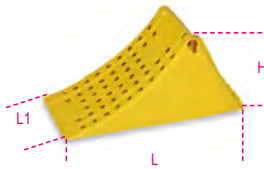

3004 H mm 225 L mm 475 L1 mm 200 Ft 19.250 1 030040000



Beta



JÁRMŰJAVÍTÁS

Járműjavító szerszámainkat, amelyeket a legigényesebb szakemberek használnak, a világ legmagasabb követelményeinek megfelelően fejlesztettük és gyártottuk, és rendszeresen tesztljük a legnagyobb terhelést jelentő üzemi körülmények között.

Több mint 50 éve büszkén dolgozunk együtt a legnagyobbakkal, akik segítenek termékeink folyamatos fejlesztésében és biztosítják a legmagasabb minőségi színvonalnak való megfelelést.

A járműjavító eszközök az alábbi szakaszokban találhatóak:

DIAGNOSZTIKA
1464T/N - 1465 1498SM - 1499 1758VT - 1760/IR 1600
MOTOR
955 - 960SN 1440 - 1462/KEP 1472 - 1485TC 1737 - 1759TT
OLAJ ÉS SZŰRŐK
1488/1 - 1496/C 1877 - 1889N
ELEKTROMOS RENDSZER
1489/33 - 1489Y 1497D - 1497RC
GYORSINDÍTÓK
1498BC/12 - 1498DG1100E
ERŐÁTVITEL
1884 - 1885/X C60 1438 - 1438DSG 1566N - 1569/F
FELFÜGGESZTÉS
1550U - 1567
FÉKEK
1466/C5 - 1471T/C5
KEREKEK
720MRC - 729T 962 - 989B 1530/C5 - 1531/C7
KAROSSZÉRIA
1065F5 - 1068 1302 - 1369/C11 1478 - 1479U/32 1505V - 1539 1763 - 1768
EGYÉB BERENDEZÉSEK
1875LT - 3067
EMELÉSTECHNIKA
3006 - 3069

3006

traktor és markológép kerék emelő és pozicionáló

- legnagyobb teherbírás 1500 kg
- legkisebb kerék átmérő 1000 mm
- legnagyobb kerék átmérő 2200 mm
- legnagyobb kerék vastagság 800 mm

CE



3006 Ft 854.300 1 030060000

3006 R/RGF

fékezhető tartalék kerék a 3006 kerékelőhöz és pozicionáléhoz



3006 R/RGF Ft 32.800 1 030060501

3006 R/RG

tartalék kerék a 3006 kerékelőhöz és pozicionáléhoz



3006 R/RG Ft 28.550 1 030060502

3007

alváz alá illeszthető kocsi első/hátsó mechanika nélküli járművekhez

- elsőhíd vagy hátsóhíd nélküli járművek hatékony mozgásához a munkavégzési fázisban
- 4 elforduló kerék, kettő fékezett, fényzökemencében használható
 - 2 állítható tartóelemmel minden alvázhhoz alkalmazkodik
 - legnagyobb teherbírás 800 kg

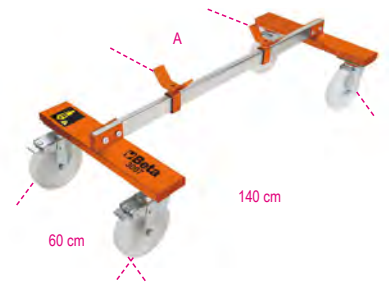

3007 A Max mm 110 Ft 347.400 1 030070001

3007 R/RGF

fékezhető tartalék kerék a 3007 alváz alá illeszthető kocsihoz



3007 R/RGF	Ft	1	030070501
	50.800		

3007 R/RG

tartalék kerék a 3007 alváz alá illeszthető kocsihoz



3007 R/RG	Ft	1	030070502
	44.350		

3008M

kézi teherautókerék emelő és pozicionáló

teherbírás: 136 kg

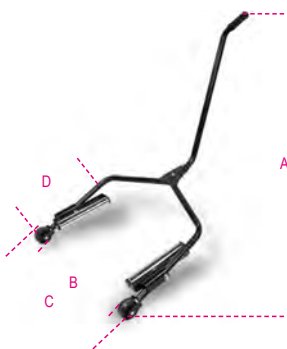

3008M	A	B	C	D	Ft	1	030080210
	1300	600	700	260	57.900		

3008N

szimpla és dupla teherautókerék emelő és pozicionáló

- maximális teherbírás: 500 kg
- legkisebb magasság: 120 mm
- maximális emelési magasság: 650 mm
- görgő tengelytáv: 429+670 mm
- hidraulikus biztosítás túlterhelés esetén
- elforduló első kerekek

CE



3008N	Ft	1	030080110
	1.453.400		

3009

Autóroller balesetben sérült autók mozgatásához

Max. teherbírás 550 kg
4 elfordítható kerék
Hengerszélesség: 200 mm
Max. 240 mm széles autókerékhez

- Alkalmas:
- Balesetben sérült autók vontatásához
 - Autószerelő és karosszériajavító műhelyekben
 - Bemutatótermekben járműmozgatáshoz



A	B	Ft	1	030090001
400÷850 mm	600 mm	201.200		

3009R/GR4

4 darabos kocsi kerékcsoport 3009 R/GR4



3009R/GR4	Ft	1	030090501
	82.200		

3010/T...

1 pár szerelőbak



C max	H min	H max	H1	L	L1
kg	mm	mm	mm	mm	mm
2000	280	425	245	185	165

3010T 2	Ft	1	030100002
	47.350		

C max	H min	H max	H1	L	L1
kg	mm	mm	mm	mm	mm
3000	285	430	250	180	195

3010T 3	Ft	1	030100003
	56.250		

C max	H min	H max	H1	L	L1
kg	mm	mm	mm	mm	mm
6000	400	580	340	245	280

3010T 6	Ft	1	030100006
	81.800		

C max	H min	H max	H1	L	L1
kg	mm	mm	mm	mm	mm
10000	471	735	420	330	290

3010T 10	Ft	1	030100010
	140.900		

3011/T

Hidraulikus emelő

CE



C max	H min	H Max	L
kg	mm	mm	mm
2000	174	369	90

3011T 2	Ft	1	030110020
	42.300		

C max	H min	H Max	L
kg	mm	mm	mm
3500	170	366	86

3011T 3,5	Ft	1	030110035
	47.350		

C max	H min	H Max	L
kg	mm	mm	mm
5000	203	467	118

3011T 5	Ft	1	030110050
	53.250		

C max	H min	H Max	L
kg	mm	mm	mm
10000	220	484	114

3011T 10	Ft	1	030110100
	79.750		

C max	H min	H Max	L
kg	mm	mm	mm
15000	230	497	113

3011T 15	Ft	1	030110150
	97.550		

C max	H min	H Max	L
kg	mm	mm	mm
20.000	245	521	115

3011T 20	Ft	1	030110200
	122.700		

C max	H min	H Max
kg	mm	mm
32.000	260	420

3011T 32	Ft	1	030110320
	127.100		

C max	H min	H Max
kg	mm	mm
50.000	280	450

3011T 50	Ft	1	030110500
	147.000		



3010H

nagy teherbírású tartóbak



C Max kg	H min mm	H Max mm	L mm	L1 mm
15,000	445	631	300	300

	Ft		
3010H631-T15	152.200	1	030100150

C Max kg	H min mm	H Max mm	L mm	L1 mm
15,000	645	1077	300	300

	Ft		
3010H1077-T15	191.100	1	030100165

3010V



C Max kg	H min mm	H Max mm	L mm	L1 mm
20,000	410	600	330	330

	Ft		
3010V600-T20	221.900	1	030100200

C Max kg	H min mm	H max mm	L mm	L1 mm
20,000	665	1090	460	460

	Ft		
3010V1090-T20	281.800	1	030100220

3012

motortartó kengyel



L mm	C max kg	Ft		
1500	500	144.900	1	030120010
1800	400	196.400	1	030120018

3012C

alsó motortartó kengyel

autókhöz és hasznójárművekhez ideális



	Ft		
3012C	383.000	1	030120255

3012I

Motortartó kengyel, alsó

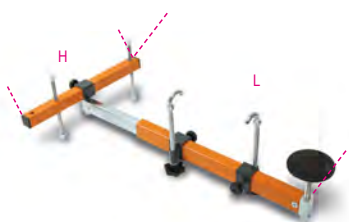

	L mm	H mm	Ft		
3012I	630÷960	190	339.700	1	030120250

3014

Motortartóbak



	Ft		
3014	182.600	1	030140010

3014R/GR5

5 pótkerék a 3014 motortartó állványhoz



	Ft		
3014R/GR5	45.750	1	030140501

3014 SAR

Motortartóbak

- Könnyen kezelhető, helytakarékos
 - A motor és a hajtómű 360°-os elfordítását teszi lehetővé
 - Maximális biztonság és stabilitás
- Max. teherbírás: 450 kg



	Ft		
3014SAR	668.000	1	030140360

3014SAR/RR

4 pótkerék a 3014SAR motortartó állványhoz



	Ft		
3014SAR/RR	72.650	1	030140370

3014SAR/1

Folyadékgyűjtő tartály a 3014 SAR modellhez

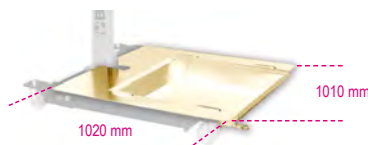

	Ft		
3014SAR/1	196.000	1	030140361

1020x1010x11 mm

3023

hidraulikus hajtómű emelő állító csavarral

maximális teherbírás: 400 kg



	H min-Max mm	Ø mm	Ft		
3023	1350÷2030	300	100.600	1	030230050

3024 0,6

Hidraulikus daru kettős hatású pumpával

Jellemzők:

- Maximális teherbírás: 600 kg
- 5 pozícióba állítható teherkar: 400-450-500-550-600 kg
- Biztonsági szelepes túlterhelés védelem és krómozott állvány
- Szabályozott visszaeresztési sebesség
- Nejlon kerekek
- Maximális emelési magasság: 2300 mm
- Teherkar hatósugara: min. 960 mm – max. 1350 mm
- A szabályozókar 200°-ban elfordítható

CE



H	H1	P	P1	Ft	1	030240006
mm	mm	mm	mm			
1540	2300	925	390	334.000		

3025N

hidraulikus daru kettős hatású pumpával

Specifikációk:

- maximális teherbírás: 1 t
- 4 pozícióba állítható teherkar: 300-600-800-1000 kg
- UL-biztonsági szeleppel és krómozott dugattyúval
- szabályozott visszaeresztési sebesség
- nejlon kerekek
- maximális emelési magasság: 2420 mm

CE



A	B	C	D	Ft	1	030250110
mm	mm	mm	mm			
1560	1600	1000	880	1.032.400		

3025N/PF

hordóemelő

maximális teherbírás: 300 kg

CE



A	B	Ft	1	030250111
mm	mm			
550=640	70	225.500		

3026 0,3

Hidraulikus hajtómű emelő

CE



H min	H Max	L	L1	Ø	Ft	1	030260003
mm	mm	mm	mm	mm			
1120	1970	450	450	25	328.700		

3026/R0,3

4 elforduló pótkerék a 3026 0,3 hidraulikus emelőhöz



Ft	1	030260903
82.600		

3026 0,5

Hidraulikus hajtómű emelő

Max. teherbírás: 500 kg

CE

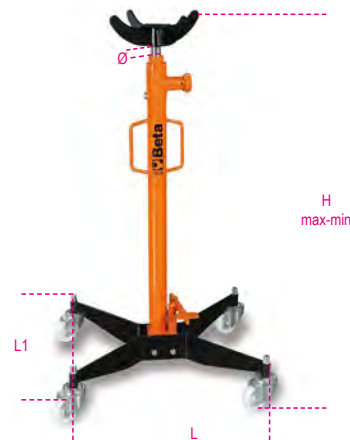

H min	H Max	L	L1	Ø	Ft	1	030260005
mm	mm	mm	mm	mm			
1140	1990	600	550	30	391.100		

3026/R0,5

4 elforduló pótkerék a 3026 0,5 hidraulikus emelőhöz



Ft	1	030260905
115.800		

3026 1,0

hidraulikus hajtómű emelő

Legnagyobb teherbírás 1 t

CE



H min	H Max	L	L1	Ø	Ft	1	030260010
mm	mm	mm	mm	mm			
1140	1990	650	550	35	472.100		

3026/R 1,0

4 tartalék forgókerék a 3026 1,0 hidraulikus emelőhöz



Ft	1	030260910
149.000		



3026/S

Forgatható tartó állítható persellyel a 3026 modellhez

Max. teherbírás: 500 kg

CE



3026/S Ft 277.700 1 030260501

3026/SP

univerzális emelő hajtóművekhez

Lehetővé teszi, hogy a kezelő egyedül, gyorsan és biztonságosan kiszerezje és visszaszerelje a személygépkocsik, haszonjárművek és terepjárók hajtóműveit

CE



3026/SP Ft 323.500 1 030260505

3026/SA

Kerékagy támasz hidraulikus hajtómű emelőhöz

• Kerékagy karbantartáshoz és lengéscsillapító cseréhez
• A 3026 0,3 és 3026 0,5 hidraulikus hajtómű emelőhöz csatlakoztatható



3026/SA Ft 67.400 1 030260510

3026/SAM

Lengéscsillapító támasz hidraulikus hajtómű emelőhöz

• Lengéscsillapítók kitémasztásához a felfüggesztő kar leszerelése esetén
• Lengéscsillapító konzol, max. átmérő 80 mm, kiegészítő adapter max. 60 mm átmérőhöz
• A 3026 0,3 és 3026 0,5 hidraulikus hajtómű emelőhöz csatlakoztatható



3026/SAM Ft 87.250 1 030260515

3027N 10

hidraulikus asztali prés mozgó dugattyúval

• maximális teherbírás: 10 t
• 2 sebességű manuális pumpa
• csúszydugattyú
• automatikus dugattyúvisszavezetés
• V-alakú prizmakészlet
• krómozott állvány

CE



3027N 10 Ft 910.900 1 030270101

3027N 20

hidraulikus prés mozgó dugattyúval

• maximális teherbírás: 20 t
• 2 sebességű manuális pumpa
• csúszydugattyú
• krómozott állvány
• automatikus dugattyúvisszavezetés
• hidraulikus biztonsági reteszelés túlterhelés esetén
• nyomásmérő
• V-alakú prizmakészlet

CE



3027N 20 Ft 1.259.100 1 030270102

3027N 30

Hidraulikus prés mozgó dugattyúval és csőrőlővel

• Maximális teherbírás: 30 t
• 2 sebességű manuális pumpa
• Oldalra mozgatható dugattyú
• Krómozott állvány
• Automatikus dugattyúvisszavezetés
• Hidraulikus túlterhelés ellen védő biztonsági berendezés
• Nyomásmérő
• Acéldrótkötéles csőrőlővel állítható munkalap

CE



3027N 30 Ft 2.206.500 1 030270103

3027N 50

hidraulikus prés mozgó dugattyúval és csőrőlővel

• maximális teherbírás: 50 t
• 2 sebességű manuális pumpa
• csúszydugattyú
• krómozott állvány
• automatikus dugattyúvisszavezetés
• hidraulikus túlterhelés ellen védő biztonsági berendezés
• nyomásmérő
• V-alakú prizmakészlet
• acéldrótkötéles csőrőlővel állítható munkalap

CE



3027N 50 Ft 3.072.900 1 030270105

3027N 100

elektrohidraulikus motoros prés mozgó dugattyúval és csőrőlővel

- maximális teherbírás: 100 t
- 3 fázisú motor: 230-400 V
- frekvencia: 50 Hz
- villanymotor teljesítmény: 3 kW
- 2 sebességű elektrohidraulikus pumpa
- 3 állású karos elosztóval működtethető: beadás-üresjárat-vissza
- Csúszódugattyú
- dugattyú Ø: 100 mm
- a munkalap magassága acéldrótköteles csőrőlővel állítható
- tápkábel 4 pólusú ipari csatlakozóval (380V)
- motorolajjal szállítva

CE

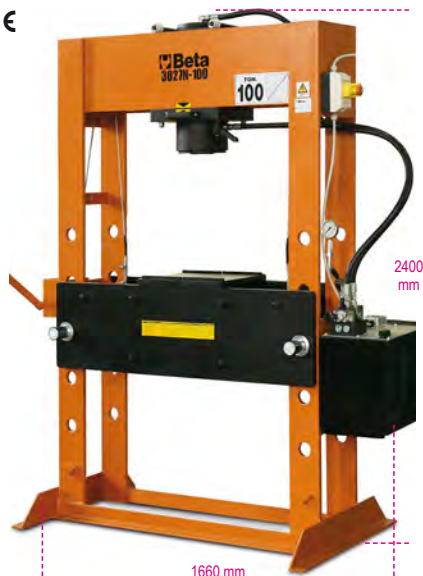

3027N 100 Ft 9.477.700 1 030270110

3027N/KP

Kiűtő készlet és lemez a 3027 modellhez



		Ft		
3027N/KP10-20	3027N10-20	168.800	1	030270511
3027N/KP30	3027N 30	236.000	1	030270531
3027N/KP50	3027N 50	288.700	1	030270541
3027N/KP100	3027N 100	530.400	1	030270552

3027N/KPP

Vezérlőpedál a 3027N modellhez



		Ft		
3027N/KPP10	3027N 10-20-30	180.600	1	030270560
3027N/KPP50	3027N 50	204.900	1	030270565

3027PR/N

Prés tartó szerzsám agy, csapágy és szilentröbök lehúzáshoz/beillesztéshez

Agyak, csapágyak és szilentröbök ki- és beszerelését segítő univerzális eszköz prés alatt végzett munkához, tartóval és királycsapokhoz is alkalmazkodik. A szerzsám szabálytalan formájú agyokhoz/ királycsapokhoz is alkalmazkodik. A 3027N és 3028 préssel együtt használható.



Műszaki adatok:
• Hatósugár: min. 135 mm - max. 150 mm
• Maximális teherbírás: 20 t

	L mm	P mm	Ft		
3027PR/N	250	200	129.100	1	030270410

3028 15

hidraulikus asztali prés mozgó dugattyúval

maximális teherbírás: 15 t
állítható felső rész mozgó dugattyú

CE

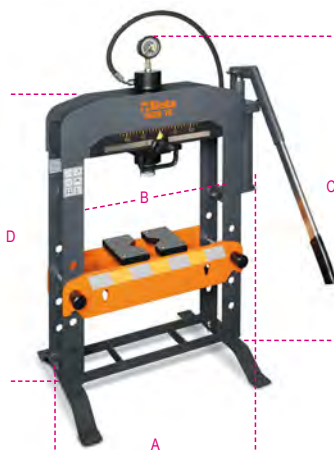

A mm	B mm	C mm	D mm	Ft		
1010	565	480	80+370	493.900	1	030280015

3028SP/15

védőburkolat a 3028 15 préshöz



	Ft		
3028SP/15	71.850	1	030280016

3028 20

hidraulikus prés mozgó dugattyúval

maximális teherbírás: 20 t
függetlenül állítható felső rész csúszódugattyú

CE

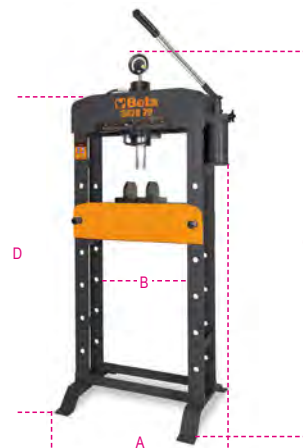

A mm	B mm	C mm	D mm	Ft		
850	540	1830	1602	718.600	1	030280020

3028SP/20

védőburkolat a 3028 20 préshöz



	Ft		
3028SP/20	80.350	1	030280021

3028 30

hidraulikus prés mozgó dugattyúval

maximális teherbírás: 30 t
függetlenül állítható felső rész csúszódugattyú

CE

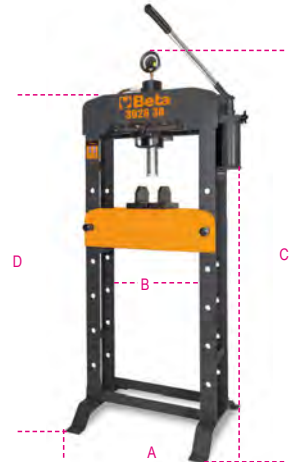

A mm	B mm	C mm	D mm	Ft		
850	540	1850	1650	1.002.000	1	030280030

3028SP/30

védőburkolat
a 3028 30 préshez



3028SP/30 Ft 80.350 1 030280031

3028 50

hidraulikus prés mozgó dugattyúval és
csőrőlóval
maximális teherbírás: 50 t
csőrőlóval állítható felső rész
csúszódugattyú

CE

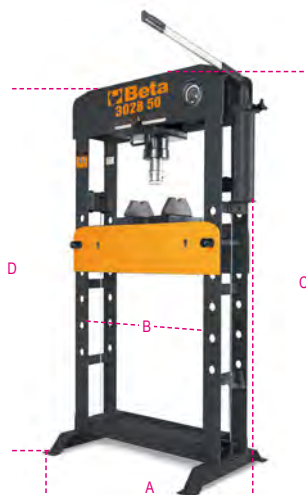

A mm 1100 B mm 750 C mm 1850 E mm 820 Ft 1.753.000 1 030280050

3028SP/50

védőburkolat
a 3028 50 préshez



3028SP/50 Ft 85.200 1 030280051

3028/KP

Kiütő készlet és lemez
a 3028 modellekhez



3028/KP Ft 62.350 1 030280055



3029/2T

2 tonnás, 4 kerek alacsony profilú
hidraulikus emelő

- Gyorspedál
- Acélváz és nejlon kerék
- Legkisebb magasság: 75 mm

CE



3029/2T Ft 200.000 1 030290020

3029L/2T

alacsony profilú hosszú krokodil emelő, 2 t

Lehetővé teszi a munkavégzést olyan alacsony
hasmagasságú járművön, ahol az emelési pont mélyen van.

- Szabályozott visszaeresztési sebesség
- Gyorspedál
- Nejlon kerekek

CE



3029L/2T Ft 231.600 1 030290120

3029/2T-L/RP

85 mm-es tartalék gumipogácsa
a 3029/2T és 3029L/2T emelőhöz



3029/2T-L/RP Ft 7.850 1 030290502

3029/2T-L/R6

tartalék hátsó kerék
a 3029/2T, 3029L/2T, 3030H/2T, 3033E/3T
emelőhöz



3029/2T-L/R6 Ft 25.300 1 030290506

3029/2T-L/R5

tartalék első kerék
a 3029/2T és 3029L/2T emelőhöz



3029/2T-L/R5 Ft 23.700 1 030290505

3029AL/1.5T

Alumínium hidraulikus emelő, 1,5 t

Jellemzők:

- Acélváz
- Praktikus nyél a mozgatáshoz
- Szállításhoz tervezett nejlon táskával
- Nejlon kerekek
- Gumi burkolatú emelőpogácsa

Intenzív használatra nem alkalmas

CE



H min-max 88=358 L 550 L1 240 Ft 196.000 1 030290015

3029AL/1,5T-R1

Első pótkerék a 3029AL/1.5T emelőhöz



3029AL/1,5T-R1 Ft 4.450 1 030290530

3029AL/1,5T-R2

Hátsó pótkerék a 3029AL/1.5T emelőhöz



3029AL/1,5T-R2 Ft 5.340 1 030290531

3029AL/1,5T-RP

Tartalék gumipogácsa a 3029AL/1.5T-RP emelőhöz



3029AL/1,5T-RP Ft 1.780 1 030290532

3030/2T

Hidraulikus krokodilemelő 2T
6 keréssel

- Előli műanyag dupla kerék (PTFE)
- Optimális kezelhetőség nem sík és egyenetlen felületen
- Maximális teherbírás: 2 tonna

CE



3030/2T Ft 380.200 1 030300020
43 kg

3030/2T-R5

csapos első kerék a 3030 2T emelőhöz



3030 2T/R5 Ft 13.350 1 030300505

3030/2T-R6

hátsó pótkerék a 3030/2T emelőhöz



3030 2T/R6 Ft 20.650 1 030300506

3030/2TRP

85 mm tartalék gumilap a 3030/2T-hez



3030/2TRP Ft 2.690 5 030300501

3030H/2T

magas hidraulikus emelő,
2 t, 6 keréssel
lehetővé teszi a padlószinttől magasan elhelyezkedő és nagyobb emelkedésű lengéscsillapítókkal szerelt gépjárművek emelését • szabályozott visszaeresztési sebesség

- gyorspedál
- nejlón kerekek

CE



H min-Max mm 85+780 L mm 1010 L1 mm 300 Ft 318.600 1 030300220

3033/3T

Hidraulikus emelő 3T
hosszú kivitel

- Alkalmos főként kisebb szállító járművekhez
- Max. teherbírás: 3 t
- Poliamid-kerekek

CE



3033/3T Ft 504.000 1 030330030

3033E/3T

hidraulikus emelő,
3 t

- szabályozott visszaeresztési sebesség
- nejlón kerekek

CE



H min-Max mm 95+515 L mm 700 L1 mm 370 Ft 186.600 1 030330130

3033S 3T/R2

első pótkerék a 3033E/3T emelőhöz



3033S 3T/R2 Ft 21.450 1 030330532



Beta

3035

Autókerékszallító kocsi

- Az autókerek könnyen szállíthatók Ø 980 mm-ig
- A robusztus keret lehetővé teszi az autókerek könnyű szállítását, illetve kezelhetőségét
- A rakodófelület vízszintesen is használható és különböző pozícióba állítható
- 2 kerék Ø 260 mm
- 2 kerék Ø 125 mm
- Max. rakodási magasság 1,60 m
- Max. terhelhetőség 200 kg
- 2 pozícióba állítható villák:
- Első pozíció max. távolság 880 mm
- Második pozíció max. távolság 980 mm



3035 Ft 458.700 1 030350100

3036

gumiabroncs szállító/tároló állomás

Nyomot nem hagyó gumikerekek



3036 Ft 54.050 1 030360063

3061/2T

2 tonnás - 2 lépcsős pneumatikus emelő



A következőkkel rendelkezik:

- háromlépcsős nagy ellenállású membrán és belső teleszkópos vezető
- végállási megállító berendezés és biztonsági szelepek túlterhelés esetére
- emelőberendezéseken is használható

MŰSZAKI ADATOK

teherbírás: 2 t
súly 14 kg
üzemi nyomásigény: 8-10 bár
magasság: min.132 - max. 326 mm

3061/2T Ft 426.300 1 030610020

3061/2T-P50

50 mm-es hosszabbító a 3061/2T modellhez



3061/2T P50 Ft 36.250 1 030610021

3061/2T-P100

100 mm-es hosszabbító a 3061/2T modellhez



3061/2T P100 Ft 48.600 1 030610022



3065/20-10T

20-10 t hidropneumatikus emelő szállítótáskával

Hordozható, könnyű, az országoti szervizeknél ideális

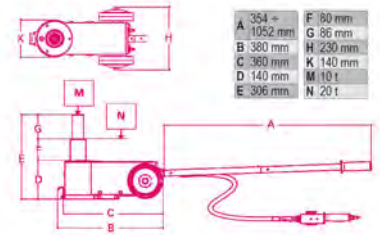

- egy 75 és egy 60 mm-es hosszabbítót tartalmaz

MŰSZAKI ADASTOK

teherbírás: 20-10 tonna
súly: 23 kg
tápnymás: 8-10 bár
levegőfogyasztás: 400 l/perc

3065/20-10T Ft 1.332.000 1 030650100

3065/40-20T

40/20 tonnás hidropneumatikus emelő

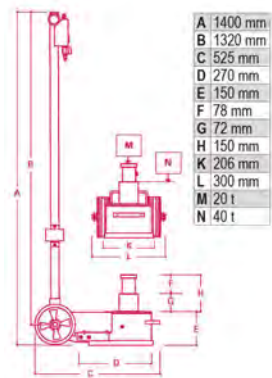

- nehéz hasznongépjárművekhez javasolt
- praktikus és jól szállítható mozgó műhelyekkel is
- automatikus dugattyú visszahúzódnás
- két súlyszétválasztó szelep terhelés alatt sebességellenőrzéssel

MŰSZAKI ADATOK

teherbírás: 40/20 tonna
súly: 39 kg
üzemi nyomásigény: 8-10 bár
levegőfogyasztás 400 l/perc

3065/40-20T Ft 1.417.000 1 030650200

3067/60-15T

60-30-15 t hidropneumatikus emelő

A csak 120 mm legkisebb magasságával különösen alkalmas városi és turista autóbuszoknál, és tömegközlekedési járműveknél történő használatra

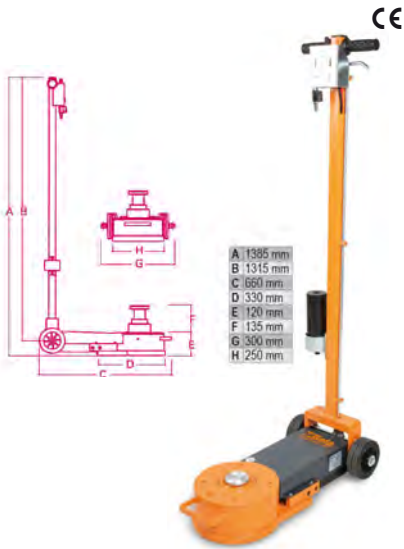

A	1385 mm
B	1315 mm
C	660 mm
D	330 mm
E	120 mm
F	135 mm
G	300 mm
H	250 mm

- automatikus dugattyú visszaállítás
- két súlyszétválasztó szelep terhelési sebesség ellenőrzéssel
- egy 70 és egy 120 mm-es hosszabbítót tartalmaz

MŰSZAKI ADATOK
teherbírás: 60-30-15 tonna
súly: 56 kg
tápnymás: 8-10 bar
levegőfogyasztás: 600 l/p

3067/60-15T Ft 2.089.100 1 030670120

3067/70-13T

70-43-23-13 t hidropneumatikus emelő

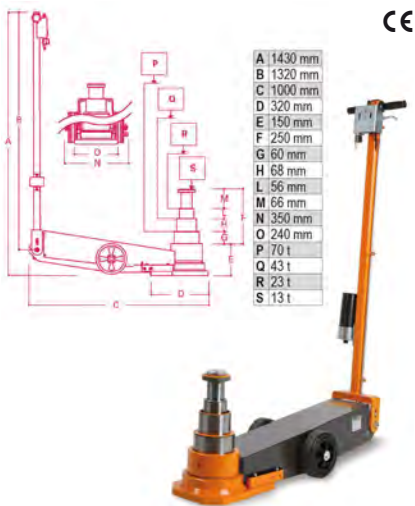

A	1430 mm
B	1320 mm
C	1000 mm
D	320 mm
E	150 mm
F	250 mm
G	60 mm
H	68 mm
L	56 mm
M	66 mm
N	350 mm
O	240 mm
P	70 t
Q	43 t
R	23 t
S	13 t

Hosszú változat, teherautók, nyergesvontatók, autóbuszok és mezőgazdasági gépek esetén történő használatra alkalmas

- automatikus dugattyú visszahúzózás
- két súlyszétválasztó szelep terhelés alatt sebességellenőrzéssel

MŰSZAKI ADATOK
teherbírás: 70-43-23-13 tonna
súly: 74 kg
üzemi nyomásigény: 8-10 bár
levegőfogyasztás 600 l/perc

3067/70-13T Ft 2.631.600 1 030670130

3068

Alacsony villás kézi raklapemelő



Műszaki adatok:

- maximális teherbírás: 2500 kg
- teljes hossz: 1200 mm
- villahossz: 800 mm
- villaszárak távolsága: 540 mm
- villaszélesség: 160 mm
- vonórúd magasság: 1230 mm
- max. emelési magasság: 115 mm

3068 Ft 374.100 1 030680000

3069

Kézi raklapemelő



Műszaki adatok:

- maximális teherbírás: 2500 kg
- teljes hossz: 1550 mm
- villahossz: 1150 mm
- villaszárak távolsága: 540 mm
- villaszélesség: 160 mm
- vonórúd magasság: 1230 mm
- max. emelési magasság: 115 mm
- raklap folyosó méret: 800x1200 hossz: 1805 mm
- fordulási sugár: 1347 mm

3069 Ft 351.800 1 030690000



Beta

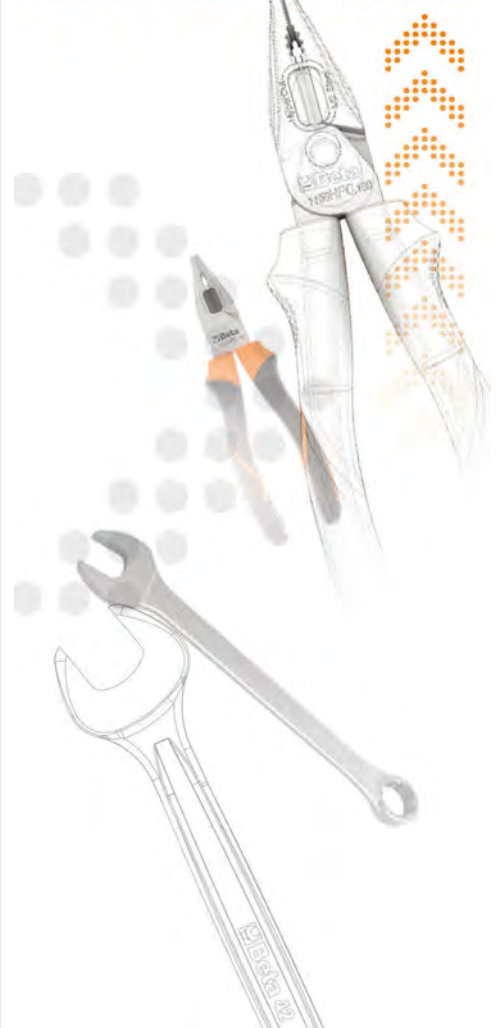



MOTORKERÉKPÁR-SZEREL



A Beta motorkerékpár javító szerszámaikat célzottan a motorkerékpár ipar számára fejlesztették.



3040C

állítható hátsó kerék állvány
motorkerékpárhoz

- Mattfekete lakkozás
- 4 hőkezelt gumikerék
- V-adapterpár
- L-adapterpár



3040C Ft 37.650 1 030400002

3040C/S1

V-adapterpár
a 3040C-hez



3040C/S1 Ft 5.950 1 030400503

3040C/S2

L-adapterpár gumiból
a 3040C-hez



3040C/S2 Ft 8.620 1 030400504

3041C

állítható első kerék állvány
motorkerékpárhoz

- Mattfekete lakkozás
- 4 hőkezelt gumikerék
- Görgős adapterpár
- Kúpos adapterpár



3041C Ft 35.200 1 030410002

3041C/12

Görgős adapterpár
a 3041C-hez



3041C/12 Ft 8.340 1 030410512



3041C/16

kúpos adapterpár
a 3041C-hez



3041C/16 Ft 5.710 1 030410516

3042C

előlső állvány
a motorkerékpár kormánycsövéhez

- Mattfekete lakkozás
- 4 hőkezelt gumikerék
- 8 csapszegből álló készlet: Ø 13 - 15 - 15,5 - 17 - 19 - 20 - 21 - 27



3042C Ft 63.550 1 030420002

3043C

egyarú motorkerékpár állvány
balos

- Mattfekete lakkozás
- 4 hőkezelt gumikerék

• Opcionális csapszeg



3043C Ft 46.350 1 030430002

3043C/ 41÷47

Csapszeg
a 3043C-hoz



	Ø mm	Ft	1	030430551
3043C/41 Ducati	21,5 ÷ 25,5	10.500	1	030430551
3043C/42 KTM - Triumph	27,5	10.500	1	030430552
3043C/43 MV	42,5	11.550	1	030430553
3043C/44 Ducati	40,5	11.550	1	030430554
3043C/45 Honda	28,5	10.500	1	030430555
3043C/47 BMW	53,5	13.550	1	030430557



3047C

pedálos cross/enduro
motorállvány



3047C Ft 29.350 1 030470002

3048C

acél cross racing tartóállvány



3048C Ft 29.350 1 030480002

3050/CC

Custom, Enduro, Cross, Scooter
alsó bölcöcsavaras középállvány

állítható tartó készletet tartalmaz

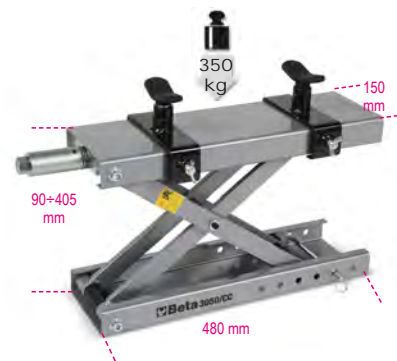

3050/CC Ft 75.500 1 030500012



3050/600

elektro-hidraulikus motorkerékpár emelő,
600 kg



CE



3050/O
3050/G
3050/R

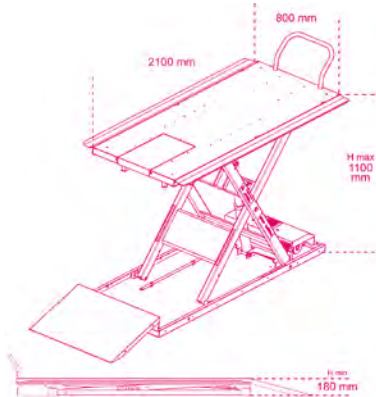

Műszaki adatok

- Elektromos, mechanikus és hidraulikus biztosítószerkezetek
- Teherbírás: 600 kg
- Integrált elektro-hidraulikus egység: 230V - 50 Hz
- Hidraulikus szivattyú
- Szabályozott visszaeresztési sebesség
- Olvadóbiztosítékos védelem kábelszakadás esetére
- Nyomógombos vezérlő panel
- CE tanúsítvány, TÜV bevizsgálás

	L	L	H min	H Max	Ft		
	mm	mm	mm	mm			
3050/O	975	2100	185	1110	2.548.000	1	030500201
3050/G	975	2100	185	1110	2.548.000	1	030500202
3050/R	975	2100	185	1110	2.548.000	1	030500203

3050/KA

szélesítő készlet a 3050/600 emelőhöz

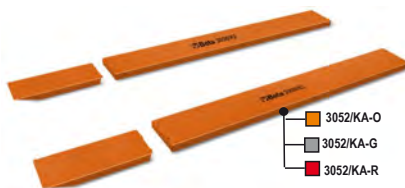

	A	B	Ft		
	mm	mm			
3050/KA-O	107,5	2100	510.100	1	030500221
3050/KA-G	107,5	2100	510.100	1	030500222
3050/KA-R	107,5	2100	510.100	1	030500223

3050/MS

kerékszorító satu a 3050/60 emelőhöz



a motorkerékpár első kereke a hidhoz rögzíthető



	Ft		
3050/MS	289.500	1	030500032

3050/MV

mechanikus kerékszorító satu
3050/600 emelőhöz



	Ft		
3050/MV	504.000	1	030500034

3050/LA

csúszásmentes lemez pad
a 3050/60 emelőhöz

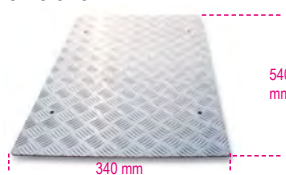

	Ft		
3050/LA	57.900	1	030500062

9562T1

garázsszőnyeg, 100x80 cm



különösen alkalmas a BETA 3071 és 3071B motorkerékpár emelő alá

- könnyen tisztítható, csúszásmentes, gumibevonatú alsórésszel



	L	H	Ft		
	cm	cm			
9562T1	100	80	40.500	1	095620150

9562T3

garázsszőnyeg
Méret: 300x160 cm



- Különösen alkalmas motorkerékpár emelők alá

- Védi a padlót az olaj- és benzincsoepektől, környezetbarát
- Könnyen tisztítható, csúszásmentes, gumibevonatú alsórésszel



	L	H	Ft		
	cm	cm			
9562T3	300	160	160.300	1	095620300

3054

mobil állvány középső kitémasztós
motorkerékpárhoz
vagy hátsó keréken lévő oldaltámaszhoz



	max kg	Ft		
3054	500	127.500	1	030540000

3055M

automatikus satu furgonokhoz



lehetővé teszi a motor első
kerékének rögzítését



	Ft		
3055M	48.600	1	030550002

3057

alumínium rámpa motor felrakodáshoz/
lerakodáshoz



	Ft		
3057	103.200	1	030570001



3070B

statikus kézi kiegyensúlyozó eszköz



- lehetővé teszi a kerekek kiegyensúlyozását műhelyben és versenypályán
- gördülőcsapágyakkal, pozicionálás szintezővel és állítható lábakkal rendelkezik a maximális pontosság érdekében
- kettős kúppal a kerékgagyakhoz

3070B	Ft	1	030700100
	60.500		

3070B/...

kiegyensúlyozó rúd
a 3070B kiegyensúlyozóhoz



	Ø1	Ø2	L	Ft	1	
	mm	mm	mm			
3070B/10	30	10	410	10.700	1	030700101
3070B/12	30	12	415	12.750	1	030700102
3070B/14	40	14	415	15.600	1	030700103

3071A

gumiabroncs szerelővas cross- és enduro motorokhoz



Könnyű és gyors abroncs leszedés a versenypályán; a széles, masszív horganyzott acél szerkezet stabil fogást garantál szerelés közben. A nagyobb kényelem érdekében BETA 3071RS konzolra szerelhető

Jellemzők:

- Ergonomikus gumi markolat a könnyű és biztos fogásért
- Gumi rögzítő a rúd lezárásához szállítás közben
- 17" ÷ 21" méretű cross- és enduro motor abroncsok szereléséhez

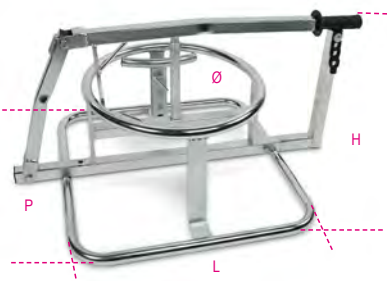

3071A	L	H	P	Ø	Ft	1	030710000
	mm	mm	mm	mm			
	570	400	850	440	234.400		

3071B

gumiabroncs szerelővas mini motorokhoz és mini terepmotorokhoz (dirt bike)



Könnyű és gyors abroncs leszedés a versenypályán; a széles, masszív horganyzott acél szerkezet stabil fogást garantál szerelés közben. A nagyobb kényelem érdekében BETA 3071RS konzolra szerelhető

Jellemzők:

- Ergonomikus gumi markolat a könnyű és biztos fogásért
- Legtöbb mini motor és mini terepmotor szereléséhez

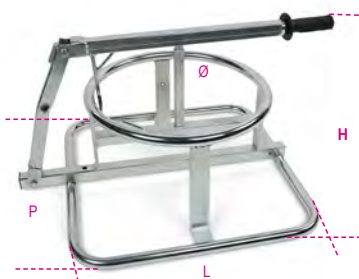

3071B	L	H	P	Ø	Ft	1	030710010
	mm	mm	mm	mm			
	570	330	650	340	219.000		

3071RS

konzol a BETA 3071A és 3071B gumiabroncs szerelővashoz



A BETA 3071A és 3071B gumiabroncs szerelővasat megemelve megkönnyíti az abroncs leszerelését. Horganyzott acél keret. A négyzetes talp stabil tartást biztosít.

- 4 rögzítőhoroggal

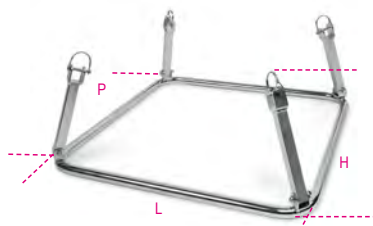

3071RS	L	H	P	Ft	1	030710020
	mm	mm	mm			
	670	275	670	102.000		

962C

gumiabroncs szerelővas pár cross és enduro motorokhoz, mini motorokhoz és mini terepmotorokhoz (dirt bike)



a BETA 3071A és 3071B modellel együttes használatra



962C	L	A	Ft	1	009620020
	mm	mm			
	420	30	53.850		

3072N

motorkerékpár hátsó lengéscsillapító szerelőpad, kézi szereléshez



A motorkerékpár hátsó lengéscsillapítójának teljesen biztonságos szétszerelését teszi lehetővé az állítható karoknak köszönhetően, ami a legtöbb lengéscsillapítóhoz használható, vagy használható akár a tartozék betéttel.

- opcionális zárógyűrűk

Tulajdonságok

- Legtöbb motorkerékpár hátsó lengéscsillapítójához használható
- Függőlegesen 8 pozícióban állítható
- 3 állítható kar állítható magasságú rögzítővel
- lengéscsillapító zárólemez
- ollós emelő
- gumitalpak
- lengéscsillapító rögzítőcsap

Műszaki adatok

Emelő hosszabbító: max. 130 mm
Emelőkar hosszabbító: max. 55 mm
Rögzítő hosszabbító: max. 18 mm
Emelőerő: max. 1 t



3072N	L	H	P	Ft	1	030720010
	mm	mm	mm			
	390	785	390	530.400		

3073

univerzális villa olajvédő beillesztő egység



35 és 45 mm közötti szárahhoz



3073	Ft	1	030730001
	40.300		



30740

Öhlins villa aljzat elektromos csatlakozóval

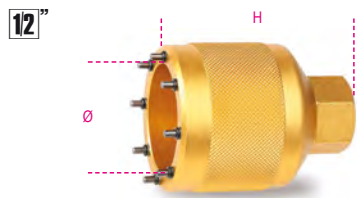

30740	H mm	Ø mm	Ft	1	030740001
	70,5	50,5	47.150		

30740/S

Sachs villakulcs
DUCATI Multistrada modellekhez

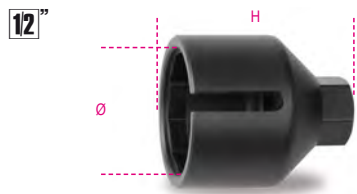

30740/S	H mm	Ø mm	Ft	1	030740002
	75	65	53.450		

30740/M

Marzocchi villakulcs
DUCATI 1199 és Hypermotard modellhez

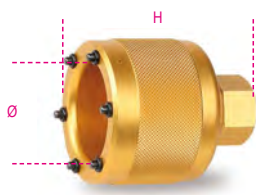

30740/M	H mm	Ø mm	Ft	1	030740003
	69	55	46.350		

30740/2

Nyolcszögletű Öhlins villakulcs DUCATI motorkerékpárokhoz

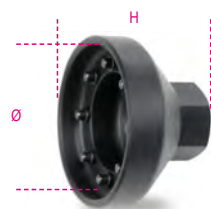

30740/2	H mm	Ø mm	Ft	1	030740004
	45	65	49.000		

3075B

sokszögű dugókulcs
DUCATI kerékagy anyához

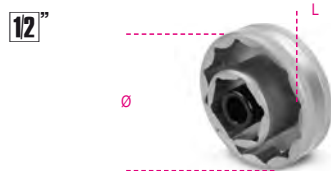

3075B	Ø mm	L mm	Ft	1	030750155
55	55	70,7	25	33.600	

3075MV

sokszögű dugókulcs MV AGUSTA kerékagy anyához

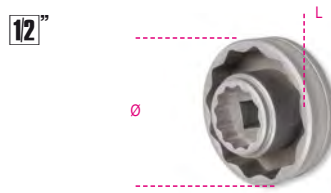

3075MV	Ø mm	L mm	Ft	1	030750156
56	56	70,7	30	37.650	

3075/CM

összetett sokszögű imbuszkulcs
kerékcsapokhoz



3075/CM	Ft	1	030750212
12-14-17-19-22-24 mm	19.000		

3075/K10

univerzális cserélhető fejű kulcskészlet
és 10 betét kerékküllök meghúzásához

Méretetek: 5.2 - 5.4 - 5.6 - 5.8 - 6.0 - 6.2 - 6.4 - 6.6 - 6.8 - 7.0



3075/K10	Ft	1	030750410
	25.100		

3080/C15

láncszem eltávolító és beillesztő készlet

Átmérő 3-4-5 mm, és regina készlet



3080/C15	Ft	1	030800015
420x185x60 mm	168.000		

3080R/CS3

3 db pót csapkinnyomó a 3080/C15 láncszem eltávolító készlethez

átmérő 3-4-5 mm



3080R/CS3	Ft	1	030800503
	25.900		

3081

hordozható láncbontó egység

Erőteljes, és összehajtható az enduro táskában történő szállítás megkönnyítéséhez.
A következő láncokhoz használható 415, 420, 428, 520, 525, 530, 532



3081	Ft	1	030810010
	20.850		

3085

szerszám a fékdugattyúk szétválasztásához

Motorkerékpár és robotgépjármű féknyergekhez ajánlott



3085	Ft	1	030850010
	46.350		

3091

belső menetes le húzó
lendkerékhez



	M	Ft		
3091/25	27x1,0	10.300	1	030910025
3091/30	28x1,0	10.300	1	030910030
3091/40	30x1,0	13.750	1	030910040
3091/45	30x1,5	13.750	1	030910045
3091/50	32x1,5	15.200	1	030910050
3091/60	33x1,5	15.800	1	030910060
3091/70	35x1,0	22.250	1	030910070
3091/75	35x1,5	22.250	1	030910075
3091/80	38x1,5	24.300	1	030910080

3092

külső menetes le húzó
lendkerékhez



	M	Ft		
3092/25	27x1,0	6.280	1	030920025
3092/50	26-28x1,0	6.320	1	030920050
3092/60	28x1,5	6.230	1	030920060

3093/E

szerszám lendkerék, tengelykapcsoló harang
és szíjtárcsa reteszeléséhez



	Ft		
3093/E	17.200	1	030930100

3093/U

kombinált le húzó lendkerékhez



	Ft		
3093/U	16.400	1	030930050
M10x1.25R			
M14x1.5R			
M16x1.5R			
M18x1.5R			
M24x1.0R			
M27x1.0L			

3095

motorkerékpár motor szerelőállvány



állítható tartókonozok a motoron végzett kényelmes munka érdekében



	H	P	L	L1	Ft		
3095	360	460	640	460	275.300	1	030950001

3099E

kültéri motorkerékpár ponyva, víz- és porálló



karcolás, por és napfény elleni védelem



„M” méret a sport és naked motorkerékpárokhoz és közepes robogókhoz
„L” méret a maxi enduro és crossover motorkerékpárokhoz

	M	Ft		
3099E/M	M	39.050	1	030990102
3099E/L	L	47.950	1	030990103

3099T

beltéri motorkerékpár ponyva, elasztikus szövetből



karcolás, por és napfény elleni védelem



„M” méret a sport és naked motorkerékpárokhoz és közepes robogókhoz
„L” méret a maxi enduro és crossover motorkerékpárokhoz
„XL” méret a túra motorkerékpárokhoz

	Tg	Ft		
3099T/M	M	33.800	1	030990202
3099T/L	L	41.500	1	030990203
3099T/XL	XL	50.200	1	030990204

Beta

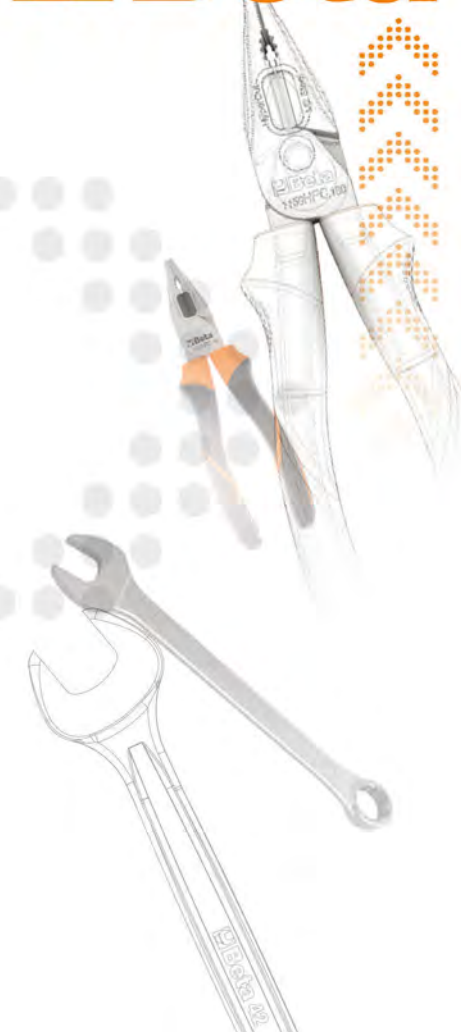



KERÉKPÁRSZERELŐ SZERSZÁMOK



A kerékpározás mindig is része volt a Beta életének. A kerékpáros szakemberek számára fejlesztett kerékpárszerelő szerszámokat bemutató fejezet kifejezetten hagyományos és elektromos kerékpárok karbantartásához tervezett termékeinket mutatja be



Tour de France winner 2020, 2021 e 2024
Giro d'Italia winner 2024



Partnership 2024



Official contributor
POLTI KOMETA cycling



Partnership 2024



3910

Elektromos kerékpáremelő



- Maximális teherbírás: 40 kg
- Hajtóműtartó maximum magassága: 135 cm
- Beépített kerék kiegyensúlyozó állvány
- Innovatív thru-axle (innovatív, gyorszáras rögzítő) rendszer
- A legtöbb villához használható befogó adapterekkel
- Villacsatlakozó adapterrel szállítva, thru-axle nélkül
- Összehajtható és könnyen szállítható
- Emelési súly: 48 kg

CE

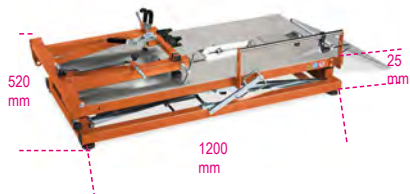

3910	Ft	1.680.200	1	039100010
------	----	-----------	---	-----------

3912TP

TOP műhelypad kerékpárok karbantartásához



- Hajtóműtartó biztosító csappal
- Teleszkópos, csapágyazott szerszámtartó fiók (490x365x90 mm)
- Beépített kerék kiegyensúlyozó állvány
- Innovatív thru-axle rögzítő rendszer



3912TP	Ft	694.300	1	039120050
--------	----	---------	---	-----------

3912PP

PRO műhelypad kerékpárok karbantartásához



- Hajtóműtartó biztosító csappal
- Beépített kerék kiegyensúlyozó állvány
- Innovatív thru-axle rögzítő rendszer



3912PP	Ft	400.800	1	039120150
--------	----	---------	---	-----------

3912TP/A

befogó adapter thru-axle villákhoz



3912TP, 3912PP és 3910 típusú műhelypadhoz



L mm	Ø mm	Ø1 mm	Ft	1	039120052
39	30	5	9.270		

3912TP/C

univerzális befogó adapter thru-axle villákhoz, hatlapú dugókulcsos meghúzáshoz



3912TP, 3912PP és 3910 típusú műhelypadhoz



L mm	Ø mm	Ft	1	039120054
29	30	9.270		

3912TP/FOX

befogó adapter for FOX® villákhoz



3912TP, 3912PP és 3910 típusú műhelypadhoz



L mm	Ft	1	039120058
38	9.270		

3912TP/QRE

adapter túske villákhoz, thru-axle nélkül



3912TP, 3912PP és 3910 típusú műhelypadhoz



L mm	Ft	1	039120064
108	15.400		

3912TP/ROAD

befogó adapter országúti kerékpár villákhoz



3912TP, 3912PP és 3910 típusú műhelypadhoz



L mm	Ø mm	Ft	1	039120060
33	35	10.300		

3912TP/RS

befogó adapter ROCKSHOX® thru-axle villákhoz



3912TP, 3912PP és 3910 típusú műhelypadhoz



L mm	Ø mm	Ft	1	039120056
35	30	9.270		

3912TP/ST

befogó adapter SUNTOUR villákhoz



3912TP, 3912PP és 3910 típusú műhelypadhoz



L mm	Ø mm	Ø1 mm	Ft	1	039120062
31	30	18	10.300		



3916MMP

egykaros műhelysatu kerékpárok karbantartásához

- 360°-ban elforgatható satsu, önbeálló pofák és mikrométeres állíthatóság
- Teherbírás: 25 kg
- Műanyag szerszámtartó tál



3916MMP	Ft	1	039160150
	342.900		

3918MML

kerékpárszerelő állvány, könnyű, összecsukható

- 360°-ban elforgatható tartó
- Teherbírás: 15 kg
- Maximális magasság: 150 cm



3918MML	Ft	1	039180010
	139.300		

3921

a láncvilla-sebességváltó láncvonalat beállító szerszám

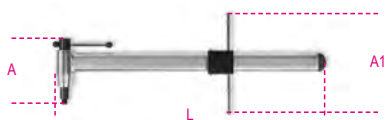

L	A	A1	Ft	1	039210010
440	115	165	48.600		



3923

készvezető szerszám airfoil vázcsövek vágáshoz 80 mm-ig, és 1" és 1.1/2" közötti kormányoszlop vágáshoz

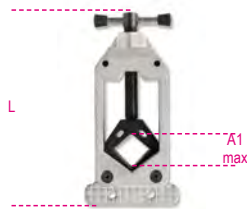

L	A1 max	Ø max	Ft	1	039230010
160	80	45	22.850		

3927

kormányreteszelő



3927	L	Ft	1	039270010
	365	13.750		

3932U

professzionális láncbontó készülék 5-11V sebességű láncokkal kompatibilis



L	L1	Ft	1	039320011
164	115	25.300		

3935

láncpás jelző



L	Ft	1	039350010
120	4.330		

3937

patentszem fogó



L	Ft	1	039370010
170	11.150		



3948

hajtókar lehúzó

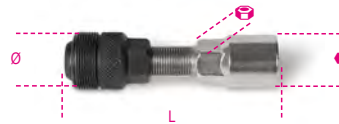

Ø	L	Ø	Ft	1	039480015
14	79	20	8.660		

3952

egyszerű kúpos kulcs



Ø	L	S1	Ft	1	039520013
mm	mm	mm			
13	205	2	11.150	2	039520013
14	205	2	11.150	2	039520014
15	205	2	11.150	2	039520015
16	205	2	11.150	2	039520016
17	205	2	11.150	2	039520017
18	205	2	11.150	2	039520018
19	205	2	11.150	2	039520019
20	205	2	11.350	1	039520020
21	205	2	11.350	1	039520021
22	205	2	11.350	1	039520022
24	205	2	11.750	1	039520024



3952/S7	Ft	1	039520207
13-14-15-16	77.950		
17-18-19 mm			
3952/S11	Ft	1	039520211
13-14-15-16	123.700		
17-18-19-20-21-22-24 mm			

3953

pedálkulcs



Ø	L	Ft	1	039530015
mm	mm			
15	401	17.400		

3955

univerzális kormány sorozat villáskulcs



Ø	L	Ft	1	039550108
mm	mm			
30x32	292	16.000		
32x36	319	17.800		

3961 3,2

fekete küllőhúzó kulcs 3,2 mm



mm	Ft		
3,2	6.320	1	039610032

3961 3,3

zöld küllőhúzó kulcs 3,3 mm



mm	Ft		
3,3	6.320	1	039610033

3961 3,5

piros küllőhúzó kulcs 3,5 mm



mm	Ft		
3,5	6.320	1	039610035

3961U

professzionális küllőhúzó kulcs 3,2 - 4,0 mm



mm	Ft		
3,2 - 4,0	10.300	1	039610100

3962SH

kettős Shimano küllő húzókulcs



L mm	A1 mm	A2 mm	Ft		
132	4,3	4,4	8.020	1	039620010

3962MV

kettős Mavic küllő húzókulcs



L mm	A1 mm	A2 mm	Ft		
135	4,3	8,4	8.340	1	039620020

3963P

speciális kulcs lapított küllőkhöz



L mm	Ft		
129	3.790	1	039630010

3964

speciális küllőcsavar behajtó kulcs



L mm	L1 mm	Ft		
170	89	9.390	1	039640010

3965

sablon 20" és 29" közötti kerekek egyenesfutásának beállításához



L mm	Ft		
680	45.950	1	039650010

3965C

professzionális kerék központozó



- 20" és 29" közötti átmérőhöz
- 10 és 20 mm közötti tengelyátmenet adapter



L mm	L1 mm	A mm	Ft		
500	380	285	185.400	1	039650110

3967

fogaskerék leszedő láncos kulcs



- 11 sebességes kazettás lánckerekekig kompatibilis
- 2PVC markolat
- Rögzített agyas kerekekhez is használható



L mm	Ft		
289	25.100	1	039670010

3969

gumiszerelő vas



L mm	A mm	Ft		
200	15,6	4.570	1	039690010

3969K3

3db gumiszerelő, műanyag



L mm	Ft		
113	2.530	1	039690130

3971

Shimano műanyag csavar kulcs



- Shimano Hollowtech II hajtóművekhez használható



N° tacche	mm	Ft		
8	8	5.630	1	039710010

3972

hajtómű lehúzó kulcs



- alkalmas a Shimano® Hollowtech II, Campagnolo® Ultra-torque, FSA®, SRAM® rendszerekhez



L mm	Ft		
252	10.950	1	039720010

3973PF

Press-Fit csapágy lehúzó



- Alkalmas 24 és 30 mm közötti belső átmérőkhöz



L mm	Ft		
240	14.550	1	039730001

3973/1

lehúzó dugókulcs 16 bordás hajtóműhöz



- Alkalmas a Shimano® XTR BB93, Dura-Ace® BB9000 rendszerekhez



Ø mm	mm	L mm	Ft		
39	24	34	9.310	1	039730010

3973/2

lehúzó dugókulcs 16 bordás hajtóműhöz

• Alkalmas a Shimano® BBR60 (Ultegra® 11 sebességű) rendszerekhez

12"



Ø mm	mm	L mm	Ft	1	039730020
41	24	35	9.310		

3973/3

lehúzó dugókulcs 16 bordás hajtóműhöz

• alkalmas a Shimano® Hollowtech II, Campagnolo® Ultra-torque, FSA®, SRAM® rendszerekhez

12"



Ø int. mm	mm	L mm	Ft	1	039730030
46	24	53,5	9.310		

3973/4

lehúzó dugókulcs 20 bordás hajtóműhöz nikkelezett központi csappal

• Alkalmas a Shimano és ISIS rendszerekhez

12"



Ø mm	L mm	mm	Ft	1	039730040
31,5	55	24	5.870		

3975

Kormány- és hajtómű összeszerelő prés

• Kormányapokák szereléséhez
1", 1.1/8", 1.1/4", 1.1/2" és 2"
MEGJEGYZÉS: Zero-Stack kupakkal nem használható



L mm	Ø mm	Ft	1	039750010
360	16x1	123.100		

3984/1

4 körmös BMX szabadonfutó lehúzó kulcs

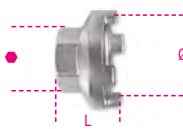

Ø mm	L mm	mm	Ft	1	039840010
35	25,5	24	6.840		

3984/2

Shimano szabadonfutó lehúzó kulcs



Ø mm	L mm	mm	Ft	1	039840020
22,8	26	24	4.330		

3984/3

kazettás vezetőcsapos Shimano szabadonfutó lehúzó kulcs

12"



Ø mm	L mm	L1 mm	Ft	1	039840030
23,5	65	25	7.450		

3984/4

vezetőcsapos Campagnolo szabadonfutó lehúzó kulcs



Ø mm	L mm	L1 mm	mm	Ft	1	039840040
23	51	13	24	9.760		

3984/5

2 körmös szabadonfutó lehúzó kulcs

12"



Ø mm	L mm	mm	Ft	1	039840050
18,5	38	21	6.840		

3984/6

4 körmös szabadonfutó lehúzó kulcs

12"

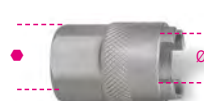

Ø mm	L mm	mm	Ft	1	039840060
19,5	36	21	6.840		

3991

tárcsafék betét hátrahúzó kar



L mm	A mm	α	Ft	1	039910010
222	36	7°	16.200		

3992

kulcs féktárcsa egyenesbe állításához



L mm	S mm	A mm	A1 mm	Ft	1	039920010
234	4	55	2,2	12.350		

2115PI/BIKE-HOME



2115PI/BIKE-HOME	354
------------------	-----

M400



M400	554
MV400	554

M401



M401	554
MV401	554

MM400



MM400	558
MMV400	558

MM401



MM401	559
MMV401	559



1000V-IG SZIGETELT SZERSZÁMOK

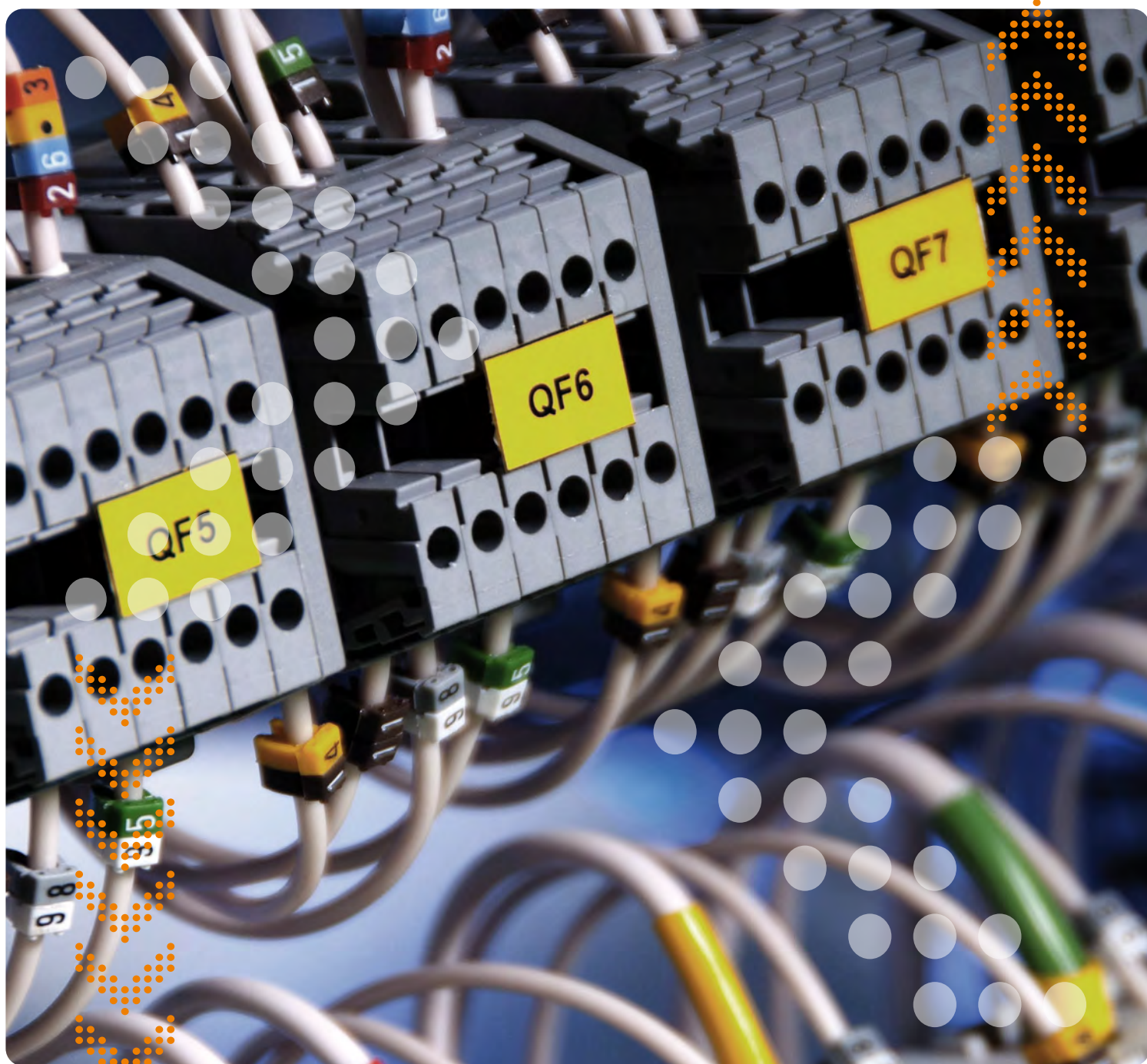

A Beta által gyártott szigetelt szerszámok tervezésénél az elektromossággal kapcsolatos előírásokat tartották szem előtt. Minden szigetelt szerszám lehetővé teszi a munkát feszültség alatti berendezéseken: váltóáramnál 1000 V alatti, egyenáram esetén 1500 V alatti feszültségig. A minőség, a teljesítmény és a használat biztonsága megfelel a 60900-as szabvány előírásainak, minden egyes szerszámot átfogó vizsgálat alá vonnak. Vizsgálják a nyél csúszásmentességét és tűzbiztonságát, valamint a szerszámot 10000 V-os feszültség esetén. A választékra és a hőformált tálcákra vonatkozóan lásd a megfelelő fejezeteket!

A Beta összes szigetelt szerszáma az EN60900 szabvány előírásainak figyelembevételével kerül gyártásra és a legjobb európai tanúsítványkibocsátó hatóságok engedélyezik.



Istituto Italiano del Marchio di Qualità - I



Verband der Elektrotechnik
Elektronik Informationstechnik - D

MUNKAVÉDELMI VIZSGÁLATOK: az 1000 V berendezéseken alkalmazott szerszámainkat 10000 V-on teszteltük.

A Beta minden egyes szigetelt szerszáma 10 kV-os vizsgálaton esik át, ezzel biztosítva a páratlan minőségű munkaeszközök megfelelőségét a legszigorúbb munkabiztonsági előírásoknak.

Szerszámainkat akár 1000 V AC (1500 V DC) berendezéseken is használhatja.

MUNKAVÉDELMI SZABVÁNYOK:

Amellett, hogy a szerszámaink a gyártás során szigorú ellenőrzéseken esnek át, használat előtt mindig ellenőrizze a szigetelő nyél épségét és győződjön meg, hogy az nem sérült. A szerszámot éró mechanikus és vegyi igénybevétel, illetve a hőfeszültség mértéke szorosan összefügg azzal, hogy az meddig őrzi meg dielektromos tulajdonságait. A szigetelőanyag sérülése esetén a szerszámot már nem lehet biztonságosan használni feszültség alatt lévő berendezéseken. Mindig viseljen védőszemüveget és szigetelt kesztyűt.

GYÁRTÁS SORÁN VÉGZETT ELLENŐRZÉSEK



100% szemrevételezés:

A szerszámok felületének minden látható sérüléstől mentesnek kell lennie.



Törésteszt:

A szerszámot két órán át -25 °C-on tartjuk, majd háromszor ráütünk (ehhez a szabványban meghatározott súlyt használjuk); a szigetelő nyélen semmilyen sérülésnek nem szabad mutatkoznia.



Penetrációvizsgálat:

A szerszám nyelére +70 °C-on két órán keresztül 2 kg súlyt helyezünk. Később a mechanikus nyomásnak kitett területbe 3 percen keresztül 5 kV feszültséget vezetünk. Nem haladhat át áram a szerszámon.



Mechanikai vizsgálat:

A szerszámoknak meg kell felelniük a vonatkozó ISO szabványokban meghatározott mechanikai teljesítmény előírásoknak.



Lángterjedési vizsgálat:

A lángot 10 másodpercig szerszám irányába fordítjuk, majd a következő 20 másodperc során a láng magassága nem haladhatja meg a 120 mm-t.



Méretellenőrzés:

A szerszám minden méretének meg kell felelnie a tervezési specifikációknak.



Villamos szigetelésvizsgálat:

A szerszámot 24 órán keresztül vízbe merítjük, majd 3 percig 10 kV feszültségre tesszük ki. A disszipáció nem haladhatja meg a szabványban meghatározott értékeket.

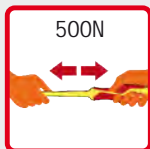

500N

Adhéziós teszt:

A szerszámot 168 órán át +70 °C-on tartjuk, majd 500 N terhelésnek tesszük ki, melynek során a markolata nem csúszhat le.



Jelölések kitörölhetetlenségi vizsgálata:

Izopropil alkohollal végzett tapadásvizsgálatot követően a jelöléseknek olvashatóknak kell maradni.



Egyoldalas villáskulcs



△1000 V

★=△

EN 60900

mm	L mm	Ft	☒	☒
★6	90	15.200	1	000520106
★7	96	15.200	1	000520107
★8	100	15.200	1	000520108
★9	108	15.200	1	000520109
★10	110	15.200	1	000520110
★11	120	15.200	1	000520111
★12	132	16.000	1	000520112
★13	140	17.000	1	000520113
★14	146	17.400	1	000520114
★15	166	18.000	1	000520115
★16	156	19.650	1	000520116
★17	168	19.650	1	000520117
★18	170	20.250	1	000520118
★19	176	20.250	1	000520119
★21	190	22.050	1	000520121
★22	200	22.050	1	000520122
★24	225	23.900	1	000520124
★27	210	31.150	1	000520127
★30	240	32.600	1	000520130
★32	240	33.200	1	000520132

Egyoldalas csillagkulcs



△1000 V

★=△

EN 60900

mm	L mm	Ft	☒	☒
★6	150	19.450	1	000890106
★7	155	19.450	1	000890107
★8	155	19.450	1	000890108
★9	160	19.450	1	000890109
★10	170	19.450	1	000890110
★11	180	19.450	1	000890111
★12	190	21.250	1	000890112
★13	195	22.450	1	000890113
★14	200	23.900	1	000890114
★15	210	24.300	1	000890115
★16	216	25.900	1	000890116
★17	218	25.900	1	000890117
★18	236	27.550	1	000890118
★19	240	27.550	1	000890119
★21	250	31.550	1	000890121
★22	255	31.550	1	000890122
★24	280	35.800	1	000890124
★27	300	38.050	1	000890127
★30	320	44.750	1	000890130
★32	340	45.350	1	000890132

Allítható villáskulcs skálával



△1000 V

EN 60900

L mm	A max	Ft	☒	☒
200	28	38.650	1	001100520
250	30	44.750	1	001100525
300	30	65.200	1	001100530

606MQ/50

Nyomatékkulcs hangjelzéssel, irányváltós racsnival



EN 60900
UNI EN 26789
ISO 6789

Nm	Kgfm	lbf.ft	A mm	L mm	g
5÷50	0,5÷5	4÷40	90	375	1130

606MQ/50	Ft	1	006060705
	374.100		

850MQ

VDE-mágneses betéttartó bimateriál-nyéllel



IMQ CSV
EN 60900

L mm	L1 mm	D mm	Ft	1	008500910
233	125	12.5	11.350		

910MQ/B

tizenkétszögű dugókulcs



EN 60900

mm	L mm	01 mm	0 mm	Ft	1	009100616
6	45	14	24	13.750		
7	45	15	24	13.750		
*8	45	16	24	13.750		
*9	45	17	24	13.750		
*10	45	19	24	13.750		
*11	45	20	24	13.750		
*12	45	24	24	13.750		
*13	45	24	24	13.750		
*14	45	25	24	13.750		
*15	45	27	24	14.550		
*16	45	27,5	24	14.550		
*17	45	30	24	14.950		
*18	45	31	24	14.950		
*19	45	32	24	14.950		

910MQ/PE

imbusz dugókulcs



EN 60900

mm	0 mm	L mm	Ft	1	009100604
4	24	100	15.600		
*5	24,5	100	15.600		
*6	25,0	100	15.600		
*8	25,0	100	15.600		
10	25,5	100	16.000		

910MQ/TX

dugókulcs
Torx® csavarokhoz



EN 60900

	0 mm	L mm	L1 mm	Ft	1	009100641
T15	23	116	61	19.650		
T20	24,5	116	65	19.650		
T25	24,5	116	65	19.650		
T27	24,5	116	65	19.650		
T30	24,5	116	65	20.050		
T40	24,5	116	65	20.250		

910MQ/XZN

dugókulcs
XZN® csavarokhoz



EN 60900

	0 mm	L mm	L1 mm	Ft	1	009100658
M8	24	106	57	18.200		
M10	24	106	57	19.000		

910MQ/PT

3/8" hosszabbító



EN 60900

Nm	L mm	L1 mm	Ft	1	009100801
12	80	35,5	103.200		

910MQ/21

3/8"-os toldó



EN 60900

L mm	0 mm	Ft	1	009100804
140	13,4	24.900		

910MQ/22

3/8"-os toldó



EN 60900

L mm	0 mm	Ft	1	009100805
265	13,4	27.100		

910MQ/T

3/8"-os T-hajtósár



EN 60900

L mm	L1 mm	Ft	1	009100807
200	165	29.550		

910MQ/55

3/8" irányváltós racsnival



EN 60900

L mm	D mm	A mm	Ft	1	009100808
203	41	67	84.600		

910MQ/C16

8 tizenkétszögű dugókulcs,
4 hatszögű dugókulcs
és 4 tartozék



EN 60900

910MQ/C16	Ft	1	009100917
	369.400		

910MQ/B	8 - 10 - 11 - 12 - 13 - 14 - 17 - 19 mm
910MQ/PE	4 - 5 - 6 - 8 mm
910MQ/21	125 mm
910MQ/22	250 mm
910MQ/T	
910MQ/55	

914MQ/A

hatszögű dugókulcs,
3/8"-os,
különleges poliamid-alapú technopolimerből

Speciálisan a hibrid és elektromos autók akkumulátoraihoz fejlesztve

Nyomatékkulccsal való használatra



EN 60900

Ø	Ø	L	Ø1	Ft		
mm	mm	mm	mm			
8	17,5	45	20	7.170	2	009140008
10	20,5	45	20	7.170	2	009140010
13	24	45	20	7.170	2	009140013
17	30	45	22	7.170	2	009140017



EN 60900

	Ft		
914MQ-A/S4 8-10-13-17 mm	28.650	1	009140054

920MQ/A

1/2"-os hatlapú dugókulcs



EN 60900

Ø	Ø	L	Ø1	Ft		
mm	mm	mm	mm			
8	21,5	57	27,5	13.750	1	009200238
9	21,5	57	27,5	13.750	1	009200239
10	21,5	57	27,5	13.750	1	009200240
11	21,5	57	27,5	13.750	1	009200241
12	23,0	57	27,5	13.750	1	009200242
13	23,0	57	27,5	13.750	1	009200243
14	23,0	57	27,5	14.150	1	009200244
16	23,0	57	27,5	14.550	1	009200246
17	30,0	57	27,5	14.550	1	009200247
18	32,0	57	27,5	14.950	1	009200248
19	32,2	57	27,5	14.950	1	009200249
20	32,0	57	27,5	16.800	1	009200250
21	34,0	57	27,5	16.800	1	009200251
22	36,0	57	27,5	16.800	1	009200252
24	39,0	57	27,5	17.200	1	009200254
27	42,0	57	27,5	17.400	1	009200257
30	44,0	57	27,5	18.000	1	009200260
32	48,0	57	27,5	18.400	1	009200262

920MQ/PE

Imbusz-dugókulcs



EN 60900

	D	L	L1	Ft		
mm	mm	mm	mm			
4	28,5	94,50	10,5	23.050	1	009200264
*5	28,5	94,5	10,5	23.050	1	009200265
*6	28,5	94,5	10,5	23.050	1	009200266
*8	28,5	94,5	10,5	23.050	1	009200268
10	28,5	94,5	10,5	24.100	1	009200267
12	28,5	94,5	10,5	24.100	1	009200269

920MQ/21

1/2"-os toldó



EN 60900

L	Ø	Ft		
mm	mm			
135	28	26.500	1	009200804

920MQ/22

1/2"-os toldó



EN 60900

L	D	Ft		
mm	mm			
264	30	30.150	1	009200805

920MQ/T

1/2"-os T-hajtósár

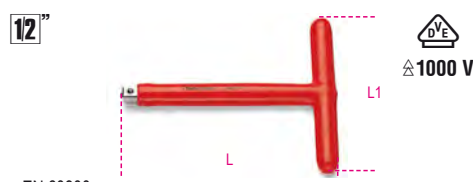

EN 60900

L	L1	Ft		
mm	mm			
200	163	31.550	1	009200807

920MQ/55A

1/2"-os irányváltós racsn

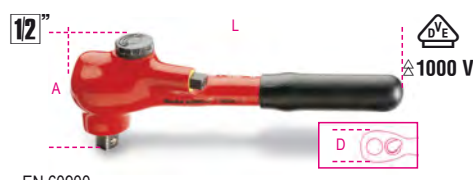

EN 60900

L	D	A	Ft		
mm	mm	mm			
240	50	89	113.000	1	009200809

920MQ/C16

9 hatlapú dugókulcs
3 imbusz-dugókulcs külső négyszöggel
és 4 tartozék



EN 60900

920MQ/C16	Ft		
	431.600	1	009200917

920MQ/A	8 - 10 - 12 - 13 - 14 - 17 - 19 - 22 - 24 mm
920MQ/PE	5 - 6 - 8 mm
920MQ/21	135 mm
920MQ/22	264 mm
920MQ/55A	
920MQ/T	
420x280x60 mm - 5,2 kg	

943MQ

Hosszú dugókulcs-csavarhúzó



EN 60900

Ø	L	L1	D	Ft		
mm	mm	mm	mm			
5,5	233	125	12,2	8.990	1	009430235
6	233	125	12,5	8.990	1	009430236
7	240	125	14,3	9.510	1	009430237
8	240	125	15,3	9.800	1	009430238
10	252	125	17,3	10.100	1	009430240
13	252	125	21,3	11.150	1	009430243

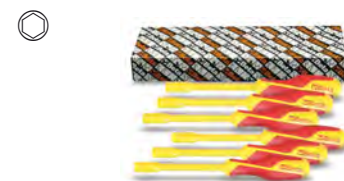

943MQ/S6	Ft		
5,5-6-7-8-10-13 mm	58.550	1	009430250

951MQ

T-szerű imbuszkulcs



EN 60900

	L	L1	Ft		
mm	mm	mm			
3	120	105	22.450	1	009510703
*4	165	105	23.050	1	009510704
*5	170	105	23.050	1	009510705
*6	168	105	23.050	1	009510706
*8	165	105	23.700	1	009510708
10	200	105	24.500	1	009510710

993MQ

Hajlított csapos csipesz lekerekített fogazott hegygel



EN 60900

L mm	Ft	1	009930040
147	19.000		

994MQ

Egyenes csipesz erősen lekerekített fogazott hegygel



EN 60900

L mm	Ft	1	009940040
145	18.400		

1010MQ

Hosszított kerekcsőrű műszerészfogó, krómozott



EN 60900

L mm	L1 mm	Ft	1	010100096
160	51,5	22.650		

1048MQ

Vízpumpafogó, stifttel állítható, szigetelt, 1000V

• krómozott



EN60900

L mm	A max mm	L1 mm	Ft	1	010480315
250	48	39	33.400		

1082MQ

Oldalsípőfogó, krómozott



EN 60900

L mm	L1 mm	≠ mm	Ft	1	010820094
140	20	1,6	22.450		
160	22	1,6	23.700		

1084MQ

Erősített oldalcsípőfogó



EN 60900

L mm	L1 mm	≠ mm	Ft	1	010840100
200	26	2,0	29.550		

1088MQ

Erősített homlokcsípőfogó



EN 60900

L mm	L1 mm	≠ mm	Ft	1	010880096
160	7	1,6	28.150		

1128MQ

Műszerészolló, rozsdamentes acél él, mikrofogazattal



IEC60900

L mm	L1 mm	Ft	1	011280101
145	45	23.500		

1132MQ

Szigetelt nyelű kábelvágó, réz és alumínium kábel vágásához



EN 60900

L mm	≠ mm	Ft	1	011320193
230	18	43.100		

1142MQ

Kábelcsupaszoló fogó, krómozott



EN 60900

L mm	≠ mm ²	Ft	1	011420096
160	0,5÷6	24.900		

1150MQ

Kombinált fogó, krómozott



EN 60900

L mm	L1 mm	≠ mm	Ft	1	011500496
160	37	1,6	21.450		
180	39	1,8	23.500		
200	43	2,0	24.500		
220	46	2,0	26.700		

1162MQ

Egyenes laposfogó, extra hosszú, krómozott



EN 60900

L mm	L1 mm	≠ mm	Ft	1	011620096
160	56	1,6	23.050		
200	76	1,6	24.500		

1164MQ

Hajlított extra hosszú laposfogó



EN 60900

L mm	L1 mm	≠ mm	Ft	1	011640096
160	54	1,6	24.100		
200	76	1,6	25.300		

1166MQ

Egyenes félkerekcsőrű fogó, extra hosszú, krómozott



EN 60900

L mm	L1 mm	≠ mm	Ft	1	011660096
160	56	1,6	23.050		
200	76	1,6	24.500		

1168MQ

Hajlított félkerekcsőrű fogó, extra hosszú, krómozott



EN 60900

L mm	L1 mm	mm	Ft	1	011680096
160	50	1,6	24.100	1	011680096
200	70	1,6	25.300	1	011680100

1169MQ/D2

1000V-ig szigetelt, 1 kombinált fogó, és 1 oldalsípőfogó



1000 V

1169MQ/D2	Ft	1	011690152
1150MQ 180 mm	47.150	1	011690152
1082MQ 160 mm			

1272MQF

csavarhúzók keresztféjű Phillips® csavarokhoz

Slim

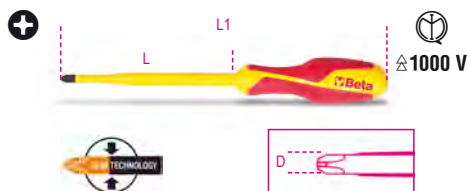

EN60900

PHxDxL mm	L1 mm	Ft	3	012720609
1x4,5x80	180	6.760	3	012720609
2x6x100	208	7.650	3	012720618

1272MQ

Phillips®-csavarhúzó



EN 60900

PHxDxL mm	L1 mm	Ft	3	012720703
0x3x60	160	4.530	3	012720703
1x4,5x80	188	5.590	3	012720709
2x6x100	219	6.360	3	012720718
3x8x150	277	8.260	2	012720724
4x10x200	327	9.800	2	012720727



1272MQ/S5	Ft	1	012720751
PH0x3x60-PH1x4,5x80 PH2x6x100-PH3x8x150 PH4x10x200 mm	34.550	1	012720751

1273MQF/D...

6 darabos slim csavarhúzókészlet



1273MQF/D4	Ft	1	012730604
1272MQF 1x4,5x80-2x6x100 mm 1274MQF 0,6x3,5x100-1x5,5x125 mm	27.000	1	012730604

1273MQF/D6	Ft	1	012730606
1272MQF 1x4,5x80-2x6x100 mm 1274MQF 0,6x3,5x100-1x4,5x100 1x5,5x125-1,2x6,5x150 mm	41.550	1	012730606

1273MQ/D6

6 csavarhúzó



1273MQ/D6	Ft	1	012730851
1274MQ 0,5x3x100 -0,8x4x100 1,0x5,5x125 mm 1272MQ PH0x3x60 -PH1x4,5x80 PH2x6x100 mm	32.400	1	012730851

1274MQF

csavarhúzóknak hernyócsavarokhoz

Slim

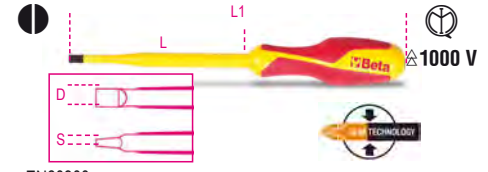

EN60900

SxDxL mm	L1 mm	Ft	3	012740603
0,6x3,5x100	200	5.790	3	012740603
1x4,5x100	200	6.440	3	012740606
1x5,5x125	225	6.800	3	012740609
1,2x6,5x150	258	8.140	3	012740612

1274MQ

Villanyszerelő csavarhúzó

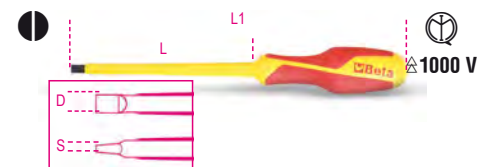

EN 60900

SxDxL mm	L1 mm	Ft	3	012740700
0,4x2,5x75	175	4.410	3	012740700
0,5x3x100	200	4.620	3	012740703
0,8x4x100	208	5.470	3	012740706
1x5,5x125	233	5.830	3	012740709
1,2x6,5x150	269	7.090	3	012740712
1,2x8x175	302	8.260	2	012740715
1,6x10x200	327	9.760	2	012740718



1274MQ/S6	Ft	1	012740751
0,5x3x100-0,8x4x100 1x5,5x125-1,2x6,5x150 1,2x8x175-1,6x10x200 mm	41.000	1	012740751

1275MQ/C

kombinált csavarhúzó PH kereszthornos + egyenes hornyú csavarokhoz

keskeny

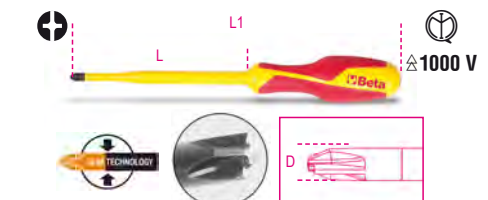

EN60900

PH1+LPP	Ft	2	012750409
PH2+LPP	7.090	2	012750418

1276MQ/C

kombinált csavarhúzó PZ keresztornyos + egyenes hornyú csavarokhoz

keskeny

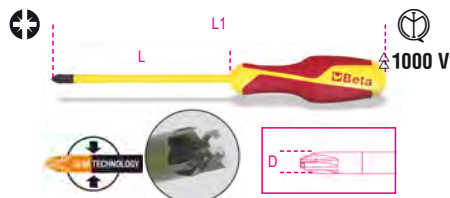

EN 60900

	Ft		
☉ PZ1+LPP	5.870	2	012760409
☉ PZ2+LPP	6.640	2	012760418

1279MQ/F

csavarhúzó Pozidriv®-Supradriv® keresztornyos csavarokhoz

keskeny

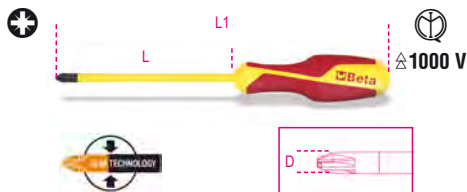

EN60900

pz	L mm	L1 mm	Ft		
1	80	180	6.230	3	012790409
2	100	208	7.090	3	012790418

1279MQ

Pozidriv®- és Supadriv® csavarhúzó



EN 60900

PZ	L mm	L1 mm	Ft		
0	60	160	4.700	3	012790703
1	80	188	5.670	3	012790709
2	100	219	6.520	3	012790718
3	150	277	8.580	2	012790724



	Ft		
1279MQ/S4 PZ 0-1-2-3	25.450	1	012790751

1725MQ

Fűrés



EN 60900

	L mm	H mm	Ft		
1725MQ	260	85	43.100	1	017250030

1777MQ/C

Kábelkés

• többeres kábelhez



EN 60900

	L mm	Ft		
1777MQ/C	190	17.400	1	017770026

1777MQ/U

Kábelkés



EN 60900

	L mm	Ft		
1777MQ/U	190	15.800	1	017770011

1777RL/U

4 Tartalékpenge a 1777MQ/U modellehez



	Ft		
1777RL/U	12.550	1	017770021

1995MQ/T

Szigetelő aláfekvő

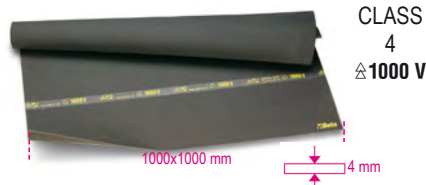

VDE 0303
EN 60243

	LxS mm	Ft		
1995MQ/T	1000x1000	144.100	1	019950030

1996MQ/T

szigetelt szövet

500x500mm

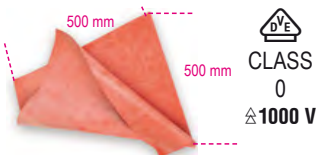

DIN EN 61112

	S mm	Ft		
1996MQ/T0,5	1.0	43.900	1	019960005

1996VPG

Pneumatikus vizsgáló szigetelt védőkesztyűkhöz

Az EN90603 szabvány szerinti kötelező vizsgálat



	Ft		
1996VPG	169.200	1	019960134

1997MQ/GM

Kompozit szigetelt védőkesztyű

CE



EN 60903
EN 61482

	Gr.	L mm	Ft		
1997MQ/GM 9	9	350	75.700	1	019970109
1997MQ/GM 10	10	350	75.700	1	019970110

2115P L-MQ32



2115PL-MQ32	354
-------------	-----

2029EM



2029EM	347
--------	-----

5989 VEM



5989 VEM	528
----------	-----





LEESÉSVÉDETT SZERSZÁMOK

**35HS**

Erősített laposvágó, krómozott H-SAFE



L mm	A mm	Ft	📦	🖨️
200	23,0	18.600	1	000354004
250	28,5	23.700	1	000354005

42HS

Csillag-villáskulcs, krómozott H-SAFE



DIN 3113 UNI-ISO 7738

📏 mm	L mm	Ft	📦	🖨️
6x6	95	9.680	1	000424506
7x7	105	9.800	1	000424507
8x8	116	9.880	1	000424508
9x9	127	10.100	1	000424509
10x10	137	10.300	1	000424510
11x11	148	10.500	1	000424511
12x12	158	10.700	1	000424512
13x13	169	10.700	1	000424513
14x14	180	11.350	1	000424514
15x15	190	11.350	1	000424515
16x16	201	11.750	1	000424516
17x17	212	12.350	1	000424517
18x18	222	12.550	1	000424518
19x19	233	12.750	1	000424519
20x20	243	13.350	1	000424520
21x21	254	14.150	1	000424521
22x22	264	14.750	1	000424522
23x23	275	15.200	1	000424523
24x24	285	15.800	1	000424524
25x25	296	16.000	1	000424525
26x26	307	16.400	1	000424526
27x27	317	17.600	1	000424527
28x28	328	17.800	1	000424528
29x29	338	19.650	1	000424529
30x30	349	20.250	1	000424530
32x32	370	22.250	1	000424532
34x34	391	36.850	1	000424534
36x36	412	40.100	1	000424536

Beta H-SAFE

A Beta H-SAFE szerszám választék több mint 200 terméket tartalmaz, melyek megtartó rendszere egyedileg tervezett, hogy ellenálljon az extrém mechanikai igénybevételnek a páratlan biztonság színvonalájaként.

Használhatóság szempontjából fontos a kényelem is, ezért a kettős aktív részből álló szerszámok, mint a 42-es számú csillagvilláskulcs, egy olyan huzal segítségével csatlakoznak, amely végigfuthat a szerszámtesten, míg a csavaró mozgással használt szerszámok, mint például a csavarhúzó esetében egy szabadon elforduló gyűrűvel csatlakoznak, ami megakadályozza a rögzítőhuzal felcsavarodását.



A H-SAFE rendszert a Beta üzemeiben tervezték, tesztelték és gyártották.
A Beta H-SAFE biztonsági rendszer segítségével a szerszámok kényelmes és biztonságos módon mindig kéznél vannak.



55HS

Villáskulcs, krómozott H-SAFE



UNI-ISO 10102 DIN 3110

mm	L mm	Ft		
• 6x7	120	7.690	1	000554012
• 8x9	140	7.890	1	000554021
• 10x11	155	8.020	1	000554030
• 12x13	170	8.740	1	000554042
• 14x15	185	8.950	1	000554054
• 16x17	202	9.470	1	000554060
• 18x19	220	10.100	1	000554066
• 20x22	236	10.700	1	000554075
• 21x23	245	11.350	1	000554078
• 22x24	245	11.950	1	000554081
• 24x27	262	13.150	1	000554090
• 30x32	297	16.400	1	000554108
• 34x36	325	37.050	1	000554117

91HS-C

Feltűző csillagkulcs, krómozott H-SAFE



mm	Ø mm	Ft		
36	54	45.150	1	000914036
41	62	52.850	1	000914041
46	69	61.350	1	000914046

91HS

Feltűző csillagkulcs, krómozott H-SAFE



mm	Ø mm	Ft		
36	54	90.100	1	000914236
41	62	97.750	1	000914241
46	69	115.400	1	000914246

92HS

Csőtoldatok a 91. típusú kulcsokhoz, krómozott H-SAFE



L mm	91 mm	Ø mm	Ft		
610	32÷41	22	44.950	1	000924020
760	46÷55	25	54.050	1	000924030

93HS

Állványozó csillagkulcs állványcsavarokhoz, krómozott H-SAFE



mm	L mm	Ft		
21x22	310	26.100	1	000934021

96TBP-HS

hajlított gömbfejű imbuszkulcsok nagy nyomatékú T-markolattal, H-SAFE

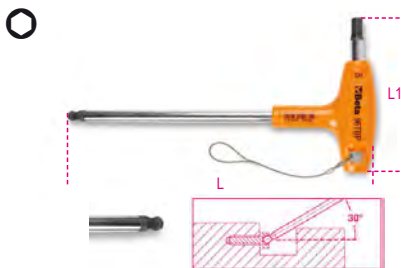

Ø mm	L mm	L1 mm	Ø mm	Ft		
2,5	153	55	4	12.350	1	000964685
3	153	55	4	12.750	1	000964686
4	179	70	5	12.950	1	000964687
5	200	84	6	13.150	1	000964688
6	221	103	7	14.150	1	000964689
8	255	117	10	16.400	1	000964690
10	285	132	12	18.000	1	000964692

96THS

T-szárú imbuszkulcs, műanyag markolattal H-SAFE

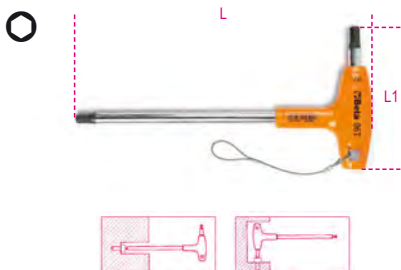

mm	L mm	L1 mm	Ft		
2,5	153	55	11.750	1	000964935
3	153	55	11.950	1	000964936
4	179	70	12.350	1	000964938
5	200	84	12.550	1	000964940
6	221	103	13.350	1	000964941
8	255	117	15.800	1	000964943
10	285	132	17.200	1	000964945

96THS-AS

T-szárú imbuszkulcs, műanyag markolattal H-SAFE



mm	L mm	L1 mm	Ø mm	Ft		
5/32	200	84	6	13.350	1	000964673
3/16	200	84	6	13.350	1	000964674
7/32	221	103	7	14.950	1	000964675
1/4	236	106	8	15.400	1	000964676
5/16	255	117	10	16.400	1	000964678
3/8	285	132	12	18.200	1	000964680

97TTXHS

T-szárú Torx®-imbuszkulcs, műanyag markolattal, krómozott, fekete hegyek H-SAFE

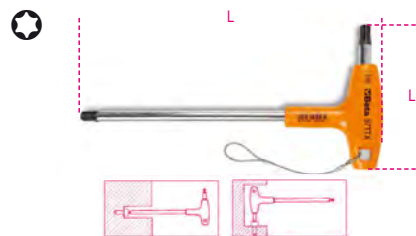

mm	L mm	L1 mm	Ft		
T10	179	70	11.950	1	000974710
T15	179	70	12.350	1	000974715
T20	179	70	12.550	1	000974720
T25	179	70	12.750	1	000974725
T30	200	84	14.750	1	000974730
T40	221	103	15.600	1	000974740
T45	236	106	16.800	1	000974745
T50	255	117	20.450	1	000974750

111E-HS

állítható villáskulcs skálával, krómozott

H-SAFE

- Jobbmenetes orsó
- Mm/coll skála



DIN 3117 ISO 6787

L mm	L mm	A max mm	Ft		
200	8	29	24.100	1	001114120
250	10	34	27.100	1	001114125
300	12	40	33.600	1	001114130
380	15	45	57.300	1	001114138
450	18	54	90.700	1	001114145

142HS

Csillag-villáskulcs irányváltós racsnival
H-SAFE



Ø mm	L mm	Ft	📦	📄
8x8	136	15.200	1	001424008
9x9	143	15.600	1	001424009
10x10	159	15.800	1	001424010
11x11	168	16.000	1	001424011
12x12	174	16.200	1	001424012
13x13	180	16.800	1	001424013
14x14	190	17.200	1	001424014
15x15	200	17.800	1	001424015
16x16	216	19.250	1	001424016
17x17	233	19.650	1	001424017
18x18	239	20.650	1	001424018
19x19	248	20.850	1	001424019
21x21	285	25.100	1	001424021
22x22	285	25.700	1	001424022
24x24	325	29.550	1	001424024
27x27	355	39.450	1	001424027
30x30	420	45.350	1	001424030
* 32x32	420	47.150	1	001424032

360HS

„Stillson” csőfogó kovácsolt acélból H-SAFE



L mm	Ø max* gas	Ft	📦	📄
250	1"	24.500	1	003604025
350	1 1/2"	30.350	1	003604035
450	2"	39.250	1	003604045
600	2 1/2"	55.850	1	003604060



LC system, kétgolyós megtartó rendszer, a tájoló csak gombnyomásra enged ki

666HS

ZERO-RESET kioldó nyomatékulcsok irányváltós racsnival jobb oldali meghúzáshoz, pontosság: ± 3%

H-SAFE

• Nem igényel visszaállítást



ISO 6789

Nm	■	D mm	A mm	L mm	LC system	■	g	📄
10÷50	3/8	30	33	342	-	680	0,25	

Ft	📦	📄
125.100	1	006664705

Nm	■	D mm	A mm	L mm	LC system	■	g	📄
20÷100	3/8	30	33	385	-	760	0,25	

Ft	📦	📄
127.100	1	006664710

Nm	■	D mm	A mm	L mm	LC system	■	g	📄
40÷200	1/2	42	43	471	*	1020	0,5	

Ft	📦	📄
142.900	1	006664721

Nm	■	D mm	A mm	L mm	LC system	■	g	📄
60÷300	1/2	42	43	600	*	1270	1,0	

Ft	📦	📄
160.300	1	006664731

900HS/55

1/4" irányváltós racsnival, H-SAFE



DIN 3122 - UNI-ISO 3315

L mm	Ø mm	A mm	■	Ft	📦	📄
127	25	29	1/4	25.300	1	009004155

910HS/55

3/8" irányváltós racsnival, H-SAFE



DIN 3122 - UNI-ISO 3315

L mm	Ø mm	A mm	■	Ft	📦	📄
207	31	33	3/8	28.950	1	009104155

920HS/55LC

1/2" irányváltós racsnival, H-SAFE



DIN 3122 - UNI-ISO 3315

L mm	Ø mm	A mm	■	Ft	📦	📄
271	40	41	1/2	41.700	1	009204159

932HS

Tizenkétszögű pipakulcs, fényes krómozott H-SAFE

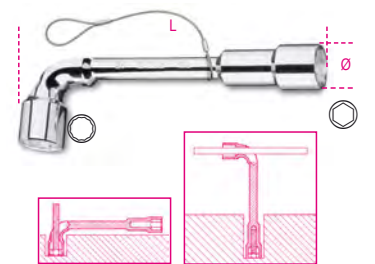

NF E 74.303

Ø mm	L mm	Ft	📦	📄
6x6	11,5	12.750	1	009324006
7x7	12,5	13.150	1	009324007
8x8	13,0	13.950	1	009324008
9x9	14,0	14.150	1	009324009
10x10	16,5	14.750	1	009324010
11x11	17,5	15.400	1	009324011
12x12	19,0	15.800	1	009324012
13x13	19,5	16.000	1	009324013
14x14	21,5	17.200	1	009324014
15x15	22,5	17.400	1	009324015
16x16	24,5	17.800	1	009324016
17x17	26,0	18.200	1	009324017
18x18	26,5	19.650	1	009324018
19x19	29,0	20.650	1	009324019



1032HS

Egyenes belső Seeger-fogó, barnított, PVC-bevonattal H-SAFE



UNI 7914 DIN 5256

L	Ø	Ø1	A	Ft		
mm	mm	mm	mm			
140x1,3	12÷25	1,3	20	17.600	1	010324014
180	19÷60	1,9	21	18.600	1	010324017

1034HS

90°-os hajlított belső Seeger-fogó, barnított, PVC-bevonattal H-SAFE



UNI 7914 DIN 5256

L	Ø	Ø1	A	Ft		
mm	mm	mm	mm			
170	19÷60	1,9	21	19.850	1	010344017

1036HS

Egyenes külső Seeger-fogó, barnított, PVC-bevonattal H-SAFE



UNI 7915 DIN 5254

L	Ø	Ø1	A	Ft		
mm	mm	mm	mm			
140x1,3	10÷25	1,3	20	18.600	1	010364014
175	19÷60	1,9	21	19.250	1	010364017

1038HS

90°-os hajlított külső Seeger-fogó, barnított, PVC-bevonattal H-SAFE



UNI 7915 DIN 5254

L	Ø	Ø1	A	Ft		
mm	mm	mm	mm			
175	19÷60	-	21	20.450	1	010384017

1048BM-HS

Vízpumpafogó, villás, bimateriál nyél H-SAFE

- Új modell új pozíciókkal
- Bimateriál-nyél



ISO 8976

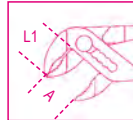

L	A max	L1	g	Ft		
mm	mm	mm				
250	48	39	460	29.350	1	010484215

1052HS

Állítható önzáró fogó, homorú pófájú, krómzott H-SAFE

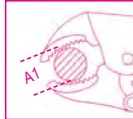

L	A	A1 max	S	Ft		
mm	mm	mm	mm			
240	72	42	10,0	24.300	1	010524024

1082BM-HS

Oldalsípófogó, krómzott, gumibetétes műanyag nyéllel H-SAFE



UNI/ISO 5749

L	L1	mm	A	Ft		
mm	mm		mm			
160	22	1,6	28,0	23.900	1	010824036

1088BM-HS

Erősített homlokcsípófogó, krómzott, gumibetétes műanyag nyéllel H-SAFE

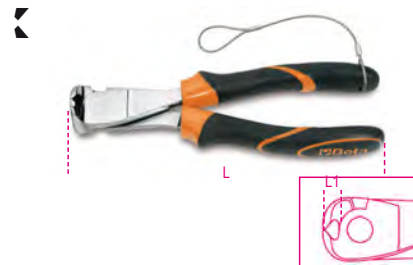

UNI/ISO 5748

L	L1	mm	A	Ft		
mm	mm		mm			
160	9	1,6	28,0	27.300	1	010884036
200	11	2,0	36,0	34.200	1	010884040

1128BAX-HS

kettős hatású villanszerelő olló, lépcsős profil, rozsdamentes acél, DLC bevonat H-SAFE

kettős hatású vágás: egy különleges bütyökkel a forgásponton létrejön a pengék hosszirányú elmozdulása, amely a zárási fázisban megnöveli a vágási teljesítményt.

lépcsős profil: 13 és 24 mm közötti furatok tágitására létrehozva műanyagokon.

DLC bevonat; A DLC (diamond-like carbon) egy újszerű, szénalapú bevonat: a nagyfokú keménység és az alacsony súrlódási együttható a felületen a grafit és gyémánt formában lerakódott szénnek köszönhető.

- nagy felületi keménység a pengénél (nagy kopásállóság és időtálló pengeélesség)
- alacsony súrlódási együttható (gördülékenység és vágási teljesítmény)
- kilazulásbiztos excentrikus csap
- széles markolat csőfogó nyakkal
- rugalmas műanyag tokkal



L	L1	mm²	Ft		
mm	mm				
150	50	50	22.650	1	011284088

1132BM-HS

Kábelvágó, krómzott, gumibetétes műanyag nyéllel H-SAFE



UNI 8791

L	mm	A	B	Ft		
mm		mm	mm			
230	18	37	12,5	41.700	1	011324143

1150BM-HS

Kombinált fogó, krómozott, polírozott, gumibetétes műanyag nyéllel H-SAFE



ISO 5746

L mm	L1 mm	mm	A mm	Ft	📦	📄
160	42	1,6	22,0	20.650	1	011504146
180	46	1,8	25,0	21.650	1	011504148
200	50	2,0	27,0	23.900	1	011504150

1166BM-HS

Egyenes extra hosszú félkerescsőrű fogó, krómozott, gumibetétes műanyag szárral H-SAFE



ISO 5745

L mm	L1 mm	mm	A mm	Ft	📦	📄
200	76	1,6	22,0	24.500	1	011664040

1168BM-HS

Hajlított extra hosszú félkerescsőrű fogó, krómozott, gumibetétes műanyag szárral H-SAFE



ISO 5745

L mm	L1 mm	mm	A mm	Ft	📦	📄
200	70	1,6	22,0	25.900	1	011684040



1290HS

Phillips®-csavarhúzó H-SAFE



ISO 2380

SxAxL mm	L1 mm	Ø mm	Ft	📦	📄
0,4x2,5x75	171	2,5	8.500	1	012904006
0,5x3x100	196	3,0	8.830	1	012904012
0,6x3,5x100	196	3,5	9.350	1	012904021
0,8x4x100	196	4,0	9.190	1	012904030
0,8x4x150	246	4,0	9.800	1	012904036
1x5,5x150	259	5,0	10.950	1	012904042
1,2x6,5x150	270	6,0	11.550	1	012904051
1,2x8x150	282	7,0	12.750	1	012904057
1,6x10x200	332	8,0	15.200	1	012904066

1292HS

Csavarhúzó Phillips®-csavarokhoz H-SAFE



UNI/ISO 8764

PHxDxL mm	L1 mm	Ft	📦	📄
0x3x100	196	8.910	1	012924006
1x4,5x120	229	9.840	1	012924012
2x6x150	270	11.750	1	012924021
3x8x150	282	13.550	1	012924024

1294HS

Csavarhúzó hernyócsavarokhoz H-SAFE



SxDxL mm	L1 mm	Ft	📦	📄
0,5x2,5x60	156	8.300	1	012944003
0,6x3x75	171	8.380	1	012944006
0,8x4x100	196	9.230	1	012944012
1x5x125	234	10.700	1	012944018

1299HS

Csavarhúzó Pozidriv®- és Supadriv®-csavarokhoz H-SAFE



UNI/ISO 8764

PZ	L mm	L1 mm	Ft	📦	📄
0	60	156	9.310	1	012994000
1	80	189	10.300	1	012994003
2	100	220	12.750	1	012994006
3	150	282	16.000	1	012994009

1370T-HS

Lakatos kalapács német modellműanyag nyéllel H-SAFE



g	A mm	L mm	L1 mm	Ft	📦	📄
300	23	300	105	17.600	1	013704630
500	27	320	118	19.000	1	013704650
1000	36	360	135	23.900	1	013704700

1370FT-HS

Lakatos kalapács, francia modell, műanyag nyéllel H-SAFE



A mm	L mm	L1 mm	B mm	Ft	📦	📄
28	280	86	22	24.300	1	013704528
30	280	92	24	24.500	1	013704530
36	300	104	29	28.950	1	013704536

1390HS

Műanyag kalapács, cserélhető végekkel, fanyéllal H-SAFE



UNI 7784

D mm	L mm	L1 mm	Ft	📦	📄
35	310	95	22.250	1	013904035
45	320	107	31.550	1	013904045

1392HS

Ütéselnyelő műanyag kalapács, cserélhető végekkel, acélnyéllel



D mm	L mm	L1 mm	Ft	1	1
35	305	115	32.400	1	013924035
40	310	125	36.050	1	013924040
50	325	135	42.100	1	013924050
60	385	155	61.350	1	013924060

1602A-HS

Saruzófogó szigetelt kábelsarukhoz, standard modell, krómozott, műanya g szárral H-SAFE

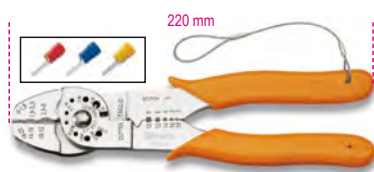

mm ²	L mm	A mm	B mm	Ft	1	1
0÷6	220	42	4	34.200	1	016024005

1682HS

Rugalmas skálás vonalzó, rozsdamentes acélból H-SAFE



L mm	H mm	± mm	Ft	1	1
200	13	0,5	7.690	1	016824020
300	13	0,5	8.740	1	016824030

1692HS

Mérőszalag, ütészálló bimateriál ABS-ház, acélszalag, pontosság: II H-SAFE

CE



L m	S mm	Ft	1	1
3	16	10.300	1	016924053
5	19	12.350	1	016924055

1708HS/20

Metrikus hézagmérő H-SAFE

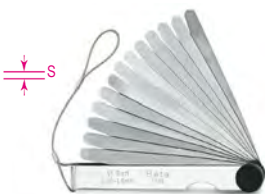

S mm	S mm	L mm	Ft	1	1
0,05÷1,0	0,002÷0,040	105	11.350	1	017084020

1727HS

Erősített fűrész, fűrészkeret lakkozott acélból, fanyéllal, bimetal fűrészlappal H-SAFE

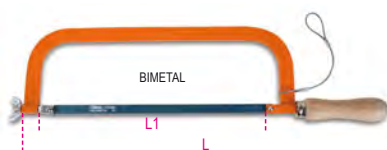

L mm	L1 mm	Ft	1	1
515	300	15.800	1	017274001

1743HS

Kábelkötegelő fogó H-SAFE

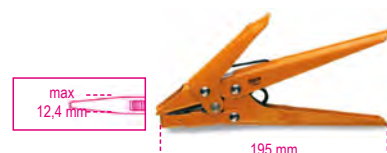

L mm	A mm	B mm	Ft	1	1
195	85	17	32.800	1	017434001

1750HS

Karoszszívó H-SAFE



1 g, 550 bar Max

cc	L mm	Ft	1	1
500	380	27.550	1	017504500

1760BHS

Univerzális digitális multiméter H-SAFE

CE



VÉGREHAJTHATÓ MÉRÉSEK

Feszültség DC: 200 mV-2/20/200/1000V

Feszültség AC: 2-20/200/700V

Áram DC: 2/20/200 mA-20 A

Áram AC: 2/200 mA- 20 A

Ellenállás: 200Ω - 2/20/200 kΩ - 2/20 MΩ

Kapacitás: 2/20/200 nF - 2/200 μF

Hőmérséklet: -20° + 1000°C/ -4 °F ~ +2000°F

Frekvencia: 20kHz

Tápegység: 1 9V-elem (együtt szállítva)

1760BHS	Ft	1	1
	108.900	1	017604012

1772H-HS

Kés behúzóható pengével, 1 tartalék pengével H-SAFE



L mm	A mm	Ft	1	1
170	18	14.150	1	017724029



1778S0S-HS

autós elsősegély kés,
ablaktörő kalapács és
biztonsági öv vágó funkcióval,
tokban,
H-SAFE



L mm	A mm	L1 mm	Ft	1	017784080
205	25	85	22.650	1	017784080

8871

Biztonsági öv, fémcstanggal és dupla zárral



L cm min-max	Ft	1	088710070
8871 70 70-100	64.350	1	088710070
8871 100 100-135	69.650	1	088710100

8872A

Merev szíj

• 8871 övhöz



Ft	1	088720050
8872A 50	11.350	1 088720050

8872AS

A zár húzással nyílik

• 8871 övhöz



D mm	Ft	1	088720525
8872AS 25	10.300	1	088720525

8873

Munkaeszköz hordozó zsák önzáró és
zipzáras zárral

• 8871 övhöz



Ft	1	088730230
8873 230	54.650	1 088730230

8877

Amortizált csatoló heveder

• MAX 2.7 kg



L cm min-max	DxL mm	Ft	1	088770080
8877 80 70-110	40x80	13.950	1	088770080

8877M

Amortizált csatoló heveder

• Tekeredés megelőző csatlakozóval • MAX 2.7 kg



L cm min-max	DxL mm	Ft	1	088770510
8877M 20-140	30x60	24.900	1	088770510

8879

Csuklóvédő húzással nyílik

• MAX 2.7 kg



D mm	Ft	1	088790025
8879 30	16.000	1	088790025

8880

Merev csatoló heveder

• Tekeredés megelőző csatlakozóval



L Cm	D mm	Ft	1	088800030
8880 30	30	12.550	1	088800030

8883

Munkaeszköz hordozó zsák

• 840-es, dörzsölés megelőző nylon • MAX 20 kg • A zipzárt a
zárvégén blokkoló karabéllyal • 6 munkaeszköz rögzítő
hevederrel • Belső zsebbel



DxH Cm	Ft	1	088830030
8883 30x40	132.000	1	088830030





NEMESACÉL SZERSZÁMOK



A Beta Inox szerszámokat olyan speciális helyeken használják, ahol a korrózió nem megengedett.

Néhány példa:

- Nukleáris területek
- Gyógyszeripar - C osztály
- Vegyes külszíni munka
- Biotechnológiai és bio orvostudományi laboratóriumok
- Élelmiszeripar

A Beta Inox szerszámok nem rozsdásodnak.

A nem rozsdamentes anyagokból készített szerszámok használata során a csavarokon és anyákon a részecskék leválnak, a korróziós folyamat megindul és ez esztétikai problémát és néhány esetben strukturális problémát is okoz.

Felhasználási területek:

- Hajóépítés,
- Építőipar,
- Szolárberendezések,
- Autóipar.



ROZSDAMENTES
ACÉL
+ NEM
ROZSDAMENTES
ACÉL SZERSZÁM=
ROZSDA

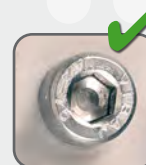

ROZSDAMENTES
ACÉL
+ ROZSDAMENTES
ACÉL SZERSZÁM=
NINCS
ROZSDA

TULAJDONSÁGAI

Az anyagok gondos megválasztása és a jobb hőkezelés a Beta Inox szerszámoknak olyan mechanikai tulajdonságokat kölcsönöznek, amelyek közül néhány - az átlagos Beta szerszámok tulajdonságaival összehasonlítva - azokat felülmúlja.

A termékek ergonómiája és dizájnja ugyanaz, mint a több mint 75 éve ismert és a felhasználók által nagyra értékelt Beta szerszámoké.

Fontos tulajdonság továbbá, hogy a rozsdamentes acél 100%-ban újrahasznosítható.



Rozsdamentes acélból készült termékek logója. A Centro Inox - az Olasz Rozsdamentes Acél Fejlesztési Szövetség - által kiadott logó, amely védjegyzeti a rozsdamentes acélból készült termékeket.

34INOX

Laposvágó,
rozsdamentes acélból



L mm	A mm	Ø mm	Ft		
100	14	14	14.750	1	000340314
160	18	18	19.650	1	000340318
200	20	20	28.950	1	000340320

39INOX

Támasztóék,
rozsdamentes acélból



L mm	A mm	S mm	Ft		
100	50	10	13.550	1	000390310
150	50	13	24.500	1	000390315
200	40	40	71.650	1	000390320

42INOX

Csillag-villáskulcs,
rozsdamentes acélból

- Keskeny fejek
- Nagy korrozíóállóság
- Kiváló műszaki tulajdonságok



DIN 3113 - UNI ISO 7738

mm	L mm	Ft		
6x6	95	6.800	2	000420306
7x7	105	7.090	2	000420307
8x8	116	7.130	2	000420308
9x9	127	7.650	2	000420309
10x10	137	8.100	2	000420310
11x11	148	8.790	2	000420311
12x12	158	9.150	2	000420312
13x13	169	9.230	2	000420313
14x14	180	9.550	2	000420314
15x15	190	9.840	2	000420315
16x16	201	10.100	2	000420316
17x17	212	11.350	2	000420317
18x18	222	12.350	2	000420318
19x19	233	13.150	2	000420319
21x21	254	16.000	1	000420321
22x22	264	16.400	1	000420322
24x24	285	18.200	1	000420324
27x27	290	56.450	1	000420327
30x30	320	69.000	1	000420330
32x32	340	75.300	1	000420332
36x36	360	105.700	1	000420336
38x38	430	112.600	1	000420338
41x41	430	132.400	1	000420341
46x46	480	151.800	1	000420343
50x50	520	164.000	1	000420345
55x55	560	177.300	1	000420347
60x60	595	197.200	1	000420350



		Ft		
42INOX/S11		103.200	1	000420391
6-8-10-11-12-13-14-15-16-17-19 mm				



		Ft		
42INOX/SC9		90.100	1	000420387
8-10-11-12-13-14-15-17-19 mm				
42INOX/SCV9		4.740	1	000420303

42INOX-AS

Csillag-villáskulcs,
rozsdamentes acélból



"	L mm	Ft		
1/4x1/4	95	8.180	1	000420356
5/16x5/16	116	8.300	1	000420358
3/8x3/8	137	9.920	1	000420360
7/16x7/16	148	10.700	1	000420361
1/2x1/2	169	11.150	1	000420363
9/16x9/16	180	11.750	1	000420364
5/8x5/8	201	12.550	1	000420366
11/16x11/16	212	14.550	1	000420367
3/4x3/4	233	15.800	1	000420369
13/16x13/16	254	18.200	1	000420371
7/8x7/8	264	19.250	1	000420372
15/16x15/16	285	21.650	1	000420373



		Ft		
42INOX-AS/S9		102.900	1	000420396
1/4-5/16-3/8-7/16-1/2-9/16-5/8-11/16-3/4				



96BPINOX

Hajlított gömbfejű imbuszkulcs,
rozsdamentes acélból



mm	L mm	L1 mm	g	Ft		
2	91	22	4	2.410	4	000961441
2,5	91	22	6	2.410	4	000961442
3	101	24	11	2.530	4	000961443
4	112	29	19	2.850	4	000961444
5	131	33	32	3.380	4	000961445
6	154	36	51	3.720	4	000961446
7	164	40	65	4.860	2	000961447
8	175	44	116	5.910	2	000961448
10	197	51	189	7.330	2	000961450



		Ft		
96BPINOX/B6		23.700	1	000961455
2,5-3-4-5-6-8 mm				
96BPINOX/B9		38.300	1	000961456
2-2,5-3-4-5-6-7-8-10 mm				
96BPINOX/BV		2.890	1	000961459

96BPINOX-AS

Hajlított hatlapfejű belső kulcs
gömbölyű szélekkel,
rozsdamentes acélból



"	L mm	L1 mm	g	Ft		
5/64	91	22	5,5	3.100	4	000961989
3/32	91	22	5,3	3.100	4	000961990
7/64	101	24	10,5	3.320	4	000961991
1/8	101	24	10,7	3.320	4	000961992
9/64	112	29	18,7	3.620	4	000961993
5/32	112	29	18,7	3.620	4	000961994
3/16	131	33	31,5	4.860	2	000961995
7/32	154	36	50,0	5.020	2	000961996
1/4	164	40	70,0	5.340	2	000961997
5/16	175	44	115,0	6.320	2	000961998
3/8	197	51	186,5	7.850	2	000961999



		Ft		
96BPINOX-AS/B8		37.550	1	000962000
5/64-3/32-1/8-5/32-3/16-7/32-1/4-5/16				
96BPINOX/BV		2.890	1	000961459

96TINOX

T-szárú imbuszkulcs markolattal, rozsdamentes acélból

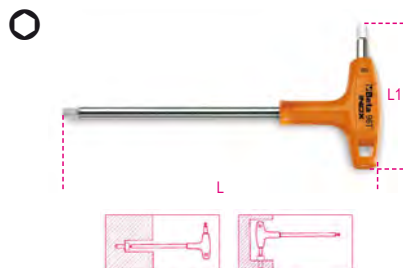

mm	L mm	L1 mm	Ft	🔧	📦
2,5	153	55	5.790	2	000961935
3	153	55	6.030	2	000961936
4	179	70	6.600	2	000961938
5	200	84	7.290	2	000961940
6	221	95	7.980	2	000961941
7	236	106	9.190	2	000961942
8	255	117	10.950	2	000961943
10	285	132	13.950	2	000961944



96TINOX/S5	Ft	🔧	📦
2,5-3-4-5-6 mm	33.700	1	000961952
96TINOX/S8	Ft	🔧	📦
2,5-3-4-5-6-7-8-10 mm	67.750	1	000961954

96TINOX-AS

T szárú belső hatlapfejű kulcs műanyag markolattal, rozsdamentes acélból

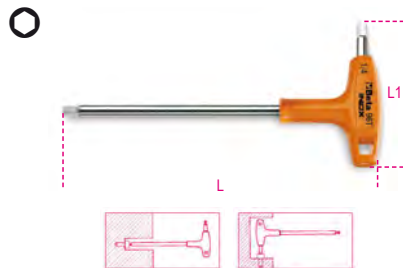

"	L mm	L1 mm	Ø mm	Ft	🔧	📦
3/32	153	55	3	6.320	2	000961861
7/64	153	55	4	6.440	2	000961862
1/8	179	70	4	7.250	2	000961863
9/64	179	70	5	7.410	2	000961864
5/32	200	84	6	7.810	2	000961865
3/16	200	84	6	8.380	2	000961866
7/32	221	103	7	9.760	2	000961867
1/4	236	106	8	10.100	2	000961868
5/16	255	117	10	12.550	2	000961869
3/8	285	132	12	13.550	2	000961870



96TINOX-AS/S7	Ft	🔧	📦
3/32-1/8-5/32-3/16-7/32-1/4-5/16	62.200	1	000961877

111INOX

Állítható görgős villáskulcs, rozsdamentes acélból



DIN 3117 - ISO 6787

L mm	L mm	A max mm	A1 mm	Ft	🔧	📦
150	6	18	45	41.900	1	001110315
200	8	24	58	57.900	1	001110320
250	10	30	70	72.650	1	001110325

362INOX

Amerikai csőfogó, rozsdamentes acélból



L mm	Ø max mm	Ft	🔧	📦
300	58	97.950	1	003620430

920INOX-A

Kézi dugókulcs hatlapú kialakítás, rozsdamentes acélból



DIN 3124 - UNI ISO 2725

mm	Ø mm	A mm	L mm	Ft	🔧	📦
8	15	10	40	14.550	2	009203008
9	16	10	40	15.400	2	009203009
10	17	10	40	16.000	2	009203010
11	18	11	40	17.200	2	009203011
12	19	11	40	18.200	2	009203012
13	20	11	40	19.450	2	009203013
14	21	11	40	20.250	2	009203014
15	23	11	40	21.450	2	009203015
16	24	11	40	22.250	2	009203016
17	25	11	40	22.850	2	009203017
18	26	13	42	23.900	2	009203018
19	28	13	42	24.700	2	009203019
20	29	13	42	26.300	1	009203020
21	30	13	43	26.700	1	009203021
22	31	15	43	26.900	1	009203022
24	34	15	43	31.350	1	009203024
27	38	18	46	38.450	1	009203027
30	42	20	46	45.750	1	009203030
32	44	20	46	51.600	1	009203032



920/55INOX

Írányváltós racsní 1/2" négyszögű külső csatlakozóval 72 fogas mechanizmus, rozsdamentes acélból



L mm	Ø mm	A mm	Ft	🔧	📦
264	40	43	110.900	1	009203882

920/R55INOX



920/R55 INOX	Ft	🔧	📦
	39.450	1	009203879

1048INOX

Vízpumpa fogó, zárt csuklós, rozsdamentes acélból

• 7 állású modell



L mm	A max mm	L1 mm	Ft	🔧	📦
250	33	33	75.700	1	010480325

1082INOX

Oldalcsípőfogó, rozsdamentes acélból



L mm	L1 mm	mm	Ft	🔧	📦
150	20,0	1,6	54.850	1	010820350

1150INOX

Robosztus kombinált fogó,
rozsdamentes acélból
decentralizált csap
nyitott csukló
decentralizált csap
szabad csukló



L	L1	Ft		
mm	mm			
180	39	50.200	1	011500518

1153INOX

Kétállású, állítható kombináltfogó,
rozsdamentes acélból



L	L1	Ft		
mm	mm			
150	26	52.000	1	011530315

1290INOX

Csavarhúzó hasítottfejű csavarokhoz,
szár rozsdamentes acélból

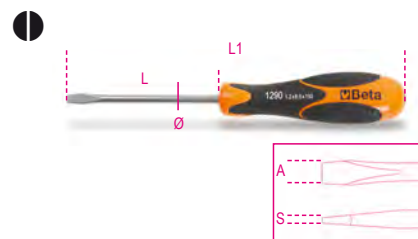

ISO 2380

SxAxL	L1	Ø	Ft		
mm	mm	mm			
0,4x2,5x50	146	2.5	4.210	4	012900403
0,5x3x75	171	3.0	4.330	4	012900409
0,8x4x100	196	4.0	4.490	4	012900430
1,0x5,5x150	259	5.0	5.750	4	012900442
1,2x6,5x150	270	6.0	6.600	4	012900451

1292INOX

Csavarhúzó Phillips®-csavarokhoz,
szár rozsdamentes acélból

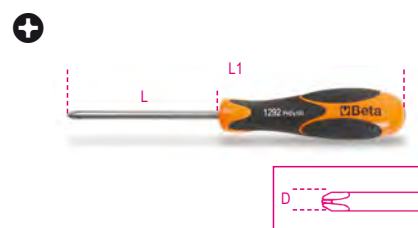

ISO 8764

PHxDxL	L1	Ft		
mm	mm			
0x3x60	156	3.950	4	012920403
1x4,5x80	189	4.700	4	012920409
2x6x100	220	5.750	4	012920418

1293INOX/D8

8 darabos csavarhúzókészlet,
rozsdamentes acélból



1293INOX/D8		Ft		
		39.750	1	012930408
1290INOX	0,4x2,5x50-0,5x3x75 0,8x4x100-1,0x5,5x150 1,2x6,5x150 mm			
1292INOX	PH0x60-PH1x80 PH2x100 mm			

1370INOX

Szerelőkalapács
német modell,
rozsdamentes acélból



	A	L	L1	Ft		
g	mm	mm	mm			
500	25	240	101	47.550	1	013700375

1377INOX

Gömbvégű és kerekfejű
kalapács,
kazánkovácsok és bádigosok számára,
rozsdamentes acélból



	L	L1	Ft		
g	mm	mm			
230	220	82	27.550	1	013770623
340	220	90	39.650	1	013770634

1730INOX

Univerzális spakli,
rozsdamentes acélból



A	L	Ft		
mm	mm			
50	200	24.300	1	017300450

C20TSS

Ötkezes szerszámos láda rozsdamentes
acélból (AISI 304)



C20TSS	Ft		
	138.100	1	021203001
☰: 450x200x210 mm - 📦 4 Kg			

T23



T23	560
TV23	560

T99



T99	563
TV99	563

T228



T228	567
TV180	566-567

C04TSS-7

7 fiókos szerszámkocsi teljesen rozsdamentes acélból Nem hagynak nyomot a kerekek.

Főbb jellemzők:

- Hét darab 570 x 410 mm teleszkópos, csapágyazott fiókkal;
- 6 fiók magassága 83 mm;
- 1 fiók magassága 170 mm;
- 4 kerék Ø 125 mm
- 2 rögzített és 2 elfordítható (kettő fékkel)
- Központi zár elől;
- Teljesen rozsdamentes acél szerkezet;
- Kerekek, tartóelemek, csapágyak, fiókbelső és fiókvezetők rozsdamentes acélból
- Alumínium fiókfogantyúk

63 kg

Beta
INOX
STAINLESS STEEL

700
kg

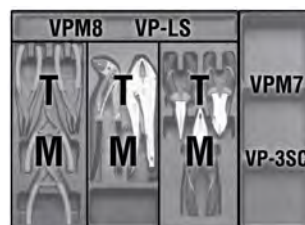

h		↓ max
83 mm		25 kg
170 mm		30 kg

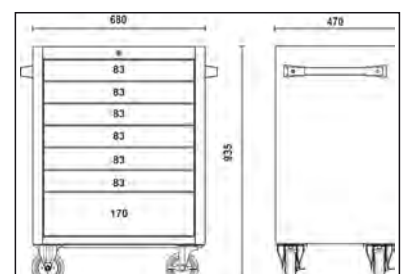
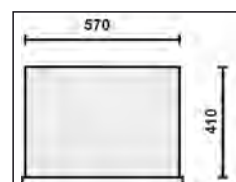



SZIKRAMENTES SZERSZÁMOK



RÉZ-BERILIUM (CU-BE)

A specifikus **Beta** szikramentes szerszámok biztonságosan használhatók olyan robbanásveszélyes helyeken, ahol gyúlékony folyadékok, vagy gázok fordulnak elő, ahol antimágneses és extrém korróziómentes szerszámok használata kötelező.



Beta szikramentes szerszámokat a BAM (Szövetségi Anyagkutató és Vizsgáló Intézet) a 99/92/EC Európai Irányelvnek megfelelően tanúsítja.



FIGYELEM! Robbanásveszély lehetséges ACETILÉN-es környezetben.

A szikramentes szerszámok mechanikai tulajdonságai mások, mint az átlagos acélszerszámoké. Ajánlatos ezeket megfelelő körülményekkel és óvatossággal használni és a túlterhelést elkerülni.

ROBBANÁSVESZÉLYES ZÓNÁK

		ROBBANÁSVESZÉLYES ZÓNÁK	
ATEX		KÖZEPES ALACSONY	NAGYON ALACSONY
GÁZ		ZONE 1 Az a térség, ahol normál üzemmódban robbanásveszélyes gyúlékony gáz, pára vagy köd levegővel keveredve atmoszférikus környezetben alkalmanként van jelen.	ZONE 2 Az a térség, ahol normál üzemmódban robbanásveszélyes gyúlékony gáz, pára vagy köd levegővel keveredve atmoszférikus környezetben ritkán, rövid ideig, rendszertelenül van jelen.
	POR	ZONE 21 Az a térség, ahol normál üzemmódban robbanásveszélyes gyúlékony por levegővel keveredve atmoszférikus környezetben gyakorta, vagy rendszeresen képződhet.	ZONE 22 Az a térség, ahol normál üzemmódban robbanásveszélyes gyúlékony por levegővel keveredve atmoszférikus környezetben normális módon nem vagy csak rövid ideig képződik.

30BA

Kiütő, szikramentes



Ø mm	L mm	S mm	Ft	📄	📁
5	150	15	32.400	1	000300806
8	150	17	39.850	1	000300808
10	150	19	49.400	1	000300810

31BA

Kiütő, szikramentes



Ø mm	L mm	Ft	📄	📁
3	110	13.950	1	000310853
4	110	30.350	1	000310854
6	115	46.350	1	000310856
8	120	52.400	1	000310858

31BA/C

szikramentes Kiütő pontozók



Ø mm	Ø1 mm	L mm	Ft	📄	📁
*6	12	150	19.000	1	000310876
*7	13	150	22.250	1	000310877
*12	18	175	47.350	1	000310882
*13	29	255	148.600	1	000310883

32BA

szikramentes pontozó



Ø mm	L mm	Ft	📄	📁
14	150	44.550	1	000320811

34BA

Laposvágó, szikramentes



L mm	A mm	Ft	📄	📁
200	22	60.500	1	000340801
250	24	101.000	1	000340803
300	25	136.400	1	000340802

39BA

Vékony laposvágó, szikramentes



L mm	A mm	Ft	🔧	📦
150	40	26.500	1	000390801
230	40	88.850	1	000390802
250	40	138.900	1	000390803

42BA

Csillag-villáskulcs, szikramentes



mm	L mm	Ft	🔧	📦
6x6	105	28.350	1	000420806
7x7	105	31.800	1	000420807
8x8	120	35.600	1	000420808
9x9	120	40.700	1	000420809
10x10	135	43.900	1	000420810
11x11	135	46.350	1	000420811
12x12	150	50.800	1	000420812
13x13	150	52.400	1	000420813
14x14	175	54.850	1	000420814
15x15	175	57.900	1	000420815
16x16	195	60.100	1	000420816
17x17	200	62.950	1	000420817
18x18	215	70.650	1	000420818
19x19	220	71.850	1	000420819
20x20	230	75.100	1	000420820
21x21	240	79.750	1	000420821
22x22	250	84.800	1	000420822
24x24	268	98.400	1	000420824
26x26	290	119.000	1	000420826
27x27	290	132.400	1	000420827
28x28	290	155.500	1	000420828
30x30	313	158.700	1	000420830
32x32	333	174.500	1	000420832
34x34	360	190.300	1	000420834
35X35	360	215.400	1	000420835
36x36	355	225.100	1	000420836
38x38	430	236.800	1	000420838
41x41	430	278.900	1	000420841
46x46	480	326.300	1	000420846
50x50	520	345.700	1	000420850
55x55	560	380.200	1	000420855
60x60	580	405.700	1	000420860
*65x65	595	462.300	1	000420865
*70x70	630	520.200	1	000420870

42BA-AS

Csillag-villáskulcs, szikramentes



mm	L mm	Ft	🔧	📦
9/32x9/32	120	30.350	1	000420946
5/16x5/16	120	30.350	1	000420947
11/32x11/32	135	38.650	1	000420948
3/8x3/8	128	40.700	1	000420950
7/16x7/16	135	46.350	1	000420951
15/32x15/32	140	51.000	1	000420949



mm	L mm	Ft	🔧	📦
1/2x1/2	140	53.050	1	000420953
9/16x9/16	163	57.300	1	000420954
*19/32x19/32	195	68.800	1	000420955
5/8x5/8	177	69.250	1	000420956
11/16x11/16	195	73.900	1	000420957
3/4x3/4	215	76.100	1	000420959
13/16x13/16	230	88.850	1	000420961
7/8x7/8	235	92.100	1	000420962
15/16x15/16	256	102.400	1	000420964
*31/32x31/32	265	112.600	1	000420963
1x1	266	110.900	1	000420965
1.1/16x1.1/16	283	125.100	1	000420967
1.1/8x1.1/8	297	164.800	1	000420969
1.3/16x1.3/16	308	177.700	1	000420970
1.1/4x1.1/4	324	209.300	1	000420973
*1.7/16x1.7/16	360	253.800	1	000420976

55BA

Villáskulcs, szikramentes



mm	L mm	Ft	🔧	📦
6x7	90	19.450	1	000550801
8x9	100	20.850	1	000550802
8x10	100	21.650	1	000550795
9x11	110	22.850	1	000550797
10x11	120	24.500	1	000550803
12x13	130	30.950	1	000550804
*12x14	130	37.450	1	000550846
13x14	133	37.250	1	000550799
14x15	145	37.450	1	000550805
14x17	150	39.850	1	000550806
16x17	165	40.500	1	000550807
17x19	170	53.050	1	000550847
18x19	170	54.050	1	000550809
*19x22	185	61.750	1	000550810
20x22	185	62.150	1	000550811
21x23	210	68.000	1	000550813
22x24	210	80.750	1	000550815
24x26	230	94.950	1	000550817
24x27	230	101.000	1	000550818
25x28	230	109.700	1	000550819
27x29	246	128.300	1	000550820
30x32	265	150.200	1	000550822
36x38	320	190.300	1	000550826
36x41	335	209.300	1	000550828
41x46	355	259.900	1	000550829
*46x50	370	298.000	1	000550830
*50x55	385	317.000	1	000550831
*55x60	415	393.100	1	000550832

55BA-AS

Villáskulcs, szikramentes



mm	L mm	Ft	🔧	📦
3/8x7/16	110	25.300	1	000550853
1/2x9/16	130	30.350	1	000550854
5/8x11/16	160	44.550	1	000550857
3/4x13/16	180	54.850	1	000550859
7/8x15/16	210	77.550	1	000550865
1x1.1/16	230	104.900	1	000550868
1.1/8x1.3/16	245	136.400	1	000550870
1.1/4x1.5/16	255	161.100	1	000550872

58BA

Ütővilláskulcs, szikramentes



mm	L mm	Ft	🔧	📦
17	125	51.800	1	000580817
19	125	53.850	1	000580819
22	135	54.050	1	000580822
24	150	60.950	1	000580824
27	165	74.900	1	000580827
30	180	93.700	1	000580830
32	190	109.700	1	000580832
*34	200	125.500	1	000580834
36	210	130.000	1	000580836
38	220	142.900	1	000580838
41	230	161.100	1	000580841
46	240	192.700	1	000580846
50	255	219.000	1	000580850
*55	305	272.900	1	000580855
*60	315	317.000	1	000580860
*65	335	368.000	1	000580865
*70	370	444.100	1	000580870
*75	375	514.200	1	000580875
*80	400	615.400	1	000580880
*85	400	724.700	1	000580885
*90	445	860.300	1	000580890
*95	445	996.000	1	000580895
*100	485	1.153.800	1	000580900
*110	513	1.425.100	1	000580901

58BA-AS



mm	L mm	A mm	S mm	Ft	🔧	📦
*11/16	125	40,5	11,0	57.300	1	000580904
*3/4	125	40,5	11,0	58.300	1	000580905
*7/8	135	46,2	12,0	59.700	1	000580906
*15/16	150	50,3	12,0	68.400	1	000580907
*31/32	150	50,3	12,0	76.500	1	000580954
*1	175	56,9	15,0	79.350	1	000580908
*1.1/8	190	64,0	15,5	102.000	1	000580909
*1.1/4	190	64,0	15,5	119.800	1	000580910
*1.7/16	210	75,0	18,5	138.900	1	000580912
*1.1/2	220	82,0	18,5	165.200	1	000580913
*1.5/8	230	86,8	18,5	177.700	1	000580914
*1.3/4	250	98,0	20,	225.100	1	000580970

78BA

Ütőcsillagkulcs, szikramentes



mm	L mm	Ft	🔧	📦
17	145	54.050	1	000780817
19	145	59.500	1	000780819
22	165	60.500	1	000780822
24	140	73.900	1	000780824
27	155	84.800	1	000780827
30	165	98.400	1	000780830
32	180	106.500	1	000780832
34	192	117.000	1	000780834
36	208	130.000	1	000780836
38	215	152.200	1	000780838
41	225	181.000	1	000780841
46	245	202.000	1	000780846
50	250	234.800	1	000780850
55	265	272.900	1	000780855

Ø mm	L mm	Ft	📄	📄
60	275	294.700	1	000780860
65	295	317.000	1	000780865
70	310	358.700	1	000780870
75	325	402.400	1	000780875
80	340	431.200	1	000780880
*85	355	548.600	1	000780885
*90	380	643.700	1	000780890
*95	390	749.000	1	000780895
*100	410	852.200	1	000780900
*105	420	943.300	1	000780903
*110	445	1.076.900	1	000780901
*120	480	1.275.300	1	000780902

78BA-AS

Tizenkétszögű ütőcsillagkulcs, szikramentes



Ø "	L mm	Ft	📄	📄
11/16	145	53.650	1	000780908
3/4	145	55.650	1	000780909
7/8	155	62.150	1	000780935
15/16	165	68.800	1	000780936
*31/32	165	80.350	1	000780937
1	175	80.350	1	000780938
*1.1/16	175	95.350	1	000780939
1.1/8	180	96.150	1	000780940
1.3/16	185	100.200	1	000780941
1.1/4	177	109.300	1	000780910
*1.5/16	200	110.900	1	000780954
*1.3/8	205	116.200	1	000780911
1.7/16	208	144.900	1	000780912
*1.1/2	215	151.000	1	000780913
*1.9/16	225	187.000	1	000780947
*1.11/16	225	197.200	1	000780962
1.5/8	225	183.000	1	000780914
*1.3/4	235	202.000	1	000780963
1.13/16	243	209.300	1	000780916
1.7/8	235	236.800	1	000780915
2	254	246.200	1	000780918
2.3/16	264	288.300	1	000780920
2.3/8	275	314.200	1	000780922
*2.9/16	286	326.300	1	000780924
*2.15/16	311	396.000	1	000780926
*3.1/8	325	459.500	1	000780928
*3.1/2	355	578.900	1	000780930

89BA

Egyoldalas csillagkulcs, szikramentes



Ø mm	L mm	Ft	📄	📄
10	200	61.550	1	000890810
11	210	63.750	1	000890811
12	220	66.200	1	000890812
13	230	68.000	1	000890813
14	240	68.800	1	000890814
16	260	73.900	1	000890816
17	270	76.500	1	000890817
18	280	82.600	1	000890818
19	300	85.200	1	000890819
20	310	106.500	1	000890820
22	330	106.500	1	000890822
24	350	116.600	1	000890824
27	370	143.700	1	000890827
30	400	161.100	1	000890830
32	420	169.600	1	000890832

90BA

Hajlított csillagkulcs, szikramentes



Ø mm	L mm	Ft	📄	📄
6x7	122	19.650	1	000900801
8x9	128	25.300	1	000900802
10x11	155	28.750	1	000900803
12x13	175	33.600	1	000900806
12x14	180	36.050	1	000900807
14x15	200	40.500	1	000900808
14x17	220	41.300	1	000900809
16x17	230	48.600	1	000900811
16x18	235	48.600	1	000900812
17x19	250	49.800	1	000900814
18x19	265	54.850	1	000900815
19x22	280	57.900	1	000900817
20x22	295	65.800	1	000900818
21x23	298	69.250	1	000900820
22x24	315	83.800	1	000900821
24x26	333	107.700	1	000900822
24x27	340	107.700	1	000900823
30x32	395	158.700	1	000900824
34x36	410	225.100	1	000900826
*36x41	450	304.000	1	000900828
*41x46	470	373.700	1	000900829
*46x50	490	415.000	1	000900830

91BA

Szikramentes feltűző csillagkulcs



Ø mm	Ø mm	Ft	📄	📄
24	38	130.000	1	000910824
27	42	155.500	1	000910827
30	48	177.700	1	000910830
32	49	198.800	1	000910832
36	54	215.400	1	000910836
41	62	241.300	1	000910841
*46	69	320.200	1	000910846
*50	75	342.500	1	000910850
*55	82	396.000	1	000910855

92BA

Toldószár a 91BA modellhez, szikramentes



	L mm	91BA mm	Ø mm	Ft	📄	📄
92BA/1	460	24÷30	25	153.800	1	000920810
92BA/2	610	32÷41	28	198.800	1	000920820
*92BA/3	760	46÷55	32	266.400	1	000920830

93BA

Állványozó csillagkulcs, lapos, speciális fejkiképzés



Ø mm	L mm	Ft	📄	📄
21x22	345	320.200	1	000930821

95BA

Egyenes csillagkulcs, szikramentes



Ø mm	L mm	Ft	📄	📄
7x9	115	19.450	1	000950801
8x10	115	21.650	1	000950802
10x11	140	23.900	1	000950804
10x12	140	28.350	1	000950805
12x14	145	32.400	1	000950806
14x17	165	38.650	1	000950807
*16x18	170	50.400	1	000950809
*17x19	185	43.900	1	000950808
*18x19	185	54.850	1	000950810
*19x22	200	68.400	1	000950812
*21x23	230	75.500	1	000950815
*24x27	255	96.150	1	000950817
*30x32	295	144.900	1	000950820

96BA

Hajlított hatlapú imbusz kulcs, szikramentes



mm	L mm	L1 mm	Ft	📄	📄
1,5	50	17	39.850	1	000960760
2	50	16	40.700	1	000960762
2,5	56	20	43.700	1	000960761
3	63	21	44.350	1	000960763
4	69	25	46.750	1	000960764
5	78	29	48.600	1	000960765
6	88	33	49.400	1	000960766
7	93	34	51.800	1	000960767
8	97	36	54.850	1	000960768
9	104	37	57.700	1	000960769
10	110	39	59.500	1	000960770
11	118	42	63.150	1	000960771
12	122	44	72.450	1	000960772
14	150	58	80.750	1	000960774
15	156	60	85.200	1	000960775
16	162	63	93.700	1	000960776
17	168	65	98.400	1	000960777
19	177	72	110.100	1	000960779
22	186	77	128.700	1	000960802
24	192	82	148.600	1	000960804

96BA/BP

Hajlított gömbfejű imbusz kulcs, szikramentes



Ø mm	L mm	L1 mm	Ft	📄	📄
1,5	50	16	40.900	1	000961800
2	50	16	41.300	1	000961801
2,5	63	20	46.550	1	000961802
3	60	20	46.750	1	000961803
3,5	70	25	48.800	1	000961799
4	66	25	49.000	1	000961804
5	75	28	49.800	1	000961805
6	84	32	51.400	1	000961806
8	92	36	56.050	1	000961808
10	102	40	60.500	1	000961810
12	113	45	74.900	1	000961812

96BAF-AS

szikramentes hajlított imbuszkulcs



mm	L mm	L1 mm	Ft	🔧	📄
*1/16	59	25	32.400	1	000962831
*5/64	59	25	33.400	1	000962832
*3/32	59	25	34.800	1	000962833
*7/64	59	25	36.250	1	000962834
*1/8	59	25	37.650	1	000962835
*9/64	64	29	40.700	1	000962836
*5/32	65	30	41.900	1	000962837
*3/16	79	31	44.350	1	000962838
*7/32	85	37	46.350	1	000962839
*1/4	85	37	48.600	1	000962840
9/32	88	38	49.800	1	000962841
*5/16	92	44	52.000	1	000962842
11/32	100	44	53.650	1	000962843
*3/8	110	45	56.900	1	000962844
*7/16	119	48	60.500	1	000962845
*1/2	140	55	73.900	1	000962846
*9/16	150	58	84.800	1	000962847

99BA

Körmoskulcs, szikramentes



mm	A mm	Ft	🔧	📄
32-75	4,0	105.300	1	000990803
50-120	4,5	165.200	1	000990805
115-170	4,5	266.400	1	000990811

110BA

Állítható villáskulcs, szikramentes



L mm	A max mm	Ft	🔧	📄
100	13	77.950	1	001100810
150	18	89.450	1	001100815
200	24	105.300	1	001100820
250	30	127.100	1	001100825
300	36	178.100	1	001100830
375	46	240.100	1	001100837
*450	55	336.400	1	001100845
*600	65	560.700	1	001100860

330BA

Csővágó, szikramentes



330BA/2	Ø max 50 mm	L mm	Ft	🔧	📄
	2"	375	409.300	1	003300802

330BA/2R

tartalék kés és tű a 330BA gázcsővágó eszközhöz, szikramentes



330BA/2-R	Ft	🔧	📄
	41.300	1	003300822

363BA

Csőfogó, amerikai modell, szikramentes



L mm	Ø max mm	Ø max mm	Ft	🔧	📄
150	1 1/2" gas	20	132.800	1	003630815
200	1" gas	30	133.200	1	003630820
250	1 1/2" gas	49	155.500	1	003630825
300	2" gas	60	197.200	1	003630830
350	2" gas	60	244.100	1	003630835
450	2 1/2" gas	76	370.400	1	003630845
600	3" gas	90	516.200	1	003630860

378BA

Svéd csőfogó, szikramentes, réz és berillium ötvözet

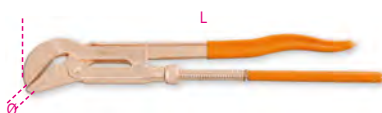

L mm	Ø max mm	Ft	🔧	📄
430	1" 1/2 gas	403.600	1	003780800
530	2" gas	498.000	1	003780801

386BA

Erősített láncos csőfogó, szikramentes

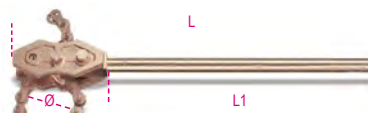

L mm	Ø max mm	470	Ft	🔧	📄
600	100	470	609.300	1	003860806
900	200	750	1.010.100	1	003860809

911BA

tizenkétszögű dugókulcs szikramentes

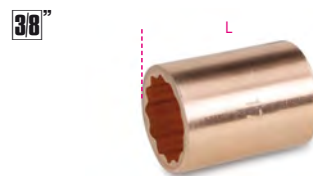

mm	L mm	Ft	🔧	📄
6	28	26.900	1	009110806
7	28	28.750	1	009110807
8	28	30.950	1	009110808
9	28	32.800	1	009110809
10	32	44.550	1	009110810
11	32	46.950	1	009110811
12	32	49.600	1	009110812
13	32	51.800	1	009110813
14	32	55.250	1	009110814
15	32	55.650	1	009110815
16	32	58.300	1	009110816
17	32	60.500	1	009110817
18	32	61.550	1	009110818
19	32	63.750	1	009110819

911BA/16

szűkítő közbetű 3/8" és 1/2", szikramentes

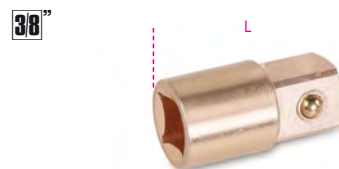

L mm	3/8	1/2	Ft	🔧	📄
34			56.900	1	009110836

911BA/20

3/8"-os toldó, szikramentes



L mm	Ft	🔧	📄
75	45.950	1	009110840

911BA/55

3/8"-os átnyomós irányváltós racsní, szikramentes



L mm	D mm	A mm	Ft	🔧	📄
200	45	16.5	97.550	1	009110882



921BA

Tizenkétszögű dugókulcs, szikramentes

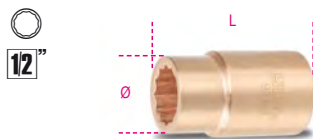

Ø mm	Ø mm	L mm	Ft	1	009210808
8	15,0	40	40.500	1	009210808
9	16,0	40	42.500	1	009210809
10	17,5	40	48.800	1	009210810
11	18,0	40	50.400	1	009210811
12	18,5	40	53.650	1	009210812
13	20,0	40	56.900	1	009210813
14	21,0	40	57.900	1	009210814
15	21,5	40	60.100	1	009210815
16	24,0	40	61.950	1	009210816
17	25,0	40	64.150	1	009210817
18	25,0	40	66.800	1	009210818
19	28,0	42	68.800	1	009210819
20	29,0	42	72.450	1	009210820
21	30,0	43	73.500	1	009210821
22	30,5	43	76.500	1	009210822
24	34,0	43	89.850	1	009210824
25	36,0	43	97.550	1	009210825
26	37,5	43	104.000	1	009210826
27	37,5	45	109.300	1	009210827
28	38,9	46	114.200	1	009210828
30	41,5	46	128.300	1	009210830
32	43,5	46	141.700	1	009210832

921BA-AS

tizenkétszögű dugókulcs, szikramentes

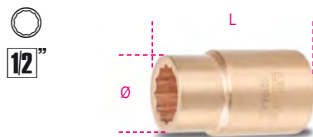

"	Ø mm	L mm	Ft	1	009210958
5/16	24,0	40	43.100	1	009210958
3/8	24,0	40	46.550	1	009210960
7/16	24,0	40	50.800	1	009210961
1/2	24,0	40	54.050	1	009210963
9/16	24,0	40	56.900	1	009210964
5/8	25,0	40	64.150	1	009210966
11/16	25,5	40	69.250	1	009210967
3/4	28,0	42	76.500	1	009210969
13/16	30,0	43	80.750	1	009210971
7/8	31,5	43	88.450	1	009210972
15/16	34,0	43	93.300	1	009210974
1	36,0	43	104.000	1	009210975
1.1/16	38,0	46	111.700	1	009210977
1.1/4	42,0	46	148.600	1	009210982
1.7/16	50,5	50	183.000	1	009210986

921BA/15

szűkítő közbetét
1/2" és 3/8",
szikramentes



L mm	□	■	Ft	1	009210839
34	1/2	3/8	51.200	1	009210839

921BA/16

szűkítő közbetét 1/2" és 3/4
szikramentes

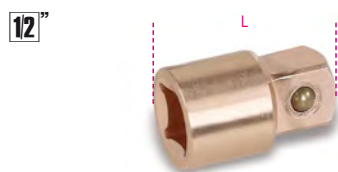

L mm	□	■	Ft	1	009210840
34	1/2	3/4	67.400	1	009210840

921BA/21 - 921BA/22

Toldó 1/2", szikramentes



	L mm	Ø mm	Ft	1	009210842
921BA/21	125	30	68.400	1	009210842
921BA/22	250	31	95.350	1	009210844

921BA/25

Csukló, belső- és külső négyszög 1/2",
szikramentes



L mm	Ø mm	□	■	Ft	1	009210845
80	25	1/2	1/2	69.250	1	009210845

921BA/42

Csúszkás T-hajtószár 1/2", szikramentes



L mm	Ft	1	009210846
250	112.600	1	009210846

921BA/50

1/2"-os racsní, szikramentes

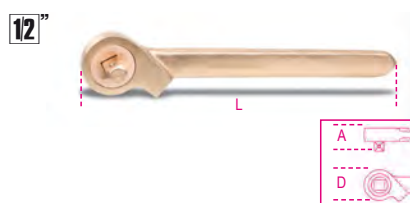

L mm	D mm	A mm	Ft	1	009210850
250	45	16,5	130.000	1	009210850

921BA/R50

pótalkatrész készlet
szikramentes



L mm	Ft	1	009210851
1/2"	38.650	1	009210851

926BA

Tizenkétszögű dugókulcs, szikramentes

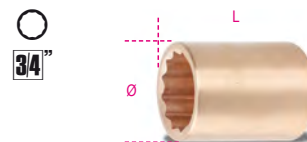

mm	Ø mm	L mm	Ft	1	009260822
22	40	55	84.800	1	009260822
24	40	55	94.950	1	009260824
26	40	55	107.700	1	009260826
27	40	55	114.200	1	009260827
28	41	55	133.200	1	009260828
30	43	60	136.400	1	009260830
32	45	60	152.200	1	009260832
34	48	60	161.500	1	009260834
36	50	60	175.300	1	009260836
38	53	60	187.000	1	009260838
41	57	65	205.300	1	009260841
46	63	65	244.100	1	009260846
50	68	70	267.600	1	009260850

926BA/15

szűkítő közbetét 3/4" és 1/2
szikramentes



L mm	□	■	Ft	1	009260861
55	3/4	1/2	67.400	1	009260861

926BA/22

Toldó 3/4", szikramentes



L mm	Ø mm	Ft	1	009260872	
926BA/22	200	38	136.400	1	009260872

926BA/42

Csúszkás T-hajtószár, külső négyszög 3/4",
szikramentes



L mm	Ft	1	009260876
400	197.200	1	009260876

926BA/50

Racsnis hajtószár 3/4", szikramentes



L mm	D mm	A mm	Ft	1	009260880
300	61	22	202.000		

926BA/R50

pótalkatrész készlet szikramentes



3/4"	Ft	1	009260881
	64.150		

937BA

Dugókulcs, szikramentes



Ø mm	L mm	A mm	Ft	1	009370813
13	240	45	50.400		
17	260	51	72.850		
19	270	55	76.100		
22	278	59	99.800		
24	286	63	106.500		
27	294	69	113.000		
30	302	75	125.100		
32	310	81	136.400		
★36	330	85	160.300		
★41	350	90	193.900		

951BA

T-szárú imbuszkulcs, szikramentes



mm	L mm	L1 mm	Ft	1	009510904
4	100	90	84.800		
5	100	90	88.850		
6	100	90	93.700		

961BA

Feszítővas, szikramentes



L mm	A mm	Ft	1	009610802
250	39	74.900		
350	55	112.600		

963BA

feszítővas hegyes és hajlított lapos véggel, szikramentes



L mm	A mm	Ft	1	009630801
500	24	208.900		
★800	24	327.500		
★1000	30	692.300		

964BA

Szerelővas, szikramentes



L mm	Ft	1	009640801
385	197.200		

964BA/L

Univerzális hordonyító, szikramentes

Fémhordók nyitására



★964BA/L	L mm	Ft	1	009640821
	510	998.000		

965BA

Biztonsági szelepszáró kulcs, szikramentes



A mm	A1 mm	L mm	Ft	1	009650830
30	44	200	86.450		
32	50	300	120.600		
35	47	250	98.400		
40	50	300	113.000		
45	58	350	146.200		
48	62	375	152.200		
50	67	400	167.200		
55	73	450	200.000		
60	79	500	215.400		
★65	82	550	241.300		
★70	85	600	266.400		

966BA

Biztonsági szelepszáró kulcs, szikramentes

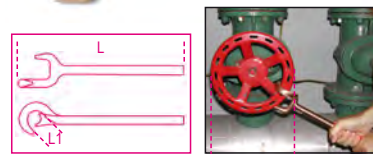

L mm	L1 mm	Ø min+max mm	Ft	1	009660801
350	40	50+150	189.500		

966BA/V

szikramentes kulcsok, biztonsági szelepekhez

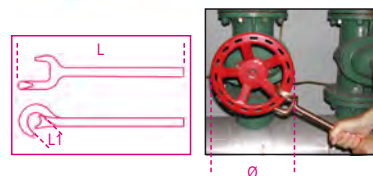

L mm	L1 mm	Ø min+max mm	Ft	1	009660812
370	36	125+250	189.500		
430	48	250+400	272.900		

1032BA

szikramentes fogó egyenes csőrrel rugalmas biztosító gyűrűkhöz, furatokhoz PVC bevonatú nyéllal



L mm	Ø mm	Ft	1	010320820
200	40+100	123.500		

1036BA

szikramentes fogó egyenes csőrrel rugalmas biztosító gyűrűkhöz, tengelyekhez PVC bevonatú nyéllal

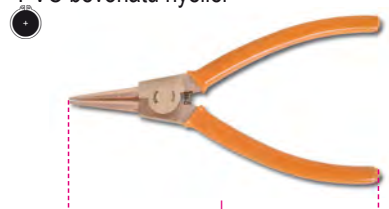

L mm	Ø mm	Ft	1	010360820
200	40+100	123.500		

1046BA

vízpumpafogó
fogasléces forgópánt,
szikramentes

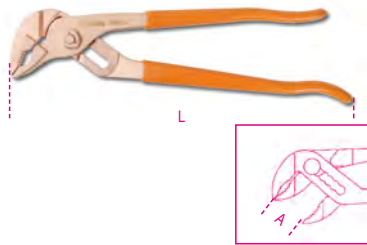

L mm	A max mm	Ft	📦	📄
250	32	161.100	1	010460801
*300	52	212.600	1	010460803

1052BA

önzáró vízpumpa fogó
homorú pófájú, szikramentes

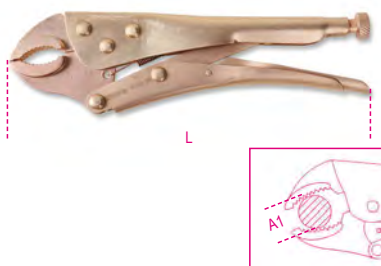

L mm	A1 max mm	Ft	📦	📄
225	40,0	158.700	1	010520824

1082BA

Oldalsípőfogó, szikramentes

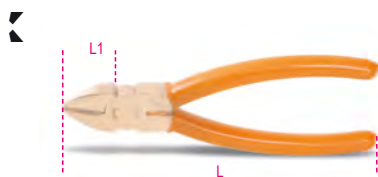

L mm	L1 mm	Ft	📦	📄
160	22	115.400	1	010820801

1100BA

csapszegvágó,
szikramentes



L mm	Ft	📦	📄
600	825.900	1	011000860

1137BA

Csupaszoló fogó



L mm	L1 mm	Ft	📦	📄
185	30	214.600	1	011370801

1137BA/RC

Tartalékpenge a 1137BA-hoz



1137BA/RC	Ft	📦	📄
	41.300	1	011370851

1150BA

Kombinált fogó, szikramentes



L mm	L1 mm	Ft	📦	📄
200	40	136.000	1	011500820

1162BA

Egyenes extra hosszú laposfogó,
szikramentes



L mm	L1 mm	Ft	📦	📄
150	54	106.500	1	011620815

1166BA

Egyenes extra hosszú félkerekcsőrű fogó,
szikramentes



L mm	L1 mm	Ft	📦	📄
150	54	106.500	1	011660815

1270BA

Csavarhúzó hasítottfejű csavarokhoz,
szikramentes



AxL mm	L1 mm	Ft	📦	📄
3x75	178	19.450	1	012700803
4x100	209	23.900	1	012700804
5x150	250	31.800	1	012700805
6x150	270	33.600	1	012700806
8x200	312	38.250	1	012700808
10x250	382	51.200	1	012700810

1272BA

Csavarhúzó Phillips®-csavarokhoz,
szikramentes



PHxDxL mm	L1 mm	Ft	📦	📄
1x5x100	209	26.700	1	012720801
2x6x150	270	34.000	1	012720802
3x8x200	332	40.900	1	012720803

1277BA

imbusz-csavarhúzó Torx® csavarokhoz,
szikramentes



Ø	L mm	L1 mm	Ø mm	Ft	📦	📄
T10	75	184	5	25.300	1	012770810
T15	75	184	5	27.300	1	012770815
T20	100	209	6	37.250	1	012770820
T25	125	209	6	39.250	1	012770825
T30	150	270	6	43.100	1	012770830
T40	200	332	8	57.300	1	012770840

1370BA

Lakatos kalapács, szikramentes,
fanyéllal



g	A mm	L mm	L1 mm	Ft	📦	📄
500	30	310	108	71.250	1	013700805
1000	35	340	137	125.500	1	013700810

1370BA/MR

Tartaléknyél a 1370BA modellhez

	Ft		
1370BA/MR 500	11.950	1	013700865
1370BA/500			
1370BA/MR 1000	14.750	1	013700870
1370BA/1000			

1370BA/PL

szikramentes lakatos kalapács, műanyag nyéllel



g	A mm	L mm	L1 mm	Ft		
500	30	310	108	71.250	1	013700815
1000	35	340	137	125.500	1	013700820

1375BA/PL

gömbfejű körmös kalapács szikramentes műanyag nyéllel



g	L mm	L1 mm	Ø mm	Ft		
680	321	125	30	91.500	1	013750800

1377BA

kerekfejű és gömbfokú kalapács kazánkövacsok és bádigosok számára, szikramentes



g	L1 mm	L mm	Ft		
340	90	280	45.950	1	013770834

1377BA/PL

kerekfejű és gömbfokú kalapács kazánkövacsok és bádigosok számára, Faser nyél, szikramentes



g	L1 mm	L mm	Ft		
340	90	280	45.950	1	013770884

1379BA

Rozsdaeltávolító kalapács, szikramentes, fanyéllal



g	L1 mm	L mm	Ft		
500	142	315	88.850	1	013790850

1380BA

Ráverő kalapács, szikramentes, fanyéllal



g	L1 mm	L mm	Ft		
1000	100	400	153.800	1	013800810
1500	118	400	187.000	1	013800815
2000	126	400	246.200	1	013800820

1380BA/MR

Tartaléknyél a 1380BA modellhez

	Ft		
1380BA/MR 1000	15.600	1	013800860
1380BA/1000			
1380BA/MR 1500	15.600	1	013800865
1380BA/1500			
1380BA/MR 2000	15.600	1	013800870
1380BA/2000			

1380BA/PL

szikramentes ráverőkalapács, műanyag nyéllel



g	L1 mm	L mm	Ft		
500	80	310	76.500	1	013800955
1000	94	350	142.900	1	013800960
1500	115	400	205.300	1	013800965
2000	125,5	400	268.800	1	013800970

1381BA

szikramentes ráverő kalapács, fanyéllal



g	L1 mm	L mm	Ft		
5000	179	900	574.900	1	013810850
★8000	190	900	919.000	1	013810858

1381BA/MR

Tartaléknyél a 1381BA modellhez

	Ft		
1381BA/MR 5000	23.900	1	013810870
1381BA/5000			
★1381BA/MR 8000	27.550	1	013810878
1381BA/8000			

1381BA/PL

szikramentes hosszú nyelű ráverőkalapács, műanyag nyéllel

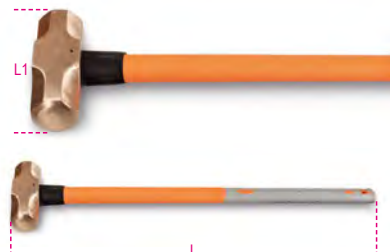

g	L1 mm	L mm	Ft		
5000	172	900	526.300	1	013810885
8000	204	900	943.300	1	013810888

1390BA

Műanyagbetétes kalapács, szikramentes



Ø mm	L mm	L1 mm	Ft		
★52	370	130	123.500	1	013900805

1390BA/R

Nylon cserefej a 1390BA kalapácshoz



D mm	Ft		
52	24.900	4	013900885



1602BA

saruzófógo szigetelt kábel-sarukhoz, könnyített kivitel, szikramentes



mm ²	L mm	Ft	1	016020801
0.75+6	200	151.800	1	016020801

1701BA

hatszögű laposvágó, szikramentes



L mm	A mm	S mm	Ft	1	017010810
150	12	10	27.950	1	017010810
200	16	14	44.550	1	017010814
250	18	14	54.850	1	017010815
350	19	17	144.900	1	017010817

1703BA/A

Fejsze, szikramentes



L mm	L1 mm	A mm	Ft	1	017030082
340	145	82	125.500	1	017030082

1703BA/P

Csákány, szikramentes



A mm	L mm	L1 mm	Ft	1	017030150
56	1050	410	327.900	1	017030150

1703BA/PL

Ásólapat, szikramentes



A mm	L1 mm	L mm	Ft	1	017030200
240	420	990	276.100	1	017030200

1717BA

Spakli, merev, szikramentes



A mm	Ft	1	017170801
60	67.400	1	017170801
80	74.900	1	017170803

1717BA/1

Hántoló, szikramentes



A mm	L mm	Ft	1	017170805
100	220	134.800	1	017170805

1719BA8

8"-os reszelő, szikramentes



	L mm	Ft	1	017190801
1719BA8/P	200	82.600	1	017190801
1719BA8/M	200	85.200	1	017190805
1719BA8/R	200	87.250	1	017190810
1719BA8/T	200	80.350	1	017190815
1719BA8/Q	200	80.350	1	017190820

1719BA12

12"-os reszelő, szikramentes



	L mm	Ft	1	017190831
1719BA12/P	300	148.600	1	017190831

1727BA

Fűrész fűrészlappal, szikramentes



L mm	L1 mm	Ft	1	017270801
500	300	263.200	1	017270801

1728BA

Fűrészlap, szikramentes, réz és berillium ötvözet



L mm	Ft	1	017280801
300	51.000	1	017280801

1737BA

Drótkefe gyújtógyertyához, szikramentes



L mm	A mm	Ft	1	017370801
294	29	34.000	1	017370801

1758BA

szikramentes tölcser



Ø mm	H mm	Ft	1	017580815
160	150	47.350	1	017580815

1776BA

Kés, szikramentes



L1 mm	L mm	Ft	1	017760801
145	250	73.900	1	017760801

1784BA

Olló, szikramentes



L mm	Ft	1	017840822
225	128.300	1	017840822





ELEKTROMOS SZERSZÁMGÉPEK

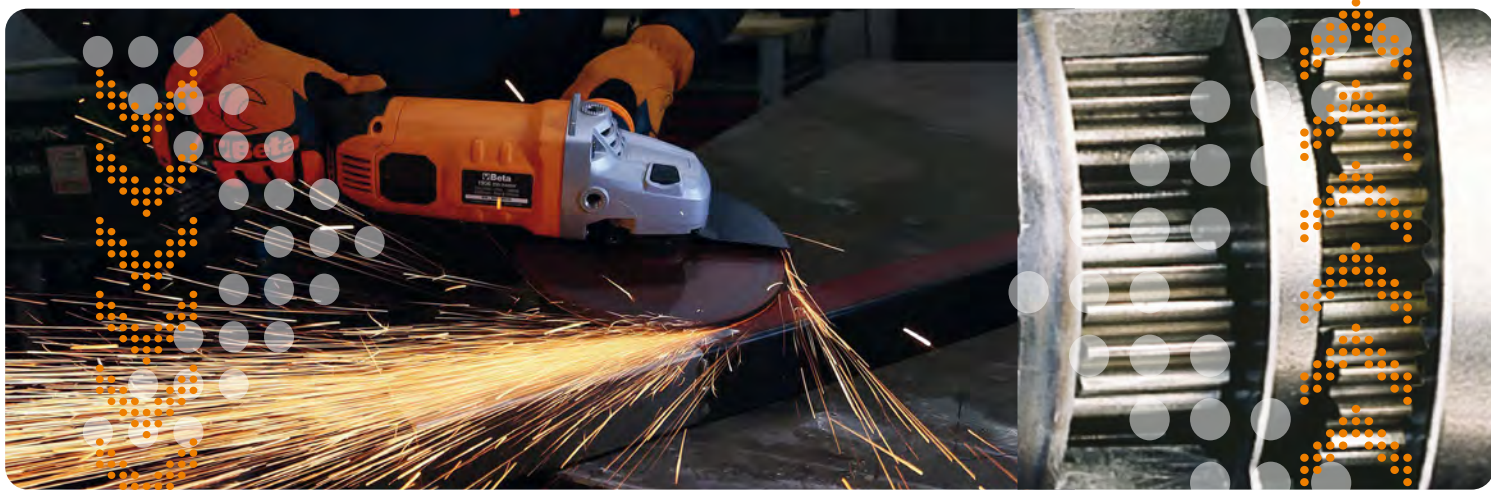

Megbízható, robusztus, minden szakember igényeit kielégítő munkaeszközök.

A Beta kínálatában egyaránt megtalálhatók vezetékes és akkumulátoros szerszámgépek.

- AKKUMULÁTOROS SZERSZÁMGÉPEK
- VEZETÉKES SZERSZÁMGÉPEK

 **Beta**
POWERTOOLS



ELEKTROMOS SZERSZÁMGÉPEK

 **3-YEAR WARRANTY**



Az új termékcsaládban nagy teljesítményű 12V-os és 20V-os akkumulátoros szerszámgépek találhatók.

A 12V-os modellek sorába tartoznak a mindennapi feladatokhoz elengedhetetlen, megbízható teljesítményű, könnyű és kompakt ütvefűrészek és ütvecsavarbehajtók.

A 20V-os akkumulátoros szerszámgép modellek egységes jellemzője a kiemelkedő teljesítmény, a minőségi konstrukció és a robusztusság.

A Beta ezekből a jellemzőkből kiindulva fejlesztette ki az akkumulátoros szerszámgépcsaládot a nagy nyomatékú ütvefűrésztől kezdve a 1/2" csatlakozójú ütvecsavarbehajtóig.

A Beta új szerszámgépeiben szénkefe nélküli motor és egy elsőrangú belső szerkezet található, ami jelentősen javítja az eszközök teljesítményét és tartósságát.

Az 1200 Nm maximális kihajtó nyomatékú ütvecsavarbehajtó kétségtelenül az új termékcsalád zászlóshajója, ideális munkatárs mindazok számára, akiknek páratlan teljesítményre van szükségük. 20V-os lítiumion akkumulátoraink akár 6 Ah kapacitással is elérhetőek és a termékcsalád összes szerszámgépével kompatibilisek.



Olvassa le a QR kódot és tudjon meg többet az ingyenes 3 éves kiterjesztett garanciáról.

1972/K12V-10

ultrakompakt 12V fúró/csavarbehajtó

- ultrakompakt, mindössze 170 mm hosszú, ultrakönnyű, csak 1,1 kg, akkumulátorral tökéletesen kiegyensúlyozott
- kétsésszerű mechanika acél fogaskerekekkel és 20 állású tengelykapcsolóval
- legnagyobb nyomaték 30 Nm és 1300 f/p (400 f/p első fokozatban); legnagyobb furatkészítés 10 mm acélban és 20 mm fában
- 2Ah akkumulátorok, töltésszelzővel a gépházon
- ergonomikus, csúszásmentes markolat
- előlő LED
- 10 mm önzáró tokmány
- jobb/bal oldali zárókapocs
- becsavarás-kicsavarás-reteszelés (szállításhoz) választókapcsoló
- merev táskában 2 db 2 Ah lítiumion akkumulátorral és gyorstöltővel (50 p) szállítva

Beta
3-YEAR
WARRANTY



1972/K12V-10

316x254x96 mm - 1,1 kg

Ft

117.000



1



019720112

1982/K12V

irányváltós ütvecsavarbehajtó, 12V

ideális szűk helyeken történő munkavégzéshez, magas nyomaték (80 Nm), egykezes működés

- ultrakompakt, csak 160 mm hosszú, ultrakönnyű, csak 1 kg, akkumulátorral tökéletesen kiegyensúlyozott
- 1/4" hatlapfejű csatlakozó reteszlelővel
- jobb/bal oldali zárókapocs
- előlő LED
- becsavarás-kicsavarás-reteszelés (szállításhoz) választókapcsoló
- ergonomikus, csúszásmentes markolat
- teljesen fémből készült fogaskerékház
- 2Ah akkumulátorok, töltésszelzővel a gépházon
- merev táskában 2 db 2 Ah lítiumion akkumulátorral és gyorstöltővel (50 p) szállítva

Beta
3-YEAR
WARRANTY



1982/K12V

316x254x96 mm - 1,1 kg

Ft

117.000



1



019820112

1972/K12V-COMBO

12V ultrakompakt fúró + 1/4" HEX irányváltós ütvecsavarbehajtó készlet

A táská tartalma:

- 1 12V ultrakompakt fúró, 10 mm önzáró tokmánnyal
- 1 12V irányváltós ütvecsavarbehajtó, 1/4" hatlapfejű csatlakozóval
- 2 2Ah lítiumion akkumulátor
- 1 akkumulátor gyorstöltő



Beta
3-YEAR
WARRANTY



+



1972/K12V-COMBO

310x295x100 mm - 3 kg

Ft

199.200



1



019720010

1972/12V-10

Ultrakompakt 12V fúró/csavarbehajtó

- Kompakt, mindössze 170 mm hosszú, ultrakönnyű: 1,1 kg, akkumulátorral, jól kiegyensúlyozott
- 10 mm fém önzáró tokmány
- Legnagyobb nyomaték 30 Nm és 1300 f/p (400 f/p első fokozatban); legnagyobb furatkészítés 10 mm acélban és 20 mm fában
- Kétszempontú mechanika acél fogaskerekekkel (0-400/1300 fordulat/perc)
- 20 nyomatékállítási pozíció
- Becsavarás-kicsavarás-reteszelés (szállításhoz) választókapcsoló
- Elülső LED
- Csúszásmentes ergonomikus markolat
- Jobb/bal oldali övkapocs

790 g

1972/12V-10

Ft
48.600



1



019720113

Beta
**3-YEAR
WARRANTY**

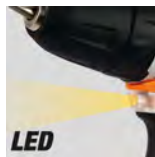

LED

0-400/min
0-1300/min
30 Nm



CE

1982/12V

irányváltós ütvecsavarbehajtó, 12V (géptest)

Ideális szűk helyen való munkavégzéshez; magas nyomaték (80 Nm); egykezes használatra tervezve

- ultrakompakt, csak 160 mm hosszú, ultrakönnyű, csak 1 kg, akkumulátorral, és tökéletesen kiegyensúlyozott
- 1/4" hatlapfejű csatlakozó reteszelővel
- jobb/bal oldali övkapocs
- elülső LED
- becsavarás-kicsavarás-reteszelés (szállításhoz) választókapcsoló
- csúszásmentes ergonomikus markolat
- teljesen fémből készült fogaskerékház

800 g

1982/12V

Ft
51.600



1



019820113

Beta
**3-YEAR
WARRANTY**



LED



80 Nm



CE

1994BL 12V-2Ah

2 Ah lítiumion akkumulátor szerszámokhoz 12V

Fő jellemzők:

- Akkumulátor feszültség: 12V
- Akkumulátorkapacitás: 2Ah
- Teljesítmény: 24Wh
- Akkumulátor típus: Li-ion

170 g

1994BL 12V-2Ah

Ft
21.850



1



019940015



CE

1994CB 12V

Akkumulátor gyorsító 12V, 110V-240V

Fő jellemzők:

- LED töltöttségi szint kijelző
- Névleges bemeneti feszültség: 110V-240V ~ 50/60Hz
- Kimeneti feszültség: 12,6V
- Töltőáram: 2A
- Névleges bemeneti teljesítmény: 35 W
- 2Ah akkumulátor töltési idő: 50 perc

260 g

1994CB 12V

Ft
21.850



1



019940123



CE

1972/K20V-13BMC

Útvefűró készlet 20V, SZÉNKEFE NÉLKÜLI motor

- SZÉNKEFE NÉLKÜLI digitális motor
- Jelentősen továbbfejlesztett tulajdonságok: nagyobb teljesítmény, kisebb energiafogyasztás, hosszabb motor élettartam, jobb teljesítményadagolás
- 3 üzemmód: fűrés, csavarbehajtás és útvefűrés
- Kompakt: 210 mm hosszú
- Csúszásmentes ergonomikus markolat
- Becsavarás-kicsavarás-reteszelés (szállításhoz) választókapcsoló
- Fémből készült fogaskerékház
- Beépített LED világítás
- Jobb és bal oldalon övkapocs
- Kiegészítő oldalmarkolat a nagyobb nyomaték érdekében
- Merev táskában 2 db lítiumion akkumulátorral (4 Ah) és gyorstöltővel szállítva

Fő jellemzők:

- Max. forgatónyomaték: 80 Nm
- Fűrőütes percnként 1a sebességen 0 – 6750 (BPM)
- Fűrőütes percnként 2a sebességen 0 – 24000 (BPM)
- 20 nyomatékállítási pozíció
- 13 mm fém önzáró tokmány
- Kétsebességes mechanika acél fogaskerekekkel (0-450/1650 fordulat/perc)
- Max. fűrészteljesítmény fában: 55 mm
- Max. fűrészteljesítmény fémben: 13 mm
- Max. fűrészteljesítmény falban: 13 mm

Beta
3-YEAR
WARRANTY



CE

1972/K20V-13BMC

Ft 254.300 1 019720020

490x370x125 mm - 5,5 kg

1972/20V-13BMC

Útvefűró 20V, SZÉNKEFE NÉLKÜLI motor

- SZÉNKEFE NÉLKÜLI digitális motor
- Jelentősen továbbfejlesztett tulajdonságok: nagyobb teljesítmény, kisebb energiafogyasztás, hosszabb motor élettartam, jobb teljesítményadagolás
- 3 üzemmód: fűrés, csavarbehajtás és útvefűrés
- Kompakt: 210 mm hosszú
- Csúszásmentes ergonomikus markolat
- Becsavarás-kicsavarás-reteszelés (szállításhoz) választókapcsoló
- Fémből készült fogaskerékház
- Beépített LED
- Jobb és bal oldalon övkapocs
- Kiegészítő oldalmarkolat a nagyobb nyomaték érdekében
- Merev táskában, akkumulátor és töltő nélkül

Fő jellemzők:

- Max. forgatónyomaték: 80 Nm
- Fűrőütes percnként 1a sebességen 0 – 6750 (BPM)
- Fűrőütes percnként 2a sebességen 0 – 24000 (BPM)
- 20 nyomatékállítási pozíció
- 13 mm fém önzáró tokmány
- Kétsebességes mechanika acél fogaskerekekkel (0-450/1650 fordulat/perc)
- Max. fűrészteljesítmény fában: 55 mm
- Max. fűrészteljesítmény fémben: 13 mm
- Max. fűrészteljesítmény falban: 13 mm

Beta
3-YEAR
WARRANTY



CE

1972/20V-13BMC

Ft 104.900 1 019720019

490x370x125 mm - 3,6 kg

1984/K600

Írányváltós ütvecsavarbehajtó, 20 V, szénkefe nélküli motor, 1/2" csatlakozó - 600 Nm

- 3 választható nyomaték és fordulatszám csavarozás üzemmódban
- Akár 600 Nm nyomaték kihajtáshoz

• SZÉNKEFE NÉLKÜLI digitális motor

Jelentősen továbbfejlesztett tulajdonságok: nagyobb teljesítmény, kisebb energiafogyasztás, hosszabb motor élettartam, jobb teljesítményadagolás

- 1/2" külső négyszög csatlakozó dugókulcs tartó gyűrűvel
- Fúróütes percnként 0-2.300 (BPM)
- Fémből készült fogaskerékház
- Csúszásmentes ergonomikus markolat
- Becsavarás-kicsavarás-reteszelés (szállításhoz) választókapcsoló
- Beépített LED világítás
- Jobb és bal oldalon övkapocs

Meghúzás:

3 nyomaték és fordulatszám beállítás (alacsony - közepes -nagy):

- 1: 200 Nm; 1000 fordulat/perc
- 2: 350 Nm; 1500 fordulat/perc
- 3: 550 Nm; 1800 fordulat/perc

Lazítás

- 1: 600 Nm: maximális nyomaték folyamatos üzemmódban (szabad kicsavarás)
- 2: 600 Nm - Automatikus leállítás: maximális nyomaték a csavar teljes kicsavarásáig, majd automatikus leállítás (egyszeri csavarkioldás)

Praktikus merev táskában 2 db 4 Ah lítiumion akkumulátorral és gyorstöltővel szállítva.



1984/K600 Ft 293.100 1 019840060
490x370x125 mm - 6,3 kg

1984 20V/600BMC

Írányváltós ütvecsavarbehajtó 20 V, SZÉNKEFE NÉLKÜLI motor, 1/2" csatlakozó - 600 Nm

- 3 választható nyomaték és fordulatszám csavarozás üzemmódban
- Akár 600 Nm nyomaték kihajtáshoz

• SZÉNKEFE NÉLKÜLI digitális motor

Jelentősen továbbfejlesztett tulajdonságok: nagyobb teljesítmény, kisebb energiafogyasztás, hosszabb motor élettartam, jobb teljesítményadagolás

- 1/2" külső négyszög csatlakozó dugókulcs tartó gyűrűvel
- Fúróütes percnként 0-2.300 (BPM)
- Fémből készült fogaskerékház
- Csúszásmentes ergonomikus markolat
- Becsavarás-kicsavarás-reteszelés (szállításhoz) választókapcsoló
- Beépített LED világítás
- Jobb és bal oldalon övkapocs
- **Merev táskában, akkumulátor és töltő nélkül**

Meghúzás:

3 nyomaték és fordulatszám beállítás (alacsony - közepes -nagy):

- 1: 200 Nm; 1000 fordulat/perc
- 2: 350 Nm; 1500 fordulat/perc
- 3: 550 Nm; 1800 fordulat/perc

Lazítás

- 1: 600 Nm: maximális nyomaték folyamatos üzemmódban (szabad kicsavarás)
- 2: 600 Nm - Automatikus leállítás: maximális nyomaték a csavar teljes kicsavarásáig, majd automatikus leállítás (egyszeri csavarkioldás)

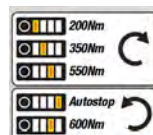

1984 20V/600BMC Ft 143.300 1 019840907
490x370x125 mm - 4,4 kg

1984/K1200

írányváltós ütvecsavarbehajtó, 20 V, szénkefe nélküli motor, 1/2" csatlakozó - 1200 Nm

Nagy nyomatékot igénylő munkákhoz ideális.

- 3 választható nyomaték és fordulatszám csavarozás üzemmódban
- Akár 1200 Nm nyomaték kihajtáshoz
- Akár 1700 Nm csúcsnyomaték

• SZÉNKEFE NÉLKÜLI digitális motor

Jelentősen továbbfejlesztett tulajdonságok: nagyobb teljesítmény, kisebb energiafogyasztás, hosszabb motor élettartam, jobb teljesítményadagolás

- 1/2" külső négyszög csatlakozó dugókulcs tartó gyűrűvel
- Fűrőütes percnként 0-2.200 (BPM)
- Teljesen fémből készült fogaskerékház
- Csúszásmentes ergonomikus markolat
- Becsavarás-kicsavarás-reteszelés (szállításhoz) választókapcsoló
- Beépített LED világítás rossz látási körülmények esetére
- Jobb/bal oldalon övkapocs

Meghúzás

3 nyomaték és fordulatszám beállítás (alacsony - közepes - nagy):

- 1: 350 Nm; 800 fordulat/perc
- 2: 600 Nm; 1400 fordulat/perc
- 3: 900 Nm; 1600 fordulat/perc

Lazítás

- 1: 1200 Nm: maximális nyomaték folyamatos üzemmódban (szabad kicsavarás)
- 2: 1200 Nm - Automatikus leállítás: maximális nyomaték a csavar teljes kicsavarásáig, majd automatikus leállítás (egyszeri csavarkidobás)

Praktikus merev táskában 2 db 6 Ah lítiumion akkumulátorral és gyorstöltővel szállítva.



1984/K1200

Ft 354.300 1 019840120

490x370x125 mm - 7 kg

1984 20V/1200BMC

Írányváltós ütvecsavarbehajtó 20 V, SZÉNKEFE NÉLKÜLI motor, 1/2" csatlakozó - 1200 Nm

Nagy nyomatékot igénylő munkákhoz ideális.

- 3 választható nyomaték és fordulatszám csavarozás üzemmódban
- Akár 1200 Nm nyomaték kihajtáshoz
- Akár 1700 Nm csúcsnyomaték

• SZÉNKEFE NÉLKÜLI digitális motor

Jelentősen továbbfejlesztett tulajdonságok: nagyobb teljesítmény, kisebb energiafogyasztás, hosszabb motor élettartam, jobb teljesítményadagolás

- 1/2" külső négyszög csatlakozó dugókulcs tartó gyűrűvel
- Fűrőütes percnként 0-2.200 (BPM)
- Teljesen fémből készült fogaskerékház
- Csúszásmentes ergonomikus markolat
- Becsavarás-kicsavarás-reteszelés (szállításhoz) választókapcsoló
- Beépített LED világítás rossz látási körülmények esetére
- Jobb/bal oldalon övkapocs
- Merev táskában, akkumulátor és töltő nélkül

Meghúzás

3 nyomaték és fordulatszám beállítás (alacsony - közepes - nagy):

- 1: 350 Nm; 800 fordulat/perc
- 2: 600 Nm; 1400 fordulat/perc
- 3: 900 Nm; 1600 fordulat/perc

Lazítás

- 1: 1200 Nm: maximális nyomaték folyamatos üzemmódban (szabad kicsavarás)
- 2: 1200 Nm - Automatikus leállítás: maximális nyomaték a csavar teljes kicsavarásáig, majd automatikus leállítás (egyszeri csavarkidobás)

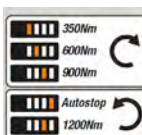

1984 20V/1200BMC

Ft 167.200 1 019840911

490x370x125 mm - 4,7 kg

1986/K20V-125

Sarokcsiszoló készlet 20V, SZÉNKEFE NÉLKÜLI motor

SZÉNKEFE NÉLKÜLI digitális motor

Jelentősen továbbfejlesztett tulajdonságok: nagyobb teljesítmény, kisebb energiafogyasztás, hosszabb motor élettartam, jobb teljesítményadagolás

Fő jellemzők:

- Véletlen beindítás elleni védelem
- Mindkét oldalra felszerelhető kiegészítő markolat
- Szerszám nélküli korongcsere (gyorskioldó)
- Tengelyzár a gyors korongcseréhez
- Tengelyreteszelő kapcsoló
- A porvédővel kialakított levegőcsatorna optimális hűtést biztosít
- Merev táskában 2 db lítiumion akkumulátorral (4 Ah) és gyorsöltővel szállítva

Műszaki adatok:

- Korong átmérő (korong nélkül szállítva): 125/115 mm
- Üresjárat fordulatszám: 8.000 fordulat/perc
- Felfogóméret: M14
- Gabalyodásmentes kábel hossza: 4 m

Beta
3-YEAR
WARRANTY



CE

1986/K20V-125

Ft 254.300 1 019860015

490x370x125 mm - 5,6 kg

1986/20V-125BMC

Sarokcsiszoló 20V, SZÉNKEFE NÉLKÜLI motor

SZÉNKEFE NÉLKÜLI digitális motor

Jelentősen továbbfejlesztett tulajdonságok: nagyobb teljesítmény, kisebb energiafogyasztás, hosszabb motor élettartam, jobb teljesítményadagolás

Fő jellemzők:

- Véletlen beindítás elleni védelem
- Mindkét oldalra felszerelhető kiegészítő markolat
- Szerszám nélküli korongcsere (gyorskioldó)
- Tengelyzár a gyors korongcseréhez
- Tengelyreteszelő kapcsoló
- A porvédővel kialakított levegőcsatorna optimális hűtést biztosít
- **Merev táskában, akkumulátor és töltő nélkül**

Műszaki adatok:

- Korong átmérő (korong nélkül szállítva): 125/115 mm
- Üresjárat fordulatszám: 8.000 fordulat/perc
- Felfogóméret: M14
- Gabalyodásmentes kábel hossza: 4 m

Beta
3-YEAR
WARRANTY



CE

1986/20V-125BMC

Ft 104.900 1 019860025

490x370x125 mm - 3,8 kg



1994B 20V-2AH

2 Ah lítiumion akkumulátor szerszámokhoz 20V

Prémium lítiumion technológia
Gombbal és 3 színes töltöttségi szint kijelző LED

Fő jellemzők:

- Akkumulátor feszültség: 20V
- Akkumulátorkapacitás: 2Ah
- Teljesítmény: 40Wh
- Akkumulátor típus: Li-ion

410 g

1994B 20V-2AH

Ft 29.350 1 019940022



CE

1994B 20V-4AH

4 Ah lítiumion akkumulátor szerszámokhoz 20V

Prémium lítiumion technológia
Gombbal és 3 színes töltöttségi szint kijelző LED

Fő jellemzők:

- Akkumulátor feszültség: 20V
- Akkumulátorkapacitás: 4Ah
- Teljesítmény: 80Wh
- Akkumulátor típus: Li-ion

660 g

1994B 20V-4AH

Ft 49.000 1 019940044



CE

1994B 20V-6AH

6 Ah lítiumion akkumulátor szerszámokhoz 20V

Prémium lítiumion technológia
Gombbal és 3 színes töltöttségi szint kijelző LED

Fő jellemzők:

- Akkumulátor feszültség: 20V
- Akkumulátorkapacitás: 6Ah
- Teljesítmény: 120Wh
- Akkumulátor típus: Li-ion

900 g

1994B 20V-6AH

Ft 67.600 1 019940066



CE

1994C 20V

Akkumulátor gyorstöltő 20V, 110V-240V

Fő jellemzők:

- LED töltöttségi szint kijelző
- Névleges bemeneti feszültség: 110V-240V ~ 50/60Hz
- Kimeneti feszültség: 20V
- Töltőáram: 6A
- Névleges bemeneti teljesítmény: 145 W

20V 2Ah akkumulátor töltési idő: 45 perc
20V 4Ah akkumulátor töltési idő: 90 perc
20V 6Ah akkumulátor töltési idő: 120 perc

680 g

1994C 20V

Ft 51.600 1 019940140



CE

1989RCB

Építkezési rádió 20V

CE

Többfunkciós hangszóró: digitális (DAB, BT) és hagyományos FM rádió
Építkezési vagy egyéb munkaterületre és szabadidős tevékenységekhez

Kompakt, modern kialakítású robusztus rádió IP54 védelemmel
A két 16W oldalsó hangfal biztosítja a nagy teljesítményű sztereó hangzást
Beépített ébresztő funkció
Beépített fogantyúval és ütészálló sarokvédőkkel
AUX és védett USB csatlakozó telefon csatlakoztatásához és töltéséhez
A Beta 20V akkumulátorával (opcionális) vagy tápkábelrel (tartozék)
használható.

Fő jellemzők:

- FM rádiófrekvencia tartomány: 87,5 – 108 MHz
- DAB rádiófrekvencia tartomány: 174 – 240 MHz
- Tárolt FM és DAB csatornák száma: 30
- Hangszóró teljesítmény: 16 W
- Akkumulátor névleges feszültsége (opcionális): 20V
- Méretek: 180 x 205 x 305 mm
- Súly (akkumulátor nélkül): 3,2 kg



1989RCB

Ft 151.400 1 019890020

C9PT

Hightech szövet táska akkumulátoros szerszámgépekhez

Tökéletes a Beta szerszámgépek kényelmes szállítására

Kiemelten ellenálló hightech szövetből készült
Dupla felső kézipánt a biztonságos, kiegyensúlyozott tartásért

C9PT
410x210x280 mm - 700 g

Ft 18.600 1 021090001



Beta





A Beta kínálatában egyaránt megtalálhatók vezetékes és akkumulátoros szerszámgépek.

A vezetékes csiszolók jellemzői és teljesítménye az alkalmazási területtől függenek.

Teljesítmény, megbízhatóság és tartósság: ez jellemzi a Beta új termékcsaládját, természetesen kiegészülve a maximális biztonsággal és könnyű használattal a szakemberek számára.

• **Kiemelkedő teljesítmény:**

- Nagy teljesítményű, műgyanta kötésű, kopásálló, robusztus motor
- A porvédővel kialakított levegőcsatorna optimális hűtést biztosít

• **Páratlan biztonság a felhasználóknak:**

- Tengelyzár a gyors korongcseréhez
- Véletlen beindítás elleni védelem
- Lágypindítás - az indításkor fellépő túláram korlátozására

• **Egyedi kényelem és könnyű kezelhetőség:**

- A csúszásmentes ergonomikus markolat jobban kézben tartható
- A lapos hajtóműfej lehetővé teszi a szűk helyen végzett munkát

A 4 méter hosszú gabalyodásmentes kábellel könnyebben körbejárhatók a munkadarabok. Mindkét oldalra felszerelhető kiegészítő markolat.

1956 115-750W

sarokcsiszoló Ø 115 mm korongokhoz

Vágáshoz, csiszoláshoz és nagyolóshoz ideális

Nagy teljesítményű motor (750 W)

Csúszásmentes, ergonomikus markolat a nagyobb kényelemért és biztonságért

A lapos hajtóműfej lehetővé teszi a szűk helyeken végzett munkát

Rendkívül könnyű (mindössze 1,8 kg)

Fő jellemzők

- Véletlen beindítás elleni védelem
- Mindkét oldalra felszerelhető kiegészítő markolat
- Szerszám nélküli korongcsere (gyorskioldó)
- Tengelyzár a gyors korongcseréhez
- Tengelyreteszelő kapcsoló
- A porvédővel kialakított levegőcsatorna optimális hűtést biztosít
- Szervizkulccsal szállítva

1,8 kg



1956 125-1400W

sarokcsiszoló Ø 125 mm korongokhoz

Vágáshoz, csiszoláshoz és nagyoláshoz ideális

Nagy teljesítményű motor (1400 W) – Változtatható fordulatszám
Csúszásmentes, ergonomikus markolat a nagyobb kényelemért és biztonságért
A lapos hajtóműfej lehetővé teszi a szűk helyeken végzett munkát

Fő jellemzők

- Véletlen beindítás elleni védelem
- Mindkét oldalra felszerelhető rezgéscsillapító oldalfogantyú
- Szerszám nélküli korongcsere (gyorskioldó)
- Tengelyzár a gyors korongcseréhez
- Tengelyreteszelő kapcsoló
- A porvédővel kialakított levegőcsatorna optimális hűtést biztosít
- Szervizkulccsal szállítva

2,5 kg

1956 125-1400W

Ft 70.450 1 019560125

CE

L = 4 m

Ø 125 mm

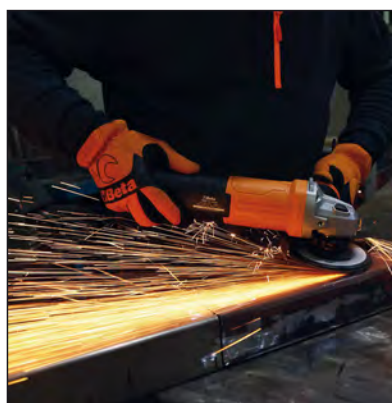

1956 230-2400W

sarokcsiszoló Ø 230 mm korongokhoz

Komplex nyíró, csiszoló és reszelő munkákhoz ideális

Nagy teljesítményű motor (2400 W)
Csúszásmentes, ergonomikus markolat a nagyobb kényelemért és biztonságért

Fő jellemzők

- Véletlen beindítás elleni védelem
- Lágýindítás funkció a zökkenőmentes indításhoz és az indításkor fellépő túláram korlátozására
- Mindkét oldalra felszerelhető rezgéscsillapító oldalfogantyú
- Csavaros korongcsere
- Tengelyzár a gyors korongcseréhez
- Tengelyreteszelő kapcsoló
- A porvédővel kialakított levegőcsatorna optimális hűtést biztosít
- Szervizkulccsal szállítva

5,8 kg

1956 230-2400W

Ft 94.950 1 019560230

CE

L = 4 m

Ø 230 mm

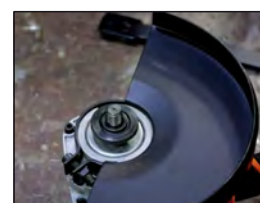
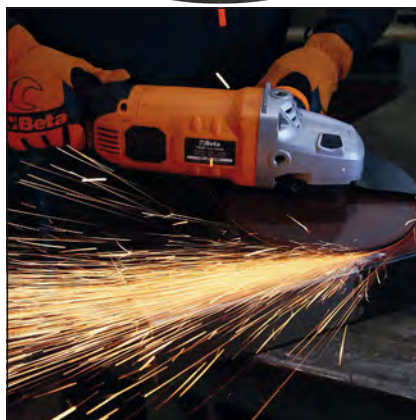

1966/910W

Útvefúró - 910W

Ideális különböző anyagok: fa, fém, műanyag, fal és beton fúrásához

Nagy teljesítményű 910W motor
Letisztult, kompakt design, ergonomikus csúszásmentes markolattal

13 mm önzáró fém fúrótokmány
Írányváltás és változtatható sebesség
Fémről készült fogaskerékház
Kapcsolózárral ellátva

Fő jellemzők:

- Max. fúrásteljesítmény fában: 32 mm
- Max. fúrásteljesítmény fémben: 13 mm
- Max. fúrásteljesítmény falban: 13 mm
- Üresjárat fordulatszám: 0-2800 fordulat/perc
- Gabalyodásmentes kábel hossza: 4 m

Kiegészítők:

- 13 mm önzáró fém fúrótokmány
- 360°-ban elfordítható oldalmarkolat
- Mélységghatároló



1966/910W

420x320x120 mm - 4,3 kg

Ft 66.800



1



019660091

1967/800W

SDS-PLUS fúrókalapács - 800W

Ideális fal, beton, csempe, fa és fém fúrásához, kalapálásához és véséséhez

Nagy teljesítményű 800W motor a nagy igénybevételt jelentő munkákhoz;
Professzionális, kompakt és nagy teljesítményű;
Ergonomikus, kompakt design kis/zárt helyen való munkavégzésre.

Fő jellemzők:

3 üzemmód + Vario-Lock funkció:

- fúró üzemmód
- kalapács üzemmód
- véső üzemmód
- vario-lock funkció: 36 állásban rögzíthető a vésőfej az optimális pozíció érdekében

- Max. fúrásteljesítmény fában: 30 mm
- Max. fúrásteljesítmény fémben: 13 mm
- Max. fúrásteljesítmény betonban: 26 mm

Írányváltós

Biztonsági tengelykapcsoló

Ütőerő: 3,2 J

Üresjárat fordulatszám: 0-1350 fordulat/perc

Löketszám: 0- 5700 löket/perc

Gabalyodásmentes kábel hossza: 4 m

Kiegészítők:

- 13 mm tokmány SDS-PLUS adapterrel
- 360°-ban elfordítható oldalmarkolat
- Mélységghatároló
- 3 db fúrófej falhoz, Ø 8-10-12 mm, hossz: 150 mm
- 1 db laposvéső, 14x250 mm
- 1 db pont véső, 14x250 mm



1967/800W

420x300x115 mm - 5,2 kg

Ft 89.050



1



019670080

1850D

3 sebességes hőlégfúvó pisztoly

- 1. pozíció 250 l/perc 50 °C
- 2. pozíció 250 l/perc 400 °C
- 3. pozíció 500 l/perc 550 °C



1850D	L mm 255	H mm 210	Ft 61.550	1	018500018
-------	----------------	----------------	--------------	---	-----------

1850E

állítható elektronikus hőlégfúvó pisztoly

- 1. pozíció 250-500 l/perc 50 °C
- 2. pozíció 250-500 l/perc 50-650 °C

- digitális kijelző
- hőmérséklet és légátesztés szabályozó gomb
- 4 tároló program és egyedi programozási lehetőség

- 1. program 150 °C kb. 400 l/perc
- 2. program 200 °C kb. 400 l/perc
- 3. program 300 °C kb. 450 l/perc
- 4. program 400 °C kb. 500 l/perc



1850E	L mm 255	H mm 210	Ft 128.700	1	018500020
-------	----------------	----------------	---------------	---	-----------

1851VK

hőragasztó-pisztoly 12 ragasztóstifttel, táskában

- teljesítmény: 80 W
- ø 11 mm és 12 mm ragasztóstifthez

CE



1851VK	Ft 25.300	1	018510058
--------	--------------	---	-----------

320x250x50 mm

1851VK-12C

12 ragasztó stift
ø 11 mm



1851VK-12C	Ft 6.520	1	018510062
------------	-------------	---	-----------

1851VK-12V

12 db hőragasztó stick
festett felületekhez
ø 11 mm



1851VK-12V	Ft 6.520	1	018510072
------------	-------------	---	-----------



1870

20 literes száraz-nedves porszívó

- egyfokozatú by-pass motor
- feszültség 220/240 V
- frekvencia 50/60 Hz
- legnagyobb teljesítmény 1200 W
- levegőszállítás l/mp. 58
- legnagyobb nyomáscsökkenés 190 mbár
- legnagyobb antistatikus PP tartálykapacitás 20 l
- zajkibocsátás <70 dB(A)
- kábelhossz 5 m
- tartozékartó kocsi
- Ø 36 mm TARTOZÉKOK
- 1 flexibilis cső ergonomikus markolattal
- 2 merev hosszabbító cső
- 1 többfunkciós kefe padlóhoz és folyadékhoz
- 1 rés szívófej
- SZŰRŐRENDSZEREK
- 1 felületi levegőszűrő betét 1900 cm² - 12 mikron névl.
- 1 habvédő szűrő PPI 45/PPI 30

CE



IPX4

1870	Ft 109.700	1	018700020
------	---------------	---	-----------

1870I

20 literes száraz-nedves porszívó
rozsdamentes acél tartály

- egyfokozatú by-pass motor
- tápfeszültség: 220/240 V
- frekvencia: 50/60 Hz
- legnagyobb teljesítmény: 1200 W
- szállított levegő mennyiség: 58 l/mp
- legnagyobb szívónyomás: 190 mbar
- max. tartálykapacitás: 20 liter, rozsdamentes acélból
- zajkibocsátás: <70 dB(A)
- Kábelhossz: 5 m
- SZABVÁNY TARTOZÉKOK Ø 36 mm
- 1 flexibilis gégecső ergonomikus markolattal és levegőszabályozóval
- 2 merev hosszabbító cső
- 1 1 többfunkciós kefe padlóhoz és folyadékhoz
- 1 rés szívófej
- 1 papírsák
- SZŰRŐRENDSZEREK
- 1 felületi levegőszűrő betét 1900 cm² - 12 mikron névl.
- 1 habvédő szűrő PPI 45/PPI 30

CE



IPX4

1870I	Ft 121.900	1	018700020
-------	---------------	---	-----------

1872L

35 literes száraz-nedves porszívó
"L" osztályú minősítés

- kétfokozatú by-pass motor
 - feszültség 220/240 V
 - frekvencia 50/60 Hz
 - legnagyobb teljesítmény 1100 W
 - levegőszállítás l/mp. 55
 - legnagyobb vákuum 220 mbár
 - az antisztatikus PE-HD anyagú tartály térfogata 35 l
 - zajkibocsátás <70 dB(A)
 - vezetékhozs 6 m
 - Ø 36 mm TARTOZÉKOK
 - 1 flexibilis cső ergonomikus markolattal
 - 2 műanyag hosszabbító cső
 - 1 kombinált kefe váz
 - 1 folyadékgyűjtő gumis betét
 - 1 nyeles szívófej
- SZÜRŐRENDSZEREK**
- 1 nemszött szövet szűrőzsák, "L" szűrési osztály
 - 1 szűrőbetét "L" osztályú IFA minősítéssel
 - 1 habvédő szűrő PPI 45/PPI 30
 - 2 PP PET csatolt utószűrő

CE



IPX4

1872L 35 Ft 239.300 1 018720135

1873

30 literes száraz-nedves porszívó,
ROZSDAMENTES acél tartállyal
Fűvás funkció

Nem hagynak nyomot a kerekek

- kétfokozatú by-pass motor
 - feszültség 220/240 V • frekvencia 50/60 Hz
 - legnagyobb teljesítmény 1100 W
 - levegőszállítás l/mp. 55
 - legnagyobb nyomásnövekedés 220 mbár
 - legnagyobb rozsdamentes acél tartálykapacitás 30 l
 - zajkibocsátás <61 dB(A)
 - kábelhozs 6 m • tartozéktartó kocsi
 - Ø 45 mm TARTOZÉKOK
 - 1 flexibilis cső ergonomikus markolattal
 - 2 rozsdamentes acél hosszabbító cső
 - 1 ipari kefe váz
 - 1 ipari szőnyegpadló szívóbetét
 - 1 ipari folyadékgyűjtő gumis betét
 - 1 rés szívófej
- SZÜRŐRENDSZEREK**
- 1 papír szűrőzsák
 - 1 felületi levegőszűrő betét 1900 cm² 12 mikron névl.
 - 1 habvédő szűrő PPI 45/PPI 30

CE



1873 30 Ft 319.000 1 018730030

1874

50 literes száraz-nedves porszívó,
ROZSDAMENTES acél tartállyal
Fűvás funkció

Nem hagynak nyomot a kerekek

- kétfokozatú by-pass motor
 - feszültség 220/240 V • frekvencia 50/60 Hz
 - legnagyobb teljesítmény 1350 W
 - levegőszállítás l/mp. 55
 - legnagyobb nyomásnövekedés 240 mbár
 - legnagyobb rozsdamentes acél tartálykapacitás 50 l
 - zajkibocsátás <63 dB(A)
 - kábelhozs 6 m • tartozéktartó kocsi
 - Ø 45 mm TARTOZÉKOK
 - 1 flexibilis cső ergonomikus markolattal
 - 2 rozsdamentes acél hosszabbító cső
 - 1 ipari kefe váz
 - 1 ipari szőnyegpadló szívóbetét
 - 1 ipari folyadékgyűjtő gumis betét
 - 1 rés szívófej
- SZÜRŐRENDSZEREK**
- 1 papír szűrőzsák
 - 1 felületi levegőszűrő betét 5200 cm² 12 mikron névl.
 - 1 habvédő szűrő PPI 45/PPI 30

CE



1874 50 Ft 402.400 1 018740050

1870-20/5S

5 vízszintes papírzsák az 1870-1870I-1875LT
modellhez



1870 20/5S Ft 24.900 1 018700021

1870-72 /FC

szűrőbetét, 1900 cm² névl. 12 mikron, az 1870
- 1870I - 1873 - 1875LT modellhez



1870/FC Ft 21.450 1 018700026

1870-72/FL

folyadékiszívó szűrő
az 1870 - 1870I - 1872L - 1873 - 1874 -
1875LT modellekhez



1870 72/FL Ft 7.890 1 018700027

1872L 35/FC

szűrőbetét, "L" osztály
a 1872L 35 készülékhez



1872L 35/FC Ft 25.900 1 018720144

1872L 35/5S

5 nemszött szövet szűrőzsák, "L" szűrési
osztály



1872L 35/5S Ft 39.450 1 018720136

1873-30/5S

5 függőleges papírzsák az 1873 modellhez



1873 30/5S Ft 24.900 1 018730031

1874-50/5S

5 függőleges az 1874 modellhez



1874 50/5S Ft 31.550 1 018740051

1874-50/FC

szűrőbetét, 5200 cm² névl. 12 mikron, az 1874
modellhez



1874 50/FC Ft 25.700 1 018740056



PNEUMATIKUS SZERSZÁMOK ÉS TAROZÉKOK



A Beta több mint 20 évvel ezelőtt pneumatikus szerszámokkal és azok tartozékaival bővítette termékpalettáját.

Az alant felsorolt szerszámok elsősorban az autópár és az ipari karbantartás területén használhatók: ütvecsavarbehajtók, racsnik, fűrőgépek, csiszoló- és polírozó gépek, stb. Időközben szoros együttműködés alakult ki termékeink professzionális felhasználóival, ami állandó fejlesztést garantált.

Ennek a fejlesztésnek köszönhetően a piac ma elismeri a Beta pneumatikus szerszámait, azok megbízhatóságát és teljesítményét.



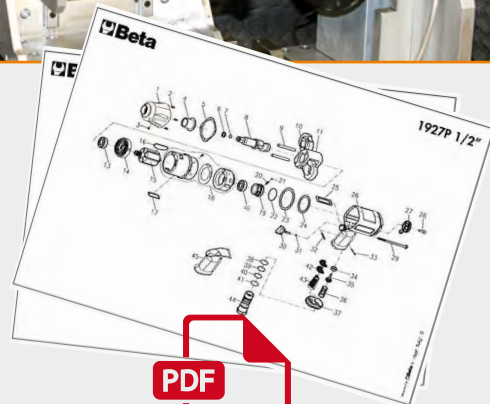
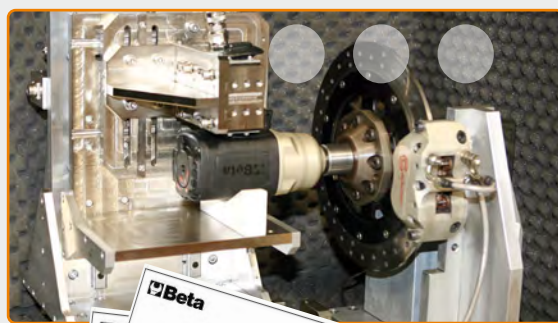

Annak érdekében, hogy a piac követelményeinek tökéletesen megfelelhessen, a Beta folyamatosan fejleszti pneumatikus eszközeit.

Ez a folyamat lehetővé teszi, hogy a know-how jelentősen növekedjen és a vevők igényeit teljesíteni tudja.





ÜTVECSAVARBEHAJTÓK

■	TERMÉK	KATALÓGUSSZÁM	ANYAG	 max. Nm	 db (A) LpA	 db (A) LpW	 l/min.	 kg	MECHANISM	 m/s ²
3/8"		1924F	Aluminium	108	93,6	104,6	59	0,5	Dupla ütőkalapács	6,85
3/8"		1924XM	Kompozit anyag	515	91,7	102,7	122	1,3	Ütőszegecs	6,2
1/2"		1927AN	Aluminium	244	89,4	100,4	190	2,1	Ütőszegecs	8,63
1/2"		1927G	Aluminium	325	92,2	103,2	113	1,2	Ütőszegecs	9,96
1/2"		1927E	Kompozit anyag	750	87,0	98,0	140	2,4	Dupla ütőkalapács	2,2
1/2"		1927XM	Aluminium	770	102	113	122	1,3	Ütőszegecs	7,5
1/2"		1927C	Kompozit anyag	950	88,2	99,2	125	2,1	Dupla ütőkalapács	9,6
1/2"		1927P	Kompozit anyag	1.750	95,1	106,1	290	2,0	Dupla ütőkalapács	6,7
1/2"		1927OLS	Aluminium	1.750	93,2	104,2	198	2,5	Dupla ütőkalapács	8,1
3/4"		1928XM	Aluminium	1.600	91,8	102,8	175	2,9	Dupla ütőkalapács	12,96
3/4"		1928DA	Aluminium	1.695	96	99,5	300	4,3	Dupla ütőkalapács	3,6
3/4"		1928DAL	Aluminium	1.695	96	99,5	300	4,8	Dupla ütőkalapács	3,6
3/4"		1928P	Kompozit anyag	2.100	96,2	107,2	221	3,7	Dupla ütőkalapács	7,6
1"		1930PA	Aluminium	2.445	96,0	97,1	410	9,6	Dupla ütőkalapács	7,2
1"		1930A	Aluminium	2.445	103,3	114,3	460	9,5	Dupla ütőkalapács	67
1"		1930LH	Aluminium	2.441	97,1	108,1	282	7,1	Dupla ütőkalapács	17,4
1"		1930LA	Aluminium	2.445	95,6	97,1	460	10,6	Dupla ütőkalapács	3,6
1"		1930HLA	Aluminium	3.661	99	101	460	16,4	Dupla ütőkalapács	16,4
1 1/2"		1930ZL	Aluminium	4.068	102,4	113,4	480	15	Dupla ütőkalapács	69,6



PNEUMATIKUS ÜTVECSAVARBEHAJTÓK

■	TERMÉK	KATALÓGUSSZÁM	max. Nm	db (A) LpA	db (A) LpW	l/min.	kg	m/s ²
1/4"		1921B1	24	96	85	90	0,4	2.6
1/4"		1921M1	27	84	88	96	0,6	1.8
1/4"		1922P1	68	90,6	101,6	88	0,6	8.61
3/8"		1921M2	27	84	88	96	0,6	1.8
3/8"		1922P2	68	90,6	101,6	88	0,6	8.61
1/2"		1921N3	68	80	87	140	1,2	2.6
1/2"		1922P3	136	94,9	105,9	113	1,5	18.28

KÖSZÖRŰK

	TERMÉK	KATALÓGUSSZÁM	MOTORELJESÍTMÉNY	db (A) LpA	db (A) LpW	l/min.	kg	m/s ²
		1933	0,20 kW	80,0	87,0	230	0,38	4,53
		1933L	0,20 kW	80,0	87,0	270	0,67	1,15
		1933AN90	0,20 kW	80,0	87,0	230	0,51	1,24
		1933I	0,38 kW	80,0	87,0	260	0,67	4,53
		1933IL	0,38 kW	79,0	97,0	113	1,4	1,6
		1933IH	0,75 kW	88,1	99,1	370	0,8	2,6
		1933ILH	0,75 kW	85,7	96,7	370	1,2	1,4
		1933AN90-H	0,75 kW	85,6	96,6	370	1,1	6,7
		1934MAV	0,04 kW	71	76	115	0,2	2,5
		1934MAV70	0,08 kW	80	87	115	0,2	4

1921B1

Baby-irányváltós racsni

1/4"

CE



130 mm

Üresjárat fordulatszám

350 fordulat/perc

Max. nyomaték

24 Nm

Csavar Ø

CI 8.8 M7●11 mm

Csavar Ø

CI 12.9 M6●10 mm

Levegőcsatlakozás

1/4" GAS

Üzemi nyomás

6,2 bar

Ajánlott tömlő-Ø

8 mm

Átlagos levegőfelhasználás

68 l/perc

Súly

0,4 kg

1/4"					
	kg	Ft			
1/4	0,4	115.400	1	019210001	

1921N3

irányváltós racsni

1/2"

CE



258 mm

Üresjárat fordulatszám

150 fordulat/perc

Max. forgatónyomaték

68 Nm

Csavar Ø

CI 8.8 M10●16 mm

Csavar Ø

CI 12.9 M8●13 mm

Levegőcsatlakozás

1/4" GAS

Üzemi nyomás

6,2 bar

Ajánlott tömlő Ø

10 mm

Átlagos levegőfelhasználás

140 l/perc

Súly

1,2 kg

1/2"					
	kg	Ft			
1/2	1,2	101.600	1	019210025	

1922P3

csúszóalapácsos irányváltós racsni

1/2"

CE



292 mm

Szabad fordulatszám

600 ford/perc

Legnagyobb nyomaték

136 Nm

Csavar/anya méret

CI 8.8 M12●18 mm

Csavar/anya méret

CI 12.9 M10●16 mm

Levegőcsatlakozó

1/4" GAS

Üzemi nyomás

6,2 bar

Levegőcső belső Ø

10 mm

Átlagos levegőfogyasztás

113 l/p

Súly

1,5 kg

1/2"					
	kg	Ft			
1/2	1,5	194.700	1	019220013	

1921M1

irányváltós racsni, kompakt kivitel

• Sebességszabályozás

1/4"

CE



198 mm

Üresjárat fordulatszám

200 fordulat/perc

Max. forgatónyomaték

27 Nm

Csavar Ø

CI 8.8 M7●11 mm

Csavar Ø

CI 12.9 M6●10 mm

Levegőcsatlakozás

1/4" GAS

Üzemi nyomás

6,2 bar

Ajánlott tömlő Ø

8 mm

Átlagos levegőfelhasználás

96 l/perc

Súly

0,6 kg

1/4"					
	kg	Ft			
1/4	0,6	101.600	1	019210005	

1922P1

csúszóalapácsos irányváltós racsni

• Impulzív "Kettős rocking dog" mechanizmus

1/4"

CE



164 mm

Szabad fordulatszám

700 ford/perc

Legnagyobb nyomaték

68 Nm

Csavar/anya méret

CI 8.8 M10●16 mm

Csavar/anya méret

CI 12.9 M8●13 mm

Levegőcsatlakozó

1/4" GAS

Üzemi nyomás

6,2 bar

Levegőcső belső Ø

10 mm

Átlagos levegőfogyasztás

88 l/p

Súly

0,6 kg

1/4"					
	kg	Ft			
1/4	0,6	123.500	1	019220006	

1924F

kompakt "butterfly" irányváltós csavarbehajtó

• Impulzív "Kettős rocking dog" mechanizmus

3/8"

CE



139 mm

Szabad fordulatszám

12 000 ford/perc

Legnagyobb nyomaték

108 Nm

Csavar/anya méret

CI 8.8 M12●18 mm

Csavar/anya méret

CI 12.9 M10●16 mm

Levegőcsatlakozó

1/4" GAS

Üzemi nyomás

6,2 bar

Levegőcső belső Ø

10 mm

Átlagos levegőfogyasztás

59 l/p

Súly

0,5 kg

3/8"					
	kg	Ft			
3/8	0,5	114.200	1	019240025	

1921M2

irányváltós racsni, kompakt kivitel

• Sebességszabályozás

3/8"

CE



198 mm

Üresjárat fordulatszám

200 fordulat/perc

Max. forgatónyomaték

27 Nm

Csavar Ø

CI 8.8 M7●11 mm

Csavar Ø

CI 12.9 M6●10 mm

Levegőcsatlakozás

1/4" GAS

Üzemi nyomás

6,2 bar

Ajánlott tömlő Ø

8 mm

Átlagos levegőfelhasználás

96 l/perc

Súly

0,6 kg

3/8"					
	kg	Ft			
3/8	0,6	101.600	1	019210015	

1922P2

csúszóalapácsos irányváltós racsni

• Impulzív "Kettős rocking dog" mechanizmus

3/8"

CE



164 mm

Szabad fordulatszám

700 ford/perc

Legnagyobb nyomaték

68 Nm

Csavar/anya méret

CI 8.8 M10●16 mm

Csavar/anya méret

CI 12.9 M8●13 mm

Levegőcsatlakozó

1/4" GAS

Üzemi nyomás

6,2 bar

Levegőcső belső Ø

10 mm

Átlagos levegőfogyasztás

88 l/p

Súly

0,6 kg

3/8"					
	kg	Ft			
3/8	0,6	123.500	1	019220010	



A FORRADALMI ÜTVECSAVARBEHAJTÓ, AMELY NEM IGÉNYEL KENÉST



A Beta Utensili által tervezett, fejlesztett és gyártott 1927OLS ütvecsavarbehajtó az **OLAJ NÉLKÜLI** rendszerre épül, amely a pneumatikus szerszámiparban új innovációnak számít. Ennek köszönhetően az ütvecsavarbehajtó rendszeres kenés nélkül is folyamatosan használható, ami hosszabb élettartamot és nagyobb teljesítményt biztosít.

**SZABADALMI OLTALOM
BEJEGYZÉSE FOLYAMATBAN**



A kiemelkedő, **1750 Nm nyomatékának** hála az **OLAJ NÉLKÜLI** ütvecsavarbehajtó minden alkalmazáshoz ideális választás. A precíz összeszerelés, a belső alkatrészek mikrométeres illesztése és a felhasznált első osztályú anyagok csökkentik a meghibásodások számát, lehetővé téve a kenésmentes, élethosszig tartó használatot.

Ezek a jellemzők együtt kiváló költség/haszon arányt biztosítanak, ami hosszú távon jelentős megtakarítást eredményez.

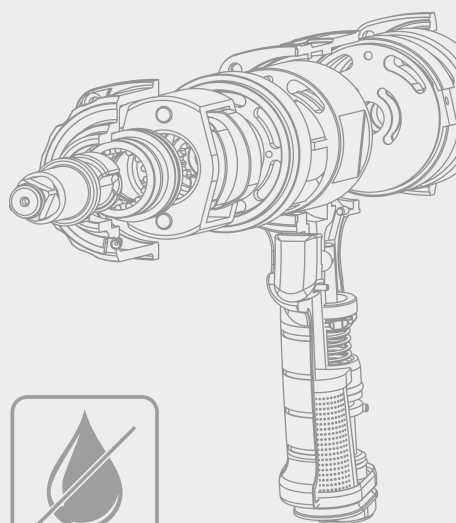

4X NÉGYSZER HOSSZABB
ÉLETTARTAM, MINT
EGY HAGYOMÁNYOS
ÜTVECSAVARBEHAJTÓNÁL.



1924XM irányváltós ütvecsavarbehajtó

• Szimpla ütőmechanizmus



Üresjárat fordulatszám	9 000 fordulat/perc
Max. forgatónyomaték	515 Nm
Csavar Ø	CI 8.8 M16<34 mm
Csavar Ø	CI 12.9 M14<27 mm
Levegőcsatlakozás	1/4" GAS
Üzemi nyomás	6,2 bar
Ajánlott tömlő Ø	10 mm
Átlagos levegőfelhasználás	122 l/perc
Súly	1,3 kg

3/8"	kg	Ft	1	019240030
	1,3	126.300		

1927OLS OLAJ NÉLKÜLI irányváltós ütvecsavarbehajtó, alumíniumötvözet test

• Nem igényel kenést
• Dupla ütőmechanizmus



Üresjárat fordulatszám	8 000 fordulat/perc
Max. forgatónyomaték	1 750 Nm
Csavar Ø	CI 8.8 M24<36 mm
Csavar Ø	CI 12.9 M20<30 mm
Levegőcsatlakozás	1/4" GAS
Üzemi nyomás	6,2 bar
Ajánlott tömlő Ø	10 mm
Átlagos levegő fogyasztás	198 l/perc
Súly	2,5 kg

1/2"	kg	Ft	1	019270010
	2,5	325.100		

1927E

Írányváltós ütvecsavarbehajtó kompozit házzal

• Dupla ütőmechanizmus



Üresjárat fordulatszám	7 000 fordulat/perc
Max. forgatónyomaték	750 Nm
Csavar Ø	CI 8.8 M24●36 mm
Csavar Ø	CI 12.9 M20●30 mm
Levegőcsatlakozás	1/4" GAS
Üzemi nyomás	6,2 bar
Ajánlott tömlő Ø	10 mm
Átlagos levegő fogyasztás	197 l/perc
Súly	2,4 kg

■	■	Ft	■	■
1/2	2,4	62.350	1	019270005

1927P

Írányváltós ütvecsavarbehajtó, jobbos-balos, plattírozott anyagból

• Dupla ütőmechanizmus



Üresjárat fordulatszám	7.500 fordulat/perc
Max. forgatónyomaték	1.750 Nm
Csavar-Ø	CI 8.8 M24●36 mm
Csavar-Ø	CI 12.9 M20●30 mm
Levegőcsatlakozás	1/4" GAS
Üzemi nyomás	6,2 bar
Ajánlott tömlő-Ø	10 mm
Átlagos levegőfelhasználás	290 l/perc
Súly	2 kg

■	■	Ft	■	■
1/2	2,0	200.400	1	019270008

1927XM

kompakt irányváltós csavarbehajtó

• Impulzív egykalapácsos mechanizmus



Szabad sebesség	10.000 ford./perc
Legnagyobb nyomaték	770 Nm
Csavar/anya kapacitás	CI 8.8 M22●34 mm
Csavar/anya kapacitás	CI 12.9 M18●27 mm
Levegőcsatlakozó	1/4" GAS
Üzemi nyomás	6,2 bar
Levegőcső belső Ø	10 mm
Átlagos levegőfogyasztás	122 l/perc
Súly	1,3 kg

■	■	Ft	■	■
1/2	1,3	124.700	1	019270030

1927C

Írányváltós ütvecsavarbehajtó kompozit házzal

• Dupla ütőmechanizmus



Üresjárat fordulatszám	9 000 fordulat/perc
Max. forgatónyomaték	900 Nm
Csavar Ø	CI 8.8 M22●34 mm
Csavar Ø	CI 12.9 M18●27 mm
Levegőcsatlakozás	1/4" GAS
Üzemi nyomás	6,2 bar
Ajánlott tömlő Ø	10 mm
Átlagos levegő fogyasztás	125 l/perc
Súly	2,1 kg

■	■	Ft	■	■
1/2	2,1	104.900	1	019270006

1927P/K3

Írányváltós ütvecsavarozó kompozit anyagból, 3 gépi dugókulccsal



Üresjárat fordulatszám	7,500 fordulat/perc
Max. forgatónyomaték	1.750 Nm
Csavar Ø	CI 8.8 M24<36 mm
Csavar Ø	CI 12.9 M20<30 mm
Levegőcsatlakozás	1/4" GAS
Üzemi nyomás	6,2 bar
Belső tömlőátmérő (Ø)	10 mm
Átlagos levegőfelhasználás	280 l/perc
Súly	2,9 kg

■	■	Ft	■	■
1/2	4	261.900	1	019270118
☞ 350x305x86 mm				

1927XM/K5

Írányváltós kompakt csavarbehajtó és 5 gépi dugókulcs készlet

• Egykalapácsos ütőmechanizmus



Szabad fordulatszám	10.000 ford./perc
Legnagyobb nyomaték	770 Nm
Csavar/anya méret	CI 8.8 M22●34 mm
Csavar/anya méret	CI 12.9 M18●27 mm
Levegőcsatlakozás	1/4" GÁZ
Üzemi nyomás	6,2 bar
cső belső Ø	10 mm
Átlagos levegőfogyasztás	122 l/perc
Súly	1,3 kg

■	■	Ft	■	■
1/2	2,8	153.700	1	019270129
☞ 307x206x86 mm				

1927AN

Írányváltós sarokűtvecsavarbehajtó, jobbos-balos

- Egy ütőműves

12"

CE



Üresjárat fordulatszám	4.700 fordulat/perc
Max. forgatónyomaték	244 Nm
Csavar-Ø	CI 8.8 M14 ● 21 mm
Csavar-Ø	CI 12.9 M12 ● 19 mm
Levegőcsatlakozás	1/4" GAS
Üzemi nyomás	6,2 bar
Ajánlott tömlő-Ø	10 mm
Átlagos levegőfelhasználás	190 l/perc
Súly	2,1 kg

1/2"	kg	Ft	1	019270012
	2,1	237.200		

19276

kompakt írányváltós csavarbehajtó

- Egyes ütőmechanizmus

12"

CE



Üresjárat fordulatszám	8500 ford/perc
Legnagyobb nyomaték	325 Nm
Csavar/anya méret	CI 8.8 M16 ● 24 mm
Csavar/anya méret	CI 12.9 M14 ● 21 mm
Levegőcsatlakozó	1/4" GAS
Üzemi nyomás	6,2 bar
Levegőcső belső Ø	10 mm
Átlagos levegőfogyasztás	113 l/p
Súly	1,2 kg

1/2"	kg	Ft	1	019270050
	1,2	195.100		

1927SP-AM

mágneses tartó pneumatikus csavarbehajtóhoz

- két nagymegtartású, védőgumival szerelt mágnessel rendelkezik
- egy 1/2" csavarbehajtó, 4 dugókulcs és 1 nyomatékkulcs elhelyezését teszi lehetővé
- teherbírás: 10 kg



400 g	Ft	1	019270000
	28.950		

1928DA

Írányváltós ütvecsavarbehajtó

- Dupla ütőmechanizmus

3/4"

CE



Üresjárat fordulatszám	5.000 fordulat/perc
Max. nyomaték	1.695 Nm
Csavar Ø	CI 8.8 M30 ● 46 mm
Csavar Ø	CI 12.9 M27 ● 41 mm
Levegőcsatlakozás	3/8" GAS
Üzemi nyomás	6,2 bar
Ajánlott tömlő Ø	10 mm
Átlagos levegőfelhasználás	240 l/perc
Súly	4,3 kg

3/4"	kg	Ft	1	019280022
	4,3	385.400		

1928DAL

Írányváltós ütvecsavarbehajtó, jobbos-balos

- Dupla ütőmechanizmus
- 6" hosszú meghajtótengely
- Robusztus, kompakt modell; nagy forgatónyomaték
- Egyszerű irányváltás
- 3-fokozatú csavarbehajtás
- Levegőelvezetés a markolaton keresztül
- Ergonómikus, csúszásmentes markolat

CE



Üresjárat fordulatszám	5.000 fordulat/perc
Max. forgatónyomaték	1.695 Nm
Csavar Ø	CI 8.8 M27 ● 41 mm
Csavar Ø	CI 12.9 M24 ● 36 mm
Levegőcsatlakozás	3/8" GAS
Üzemi nyomás	6,2 bar
Ajánlott tömlő Ø	10 mm
Átlagos levegőfelhasználás	240 l/perc
Súly	4,8 kg

3/4"	kg	Ft	1	019280023
	4,8	413.400		

1928K4

1 irányváltós ütvecsavarbehajtó, 4 hosszú gépi dugókulcs

- "Pin Clutch" ütőmechanizmus

3/4"

CE



Üresjárat fordulatszám	4.000 fordulat/perc
Max. nyomaték	1.493 Nm
Csavar Ø	CI 8.8 M27 ● 41 mm
Csavar Ø	CI 12.9 M24 ● 36 mm
Levegőcsatlakozás	3/8" GAS BSP
Üzemi nyomás	6,2 bar
Ajánlott tömlő Ø	10 mm
Átlagos levegőfelhasználás	260 l/perc
Csavarbehajtó súlya	5,2 kg

3/4"	kg	Ft	1	019280104
	9,3	393.100		
410x330x106 mm				

1928XM

írányváltós ütvecsavarbehajtó

- Dupla ütőmechanizmus
- Robusztus, kompakt modell, nagy forgatónyomaték
- Egykezes irányváltó gomb
- 3-fokozatú csavarbehajtás
- Levegőelvezetés a markolaton keresztül

3/4"

CE



Üresjárat fordulatszám	4 800 fordulat/perc
Max. forgatónyomaték	1 600 Nm
Csavar Ø	CI 8.8 M27 ● 41 mm
Csavar Ø	CI 12.9 M24 ● 36 mm
Levegőcsatlakozás	3/8" GAS
Üzemi nyomás	6,2 bar
Ajánlott tömlő Ø	10 mm
Átlagos levegőfelhasználás	175 l/perc
Súly	2,9 kg

3/4"	kg	Ft	1	019280030
	2,9	266.400		

1928P

Írányváltós ütvecsavarbehajtó plattírozott anyagból

• Dupla ütőmechanizmus



Üresjárat fordulatszám	5 000 fordulat/perc
Max. forgatónyomaték	2 100 Nm
Csavar Ø	CI 8.8 M30●46 mm
Csavar Ø	CI 12.9 M27●41 mm
Levegőcsatlakozás	3/8" GAS
Üzemi nyomás	6,2 bar
Ajánlott tömlő Ø	10 mm
Átlagos levegőfelhasználás	221 l/perc
Súly	3,7 kg

3/4"	kg	Ft	1	019280006
3,7		530.400		

1930PA

Írányváltós ütvecsavarbehajtó

• Dupla ütőmechanizmus



Üresjárat fordulatszám	3.500 fordulat/perc
Max. forgatónyomaték	2.445 Nm
Csavar-Ø	CI 8.8 M36●55 mm
Csavar-Ø	CI 12.9 M30●46 mm
Levegőcsatlakozás	1/2" GAS
Üzemi nyomás	6,2 bar
Ajánlott tömlő-Ø	13 mm
Átlagos levegőfelhasználás	350 l/perc
Súly	9,6 kg

1"	kg	Ft	1	019300032
9,6		574.900		

1930A

Írányváltós csavarbehajtó

• Kétkalapácsos ütőmechanizmus



Szabad fordulatszám	4.000 ford./perc
Legnagyobb nyomaték	2.445 Nm
Csavar/anya méret	CI 8.8 M36●55 mm
Csavar/anya méret	CI 12.9 M30●46 mm
Levegőcsatlakozó	1/2" GAS
Üzemi nyomás	6,2 bar
Levegő cső belső Ø	13 mm
Átlagos levegőfogyasztás	460 l/perc
Súly	9,5 kg

1"	kg	Ft	1	019300036
9,5		583.000		

1930LH

Írányváltós csavarbehajtó

• Kettős ütőmechanizmus

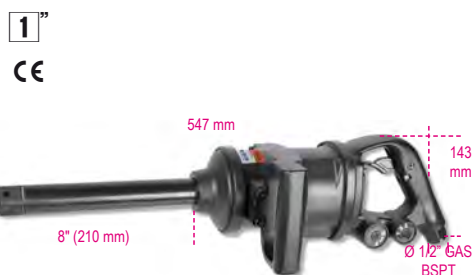

Üresjárat fordulatszám	6 000 ford/perc
Legnagyobb nyomaték	2 441 Nm
Csavar/anya méret	CI 8.8 M36●55 mm
Csavar/anya méret	CI 12.9 M30●46 mm
Levegőcsatlakozó	1/2" GAS
Üzemi nyomás	6,2 bar
Levegőcső belső Ø	13 mm
Átlagos levegőfogyasztás	280 l/p
Súly	7,1 kg

1"	kg	Ft	1	019300030
7,1		595.100		

1930LA

Írányváltós ütvecsavarbehajtó

• Dupla ütőmechanizmus



Üresjárat fordulatszám	4.000 fordulat/perc
Max. forgatónyomaték	2.445 Nm
Csavar Ø	CI 8.8 M36●55 mm
Csavar Ø	CI 12.9 M30●46 mm
Levegőcsatlakozás	1/2" GAS
Üzemi nyomás	6,2 bar
Ajánlott tömlő Ø	13 mm
Átlagos levegőfelhasználás	460 l/perc
Súly	10,6 kg

1"	kg	Ft	1	019300037
10,6		605.300		



1930HLA

Írányváltós ütvecsavarbehajtó

• Dupla ütőmechanizmus

1"

CE



Üresjárat fordulatszám	3.000 fordulat/perc
Max. forgatónyomaték	3.661 Nm
Csavar Ø	CI 8.8 M42 ● 65 mm
Csavar Ø	CI 12.9 M33 ● 50 mm
Levegőcsatlakozás	1/2" GAS
Üzemi nyomás	6,2 bar
Ajánlott tömlő Ø	13 mm
Átlagos levegőfelhasználás	460 l/perc
Súly	16,4 kg

1	kg	Ft	1	019300040
16,4		838.100		

1931CD6

Írányváltós fűrőgép kompozitházzal

1 1/8"

CE



Üresjárat fordulatszám	2.600 fordulat/perc
Fűrőtokmány	1+6 mm
Motorteljesítmény	0,23 kW
Felfogóméret	3/8" - 24UNF
Levegőcsatlakozás	1/4" GAS
Üzemi nyomás	6,2 bar
Ajánlott tömlő-Ø	8 mm
Átlagos levegőfelhasználás	130 l/perc
Súly	0,6 kg

0,6	kg	Ft	1	019310006
		123.100		

1931CD13

Írányváltós fűrőgép kompozitházzal

1 1/8"

CE



Üresjárat fordulatszám	800 fordulat/perc
Fűrőtokmány	1,0+13 mm
Motorteljesítmény	0,38 kW
Felfogóméret	1/2" - 20UNC
Levegőcsatlakozás	1/4" GAS
Üzemi nyomás	6,2 bar
Ajánlott tömlő-Ø	10 mm
Átlagos levegőfelhasználás	170 l/perc
Súly	1,3 kg

1,3	kg	Ft	1	019310013
		164.400		

1930ZL

Írányváltós ütvecsavarbehajtó

• Dupla ütőmechanizmus

1 1/2"

CE



Üresjárat fordulatszám	3.000 fordulat/perc
Max. forgatónyomaték	4.068 Nm
Csavar Ø	CI 8.8 M42 ● 65 mm
Csavar Ø	CI 12.9 M36 ● 55 mm
Levegőcsatlakozás	1/2" GAS
Üzemi nyomás	6,2 bar
Ajánlott tömlő Ø	13 mm
Átlagos levegőfelhasználás	480 l/perc
Súly	15 kg

1 1/2	kg	Ft	1	019300070
15		1.052.600		

1931CD10

Írányváltós fűrőgép kompozitházzal

1 1/8"

CE



Üresjárat fordulatszám	1.800 fordulat/perc
Fűrőtokmány	1+10 mm
Motorteljesítmény	0,38 kW
Felfogóméret	3/8" - 24UNF
Levegőcsatlakozás	1/4" GAS
Üzemi nyomás	6,2 bar
Ajánlott tömlő-Ø	10 mm
Átlagos levegőfelhasználás	170 l/perc
Súly	1 kg

1,0	kg	Ft	1	019310010
		110.500		

1931AN10

Írányváltós sarokfűrőgép

1 1/8"

CE



Üresjárat fordulatszám	1.400 fordulat/perc
Fűrőtokmány	1+10 mm
Motorteljesítmény	0,38 kW
Felfogóméret	3/8" - 24UNF
Levegőcsatlakozás	1/4" GAS
Üzemi nyomás	6,2 bar
Ajánlott tömlő-Ø	10 mm
Átlagos levegőfelhasználás	150 l/perc
Súly	1,1 kg

1,1	kg	Ft	1	019310030
		123.100		

1932B10

Írányváltós fúrógép



Üresjárat fordulatszám	1.800 fordulat/perc
Fúrótokmány	1÷10 mm
Motorteljesítmény	0,44 kW
Felfogóméret	3/8" - 24UNF
Levegőcsatlakozás	1/4" GAS
Üzemi nyomás	6,2 bar
Ajánlott tömlő-Ø	10 mm
Átlagos levegőfelhasználás	160 l/perc
Súly	1,2 kg

kg	Ft	1	019320040
1,2	88.050		

1932RS13

Írányváltós fúrógép



Üresjárat fordulatszám	750 fordulat/perc
Fúrótokmány	1,5÷13 mm
Motorteljesítmény	0,55 kW
Felfogóméret	3/8" - 24UNF
Levegőcsatlakozás	1/4" GAS
Üzemi nyomás	6,2 bar
Ajánlott tömlő-Ø	10 mm
Átlagos levegőfelhasználás	160 l/perc
Súly	1,4 kg

kg	Ft	1	019320043
1,4	111.700		

1932B13

Írányváltós fúrógép



Üresjárat fordulatszám	400 fordulat/perc
Fúrótokmány	1,5÷13 mm
Motorteljesítmény	0,34 kW
Felfogóméret	1/2" - 20UNC
Levegőcsatlakozás	1/4" GAS
Üzemi nyomás	6,2 bar
Ajánlott tömlő-Ø	10 mm
Átlagos levegőfelhasználás	180 l/perc
Súly	1,6 kg

kg	Ft	1	019320004
1,6	131.600		

1933IH

nagyteljesítményű egykezes egyenes rúdcsiszoló

• Patron, Ø 3 mm és 6 mm



Üresjárat fordulatszám	20.000 fordulat/perc
Patron	3 - 6 mm
Motorteljesítmény	0,75 kW
Levegőcsatlakozás	1/4" GAS
Üzemi nyomás	6,2 bar
Ajánlott tömlő-Ø	10 mm
Átlagos levegőfelhasználás	370 l/perc
Súly	800 g

g	Ft	1	019330006
800	99.800		



1933ILH

nagyteljesítményű egykezes egyenes hosszított rúdcsiszoló

• Patron, Ø 3 mm és 6 mm

CE



Üresjárat fordulatszám	20.000 fordulat/perc
Patron	3 - 6 mm
Motorteljesítmény	0,75 kW
Levegőcsatlakozás	1/4" GAS
Üzemi nyomás	6,2 bar
Ajánlott tömlő-Ø	10 mm
Átlagos levegőfelhasználás	370 l/perc
Súly	1,2 kg

kg	Ft	1	019330011
1,2	187.400		

1933AN90-H

nagyteljesítményű sarokcsiszoló

• Patron, Ø 3 mm és 6 mm

CE



Üresjárat fordulatszám	15 000 fordulat/perc
Patron	3 - 6 mm
Motorteljesítmény	0,75 kW
Levegőcsatlakozás	1/4" GAS
Üzemi nyomás	6,2 bar
Ajánlott tömlő-Ø	10 mm
Átlagos levegőfelhasználás	370 l/perc
Súly	1,1 kg

kg	Ft	1	019330021
1,1	187.400		

1933

Egykezes egyenes rúdcsiszoló

• Szállítás 3 - 6 mm-es patronnal

CE



Üresjárat fordulatszám	25.000 fordulat/perc
Patron	3 - 6 mm
Motorteljesítmény	0,20 kW
Levegőcsatlakozás	1/4" GAS
Üzemi nyomás	6,2 bar
Ajánlott tömlő-Ø	10 mm
Átlagos levegőfelhasználás	230 l/min
Súly	380 g

g	Ft	1	019330001
380	65.400		

1933I

Egykezes egyenes rúdcsiszoló

• Szállítás: 3-6 mm patronnal

CE



Üresjárat fordulatszám	20.000 fordulat/perc
Patron	3 - 6 mm
Motorteljesítmény	0,38 kW
Levegőcsatlakozás	1/4" GAS
Üzemi nyomás	6,2 bar
Ajánlott tömlő-Ø	10 mm
Átlagos levegőfelhasználás	260 l/min
Súly	670 g

g 670 Ft 74.300 1 019330005

1933AN90

Egykezes sarokcsiszoló

• Szállítás: 3-6 mm patronnal

CE



Üresjárat fordulatszám	20.000 fordulat/perc
Patron	3 - 6 mm
Motorteljesítmény	0,20 kW
Levegőcsatlakozás	1/4" GAS
Üzemi nyomás	6,2 bar
Ajánlott tömlő-Ø	10 mm
Átlagos levegőfelhasználás	230 l/min
Súly	510 g

g 510 Ft 83.800 1 019330020

1934MAV

Egykezes mikro rúdcsiszoló

CE



Üresjárat fordulatszám	56.000 fordulat/perc
Patron	3 mm
Motorteljesítmény	0,04 kW
Levegőcsatlakozás	1/4" GAS BSPT
Üzemi nyomás	6,2 bar
Ajánlott tömlő-Ø	4,5 mm
Átlagos levegőfelhasználás	115 l/min
Súly	0,2 kg

g 205 Ft 77.550 1 019340010

1933L

Egykezes egyenes hosszított rúdcsiszoló

• Szállítás: 3-6 mm patronnal

CE



Üresjárat fordulatszám	25.000 fordulat/perc
Patron	3 - 6 mm
Motorteljesítmény	0,20 kW
Levegőcsatlakozás	1/4" GAS
Üzemi nyomás	6,2 bar
Ajánlott tömlő-Ø	10 mm
Átlagos levegőfelhasználás	270 l/min
Súly	670 g

g 670 Ft 83.800 1 019330015

1934BV

Alacsonyfordulatú gumibroncs polírozó

• Szállítás: 3-6 mm patronnal

CE



Üresjárat fordulatszám	3.700 fordulat/perc
Patron	3 - 6 mm
Motorteljesítmény	0,37 kW
Levegőcsatlakozás	1/4" GAS
Üzemi nyomás	6,2 bar
Ajánlott tömlő-Ø	10 mm
Átlagos levegőfelhasználás	113 l/min
Súly	0,84 kg

g 840 Ft 90.500 1 019340000

1934MAV70

Nagy fordulatszámú Mikro-egykezes rúdcsiszoló

CE



Üresjárat fordulatszám	70.000 fordulat/perc
Patron	3 mm
Motorteljesítmény	0,08 kW
Levegőcsatlakozás	1/4" GAS BSPT
Üzemi nyomás	6,2 bar
Ajánlott tömlő-Ø	4,5 mm
Átlagos levegőfelhasználás	115 l/min
Súly	0,21 kg

g 210 Ft 128.700 1 019340030

1933IL

Egykezes egyenes hosszított rúdcsiszoló

• Szállítás: 3-6 mm patronnal

CE



Üresjárat fordulatszám	20.000 fordulat/perc
Patron	3 - 6 mm
Motorteljesítmény	0,38 kW
Levegőcsatlakozás	1/4" GAS
Üzemi nyomás	6,2 bar
Ajánlott tömlő Ø	10 mm
Átlagos levegőfelhasználás	113 l/min
Súly	1,4 kg

kg 1,4 Ft 101.600 1 019330010



1935F

Írányváltós csavarbehajtó



Üresjárat fordulatszám	800 fordulat/perc
Nyomaték	4-16 Nm
Csavar-Ø	6-9 M
Betéttartó	1/4"
Levegőcsatlakozás	1/4" GAS
Üzemi nyomás	6,2 bar
Ajánlott tömlő-Ø	10 mm
Átlagos levegőfelhasználás	150 l/perc
Súly	1,3 kg

kg	1,3	Ft	123.100	1	019350045
----	-----	----	---------	---	-----------

1936/5A

Sarokcsiszoló



Üresjárat fordulatszám	10.000 fordulat/perc
Tányérméret	125 mm
Motorteljesítmény	0,66 kW
Felfogóméret	M14
Levegőcsatlakozás	1/4" GAS
Üzemi nyomás	6,2 bar
Ajánlott tömlő-Ø	10 mm
Átlagos levegőfelhasználás	390 l/perc
Súly	1,9 kg

kg	1,9	Ft	202.800	1	019360025
----	-----	----	---------	---	-----------

1936/7A

Sarokcsiszoló



Üresjárat fordulatszám	7600 giri/min
Tányérméret	180 mm
Motorteljesítmény	1,3 kW
Tengelyméret	M14
Levegőcsatlakozás	3/8" GAS
Üzemi nyomás	6,2 bar
Ajánlott tömlő-Ø	13 mm
Átlagos levegőfelhasználás	906 l/min
Súly	2,7 kg

kg	2,7	Ft	296.800	1	019360027
----	-----	----	---------	---	-----------

1937

Excenteresiszoló mintázott markolattal, kenés nélkül, platírozott anyagból

• Rezgőkör keresztmetszete 5 mm



Üresjárat fordulatszám	12.000 fordulat/perc
Motorteljesítmény	0,18 kW
Csiszolótányér mérete	150 mm
Rezgőkör keresztmetszete	5 mm
Patron	5/16"-24
Levegőcsatlakozás	1/4" GAS
Üzemi nyomás	6,2 bar
Ajánlott tömlő-Ø	10 mm
Átlagos levegőfelhasználás	170 l/perc
Súly	0,86 kg

kg	0,86	Ft	213.800	1	019370001
----	------	----	---------	---	-----------

1937R/P

Csiszolótányér Ø 150 mm, 6-lyukú perforált a 1937-hez



1937R/P	Ft	22.250	1	019370002
---------	----	--------	---	-----------

1936/4A

Sarokcsiszoló



Üresjárat fordulatszám	11.000 fordulat/perc
Tányérméret	115 mm
Motorteljesítmény	0,66 kW
Felfogóméret	M14
Levegőcsatlakozás	1/4" GAS
Üzemi nyomás	6,2 bar
Ajánlott tömlő-Ø	10 mm
Átlagos levegőfelhasználás	390 l/perc
Súly	1,77 kg

kg	1,8	Ft	202.800	1	019360024
----	-----	----	---------	---	-----------

1937KC

mini excenteres csiszoló

• 2 db csiszolótányér Ø 50 mm és Ø 75 mm
• 10 db csiszolópapír tárcsa Ø 50 mm finomság 400, 600, 800
• 10 db csiszolópapír tárcsa Ø 75 mm finomság 400, 600, 800



Üresjárat fordulatszám:	15000
Teljesítmény	0,25
Csiszolótányér méret	50 - 75
Tengely menet	M6 x 1,0
Levegőcsatlakozó	1/4" BSPT
Üzemi nyomás	6,2
Levegőcső belső Ø	10
Átlagos levegőfogyasztás	79
Polírozógép súly	0,64
Készlet súly	1,4

kg	1,4	Ft	122.700	1	019370171
----	-----	----	---------	---	-----------



1937C...

csiszolópapír tárcsa a 1937KC készülékhez



Ø mm	P	Ft	1	1
50	400	7.290	1	019370175
50	600	7.290	1	019370176
50	800	7.290	1	019370177
75	400	9.270	1	019370178
75	600	9.270	1	019370179
75	800	9.270	1	019370180

* A jelzett árak 10 darabra vonatkoznak

1937KL

mini polírozó

- Csiszolóátányér Ø 75 mm
- 2 csiszolószivacs Ø 90 mm - 1937/KL-DSB, 1937/KL-DSG
- Bărănygyapjú Ø 90 mm - 1937/KL-DLA

CE



Szabad sebesség	3.200 ford/perc
Teljesítmény	0,25 kW
Csiszolóátányér méret	75 mm
Tengely csavarmenet	M6
Levegőcsatlakozó	1/4" GAS BSPT
Üzemi nyomás	6,2 bar
cső belső Ø	10 mm
Átlagos levegőfogyasztás	91 l/perc
Polírozó készülék súlya	0,75 kg
Készlet súlya	1,8 kg

kg	Ft	1	1
1,8	133.200	1	019370161

1937KL-D

tartozékok a 1937/KL polírozógéphez



Ø mm	Ft	1	1
1937KL-DLA 90	11.950	1	019370164
1937KL-DSB 90	11.950	1	019370165
1937KL-DSG 90	11.950	1	019370166

1937K...

csiszolóátányérok a 1937KC és 1937KL készülékekhez



Ø mm	1937KC	1937KL	Ft	1	1
1937KC-RP 50	•		13.150	1	019370173
1937KL-RP 75	•	•	15.800	1	019370163

1937M

Multifunkciós-csiszoló 16 tartozékkal

CE



Üresjárat fordulatszám	3.500 fordulat/perc
Motorteljesítmény	0,34 kW
Levegőcsatlakozás	1/4" GAS
Üzemi nyomás	6,2 bar
Ajánlott tömlő-Ø	10 mm
Átlagos levegőfelhasználás	113 l/min
Csiszológép súlya	1,5 kg
Szerszámkészlet súlya	4,5 kg

kg	Ft	1	1
4,5	369.200	1	019370011

458x495x116 mm

1937M-01÷11

Tartozék a 1937M modellhez



L mm	1937M-	Ft	1	1
1937M-01 30		13.750	1	019370101
1937M-02 30		13.750	1	019370102
1937M-03 11		11.950	1	019370103
1937M-04 23		11.950	1	019370104
1937M-05 11		11.950	1	019370105
1937M-06 23		11.950	1	019370106
* 1937M-07 16		33.000	1	019370107
1937M-08 13	07	11.950	1	019370108
1937M-09 26	07	11.950	1	019370109
1937M-10 11	03, 05	11.950	1	019370110
1937M-11 23	01, 02, 04, 06	11.950	1	019370111

* A megadott árak 6 darabra vonatkoznak

1937N10

Szalagcsiszológép 10 mm

CE



Üresjárat fordulatszám	20.000 fordulat/perc
Motorteljesítmény	0,37 kW
Szalagméret	10x330 mm
Levegőcsatlakozás	1/4" GAS
Üzemi nyomás	6,2 bar
Ajánlott tömlő Ø	10 mm
Átlagos levegőfelhasználás	374 l/min
Súly	0,9 kg

kg	Ft	1	1
0,9	143.700	1	019370041

1937N10-GR

Csiszolószalag a 1937N10 modellhez



P	Ft	1	1
1937N10-GR60 60	15.200	1	019370146
1937N10-GR80 80	15.200	1	019370148
1937N10-GR100 100	15.200	1	019370150
1937N10-GR120 120	15.200	1	019370152

A megadott árak 10 darabra vonatkoznak

1937N20

Szalagcsiszoló

CE



Üresjárat fordulatszám	16.000 fordulat/perc
Motorteljesítmény	0,45 kW
Szalagméret	20x520 mm
Levegőcsatlakozás	1/4" GAS
Üzemi nyomás	6,2 bar
Ajánlott tömlő Ø	10 mm
Átlagos levegőfelhasználás	400 l/min
Súly	1,6 kg

kg	Ft	1	1
1,6	167.600	1	019370051

1937N20-GR

Csiszolószalag a 1937N20 modellhez



	P	Ft		
1937N20-GR60	60	19.850	1	019370156
1937N20-GR80	80	19.850	1	019370158
1937N20-GR100	100	19.850	1	019370160
1937N20-GR120	120	19.850	1	019370162

A megadott árak 10 darabra vonatkoznak

1938

Szélvédőkivágó

• 1 egyenes 57 mm-es penge

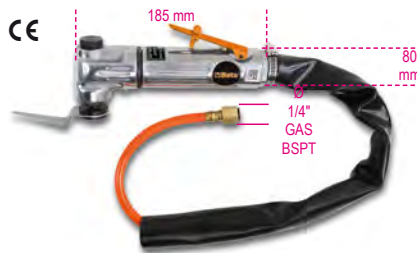

Rezgés/perc	20.000
Levegőcsatlakozás	1/4" GAS
Üzemi nyomás	6,2 bar
Ajánlott tömlő-Ø	6,5 mm
Átlagos levegőfelhasználás	200 l/min
Súly	1,0 kg

kg	Ft		
1,0	112.600	1	019380021

1938R/L

Pengék szélvédőkivágóhoz

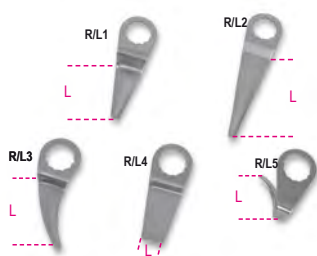

	L mm	Ft		
1938R/L1	57	9.550	1	019380041
1938R/L2	90	17.600	1	019380042
1938R/L3	30	10.700	1	019380043
1938R/L4	8	15.200	1	019380044
1938R/L5	36	17.400	1	019380045

1938R/S5

5 darabos pengekészlet a 1938-hoz

1938R/S5	Ft		
	70.500	1	019380055

1940

légkalapács

• Kalapácsrugóval és gyorsan cserélhető hatszög-tokmánnal



Ütésszám/perc	3 500
Véső csatlakozási méret	Ø 11 mm
Dugattyú méret	19 mm
Dugattyú löket	67 mm
Levegőcsatlakozás	1/4" GAS
Üzemi nyomás	6,2 bar
Ajánlott tömlő Ø	8 mm
Átlagos levegőfelhasználás	240 l/perc
Súly	1,9 kg

kg	Ft		
1,9	90.500	1	019400001

1940/C6

légkalapács 5 vésővel és kiegészítőkkal

• Fémlemezek, csapszeg és karosszéria vágására, hegesztési pontok, szegecsek, vakolat- és csempe eltávolítására alkalmas

• A praktikus ABS szerszámtáskában szállított készlet a következő elemeket tartalmazza:

- 1 légkalapács (1940)
- 1 lapos véső (1940SN)
- 1 bontó véső (1940ST)
- 1 hegyesvéső (1940SD)
- 1 hajlítot véső (1940SPS)
- 1 lemezvágó véső (1940SDT)
- 1 kalapácsrugó (1940MT)
- 1 bajonettzár hatszögű vésőszarakhoz



Ütésszám/perc	3.500
Véső csatlakozási méret	Ø 11 mm
Dugattyú méret	19 mm
Dugattyú löket	67 mm
Levegőcsatlakozás	1/4" GAS
Üzemi nyomás	6,2 bar
Ajánlott tömlő Ø	8 mm
Átlagos levegőfelhasználás	240 l/min
Súly	3,3 kg

kg	Ft		
3,3	128.300	1	019400000
320x240x90 mm			

1940MT

Tartalék kalapácsrugó az 1940 típusú pneumatikus kalapácshoz



1940MT	Ft		
	5.910	5	019400110

1940S...

Véső az 1940 modellhez



1940SN	Ft		
	7.250	5	019400020
1940ST	Ft		
	7.250	5	019400021
1940SD	Ft		
	7.250	5	019400022
1940SPS	Ft		
	7.250	5	019400023
1940SDT	Ft		
	7.250	5	019400024

1940/S5

5-részes vésőkészlet az 1940 modellhez



1940/S5	Ft		
	32.950	1	019400030

1940E10

légkalapács

• kompatibilis a 10 mm-es hatlapfejű csatlakozós vésőkkel
• kalapácsrugóval és bajonettzáras biztonsági tartóelemmel szállítva



Ütésszám/perc	2 900
Csatlakozó méret	Ø 10 mm
Dugattyú méret	19 mm
Dugattyú löket	67 mm
Véső csatlakozási méret	1/4" GAS
Üzemi nyomás	6,2 bar
Ajánlott tömlő Ø	10 mm
Átlagos levegőfelhasználás	76 l/perc
Súly	1,7 kg

kg	Ft		
1,7	99.800	1	019400010

1940E10/MT

tartórugó a 1940E10 légalapácsolóhoz



1940E10/MT	Ft	785	5	019400112
------------	----	-----	---	-----------

1940E10/S...

vésők a 1940E10 légalapácsolóhoz



1940E10/SN	Ft	5.020	5	019400040
1940E10/ST	Ft	5.020	5	019400041
1940E10/SD	Ft	5.020	5	019400042
1940E10/SPS	Ft	5.020	5	019400043
1940E10/SDT	Ft	5.020	5	019400044

1940E10/S5

5 vésőből álló sorozat a 1940E10 légalapácsolóhoz



1940E10/S5	Ft	25.100	1	019400050
------------	----	--------	---	-----------

1942A

Levegős fűrész



Löklet/perc.	10.000
Lökethosszúság	10 mm
Levegőcsatlakozás	1/4" GAS BSP
Üzemi nyomás	6,2 bar
Ajánlott tömlő-Ø	8 mm
Átlagos levegőfelhasználás	75 l/min
Súly	550 g

kg	Ft	150.600	1	019420000
----	----	---------	---	-----------

1942LR

Bimetall-fűrészlap 1942A modellhez



1942LR	Ft	3.500	5	019420032
--------	----	-------	---	-----------

1944A

axiális tűs revéltető



Percenkénti ütésszám	3.800
Dugattyú löket	33 mm
Tűszám	19
Tű Ø	3 mm
Levegőcsatlakozó	1/4" GAS
Üzemi nyomás	6,2 bar
levegőcső belső Ø	10 mm
Átlagos levegőfogyasztás	85 l/p
Súly	2,8 kg

kg	Ft	169.600	1	019440011
----	----	---------	---	-----------

1944N

tűs revéltető



Percenkénti ütésszám	3800
Dugattyú löket	33 mm
Tűszám	19
Tű Ø	3 mm
Levegőcsatlakozó	1/4" GAS
Üzemi nyomás	6,2 bar
levegőcső belső Ø	8 mm
Átlagos levegőfogyasztás	85 l/p
Súly	2,7 kg

kg	Ft	217.000	1	019440002
----	----	---------	---	-----------

1944AR

Tűs készlet az 1944A-1944N típusú revéltetőkhöz



1944AR 2	Ø mm	2	n.	29	Ft	22.250	1	019440015
1944AR 3	Ø mm	3	n.	19	Ft	17.400	1	019440005

1944PA

tűtartó talp a 1944N és 1944A készülékekhez



1944PA 2	Ø mm	2	N. Aghi	29	Ft	24.500	1	019440016
1944PA 3	Ø mm	3	N. Aghi	19	Ft	18.600	1	019440006

1945S

tűzőgép

• Használt tűzőkapocs típus 80, keresztmetszet 0,95 x 0,65 mm (21 Gauge), hosszúság 4 - 16 mm, szélesség 12,8 mm



Tárkapacitás	157 db.
Levegőcsatlakozó	1/4" GÁZ
Üzemi nyomás	4,2 - 7 bar
levegőcső belső Ø	8 mm
Levegőfogyasztás (7 bar)	0,34 l/ciklus
Súly	0,87 kg

kg	Ft	92.100	1	019450000
----	----	--------	---	-----------

1945S/G...

tűzőkapocs, 80-as típus, 0,95x0,65 mm (21 vastag), szélesség 12,8 mm, 1945S modellhez



1945S/G 4	L mm	4	Ft	8.580	1	019450004
1945S/G 6	L mm	6	Ft	3.380	1	019450006
1945S/G 8	L mm	8	Ft	3.640	1	019450008
1945S/G 10	L mm	10	Ft	4.090	1	019450010
1945S/G 12	L mm	12	Ft	4.570	1	019450012
1945S/G 14	L mm	14	Ft	4.940	1	019450014
1945S/G 16	L mm	16	Ft	5.430	1	019450016

Az árak 5 000 darabra vonatkoznak
• Az árak 10 000 darabra vonatkoznak

Beta

1945P

tűzőgép

- Használt tű típus B6, Ø 0,64 mm (23 Gauge), hosszúság 12 - 35 mm



Tárkapacitás 145 db.
Levegőcsatlakozó 1/4" GÁZ
Üzemi nyomás 4 - 7 bar
Levegőcső belső Ø 8 mm
Levegőfogyasztás (7 bar) 0,27 l/ciklus
Súly 0,87 kg

kg 0,87 Ft 147.400 1 019450100

1945P/S...

tű, B6 típus, Ø 0,64 mm (23 Gauge), a 1945P modellhez

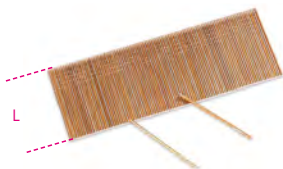

	L mm	Ft		
1945P/S 12	12	4.010	1	019450112
1945P/S 15	15	4.370	1	019450115
1945P/S 18	18	4.780	1	019450118
1945P/S 20	20	5.510	1	019450120
1945P/S 21	21	5.630	1	019450121
1945P/S 22	22	5.790	1	019450122
1945P/S 25	25	6.190	1	019450125
1945P/S 30	30	7.090	1	019450130
1945P/S 35	35	8.060	1	019450135

Az árak 10 000 darabra vonatkoznak.

1946

Levegős popszegecshúzó

- Cserélhető 2,4-3,2-4,0-4,8 mm-es betéttel, szöggyűjtővel és egyensúlyozó szemmel szállítva!



Húzóerő 8000 N
Lökethosszúság 14 mm
Max. szegecs Ø aluminium Ø 4,8 mm
Levegőcsatlakozás 1/4" GAS
Üzemi nyomás 6,2 bar
Ajánlott tömlő Ø 6 mm
Átlagos levegőfelhasználás 1,2 l/ciklus
Súly 1,5 kg

kg 1,5 Ft 91.700 1 019460001

1946C4,8

szegecshúzó

- Automatikus beszívással
- Összeszerelve szállítjuk 2,4 - 3,2 - 4,0 - 4,8 mm méretű acél, rozsdamentes acél, alumínium és réz szegecsekhez



Húzóerő 8.900 N
Lökethossz 15 mm
Legnagyobb szegecsméret Ø rozsdamentes acél 4,8 mm
Levegőcsatlakozó 1/4" GÁZ
Üzemi nyomás 6,2 bar
Levegőcső belső Ø 10 mm
Levegő fogyasztás 2,6 l/ciklus
Súly 1,5 kg

kg 1,5 Ft 285.800 1 019460006

1946C7,8

szegecshúzó

- Automatikus beszívással
- Összeszerelve szállítjuk 4,8 - 5,6 - 6,4 - 7,8 mm méretű acél, rozsdamentes acél, alumínium és réz szegecsekhez



Húzóerő 16.900 N
Lökethossz 22,5 mm
Legnagyobb szegecsméret Ø rozsdamentes acél 7,8 mm
Levegőcsatlakozó 1/4" GÁZ
Üzemi nyomás 6,2 bar
Levegőcső belső Ø 10 mm
Levegőfogyasztás 4,9 l/ciklus
Súly 1,8 kg

kg 1,8 Ft 450.600 1 019460008

1946C/T...

fejek a szerkezeti szegecsekhez



	Ø mm	Ft		
1946C/T4,8	4,8	17.400	1	019460016
1946C/T6,4	6,4	17.400	1	019460018

1946KF

Rozsdamentes acél Ø M8

- Felhasználható szegecsanyagok: acél, nemesacél, alumínium és réz, M4, M5, M6, M8



Húzóerő 14.235 N
Lökethossz 7 mm
Max. szegecs Ø Nemesacél Ø M8
Levegőcsatlakozás 1/4" GAS
Üzemi nyomás 6,2 bar
Ajánlott tömlő-Ø 10 mm
Átlagos levegőfelhasználás 2,1 l/löket
Szegecsanyagrapantó súlya 2,1 kg
Készlet súlya 3,4 kg

kg 3,4 Ft 949.400 1 019460012



1946KF/M...

Tartalékstiftkek a 1946KFmodellhez



	Ft		
1946KF/M4	31.800	1	019460124
1946KF/M5	31.800	1	019460125
1946KF/M6	31.800	1	019460126
1946KF/M8	30.550	1	019460128

1947

KIT-kinyomó

- Kit-kinyomópisztoly szilikon, ragasztó és közepes sűrűségű tömítőanyaghoz
- Szabvány (210 x 50 mm) merev és lágy patronokkal használható



Patron méret	210x50 mm
Patron űrtartalom	350 ml
Levegőcsatlakozás	1/4" GAS
Üzemi nyomás	4,8 bar
Ajánlott tömlő Ø	10 mm
Átlagos levegőfelhasználás	120 l/perc
Súly	1,1 kg

kg	Ft		
1,1	32.000	1	019470001

1947H

tömítőanyag pisztoly

- Szabvány műanyag vagy fémpatronos szilikon és tömítőanyag kinyomó pneumatikus pisztoly
- Szabvány (215/218 x 50/51 mm) merev és lágy patronokkal használható
- Integrált nyomáscsökkentővel



Patron méret	210x50 mm
Patron űrtartalom	300/310 ml
Levegőcsatlakozás	1/4" GAS
Üzemi nyomás	4 ÷ 8 bar
Ajánlott tömlő Ø	2,5 mm
Átlagos levegőfelhasználás	120 l/perc
Súly	750 g

g	Ft		
750	111.700	1	019470011

1947G

zsírzópisztoly

fröccsöntött alumínium fej
ergonomikus markolat sarkos kiképzéssel, hogy szűk térben is alkalmazható legyen
hosszú élettartamú sárgaréz szelep
400 g betétekkel vagy 500 cm³ folyékony zsírral működik
a cső méretei: 54 (belső) x 260 mm
levegőcsatlakozó: 1/4" GAS
üzemi nyomás: 4 ÷ 10 bár
súly: 1.9 kg



g	Ft		
1900	78.750	1	019470051

1947G2

2 az 1-ben zsírzópisztoly

Folyamatos és szakaszos zsírzáshoz
Fröccsöntött alumínium fej
Ergonomikus markolat
400 g patronokkal vagy max. 500 cm³ folyékony zsírral működik



A cső méretei	54 (belső) x 276 mm
Levegőcsatlakozás	1/4" GAS BSP
Üzemi nyomás	3÷10 bar
Súly	2,2 kg

g	Ft		
1900	80.950	1	019470060



1948

gravírozó

- Acél, rozsdamentes acél, alumínium, üveg, kő és kerámia gravírozására



Ütésszám/perc	3 500 ÷ 3 800
Max. keménység	60 HRC
Levegőcsatlakozás	1/4" GAS
Üzemi nyomás	6,2 bar
Átlagos levegőfelhasználás	50 l/perc
Súly	150 g

g	Ft		
150	147.800	1	019480001

1948PR

Tartalék-wolframkarbidhegy a 1948 modellhez

- Max. keménység: 60 HRC



g	Ft		
150	55.850	1	019480005

1949XS

Lefúvató pisztoly

- Könnyűfémötvezetből
- A légmenyiség a fej elfordításával szabályozható



Légi támadás	1/4"
Üzemi nyomás	3-8 bar
Maximális üzemi nyomás	10 bar
Üzemeltetési hőmérséklet	-20 °C ÷ +70 T38°C
Súly	20 g

g	Ft		
20	3.180	25	019490025

1949U5

lefúvató pisztoly 5 fúvókával

- Csúcsmínőségű, ütésálló üvegszálas anyagból
- 3 acél fúvóka, 100/160/320 mm, karcálló, gumi védősapkával
- 1 "Turbo" fúvóka üvegszállal erősített műanyagból, biztonsági sapkával
- 1 forgatható fúvóka, 100 mm, üvegszállal erősített műanyagból
- Gyorscsatlakozó rendszer



Ø 1/4" GAS BSPT

Menetes réz betét
Üzemi nyomás
Maximális üzemi nyomás
Átlagos levegőfelhasználás
Üzemi hőmérséklet
Súly

1/4" GAS
10 bar
15 bar
280 l/perc
-10°C ÷ 85°C
93 g

g 93 Ft 17.600 1 019490030

1949U5/A

acél fúvóka, 100 mm, karcálló védő gumisapkával a 1949U5 - 1949P modellhez



1949U5/A Ft 3.560 1 019490131

1949U5/B

acél fúvóka, 160 mm, karcálló védő gumisapkával a 1949U5 - 1949P modellhez



1949U5/B Ft 3.600 1 019490132

1949U5/C

acél fúvóka, 320 mm, karcálló védő gumisapkával a 1949U5 - 1949P modellhez



1949U5/C Ft 4.620 1 019490133

1949U5/D

forgatható fúvóka, 100 mm, üvegszállal megerősített műanyag, a 1949U5 - 1949P modellhez



1949U5/D Ft 3.380 1 019490134

1949U5/E

„Turbo” fúvóka üvegszállal erősített műanyagból, biztonsági sapkával



1949U5/E Ft 1.680 1 019490135

1949U5/F

lapos, legyező formájú fúvóka üvegszállal erősített műanyagból az 1949U5 és 1949P modellhez



1949U5/F Ft 2.150 1 019490136

1949U5/G

OSHA fúvóka üvegszállal erősített műanyagból az 1949U5 és 1949P modellhez



1949U5/G Ft 1.600 1 019490137

1949BC

Lefúvató pisztoly gumifúvókával

- Ütésálló plattírozott ház
- Karcmentes cserélhető gumifúvóka

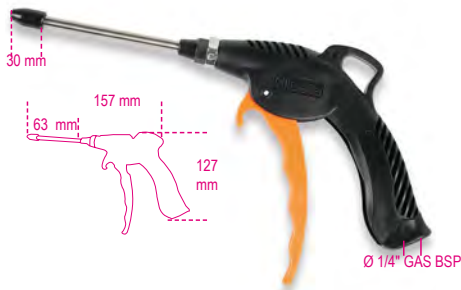

Alumíniumbetét, belső menet
Üzemi nyomás
Max. üzemi nyomás
Átlagos levegőfelhasználás
Üzemi hőmérséklet
Súly

1/4" GAS
6-8 bar
15 bar
87 l/min
-20°C ÷ 70°C
120 g

g 120 Ft 8.620 1 019490022

1949BC/RUL

5 darab hosszú gumi fúvóka az 1949BC modellhez



1949BC/RUL Ft 10.700 1 019490123

1949P

kis méretű lefúvató pisztoly

- Kopásálló, ütésálló kompozit anyagból
- Fúvóka gyorsrögzítő rendszer
- Gyűrűsanyával állítható levegőmennyiség



Sárgaréz betét
Üzemi nyomás
Maximális üzemi nyomás
Átlagos levegőfelhasználás
Üzemi hőmérséklet
Súly

1/4" GAS
6-8 bar
15 bar
280 l/perc
-10 °C ÷ 85 °C
70 g

g 70 Ft 11.350 1 019490031

1949T

Teleszkópos lefúvatópisztoly, progresszíven szabályozható fúvóhatás

- Markolat ütésálló kompozit anyagból
- Elfördíthető acél teleszkópos cső: 165 mm ÷ 300 mm

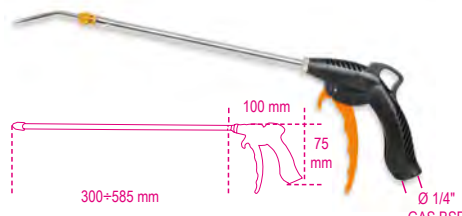

Alumíniumbetét, belső menet
Üzemi nyomás
Max. üzemi nyomás
Átlagos levegőfelhasználás
Üzemi hőmérséklet
Súly

1/4" GAS
6-8 bar
15 bar
144 l/min
-20°C ÷ 70°C
190 g

g 190 Ft 13.750 1 019490040



1949F2

lefúvató pisztoly

- Csúcsmínőségű, ütészálló és karcmentes, hőszigetelt üvegszálas anyagból
- A speciálisan kialakított szelep és kar lehetővé teszi a levegőmennyiség optimális, folyamatos szabályozását
- Műanyag védőkupak biztosítja a használaton kívüli védelmet



Sárgaréz betét	1/4" GAS
Üzemi nyomás	4-8 bar
Maximális üzemi nyomás	12 bar
Üzemeltetési hőmérséklet	-20°C ÷ 70°C
Súly	125 g

g	Ft	1	019490028
125	8.020		

1949GPA

tömítőfúvató

- ütészálló gumi burkolatú test
- fém billentyű
- üzemi nyomás: 0,5÷12 bar (7÷174 psi)
- nyomásleeresztő gomb
- nyomásmérő
- tömlő hossz: 58 cm
- 360°-ban elforduló tömlő
- 1/4" levegőcsatlakozó



bar	psi	Ft	1	019490018
0,5÷12	7÷174	51.200		

1949DGT/2

digitális tömlőfúvató

- ütészálló gumi burkolatú test
- fém billentyű
- üzemi nyomás: 0,5÷12 bar (7÷174 psi)
- 4 mértékegység: bar/psi/kpa/kgf
- háttérvilágítású LCD kijelző
- pontosság: 0,05 bar
- önkikapcsolás 1,5 perc után
- tömlő hossz: 58 cm
- 360°-ban elforduló tömlő
- tápellátás: 2 AAA elem
- 1/4" levegőcsatlakozó



bar	psi	Ft	1	019490021
0,5÷12	7÷174	61.350		

1949M

nyomásmérő gumiabroncsokhoz



bar	psi	g	Ft	1	019490400
0÷4	5÷60	280	35.800		

1949R

lefúvató pisztoly gépjármű radiátorok tisztításhoz

a markolatla merőleges 5 lyuk lehetővé teszi a szennyeződés hatékony eltávolítását a hűtőról



L	mm	Ft	1	019490050
600	6	32.400		

1950BZK

abroncsszerelő légágyú

- a nyomógombos másodlagos markolattal a szerszám használat közben stabilan tartható
- tartály úrtartalom: 18 l
- üzemi nyomás: 3-8 bar
- tartály maximum nyomás: 16 bar
- nyomásmentesítő szelep
- skálázott mérő
- a műanyag bemenet megakadályozza a perem sérülését



L	Ø	Ft	1	019500078
440	290	148.200		

1950BZK/T

Teherautó abroncsszerelő légágyú

A Beta abroncsszerelő légágyúja a nyomógombos másodlagos markolatnak köszönhetően használat közben stabilan és biztonságosan tartható.



- Jellemzők
- Tartálykapacitás: 36 l
 - Üzemi nyomás: 3-8 bar
 - Tartály maximum nyomás: 16 bar
 - Nyomásmentesítő szelep
 - Skálázott mérő
 - A műanyag bemenet megakadályozza a perem sérülését

L	Ø	Ft	1	019500080
560	290	185.000		

1950GPP

Automatikusan és manuálisan feltölthető, hordozható tömlőfúvató levegőpisztollyal

Javitóműhelyek és töltőállomások elengedhetetlen kelléke, mely a kettős beosztású (bar/psi) nyomásmérővel szerelt levegőpisztollyal alkalmas a keréknyomás ellenőrzésére és helyreállítására.

A berendezés automatikusan (fali csatlakozóról) és manuálisan (töltőselepről) egyaránt tölthető



CE

Műszaki adatok:

- Tartálykapacitás: 10 l
- Max. tartálynyomás: 16 bar (232 psi)
- Tartály nyomásmérő, Ø 50 mm: 0÷16 bar (232 psi)
- Üzemi nyomásmérő: 0÷16 bar (232 psi)
- Tömlő hossz: 1550 mm
- Őnsúly: 9,3 kg

H	Ø	bar	l	Ft	g	1	019500050
700	300	0÷16	10	124.700	9300	1	019500050

1951

mosópisztoly

- autókárpit, szőnyegpadló, ülés és csomagtartó tisztításhoz ajánlott



CE

Szabad fordulatszám

Tartály térfogat	1 L
Levegőcsatlakozó	1/4" GAS
Üzemi nyomás	6,2 bar
Levegő cső belső Ø	8 mm
Átlagos levegőfogyasztás	110 l/min
Súly	650 g

g	Ft	g	1	019510051
650	69.450	650	1	019510051

1951A

mosópisztoly

- Autókárpit, szőnyegpadló, ülés és csomagtartó tisztításhoz ajánlott
- Megfelelő mosószerrel használható
- 1 literes tartály
- A tartályban tárolt folyadék kiáramlását szabályozó csappal rendelkeznek
- 1,8 m hosszú bordáscsővel szállítva



Tartálykapacitás

Levegőcsatlakozás

Üzemi nyomás

Belső tömlőátmérő (Ø)

Átlagos levegőfelhasználás

Súly

1 l

1/4" GAS

6,2 bar

8 mm

120 l/perc

800 g

g	Ft	g	1	019510101
800	112.600	800	1	019510101

1952

professzionális festékszóró pisztoly

- Öntött alumínium test, fekete, kémiai nikkel bevonattal
- Műanyag tartály cseppfogóval, 3/8" BSP menet
- Csatlakozó: 1/4" BSP hengeres gázmenet
- Nyomás- és levegőszabályozó
- Szabályozható fúvóka a kerek és szórt szóráskep között állítható
- Festék mennyiség szabályozó
- Karbantartáshoz szükséges szervizkulccsal szállítva



Ø	Ft	g	1	019520012
1,2	74.300	650	1	019520012
1,5	74.300	650	1	019520015
1,8	74.300	650	1	019520018
2,0	74.300	650	1	019520020

1900S

automatikus rugós tömlődob
ütésálló műanyag test,
levegőhöz és vízhez

- max. üzemi nyomás: 15 bar
- fonott poliuretán tömlő
- polipropilén ház
- a tömlőt a kívánt hosszban rögzítő szerkezet
- a reteszelő mechanizmus kikapcsolható, így a tömlő folyamatos visszahúzását teszi lehetővé
- üzemi hőmérséklet tartomány: -5 °C / +50 °C
- 180°-os elforgatható konzollal és kiegészítő gyorscsatlakozó konzollal szállítva

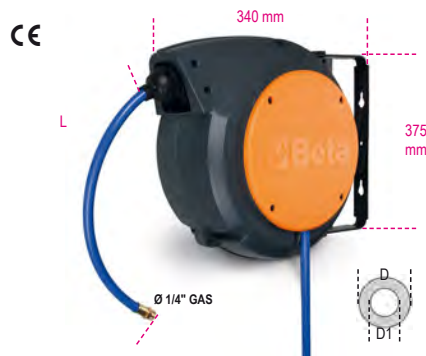

CE

D1xD	L	Ø GAS	Ft	g	1	019000080
1900S 8X10	8x12	10 1/4"	79.150	8000	1	019000080

1900M

automatikus rugós tömlődob
ütésálló műanyag test,
levegőhöz és vízhez

- max. üzemi nyomás: 15 bar
- fonott poliuretán tömlő
- polipropilén ház
- a tömlőt a kívánt hosszban rögzítő szerkezet
- a reteszelő mechanizmus kikapcsolható, így a tömlő folyamatos visszahúzását teszi lehetővé
- üzemi hőmérséklet tartomány: -5 °C / +50 °C
- 180°-os elforgatható konzollal és kiegészítő gyorscsatlakozó konzollal szállítva



CE

D1xD	L	Ø GAS	Ft	g	1	019000085
1900M8X15	8x12	15 1/4"	108.100	8000	1	019000085
1900M10X15	10x14	15 3/8"	112.600	8000	1	019000115
1900M12X15	12x16	15 1/2"	147.000	8000	1	019000125

1914

98 Shore kihúzható poliuretán spiráltömlő

• Legnagyobb üzemi nyomás 12 bar

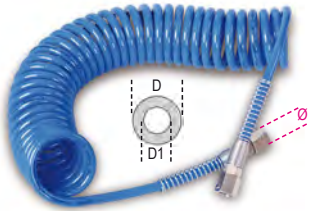

L	DxD1	Ø GAS	Ft		
m	mm	BSP			
4	5x8	1/4"	11.750	1	019140054
6	5x8	1/4"	13.750	1	019140056
10	5x8	1/4"	17.600	1	019140060

1915B

95 Shore poliuretán spiráltömlő
9 méterre kihúzható

• Legnagyobb üzemi nyomás 10 bar

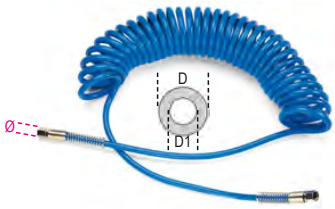

D1xD	Ø GAS	Ft		
mm	BSP			
6,5x10	1/4"	20.250	1	019150011
8x12	1/4"	24.300	1	019150012

1915C

95 Shore poliuretán spiráltömlő
12 m-ig kihúzható

• Legnagyobb üzemi nyomás 10 bar



D1xD	Ø GAS	Ft		
mm	BSP			
6,5x10	1/4"	24.300	1	019150014
8x12	1/4"	29.750	1	019150015

1915C/L

95 Shore poliuretán spiráltömlő
15 m-ig kihúzható

• Legnagyobb üzemi nyomás 10 bar



D1xD	Ø GAS	Ft		
mm	BSP			
8x12	1/4"	38.250	1	019150115

1915D

95 Shore huzalhálós poliuretán cső
hosszúság 9 m

• Legnagyobb üzemi nyomás 15 bar



D1xD	Ø GAS	Ft		
mm	BSP			
8x12	1/4"	24.300	1	019150017

1915E

95 Shore huzalhálós poliuretán cső
hosszúság 12 m

• Legnagyobb üzemi nyomás 15 bar

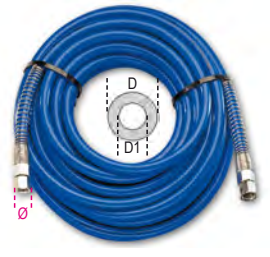

D1xD	Ø GAS	Ft		
mm	BSP			
8x12	1/4"	32.000	1	019150019
11x16	3/8"	47.950	1	019150020

1915E/XL

95 Shore huzalhálós poliuretán cső tekercs
hosszúság 50 m

• Legnagyobb üzemi nyomás 15 bar



D1xD	Ø GAS	Ft		
mm	BSP			
8x12	1/4"	110.100	1	019150519
11x16	3/8"	184.200	1	019150520

1916I

Gyorscsatlakozó, olasz modell
külső GAS menet, hengeres, BSP



Ø GAS	Ft		
BSP			
1/4"	1.400	5	019160001
3/8"	1.580	5	019160002

1916G

Gyorscsatlakozó, európai modell
külső GAS menet, hengeres, BSPT



Ø GAS	Ft		
BSPT			
1/4"	1.400	5	019160005
3/8"	1.840	5	019160010
1/2"	2.040	5	019160012

1916GF

gyorscsatlakozó, olasz modell
belső GAS menet, hengeres BSP



Ø GAS	Ft		
BSP			
1/4"	1.400	5	019160055
3/8"	1.580	5	019160060

1916GFE

gyorscsatlakozó, európai modell
belső GAS menet, hengeres BSPT



Ø GAS	Ft		
BSPT			
1/4"	1.400	5	019160075
3/8"	1.840	5	019160082
1/2"	2.040	5	019160084

1916JM

gyorscsatlakozó, ázsiai modell
külső GAS menet, hengeres BSPT



Ø GAS	Ft		
BSPT			
1/4"	1.960	1	019160406
3/8"	2.040	1	019160410

1916JF

gyorscsatlakozó, ázsiai modell
belső GAS menet, hengeres BSP



Ø GAS	Ft		
BSPT			
1/4"	1.960	1	019160456
3/8"	2.040	1	019160460

1917M

Univerzális golyörögztésű gyorscsatlakozó hüvely

ütésálló gumival

külső GAS menet, hengeres, BSP

• Csatlakoztatható a 1916I és a 1916G modellhez



Ø GAS BSP	Ft	📦	📄
1/4"	5.020	5	019170001
3/8"	5.020	5	019170003
1/2"	5.380	5	019170004

1917F

univerzális golyörögztésű gyorscsatlakozó hüvely, ütésálló gumival

belső GAS menet, hengeres BSP

• csatlakoztatható a 1916I és 1916G gyorscsatlakozókhoz



Ø GAS BSP	Ft	📦	📄
1/4"	5.220	5	019170005
3/8"	5.020	5	019170010
1/2"	5.590	5	019170014

1917JM

univerzális golyörögztésű gyorscsatlakozó hüvely ázsiai modellekhez

külső GAS menet, hengeres BSP



Ø GAS BSP	Ft	📦	📄
1/4"	8.380	1	019170406
3/8"	8.380	1	019170410
1/2"	8.990	1	019170412

1917JF

golyörögztésű gyorscsatlakozó hüvely ázsiai modellekhez

belső GAS menet, hengeres BSP



Ø GAS BSP	Ft	📦	📄
1/4"	8.380	1	019170456
3/8"	8.380	1	019170460

1917RG

forgatható univerzális gyorscsatlakozó hüvely

- Alumínium, belső GAS menet, hengeres BSP, külső menet, hengeres BSP
- Az összes olasz és európai csatlakozó modellhez csatlakoztatható
- Csatlakoztatott levegő nélkül is szabad elforgatás



Ø GAS BSP	Ft	📦	📄
1/4"	10.950	1	019170252

1917SP

univerzális golyörögztésű gyorscsatlakozó gumitömítőhöz való hüvellyel



D1xD mm	Ft	📦	📄
6x14	5.380	5	019170206
8x17	5.630	5	019170208
10x19	6.400	5	019170210

1918

külső menetes tömlőcsatlakozó



D1 mm	Ø GAS BSP	Ft	📦	📄
8	1/4"	1.300	3	019180118
10	1/4"	1.300	3	019180120
10	3/8"	1.480	3	019180130
12	3/8"	1.520	3	019180132
10	1/2"	2.000	3	019180140
12	1/2"	2.040	3	019180142

1918N

menetes adapter (BSPT)



Ø GAS 1/4"	Ø1 GAS 1/4"	Ft	📦	📄
		1.300	5	019180300

1918R

menetes adapter (BSPT)



Ø GAS 1/4"	Ø1 GAS 3/8"	Ft	📦	📄
		1.480	5	019180200
		2.000	5	019180210

Beta

1919FE1/4

Levegőelőkészítő



Levegőcsatlakozás/kimenet 1/4" GAS BSPT
 Manométermenet 1/8" GAS BSPT
 Max. átfolyás 750 l/min
 Max. üzemi nyomás 9,5 bar
 Üzemi nyomás 0,5 - 8,5 bar
 Üzemi hőmérséklet 5 - 60 °C
 Szűrési finomság 5 micron
 Tartály úrtartalma 15 cl levegő / 25 cl olaj
 Súly 700 g

g	Ft	📦	📄
700	50.600	1	019190200

1919RB-FE1/4

1 pár tartalék tartály a 1919FE1/4"-hoz



1919RB-FE1/4	Ft	📦	📄
	10.950	1	019190210

1919RF-FE1/4

Tartalék szűrőbetét az 1919FE1/4 típusú levegőelőkészítőhöz



1919RF-FE1/4	Ft	📦	📄
	2.980	1	019190230

1919RM-FE1/4

Tartalékmanométer az 1919FE1/4 típusú levegőelőkészítőhöz



1919RM-FE Ft 6.440 1 019190220

1919F1/4

Levegőelőkészítő



Levegőcsatlakozás/kimenet 1/4" GAS BSPT
 Max. áteresztés 1000 l/perc
 Max. üzemi nyomás 9,5 bar
 Üzemi nyomás 0,5 - 8,5 bar
 Üzemi hőmérséklet 5 - 60 °C
 Szűrési finomság 5 µm
 Tartály úrtartalma 60 cl levegő / 90 cl olaj
 Súly 1,3 kg

kg 1,3 Ft 79.550 1 019190250

1919F3/8

Levegőelőkészítő



Levegőcsatlakozás/kimenet 3/8" GAS BSPT
 Max. áteresztés 1350 l/perc
 Max. üzemi nyomás 9,5 bar
 Max. üzemi nyomás 0,5 - 8,5 bar
 Üzemi hőmérséklet 5 - 60 °C
 Szűrési finomság 5 µm
 Tartály úrtartalma 60 cl levegő / 90 cl olaj
 Súly 1,3 kg

kg 1,3 Ft 79.550 1 019190350

1919F1/2

Levegőelőkészítő



Levegőcsatlakozás/kimenet 1/2" GAS BSPT
 Max. áteresztés 2500 l/perc
 Max. üzemi nyomás 9,5 bar
 Max. üzemi nyomás 0,5 - 8,5 bar
 Üzemi hőmérséklet 5 - 60 °C
 Szűrési finomság 5 µm
 Tartály úrtartalma 60 cl levegő / 90 cl olaj
 Súly 1,3 kg

kg 1,3 Ft 79.550 1 019190450

1919RB-F

1 pár tartalék tartály az 1919F - 1/4", 3/8", 1/2" típusú levegőelőkészítőhöz



1919RB-F Ft 13.950 5 019190510

1919RF-F

Tartalék szűrőbetét az 1919F - 1/4", 3/8", 1/2" típusú levegőelőkészítőhöz



1919RF-F Ft 5.590 1 019190530

1919RM-F

Tartalék manométer az 1919F - 1/4", 3/8", 1/2" típusú levegőelőkészítőhöz



1919RM-F Ft 8.340 1 019190520

1919ML

Mini olajozó



Ø mm	L mm	Ø mm	Ft	1	019190030
1/4"	63	36	10.300	1	019190030
3/8"	63	36	11.150	1	019190032

1919SC

Mini nedvesség leválasztó



Ø mm	L mm	Ø mm	Ft	1	019190035
1/4"	80	40	13.150	1	019190035

1919L

ISO 32 kenőolaj

Sűrűség (20°C) 875 Kg/m3
 Viskozitás (40°C) 32 cSt
 Lobbanáspont COC 210°C



cc 500 Ft 8.990 5 019190050





SZERSZÁMTÁROLÓK ÉS KÉSZLETEK



KÉSZLETEK KISEBB TÁSKÁKHOZ ÉS BŐRÖNDÖKHOZ

KÉSZLETEK KÉZIKOCSIKHOZ

	darab	2009N/BV	2028/WV	2029/WV	2032/TV	2033L/WV	2036/TV	C5 C6T C9MT	C7	C8	C10	C9 C10S C11 CP15L	C16 CP17 CP17L	C12	C14	CP15	C18	C19 C19L	C20	C20L	C41S	C41H	C42H	
		5914VU/M	Általános karbantartáshoz	109													509							
5915VU/0	Általános karbantartáshoz	35						511																
5915VU/1	Általános karbantartáshoz	45							511	511	511	511				511	511							
5915VU/2	Általános karbantartáshoz	49						512								512			512	512				
5915VU/3	Általános karbantartáshoz	74						512		512	512	512						512	512	512				
5915VU/4	Általános karbantartáshoz	80																	513	513				
5915VU/5	Általános karbantartáshoz	111												513								513	513	513
5915VU/AS	Általános karbantartáshoz	68									514								514	514				
5940SBK	Motorkerékpárok és kerékpárok javítása	125																				539	539	539
5941VU/M	Általános karbantartáshoz	64																					540	
5980EL/A	Elektronikai	57	525		525	525																		
5980EL/B	Elektronikai	98		526		526	526																	
5980ET/A	Elektrotechnikai	70	523		523									523										
5980ET/B	Elektrotechnikai	64		524		524	524							524										
5980ID/1	Víz- és gázszerelő	24	527					527																
5980MQ	Elektrotechnikai	46		524																				
5980U/BIKE	Motorkerékpárok és kerékpárok javítása	90											517							517				

FUNKCIONALITÁS

STRAPABÍRÁS

TARTÓSSÁG

TECHNIKAI ANYAGBÓL KÉSZÜLT SZERSZÁMTÁSKÁK ÉS HÁTIZSÁKOK

Ez a három fogalom a Beta szövetből készült tárolóeszközeinek három sarokköve. A Beta szerszámtáskái és hátizsákjai strapabíró technikai anyagból készülnek, egyaránt ellenállnak a kopásnak és elhasználódásnak, varratai és alja megerősítettek, ami megbízhatóságot és tartósságot eredményez. Minden tárolóeszköz különleges jellemzőkkel rendelkezik, a tárolókat különböző felhasználásokra és a rendelkezésre álló hely optimális kihasználására tervezték: a cipzáras zsebek, a teleszkópos fogantyúk, a kerékvédők, a megerősített vállpántok és átlátszó dokumentumtárolók az egyes táskák és hátizsákok számos sajátosságai közül csak néhányat képviselnek. A gondos odafigyelés a részletekre és a sokféleségre, valamint a szerszámok teljesen biztonságos szállításának fokozott figyelembevétele biztosítja, hogy ezek a termékek minden munkahelyi helyzetben ideális megoldást jelentsenek.



POLIPROPILÉN SZERSZÁMOS LÁDÁK

A Beta a szerszámos ládák széles választékát kínálja, hogy bármilyen igénynek megfeleljen!

A Beta szerszámos ládái és szerszámkocsijai erős, vastag, ütésálló, korrózióálló polipropilénből készülnek, amely ellenáll a nagy igénybevételnek – pl. alacsony hőmérsékletnek.

Válassza ki azt a terméket, amely a legjobban megfelel az Ön munkája szerinti igénynek: klasszikus szerszámkocsi, kerek kocsi egyszerű szállításhoz, TSA zárral ellátott változatok a teljesen szabad utazáshoz, végül az alumínium vagy vízzáró változatok.

A Beta legtöbb szerszámos ládája és szerszámkocsija a különböző munkák igényeinek és alkalmazási területeinek megfelelően válogatott szerszámkészletekkel is kaphatók, legyen az elektronika, hidraulika, hajózás vagy karbantartás.



2001/B26

26 darabos szerszámkészlet textiltokban



2001/B26 Ft 110.000 1 020010215

	n.	
55	6x7 - 8x9 - 10x11 - 12x13 - 14x15 - 16x17 mm	6
96N/SC9	1,5 - 2 - 2,5 - 3 - 4 - 5 - 6 - 8 - 10 mm	9
1044N	250 mm	1
1128BMX	147 mm	1
1150	180 mm	1
1201E	3x75 - 4x100 - 5,5x150 mm	3
1202E	PH1x80 - PH2x100 mm	2
1370	300 g	1
1692	2 m	1
1770A	9 mm	1

2001/BV Ft 25.100 1 020010051

2001/BZV

szerszámtáska tartós hi-tech szövetből

- Dupla felső pánt az optimális fogáshoz
- Elülső cipzáras dokumentumtároló zseb
- A hátoldalon elhelyezett tépőzáras pánttal a táska a kocsifogantyújára rögzíthető
- 20 kényelmes szerszámosrekesz (6 zseb és 14 gumipánt)
- Kalapáccstartó fülek
- C9/RT vállszíjjal is kapható (külön kell megrendelni)



2001/BZV Ft 22.850 1 020010151

380x290x60 mm - 890 g



2001/BZ24 MQ

összehajtható táska 24 darabos szerszámkészlettel villanszereléshez



2001/BZ24 MQ Ft 158.300 1 020010154

		n.
1128BMX	147 mm	1
1150MQ	180 mm	1
42	8-10-13-17-19 mm	5
1274MQ	3x100 - 4x100 - 5,5x125 mm	3
1272MQ	PH0x60 - PH1x80 - PH2x100 mm	3
96BP/SC9	1,5-2-2,5-3-4-5-6-8-10 mm	9
1253		1
1082MQ	160 mm	1
☞ 380x290x60 mm		

2001/BZ27 VU

összehajtható táska 27 darabos szerszámkészlettel univerzális alkalmazásra



2001/BZ27 VU Ft 130.500 1 020010157

		n.
1128BMX	147 mm	1
1150	180 mm	1
42	7-8-10-13-17-19 mm	6
1201E	3x75 - 4x100 - 5,5x150 mm	3
1202E	PH0x60 - PH1x80 - PH2x100 mm	3
96/SC9	1,5-2-2,5-3-4-5-6-8-10 mm	9
1370	300 g	1
1048N	250 mm	1
1692/5	5 m	1
1771	18 mm	1
☞ 380x290x60 mm		

2002/BV6

tartós poliészterből készült összetekkerhető szerszámtok, üres

- 6 különböző méretű praktikus szerszámtartó zseb
- A megerősített anyagból készült fülnek köszönhetően könnyen szállítható
- A belső hajtóka megakadályozza, hogy a szerszámok kiessenek
- Körben mindenhol megerősített varrás
- Kettős tépőzár



2002/BV6 Ft 4.050 1 020020000

☞ 175x240 mm - 83 g

2002/BVL6

tartós poliészterből készült összetekkerhető szerszámtok, üres

- 6 különböző méretű praktikus szerszámtartó zseb
- A megerősített anyagból készült fülnek köszönhetően könnyen szállítható
- A belső hajtóka megakadályozza, hogy a szerszámok kiessenek
- Körben mindenhol megerősített varrás
- Kettős tépőzár



2002/BVL6 Ft 5.180 1 020020010

☞ 220x290 mm - 120 g

2002/BV7-ZIP

tartós poliészterből készült összetekkerhető szerszámtok, üres

- 7 különböző méretű praktikus szerszámtartó zseb és kis cipzáros szerszámtartó zseb
- A megerősített anyagból készült fülnek köszönhetően könnyen szállítható
- A belső hajtóka megakadályozza, hogy a szerszámok kiessenek
- Körben mindenhol megerősített varrás
- Kettős tépőzár



2002/BV7-ZIP Ft 9.270 1 020020060

☞ 335x220 mm - 135 g

2002/BV8

tartós poliészterből készült összetekkerhető szerszámtok, üres

- 8 különböző méretű praktikus szerszámtartó zseb
- A megerősített anyagból készült fülnek köszönhetően könnyen szállítható
- A belső hajtóka megakadályozza, hogy a szerszámok kiessenek
- Körben mindenhol megerősített varrás
- Kettős tépőzár



2002/BV8 Ft 5.180 1 020020020

☞ 395x360 mm - 225 g

2002/BV9

tartós poliészterből készült összetekkerhető szerszámtok, üres

- 9 különböző méretű praktikus szerszámtartó zseb
- A megerősített anyagból készült fülnek köszönhetően könnyen szállítható
- A belső hajtóka megakadályozza, hogy a szerszámok kiessenek
- Körben mindenhol megerősített varrás
- Kettős tépőzár



2002/BV9 Ft 5.180 1 020020030

☞ 325x290 mm - 155 g

2002/BV12

tartós poliészterből készült összetekkerhető szerszámtok, üres

- 12 különböző méretű praktikus szerszámtartó zseb
- A megerősített anyagból készült fülnek köszönhetően könnyen szállítható
- A belső hajtóka megakadályozza, hogy a szerszámok kiessenek
- Körben mindenhol megerősített varrás
- Kettős tépőzár



2002/BV12 Ft 8.580 1 020020040

☞ 650x355 mm - 310 g

2002/BV13

tartós poliészterből készült összetekkerhető szerszámtok, üres

- 13 különböző méretű praktikus szerszámtartó zseb
- A megerősített anyagból készült fülnek köszönhetően könnyen szállítható
- A belső hajtóka megakadályozza, hogy a szerszámok kiessenek
- Körben mindenhol megerősített varrás
- Kettős tépőzár



2002/BV13 Ft 5.180 1 020020050

330x190 mm - 110 g

2002/BV42

tartós poliészterből készült összetekkerhető szerszámtok, üres

- 42 különböző méretű praktikus szerszámtartó zseb: 18 gumipánt és 24 zseb (egy tépőzár)
- A megerősített anyagból készült fülnek köszönhetően könnyen szállítható
- Fém gyűrűkkel a falra akasztható
- Körben mindenhol megerősített varrás
- Robusztus duplacsatos zár
- Méret nyitott állapotban: 595 x 535 mm



2002/BV42 Ft 12.750 1 020020070

595x540 mm - 490 g

2005MPU

övtáska, üres, nylonból, övvel

- Öt nagy szerszámtartó zseb
- Egy ollótartó zseb elöl
- Karabinerhorog a csaton a ragasztószalaghoz
- Állítható öv (70 ÷ 120 cm)



2005MPU Ft 13.350 1 020050060

155x285x80 mm

2005MPU/E

övtáska 5 szerszámmal



2005MPU/E Ft 43.100 1 020050065

- 1128BMX 147 mm
- 1150BM 180 mm
- 1201E 3,5x100 - 4x100 mm
- 1202E PH1x80 mm
- 155x285x80 mm

2005PA/D

Övtáska, üres, nylonból, övvel



2005PA/D Ft 31.350 1 020050000

2005PA/E

övtáska, üres, nylonból, övvel

- Két nagy zseb szerszámtartó gumipánttal
- Két ollótartó zseb elöl
- Két praktikus oldalzseb:
 - bal oldali zseben erős fémhorog a mérőszalagnak
 - dupla jobb oldali zseb zsinóros tasakkal és cipzárral
- Karabinerhorog a csaton a ragasztószalaghoz
- Állítható öv (70 ÷ 120 cm)



2005PA/E Ft 20.850 1 020050030

260x250x190 mm

2005PA/ET

övtáska 8 szerszámmal elektrotechnikai karbantartáshoz, villanszereléshez



2005PA/ET Ft 85.200 1 020050035

- 1082MQ 160 160 mm
- 1128BMX 147 mm
- 1253
- 1272MQF PH1x80 - PH2x100
- 1274MQF 3,5x100 - 4,5x100
- 1639ESB BMESB1925NE
- 260x250x190 mm

2005PA/S

Övtáska, üres, nylonból, övvel



2005PA/S Ft 15.800 1 020050020

280x76x264 mm

2009N/BV

Karbantartó bőr szerszámtáska, üres

Teljes egészében bőrből készült, alumíniummal erősített oldalfallal

Tartozékok:

- vállpánt
- fémcsatos zár
- masszív belső alj, horganyzott vaslemezből



2009N/BV Ft 132.800 1 020090200

530x220x190 mm



2005PA/U

övtáska 17 szerszámmal univerzális alkalmazásra



2005PA/U Ft 84.700 1 020050040

96/SC9 1,5-2-2,5-3-4-5-6-8-10 mm
111E 200 mm
1048N 250 mm
1128BMX 147 mm
1201E 4x100 - 5,5x125 mm
1202E PH1x80 - PH2x100 mm
1692/3 3 m
260x250x190 mm

2028/VV

polipropilén szerszámtáska

2 szerszámtartó panel
Kivehető válaszfal, belső aljzat Kétfős kombinációs zár



2028/VV Ft 109.700 1 020280010
480x190x400 mm - 4,7 Kg

2028E

táska szerszámkészlettel elektronikai és elektrotechnikai felhasználásra



2028EL/A Ft 541.900 1 020281014
(2028/VV+5980EL/A)
2028ET/A Ft 542.500 1 020281018
(2028/VV+5980ET/A)

2029/VV

szerszámtáska, keményfalú, polipropilén, alumínium profillal merevítve

- 2 szerszámpanel
- Az aljrászban kivehető és állítható rekeszekkel
- Vállszij
- 2 kulcsos zár



2029/VV Ft 157.100 1 020290000
480x227x408 mm - 6 Kg

2029E

Szerszámkészlet műszerésznek és villanszerelőknak szerszámtáskában



2029 BG MQ Ft 950.500 1 020291257
(2029/VV+5980MQ)
2029ET/B Ft 756.800 1 020291021
(2029/VV+5980ET/B)
2029EL/B Ft 764.400 1 020291017
(2029/VV+5980EL/B)

2029EM

Szerszámkészlet hibrid és elektromos gépjárművek karbantartásához és javításához szerszámtáskában



2029EM Ft 989.700 1 020290300

52MQ 7-8-9-10-11-12-13-14-15-16-17-19-22 mm
910MQ/B 6-7-10-12-13-17-19 mm
910MQ/TX TX25 - TX30 - TX40
910MQ/55
1048MQ 250 mm
1082MQ 160 mm
1128MQ 145 mm
1150MQ 180 mm
1162MQ 160 mm
1272MQ PH1 - PH2
1274MQ 2,5x75 - 3x100 - 4x100 - 5,5x125 - 6,5x150 mm
1760PT/N
1777MQ/U 190 mm
7109A A1 - A2
7109D D2 - D3
1997MQ/GM Gr. 10

2032/TV

Műanyag kerek szerszámtáska

- 2 szerszámpanel
- Szerszámtáska
- Fenéklap kivehető elválasztókkal



2032/TV Ft 212.600 1 020320110
450x200x400 mm - 3 Kg



2032/TE

Szerszámkészlet műszerészeknek és villanszerelőknak, kerek szerzámzátkában



2032TET/A
(2032/TV+5980ET/A)

Ft 645.400

1 020321328

2033L/VV

alumínium műszerésztkáka, üres

- Kiemelten ütészálló
- Karcmentes kivitel
- Ergonomikus, gumis fogantyú
- Kettős kombinációs zár

- 2 szerzámzátkó panel gumipánttal
- Kivehető elválasztók



2033L/VV

Ft 172.100

1 020330250

470x203x373 mm - 6 Kg

2033L

szerzámkészlet műszerészeknek és villanszerelőknak alumínium szerzámzátkában



2033LEL/A
(2033L/VV+5980EL/A)

Ft 604.300

1 020331224

2033LEL/B
(2033L/VV+5980EL/B)

Ft 779.400

1 020331225

2033LET/B
(2033L/VV+5980ET/B)

Ft 771.700

1 020331237

2036/TV

Kerek szerzámzátkáka polipropilén, alumínium profilal merevítve

- 2 szerzámzátkó panel
- Teleszkópos fogantyúval
- Csapágázott kerekék



2036/TV

Ft 249.000

1 020360000

480x267x408 mm - 7,5 Kg

2036E

Szerzámkészlet műszerészeknek és villanszerelőknak kerek szerzámzátkáka



2036TET/B
(2036/TV+5980ET/B)

Ft 848.700

1 020361223

2036EL/B
(2036/TV+5980EL/B)

Ft 856.300

1 020361218

2037/TV

nagyvastagságú polipropilén húzható szerzámzátkó táskáka 4 elforduló kerékkel

- Rendkívül ütészálló. Repülőgépes szerzámzátkó szállításhoz javasolt.
- 2 kivehető szerzámzátkó panel.
- Beépített dokumentumtartó zseb.
- 4 eltávolítható elforduló kerék, amelyek lehetővé teszik a szerzámzátkó vízszintes mozgatását.
- 2 szerzámzátkó tállal szállítva
- 2 engedélyezett TSA zár kulccsal
- Gumiborítású ergonomikus fogantyú



2037/TV

Ft 306.900

1 020370000

482x295x478 mm - 8,2 Kg

2038/TV

nagyvastagságú polipropilén húzható szerzámzátkó táskáka

- Rendkívül ütészálló.
- Alumínium tartóprofil
- 2 TSA homologizációval rendelkező kulcsos zár
- 2 kivehető szerzámzátkó panel.
- Teleszkópos fogantyú és nagy, golyóscsapágás kerekék
- 2 ergonomikus, gumival bevont fogantyú (1 oldalsó)
- Tágas alsó rész
- Dokumentum tartó zseb
- 3 szerzámzátkó tállal



2038/TV

Ft 406.100

1 020380000

430x375x525 mm - 9 Kg



Beta



2041UC

33 darabos szerszámkészlet "Utility Case" kofferben



2041UC Ft 161.500 1 020410215

- 55 6x7 - 8x9 - 10x11 - 12x13 - 14x15 - 16x17 mm
- 96/SC9 1,5 - 2 - 2,5 - 3 - 4 - 5 - 6 - 8 - 10 mm
- 111E 200 mm
- 1048VN 250 mm
- 1128BMX 147 mm
- 1150 180 mm
- 1201E 2,5x50 - 3x75 - 4x100 - 5,5x100 - 6,5x150 mm
- 1202E PH0x60 - PH1x80 - PH2x100 mm
- 1370 300 g
- 1692 3m
- 1771 170 mm
- 1833S 70 Lumen / 140 mm
- 1639NS-N 25m
- 1696 200 mm
- 535x282x87 mm - 4,5 Kg

2051N

55 darabos szerszámkészlet hajókarbantartáshoz ütésálló PP-kofferben



2051N Ft 384.600 1 020510225

- 42 7 - 8 - 10 - 12 - 13 - 14 - 17 - 19 mm
- 55AS 3/8x7/16 - 1/2x9/16 - 5/8x11/16"
- 96/SC9 1,5÷10 mm
- 111E 200 mm
- 920A 10 - 12 - 13 - 14 - 17 - 19 mm
- 920AS 7/16 - 1/2 - 9/16 - 11/16 - 7/8"
- 920/22 255 mm - 1/2 - 1/2
- 920/25 1/2 - 1/2
- 920/42 1/2
- 920/55 1/2
- 956C 1/2 - 16 - 20,8 mm
- 1048BM 250 mm
- 1084BM 160 mm
- 1128BMX 147 mm
- 1150BM 180 mm
- 1166BM 160 mm
- 1201E 3x75 - 4x100 - 5,5x150 - 6,5x150 mm
- 1202E PH1x80 - PH2x100 mm
- 1390 35 mm
- 1490/2 240 mm
- 1737 145 mm
- 1778X
- BMN1436 3,6 x 140 mm
- BMESB1925NE 25 m
- 585x393x92 mm - 9 kg

2055HB

24 darabos szerszámkészlet "Home Bag", szerszámkofferben



2055HB Ft 97.150 1 020550215

- 55 6x7 - 8x9 - 10x11 - 12x13 mm
- 96N/SC9 1,5 - 2 - 2,5 - 3 - 4 - 5 - 6 - 8 - 10 mm
- 1128BMX 147 mm
- 1150 180 mm
- 1048VN 250 mm
- 1201E 3x75 - 4x100 - 5,5x100 mm
- 1202E PH0x60 - PH1x80 - PH2x100 mm
- 1370 300 g
- 1692 3m
- 373x275x70 mm - 3 Kg

2080/DS

Szerszámtáska 15 darab rekeszsel és 10 darabkivehető válaszfalal

- Tökéletes megoldás aprócskék, így csavarok, anyák, alátétek, szegecsek és tiplik szállítására.
- Az erős átlátszó fedél megakadályozza, hogy az alkatrészek kiessenek a rekeszekből
- A kivehető válaszfalakkal az igényeknek megfelelő méretű rekeszek alakíthatók ki
- A rekeszek egymásra rakhatók és összepattinthatók
- Belső méret: 345 x 290 mm



2080/DS Ft 9.800 4 020800210

375x315x65 mm - 760 g

2080/DL

Szerszámtáska 15 darab rekeszsel és 8 darab kivehető válaszfalal

- Tökéletes megoldás aprócskék, így csavarok, anyák, alátétek, szegecsek és tiplik szállítására.
- Az erős átlátszó fedél megakadályozza, hogy az alkatrészek kiessenek a rekeszekből
- A kivehető válaszfalakkal az igényeknek megfelelő méretű rekeszek alakíthatók ki
- A rekeszek egymásra rakhatók és összepattinthatók
- Belső méret: 410 mm x 300 mm



2080/DL Ft 11.550 3 020800211

440x330x75 mm - 970 g

2080/V17

Szerszámtáska 17 darab kivehető rendező műanyag dobozzal

Kis alkatrészek rendezett tárolásához és szállításához elengedhetetlen.

- Az erős fedél megakadályozza, hogy az alkatrészek kiessenek a rekeszekből
- Különböző méretű tálcák:
 - kicsi: 5,1x4,6x5,9 cm
 - közepes: 5,1x9,9x5,9 cm
 - nagy: 10x9,9x5,9 cm
- Belső méret: 310 x 255 mm



2080/V17 Ft 10.700 4 020800200

335x285x65 mm - 750 g

2080/V6

Üres szerszámtáska 6 db kivehető tálcával és állítható válaszfalakkal



2080/V6 Ft 18.000 1 020800060
385x320x60 mm - 1,2 kg

2080/V6-U

kivehető tálcá a 2080/V6 táskához



2080/V6-U Ft 1.380 1 020800066
90x60x50 mm

2080/V12

szerszámtáska 12 db kivehető tálcával



2080/V12 Ft 28.350 1 020800000
300x145x330 mm - 1,8 kg

2080/V12-...

kivehető tálcá a 2080/V12 táskához



	Ft	1	020800013
2080/V12-S 95x75x65 mm	1.740	3	020800013
2080/V12-M 145x75x65 mm	2.610	2	020800015
2080/V12-L 295x75x65 mm	4.490	1	020800020

C3

mini szerszámtáska hightech szövetből

Fő jellemzők:

- 1 cipzáros elülső külső zseb
- 2 oldalsó zseb tálcával
- 1 praktikus tépőzárás hátsó zseb
- 1 kivehető belső szerszámtartó panel két oldalt gumipánttal
- USB csatlakozó mobilkészülékek töltéséhez
- Vállszíjjal szállítva



C3 Ft 30.350 1 021030000
230x110x320 mm - 917 g

C5S

szerszámos hátizsák kopásálló poliészterből

- Dupla pánt felül középen a stabil, kiegyensúlyozott tartáshoz
- Két nagy elülső zseb
- Két tágas belső zseb és két további tépőzárás pánt
- Négy eszköztartó panelből álló feltekerhető belső táská
- Állítható megerősített vállpánt
- Maximális teherbírás: 15 kg



C5S Ft 26.100 1 021050100
310x120x390 mm - 0,9 Kg

C5 - 2105

Szerszámos hátizsák Hightech-textilből



C5 Ft 73.050 1 021050000
2105VU/0 Ft 261.600 1 021050112
(C5+5915VU/0)
400x200x500 mm - 2,8 Kg

C6T - 2106

Húzható szerszámtáska textilből



C6T	Ft		
2106T/VU0	103.600	1	021060010
(C6T+5915VU/0)	292.100	1	021061123

360x200x480 mm - 4,9 Kg

C7 - 2107

Szerszámtáska High-Tech-szövetből

- 2 kivehető szerszámpanel
- Notebook zseb
- Elöl 2 külső zseb
- Kivehető műanyag elválasztók



C7	Ft		
2107VU/2	108.100	1	021070000
(C7+5915VU/2)	307.800	1	021071112
2107VU/3	529.100	1	021071114
(C7+5915VU/3)			

480x165x380 mm - 4 Kg

C7AT

Szerszámtáska tartós hightech szövetből

Fő jellemzők:

- kiemelten ellenálló hightech szövetből készült
- megerősített gumitalppal
- dupla felső kézipánt a biztonságos, kiegyensúlyozott tartásért
- nagy előlő cipzáras dokumentumtároló zseb + kiegészítő kettős tépőzárral és patenttel zárható rekesz
- 2 db tépőzáras oldalzseb
- tágas belső rekesz kiegészítő dokumentum zsebbel
- bélelt laptop és tablet tároló rekesz (maximum 370 mm x 250 mm méretű laptop - 15")
- a táska mindkét oldalán cipzáros, így gyorsan hozzáférhetünk a szerszámokhoz:
 - 29 db szerszámtartó rekesz és 13 db rugalmas szerszámtartó szalag előtt;
 - 33 db szerszámtartó rekesz hátul.
- állítható, bélelt vállpánttal szállítva



C7AT	Ft		
	57.900	1	021070010

420x200x340 mm - 2,8 Kg

C8 - 2108

Húzható szerszámtáska, Hightech-szövet, üres

- Teleszkópos fogantyú a szállításhoz
- 2 belső kivehető szerszámpanel
- 2 külső zseb
- C10S modell ráhelyezhető



C8	Ft		
2108VU/1	121.900	1	021080000
(C8+5915VU/1)	351.500	1	021081022

470x280x380 mm - 5,5 Kg

C8B

hightech szövet szerszámkocsi villanyszerelőknak

Merev keret

Teleszkópos fogantyúval

4 kerék

1 kivehető belső szerszámtartó panel

Előlő zseb kártyatartóval

Kettős fenék hőformált tálcával

2 külső oldalzseb

2 kábelbehúzó

A lejahajtható fogantyú könnyebb hozzáférést biztosít a szerszámokhoz

Lakattal zárható (a lakat nem tartozék)



C8B	Ft		
	98.400	1	021080300

380x250x430 mm - 4,8 Kg

C9 - 2109

Szerszámtáska Hightech-szövetből

- Merev fenéklap
- Belső- és külső zsebek a szerszámok elhelyezésére
- Cipzáras külső zseb a nagyobb biztonság érdekében
- Tépzáras zseb a személyes tárgyak részére
- Dupla fenéklap
- Dupla szíj vízmérték rögzítéséhez
- Vállszíj az egyszerűbb szállításhoz



C9	Ft		
2109VU/1	59.100	1	021090000
(C9+5915VU/1)	288.700	1	021091022
2109VU/3	480.100	1	021091024
(C9+5915VU/3)			

550x280x320 mm - 2,6 Kg

C9/RT

Vállszij a C9-hez és a C10-hez



C9/RT Ft 7.650 1 021090900

C9DA

Nagyra nyitható szerszámtáska

Fő jellemzők:

- kiemelten ellenálló hightech szövetből készült
- kemény műanyag alap, vízálló
- megerősített felső kézipánt a biztonságos tartásért
- 2 db tépőzárás oldalzseb
- két, nagyra nyitható oldalsó szerszámtartó rekesz a gyors hozzáférés és a könnyű átláthatóság érdekében
- 22 db szerszámtartó zseb és kiegészítő cipzáras rekesz elöl
- 14 db szerszámtartó zseb és kiegészítő cipzáras rekesz hátul
- állítható, bélelt vállpánttal szállítva



C9DA Ft 46.750 1 021090005

420x220x310 mm - 2,4 Kg

C9MT

karbantartó szerszámtáska

- robusztus PVC fedél, vízálló
- körben mindenhol megerősített varrás
- duplacsatos zár
- dupla belső kézipánt a biztonságos, kiegyensúlyozott tartásért
- cipzáros dokumentumtartó zseb



C9MT Ft 41.500 1 021090200

450x180x200 mm - 1,4 Kg

2109MT ID/1

karbantartó szerszámtáska 24 darabos vízvezetékészterelő szerszámmal



2109MT ID/1 Ft 297.900 1 021091026

(C9MT+5980ID/1)

- 111E 250 mm
- 332 Ø 3+28 mm
- 334 Ø 3+30 mm
- 342 Ø 0+42 mm
- 345SB2 140 mm
- 376 320-410 mm
- 1048N 175-250 mm
- 1128BMX 147 mm
- 1150GBM 180 mm
- 1201E 3x75-4x100-5,5x150-8x150 mm
- 1202E PH1x80-PH2x100
- 1370 500 g
- 1690F 2 m
- 1692/5 5 m
- 1696 200 mm
- 1719BMA...M 200 mm
- 1719BM/RL 200 mm
- 1725



C9PT



C9PT 314

C10 - 2110

Szerszámtáska Hightech-szövetből

- Merev struktúra
- Dupla fenéklap. A fenéklap eltávolítható a nagyobb hely érdekében
- Lehajtható, ill. sréhen állítható fogantyú, a szerszámokhoz könnyebb hozzáférés érdekében
- Gumis belső és külső zsebek szerszámok elhelyezésére
- Bélés
- Tálca a kis tárgyak elhelyezésére a dupla fenéklapban



C10 Ft 74.100 1 021100000

2110VU/1 Ft 303.700 1 021101031

(C10+5915VU/1)

2110VU/3 Ft 495.100 1 021101034

(C10+5915VU/3)

2110VU/AS Ft 537.200 1 021101036

(C10+5915VU/AS)

520x220x250 mm - 3,3 Kg





C12 - 2112

Szerszámtáska High-Tech-szövetből

- Kivehető szerszámpanel
- Nagy belső és külső zsebek gumisalaggal szerszámok elhelyezésére
- Elöl nyitható zseb, ami megkönnyíti a szerszámok kivételét
- Gumizott vízálló fenéklap
- C8 teleszkópos fogantyúval is használható



	Ft	📦	📄
C12	93.700	1	021120000
2112ET/A (C12+5980ET/A)	526.500	1	021121028
2112ET/B (C12+5980ET/B)	693.400	1	021121029
2112VU/5 (C12+5915VU/5)	630.300	1	021121056

📏 500x270x350 mm - 📊 5,3 Kg

C13

húzzható szerszámláda tartós polipropilénből

- Szabadtéri használatra alkalmas
- Űtésálló, vegyszerálló
- Lelakatholható (a lakat nem tartozék)
- Kétfős zár
- Két kerék a szerszámláda könnyebb mozgatásához
- Kivehető, két helyen rögzíthető belső tálca
- Névtábla



	Ft	📦	📄
C13	155.100	1	021130000

📏 806x350x467 mm - 📊 7,2 Kg

C14

4 fiókos polipropilén húzzható szerszámtartó táska

- Nagyfokú ütésvédelmet biztosító injektált polipropilén szerkezet.
- A burkolattal rendelkező első rész 4 db 470x255 mm, kihúzható fiókot tartalmaz.
1 fiók 30 mm magas
2 fiók 60 mm magas
1 fiók 90 mm magas
- Az első központi zár lehetővé teszi a felső és az első burkolat egyidejű zárását.
- Két oldalifogantyú
- 4 erőteljes hátsó kerék
- Levehető felső tálca
- Fedélbe épített szerszámtartó panel
- 3 db szerelékartató tálcával
- Névtartó azonosító adattábla
- TSA lakattal történő zárásra felkészítve



	Ft	📦	📄
C14	395.500	1	021140000
2114VU/M (C14+5914VU/M)	907.800	1	021141011

📏 585x390x457 mm - 📊 14,5 Kg

CP15 - 2115

Műanyag szerszám láda kivehető betéttel és tálcák kis tárgyak elhelyezésére

- 1 tálca kis tárgyak elhelyezésére, fedélbe beépítve
- 2 kivehető tálca kis tárgyak elhelyezésére állítható elválasztókkal
- 1 belső betét állítható elválasztókkal



	Ft	📦	📄
CP15	22.850	1	021150201
2115PVU/1 (CP15+5915VU/1)	252.500	1	021151232

	Ft	📦	📄
2115PVU/2 (CP15+5915VU/2)	222.600	1	021151234

📏 445x240x250 mm - 📊 2 Kg

C10S - 2110S

Szerszámtáska Hightech-szövetből

- Merev fenéklap
- Dupla fenéklap. A fenéklap eltávolítható a nagyobb hely érdekében
- Lehajtható, ill. sréhen állítható fogantyú, a szerszámokhoz könnyebb hozzáférés érdekében
- Gumis belső és külső zsebek szerszámok elhelyezésére
- Bélés
- Tálcák a kis tárgyak elhelyezésére a dupla fenéklapban



	Ft	📦	📄
C10S	58.300	1	021100001
2110SVU/1 (C10S+5915VU/1)	287.900	1	021101041
2110SVU/3 (C10S+5915VU/3)	479.300	1	021101044

📏 420x220x250 mm - 📊 2,9 Kg

C11 - 2111

Szerszámtáska textilből



	Ft	📦	📄
C11	43.100	1	021110000
2111VU/1 (C11+5915VU/1)	272.700	1	021111031
2111VU/3 (C11+5915VU/3)	464.100	1	021111034

📏 410x230x250 mm - 📊 1,8 Kg





CP15L - 2115

Műanyag szerszámos láda, hosszú kivitel kivehető betéttel és tálcák kis tárgyak elhelyezésére

- 3 tálcá kis tárgyak elhelyezésére, fedélbe beépítve, állítható elválasztókkal
- 1 belső betét elválasztókkal



	Ft		
CP15L	31.150	1	021150202
2115PL-VU/1 (CP15L+5915VU/1)	260.800	1	021151242
2115PL-VU/3 (CP15L+5915VU/3)	452.100	1	021151245

558x277x270 mm - 2,9 Kg

2115PI/BIKE-HOME



	Ft		
2115PI/BIKE-HOME	125.400	1	021150098

- 96BP/SC9 1,5-2-2,5-3-4-5-6-8-10 mm
- 3935
- 3969K3
- 42 8-9-10-13-14 mm
- 42SLIM 15 mm
- 1082G 160 mm
- 1150G 180 mm
- 1201E 3x75 - 5,5x150 mm
- 1202E PH0x60 - PH2x100 mm
- 3991

BMESB1925NE 25 m

BMN1436 3,6 x 140 mm

558x277x270 mm - 4,3 kg

2115P L-MQ32

32 darabos szigetelt szerszámkészlet hibridautókhoz, puha hőformázott tálcás műanyag kosárban



	Ft		
2115PL-MQ32	573.200	1	021150332

920MQ/55A

89MQ 10-12 mm

850MQ 1/4"

861TX/A10 T7 - T8 - T9 - T10 - T15 - T20
T25 - T27 - T30 - T40

920MQ/A 8-10-12-13-14-17-19 mm

920MQ/21 125mm

920MQ/22 250mm

1048MQ250 250mm

1150MQ 180mm

1164MQ160 160mm

1272MQ 4.5X80-6X100mm

1274MQ 3X100-4X100-5.5X125

1997MQ/GM Gr. 10

CP15L

C16 - 2116

Szerszámtáska belső rekeszekkel, üres



	Ft		
C16	51.000	1	021160000
2116VU/1 (C16+5915VU/1)	280.600	1	021161102
2116VU/3 (C16+5915VU/3)	472.000	1	021161105

500x260x260 mm - 2,3 Kg



CP17 - CP17L - 2117

Szerszámos láda acéllemezről és műanyagból, betéttel



CP17
500x200x220 mm



CP17L
575x245x265 mm

	Ft		
CP17	42.700	1	021170500
2117P-VU/1 (CP17+5915VU/1)	272.300	1	021171042
2117P-VU/3 (CP17+5915VU/3)	463.700	1	021171045
CP17L	61.550	1	021170502
2117L-VU/1 (CP17L+5915VU/1)	291.100	1	021171142
2117PL-VU/3 (CP17L+5915VU/3)	482.500	1	021171145

C18 - 2118

Szerszámosláda acéllemezről



	Ft		
C18	20.250	1	021180001
2118VU/1 (C18+5915VU/1)	249.900	1	021181032

450x200x100 mm - 2,1 Kg

C19 - 2119 - C19L - 2119L

Háromrekeszes szerszám láda, fémlemez



C19

450x200x160 mm



C19L

550x200x160 mm

	Ft		
C19	26.700	1	021190001
2119VU/3 (C19+5915VU/3)	447.700	1	021191025
C19L	34.200	1	021190002
2119L-VU/3 (C19L+5915VU/3)	455.200	1	021191125

C20 - C20L - 2120

Ötrekeszes szerszám láda fémlemez



C20

450x200x210 mm



C20L

550x200x210 mm

	Ft		
C20	37.650	1	021200001
2120VU/2 (C20+5915VU/2)	237.400	1	021201061
2120VU/3 (C20+5915VU/3)	458.600	1	021201063
2120VU/4 (C20+5915VU/4)	584.300	1	021201064
2120VU/AS (C20+5915VU/AS)	500.700	1	021201068
C20L	41.300	1	021200002
2120L-VU/2 (C20L+5915VU/2)	241.000	1	021201161
2120L-VU/3 (C20L+5915VU/3)	462.300	1	021201163
2120L-VU/4 (C20L+5915VU/4)	588.000	1	021201164
2120L-VU/AS (C20L+5915VU/AS)	504.400	1	021201168

C20TSS

Ötrekeszes szerszám láda rozsdamentes acélból (AISI 304)



	Ft		
C20TSS	138.100	1	021203001

450x200x210 mm - 4 Kg

C22B

Szerszámláda acéllemezből



C22B O

720x320x310 mm



C22BM O

850x360x350 mm



C22BL O

1010x410x400 mm

	Ft		
C22B-O	106.900	1	022000150
C22BM-O	123.100	1	022000160
C22BL-O	164.000	1	022000170

C22B O: 720x320x310 mm - 13 Kg
C22BM O: 850x360x350 mm - 20 Kg
C22BL O: 1.010x410x400 mm - 26 Kg

C22W

Szerszámláda acéllemezből, belső borítás a szerszámok védelmére



C22W-O

690x300x360 mm



C22WL-O

990x300x360 mm

	Ft		
C22W-O	119.000	1	022000269
C22WL-O	154.700	1	022000299

C22W O: 690x300x360 mm - 15 Kg
C22WL O: 990x300x360 mm - 28 Kg

C22P

szerszám műhelyláda, lemezből

- Süllyesztett fogantyúk
- Emelt csúsztalpak targoncás felemeléshez
- Felfeszítésbiztos lakatolható kettős zár (lakat nélkül)



C22PM O

915x540x430 mm



C22PL O

1220x720x615 mm

	Ft		
C22PM-O	318.600	1	022000240
C22PL-O	491.900	1	022000245

C22PM O: 915x540x430 mm - 39 Kg
C22PL O: 1.220x720x615 mm - 67 Kg



A Combo a Beta új moduláris rendszere, amely három különböző robusztus szerszámládával

megkönnyíti a szerszámok biztonságos és rendezett tárolását.

A szerszámládák az oldalt elhelyezkedő mechanizmusnak köszönhetően egyszerűen összepattinthatók.

Az új Beta Combo C99 rendszer kompatibilis a Sortimo® L-BOXX szabványával.

C99

BETA COMBO komplett moduláris rendszer

A szerszámdobozok egyszerűen összekapcsolhatók egy kattintással, a praktikus oldalsó bepattintós mechanizmus segítségével.

Rendszer összeállítás:

- Ultrakompakt összecukható szállítókoszi teleszkópos fogantyúval C99P (485x520x1095 mm)
- ABS szerszámdoboz C99V1 (445x358x152 mm)
- ABS szerszámdoboz C99V2 (445x358x254 mm)
- ABS szerszámdoboz, 2 darab kivethető C99V3/2C tálcával (445x358x322 mm)



C99 Ft 310.500 1 099000010

C99V0

COMBO ABS szerszámdoboz átlátszó fedéllel

Az oldalsó bepattintós mechanizmussal a szerszámdobozok egyszerűen összepattinthatók.

Fő jellemzők:

- Az erős átlátszó polikarbonát fedélnek köszönhetően gyorsan felismerhető a tartalma
- Külső méret: 445x358x118 mm
- Max. belső teherbírás: 25 kg
- Lelakolható
- Súly: 2,5 kg

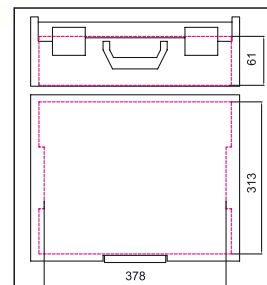

C99V0 Ft 49.800 1 099000202

C99V0-P12

COMBO ABS szerszámdoboz átlátszó fedéllel

Az oldalsó bepattintós mechanizmussal a szerszámdobozok egyszerűen összepattinthatók.

Fő jellemzők:

- Az erős átlátszó polikarbonát fedélnek köszönhetően gyorsan felismerhető a tartalma
- Különösen alkalmas tömegcikkek, így csavarok, anyák, alátétek, szegecsek és tiplik szállítására
- 18 tálcát tartalmaz:
 - 2 piros tábla, 52x52 mm
 - 3 sárga tábla, 104x52 mm
 - 2 kék tábla, 104x104 mm
 - 1 zöld tábla, 104x156 mm
 - 2 narancs tábla, 208x52 mm
 - 2 szürke tábla, 312x71 mm, és 6 állítható válaszfal
- Külső méret: 445x358x118 mm
- Max. belső teherbírás: 25 kg
- Lelakatható
- Súly: 3,2 kg

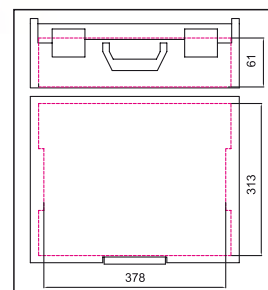

C99V0-P12

Ft 71.050 1 099000200

C99V2

COMBO ABS szerszámdoboz

A szerszámdobozok egyszerűen összekapcsolhatók egy kattintással, a praktikus oldalsó bepattintós mechanizmus segítségével.

Főbb jellemzői:

- Külső méretek: 445x358x254 mm
- Max. belső teherbírás: 25 kg
- Súly: 2,8 kg

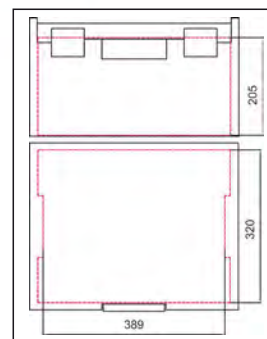

C99V2

Ft 56.250 1 099000350

C99V3/2C

COMBO ABS szerszámdoboz 2 darab kivethető rendezőtálcával

A szerszámdobozok egyszerűen összekapcsolhatók egy kattintással, a praktikus oldalsó bepattintós mechanizmus segítségével.

Főbb jellemzői:

- Külső méretek: 445x358x322 mm
- 2 darab C99C-V3 üres rendezőtálcával
- Max. belső teherbírás: 25 kg
- Súly: 5,6 kg

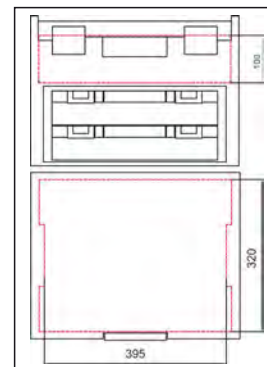

C99V3/2C

Ft
108.100



1



099000450

C99P

COMBO összecsuksukható szállítókocsi

Fő jellemzők:

- Ultrakompakt összecsuksukható szerszámkocsi
- Teleszkópos fogantyú
- Méret nyitott állapotban: 485x520x1095 mm
- Méret zárt állapotban: 485x80x810 mm
- Alap mérete: 485x350 mm
- Két defektvédett kerék, Ø 175 mm
- Hordozópá



C99P

Ft
97.550



1



099000101

C99PP

szerszámtartó panel COMBO szerszámdobozokhoz

- 6 zseb és 11 szerszámtartó gumipánt
- a panel szerszámdoboz fedelére rögzítéséhez szükséges kampókkal szállítva



C99PP

Ft
23.050



1



099000489



RSC22

3 fiókos
szerszámoszláda

Fő jellemzők:

3 teleszkópos, csapágyazott fiók (588x277 mm):

1 fiók, 50 mm magas

2 fiók, 70 mm magas.

• Központi zár elöl.

• Süllyeszthető oldalfogantyúk a könnyebb kezelés érdekében.

19 kg



RSC22-O



RSC22-A



RSC22-R



h		
	50 mm	25 kg
	70 mm	25 kg

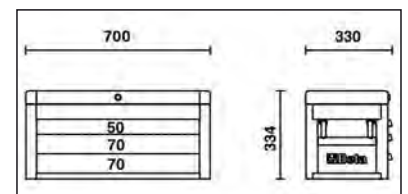
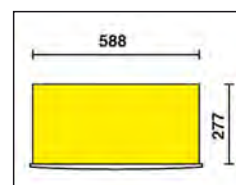

			Ft		
RSC22-O	RAL 2011	219.800	1	022003001	
RSC22-R	RAL 3000	219.800	1	022003003	
RSC22-A	RAL 7016	219.800	1	022003007	

RSC23

5 fiókos
szerszámoszláda

Fő jellemzők:

- 5 teleszkópos, csapágyazott fiók (588x277 mm):
- 2 fiók, 50 mm magas
- 3 fiók, 70 mm magas.
- Központi zár elöl.
- Süllyeszhető oldalfogantyúk a könnyebb kezelés érdekében.

📦 26 kg



RSC23-A



RSC23-R



RSC23-O



h	max
50 mm	25 kg
70 mm	25 kg

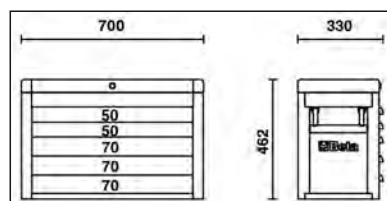
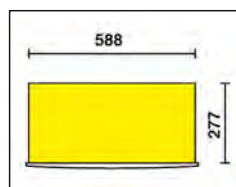

		Ft	📦	🖨️
RSC23-O	RAL 2011	278.900	1	023003001
RSC23-R	RAL 3000	278.900	1	023003003
RSC23-A	RAL 7016	278.900	1	023003007

CD23S

Caddy szállítókoszti

Fő jellemzők:

- ABS-sel bevont munkalap, melyre a C22S, C23S, C23SC vagy C23ST modell röhelyezhető.
- A kocsi rúd leszerelhető és a kocsi alatt tárolható.
- Négy Ø 100 mm kerék: 2 rögzített és 2 forgókerék (egy kerék fékezhető).
- Maximális teherbírás: 250 kg.

📦 14 kg



	Ft	📦	🖨️
CD23S	128.300	1	023000610

RSC23C

8 fiókos
szerszámoszláda

Fő jellemzők:

- 8 teleszkópos, csapágyazott fiók (588x277 mm):
- 4 fiók, 50 mm magas
- 3 fiók, 70 mm magas
- 1 fiók 100 mm magas.
- Központi zár elöl.
- Süllyeszhető oldalfogantyúk a könnyebb kezelés érdekében.

📦 28 kg



RSC23C-A



RSC23C-R



RSC23C-O



h	max
50 mm	25 kg
70 mm	25 kg

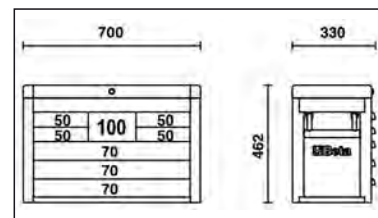
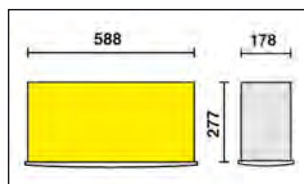

		Ft	📦	🖨️
RSC23C-O	RAL 2011	315.000	1	023003011
RSC23C-R	RAL 3000	315.000	1	023003013
RSC23C-A	RAL 7016	315.000	1	023003017

RSC23T

5 fiókos
szerszámosláda

Fő jellemzők:

5 teleszkópos, csapágazott fiók (588x367 mm):

- 5 fiók, 70 mm magas.
- Központi zár elől.
- 4 darab kerék és fogantyú rászerezhető (2300ST/KIT)

36 kg



RSC23T-A



RSC23T-B



RSC23T-O



RSC23T-G



RSC23T-FO

h	max
70 mm	25 kg



RSC23T-N



RSC23T-R

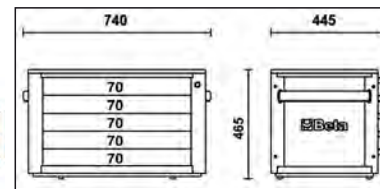
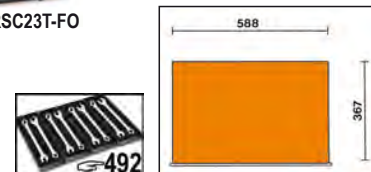

		Ft		
RSC23T-FO	RAL 2011	351.400	1	023003020
RSC23T-O	RAL 2011	351.400	1	023003021
RSC23T-G	RAL 9006	351.400	1	023003022
RSC23T-R	RAL 3000	351.400	1	023003023
RSC23T-B	RAL 5015	351.400	1	023003026
RSC23T-A	RAL 7016	351.400	1	023003027
RSC23T-N	RAL 9005	351.400	1	023003029

2300ST/KIT

1 fogantyú és 4 kerék a C23ST szerszámládahoz

- Négy Ø 125 mm kerék:
- 2 rögzített és 2 forgókerék (egy kerék fékezhető).
- Teleszkópos fogantyú

6,5 kg

		Ft		
2300ST/KIT		94.550	1	023000950



Beta

RSC24 SZERSZÁMKOCSI

Beta RSC24

ÚJ MUNKALAP ERŐSEBB ÉS ROBOSZTUSABB KÉNYELMESEBB ÉS PRAKTIKUSABB MODERNEBB

- Teleszkópos, csapágyazott fiókok
- A fiókok habgumival bélelték
- Mindegyik fiókba 4 db ¼-es EVA habszivacs vagy ABS hőformált tálcá helyezhető el
- Új ABS erősítésű munkalap RSC22, RSC23, RSC23C és RSC23T szerszámszekrényhez
- Univerzális munkalap legurulásgátló peremmel és nyolc csavarhúzó tartó lyukkal
- Központi biztonsági zár elől
- Négy Ø 125 mm kerék: 2 rögzített és 2 forgó kerék (egy kerék fékezhető)
- Statikus terhelhetőség: 800 kg



800 kg

Választható színek

FO	RAL 2011	RAL 2011
O	RAL 7016	RAL 2011
G	RAL 7016	RAL 9006
R	RAL 7016	RAL 3000
B	RAL 7016	RAL 5015
A	RAL 7016	RAL 7016
N	RAL 9005	RAL 9005

Választható modellek:

- RSC24/5 (5 fiókos)
- RSC24/6 (6 fiókos)
- RSC24/7 (7 fiókos)
- RSC24/8 (8 fiókos)



Választható tartozékok:

2400 RSC24/PD-A
2400 RSC24/PD-N



2400 RSC24/PL



2400 RSC24/SPC



2400 RSC24/PF-A
2400 RSC24/PF-N



2400 RSC24/PF



2400 RSC24AXLP/VL



2400 RSC24/MP

2400 RSC24/PC-A
2400 RSC24/PC-N

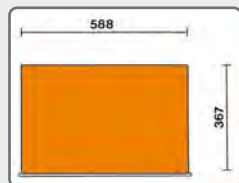
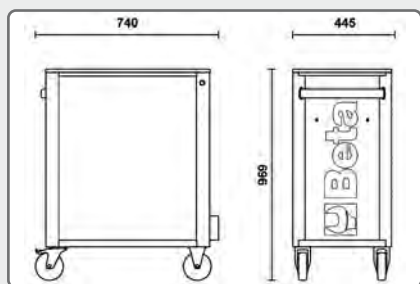

RSC24/7

7 fiókos szerszámkocsi

Fő jellemzők:

- 7 teljesen kivehető, teleszkópos, csapágyazott fiók, 588x367 mm:
- 5 fiók, 70 mm magas
- 1 fiók, 140 mm magas
- 1 fiók, 210 mm magas

63 kg

	Ft		
RSC24/7-FO	489.900	1	024004070
RSC24/7-O	489.900	1	024004071
RSC24/7-G	489.900	1	024004072
RSC24/7-R	489.900	1	024004073
RSC24/7-B	489.900	1	024004076
RSC24/7-A	489.900	1	024004077
RSC24/7-N	489.900	1	024004079



RSC24/7-O

Beta RSC24



RSC24/7-FO



RSC24/7-A



RSC24/7-B



RSC24/7-G



RSC24/7-N



RSC24/7-R



h	max
70 mm	25 kg
140 mm	30 kg
210 mm	30 kg

RSC24/5

5 fiókos szerszámkocsi

Fő jellemzők:

- 5 teljesen kivethető, teleszkópos, csapágyazott fiók, 588x367 mm:
- 2 fiók, 70 mm magas
- 2 fiók, 140 mm magas
- 1 fiók, 280 mm magas

60 kg



RSC24/5-O

	Ft	📦	🚚
RSC24/5-FO	422.700	1	024004050
RSC24/5-O	422.700	1	024004051
RSC24/5-G	422.700	1	024004052
RSC24/5-R	422.700	1	024004053
RSC24/5-B	422.700	1	024004056
RSC24/5-A	422.700	1	024004057
RSC24/5-N	422.700	1	024004059

Beta RSC24



h	max
70 mm	25 kg
140 mm	30 kg
280 mm	35 kg

RSC24/6

6 fiókos szerszámkocsi

Fő jellemzők:

- 6 teljesen kivethető, teleszkópos, csapágyazott fiók, 588x367 mm:
- 4 fiók, 70 mm magas
- 1 fiók, 140 mm magas
- 1 fiók, 280 mm magas

62 kg



RSC24/6-O

	Ft	📦	🚚
RSC24/6-FO	455.100	1	024004060
RSC24/6-O	455.100	1	024004061
RSC24/6-G	455.100	1	024004062
RSC24/6-R	455.100	1	024004063
RSC24/6-B	455.100	1	024004066
RSC24/6-A	455.100	1	024004067
RSC24/6-N	455.100	1	024004069

Beta RSC24



h	max
70 mm	25 kg
140 mm	30 kg
280 mm	35 kg

RSC24/8

8 fiókos szerszámkocsi

Fő jellemzők:

- 8 teljesen kivethető, teleszkópos, csapágyazott fiók, 588x367 mm:
- 6 fiók, 70 mm magas
- 2 fiók, 140 mm magas

66 kg



RSC24/8-O

	Ft	📦	🚚
RSC24/8-FO	528.300	1	024004080
RSC24/8-O	528.300	1	024004081
RSC24/8-G	528.300	1	024004082
RSC24/8-R	528.300	1	024004083
RSC24/8-B	528.300	1	024004086
RSC24/8-A	528.300	1	024004087
RSC24/8-N	528.300	1	024004089

Beta RSC24



h	max
70 mm	25 kg
140 mm	30 kg

RSC24A/6

6 fiókos szerszámkocsi
borulásgátló rendszerrel

Fő jellemzők:

- 6 teljesen kivethető, teleszkópos, csapágyazott fiók, 588x367 mm:
- 4 fiók , 70 mm magas
- 1 fiók , 140 mm magas
- 1 fiók , 280 mm magas

62 kg

	Ft		
RSC24A/6-O	506.100	1	024004161
RSC24A/6-R	506.100	1	024004163
RSC24A/6-A	506.100	1	024004167



Beta RSC24



RSC24A/6-A



RSC24A/6-R



h	max
70 mm	25 kg
140 mm	30 kg
280 mm	35 kg

RSC24A/7

7 fiókos szerszámkocsi
borulásgátló rendszerrel

Fő jellemzők:

- 7 teljesen kivethető, teleszkópos, csapágyazott fiók, 588x367 mm:
- 5 fiók , 70 mm magas
- 1 fiók , 140 mm magas
- 1 fiók 210 mm magas.

63 kg

	Ft		
RSC24A/7-O	540.500	1	024004171
RSC24A/7-R	540.500	1	024004173
RSC24A/7-A	540.500	1	024004177



Beta RSC24



RSC24A/7-A



RSC24A/7-R



h	max
70 mm	25 kg
140 mm	30 kg
210 mm	30 kg

RSC24A/8

8 fiókos szerszámkocsi
borulásgátló rendszerrel

Fő jellemzők:

- 8 teljesen kivethető, teleszkópos, csapágyazott fiók, 588x367 mm:
- 6 fiók , 70 mm magas
- 2 fiók , 140 mm magas

66 kg

	Ft		
RSC24A/8-O	585.000	1	024004181
RSC24A/8-R	585.000	1	024004183
RSC24A/8-A	585.000	1	024004187



Beta RSC24



RSC24A/8-A



RSC24A/8-R



h	max
70 mm	25 kg
140 mm	30 kg

RSC24AXL SZERSZÁMKOCSI

Beta RSC24

HOSSZÍTOTT KIVITEL:

MINDEGYIK FIÓKBA 6 DB ¼-ES EVA HABSZIVACCS VAGY ABS HŐFORMÁLT TÁLCA HELYZHETŐ EL



**BORULÁSGÁTLÓ RENDSZER:
MEGAKADÁLYOZZA TÖBB FIÓK
EGYSZERRE TÖRTÉNŐ KINYITÁSÁT**

- Teleszkópos, csapágyazott fiókok
- ABS erősítésű munkalap legurulásgátló peremmel, 8 csavarhúzótartó lyukkal és 6 szerszámotálccával
- Rendkívül ellenálló nejlón előlap beépített címketartóval
- Négy Ø 125 mm kerék: 2 rögzített és 2 forgó kerék (egy kerék fékezhető)
- Statikus terhelhetőség: 1000 kg
- A fiókok habgumival bélelték
- Beépített oldalsó flakontartó
- Központi biztonsági zár elől

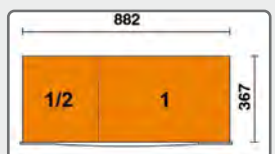
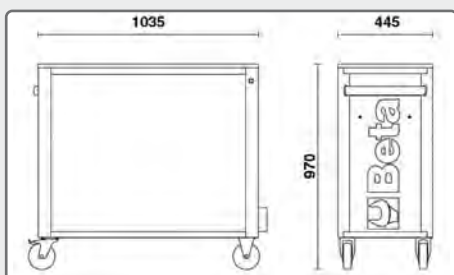

Választható színek:

O	RAL 7016	RAL 2011
R	RAL 7016	RAL 3000
A	RAL 7016	RAL 7016

Választható tartozékok:



RSC24AXL/7

7 fiókos szerszámokcsi borulásgátló rendszerrel, hosszú modell

Fő jellemzők:

- 7 teljesen kivethető, teleszkópos, csapágyazott fiók, 882x367 mm:
- 5 fiók, 70 mm magas
- 1 fiók, 140 mm magas
- 1 fiók, 210 mm magas

1000 kg



Beta RSC24



RSC24AXL/7-O

RSC24AXL/7-R

h	max
70 mm	30 kg
140 mm	35 kg
210 mm	35 kg



84 kg

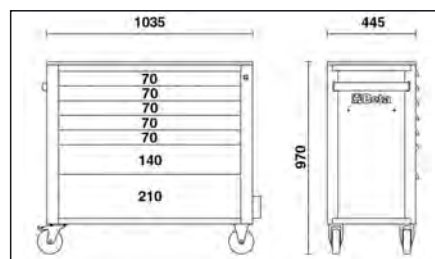
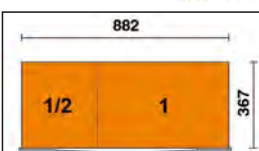

	Ft	1	1
RSC24AXL/7-O	688.300	1	024004271
RSC24AXL/7-R	688.300	1	024004273
RSC24AXL/7-A	688.300	1	024004277

RSC24AXL/8

8 fiókos szerszámkocsi
borulásgátló rendszerrel,
hosszú modell

Fő jellemzők:

- 8 teljesen kivethető, teleszkópos, csapágyazott fiók, 882x367 mm:
- 6 fiók, 70 mm magas.
- 2 fiók, 140 mm magas.

88 kg

	Ft	📦	📄
RSC24AXL/8-O	736.800	1	024004281
RSC24AXL/8-R	736.800	1	024004283
RSC24AXL/8-A	736.800	1	024004287



h	max
70 mm	30 kg
140 mm	35 kg

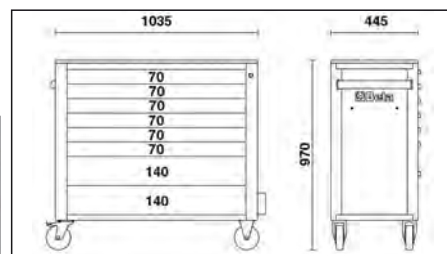
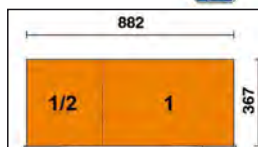

RSC24AXL/9

9 fiókos szerszámkocsi
borulásgátló rendszerrel,
hosszú modell

Fő jellemzők:

- 9 teljesen kivethető, teleszkópos, csapágyazott fiók, 882x367 mm:
- 8 fiók, 70 mm magas
- 1 fiók 140 mm magas.

90 kg

	Ft	📦	📄
RSC24AXL/9-O	783.400	1	024004291
RSC24AXL/9-R	783.400	1	024004293
RSC24AXL/9-A	783.400	1	024004297



h	max
70 mm	30 kg
140 mm	35 kg

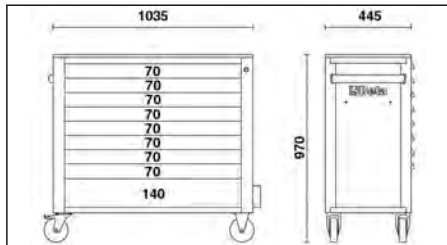
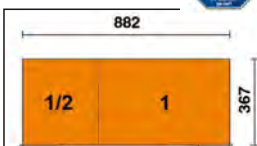

RSC24AXLP/7

7 fiókos szerszámkocsi fa munkalappal és borulásgátló rendszerrel, hosszú modell

Fő jellemzők:

- 7 teljesen kivehető, teleszkópos, csapágyazott fiók, 882x367 mm:
- 5 fiók 70 mm magas
- 1 fiók 140 mm magas
- 1 fiók 210 mm magas
- Rétegelt fa munkalap, furatokkal 1599F/100 vagy 1599GI/100 satu rögzítéséhez (a satut külön kell megrendelni)
- Robosztus nylon előlap beépített címketartóval
- A fiókok habgumival bélelték
- 4 kerék, Ø 125 mm: 2 rögzített és 2 forgókerék (egy kerék fékezhető)
- Központi biztonsági zár elől
- Statikus terhelhetőség: 1.100 kg
- Beépített oldalsó flakontartó (mindkét oldalon alkalmazható)
- Beépített papírtekerstartó
- Mindegyik fiókba 6 EVA habszivacs vagy ABS hőformált tálca helyezhető



105 kg

h	max
70 mm	30 kg
140 mm	35 kg
210 mm	35 kg

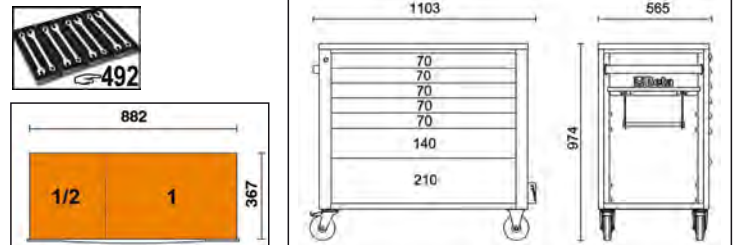
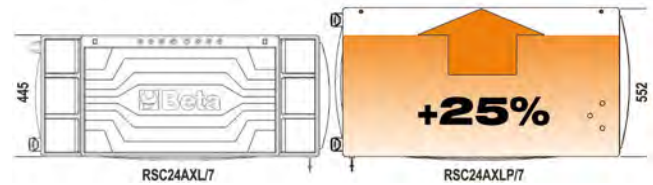

	Ft		
RSC24AXLP/7-O	791.500	1	024004571
RSC24AXLP/7-R	791.500	1	024004573
RSC24AXLP/7-A	791.500	1	024004577

2400 RSC24AXLP/PF

perforált szerszámtartó panel konzolla RSC24AXLP/7, RSC24L, RSC24L-CAB szerszámkocsihoz

50 db horgos GPS készlettel

4,5 kg

	Ft		
2400 RSC24AXLP/PF	55.650	1	024004992



Beta

RSC24AXXL

8 fiókos szerszámköcsi borulásgátló rendszerrel, hosszú modell

Fő jellemzők:

- 1 db teljesen kivehető, teleszkópos, csapágyazott fiók, 1176 mm x 367 mm
- 7 db teljesen kivehető, teleszkópos, csapágyazott fiók, 882 mm x 367 mm:
- 6 db fiók 70 mm magas
- 1 db fiók 140 mm magas
- Rozsdamentes acéllal fedett MDF munkalap, az 1599F/125 vagy 1599GI/125 satu rögzítésére szolgáló furatokkal (külön rendelhető) és 6 tálcával
- Robosztus nylon előlap beépített címketartóval
- A fiókok habgumival bélelték
- Teleszkópos, csapágyazott, zárható, polcos, levehető oldalrekesz
- 4 db kerék, Ø 150 mm: 2 db rögzített és 2 db fékező forgókerék
- 3 db biztonsági zár
- Beépített papírtekercstartó
- Beépített flakonstartó
- Statikus terhelhetőség: 1,100 kg

• A következő tálcákkal bővíthető:
maximum 8 EVA habszivacs vagy ABS hőformált tálca az 1176 mm x 357 mm méretű fiókba
maximum 6 EVA habszivacs vagy ABS hőformált tálca a 882 mm x 367 mm méretű fiókba

1 100
kg

Beta
RSC24



RSC24AXXL/O



h	max
70 mm (1.176x367 mm)	40 kg
70 mm (882x367 mm)	30 kg
140 mm (882x367 mm)	35 kg



RSC24AXXL/R



RSC24AXXL/A

131 kg

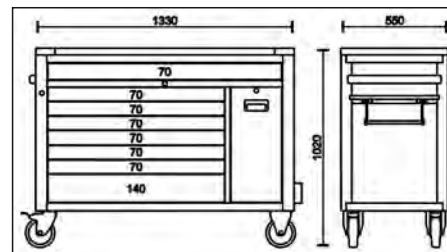
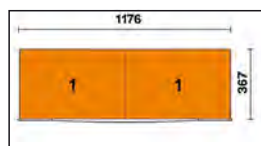

	Ft		
RSC24AXXL-O	979.800	1	024004781
RSC24AXXL-R	979.800	1	024004783
RSC24AXXL-A	979.800	1	024004787

2400 RSC24AXXL/PF

Perforált szerszámtartó panel konzollal RSC24AXXL szerszámköcsihez

3,8 kg



	Ft		
2400 RSC24AXXL/PF	60.100	1	024004998

2400 RSC24AXLP/CPR

hulladéktartály RSC24AXLP/7, RSC24AXXL fiókos szerszámköcsihez

5 kg



	Ft		
2400 RSC24AXLP/CPR	30.550	1	024004993

2400 RSC24AXLP/VL

oldalsó szerszámtálca RSC24, RSC24A, RSC51, RSC24AXLP/7, RSC24AXXL fiókos szerszámokcsihoz

4 kg

2400 RSC24AXLP/VL	Ft		
	23.500	1	024004995



2400 RSC24/PC

papírtekerstartó az RSC24 szerszámokcsihoz RSC24, RSC24A, RSC24AXL, RSC51

0,3 kg

2400 RSC24/PC-A	Ft		
	11.550	1	024004903
2400 RSC24/PC-N	11.550	1	024004904

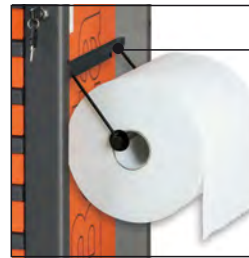

- RAL7016 2400 RSC24/PC-A
- RAL9005 2400 RSC24/PC-N



2400 RSC24/PD

dokumentumtartó az RSC24, RSC24A, RSC24AXL szerszámokcsihoz

1,2 kg

2400 RSC24/PD-A	Ft		
	20.250	1	024004907
2400 RSC24/PD-N	20.250	1	024004908

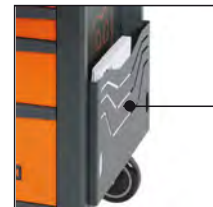

- RAL7016 2400 RSC24/PD-A
- RAL9005 2400 RSC24/PD-N



2400 RSC24/PF

perforált szerszámtartó panel konzolla RSC24, RSC24A, RSC51 szerszámokcsihoz

50 db horgos GPS készlettel

2,3 kg

2400 RSC24/PF	Ft		
	44.550	1	024004902

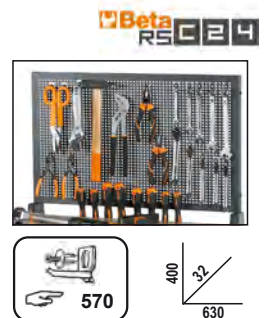

2400 RSC24/PF-

palacktartó az RSC24, RSC24A szerszámokcsihoz, RSC24AXL

0,5 kg

2400 RSC24/PF-A	Ft		
	12.350	1	024004905
2400 RSC24/PF-N	12.350	1	024004906

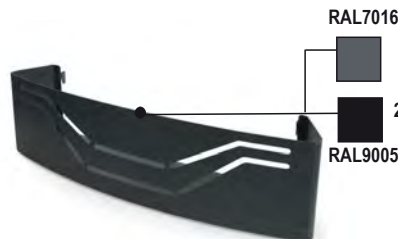

- RAL7016 2400S RSC24/PF-A
- RAL9005 2400S RSC24/PF-N



2400 RSC24/PL

fa munkalap a RSC24, RSC24A, RSC24AXL, RSC51 fiókos szerszámokcsihoz

4,3 kg

2400 RSC24/PL	Ft		
	45.350	1	024004901



2400 RSC24/SPC

számítógép konzol az RSC24, RSC24A, RSC51, RSC24AXLP/7, RSC24AXXL fiókos szerszámkocsihoz

- Kivehető fiók
- Az RSC24AXL modellel nem használható

3,1 kg

2400 RSC24/SPC	Ft	1	024004909
	66.200		



2400 RSC24/MP

lehajtható polc az RSC24, RSC24A, RSC51, RSC24AXLP/7, RSC24AXXL modellel

- Kiegészítő munkalapként használható
- Munkalap méretei: 390x440 mm, olaj- és benzinálló gumi borítással védve
- Terhelési kapacitás: 20 kg

3,4 kg

2400 RSC24/MP	Ft	1	024004900
	34.800		



2499PF

Flakontartó

- Tartozékok a C38, C38A

2,5 kg

2499PF-O	Ft	1	024990210
2499PF-G	33.800	1	024990219
2499PF-R	33.800	1	024990230

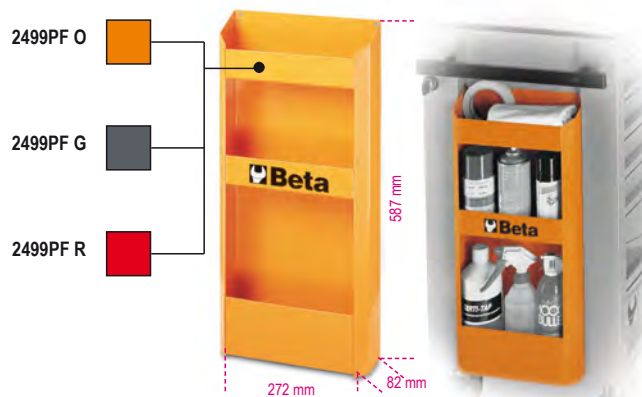

2499PF/M

Univerzális mágneses flakontartó

2,2 kg

2499PF/M	Ft	1	024990050
	30.750		



2499PC

papírtekerstartó

- Felszerelhető a Tank C25 szerszámkocsikra.

2,2 kg

2499PC	Ft	1	024990090
	36.050		



RSC24L/7

7 fiókos
szerszámkocsi
oldalpolccal

Fő jellemzők:

- 7 teleszkópos, csapágyazott fiók (588x367 mm):
5 fiók, 70 mm magas
1 fiók, 140 mm magas
1 fiók 210 mm magas.
- A fiókok habgumival bélelték.
- Négy Ø 125 mm kerék:
- 2 rögzített és 2 fékező forgókerék.
- Központi zár elöl.
- Statikus terhelhetőség: 1 100 kg.
- Rétegelt fa munkalap
- furatokkal a satu rögzítéséhez
(A 1599F/100 - 1599GI/100 satut külön kell megrendelni.)
- Oldalrekesz állítható magasságú polccal.
- Beépített papírtekercstartó.
- Két hátsó flakontartó.
- Beépített oldalsó flakontartó

80 kg

		Ft		
RSC24L/7-O	RAL 2011	742.900	1	024004371
RSC24L/7-R	RAL 3000	742.900	1	024004373
RSC24L/7-A	RAL 7016	742.900	1	024004377

Beta RSC24

1 100 kg



RSC24L/7-A



RSC24L/7-R



RSC24L/7-O

h	max
70 mm	25 kg
140 mm	30 kg
210 mm	30 kg

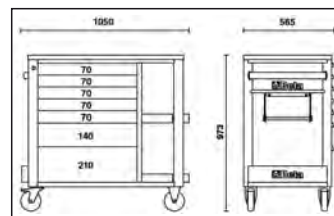
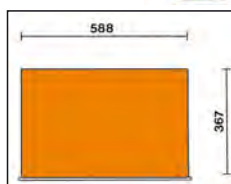

RSC24L-CAB

7 fiókos
szerszámkocsi
szerszámszekrényvel

Fő jellemzők:

- 7 teleszkópos, csapágyazott fiók (588x367 mm):
5 fiók, 70 mm magas
1 fiók, 140 mm magas
1 fiók 210 mm magas.
- A fiókok habgumival bélelték.
- Négy Ø 125 mm kerék:
- 2 rögzített és 2 fékező forgókerék.
- Központi zár elöl.
- Oldalsó szerszámszekrény zárható ajtóval és állítható magasságú belső polccal.
- Statikus terhelhetőség: 1 100 kg.
- Rétegelt fa munkalap
- furatokkal a satu rögzítéséhez
(A 1599F/100 satut külön kell megrendelni.)
- Beépített papírtekercstartó.
- Két hátsó flakontartó.
- Beépített oldalsó flakontartó

82 kg

		Ft		
RSC24L-CAB/O	RAL 2011	769.200	1	024004471
RSC24L-CAB/R	RAL 3000	769.200	1	024004473
RSC24L-CAB/A	RAL 7016	769.200	1	024004477

Beta RSC24

1 100 kg



RSC24L-CAB/A



RSC24L-CAB/R



RSC24L-CAB/O

h	max
70 mm	25 kg
140 mm	30 kg
210 mm	30 kg

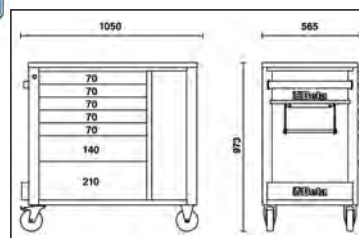
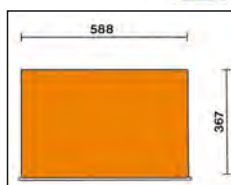

C04TSS-7

7 fiókos szerszámkocsi teljesen rozsdamentes acélból

Nem hagynak nyomot a kerekek.

Főbb jellemzők:

- Hét darab 570 x 410 mm teleszkópos, csapágyazott fiókkal;
- 6 fiók magassága 83 mm;
- 1 fiók magassága 170 mm;
- 4 kerék Ø 125 mm
- 2 rögzített és 2 elfordítható (kettő fékkel)
- Központi zár elől;
- Teljesen rozsdamentes acél szerkezet;
- Kerekek, tartóelemek, csapágyak, fiókbelső és fiókvezetők rozsdamentes acélból;
- Alumínium fiókfogantyúk



700 kg

Beta
INOX
STAINLESS STEEL



63 kg

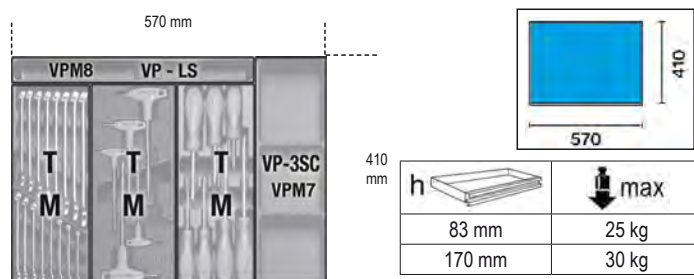

C04TSS/7 Ft 1.234.800 1 024003077 296

C25

Tank polcos szerszámkocsi

Fő jellegzetességek:

- bukófedél
- 1 csúszó tálca
- a szerszámtálca habgumival bélelt
- a polcok olaj- és benzinálló gumival béleltek
- négy 100 mm-es kerék,
- 2 fix és 2 forgó (az egyik fékes)
- biztonsági zár
- hőformált tálca 1/2"-os dugókulcshoz és tartozékhoz, üres (024990104)
- 2499PC papírtekerstartóval kiegészíthető



31,5 kg

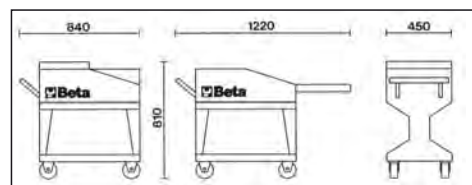

C25 Ft 319.000 1 025000001

C27S

Szerszámkocsi összecsuksukható

Zárható kocsi összecsuksukható vázzal a könnyebb szállítás érdekében

2 teleszkópos fiók, 588x277 mm, mindkét irányban nyitható

Nagy alsó szerszámrekesz 588x277x220 mm

Szerkezet lemezből

2 fix kerék Ø 160 mm és 2 forgó kerék Ø 100 mm (egyik fékes)

termoplasztik munkalap 6 beépített tálcával kis tárgyak elhelyezésére

Központi zár

A fiókokban elválasztók és MC hőformált tálcák a szerszám elhelyezésére

20 kg



C27S-O



C27S-G



C27S-R



h	max
70 mm	20 kg

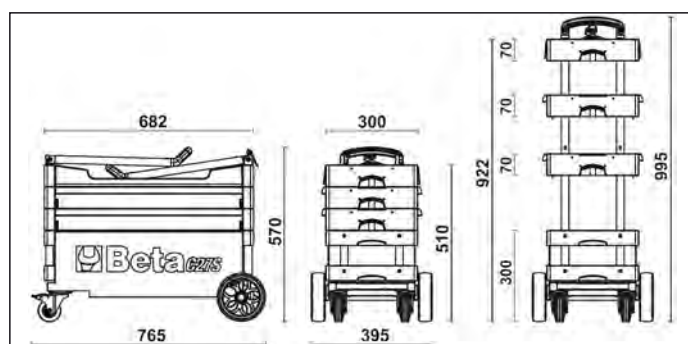
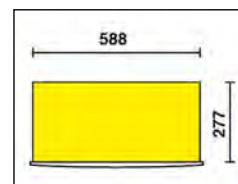

		Ft	🔑	🚚
C27S-O	RAL 2011	357.500	1	027000201
C27S-G	RAL 7016	357.500	1	027000202
C27S-R	RAL 3000	357.500	1	027000203

RSC28

SuperTank szerszámkocsi fa munkalappal és 10 fiókkal

Fő jellemzők:

- 10 teleszkópos, csapágyazott fiók (588x367 mm).
- Gyors és biztos fióknyitás és zárás, a fiók elülső része nylon- és üvegszál.
- 5 oldalsó fiók:
- 4 fiók, 70 mm magas
- 1 fiók 210 mm magas.
- 5 fiók elöl:
- 4 fiók, 70 mm magas
- 1 fiók 210 mm magas.
- A fiókok habgumival béleltek.
- Négy Ø 150 mm kerék:
- 2 rögzített és 2 fékező forgókerék.
- 2 központi biztonsági zár.
- 3 szerszámos fiók elöl.
- Rétegelt fa munkalap
- furatokkal a satu rögzítéséhez
- (A 1599F/150 - 1599GI/150 satut külön kell megrendelni.)
- Beépített szerszámos rekesz.
- Zárható oldalrekesz bukóajtóval.
- Beépített flakontartók.
- 135 mm magas raktér műanyag borítással.
- Statikus terhelhetőség: 1 200 kg.

1200
kg



RSC28-O

130 kg



RSC28-A



RSC28-R



h	max
70 mm	25 kg
210 mm	30 kg

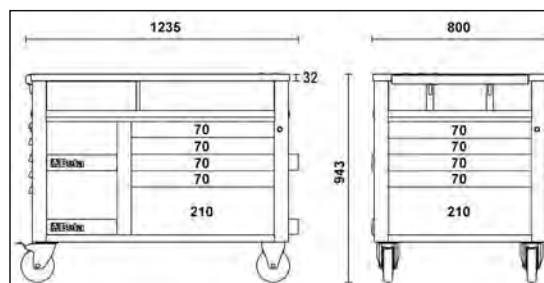
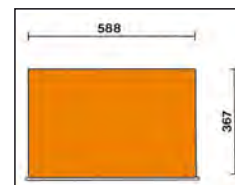

		Ft		
RSC28-O	RAL 2011	1.348.200	1	028003001
RSC28-R	RAL 3000	1.348.200	1	028003003
RSC28-A	RAL 7016	1.348.200	1	028003007

C30M

MaxiTank mobil munkapad

Fő jellemzők:

- 5 teleszkópos, csapágyazott elülső fiók:
- 3 fiók (367x610 mm), 90 mm magas
- 1 fiók (588x610 mm), 90 mm magas
- 1 fiók (588x610 mm), 180 mm magas.
- A fiókok elülső részén alumínium gyorsnyitó rendszer.
- A fiókok habgumival bélelték.
- Hőformált tálcák elhelyezhetők.
- Hidraulikus emelőkar lehetővé teszi a könnyű és praktikus szállítást.
- Négy kerék:
- 2 forgó, elől, Ø 150 mm
- 2 fix, hátul, Ø 170 mm.
- Olajálló gumibetétes munkalap, 1300x800 mm, leeresztő furattal, amely egy kis folyadékgyűjtő tartályhoz csatlakozik.
- Tároló rekesz 720x250x1300 mm, PVC-bevonattal, elől bukóajtóval.
- Központi zár.
- 3 beépített oldalsó flakontartó.
- Beépített papírtekerstartó
- Statikus terhelhetőség: 1 800 kg.
- Multiplex-munkalap (3000 S/PLM) - külön kell megrendelni
- Furatokkal a satu rögzítéséhez 1599F/150 - 1599GI/150 (a satu külön kell megrendelni).

1800
kg



200 kg



h	max
90 mm	30 kg
180 mm	35 kg

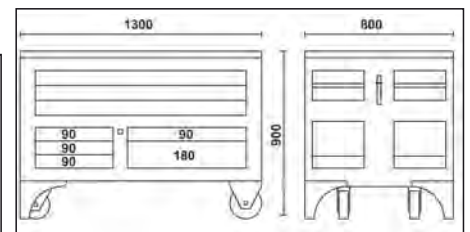
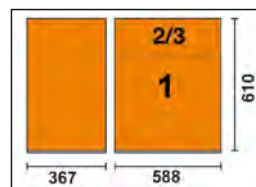

C30M Ft 2.153.800 1 030000300

3000M/PLM

fa munkalap a C30M-hez
furatokkal a satu rögzítéséhez (1599F/150 - 1599GI/150)



1240x740x26 mm

10 kg

3000M/PLM Ft 209.300 1 030000350



C35 IPARI SZERSZÁMSZEKRÉNY



FUNKCIONÁLIS ÉS STRAPABÍRÓ

- Kihúzható fiókok
- Központi biztonsági zár elöl
- Munkalaphoz és fiók elválasztóhoz előkészítve, ezeket külön kell megrendelni
- Statikus terhelhetőség: 1200 kg

Választható modellek:

- C35/6 (6 fiókos)
- C35/7 (7 fiókos)
- C35/8 (8 fiókos)
- C35/9 (9 fiókos)

Választható tartozékok:

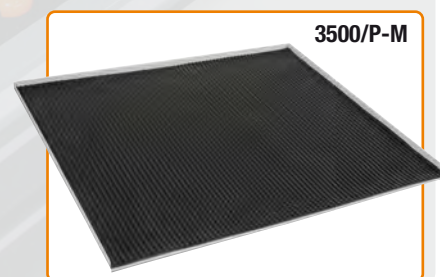

C35/6GM

6 fiókos, ipari, rögzített szerszámszekrény

Fő jellemzők:

- 6 kihúzható fiók (600x447 mm):
 - 2 fiók, 75 mm magas
 - 1 fiók, 100 mm magas
 - 1 fiók, 150 mm magas
 - 1 fiók, 200 mm magas
 - 1 fiók, 300 mm magas
- Központi biztonsági zár elöl
- Munkalaphoz és fiók elválasztóhoz előkészítve, ezeket külön kell megrendelni

75 kg



h	max
75 mm	70 kg
100 mm	70 kg
150 mm	70 kg
200 mm	70 kg
300 mm	70 kg

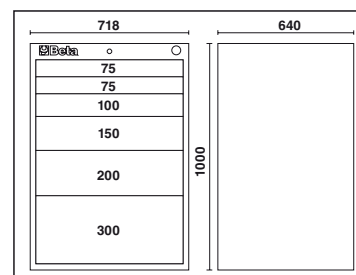
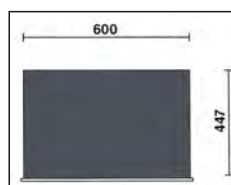

C35/6GM

Ft 868.400 1 035000162

C35/7GM

7 fiókos, ipari, rögzített szerszámszekrény

Fő jellemzők:

- 7 kihúzható fiók (600x447 mm):
 - 2 fiók, 75 mm magas
 - 1 fiók, 100 mm magas
 - 3 fiók, 150 mm magas
 - 1 fiók, 200 mm magas
- Központi biztonsági zár elől
- Munkalaphoz és fiók elválasztókhöz előkészítve, ezeket külön kell megrendelni

82 kg

C35/7GM Ft 906.900 1 035000172



h	max
75 mm	70 kg
100 mm	70 kg
150 mm	70 kg
200 mm	70 kg

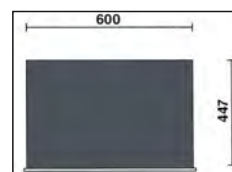

Fiók magasság (mm)	Fiók szélessége (mm)	Fiók mélysége (mm)
75	600	447
75	600	447
100	600	447
150	600	447
150	600	447
150	600	447
200	600	447

C35/8GM

8 fiókos, ipari, rögzített szerszámszekrény

Fő jellemzők:

- 8 kihúzható fiók (600x447 mm):
 - 4 fiók, 75 mm magas
 - 1 fiók, 100 mm magas
 - 2 fiók, 150 mm magas
 - 1 fiók, 200 mm magas
- Központi biztonsági zár elől
- Munkalaphoz és fiók elválasztókhöz előkészítve, ezeket külön kell megrendelni

86 kg

C35/8GM Ft 965.600 1 035000182



h	max
75 mm	70 kg
100 mm	70 kg
150 mm	70 kg
200 mm	70 kg

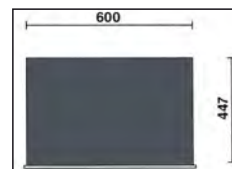

Fiók magasság (mm)	Fiók szélessége (mm)	Fiók mélysége (mm)
75	600	447
75	600	447
75	600	447
75	600	447
100	600	447
150	600	447
150	600	447
200	600	447

C35/9GM

9 fiókos, ipari, rögzített szerszámszekrény

Fő jellemzők:

- 9 kihúzható fiók (600x447 mm):
 - 6 fiók, 75 mm magas
 - 3 fiók, 150 mm magas
- Központi biztonsági zár elől
- Munkalaphoz és fiók elválasztókhöz előkészítve, ezeket külön kell megrendelni

91 kg

C35/9GM Ft 1.012.100 1 035000192



h	max
75 mm	70 kg
150 mm	70 kg

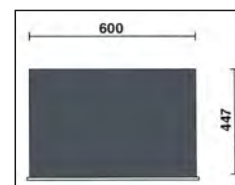

Fiók magasság (mm)	Fiók szélessége (mm)	Fiók mélysége (mm)
75	600	447
75	600	447
75	600	447
75	600	447
75	600	447
75	600	447
150	600	447
150	600	447
150	600	447

3500/P-M

peremes munkalap a C35 szerszámszekrényhez

3500/P-M 700x600 mm Ft 168.800 1 035000505



C37 SZERSZÁMKOCSI

PUHA SAROKVÉDŐ ELEMEK (A SÉRÜLÉSMENTES ÜTKÖZÉS ÉRDEKÉBEN)

- Teleszkópos, csapágyazott fiókok
- Többfunkciós rendkívül ellenálló munkalap
- Alumínium gyorskioldó rendszer a fiók teljes hosszában történő nyitási lehetőséggel
- Szerelék tartó tálcák és csavarhúzóok elhelyezésére szolgáló furatok
- Négy Ø 125 mm kerék: 2 rögzített és 2 forgó kerék (egy kerék fékezhető)
- Statikus terhelhetőség: 1000 kg
- Sarokvédő elemek a szerszámokosi teljes magasságában, hogy nekiütközés esetén elkerülhető legyen a műhelyben tartózkodó jármű sérülése.
- A fiókok habgumival bélelték
- Központi biztonsági zár elöl
- Több helyzetbe állítható beépített oldalsó palacktartó és papírtekerstartó

Választható modellek:

- C37/6 (6 fiókos)
- C37/7 (7 fiókos)
- C37/8 (8 fiókos)

- C37A/7 (7 fiókos szerszámokosi borulásgátló rendszerrel)

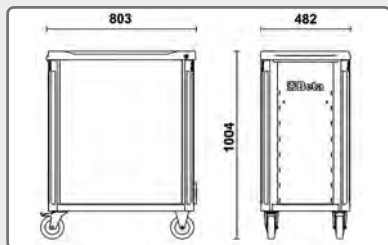
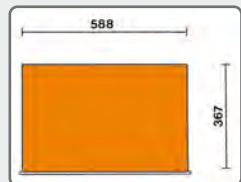

Dostępne kolory:

O	RAL 2011
G	RAL 7016
R	RAL 3000

1000 kg



Választható tartozékok:

3700/PC



3700/PLA



3700/PLL



3700/PF



3700/PFL



C37/7

7 fiókos szerszámokosi

Fő jellemzők:

- 7 fiók (588x367 mm), teleszkópos, csapágyazott:
- 5 fiók 75 mm magas
- 1 fiók 150 mm magas
- 1 fiók 225 mm magas

71 kg

1000 kg



C37/7-O



C37/7-G



C37/7-R



	Ft	☑	📄
C37/7-O	591.100	1	037000071
C37/7-G	591.100	1	037000072
C37/7-R	591.100	1	037000073

h	max
75 mm	30 kg
150 mm	35 kg
225 mm	35 kg

C37/6

6 fiókos szerszámkocsi

Fő jellemzők:

- 6 fiók (588x367 mm), teleszkópos, csapágyazott:
- 4 fiók 75 mm magas
- 1 fiók 150 mm magas
- 1 fiók 305 mm magas

69 kg

	Ft	📦	🏠
C37/6-O	570.900	1	037000061
C37/6-G	570.900	1	037000062
C37/6-R	570.900	1	037000063



C37/6-G



C37/6-R



h	max
75 mm	30 kg
150 mm	35 kg
305 mm	40 kg



C37/8

8 fiókos szerszámkocsi

Fő jellemzők:

- 8 fiók (588x367 mm), teleszkópos, csapágyazott:
- 6 fiók 75 mm magas
- 2 fiók 150 mm magas

73 kg

	Ft	📦	🏠
C37/8-O	613.400	1	037000081
C37/8-G	613.400	1	037000082
C37/8-R	613.400	1	037000083



C37/8-G



C37/8-R



h	max
75 mm	30 kg
150 mm	35 kg



C37A/7

7 fiókos szerszámkocsi
borulásgátló rendszerrel

Fő jellemzők:

- 7 fiók (588x367 mm), teleszkópos, csapágyazott:
- 5 fiók 75 mm magas
- 1 fiók 150 mm magas
- 1 fiók 225 mm magas

71 kg

	Ft	📦	🏠
C37A/7-O	605.300	1	037000271
C37A/7-G	605.300	1	037000272
C37A/7-R	605.300	1	037000273



C37A/7-G



C37A/7-R



h	max
75 mm	30 kg
150 mm	35 kg
225 mm	35 kg



3700/PLA

rozsdamentes acél munkalap a C37, C37A fiókos szerszámkocsihoz

2,8 kg

3700/PLA Ft 34.200 1 037000100



672x396x1,5 mm

3700/PLL

fa munkalap a C37, C37A szerszámkocsihoz

Furatokkal a satu rögzítéséhez (1599P/100, a satut külön kell megrendelni)

3,9 kg

3700/PLL Ft 42.900 1 037000101



672x396x28 mm

3700/PF

perforált panel konzollal a C37, C37A fiókos szerszámkocsihoz

50 db horgos GPS készlettel

3,2 kg

3700/PF Ft 62.350 1 037000102



3700/PFL

perforált oldalpanel a C37, C37A fiókos szerszámkocsihoz

1,9 kg

3700/PFL Ft 18.200 1 037000104

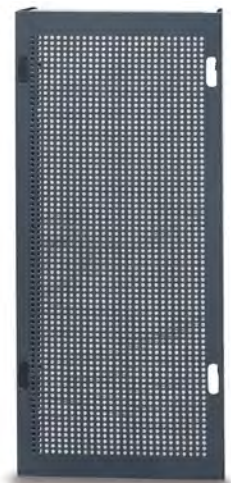

3700/PC

számítógép konzol a C37, C37A fiókos szerszámkocsihoz

3,1 kg

3700/PC Ft 46.550 1 037000103



C39 SZERSZÁMKOCSI

A FÜGGŐLEGES ELEMÉK ÉS A FIÓKOK ELÜLSŐ RÉSE ALUMÍNÍUM ÖTVÖZETBŐL KÉSZÜLT

+ TARTÓSSÁG
+ KÖNNYŰ SÚLY

- Teleszkópos, csapágyazott fiókok
- Hőkezelt munkalap a hordozható C39T szerszámszekrényhez
- Alumínium gyorskioldó rendszer a fiók teljes hosszában történő nyitási lehetőséggel
- Négy Ø 125 mm kerék: 2 rögzített és 2 forgó kerék (egy kerék fékezhető)
- Statikus terhelhetőség: 1200 kg
- A fiókok habgumival bélelték
- Központi biztonsági zár elöl
- Szerelékartó tálcák és csavarhúzó elhelyezésére szolgáló furatok
- Beépített flakontartók oldalt és a hátsó részen
- Beépített papírtekerstartó

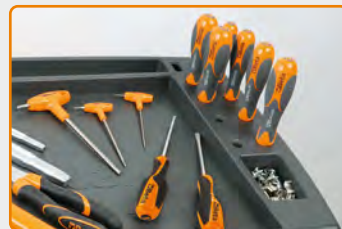

Választható színek:



O	RAL 2011
G	RAL 7016
R	RAL 3000

Választható modellek:

- C39/6 (6 fiókos)
- C39/7 (7 fiókos)
- C39/8 (8 fiókos)

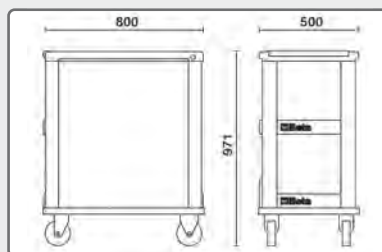
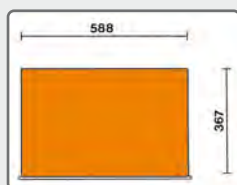

C39/7

7 fiókos szerszámkocsi

Fő jellegzetességek:

- hét teleszkópos, csapágyazott fiók 588x367 mm:
- 5 fiók 70 mm
- 1 fiók 140 mm
- 1 fiók 210 mm

61 kg

1200 kg



C39-7/G



C39-7/R

C39-7/O

h	max
70 mm	30 kg
140 mm	35 kg
210 mm	35 kg



	Ft	☛	☛
C39-7/O	888.700	1	039000001
C39-7/G	888.700	1	039000002
C39-7/R	888.700	1	039000003

C39/6

6 fiókos szerszámkocsi

Fő jellegzetességek:

- 6 teleszkópos, csapágyazott fiók, 588x367 mm:
- 4 fiók 70 mm
- 1 fiók 140 mm
- 1 fiók 280 mm

1200
kg



C39-6/O



C39-6/G



C39-6/R



h	max
70 mm	30 kg
140 mm	35 kg
280 mm	40 kg



59 kg

	Ft		
C39-6/O	842.100	1	039000031
C39-6/G	842.100	1	039000032
C39-6/R	842.100	1	039000033

C39/8

8 fiókos szerszámkocsi

Fő jellegzetességek:

- 8 teleszkópos, csapágyazott fiók, 588x367 mm:
- 6 fiók 70 mm
- 2 fiók 140 mm

1200
kg



C39-8/O



C39-8/G



C39-8/R



h	max
70 mm	30 kg
140 mm	35 kg



64 kg

	Ft		
C39-8/O	949.400	1	039000041
C39-8/G	949.400	1	039000042
C39-8/R	949.400	1	039000043

C39T

4 fiókos szerszámláda

Fő jellegzetességek:

- 4 teleszkópos csapágyazott fiók, 588x257 mm
- 4 fiók 70 mm
- Elöl központi biztonsági zár.
- Fiók teherbírása: 15 kg
- Merevítő és a fiók előlap alumíniumból.



C39T-O



C39T-R



C39T-G



29 kg

h	max
70 mm	30 kg

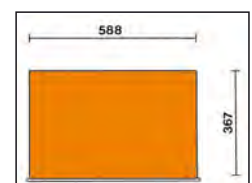
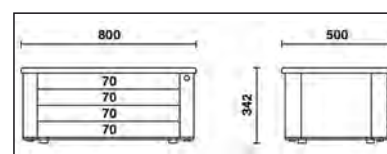

	Ft		
C39T-O	570.900	1	039000101
C39T-G	570.900	1	039000102
C39T-R	570.900	1	039000103

2400-COVER RSC24

nylon takaró a RSC24/RSC24A - C39 fiókos szerszámkocsikhoz



2400-COVER RSC24	Ft	1	024000910
------------------	----	---	-----------

2400-COVER RSC24AXL

nylon takaró a RSC24A-XL, RSC24L, RSC24L-CAB fiókos szerszámkocsikhoz



2400-COVER RSC24AXL	Ft	1	024000930
---------------------	----	---	-----------

Beta

C39SM

Speciális szerszámkocsi Racing SM

Műszaki jellemzők:

- Multiplex munkalap
- 4 kerék Ø 125 mm
- 2 fix és 2 forgó (egyik fékes)
- Statikus teherbírás: 1200 kg

Modul 7 fiókkal

teleszkópos, csapágyazott fiók, 588x367 mm:

- 6 fiók 70 mm
- 1 fiók 240 mm

- A fiókok habgumival bélelték
- Központi zár elől biztonsági zárral
- A fiókokat egyszerre nyitó zárrendszer
- A fiókok előlapja alumínium

Szerviz-modul

- Beépített szeméttartó
- Papírtekerstartó • Egy nagy rakodótér 420x305x270 mm

1200
kg



C39SM-G



C39SM-R



C39SM-O



h	max
70 mm	30 kg
240 mm	40 kg

125 kg

		Ft		
C39SM-O	RAL 2011	1.441.300	1	039390001
C39SM-G	RAL 7016	1.441.300	1	039390002
C39SM-R	RAL 3000	1.441.300	1	039390003

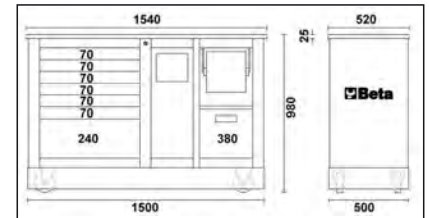
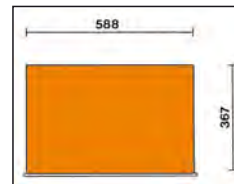

C39MD

Speciális szerszámkocsi Racing MD

Műszaki jellemzők:

- Multiplex munkalap
- 4 kerék Ø 125 mm
- 2 fix és 2 forgó (egyik fékes)
- Statikus teherbírás: 1200 kg

Modul 7 fiókkal

teleszkópos, csapágyazott, 588x367 mm:

- 6 fiók 70 mm
- 1 fiók 240 mm

- A fiókok habgumival bélelték
- Központi zár elől biztonsági zárral
- A fiókokat egyszerre nyitó zárrendszer
- A fiókok előlapja alumínium

Modul 2 fiókkal

teleszkópos, csapágyazott, 588x367x270 mm és 588x367x380 mm

- A fiókok habgumival bélelték
- Központi zár elől biztonsági zárral
- A fiókokat egyszerre nyitó zárrendszer
- A fiókok előlapja alumínium

1200
kg



C39MD-G



C39MD-R



C39MD-O



h	max
70 mm	30 kg
240 mm	40 kg

123 kg

		Ft		
C39MD-O	RAL 2011	1.485.800	1	039390101
C39MD-G	RAL 7016	1.485.800	1	039390102
C39MD-R	RAL 3000	1.485.800	1	039390103

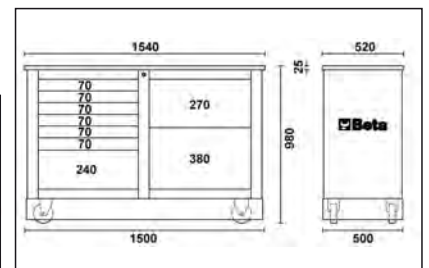
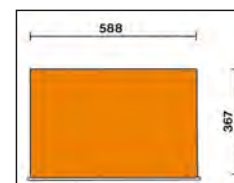

C41S

Két modulós szerszámkocsi

Fő jellegzetességek:

- acéllemezről készült és műanyagborítású: robusztus, könnyű
- 2 elválasztható modul:
 - 1 modul kisláda
 - 1 modul két fiók (1 db 95 mm és 1 db 295 mm magas fiók)
- nagy kerekek (átmérő 160 mm) lépcsőn is könnyen szállítható
- az oldalsó központi zár az alsó modul 2 fiókját zárja
- teleszkópos, csapágyazott fiókok dupla zárókapoccsal
- alumínium teleszkópos fogantyú
- a kisládban beépített műanyagrekeszek kis tárgyak elhelyezésére

Javasolt készletek: 5940/SBK és 5915VU/5

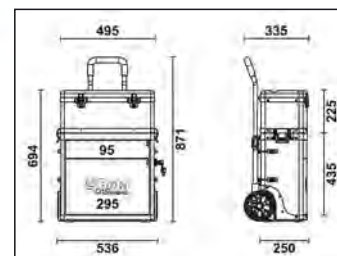
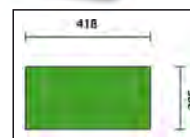

16 kg

C41S Ft 244.900 1 041000001

C41H

Két modulós szerszámkocsi

Fő jellegzetességek:

- acéllemezről készült és műanyagborítású: robusztus, könnyű
- 2 elválasztható modul:
 - 1 felső modul: kisláda
 - 1 alsó modul: 1 db 295 mm magas fiók 1 db 66 mm kihúzható műanyagrekesz 2 db 95 mm magas fiók
- nagy kerekek (átmérő 160 mm) lépcsőn is könnyen szállítható
- az oldalsó központi zár az alsó modul 2 fiókját zárja
- teleszkópos, csapágyazott fiókok dupla zárókapoccsal
- alumínium teleszkópos fogantyú
- a kisládban beépített műanyagrekeszek kis tárgyak elhelyezésére

Javasolt készletek: 5941VU/M, 5940/SBK és 5915VU/5

* Kérésre rendelhető színek



C41H-O



C41H-W

C41H-Y

C41H-R

C41H-V

C41H-B

C41H-G

C41H-N

21 kg

		Ft		
C41H-O	RAL 2011	276.900	1	041000002
C41H-N	RAL 9005	276.900	1	041000005
C41H-B	RAL 5002	276.900	1	041000006
C41H-R	RAL 3000	276.900	1	041000008
C41H-G	RAL 7016	276.900	1	041000010
C41H-Y	RAL 1023	276.900	1	041000012
C41H-W	RAL 9016	276.900	1	041000021
C41H-V	RAL 6016	276.900	1	041000024

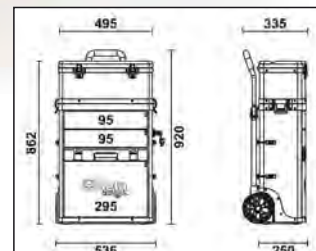
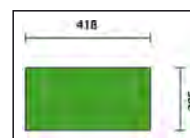

C41H/CE

Kivehető műanyag rekesz kis tárgyak elhelyezésére

1,3 kg

C41H/CE Ft 17.400 1 041000916



C42H

Szerszámkocsi 3 modullal

Fő jellegzetességek:

- Lemezből készült és műanyagborítású: robusztus és könnyű
- 3 elválasztható modul:
 - 1 felső modul, magasság: 220 mm
 - 1 középső modul, magasság: 180 mm
 - 1 alsó modul kerékekkel, magasság: 330 mm
- Nagy átmérőjű kerekek (ø 160 mm)
- 3 pozícióba állítható teleszkópos fogantyú
- Gyorsan szétválasztható modulok: praktikus és jól kezelhető fogantyú a különböző modulokon
- Felső modul belső rekesszel és 3 fedélbe épített rekesz kis tárgyak elhelyezésére
- 2 modullal is használható

Javasolt készletek: 5940/SBK és 5915VU/5

14 kg

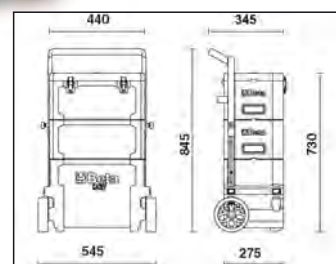

C42H

Ft 196.800 1 042000002



CX49-G

többfunkciós szerszámkocsi

mobil munkaállásként használható
diagnosztikai eszközök, laptopok, teszterek és akkumulátortöltők számára.

JELLEMZŐK

- Festett fémlemez szerkezet: maximális stabilitás és szilárdság
- Ergonomikus fogantyú
- Kétszintes felső rakodópól
- Kihúzható fiók minibillentyűzethez
- 2 állítható helyzetű középső polc és 1 rögzített alsó polc
- 4 hasznos oldalsó műanyag kábeldob
- 2 praktikus oldaldoboz
- 2 rögzített hátsó kerék, Ø 160 mm
- 2 elforgatható első kerék, Ø 100 mm (egyikük fékkel)
- Súly: 36 kg

CX49-G **Ft** 365.200 1 049000102

1099 mm
460 mm
435 mm



CA49-G

többfunkciós szerszámkocsi ajtóval

mobil munkaállásként használható
diagnosztikai eszközök, laptopok, teszterek és akkumulátortöltők számára.

JELLEMZŐK

- Festett fémlemez szerkezet: maximális stabilitás és szilárdság
- Ergonomikus fogantyú
- Kétszintes felső rakodópól
- Kihúzható fiók minibillentyűzethez
- 1 állítható helyzetű polc és 1 rögzített polc és záróajtó
- 4 hasznos oldalsó műanyag kábeldob
- 1 praktikus oldaldoboz
- 2 rögzített hátsó kerék, Ø 160 mm
- 2 elforgatható első kerék, Ø 100 mm (egyikük fékkel)
- Súly: 36,5 kg

CA49-G **Ft** 410.100 1 049000112



1099 mm
460 mm
435 mm

4900-COVER C49

nejlon takaró a C49 többfunkciós szerszámkocsihoz

4900-COVER C49 **Ft** 17.400 1 049000930



Kompakt méretének és sokoldalú felhasználásának köszönhetően a C48M kézikocsi ideális megoldás nehéz terhek (dobozok, tartályok, nagyméretű tárgyak, berendezések) biztonságos szállítására nehezen és hagyományos targoncával nem megközelíthető helyeken.

A motoros rásegítésnek köszönhetően csökken a kézi tehermozgatás jelentette veszélyek, pl. mozgásszervi betegségek kockázata.

24V - 400W motorral, 2x12V 33Ah akkumulátorral és Curtis vezérlőkártyával felszerelt kézikocsi.

Csúszásmentes gumival borított masszív acélból készült plató. A peremen elhelyezkedő csőpanelek megátolják a szállított tárgyak leesését.

A panelek nagyobb darabok szállítására esetén eltávolíthatók.

A vezérlőpanel felszereltsége:

- indítókulcs
- sebességszabályozó
- oldalsó "pillangó" kapcsoló az irányításhoz
- tolatásjelző csipogó hangjelzés
- akkumulátor töltésjelző
- elektromos fék megszakító gomb
- vészleállító gomb

2 pneumatikus hajtókerék (Ø 260 mm), 2 gumi forgókerék (Ø 150 mm), mágnesfék és differenciálmű.

Külső akkumulátortöltővel szállítva, 220V/50Hz - V/A 24/12

FUNKCIONÁLIS SPECIFIKÁCIÓK

Teherbírás: 400 kg

Sebesség: 4-6 km/h (szabályozható)

Akkumulátor üzemidő: 4 óra

Teljes terheléssel megengedett legnagyobb emelkedő: 6%

100 kg terheléssel megengedett legnagyobb emelkedő: 18%

Biztonsági berendezések:

Elektronikus fék

Hangjelző

Zúzódásvédő

Akkumulátor töltésjelző

Curtis vezérlőkártya

MŰSZAKI ADATOK

Külső méret: 1280x630x1100h mm

Plató hasznos rakfelülete panelekkel: 1180x580 mm

Plató hasznos rakfelülete panelek nélkül: 1260x620 mm

Plató magassága: 320 mm

Akkumulátortartó magassága: 65 mm

Tömeg akkumulátorral: 140 kg

400
kg



140 kg

C48P

összecsukható szerszámkocsi

Fő jellemzők:

- Erősített polipropilénből (PP) készült rakodófelület csúszásálló bevonattal és TPV betétekkel védett sarkakkal
- Betölthető fogantyú a gyors, kompakt tárolásért
- Négy, nyomot nem hagyó kerék, Ø 125 mm: 2 rögzített és 2 fékezhető forgókerék
- Maximális teherbírás: 300 kg.
- Rakodófelület munkaszélessége: 705 mm
- Rakodófelület mélysége: 480 mm
- Rakodófelület magassága: 200 mm



11 kg

C48P Ft 125.100 1 048000030

C51

Kisegítő szerszámkocsi

- 3 csúszásmentes bordás gumival borított munkalap
- Ergonómikus fogantyú
- Két állásban rögzíthető középső munkalap
- 4 kerék Ø 100 mm: 2 fix és 2 forgó kerék (az egyik fékes)
- Maximális terhelhetőség: 240 kg

21 kg

		Ft		
C51 O	RAL 2011	139.300	1	051000001
C51 G	RAL 7016	139.300	1	051000002
C51 R	RAL 3000	139.300	1	051000003



200 kg

- C51 O
- C51 G
- C51 R

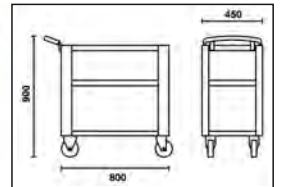

Beta



RSC51

3 fiókos szerszámkocsi

Fő jellemzők:

- ABS erősítésű, stabil, robusztus munkalap
- Univerzális munkalap legurulásálló peremmel és nyolc csavarhúzó tartó lyukkal
- 3 teleszkópos, csapágyazott fiók (588x367 mm), 70 mm magas
- A fiókok habgumival bélelték
- Mindegyik fiókba 4 EVA habszivacs vagy ABS hőformált tálca helyezhető
- Központi biztonsági zár elöl
- Praktikus oldalsó csavarhúzó tartó
- Két oldalsó beépített spray flakon tartó
- Nagy alsó polc olaj- és benzinálló gumi borítással
- 4 kerék, Ø 125 mm: 2 rögzített kerék és 2 forgókerék (egy kerék fékeezhető)

- Statikus terhelhetőség: 400 kg
- Egyes fiókok teherbírása: 15 kg, egyenletesen elosztva



RSC51-R



RSC51-A

RSC51-FO

38 kg



h	max
70 mm	15 kg

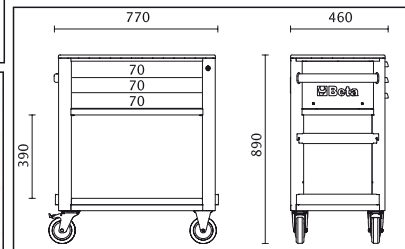
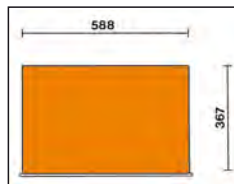

		Ft		
RSC51-FO	RAL 2011 - 7016	278.500	1	051000300
RSC51-R	RAL 3000 - 7016	278.500	1	051000303
RSC51-A	RAL 7016	278.500	1	051000307

2400 RSC24/MP

lehajtható polc az RSC24, RSC24A, RSC51, RSC24AXLP/7, RSC24AXXL modellhez

- Kiegészítő munkalapként használható
- Munkalap méretei: 390x440 mm, olaj- és benzinálló gumi borítással védve
- Terhelési kapacitás: 20 kg

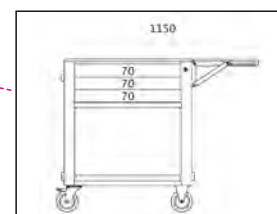
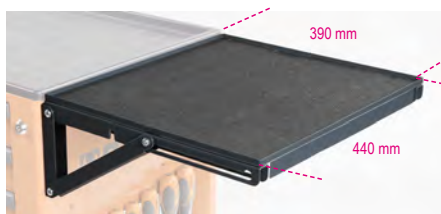

3,4 kg

		Ft		
2400 RSC24/MP		34.800	1	024004900



Beta

CP51

nagyszilárdságú szerszámkocsi

- 2 gumiszőnyeggel fedett rakodópól
- Ergonomikus fogantyú
- Négy 125 Ø nagyszilárdságú kerék
2 rögzített, 2 elfordítható fékkel
- Statikus terhelhetőség: 750 kg. (2 polcon elosztva)

37 kg

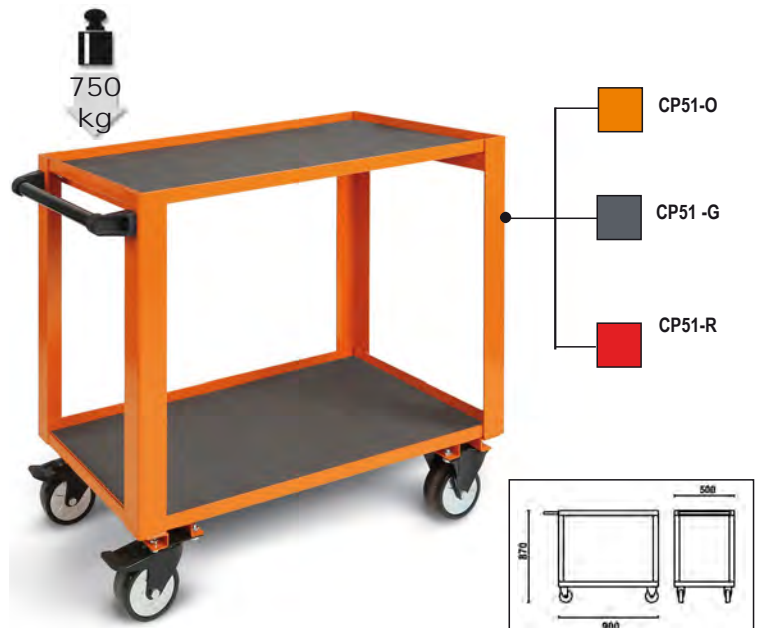

		Ft		
CP51 O	RAL 2011	184.200	1	051000501
CP51 G	RAL 7016	184.200	1	051000502
CP51 R	RAL 3000	184.200	1	051000503

CB52

sebességváltó/erőátvitel tartókocsi
folyadékgyűjtővel

A döntött sík és a lefolyólyukak
lehetővé teszik a folyadékok gyűjtését
közvetlenül a gyűjtőtálcába

A következőket tartalmazza:

- 4 elforduló kerék, kettő fékkel
- szerszámfiók
- 7 literes kihúzható folyadékgyűjtő tálca
- 2 polc

Méreték: 1200x640x870 mm

Súly: 60 Kg

60 kg



		Ft		
CB52-O		352.200	1	052000201

C56P 0

összecsukható munkapad

Kompakt és könnyen szállítható.
Mindkét oldalán használható 30 mm vastag 800x500mm méretű MDF és horganyzott lemez munkalap.
Gumival védett fogantyú a hatékony szállítás érdekében.
Csúszásgátló burkolattal rendelkező lábak.
Statikus terhelhetőség: 250 kg

25 kg

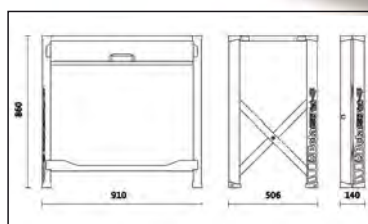

C56P 0 Ft 194.300 1 056000011

C56PL 0

összecsukható munkapad, könnyű kivitel

Könnyű, kompakt, könnyen szállítható.
Horganyzott lemez munkalap (800x500mm), munkaoldalán olaj- és benzinálló gumiborítással.
Gumival védett fogantyú a hatékony szállítás érdekében.
Csúszásgátló burkolattal rendelkező lábak.
Statikus terhelhetőség: 200 kg

18,5 kg

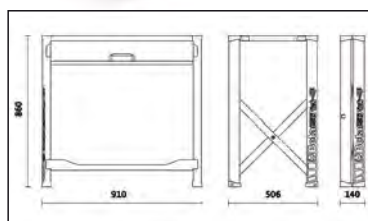

C56PL 0 Ft 168.000 1 056000021

C54S

Cargo szerszámszekrények

Ezeknek a szerszámszekrényeknek a tervezése alapos kutatás alapján történt, és ezért a végfelhasználók számára pontos, kényelmes és ésszerű megoldást kínálnak.

Az ajtókhöz illeszkedő két perforált lemezajtó nyitható, ezáltal további tárolóterhez jutunk.

Fő jellegzetességek:

- 1 fiók egyszerű szerszámrendezés a felhasználó igényei szerint
- könnyen falra szerelhető két horony segítségével, melyek a szerszámszekrény hátulján található, vagy két csavarral felerősíthető a C50 Team szekrénytartó kocsira
- biztonsági zár a fiók és az ajtók bezárásához
- a VI és VG modelleknek eltérő szerszámtartó készlete van
- hőformált tálca 1/2"-os dugókulcshoz és tartozékhoz, üres



C54S-O

37 kg

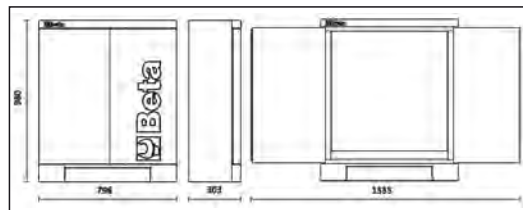
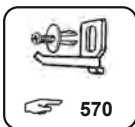

C54S-O

Ft 351.800 1 054000301

Beta

C57SA

MasterCargo munkapad

• Ez a modell szerszámtartó fallal (C57P) és egy fiókos blokkal készült.

A fiókos blokk:

5 fiók teleszkópos és csapágyazott 588x367 mm 3 fiók 90 mm

1 fiók 180 mm

1 fiók 280 mm.

A fiókokban hőformált tálcák

Központi zár

Szerszámtartó fal furattal, hogy

a falra is lehessen szerelni.

Alumíniumredőny, függőlegesen

manőverezhető, biztonsági zárral.

Három kivehető perforált szerszámtartó lemez

Multiplex munkalap,

laminált rétegelt, három furattal,

1599F/150 - 1599GI/150 satu rögzítéséhez

(külön kell megrendelni).



C57SA-O

205 kg



C57SA-G

C57SA-R

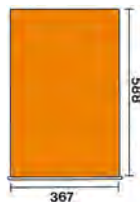

h	max
90 mm	30 kg
180 mm	40 kg
280 mm	40 kg

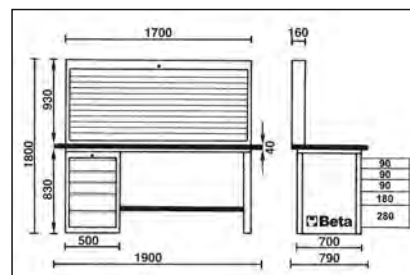

		Ft		
C57SA-O	RAL 2011	2.210.500	1	057001005
C57SA-G	RAL 7016	2.210.500	1	057001205
C57SA-R	RAL 3000	2.210.500	1	057001405

C57SD

MasterCargo munkapad

• Ez a modell egy fiókos blokkal készült

A fiókos blokk:

5 fiók teleszkópos és csapágyazott 588x367 mm 3 fiók 90 mm

1 fiók 180 mm

1 fiók 280 mm.

A fiókokban hőformált tálcák

Központi zár

Multiplex munkalap,

laminált rétegelt, három furattal,

1599F/150 - 1599GI/150 satu rögzítéséhez

(külön kell megrendelni).



C57SD-O

158 kg

h	max
90 mm	30 kg
180 mm	40 kg
280 mm	40 kg

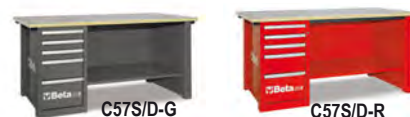

C57SD-G

C57SD-R

		Ft		
C57SD-O	RAL 2011	1.560.700	1	057001004
C57SD-G	RAL 7016	1.560.700	1	057001204
C57SD-R	RAL 3000	1.560.700	1	057001404

C57SB

MasterCargo munkapad

• Ez a modell szerszámtartó fallal (C57P) és két fiókos blokkal készült.

A fiókos blokk:

5 fiók teleszkópos és csapágyazott 588x367 mm 3 fiók 90 mm

1 fiók 180 mm

1 fiók 280 mm.

A fiókokban hőformált tálcák

Központi zár

Szerszámtartó fal furattal, hogy

a falra is lehessen szerelni.

Alumíniumredőny, függőlegesen

manőverezhető, biztonsági zárral.

Három kivehető perforált szerszámtartó lemez

Multiplex munkalap,

laminált rétegelt, három furattal,

1599F/150 - 1599GI/150 satu rögzítéséhez

(külön kell megrendelni).



C57S/B-O

243 kg



C57S/B-G



C57S/B-R



h	max
90 mm	30 kg
180 mm	40 kg
280 mm	40 kg

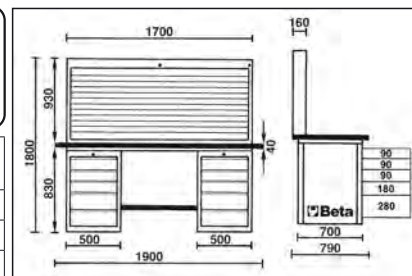

		Ft		
C57S/B-O	RAL 2011	2.754.700	1	057001006
C57S/B-G	RAL 7016	2.754.700	1	057001206
C57S/B-R	RAL 3000	2.754.700	1	057001406

C57SC

MasterCargo munkapad

• Ez a modell két fiókos blokkal készült

A fiókos blokk:

5 fiók teleszkópos és csapágyazott 588x367 mm 3 fiók 90 mm

1 fiók 180 mm

1 fiók 280 mm.

A fiókokban hőformált tálcák

Központi zár

Multiplex munkalap,

laminált rétegelt, három furattal,

1599F/150 - 1599GI/150 satu rögzítéséhez

(külön kell megrendelni).



C57S/C-O

196 kg



h	max
90 mm	30 kg
180 mm	40 kg
280 mm	40 kg



C57S/C-G



C57S/C-R

		Ft		
C57S/C-O	RAL 2011	2.104.900	1	057001003
C57S/C-G	RAL 7016	2.104.900	1	057001203
C57S/C-R	RAL 3000	2.104.900	1	057001403

C57SP

Szerszámtartó fal

Szerszámtartó fal hátulján két furattal, hogy falra is lehessen szerelni. Biztonsági zárral ellátott alumínium redőny, három kivehető perforált szerszámtartó lemez

60 kg

		Ft		
C57SP-O	RAL 2011	649.800	1	057001020
C57SP-G	RAL 7016	649.800	1	057001220
C57SP-R	RAL 3000	649.800	1	057001420



C57SP G

C57SP R

5700LAMP

MasterCargo munkapad-lámpa

erőteljes fémlemezkeret, amelyet a munkapad lapjához kell lámpatartó 1120 Lumen LED-es szalaggal, 4000K, 14W feszültség: 230V vezeték nélkül szállítva

9 kg

	Ft		
5700LAMP	160.300	1	057000005

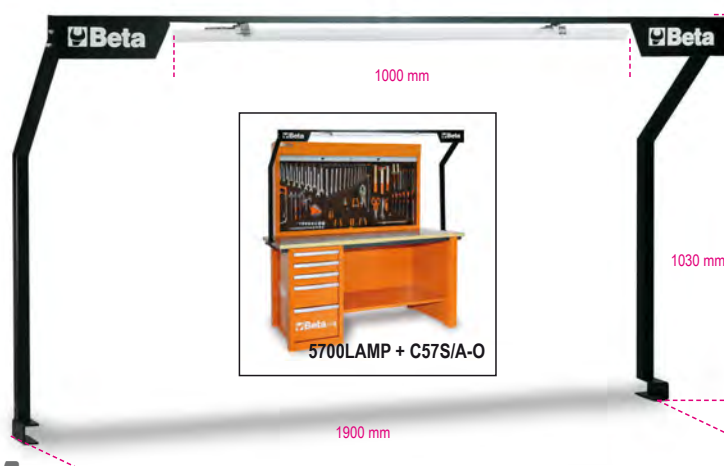

C58P

szerszámtartó fal

Szerszámtartó fal hátulján két furattal, hogy falra is lehessen szerelni. Festett alumínium redőny biztonsági zárral. Két kivehető lyukacsos szerszámtartó panel.

47,5 kg

		Ft		
C58P-O	RAL 2011	493.900	1	058000221
C58P-G	RAL 7016	493.900	1	058000222
C58P-R	RAL 3000	493.900	1	058000223



C58P-G



C58P-R



1360 mm

C58P-O

PV

Szerszámtartó fal

	LxA mm		Ft		
PV1	1000x920	10,2	92.100	1	088880010
PV1,5	1500x920	14,2	121.900	1	088880015

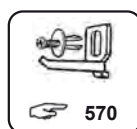



MODULÁRIS MUNKAASZTALOK

A Beta új MODULÁRIS munkasztal termékcsaládja lehetővé teszi a szakemberek számára, hogy egyéni igényeiknek megfelelően alakítsák ki munkahelyüket.

A termékcsalád előre összeállított kombinációk széles választékában érhető el, de a konfiguráció teljes mértékben testre szabható, beleértve a munkalapokat, lábakat, szerszámkocsikat, szerszámsekrényeket, szerszámotartó falrendszereket és tartozékokat.

A 75 cm mély munkalap nagy, kényelmes és praktikus munkafelületet biztosít, amelyre satu is szerelhető, lehetővé téve a nagy igénybevételű jelentő munkák elvégzését.

Az új MODULÁRIS termékcsaládot a legújabb ergonomiai tanulmányok alapján tervezték, és a Beta termékek jól ismert robusztusságával és minőségével rendelkezik, így nélkülözhetetlen partner a munkában.

Konfigurálja saját műhelyét



látogasson el a www.beta-tools.com



SZERSZÁMTÁROLÓ



SZERSZÁMTARTÓ PANEL



MUNKALAP



LÁB

C58BC-W1,6

Egyszerű fa munkalapos munkapad, 1,6 m széles

Fő jellemzők:

- Rétegelt fa munkalap (1600 mm x 750 mm), 38 mm vastag
- Acélszerkezet 4 tartólábbal
- Furatokkal a satu rögzítéséhez (1599F/150 - 1599GI/150, a satu külön rendelhető)
- Alsó keskeny tárolópolc, 288 mm x 335 mm; vastagság: 40 mm
- Padlóhoz rögzíthető
- Statikus terhelhetőség: 1000 kg, egyenletesen elosztva

A következő kiegészítőkkel bővíthető:

- Perforált oldalpanel, C58PFL
- Legurulásgátló perem, 1600 mm, C58BAC 1.6

61 kg

1000 kg

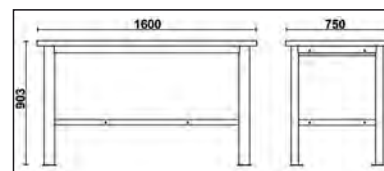

C58BC-W1,6

Ft 262.300 1 058000601

C58BC-X1,6

Egyszerű rozsdamentes acéllal fedett MDF munkalapos munkapad, 1,6 m széles

Fő jellemzők:

- Rozsdamentes acéllal fedett MDF munkalap (1600 mm x 750 mm), 38 mm vastag
- Acélszerkezet 4 tartólábbal
- Furatokkal a satu rögzítéséhez (1599F/150 - 1599GI/150, a satu külön rendelhető)
- Alsó keskeny tárolópolc, 1288 mm x 335 mm; vastagság: 40 mm
- Padlóhoz rögzíthető
- Statikus terhelhetőség: 1000 kg, egyenletesen elosztva

A következő kiegészítőkkel bővíthető:

- Perforált oldalpanel, C58PFL
- Legurulásgátló perem, 1600 mm, C58BAC 1.6

📦 74 kg

1000
kg

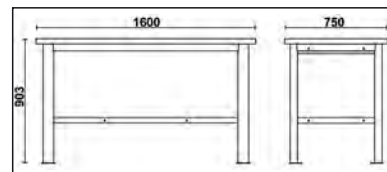

C58BC-X1,6

Ft 276.500 1 058000606

C58BC-W1,6 2C

2 fiókos, fa munkalapos munkapad, 1,6 m széles

Fő jellemzők:

- Rétegelt fa munkalap (1600 mm x 750 mm), 38 mm vastag
- 2 db teleszkópos, csapágyazott fiók (367 mm x 588 mm):
 - 1 db fiók 70 mm magas
 - 1 db fiók 140 mm magas
- A fiókok habgumival béleltek
- Mindegyik fiókba 4 EVA habszivacs vagy ABS hőformált tálca helyezhető
- Központi zár elöl
- Acélszerkezet 4 db tartólábbal
- Furatokkal a satu rögzítéséhez (1599F/150 - 1599GI/150, a satu külön rendelhető)
- Alsó keskeny tárolópolc, 1288 mm x 335 mm, vastagság: 40 mm
- Padlóhoz rögzíthető
- Statikus terhelhetőség: 1000 kg, egyenletesen elosztva

A következő kiegészítőkkel bővíthető:

- Perforált oldalpanel, C58PFL
- Legurulásgátló perem, 1600 mm, C58BAC 1.6

📦 103,5 kg

1000
kg



C58BC-W1,6 2C/O



C58BC-W1,6 2C/A

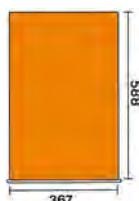

h	max
70 mm	25 kg
140 mm	30 kg

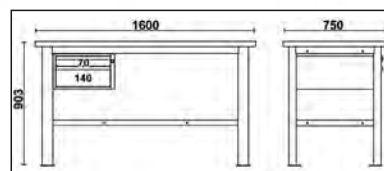

C58BC-W1,6 2C/O

Ft 380.600 1 058000611

C58BC-W1,6 2C/A

Ft 380.600 1 058000613

C58BC-W1,6 4C

4 fiókos, fa munkalapos munkapad, 1,6 m széles

Fő jellemzők:

- Rétegelt fa munkalap (1600 mm x 750 mm), 38 mm vastag
- 4 db teleszkópos, csapágyazott fiók (367 mm x 588 mm):
1 db fiók 210 mm magas
3 db fiók 70 mm magas
- A fiókok habgumival béleltek
- Mindegyik fiókba 4 EVA habszivacs vagy ABS hőformált tálca helyezhető
- Központi zár elöl
- Acélszerkezet 4 db tartólábbal
- Furatokkal a satu rögzítéséhez (1599F/150 - 1599GI/150, a satu külön rendelhető)
- Alsó keskeny tárolópolc, 1288 mm x 335 mm, vastagság: 40 mm
- Padlóhoz rögzíthető
- Statikus terhelhetőség: 1000 kg, egyenletesen elosztva

A következő kiegészítőkkel bővíthető:

- Perforált oldalpanel, C58PFL
- Legurulásgátló perem, 1600 mm, C58BAC 1.6

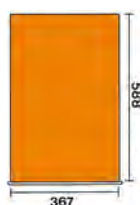

h	max
70 mm	25 kg
210 mm	30 kg

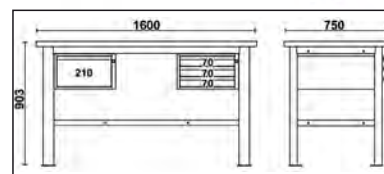

82 kg

	Ft		
C58BC-W1,6 4C/O	505.300	1	058000612
C58BC-W1,6 4C/A	505.300	1	058000614

C58BC-W2,1

Egyszerű fa munkalapos munkapad, 2,1 m széles

Fő jellemzők:

- Rétegelt fa munkalap (2100 mm x 750 mm), 38 mm vastag
- Acélszerkezet 4 db tartólábbal
- Furatokkal a satu rögzítéséhez (1599F/150 - 1599GI/150, a satu külön rendelhető)
- Alsó keskeny tárolópolc, 1788 mm x 335 mm; vastagság: 40 mm
- Padlóhoz rögzíthető
- Statikus terhelhetőség: 800 kg, egyenletesen elosztva

A következő kiegészítőkkel bővíthető:

- Perforált oldalpanel, C58PFL
- Legurulásgátló perem, 2100 mm, C58BAC 2.1

70 kg

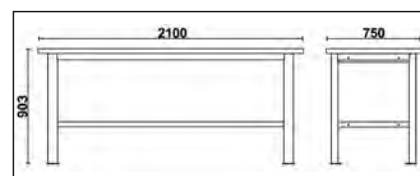

	Ft		
C58BC-W2,1	310.300	1	058000621

C58BC-X2,1

Egyszerű rozsdamentes acéllal fedett MDF munkalapos munkapad, 2,1 m széles

Fő jellemzők:

- Rozsdamentes acéllal fedett MDF munkalap (2100 mm x 750 mm), 38 mm vastag
- Acélszerkezet 4 tartólábbal
- Furatokkal a satu rögzítéséhez (1599F/150 - 1599GI/150, a satu külön rendelhető)
- Alsó keskeny tárolópolc, 1788 mm x 335 mm; vastagság: 40 mm
- Padlóhoz rögzíthető
- Statikus terhelhetőség: 1000 kg, egyenletesen elosztva

A következő kiegészítőkkel bővíthető:

- Perforált oldalpanel, C58PFL
- Legurulásgátló perem, 2100 mm, C58BAC 2.1

93 kg

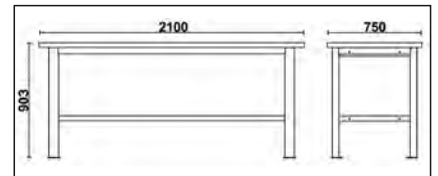

C58BC-X2,1 Ft 323.700 1 058000626

C58BC-W2,1 2C

2 fiókos, fa munkalapos munkapad, 2,1 m széles

Fő jellemzők:

- Rétegelt fa munkalap (2100 mm x 750 mm), 38 mm vastag
- 2 db teleszkópos, csapágyazott fiók (367 mm x 588 mm):
 - 1 db fiók 70 mm magas
 - 1 db fiók 140 mm magas
- A fiókok habgumival béleltek
- Mindegyik fiókba 4 EVA habszivacs vagy ABS hőformált tálca helyezhető
- Központi zár elöl
- Acélszerkezet 4 db tartólábbal
- Furatokkal a satu rögzítéséhez (1599F/150 - 1599GI/150, a satu külön rendelhető)
- Alsó keskeny tárolópolc, 1788 mm x 335 mm, vastagság: 40 mm
- Padlóhoz rögzíthető
- Statikus terhelhetőség: 800 kg, egyenletesen elosztva

A következő kiegészítőkkel bővíthető:

- Perforált oldalpanel, C58PFL
- Legurulásgátló perem, 2100 mm, C58BAC 2.1

91 kg



RAL 2011

C58BC-W2,1 2C/O



RAL 7016

C58BC-W2,1 2C/A

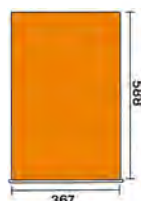

h	max
70 mm	25 kg
140 mm	30 kg

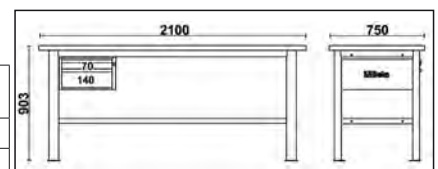

C58BC-W2,1 2C/O Ft 428.500 1 058000631
C58BC-W2,1 2C/A Ft 428.500 1 058000636

C58BC-W2,1 4C

4 fiókos, fa munkalapos munkapad, 2,1 m széles

Fő jellemzők:

- Rétegelt fa munkalap (2100 mm x 750 mm), 38 mm vastag
- 4 db teleszkópos, csapágyazott fiók (367 mm x 588 mm):
2 db fiók 70 mm magas
2 db fiók 140 mm magas
- A fiókok habgumival béleltek
- Mindegyik fiókba 4 EVA habszivacs vagy ABS hőformált tálca helyezhető
- Központi zár elöl
- Acélszerkezet 4 db tartólábbal
- Furatokkal a satu rögzítéséhez (1599F/150 - 1599GI/150, a satu külön rendelhető)
- 2 db alsó keskeny tárolópolc, 1788 mm x 335 mm, vastagság: 40 mm
- Statikus terhelhetőség: 800 kg, egyenletesen elosztva
- Padlóhoz rögzíthető

A következő kiegészítőkkel bővíthető:

- Perforált oldalpanel, C58PFL
- Legurulásgátló perem, 2100 mm, C58BAC 2.1

118 kg

	Ft	📦	🚚
C58BC-W2,1 4C/O	545.700	1	058000632
C58BC-W2,1 4C/A	545.700	1	058000637

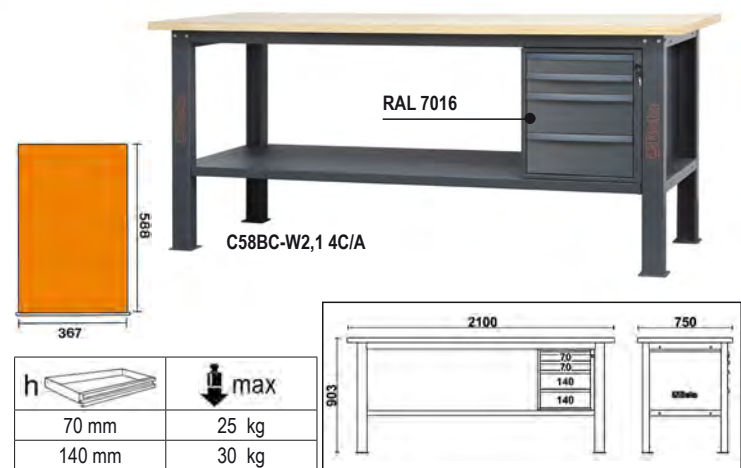

C58BC-W2,1 4CA

Fa munkalapos munkapad, 2,1 m széles, 4 fiókkal és ajtós modulal

Fő jellemzők:

- Rétegelt fa munkalap (2100 mm x 750 mm), 38 mm vastag
- 4 db teleszkópos, csapágyazott fiók (367 mm x 588 mm):
2 db fiók 70 mm magas
2 db fiók 140 mm magas
- A fiókok habgumival béleltek
- Mindegyik fiókba 4 EVA habszivacs vagy ABS hőformált tálca helyezhető
- Központi zár elöl
- 1 db zárható ajtós modul
- Acélszerkezet 4 db tartólábbal
- Furatokkal a satu rögzítéséhez (1599F/150 - 1599GI/150, a satu külön rendelhető)
- 2 db alsó keskeny tárolópolc, 1788 mm x 335 mm, vastagság: 40 mm
- Statikus terhelhetőség: 800 kg, egyenletesen elosztva
- Padlóhoz rögzíthető

A következő kiegészítőkkel bővíthető:

- Perforált oldalpanel, C58PFL
- Legurulásgátló perem, 2100 mm, C58BAC 2.1

133 kg

	Ft	📦	🚚
C58BC-W2,1 4CA/O	638.900	1	058000633
C58BC-W2,1 4CA/A	638.900	1	058000638



C58BC-W2,1 6CA

Fa munkalapos munkapad, 2,1 m széles, 6 fiókkal és ajtós modulal

Fő jellemzők:

- Rétegelt fa munkalap (2100 mm x 750 mm), 38 mm vastag
- 6 db teleszkópos, csapágyazott fiók (367 mm x 588 mm):
1 db fiók 210 mm magas
4 db fiók 70 mm magas
1 db fiók 140 mm magas
- A fiókok habgumival bélelték
- Mindegyik fiókba 4 EVA habszivacs vagy ABS hőformált tálca helyezhető
- Központi zár elöl
- 1 db zárható ajtós modul
- Acélszerkezet 4 db tartólábbal
- Furatokkal a satu rögzítéséhez (1599F/150 - 1599GI/150, a satu külön rendelhető)
- 2 db alsó keskeny tárolópolc, 1788 mm x 335 mm, vastagság: 40 mm
- Statikus terhelhetőség: 800 kg, egyenletesen elosztva
- Padlóhoz rögzíthető

A következő kiegészítőkkel bővíthető:

- Perforált oldalpanel, C58PFL
- Legurulásgátló perem, 2100 mm, C58BAC 2.1

162 kg

	Ft	1	058000634
C58BC-W2,1 6CA/O	816.600	1	058000634
C58BC-W2,1 6CA/A	816.600	1	058000639

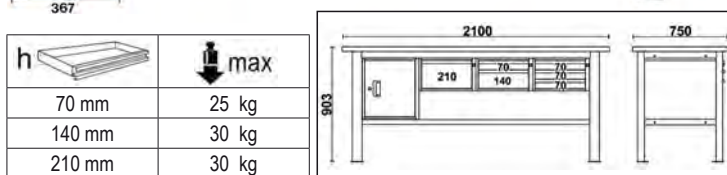

C58BC-W2,1 8CA

Fa munkalapos munkapad, 2,1 m széles, 8 fiókkal és ajtós modulal

Fő jellemzők:

- Rétegelt fa munkalap (2100 mm x 750 mm), 38 mm vastag
- 8 db teleszkópos, csapágyazott fiók (367 mm x 588 mm):
5 db fiók 70 mm magas
2 db fiók 140 mm magas
1 db fiók 210 mm magas
- A fiókok habgumival bélelték
- Mindegyik fiókba 4 EVA habszivacs vagy ABS hőformált tálca helyezhető
- Központi zár elöl
- 1 db zárható ajtós modul
- Acélszerkezet 4 db tartólábbal
- Furatokkal a satu rögzítéséhez (1599F/150 - 1599GI/150, a satu külön rendelhető)
- 2 db alsó keskeny tárolópolc, 1788 mm x 335 mm, vastagság: 40 mm
- Statikus terhelhetőség: 800 kg, egyenletesen elosztva
- Padlóhoz rögzíthető

A következő kiegészítőkkel bővíthető:

- Perforált oldalpanel, C58PFL
- Legurulásgátló perem, 2100 mm, C58BAC 2.1

174 kg

	Ft	1	058000635
C58BC-W2,1 8CA/O	878.900	1	058000635
C58BC-W2,1 8CA/A	878.900	1	058000640

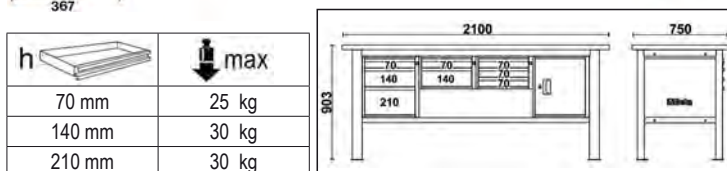

C58BC-X2,1 4C

Rozsdamentes acéllal fedett MDF munkalapos munkapad, 2,1 m széles, 4 fiókkal

Fő jellemzők:

- Rozsdamentes acéllal fedett MDF munkalap (2100 mm x 750 mm), 38 mm vastag
- 4 db teleszkópos, csapágyazott fiók (367 mm x 588 mm):
2 db fiók 70 mm magas
2 db fiók 140 mm magas
- A fiókok habgumival béleltek
- Mindegyik fiókba 4 EVA habszivacs vagy ABS hőformált tálca helyezhető
- Központi zár elöl
- Acélszerkezet 4 db tartólábbal
- Furatokkal a satu rögzítéséhez (1599F/150 - 1599GI/150, a satu külön rendelhető)
- 2 db alsó keskeny tárolópolec, 1788 mm x 335 mm, vastagság: 40 mm
- Statikus terhelhetőség: 800 kg, egyenletesen elosztva
- Padlóhoz rögzíthető

A következő kiegészítőkkel bővíthető:

- Perforált oldalpanel, C58PFL
- Legurulásgátló perem, 2100 mm, C58BAC 2.1

141 kg

800 kg

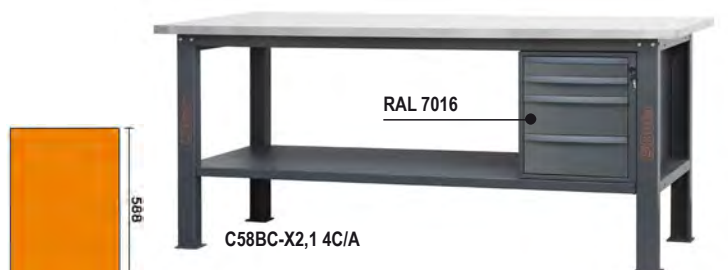

h	max
70 mm	25 kg
140 mm	30 kg

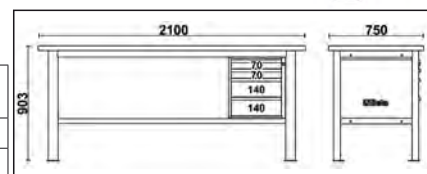

	Ft		
C58BC-X2,1 4C/O	559.100	1	058000623
C58BC-X2,1 4C/A	559.100	1	058000627

C58BC-X2,1 4CA

Rozsdamentes acéllal fedett MDF munkalapos munkapad, 2,1 m széles, 4 fiókkal és ajtós modul

Fő jellemzők:

- Rozsdamentes acéllal fedett MDF munkalap (2100 mm x 750 mm), 38 mm vastag
- 4 db teleszkópos, csapágyazott fiók (367 mm x 588 mm):
2 db fiók 70 mm magas
2 db fiók 140 mm magas
- A fiókok habgumival béleltek
- Mindegyik fiókba 4 EVA habszivacs vagy ABS hőformált tálca helyezhető
- Központi zár elöl
- 1 db zárható ajtós modul
- Acélszerkezet 4 db tartólábbal
- Furatokkal a satu rögzítéséhez (1599F/150 - 1599GI/150, a satu külön rendelhető)
- 2 db alsó keskeny tárolópolec, 1788 mm x 335 mm, vastagság: 40 mm
- Statikus terhelhetőség: 800 kg, egyenletesen elosztva
- Padlóhoz rögzíthető

A következő kiegészítőkkel bővíthető:

- Perforált oldalpanel, C58PFL
- Legurulásgátló perem, 2100 mm, C58BAC 2.1

155,5 kg

800 kg



h	max
70 mm	25 kg
140 mm	30 kg

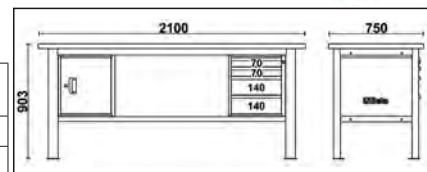

	Ft		
C58BC-X2,1 4CA/O	652.200	1	058000624
C58BC-X2,1 4CA/A	652.200	1	058000628

C58BC-X2,1 8CA

Rozsdamentes acéllal fedett MDF munkalapos munkapad, 2,1 m széles, 8 fiókkal és ajtós modulal

Fő jellemzők:

Rozsdamentes acéllal fedett MDF munkalap (2100 mm x 750 mm), 38 mm vastag

- 8 db teleszkópos, csapágyazott fiók (367 mm x 588 mm):
5 db fiók 70 mm magas
2 db fiók 140 mm magas
1 db fiók 210 mm magas
- A fiókok habgumival bélelték
- Mindegyik fiókba 4 EVA habszivacs vagy ABS hőformált tálca helyezhető
- Központi zár elől
- 1 db zárható ajtós modul
- Acélszerkezet 2 db tartólábal
- Furatokkal a satu rögzítéséhez (1599F/150 - 1599GI/150, a satu külön rendelhető)
- 2 db alsó keskeny tárolópolc, 1788 mm x 335 mm, vastagság: 40 mm
- Statikus terhelhetőség: 800 kg, egyenletesen elosztva
- Padlóhoz rögzíthető

A következő kiegészítőkkel bővíthető:

- Perforált oldalpanel, C58PFL
- Leguruláságtól perem, 2100 mm, C58BAC 2.1

197 kg

	Ft	📦	🏠
C58BC-X2,1 8CA/O	892.300	1	058000625
C58BC-X2,1 8CA/A	892.300	1	058000629



h	max
70 mm	25 kg
140 mm	30 kg
210 mm	30 kg

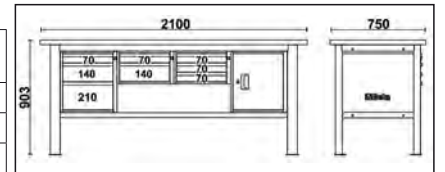

C58PLT-W 1,6

Rétegelt fa munkalap (1600x750 mm) a C58BC moduláris munkapadokhoz

- Vastagság: 38 mm
- Furatokkal a satu rögzítéséhez (1599F/150, a satu külön rendelhető)

35,5 kg

	Ft	📦	🏠
C58PLT-W 1,6	142.500	1	058000641



C58PLT-X 1,6

Rozsdamentes acéllal fedett MDF munkalap (1600x750 mm) a C58BC moduláris munkapadokhoz

- Vastagság: 38 mm
- Furatokkal a satu rögzítéséhez (1599F/150, a satu külön rendelhető)

48,5 kg

	Ft	📦	🏠
C58PLT-X 1,6	156.700	1	058000646



C58PLT-W 2,1

Rétegelt fa munkalap (2100x750 mm) a C58BC moduláris munkapadokhoz

- Vastagság: 38 mm
- Furatokkal a satu rögzítéséhez (1599F/150, a satu külön rendelhető)

41 kg

	Ft	📦	🏠
C58PLT-W 2,1	178.100	1	058000651



C58PLT-X 2,1

Rozsdamentes acéllal fedett MDF munkalap (2100x750 mm) a C58BC moduláris munkapadokhoz

- Vastagság: 38 mm
- Furatokkal a satu rögzítéséhez (1599F/150, a satu külön rendelhető)



63,5 kg

C58PLT-X 2,1

Ft 191.500 1 058000656

C58GF

Láb a C58BC moduláris munkapadokhoz

- Robosztus fémelem szerkezet polcok rögzítésére alkalmas lyukakkal
- Magasság 866 mm
- Padlóhoz rögzíthető
- Szín: antracitszürke RAL7016
- Teherbírás: 400 kg

8 kg



C58GF

Ft 40.100 1 058000660

C58GT

Állítható magasságú láb a C58BC moduláris munkapadokhoz

A láb az egyedi igényeknek megfelelő magasságba állítható, így a munkapad ergonómiailag optimalizálható.

- Robosztus fémelem szerkezet polcok rögzítésére alkalmas lyukakkal
- Magasság: 715 ÷ 1065 mm; furat köztáv: 25 mm
- Padlóhoz rögzíthető
- Szín: antracitszürke RAL7016
- Teherbírás: 400 kg

10 kg



C58GT

Ft 47.550 1 058000661

C58GRGM

Forgókerekes, fogantyús láb a C58BC moduláris munkapadokhoz

- Robosztus fémelem szerkezet polcok rögzítésére alkalmas lyukakkal
- 2 db fékezhető forgókerék, Ø 125 mm
- Oldalsó fogantyú a munkapad könnyű mozgatásához
- Teljes magasság: 824 mm, kerékkel együtt
- Szín: antracitszürke RAL7016
- Teherbírás: 400 kg

9,5 kg



C58GRGM

Ft 72.200 1 058000662

C58GRF

Kerekes, fogantyús láb a C58BC moduláris munkapadokhoz

- Robosztus fémelem szerkezet polcok rögzítésére alkalmas lyukakkal
- 2 db kerék, Ø 125 mm
- Teljes magasság: 824 mm, kerékkel együtt
- Szín: antracitszürke RAL7016
- Teherbírás: 400 kg

8,5 kg



C58GRF

Ft 61.150 1 058000663

C58CS 1C

1 fiókos, 257 mm magas szerszámtároló a C58BC moduláris munkapadokhoz

- 1 db teljesen kivethető, teleszkópos, csapágyazott fiók (367 mm x 588 mm), 210 mm magas
- Központi biztonsági zár elől
- A fiókok habgumival bélelték
- Mindegyik fiókba 4 EVA habszivacs vagy ABS hőformált tálca helyezhető

18,5 kg



h			max
210 mm			30 kg

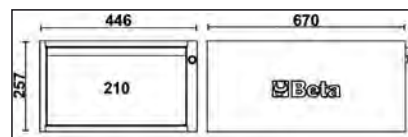

	Ft		
C58CS/O 1C	105.700	1	058000671
C58CS/A 1C	105.700	1	058000674

C58CS 2C

2 fiókos, 257 mm magas szerszámtároló a C58BC moduláris munkapadokhoz

- 2 db teljesen kivethető, teleszkópos, csapágyazott fiók, 367 mm x 588 mm:
- 1 db fiók 70 mm magas
- 1 db fiók 140 mm magas
- Központi biztonsági zár elől
- A fiókok habgumival bélelték
- Mindegyik fiókba 4 EVA habszivacs vagy ABS hőformált tálca helyezhető

21 kg

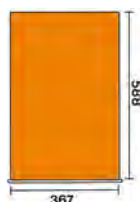

h			max
70 mm			25 kg
140 mm			30 kg

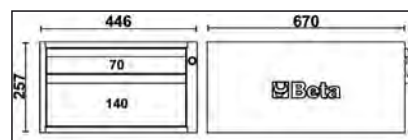

	Ft		
C58CS/O 2C	118.200	1	058000672
C58CS/A 2C	118.200	1	058000675

C58CS 3C

3 fiókos, 257 mm magas szerszámtároló a C58BC moduláris munkapadokhoz

- 3 db teljesen kivethető, teleszkópos, csapágyazott fiók (367 mm x 588 mm), 70 mm magas
- Központi biztonsági zár elől
- A fiókok habgumival bélelték
- Mindegyik fiókba 4 EVA habszivacs vagy ABS hőformált tálca helyezhető

24 kg



h			max
70 mm			25 kg

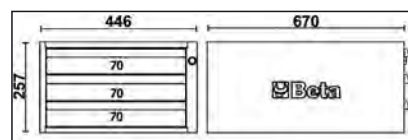

	Ft		
C58CS/O 3C	137.200	1	058000673
C58CS/A 3C	137.200	1	058000676

C58MA

Ajtós modul a C58BC moduláris munkapadokhoz, 479 mm magas

- Biztonsági zár elől
- Balra vagy jobbra nyíló féMLEmez ajtó felszerelhető
- Hasznos belső méret: 440x640x447 mm

15 kg

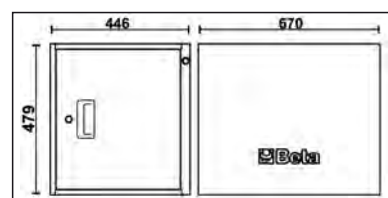

	Ft	1	058000680
C58MA/O	93.100	1	058000680
C58MA/A	93.100	1	058000681

C58CSH 3C

3 fiókos, 479 mm magas szerszámszekrény a C58BC moduláris munkapadokhoz

- 3 teljesen kivethető, teleszkópos, csapágyazott fiók, 367 mm x 588 mm:
- 1 db fiók 70 mm magas
- 1 db fiók 140 mm magas
- 1 db fiók 210 mm magas
- Központi biztonsági zár elől
- A fiókok habgumival béleltek
- Mindegyik fiókba 4 EVA habszivacs vagy ABS hőformált tálca helyezhető

31 kg



h	max
70 mm	25 kg
140 mm	30 kg
210 mm	30 kg

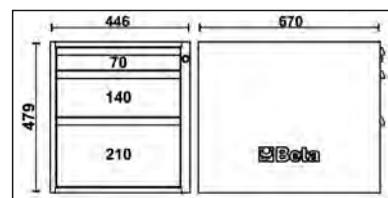

	Ft	1	058000682
C58CSH/O 3C	168.000	1	058000682
C58CSH/A 3C	168.000	1	058000686

C58CSH 4C

4 fiókos, 479 mm magas szerszámszekrény a C58BC moduláris munkapadokhoz

- 4 db teljesen kivethető, teleszkópos, csapágyazott fiók, 367 mm x 588 mm:
- 2 db fiók 70 mm magas
- 2 db fiók 140 mm magas
- Központi biztonsági zár elől
- A fiókok habgumival béleltek
- Mindegyik fiókba 4 EVA habszivacs vagy ABS hőformált tálca helyezhető

35 kg



h	max
70 mm	25 kg
140 mm	30 kg

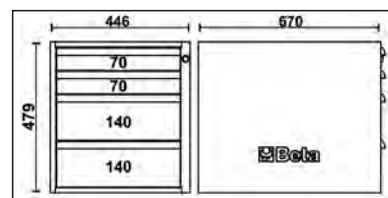

	Ft	1	058000683
C58CSH/O 4C	183.400	1	058000683
C58CSH/A 4C	183.400	1	058000687

C58CSH 5C

5 fiókos, 479 mm magas szerszámszekrény a C58BC moduláris munkapadokhoz

- 5 teljesen kivethető, teleszkópos, csapágyszott fiók, 367 mm x 588 mm:
- 4 db fiók 70 mm magas
- 1 db fiók 140 mm magas
- Központi biztonsági zár elöl
- A fiókok habgumival bélelték
- Mindegyik fiókba 4 EVA habszivacs vagy ABS hőformált tálca helyezhető

37,5 kg



RAL 2011

C58CSH/O 5C

RAL 7016

C58CSH/A 5C

	Ft	1	058000684
C58CSH/O 5C	199.600	1	058000684
C58CSH/A 5C	199.600	1	058000688

h	max
70 mm	25 kg
140 mm	30kg

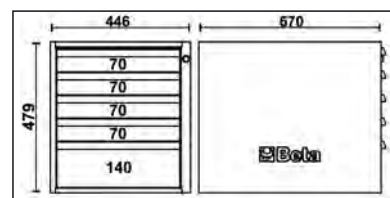

C58CSH 6C

6 fiókos, 479 mm magas szerszámszekrény a C58BC moduláris munkapadokhoz

- 6 db teljesen kivethető, teleszkópos, csapágyszott fiók (367 mm x 588 mm), 70 mm magas
- Központi biztonsági zár elöl
- A fiókok habgumival bélelték
- Mindegyik fiókba 4 EVA habszivacs vagy ABS hőformált tálca helyezhető

40 kg



RAL 2011

C58CSH/O 6C

RAL 7016

C58CSH/A 6C

	Ft	1	058000685
C58CSH/O 6C	215.400	1	058000685
C58CSH/A 6C	215.400	1	058000689

h	max
70 mm	25 kg

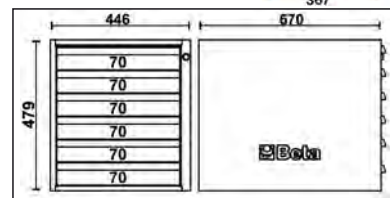

C58K/2PF-1,6M

2 db perforált szerszámtartó panel kerettel a C58BC moduláris munkapadokhoz, 1,6 m széles

Készlet tartalma:

- 3 db tartókonzol
- 3 db függőleges konzol, 400 mm
- 2 db vízszintes konzol, 765 mm, 1 csatlakozónak kialakított 19" keret (nem tartozék)
- 2 db perforált szerszámtartó panel, 765x25x400 mm

14,4 kg

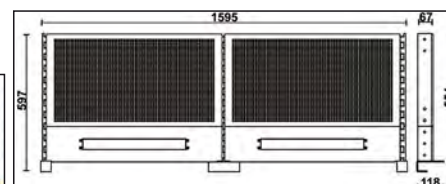
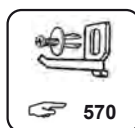

	Ft	1	058000802
C58K/2PF-1,6M	156.000	1	058000802

C58K/4PF-1,6M

4 db perforált szerszámtartó panel kerettel a C58BC moduláris munkapadokhoz, 1,6 m széles

Készlet tartalma:

- 3 db tartókonzol
- 6 db függőleges konzol, 400 mm
- 2 db vízszintes konzol, 765 mm, 1 csatlakozónak kialakított 19" keret (nem tartozék)
- 4 db perforált szerszámtartó panel, 765 mm x 400 mm

📦 23,9 kg

C58K/4PF-1,6M

Ft 263.500 1 058000804

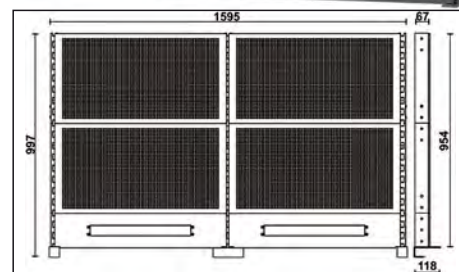
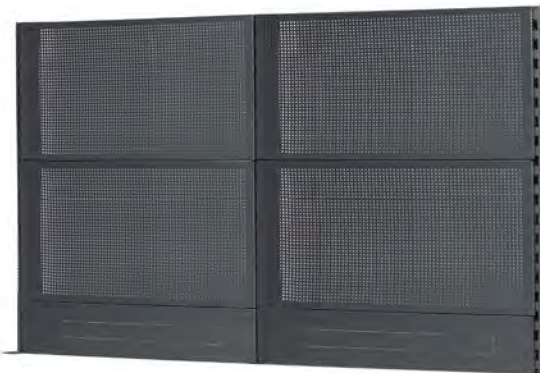

C58K/2PF-2,1M

2 db perforált szerszámtartó panel kerettel a C58BC moduláris munkapadokhoz, 2,1 m széles

Készlet tartalma:

- 3 db tartókonzol
- 3 db függőleges konzol, 400 mm
- 2 db vízszintes konzol, 1015 mm, 1 csatlakozónak kialakított 19" keret (nem tartozék)
- 2 db perforált szerszámtartó panel, 1015x25x400 mm

📦 17 kg

C58K/2PF-2,1M

Ft 169.200 1 058000812

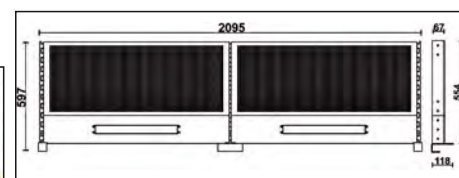

C58K/4PF-2,1M

4 db perforált szerszámtartó panel kerettel a C58BC moduláris munkapadokhoz, 2,1 m széles

Készlet tartalma:

- 3 db tartókonzol
- 6 db függőleges konzol, 400 mm
- 2 db vízszintes konzol, 1015 mm, 1 csatlakozónak kialakított 19" keret (nem tartozék)
- 4 db perforált szerszámtartó panel, 1015x25x400 mm

📦 28,2 kg

C58K/4PF-2,1M

Ft 282.800 1 058000814

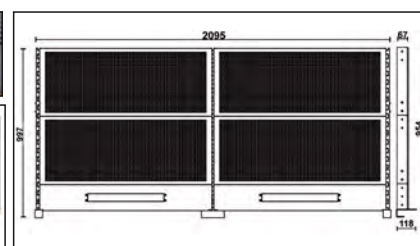

C58SP 1,6

Keskeny tárolópólc a C58BC moduláris munkapadokhoz, 1,6 m széles

- Vastagság: 40 mm
- Rögzítő szerelvényekkel

📦 9,7 kg

C58SP 1,6 Ft 39.650 1 058000690



C58SP 2,1

Keskeny tárolópólc a C58BC moduláris munkapadokhoz, 2,1 m széles

- Vastagság: 40 mm
- Rögzítő szerelvényekkel

📦 13,3 kg

C58SP 2,1 Ft 52.000 1 058000691



C58BAC 1,6

Leguruláságtóló perem a C58BC moduláris munkapadokhoz, 1,6 m széles

- 2 db elektromos csatlakozónak kialakított 19" keret (nem tartozék)
- Méretek: 1600x55x120 mm

📦 4,5 kg

C58BAC 1,6 Ft 22.250 1 058000692



C58BAC 2,1

Leguruláságtóló perem a C58BC moduláris munkapadokhoz, 2,1 m széles

- 2 db elektromos csatlakozónak kialakított 19" keret (nem tartozék)
- Méretek: 2100x55x120 mm

📦 5,8 kg

C58BAC 2,1 Ft 26.300 1 058000693



C58PFL

Perforált oldalpanel a C58BC moduláris munkapadokhoz

- Méretek: 560x25x545 mm
- Rögzítő szerelvényekkel

📦 1,8 kg

C58PFL Ft 25.300 1 058000696



C58MP-0,8M

Polc a C58BC moduláris munkapadokhoz, 1,6 m széles

- Méretek: 774 mm x 335 mm
- Alumínium profilra szerelt 5000 RSC50 2.0/PLEDC vagy 5000 RSC50 2.0/PLED-ST LED szalag (külön rendelhető) a munkapad alatti modulok megvilágítására.

📦 3,5 kg

C58MP-0,8M

Ft 27.550 1 058000840



C58MP-1M

Polc a C58BC moduláris munkapadokhoz, 2,1 m széles

- Méretek: 1024 mm x 335 mm
- Alumínium profilra szerelt 5000 RSC50 2.0/PLEDC vagy 5000 RSC50 2.0/PLED-ST LED szalag (külön rendelhető) a munkapad alatti modulok megvilágítására.

📦 4,5 kg

C58MP-1M

Ft 32.000 1 058000841



C58BLP-1,6M

LED lámpasín a C58BC moduláris munkapadokhoz, 1,6 m széles

- Sín hossza: 1550 mm
- 1 db C58PLED-150 típusú LED lámpával is szállítható (a LED lámpa külön rendelhető)

📦 5,2 kg

C58BLP-1,6M

Ft 36.450 1 058000850



C58BLP-1M

LED lámpasín a C58BC moduláris munkapadokhoz, 2,1 m széles

- Sín hossza: 1024 mm
- 1 db C58PLED-90 típusú LED lámpával is szállítható (a LED lámpa külön rendelhető)
- A 2,1 m-es pad teljes felszereléséhez 2 darabot kell rendelni.

📦 3,8 kg

C58BLP-1M

Ft 30.350 1 058000851



C58PLED-150

LED lámpa a C58BC moduláris munkapadokhoz, 1,6 m hosszú

- Méretek: 1500x25x78 mm
- Teljesítmény: 48W
- Fényerősség: 4320 lumen
- Színhőmérséklet: 6400k
- Sugárzási szög: 180°
- Védelmi fokozat: IP20
- Átlagos élettartam: >20,000 óra
- Működési hőmérséklet: -10 °C ÷ +45 °C
- Üzemi feszültség: 220-240AC, 50/60 Hz
- Rögzítőelemekkel szállítva

📦 540 g

C58PLED-150

Ft 20.450 1 058000860



CE

C58PLED-90

LED lámpa a C58BC moduláris munkapadokhoz, 2,1 m hosszú

CE

- Méretek: 900x25x75 mm
- Teljesítmény: 24W
- Fényerősség: 2200 lumen
- Színhőmérséklet: 6400k
- Sugárzási szög: 180°
- Védelmi fokozat: IP20
- Átlagos élettartam: >20,000 óra
- Működési hőmérséklet: -10 °C ÷ +45 °C
- Üzemi feszültség: 220-240AC, 50/60 Hz
- Rögzítőelemekkel szállítva

340 g



C58PLED-90	Ft	12.950	1	058000861
------------	----	--------	---	-----------

C56

Munkapad

- Fém munkalap peremmel
- 6 lábú acélváz
- Statikai terhelés: 1.200 Kg
- C57P szerszámfallal kombinálható, munkaasztalra nem rögzíthető.
- Két fiók zárral.
- Padlóhoz rögzíthető.

82 kg



C56-O	RAL 2011	Ft	457.700	1	056000201
C56-G	RAL 7016	Ft	457.700	1	056000202
C56-R	RAL 3000	Ft	457.700	1	056000203

C56W

fa munkalapos munkapad

- Többretegű fa munkalap furatokkal a satu rögzítéséhez (1599F/125 - 1599GI/125, külön kell megrendelni).
- Acélszerkezet 6 tartólábbal
- Statikus terhelhetőség: 1.200 kg
- Hozzárendelhető a munkapadhoz nem rögzíthető C57P falhoz.
- Két fiók zárral.
- Előkészítve a padlóhoz történő rögzítéshez.

86 kg



C56W-O	RAL 2011	Ft	543.900	1	056000251
C56W-G	RAL 7016	Ft	543.900	1	056000252
C56W-R	RAL 3000	Ft	543.900	1	056000253

C59A

"Endurance" munkapad egy 6 fiókos blokkal

Fő jellegzetességek:

- Multiplex-munkalap furatokkal a satu rögzítéséhez 1599F/125 - 1599GI/125 (külön kell megrendelni).
- 6 teleszkópos, csapágyazott fiók 588x367 mm:
- 4 fiók magasság: 70 mm
- 1 fiók magasság: 140 mm
- 1 fiók magasság: 280 mm.
- A fiókok habgumival bélelték.
- Erősített nylon fiókperem.
- Hőformált tálcák elhelyezhetők.
- Elöl központi biztonsági zár.
- Alul tároló rekesz
- 2400 RSC24/PC papírtekerstartó és a 2400 RSC24/PF- flakontartó felszerelhető, külön kell megrendelni.

115 kg

		Ft		
C59A-O	RAL 2011 - 7016	871.900	1	059000011
C59A-A	RAL 7016	871.900	1	059000031
C59A-R	RAL 3000 - 7016	871.900	1	059000051



C59A-O



C59A-A



C59A-R

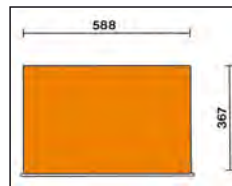

h	max
70 mm	25 kg
140 mm	30 kg
280 mm	35 kg

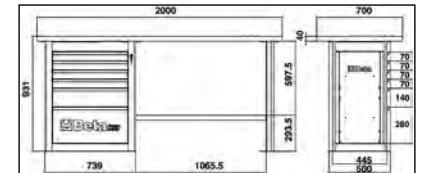

C59B

"Endurance" munkapad két 6 fiókos blokkal

Fő jellegzetességek:

- Multiplex-munkalap furatokkal a satu rögzítéséhez 1599F/125 - 1599GI/125 (külön kell megrendelni).
- 12 fiók, teleszkópos, csapágyazott fiók 588x367 mm:
- 8 fiók magasság: 70 mm
- 2 fiók magasság: 140 mm
- 2 fiók magasság: 280 mm
- A fiókok habgumival bélelték.
- Hőformált tálcák elhelyezhetők.
- Elöl központi biztonsági zár.
- Alul tároló rekesz.
- 2400 RSC24/PC papírtekerstartó és a 2400 RSC24/PF- flakontartó felszerelhető, külön kell megrendelni.

155 kg

		Ft		
C59B-O	RAL 2011 - 7016	1.159.900	1	059000012
C59B-R	RAL 3000 - 7016	1.159.900	1	059000052
C59B-A	RAL 7016	1.159.900	1	059000032

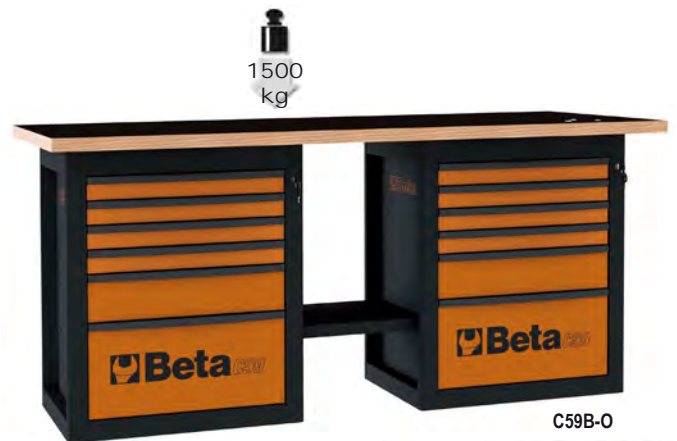

C59B-O



C59B-A



C59B-R

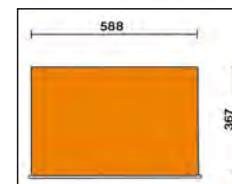

h	max
70 mm	25 kg
140 mm	30 kg
280 mm	35 kg

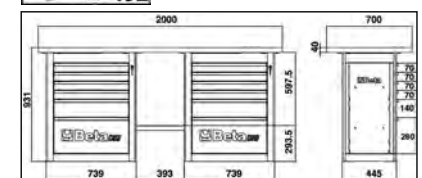

"Endurance" munkapad egy 6 fiókos blokkal, rövid kivitel

Fő jellegzetességek:

- Multiplex-munkalap furatokkal a satu rögzítéséhez 1599F/125 - 1599GI/125 (külön kell megrendelni).
- 6 fiók, teleszkópos, csapágyazott fiók 588x367 mm
- 4 fiók magasság: 70 mm
- 1fiók magasság: 140 mm
- 1fiók magasság: 280 mm
- A fiókok habgumival bélelték.
- Hőformált tálcák elhelyezhetők.
- Elöl központi biztonsági zár.
- Alul tároló rekesz.
- 2400 RSC24/PC papírtekercstartó és a 2400 RSC24/PF- flakontartó felszerelhető, külön kell megrendelni.

1500 kg



C59C-O



C59C-A



C59C-R

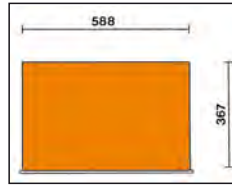

h	max
70 mm	25 kg
140 mm	30 kg
280 mm	35 kg

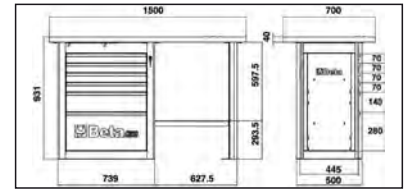

105 kg

		Ft		
C59C-O	RAL 2011 - 7016	787.400	1	059000013
C59C-R	RAL 3000 - 7016	787.400	1	059000053
C59C-A	RAL 7016	787.400	1	059000033





CSÚSZÁSMENTES, MODULÁRIS PVC PADLÓLAP

	PCP	SCG/M	SCG/F
	6x	5x	5x
	8x	6x	6x
	10x	7x	7x

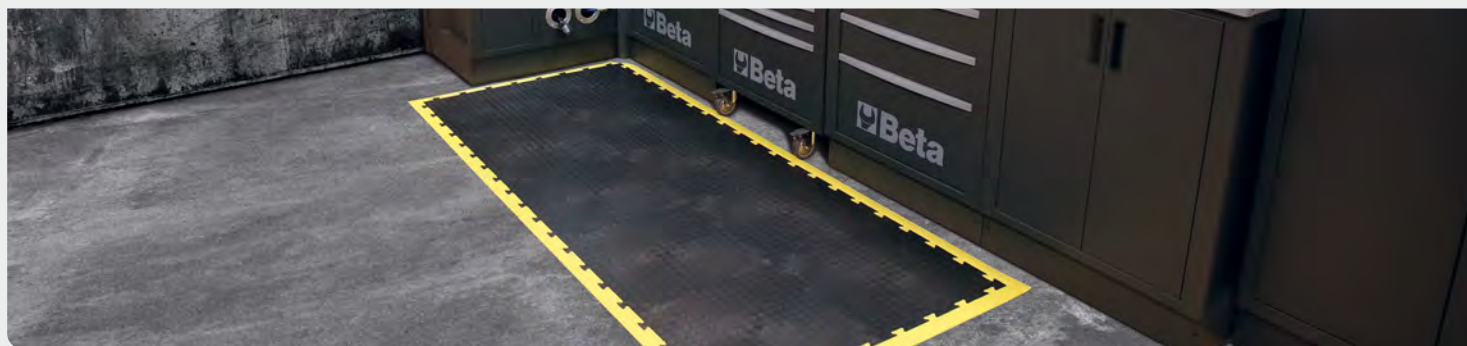

PCP

Csúszásmentes, moduláris PVC padlólap

A Beta műhelyberendezés összeállítások és munkapadok tökéletes kiegészítője.

Fő jellemzők:

- Csúszásmentes, dombornyomott felület
- Az EN 13501-1 szabvány szerinti tűzállósági vizsgálatot teljesítette
- Csúszásmentességi besorolás: R10, a DIN EN 16165 szabványnak megfelelően
- Legtöbb oldószernek és vegyi anyagnak ellenálló
- Jó hang- és hőszigetelő
- Könnyen tisztítható
- Egymásba illeszthető

1,4 kg

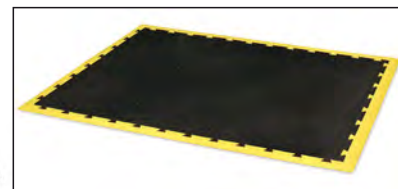
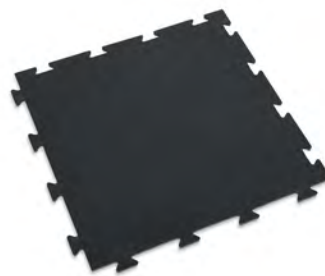

PCP mm Ft

500x500x80 mm 4.700 10 088880800

SCG

Moduláris PCP szegély

Elengedhetetlen kiegészítő a munkaterületek kijelöléséhez.

Fő jellemzők:

- Egymásba illeszkedő szegélyek
- A szegélyek 45° szögben levághatók, így sarkok is kialakíthatók
- Sárga kivite la maximális láthatóság érdekében
- A rézsútós szegélyeken a kocsik könnyebben közlekednek

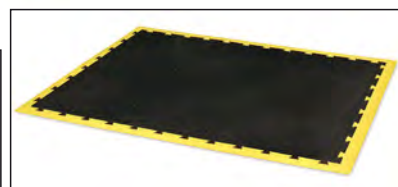

SCG/M mm Ft

483x50x7,5 mm 3.700 10 088880805

SCG/F 483x50x7,5 mm 3.700 10 088880810



MŰHELYBERENDEZÉSEK



Hogy megfeleljen az egyre inkább a minőség, a design és a személyre szabottság igényével jelentkező piacnak, a Beta Utensili kifejlesztette a "Racing System C55" moduláris műhelyberendezési rendszert, hogy lehetővé tegye Önöknek egy modern és a szükségleteknek mindenben megfelelő munkahelyi környezet létrehozását.

 **Beta**
R S C 55



MINŐSÉG

A legjobb „Made in Italy“ Beta minőség a műhely berendezéséhez



SZERVEZETTSÉG

Egy észszerűen szervezett munkaállás lehetővé teszi a munkavégzés optimalizálását



MODULARITÁS

A rendelkezésre álló hely és az igények alapján összeállítható műhely



DESIGN

Igényes és lenyűgöző kivitel, hogy a munkahely egy rendezett és kellemes környezetet biztosítson





MŰHELYBERENDEZÉSEK



MADE IN ITALY



Látogasson el a www.rsc55.com webhelyre és konfigurálja saját műhelyét.

A színeiben tündöklő műhely!

Az RSC55 lehetőséget kínál arra, hogy a munkapadok és a szerszámtartó falak redőnyeit semleges (szürke) színben rendeljük meg, majd személyre szabhatjuk magunknak a 7 különböző színű ragasztószalag (függőleges betétek) segítségével.

1. Rendelje meg a modulokat semleges színben

2. Rendelje meg a függőleges betéteket
Válassza ki a megfelelő színt ízlésének, vagy vállalata arculatának megfelelően.



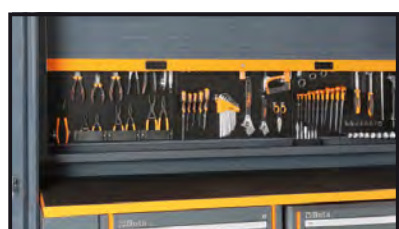

A teljes összeállítás a következőkből áll:

- 1 ajtós szekrény (C55A1)
- 2 ajtós szekrény (C55A2)
- Munkapad (C55BO/2)
- Munkapad csatlakozókkal (C55PRO BO/2)
- 7 fiókos mobil szerszámkocsi (C55C7)
- Rögzített 2 fiókos modul (C55M2)
- Rögzített 7 fiókos modul (C55M7)
- Rögzített szervizmodul (C55MS)
- Polcos fal (C55/2PM)
- Szerszámtartó fal redőnyvel (C55PS-O)

C55AB

műhelyberendezés összeállítás

Az összeállítás a következőkből áll:

- 2 ajtós szekrény (C55A2)
- Munkapad (C55BO/2)
- Rögzített 7 fiókos modul (C55M7)
- Rögzített szervízmodul (C55MS)
- Polcos fal (C55/2PM)

407 kg



C55AB

Ft 4.615.000 1 055000020



C55PB/3

műhelyberendezés összeállítás

Az összeállítás a következőkből áll:

- Munkapad (C55BO/2)
- 8 fiókos szerszámkocsi műhelyberendezéshez (C55C8)
- 2 nagy fiókos rögzített modul (C55M2)
- Redőnyös szerszámtartó fal (C55PS-O)

334 kg



C55PB/3

Ft 3.888.300 1 055000035



C55PB-PRO/7

munkaállomás az RSC55 műhelyberendezés összeállításához

Tartalma:

C55B

Munkapad ütésbiztos, olajoknak és szénhidrogéneknek ellenálló karcvédett ABS réteggel burkolt 2050x700 mm munkalappal.

Tartozékok:

- Furatokkal a satu rögzítéséhez (1599F/150 - 1599GI/150, külön kell megrendelni)
- Függetlenül állítható talp

C55M7

7 fiókos rögzített modul, teleszkópos, csapágyazott fiókokkal (588x367 mm)

- Alumínium nyitórendszer, a szerszámkocsi teljes hosszában elhelyezve
- A fiókok habgumival bélelték
- Központi zár elöl
- Beta szerszámtálcákkal méretpontosan feltölthető

C55MS

Rögzített szervizmodul

- Beépített hulladékartó
- Üreg a papírtekerstartó számára
- 1 rakodófiók, 305x270 mm

C55/2PM + C55/PF

2 szerszámtartó fal szekrénnel

- 2 db 1024x400x300 mm méretű polc, gázrugókkal felszerelve.
- 2 db 1024x620x25 mm méretű panel a szekrények alatt
- 2 db 1024x620x25 mm méretű lyukacsos szerszámtartó panel a szekrények alatt



350 kg

C55PB-PRO/7

Ft 4.365.200 1 055000065



C55PB-PRO/8

munkaállomás az RSC55 műhelyberendezés összeállításához

Tartalma:

C55B

Munkapad ütésbiztos, olajoknak és szénhidrogéneknek ellenálló karcvédett ABS réteggel burkolt 2050x700 mm munkalappal.

Tartozékok:

- Furatokkal a satu rögzítéséhez (1599F/150 - 1599GI/150, külön kell megrendelni)
- Függetlenül állítható talp

C55C7

7 fiókos szerszámkocsi teleszkópos, csapágyazott fiókokkal (588x367 mm)

- 4 kerék Ø 100 mm, 2 rögzített (egyik fékkel) és 2 elfordítható
- Alumínium nyitórendszer, a szerszámkocsi teljes hosszában elhelyezve
- A fiókok habgumival bélelték
- Központi zár elöl
- Beta szerszámtálcákkal méretpontosan feltölthető

C55MA

Rögzített kétajtós modul

- Nyomásra nyíló ajtó
- Zárható
- Magasságban állítható belső polc

C55PS

Redőnyös szerszámtartó fal

- Függetlenül mozgatható, zárral rendelkező alumínium redőny
- Levehető lyukacsos szerszámtartó panel



347 kg

C55PB-PRO/8

Ft 3.758.700 1 055000066



C55B/2

2 méteres munkapad műhelyberendezéshez

Ütésbiztos és szénhidrogéneknek ellenálló, karcvédett PVC réteggel bevont, 2050x700 mm munkalap

- Furatok a(z) 1599F/150 - 1599GI/150 satu rögzítéséhez(külön kell megrendelni)
- Állítható magasságú lábak

105 kg

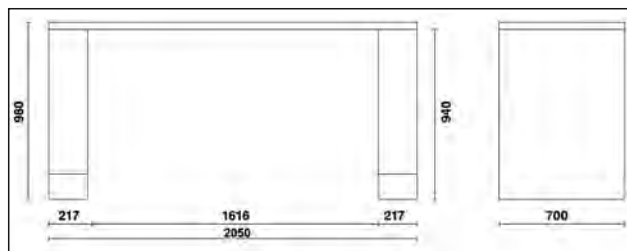

	Ft		
C55BO/2	1.071.300	1	055000101
C55BG/2	1.071.300	1	055000111

C55PRO B/2

2 méteres munkapad műhelyberendezés összeállításához

Ütésbiztos és szénhidrogéneknek ellenálló karcvédett PVC réteggel burkolt 2050x700 mm munkalap

Beépített aljzatok és tömlődob:

- Schuko aljzat+16+10A
- EU csatlakozó 10A
- Sűrített levegős csatlakozó Ø 8 mm tömlődobbal. Hosszúság: 10 m.
- Furatokkal a satu rögzítéséhez (1599F/150 - 1599GI/150, külön kell megrendelni)
- Függőlegesen állítható talp

110 kg

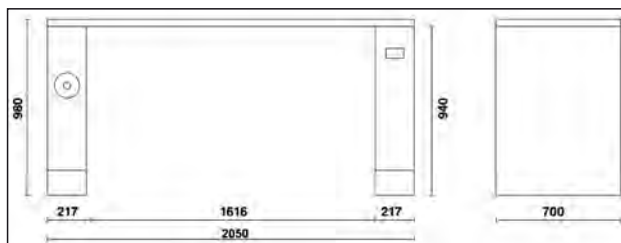
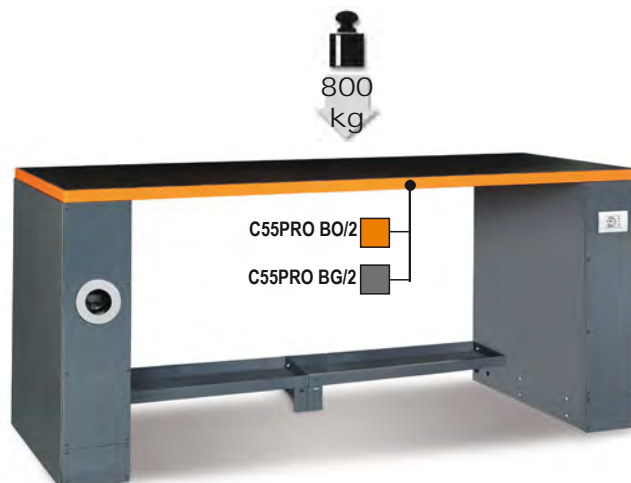

	Ft		
C55PRO BO/2	1.309.900	1	055000151
C55PRO BG/2	1.309.900	1	055000171

C55B/2,8

2,8 méteres munkapad műhelyberendezéshez

Ütésbiztos és szénhidrogéneknek ellenálló, karcvédett PVC réteggel bevont, 2850x700 mm munkalap

- Furatok a(z) 1599F/150 - 1599GI/150 satu rögzítéséhez (külön kell megrendelni)
- Állítható magasságú lábak

131 kg

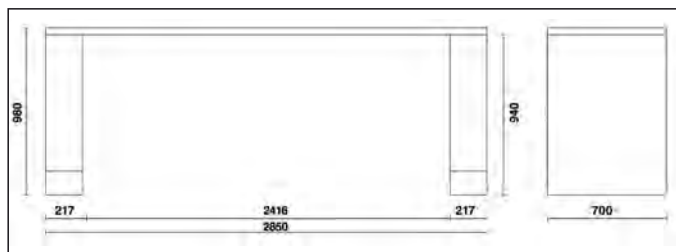
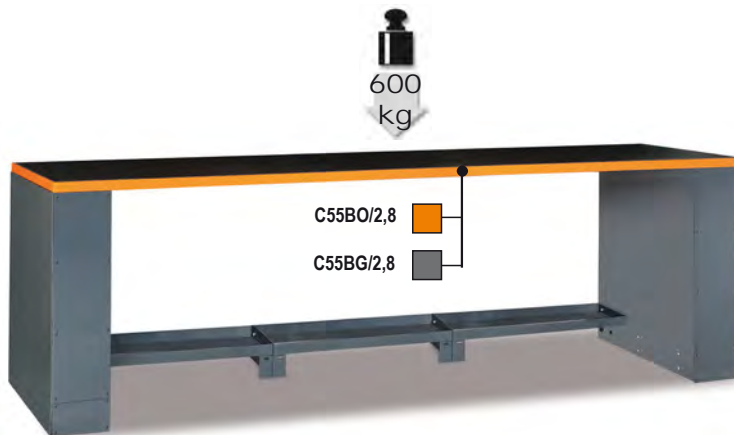

	Ft	1	055000261
C55BO/2,8	1.344.100	1	055000261
C55BG/2,8	1.344.100	1	055000281

C55PRO B/2,8

2,8 méteres munkapad műhelyberendezés összeállításához

Ütésbiztos és szénhidrogéneknek ellenálló karcvédett PVC réteggel burkolt 2850x700 mm munkalap

Beépített aljzatok és tömlődob:

- Schuko aljzat+16+10A
- EU csatlakozó 10A
- Sűrített levegős csatlakozó Ø 8 mm tömlődobbal. Hosszúság: 10 m.
- Furatokkal a satu rögzítéséhez (1599F/150 - 1599GI/150, külön kell megrendelni)
- Függetlenül állítható talp

134 kg

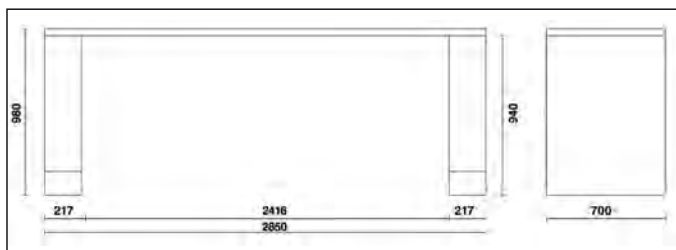
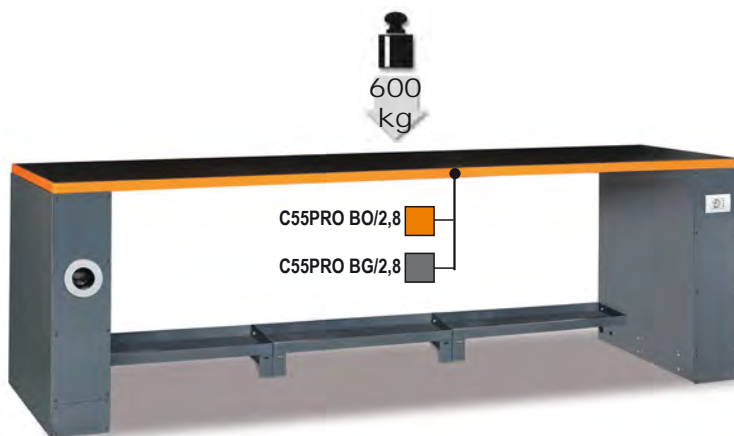

	Ft	1	055000271
C55PRO BO/2,8	1.582.800	1	055000271
C55PRO BG/2,8	1.582.800	1	055000283

C55B-D4

4 méteres kettős munkapad közepső lábbal

4100x700 mm méretű, egy ütészálló és karcálló, szénhidrogéneknek ellenálló PVC réteggel burkolva

- Furatok egy darab 1599F/150 - 1599GI/150 típusú satu elhelyezésére (külön kell megrendelni)
- Állítható magasságú lábak
- Dupla szélességű közepső láb (365x750 mm) beépített ajtós tárolórekeszsel

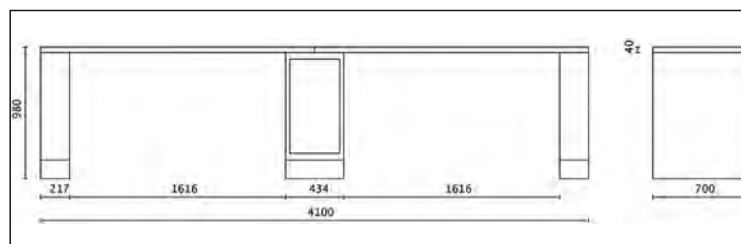

	Ft		
C55BO/D4	2.181.400	1	055000109
C55BG/D4	2.181.400	1	055000119

C55PRO B-D4

4 méteres két munkaállomásos munkapad közepső lábbal

Ütésbiztos és szénhidrogéneknek ellenálló karcvédett PVC réteggel burkolt 4100x700 mm munkalap

Beépített aljzatok és kábeldob:

- Schuko aljzat+16+10A
- EU csatlakozó 10A
- Sűrített levegős csatlakozó Ø 8 mm tömlődobbal. Hosszúság: 10 m.
- Furatokkal a satu rögzítéséhez (1599F/150 - 1599GI/150, külön kell megrendelni)
- Függgőlegesen állítható talp
- Dupla szélességű közepső láb (365x750 mm) beépített ajtós tárolórekeszsel

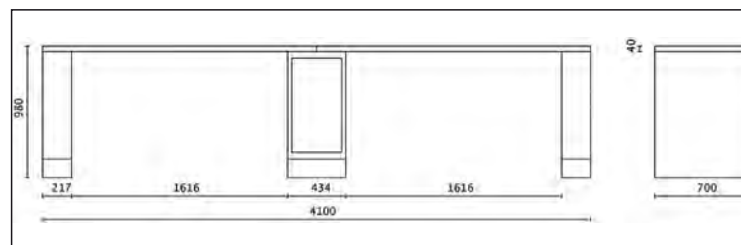
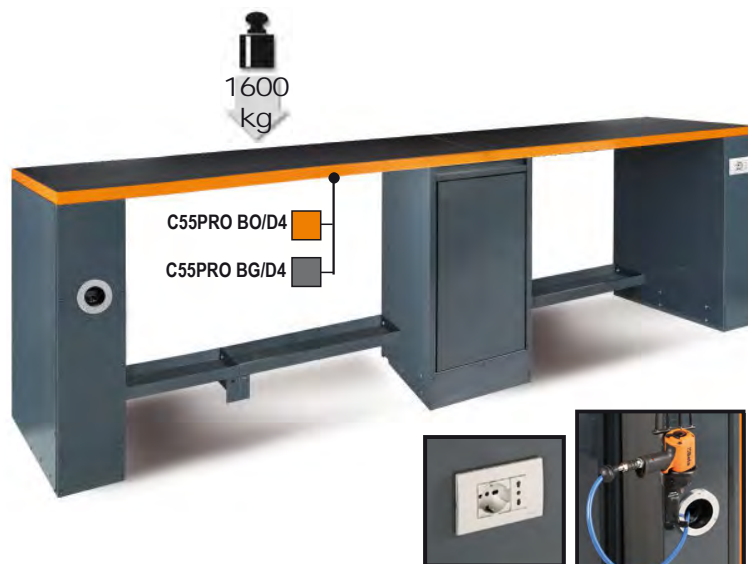

	Ft		
C55PRO-BO/D4	2.420.000	1	055000159
C55PRO-BG/D4	2.420.000	1	055000179

 **Beta**

C55B/G

univerzális láb műhelyberendezés munkapadhoz

- Fügőlegesen állítható talp
- A munkapad mindkét oldalára felszerelhető
- Szemből és oldalról nyitható szerelőnyílás

32 kg

C55B/G Ft 288.300 1 055000096

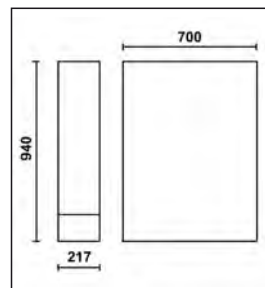

C55B/GAA

univerzális lábázat munkapadhoz beépített tömlődobbal

- Beépített automata tömlődob pneumatikus levegőhöz vagy hideg vízhez, Ø 8 mm
- Tömlő hossz: 10 m 1900S 8x10
- Fügőlegesen állítható talp
- Szemből és oldalról nyitható szerelőnyílás

36,4 kg

C55B/GAA Ft 460.500 1 055000099

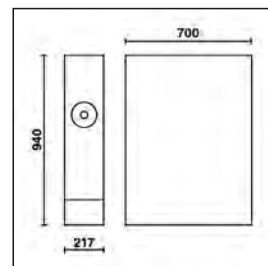
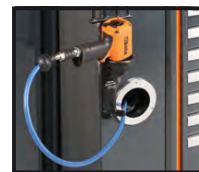

C55B/GDP

Kettős láb műhelyberendezés munkapadhoz

- Papírtekerstartó rekesz
- Rakodórekesz zárófedéllel
- Állítható magasságú lábakkal

45 kg

C55B/GDP Ft 684.200 1 055000292

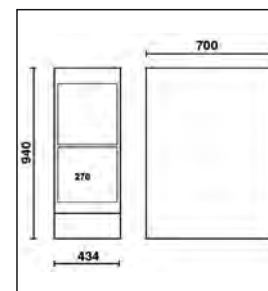

C55B/GDS

kettős láb műhelyberendezés munkapadhoz

- Rakodórekesz 365x750 mm, zárófedéllel
- Állítható magasságú lábakkal

45 kg

C55B/GDS Ft 615.400 1 055000291

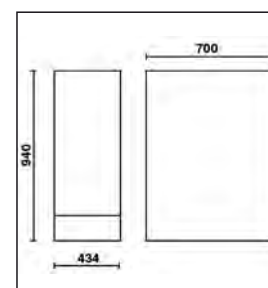

C55B/GE

univerzális láb konnektorral műhelyberendezés munkapadhoz

- Schuko aljzat 16/10A
- EU csatlakozó 10A
- Fügőlegesen állítható talp
- Szemből és oldalról nyitható szerelőnyílás

30,4 kg

C55B/GE Ft 354.700 1 055000097

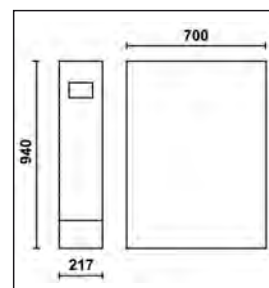

C55B/GAE

univerzális láb elektromos kábeldobbal műhelyberendezés munkapadhoz

- Beépített automata kábeldob Schuko csatlakozóval 1844 15H05SCK
- Kábelhossz: 15 m
- Hővédő kapcsolóval
- Fügőlegesen állítható talp
- Szemből és oldalról nyitható szerelőnyílás

37,5 kg

C55B/GAE Ft 488.300 1 055000094

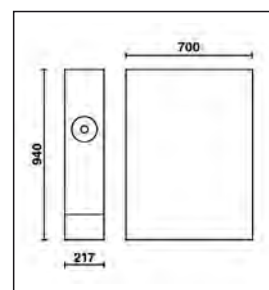
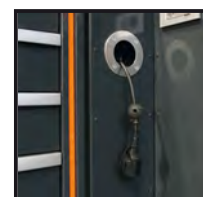

C55/PL-1,024

1 m széles munkalap műhelyberendezés munkapad bővítéséhez

Ütésálló és szénhidrogéneknek ellenálló, karcvédett PVC réteggel burkolt, 1024x700 mm, festett lemez munkalap

21 kg

	Ft	csomagolás	azonosító
C55/PLO-1,024	238.100	1	055000130
C55/PLG-1,024	238.100	1	055000131



C55B PT/2

2 méteres munkalap műhelyberendezéshez

Ütésbiztos és szénhidrogéneknek ellenálló, karcvédett PVC réteggel burkolt, 2050x700 mm, festett lemez munkalap
Furatokkal a satu rögzítéséhez (1599P/150 - 1599GI/150, külön kell megrendelni)

43 kg

	Ft	csomagolás	azonosító
C55BO PT/2	494.700	1	055000106
C55BG PT/2	494.700	1	055000116

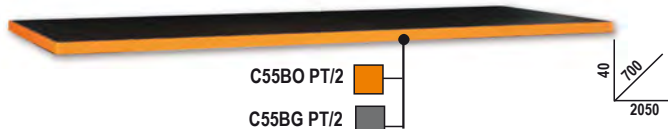

C55B PT/2,8

2,8 méteres munkalap műhelyberendezéshez

Ütésbiztos és szénhidrogéneknek ellenálló, karcvédett PVC réteggel burkolt, 2850x700 mm, festett lemez munkalap
Furatokkal a satu rögzítéséhez (1599P/150 - 1599GI/150, külön kell megrendelni)

67 kg

	Ft	csomagolás	azonosító
C55BO PT/2,8	767.600	1	055000266
C55BG PT/2,8	767.600	1	055000286



C55RB

ütésbiztos és szénhidrogéneknek ellenálló, karcvédett PVC burkolat

Munkalapok védelmére.

C55RB/2: 2 m széles munkalaphoz

C55RB/2,8: 2,8 m széles munkalaphoz

C55RB/0,7: 700x700mm méretű munkalaphoz

C55RB/1: 1 m széles munkalaphoz

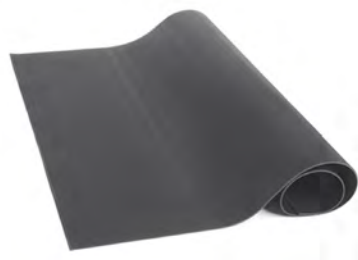

	Ft	csomagolás	azonosító
C55RB/2	83.800	1	055000195
C55RB/2,8	113.800	1	055000196
C55RB/0,7	46.550	1	055000199
C55RB/1	63.550	1	055000198

C55B/VS

alsó munkalap konzol műhely munkapadokhoz, 0,8 m széles

Méreték: 800x230x60 mm

4,2 kg

	Ft	csomagolás	azonosító
C55B/VS	63.550	1	055000095

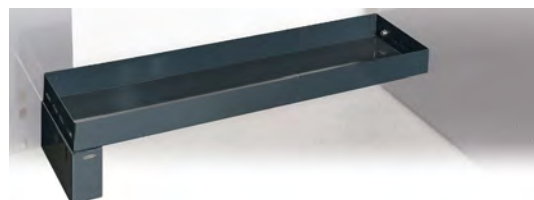

C55C7

7 fiókos szerszámkocsi műhelyberendezéshez

7 fiók 588x367 mm, teleszkópos, csapágyazott

- 4 kerék Ø 100 mm, 2 rögzített (egyik fékkel) és 2 elfordítható
- Alumínium nyitórendszer, a szerszámkocsi teljes hosszában elhelyezve
- A fiókok habgumival bélelték
- Központi zár elöl
- Hőformált tálcák elhelyezési lehetősége

79 kg

1000 kg



h	max
70 mm	30 kg
245 mm	40 kg

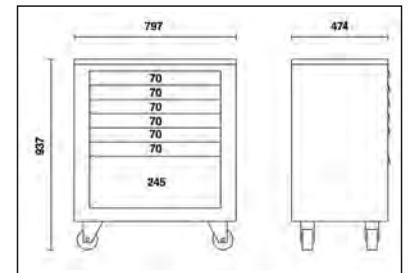
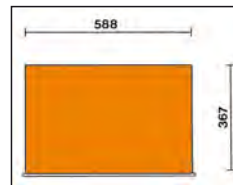

C55C7

Ft 991.900 1 055000201

Beta



C55C8

8 fiókos szerszámkocsi műhelyberendezéshez

8 fiók 588x367 mm, teleszkópos, csapágyazott

- 4 kerék Ø 100 mm, 2 rögzített (egyik fékkel) és 2 elfordítható
- Alumínium nyitórendszer, a szerszámkocsi teljes hosszában elhelyezve
- A fiókok habgumival bélelték
- Központi zár elől
- Hőformált tálcák elhelyezési lehetősége

80,8 kg



h	max
70 mm	30 kg
175 mm	40 kg

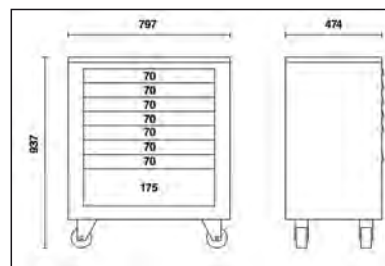
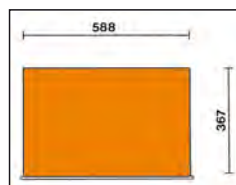

C55C8

Ft 1.008.100 1 055000206

C55M2

2 fiókos rögzített modul műhelyberendezéshez

2 fiók 588x367 mm, teleszkópos, csapágyazott

- Alumínium nyitórendszer, a fiók teljes hosszában elhelyezve
- A fiókok habgumival bélelték
- Központi zár elől

66 kg



h	max
280 mm	40 kg
385 mm	40 kg

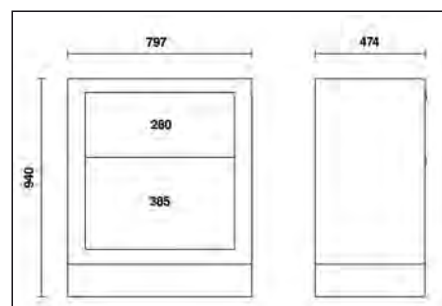
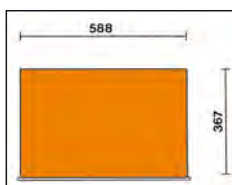

C55M2

Ft 842.100 1 055000202

C55M4

4 fiókos rögzített modul műhelyberendezéshez

4 fiók (588x367 mm), teleszkópos, csapágyazott

- Alumínium nyitórendszer, a szerszámok teljes hosszában elhelyezve
- A fiókok habgumival béleltek
- Központi zár elöl

75 kg

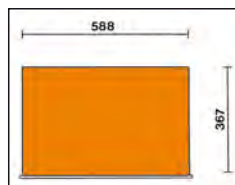

h	max
140 mm	30 kg
245 mm	40 kg

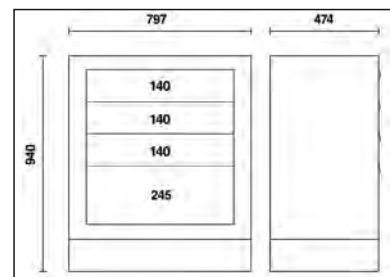

C55M4

Ft 884.600 1 055000212

C55M7

7 fiókos rögzített modul műhelyberendezéshez

7 fiók 588x367 mm, teleszkópos, csapágyazott

- Alumínium nyitórendszer, a fiók teljes hosszában elhelyezve
- A fiókok habgumival béleltek
- Központi zár elöl
- Hőformált tálcák elhelyezési lehetősége

78 kg

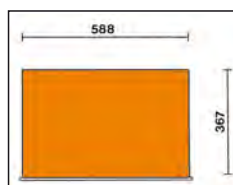

h	max
70 mm	30 kg
245 mm	40 kg

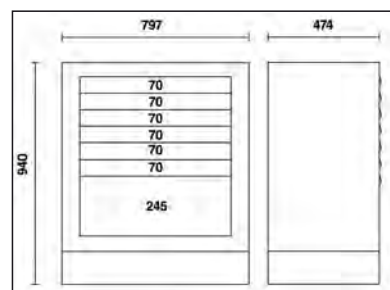

C55M7

Ft 937.200 1 055000203

C55M8

8 fiókos rögzített modul műhelyberendezéshez

8 fiók 588x367 mm, teleszkópos, csapágyszegélyezett

- Alumínium nyitórendszer, a fiók teljes hosszában elhelyezve
- A fiókok habgumival bélelték
- Központi zár elöl
- Hőformált tálcák elhelyezési lehetősége

📦 78,9 kg



h	max
70 mm	30 kg
175 mm	40 kg

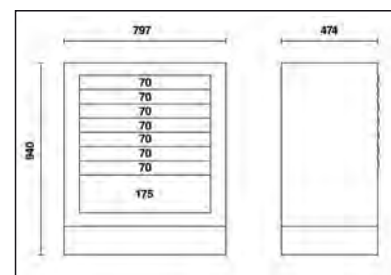
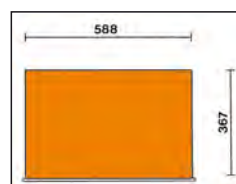

C55M8

Ft 955.500 1 055000207

C55CS

Rögzített szelektív hulladékgyűjtő modul műhelyberendezéshez

- Kihúzható 588x465 méretű hulladékgyűjtő rekesz, golyóscsapágyszegélyezett vezetőnkön- 2 nagy térfogatú kihúzható belső tartály a hulladék szétválasztásához

📦 61,4 kg

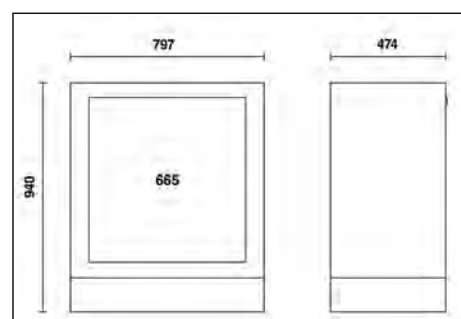

C55 CS

Ft 852.200 1 055000208

C55MA

2 ajtós rögzített modul műhelyberendezéshez

- Zárral ellátva
- Magasságában állítható belső polccal

75 kg

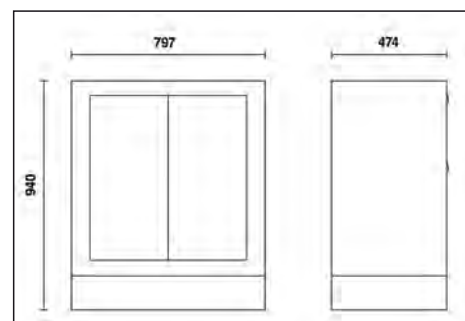

C55MA

Ft 728.700 1 055000205

C55MDO

Rögzített olajelosztó modul műhelyberendezéshez

- 2 tekercselő, 7 m - 1/2" gumicsővel együtt
- 2 digitális literszámlálóval rendelkező pisztoly automatikus cseppvédővel
 - legnagyobb szállítási mennyiség: 30 l/p
 - viszkozitás: 8÷2000 mPas

93,4 kg

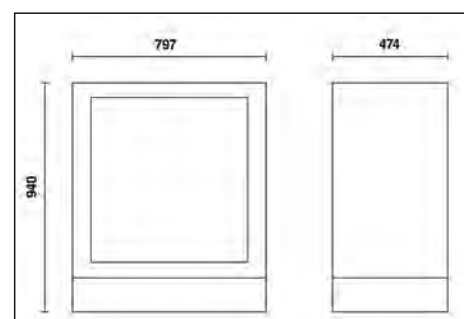

C55MDO

Ft 1.478.200 1 055000210

C55MS

rögzített szervizmodul műhelyberendezéshez

- Beépített hulladékartó
- Üreg a papírtekercstartó számára
- 1 rakodófiók 305x270 mm

75 kg



C55MS

Ft 769.200 1 055000204

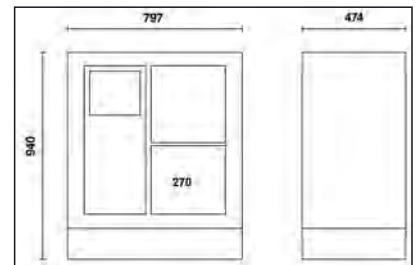

C55T3

kocsi

- 3 csúszásmentes bordázott gumival fedett munkalap
- Ergonomikus fogantyú
- A központi munkalap kétféleképpen is rögzíthető
- Négy Ø 100 mm (kettő fékezhető)
- Statikus terhelhetőség: 200 kg (3 polc között elosztva)

22,8 kg

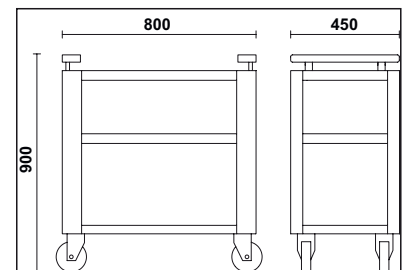

C55T3

Ft 173.700 1 055000219

C55P/MCD

összekötő tartó konzol a panelek toldásához

10 kg

C55P/MCD Ft 73.250 1 055000257



C55P/2MDX-SX

Jobb és bal oldali tartó konzol a végekre

10 kg

C55P/2MDX-SX Ft 133.600 1 055000253



C55PM

1 m széles függesztett szekrény műhelyberendezéshez

• Méretek: 1024x400x300 mm, gázrugós megoldás az ajtó könnyebb nyitásához és zárásához

23,4 kg

C55PM Ft 487.900 1 055000302

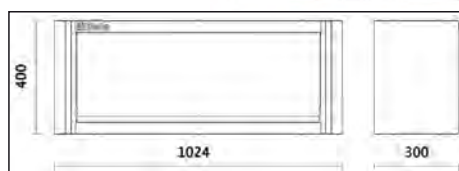

C55PFA-1,0

1 m széles perforált szerszámtartó panel műhelyberendezéshez

Perforált acél szerszámtartó panel
(1024x1020x25 mm)

11 kg

C55PFA-1,0 Ft 164.000 1 055000316

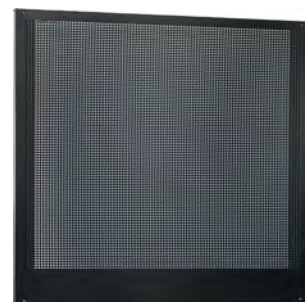

C55/PF

1 méter széles szekrény alatti perforált szerszámtartó panel

• Perforált szerszámtartó panel (1024x620 mm)
az 1,0X0,6 méretű C55PT-hez

6 kg

C55/PF Ft 112.600 1 055000307



C55PT1,0X0,6

1 m széles panel faliszekrény alá

Méreték: 1024x620x25 mm

8 kg

C55PT1,0X0,6 Ft 89.850 1 055000314



C55PTE-1,0

1 m széles panel faliszekrény alá

Méreték: 1024x620x25 mm

2 elektromos aljzat fogadására (az aljzat nem tartozék)

8 kg

C55PTE-1,0 Ft 106.900 1 055000319



C55/2PM

2 polcos fal műhelyberendezéshez

- 2 db 1024x400x300 mm méretű polc, az ajtók nyitásának és zárásának megkönnyítésére gázrugókkal felszerelve.
- Fali panel 1024x620 mm, C55/PF perforált szerszámtartó panelek számára (külön kell rendelni)
- Önhordó szerkezettel rendelkezik
- 2 méteres munkapadhoz társítható

82,7 kg

C55/2PM Ft 1.362.300 1 055000301

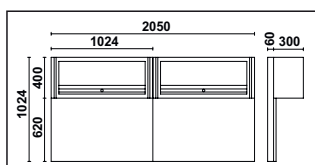
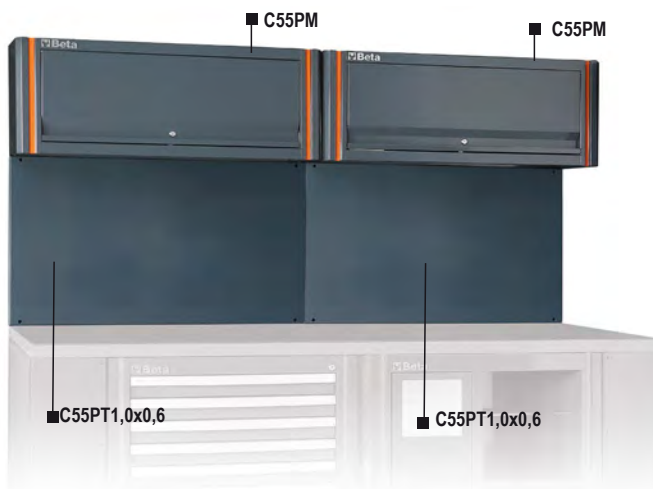

C55PFA-0,8

0,8 m széles perforált szerszámtartó panel

Lyukacsos acél perforált panel
(800x1020x25 mm)

10 kg

C55PFA-0,8 Ft 151.000 1 055000315

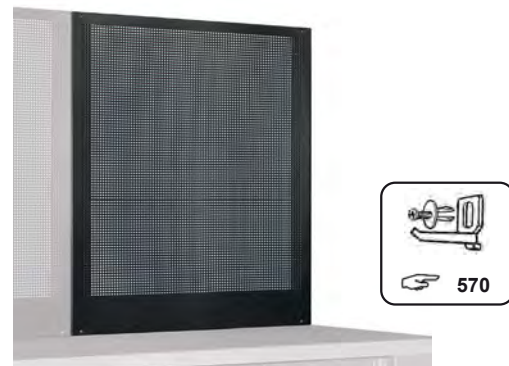

C55PM/M0,8

0,8 m széles függesztett szekrény

Méreték: 800x400x300 mm, gázrugós megoldás az ajtó könnyebb nyitásához és zárásához

19 kg

C55PM/M0,8 Ft 468.400 1 055000312



C55PTE-0,8

0,8 m széles panel faliszekrény alá

Méreték: 800x620x25 mm

1 elektromos aljzat fogadására (az aljzat nem tartozék)

6 kg

C55PTE-0,8 Ft 96.950 1 055000318



C55PT0,8X0,6

0,8 m széles panel faliszekrény alá

Méreték: 800x620x25 mm

7,8 kg

C55PT0,8X0,6 Ft 83.800 1 055000313



C55/1PF

perforált szerszámtartó panel
műhelyberendezéshez

• Perforált panel 800x620 mm
a szerszámok elhelyezéséhez

4,6 kg

C55/1PF Ft 70.250 1 055000309



C55PS

redőnyös szerszámtartó fal műhelyberendezéshez

- Fügőlegesen mozgatható, zárral rendelkező alumínium redőny
- Levehető perforált panel a szerszámok elhelyezéséhez
- Önhordó szerkezettel szállítva
- 50 horgos GPS készlettel
- 2 méteres munkapadhoz társítható

85,7 kg

	Ft		
C55PS-O	1.016.600	1	055000250
C55PS-G	1.016.600	1	055000255

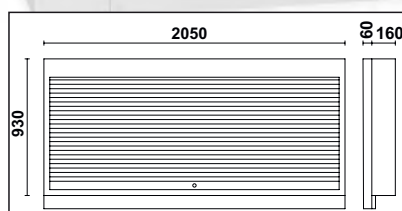

C55PSE

redőnyös szerszámtartó fal
2 elektromos aljzattal

- Fügőlegesen mozgatható, zárral rendelkező alumínium redőny
- Levehető perforált szerszámtartó panel
- Önhordó szerkezettel szállítva
- 50 horgos GPS készlettel
- Elektromos aljzat kivágással
- 2 méteres munkapadhoz társítható

85,7 kg

	Ft		
C55PSE-O	1.026.300	1	055000258
C55PSE-G	1.026.300	1	055000260

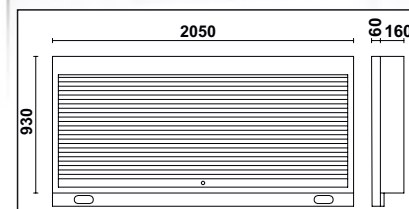

C55AE

2 m széles profil elektromos aljzatok fogadására

Méret: 2050x25x90mm

2 elektromos aljzat fogadására

3 kg

	Ft		
C55AE	89.850	1	055000325



C55AC

önálló teljes sarok

Munkalap (700x700 mm) tartólábbal
2 felső szerszámtartó fal 2 rögzítőpolccal (670x160 mm)

63 kg

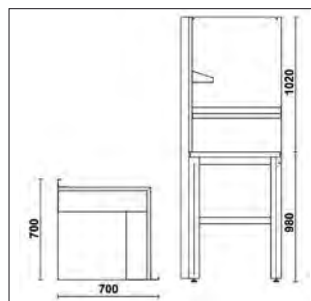

C55AC-O

C55AC-G

C55AC-O	1.116.600	1	055000360
C55AC-G	1.116.600	1	055000380

C55KAI

sarok munkalap műhelyberendezés összeállításához, 700x700 méret lábakkal

• Ütésbiztos és szénhidrogéneknek ellenálló,
karcvédett PVC réteggel burkolt, 700x700 mm
festett lemez munkalap

33 kg

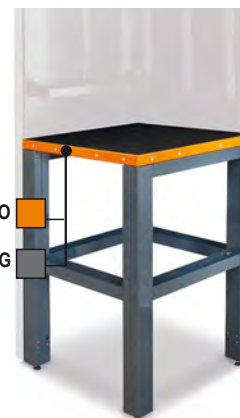

C55KAI-O

C55KAI-G

C55KAI-O	642.500	1	055000365
C55KAI-G	642.500	1	055000385

C55MP

acél sarokpolc falra

Méretek: 700x160x80 mm

3 kg



C55MP	66.800	1	055000374
-------	--------	---	-----------

Beta

C55A1

Egyajtós lemez szerszámszekrény műhelyberendezés összeállításához

- 3 db állítható magasságú polc
- Praktikus visszahajtható ruhatartó sín az első polc alatt
- Zárható
- Hasznos belső méret: 1770 mm x 420 mm x 420 mm

📦 47,3 kg

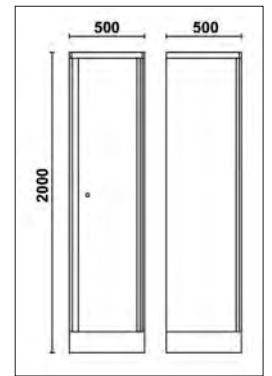

C55A1 Ft 354.700 1 055000411

C55A1/R42

polc a C55A1/C55AT1 szerszámszekrényhez

📦 1,9 kg



C55A1/R42 497x403 mm Ft 15.400 1 055000461

C55 A1/RB42

Polc a C55A1/C55AT1 szerszámszekrényhez, ruhatartó sìnnel

📦 2,3 kg



C55 A1/RB42 mm 497x403 Ft 19.250 1 055000463



C55A2

2 ajtós lemezszekrény műhelyberendezéshez

- 3 db állítható magasságú polc
- Zárral ellátva
- Hasznos belső méretek: 1798x797x403 mm

69,5 kg

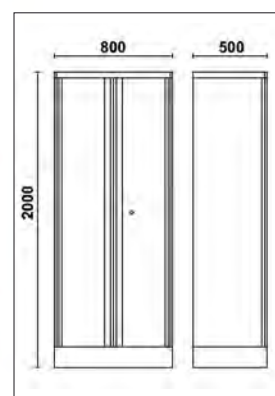

C55A2

Ft 474.900 1 055000412

C55A2/R70

polc a C55A2/C55AT2 szerszámszekrényhez

3,6 kg

50 kg



C55A2/R70

700x420 mm

Ft 24.700 1 055000462

Beta

C55AT1

lemez szerszámszekrény átlátszó polikarbonát ajtóval
műhelyberendezéshez

- 3 db állítható magasságú polc
- Zárható
- Hasznos belső méret: 1798x497x403 mm

41 kg

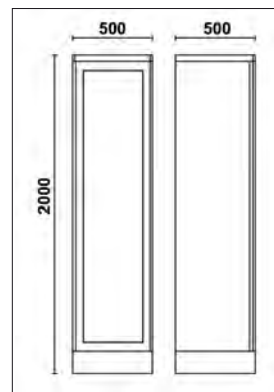

C55AT1 Ft 394.700 1 055000421

C55AT2

lemez szerszámszekrény átlátszó polikarbonát ajtóval
műhelyberendezéshez

- 3 db állítható magasságú polc
- Zárható
- Hasznos belső méret: 1798x797x403 mm

56 kg

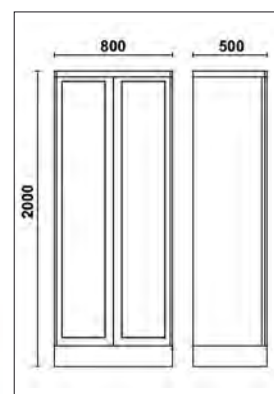

C55AT2 Ft 534.400 1 055000422

C55STR

színes ragasztószalag, 25 m

lehetővé teszi a függőleges betétek színének személyre szabását a C55
műhelyberendezésnél



RAL2011
RAL3000
RAL6029
RAL9016
RAL1023
RAL5015
RAL1035
RAL9006

		Ft	1	055000901
C55STR-O/2011	Orange	36.050	1	055000901
C55STR-R/3000	Red	36.050	1	055000903
C55STR-V/6029	Green	36.050	1	055000906
C55STR-Y/1023	Yellow	36.050	1	055000905
C55STR-B/5015	Blue	36.050	1	055000904
C55STR-S/9006	Grey	36.050	1	055000902





MŰHELYBERENDEZÉST RSC50 2.0



A Beta a piaci trendekkel összhangban folyamatosan fejlődik, hogy sikeresen megfeleljen a jövő kihívásainak. Ennek eredményeként **továbbfejlesztette az RSC50 műhelyberendezést**, létrehozva az új, forradalmi RSC50 2.0 rendszert.

Az új, **70 cm széles munkalap**, a háromféle választható anyag (fémlemez, rétegelt fa és rozsdamentes acél bevonatú MDF) teszik az RSC50 2.0-t egyedülálló termékcsaláddá, amely Olaszországban készült.

Az RSC50 2.0 a modern design és a páratlan funkcionalitás tökéletes kombinációja, amelyet a mai szakemberek igényeinek megfelelően terveztek.



Termékcsaládunk a következő alapvető koncepciókra épül:



MINŐSÉG

A nagy gondossággal megválasztott anyagok, a részletekre fordított aprólékos figyelem és nem utolsósorban a magával ragadó design teszi az RSC50 2.0-et egyedülálló műhelyberendezéssé.



PRAKTIKUM ÉS ROBOSZTUSSÁG

A 70 cm mély munkalap nagy, kényelmes és praktikus munkafelületet biztosít. A satu is könnyedén felszerelhető a munkalapra, így lehetővé teszi a nagy igénybevételű jelentő munkák elvégzését is.



HATÉKONYSÁG

A termékcsalád különböző részeinek optimalizált kialakításának köszönhetően egyszerűen és gyorsan összeállítható.



RUGALMASSÁG

Minden műhelyberendezés összeállítása igény szerint bármikor bővíthető vagy módosítható. A munkalap anyaga szabadon megválasztható: lehet fémlemez, rétegelt fa vagy rozsdamentes acéllal bevont MDF.



KOMPATIBILITÁS

A Beta szabványos méretű (588 mm x 367 mm) fiókaiba számos szerszámmodul fér el, amelyek puha EVA és kemény ABS kivitelben érhetőek el.

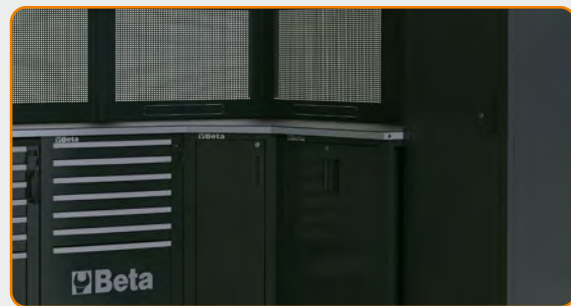
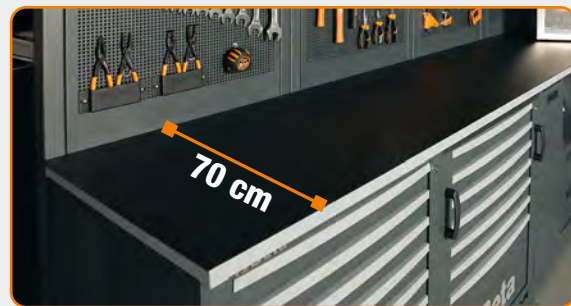



MŰHELYBERENDEZÉST RSC50 2.0



Konfigurálja online a műhelyét 3D nézetben a www.beta-tools.com oldalon

A Beta által szakemberek számára kifejlesztett RSC50 2.0 műhelyberendezés előre összeállított kombinációkat kínál, de lehetőséget biztosít arra is, hogy saját igényei szerint alakítsa ki munkaterületét. Számos munkalap alá elhelyezhető modul, falra szerelhető szekrény és berendezési kiegészítő közül választhat.

A fiókfogantyúk, a munkalapok alatti lámpák és a faliszekrények egyedi színei különleges műhelyberendezést eredményeznek, így az RSC50 2.0 ideális választás azok számára, akiknek fontos az esztétikus, modern munkakörnyezet



RSC50 2.0 I

RSC50 2.0 műhelyberendezés összeállítás

Az összeállítás a következőkből áll:

- 1 db munkalap, 2240 mm x 700 mm (RSC50 2.0 NPG/3-2.2MT)
- 1 db munkalap, 1495 mm x 700 mm (RSC50 2.0 NPG/2-1.5MT)
- 1 db 7 fiókos rögzített modul (RSC50 2.0 M7)
- 1 db 7 fiókos szerszámkocsi (RSC50 2.0 C7)
- 1 db 2 fiókos rögzített kiszolgáló modul (RSC50 2.0 MS-2C)
- 1 db önálló teljes sarok (RSC50 2.0 NAC-G)
- 1 db 5 fiókos rögzített modul (RSC50 2.0 M5)
- 1 db rögzített kétajtós modul (RSC50 2.0 MA)
- 5 db faliszekrény (RSC50 2.0 PM)
- 5 db felső perforált szerszámtartó panel (RSC50 2.0 PFS)
- 5 db alsó perforált szerszámtartó panel (RSC50 2.0 PFI)
- 5 pár jobb- és baloldali konzol (RSC50 2.0 P/2MDX-SX)
- 2 db egyajtós szekrény (RSC50 2.0 A1)

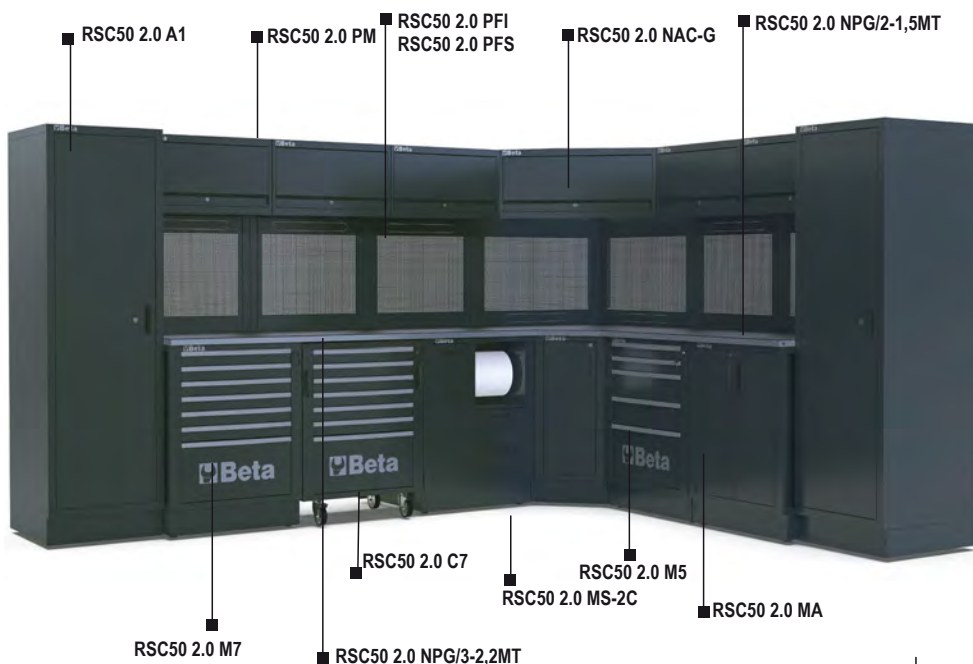

2000
760
3864 / 3119

804 kg

RSC50 2.0 I Ft 10.104.900 1 050001046

RSC50 2.0 L

RSC50 2.0 műhelyberendezés összeállítás

Az összeállítás a következőkből áll:

- 1 db munkalap, 2240 mm x 700 mm (RSC50 2.0 NPG/3-2.2MT)
- 1 db munkalap, 750 mm x 700 mm (RSC50 2.0 NPG/1-0.7MT)
- 1 db rögzített kiszolgáló modul (RSC50 2.0 MS-2AVV) 1900S 8x10 sűrített levegős tömlődobbal és 1844 15-H05/SCK kábeldobbal (tartozék)
- 1 db 7 fiókos szerszámkocsi (RSC50 2.0 C7)
- 1 db 7 fiókos rögzített modul (RSC50 2.0 M7)
- 1 db önálló teljes sarok (RSC50 2.0 NAC-G)
- 1 db rögzített, kétajtós modul (RSC50 2.0 MA)
- 1db alumínium redőnyös szerszámtartó fal és önhordó szerkezet (RSC50 2.0 PS)
- 2 db faliszekrény (RSC50 2.0 PM)
- 2 db felső perforált szerszámtartó panel (RSC50 2.0 PFS)
- 2 db alsó perforált szerszámtartó panel (RSC50 2.0 PFI)
- 2 pár jobb- és baloldali konzol (RSC50 2.0 P/2MDX-SX)
- 1 db egyajtós szerszámkoszár (RSC50 2.0 A1)

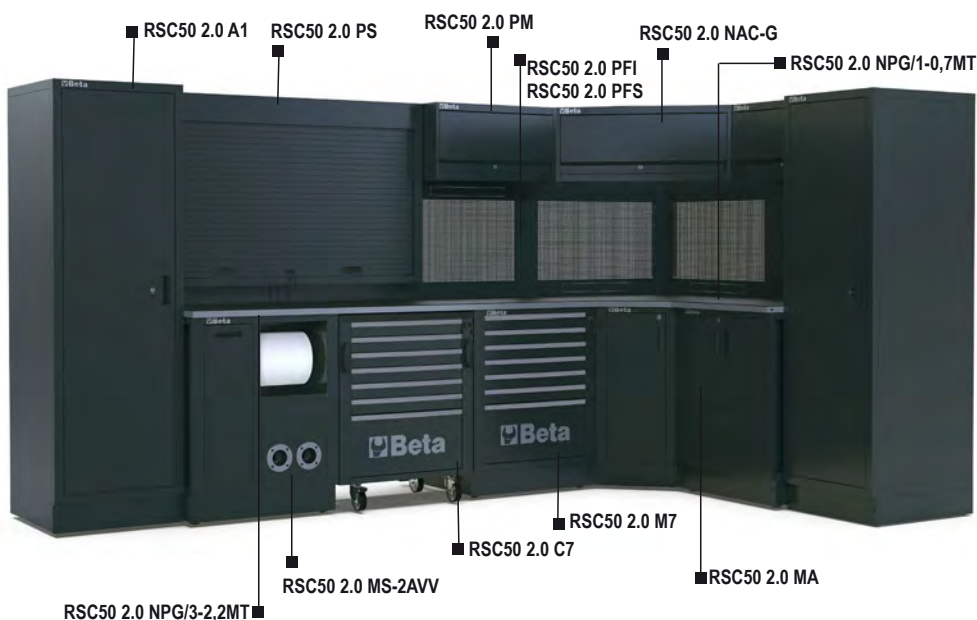

2000
760
3864 / 2374

720 kg

RSC50 2.0 L Ft 9.014.200 1 050001051

RSC50 2.0

RSC50 2.0 műhelyberendezés összeállítás

Az összeállítás a következőkből áll:

- 1 db egyajtós szekrény (RSC50 2.0 A1)
- 1 db munkalap, 750 mm x 700 mm (RSC50 2.0 NPG/1-0.7MT)
- 1 db munkalap, 2240 mm x 700 mm (RSC50 2.0 NPG/3-2.2MT)
- 1 db 7 fiókos szerszámkocsi (RSC50 2.0 C7)
- 1 db 4 fiókos rögzített modul (RSC50 2.0 M4)
- 1 db 7 fiókos rögzített modul (RSC50 2.0 M7)
- 1 db rögzített kiszolgáló modul (RSC50 2.0 MS-AVV) 1900S 8x10 sűrített levegős tömlődobbal (tartozék)
- 1 db alumínium redőnyös szerszámtartó fal és önhordó szerkezet (RSC50 2.0 PS)
- 2 db faliszekrény (RSC50 2.0 PM)
- 2 db felső perforált szerszámtartó panel (RSC50 2.0 PFS)
- 2 db alsó perforált szerszámtartó panel (RSC50 2.0 PFI)
- 2 pár jobb- és baloldali konzol (RSC50 2.0 P/2MDX-SX)
- 1 db kétajtós szekrény (RSC50 2.0 A2)

604 kg

RSC50 2.0 Ft 6.949.600 1 050001001

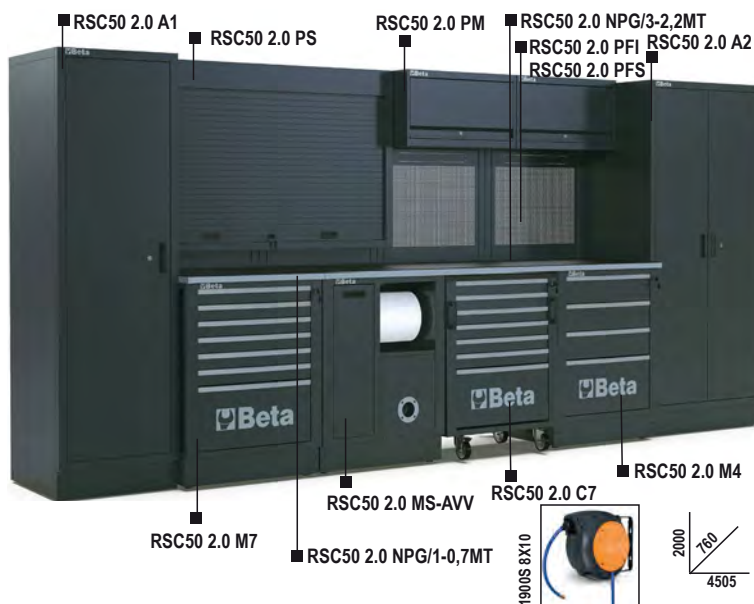

RSC50 2.0 H

RSC50 2.0 műhelyberendezés összeállítás

Az összeállítás a következőkből áll:

- 1 db munkalap, 2240 mm x 700 mm (RSC50 2.0 NPG/3-2.2MT)
- 1 db 2 fiókos rögzített kiszolgáló modul (RSC50 2.0 MS-2C)
- 1 db 7 fiókos szerszámkocsi (RSC50 2.0 C7)
- 1 db 7 fiókos rögzített modul (RSC50 2.0 M7)
- 1 db rögzített modul beépített mosdóval (RSC50 2.0 ML)
- 4 db faliszekrény (RSC50 2.0 PM)
- 4 db felső perforált szerszámtartó panel (RSC50 2.0 PFS)
- 4 db alsó perforált szerszámtartó panel (RSC50 2.0 PFI)
- 4 pár jobb- és baloldali konzol (RSC50 2.0 P/2MDX-SX)
- 1 db egyajtós szerszámos szekrény (RSC50 2.0 A1)

464 kg

RSC50 2.0 H Ft 6.058.300 1 050001041



RSC50 2.0 G

RSC50 2.0 műhelyberendezés összeállítás

Az összeállítás a következőkből áll:

- 1 db munkalap, 2240 mm x 700 mm (RSC50 2.0 NPG/3-2.2MT)
- 1 db rögzített kiszolgáló modul (RSC50 2.0 MS-2AVV) 1900S 8x10 sűrített levegős tömlődobbal és 1844 15-H05/SCK kábeldobbal (tartozék)
- 1 db 7 fiókos szerszámkocsi (RSC50 2.0 C7)
- 1 db 4 fiókos rögzített kiszolgáló modul (RSC50 2.0 M4)
- 3 db faliszekrény (RSC50 2.0 PM)
- 3 db felső perforált szerszámtartó panel (RSC50 2.0 PFS)
- 3 db alsó perforált szerszámtartó panel (RSC50 2.0 PFI)
- 3 pár jobb- és baloldali konzol (RSC50 2.0 P/2MDX-SX)
- 1 db kétajtós szerszámos szekrény (RSC50 2.0 A2)

416 kg

RSC50 2.0 G Ft 5.115.800 1 050001036



RSC50 2.0 F

RSC50 2.0 műhelyberendezés összeállítás

Az összeállítás a következőkből áll:

- 1 db munkalap, 2240 mm x 700 mm (RSC50 2.0 NPG/3-2.2MT)
- 1 db 7 fiókos rögzített modul (RSC50 2.0 M7)
- 1 db 7 fiókos szerszámkocsi (RSC50 2.0 C7)
- 1 db 2 fiókos rögzített kiszolgáló modul (RSC50 2.0 MS-2C)
- 3 db faliszekrény (RSC50 2.0 PM)
- 3 db felső perforált szerszámtartó panel (RSC50 2.0 PFS)
- 3 db alsó perforált szerszámtartó panel (RSC50 2.0 PFI)
- 3 pár jobb- és baloldali konzol (RSC50 2.0 P/2MDX-SX)
- 1 db kétajtós szerszamos szekrény (RSC50 2.0 A2)

411 kg

RSC50 2.0 F

Ft 5.014.800 1 050001031



RSC50 2.0 FX

RSC50 2.0 műhelyberendezés összeállítás

Az összeállítás a következőkből áll:

- 1 db rozsdamentes acéllal fedett MDF munkalap, 2240 mm x 700 mm (RSC50 2.0 PX/3-2.2MT)
- 1 db 7 fiókos rögzített modul (RSC50 2.0 M7)
- 1 db 7 szerszámkocsi (RSC50 2.0 C7)
- 1 db 2 fiókos rögzített kiszolgáló modul (RSC50 2.0 MS-2C)
- 3 db faliszekrény (RSC50 2.0 PM)
- 3 db felső perforált szerszámtartó panel (RSC50 2.0 PFS)
- 3 db alsó perforált szerszámtartó panel (RSC50 2.0 PFI)
- 3 pár jobb- és baloldali konzol (RSC50 2.0 P/2MDX-SX)
- 1 db kétajtós szerszamos szekrény (RSC50 2.0 A2)

405 kg

RSC50 2.0 FX

Ft 4.840.300 1 050001032



RSC50 2.0 FW

RSC50 2.0 műhelyberendezés összeállítás

Az összeállítás a következőkből áll:

- 1 db rétegelt fa munkalap, 2240 mm x 700 mm (RSC50 2.0 PW/3-2.2MT)
- 1 db 7 fiókos rögzített modul (RSC50 2.0 M7)
- 1 db 7 fiókos szerszámkocsi (RSC50 2.0 C7)
- 1 db 2 fiókos rögzített kiszolgáló modul (RSC50 2.0 MS-C2)
- 3 db faliszekrény (RSC50 2.0 PM)
- 3 db felső perforált szerszámtartó panel (RSC50 2.0 PFS)
- 3 db alsó perforált szerszámtartó panel (RSC50 2.0 PFI)
- 3 pár jobb- és baloldali konzol (RSC50 2.0 P/2MDX-SX)
- 1 db kétajtós szerszamos szekrény (RSC50 2.0 A2)

386 kg

RSC50 2.0 FW

Ft 4.794.100 1 050001033



RSC50 2.0 E

RSC50 2.0 mőhelyberendezés összeállítás

Az összeállítás a következőköl áll:

- 1 db munkalap, 2240 mm x 700 mm (RSC50 2.0 NPG/3-2.2MT)
- 1 db 2 fiókos rögzített kiszolgáló modul (RSC50 2.0 MS-2C)
- 1 db 7 fiókos rögzített kiszolgáló modul (RSC50 2.0 M7)
- 1 db rögzített kétajtós modul (RSC50 2.0 MA)
- 3 db faliszekrény (RSC50 2.0 PM)
- 3 db felső perforált szerszámtartó panel (RSC50 2.0 PFS)
- 3 db alsó perforált szerszámtartó panel (RSC50 2.0 PFI)
- 3 pár jobb- és baloldali konzol (RSC50 2.0 P/2MDX-SX)

310 kg

RSC50 2.0 E

Ft 4.116.000 1 050001026



RSC50 2.0 D

RSC50 2.0 mőhelyberendezés összeállítás

Az összeállítás a következőköl áll:

- 1 db munkalap, 1495 mm x 700 mm (RSC50 2.0 NPG/2-1.5MT)
- 1 db 7 fiókos rögzített modul (RSC50 2.0 M7)
- 1 db rögzített, kétajtós modul (RSC50 2.0 MA)
- 2 db faliszekrény (RSC50 2.0 PM)
- 2 db felső perforált szerszámtartó panel (RSC50 2.0 PFS)
- 2 db alsó perforált szerszámtartó panel (RSC50 2.0 PFI)
- 2 pár jobb- és baloldali konzol (RSC50 2.0 P/2MDX-SX)
- 1 db egyajtós szekrény (RSC50 2.0 A1)

276 kg

RSC50 2.0 D

Ft 3.142.900 1 050001021

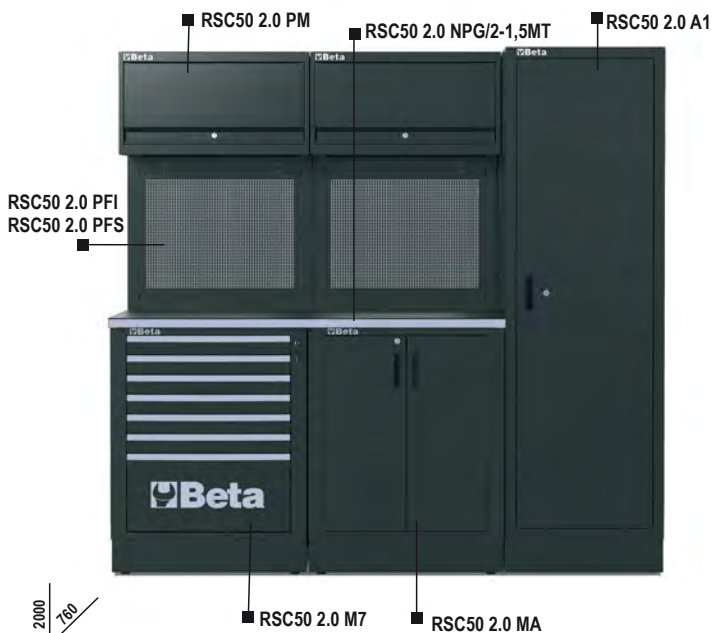

RSC50 2.0 DX

RSC50 2.0 mőhelyberendezés összeállítás

Az összeállítás a következőköl áll:

- 1 db rozsdamentes acéllal fedett MDF munkalap, 1495 mm x 700 mm (RSC50 2.0 PX/2-1.5MT)
- 1 db 7 fiókos rögzített modul (RSC50 2.0 M7)
- 1 db rögzített, kétajtós modul (RSC50 2.0 MA)
- 2 db faliszekrény (RSC50 2.0 PM)
- 2 db felső perforált szerszámtartó panel (RSC50 2.0 PFS)
- 2 db alsó perforált szerszámtartó panel (RSC50 2.0 PFI)
- 2 pár jobb- és baloldali konzol (RSC50 2.0 P/2MDX-SX)
- 1 db egyajtós szerszámos szekrény (RSC50 2.0 A1)

275 kg

RSC50 2.0 DX

Ft 3.030.400 1 050001023



RSC50 2.0 DW

RSC50 2.0 műhelyberendezés összeállítás

Az összeállítás a következőkből áll:

- 1 db rétegelt fa munkalap, 1495 mm x 700 mm (RSC50 2.0 PW/2-1.5MT)
- 1 db 7 fiókos rögzített modul (RSC50 2.0 M7)
- 1 db rögzített, kétajtós modul (RSC50 2.0 MA)
- 2 db faliszekrény (RSC50 2.0 PM)
- 2 db felső perforált szerszámtartó panel (RSC50 2.0 PFS)
- 2 db alsó perforált szerszámtartó panel (RSC50 2.0 PFI)
- 2 pár jobb- és baloldali konzol (RSC50 2.0 P/2MDX-SX)
- 1 db egyajtós szekrény (RSC50 2.0 A1)

263 kg

RSC50 2.0 DW

Ft 2.982.200 1 050001024



RSC50 2.0 C

RSC50 2.0 műhelyberendezés összeállítás

Az összeállítás a következőkből áll:

- 1 db munkalap, 1495 mm x 700 mm (RSC50 2.0 NPG/2-1.5MT)
- 1 db 2 fiókos rögzített kiszolgáló modul (RSC50 2.0 MS-2C)
- 1 db 7 fiókos rögzített modul (RSC50 2.0 M7)
- 2 db faliszekrény (RSC50 2.0 PM)
- 2 db felső perforált szerszámtartó panel (RSC50 2.0 PFS)
- 2 db alsó perforált szerszámtartó panel (RSC50 2.0 PFI)
- 2 pár jobb- és baloldali konzol (RSC50 2.0 P/2MDX-SX)
- 1 db egyajtós szekrény (RSC50 2.0 A1)

279 kg

RSC50 2.0 C

Ft 3.268.400 1 050001016

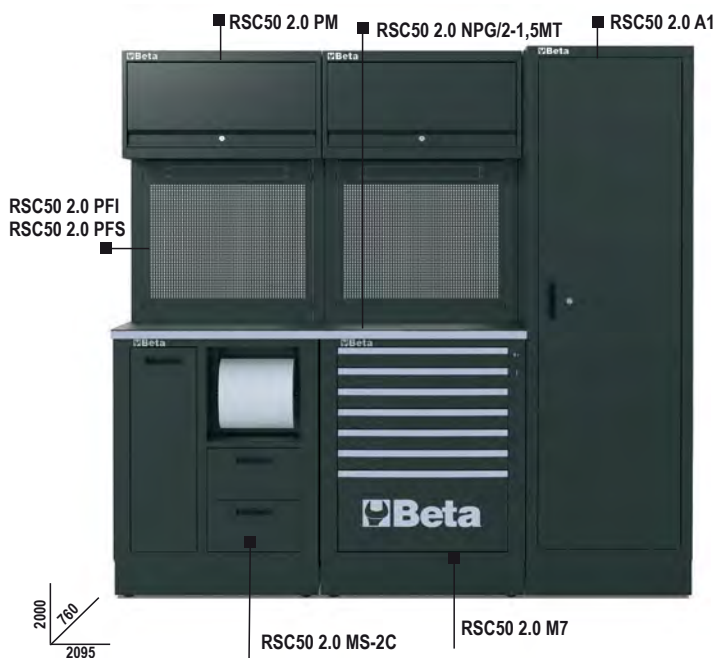

RSC50 2.0 B

RSC50 2.0 műhelyberendezés összeállítás

Az összeállítás a következőkből áll:

- 1 db munkalap, 1495 mm x 700 mm (RSC50 2.0 NPG/2-1.5MT)
- 1 db rögzített kétajtós modul (RSC50 2.0 MA)
- 1 db 7 fiókos rögzített modul (RSC50 2.0 M7)
- 1 db alumínium redőnyös szerszámtartó fal és önhordó szerkezet (RSC50 2.0 PS)

224 kg

RSC50 2.0 B

Ft 2.831.600 1 050001011



RSC50 2.0 A

RSC50 2.0 műhelyberendezés összeállítás

Az összeállítás a következőkből áll:

- 1 db munkalap, 1495 mm x 700 mm (RSC50 2.0 NPG)
- 1 db 7 fiókos rögzített modul (RSC50 2.0 M7)
- 1 db 2 fiókos rögzített kiszolgáló modul (RSC50 2.0 MS-2C)
- 2 db faliszekrény (RSC50 2.0 PM)
- 2 db felső perforált szerszámtartó panel (RSC50 2.0 PFS)
- 2 db alsó perforált szerszámtartó panel (RSC50 2.0 PFI)
- 2 pár jobb- és baloldali konzol (RSC50 2.0 P/2MDX-SX)

212 kg

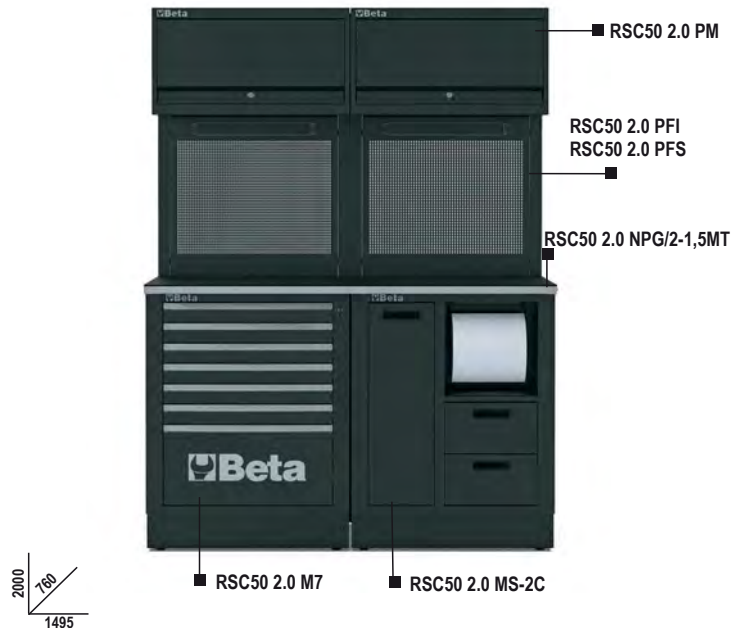

RSC50 2.0 A	Ft	1	050001006
	2.864.800		

RSC50 2.0 NP/1-0,7MT

Fémlemez munkalap, 0,75 m széles, munkapadhoz, az RSC50 2.0 műhelyberendezés összeállításához
 Ütéselnyelő és szénhidrogéneknek ellenálló karvédett PVC réteggel burkolt 750 mm x 700 mm festett lemez munkalap.
 Két külső oldalbetéttel szállítva.

Mindkét oldalon a satu rögzítésére szolgáló furatokkal (1599P/125, a satu külön rendelhető).
 Alumínium profilra szerelt 5000 RSC50 2.0/PLEDC vagy 5000 RSC50 2.0/PLED-ST LED szalag (külön rendelhető) a munkapad alatti modulok megvilágítására.

16,7 kg

RSC50 2.0 NPA/1-0,7MT	Ft	1	050001117
RSC50 2.0 NPG/1-0,7MT	248.200		
	252.600		050001118

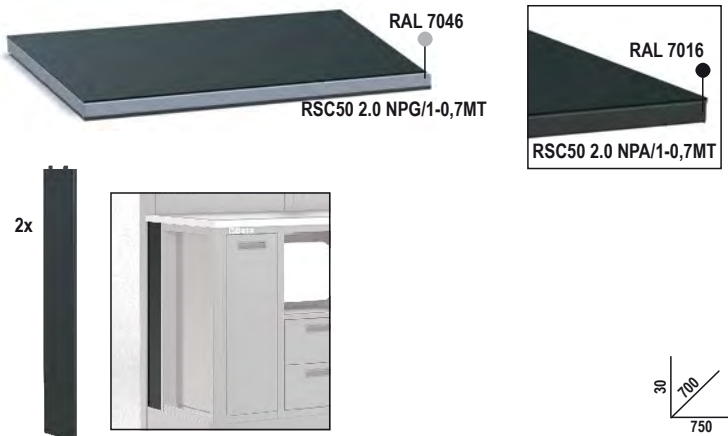

RSC50 2.0 NP/2-1,5MT

fémlemez munkalap, 1,5 m széles, munkapadhoz, az RSC50 2.0 műhelyberendezés összeállításához
 Ütéselnyelő és szénhidrogéneknek ellenálló karvédett PVC réteggel burkolt 1495 mm x 700 mm festett lemez munkalap.
 Két oldalbetéttel szállítva.

Mindkét oldalon a satu rögzítésére szolgáló furatokkal (1599P/125, a satu külön rendelhető).
 Alumínium profilra szerelt 5000 RSC50 2.0/PLEDC vagy 5000 RSC50 2.0/PLED-ST LED szalag (külön rendelhető) a munkapad alatti modulok megvilágítására.

31 kg

RSC50 2.0 NPA/2-1,5MT	Ft	1	050001124
RSC50 2.0 NPG/2-1,5MT	340.100		050001125

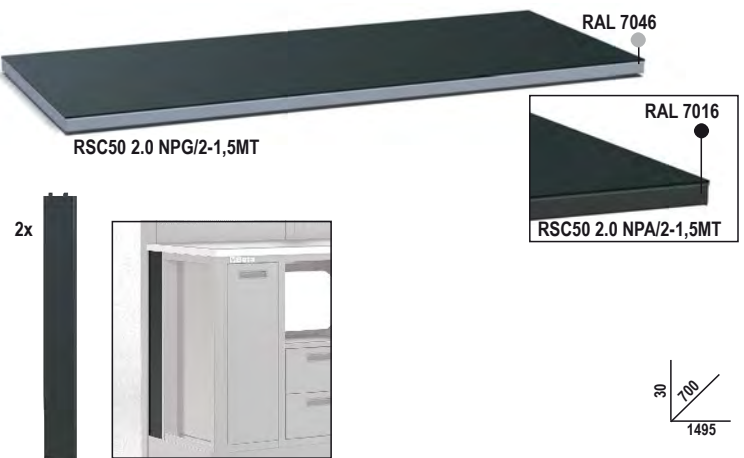

RSC50 2.0 NP/3-2,2MT

fémlemez munkalap, 2,2 m széles, munkapadhoz, az RSC50 2.0 műhelyberendezés összeállításához
Ütéselnyelő és szénhidrogéneknek ellenálló karcvédett PVC réteggel burkolt 2240 mm x 700 mm festett lemez munkalap.
Két külső oldalbetéttel szállítva.

Mindkét oldalon a satu rögzítésére szolgáló furatokkal (1599P/125, a satu külön rendelhető).
Alumínium profilra szerelt 5000 RSC50 2.0/PLEDC vagy 5000 RSC50 2.0/PLED-ST LED szalag (külön rendelhető) a munkapad alatti modulok megvilágítására.

49,6 kg

	Ft		
RSC50 2.0 NPA/2-2,2MT	477.700	1	050001132
RSC50 2.0 NPG/2-2,2MT	477.700	1	050001133

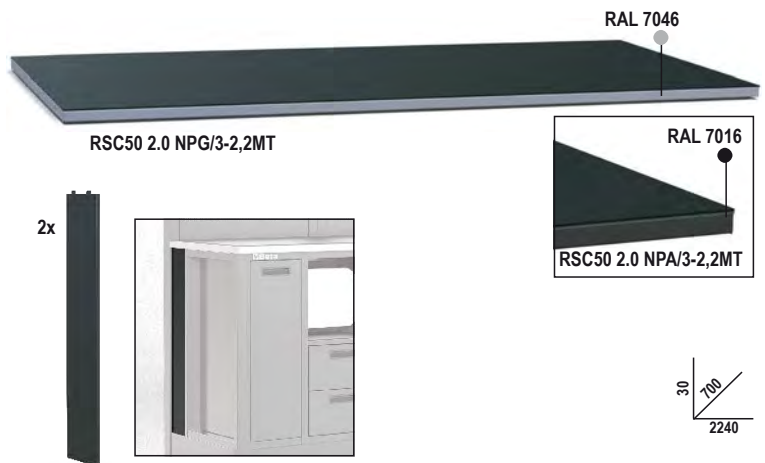

RSC50 2.0 PW/1-0,7MT

Rétegelt fa munkalap, 0,75 m széles, munkapadhoz, az RSC50 2.0 műhelyberendezés összeállításához
Rétegelt fa munkalap (750 mm x 700 mm)
Két külső oldalbetéttel szállítva.

Furatokkal a satu rögzítéséhez (1599P/125, a satu külön rendelhető)

7 kg

	Ft		
RSC50 2.0 PW/1-0,7MT	124.500	1	050001126



RSC50 2.0 PX/1-0,7MT

Rozsdamentes acéllal fedett MDF munkalap, 0,75 m széles, az RSC50 2.0 műhelyberendezés összeállításához

Rozsdamentes acéllal fedett MDF munkalap (750 mm x 700 mm).
Két külső oldalbetéttel szállítva.

Furatokkal a satu rögzítéséhez (1599P/125, a satu külön rendelhető)

13,5 kg

	Ft		
RSC50 2.0 PX/1-0,7MT	147.200	1	050001127



RSC50 2.0 PW/2-1,5MT

Rétegelt fa munkalap, 1,5 m széles, munkapadhoz, az RSC50 2.0 műhelyberendezés összeállításához
Rétegelt fa munkalap (1495 mm x 700 mm).
Két külső oldalbetéttel szállítva.

Furatokkal a satu rögzítéséhez (1599P/125, a satu külön rendelhető)

14,5 kg

	Ft		
RSC50 2.0 PW/2-1,5MT	179.400	1	050001130



RSC50 2.0 PX/2-1,5MT

Rozsdamentes acéllal fedett MDF munkalap, 1,5 m széles, az RSC50 2.0 műhelyberendezés összeállításához

Rozsdamentes acéllal fedett MDF munkalap (1495 mm x 700 mm).
Két külső oldalbetéttel szállítva.

Furatokkal a satu rögzítéséhez (1599P/125, a satu külön rendelhető)

27 kg

	Ft		
RSC50 2.0 PX/2-1,5MT	227.500	1	050001131



RSC50 2.0 PW/3-2,2MT

Rétegelt fa munkalap, 2,2 m széles, munkapadhoz, az RSC50 2.0 műhelyberendezés összeállításához

- Rétegelt fa munkalap (2240 mm x 700 mm)
- Két külső oldalbetéttel szállítva.



Furatokkal a satu rögzítéséhez (1599P/125, a satu külön rendelhető)

📦 21 kg

RSC50 2.0 PW/3-2,2MT	Ft	📦	🖨️
	257.100	1	050001136

RSC50 2.0 PX/3-2,2MT

Rozsdamentes acéllal fedett MDF munkalap, 2,2 m széles, az RSC50 2.0 műhelyberendezés összeállításához

Rozsdamentes acéllal fedett MDF munkalap (2240 mm x 700 mm). Két külső oldalbetéttel szállítva.



Furatokkal a satu rögzítéséhez (1599P/125, a satu külön rendelhető)

📦 40,5 kg

RSC50 2.0 PX/3-2,2MT	Ft	📦	🖨️
	303.200	1	050001137

RSC50 2.0 RB

Útéselyelő és szénhidrogéneknek ellenálló, karcálló PVC burkolat az RSC50 műhelyberendezés összeállításához

A munkalapok védelméhez elengedhetetlen.

RSC50 RB/0.63: 630x630 mm sarok munkalaphoz

RSC50 RB/0.75: 750 mm széles munkalaphoz

RSC50 RB/1.5: 1495 mm széles munkalaphoz

RSC50 RB/2.2: 2240 mm széles munkalaphoz



RSC50 RB/0,63	Ft	📦	🖨️
	25.100	1	050001140
RSC50 RB/0,75	30.350	1	050001141
RSC50 RB/1,5	60.500	1	050001142
RSC50 RB/2,2	90.900	1	050001143

RSC50 2.0 C5

5 fiókos szerszámkocsi az RSC50 2.0 műhelyberendezés összeállításához

- 5 db teleszkópos csapágyazott fiók (588 mm x 367 mm)
- 4 db forgókerék, Ø 100 mm (2 kerék fékezhető)
- A fiókok habgumival bélelték
- Központi zár elöl
- Keretbe épített fogantyúk a könnyebb kezelhetőség érdekében
- Mindegyik fiókba 4 EVA habszivacs vagy ABS hőformált tálca helyezhető el

📦 58 kg

RSC50 2.0 C5	Ft	📦	🖨️
	830.000	1	050001205

h	max
70 mm	25 kg
140 mm	30 kg
280 mm	35 kg

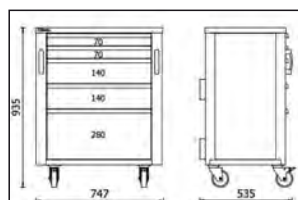
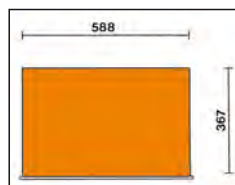

800 kg



RSC50 2.0 C6

6 fiókos szerszámkocsi az RSC50 2.0 műhelyberendezés összeállításához

- 6 db teleszkópos csapágyazott fiók (588 mm x 367 mm)
- 4 db forgókerék, Ø 100 mm (2 kerék fékezhető)
- A fiókok habgumival bélelték
- Központi zár elöl
- Keretbe épített fogantyúk a könnyebb kezelhetőség érdekében
- Mindegyik fiókba 4 EVA habszivacs vagy ABS hőformált tálca helyezhető el

61 kg

h	max
70 mm	25 kg
140 mm	30 kg
280 mm	35 kg

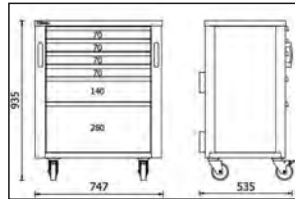
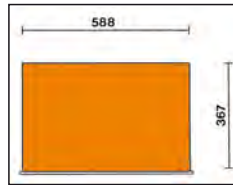

800 kg



RSC50 2.0 C6

Ft 848.200 1 050001206

RSC50 2.0 C7

7 fiókos szerszámkocsi az RSC50 2.0 műhelyberendezés összeállításához

- 7 db teleszkópos csapágyazott fiók (588 mm x 367 mm)
- 4 db forgókerék, Ø 100 mm (2 kerék fékezhető)
- A fiókok habgumival bélelték
- Központi zár elöl
- Keretbe épített fogantyúk a könnyebb kezelhetőség érdekében
- Mindegyik fiókba 4 EVA habszivacs vagy ABS hőformált tálca helyezhető el

62 kg

h	max
70 mm	25 kg
280 mm	35 kg

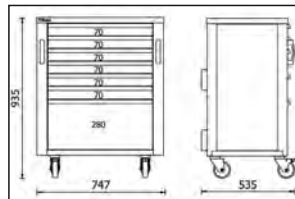
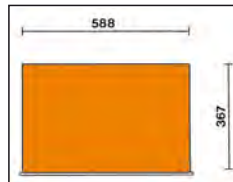

800 kg



RSC50 2.0 C7

Ft 866.400 1 050001207

 **Beta**

RSC50 2.0 C8

8 fiókos szerszámkocsi az RSC50 2.0 műhelyberendezés összeállításához

- 8 db teleszkópos csapágyazott fiók (588 mm x 367 mm)
- 4 db forgókerék, Ø 100 mm (2 kerék fékezhető)
- A fiókok habgumival béleletek
- Központi zár elöl
- Keretbe épített fogantyúk a könnyebb kezelhetőség érdekében
- Mindegyik fiókba 4 EVA habszivacs vagy ABS hőformált tálca helyezhető el

64 kg

RSC50 2.0 C8

Ft 886.600 1 050001208

h	max
70 mm	25 kg
140 mm	30 kg

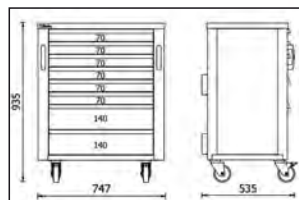
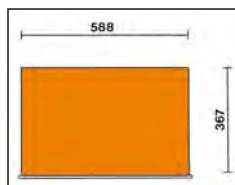

RSC50 2.0 M4

4 fiókos rögzített modul az RSC50 2.0 műhelyberendezés összeállításához

- 4 db teleszkópos csapágyazott fiók (588 mm x 367 mm)
- A fiókok habgumival béleletek
- Központi zár elöl
- Állítható magasságú lábak
- Mindegyik fiókba 4 EVA habszivacs vagy ABS hőformált tálca helyezhető el

61,5 kg

RSC50 2.0 M4

Ft 704.500 1 050001264

h	max
140 mm	30 kg
280 mm	35 kg

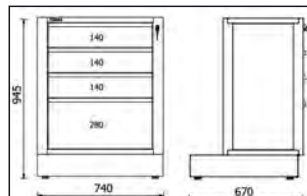
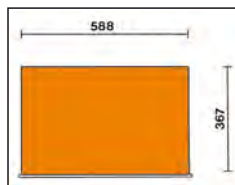

RSC50 2.0 M5

5 fiókos rögzített modul az RSC50 2.0 műhelyberendezés összeállításához

- 5 db teleszkópos csapágyazott fiók (588 mm x 367 mm)
- A fiókok habgumival béleletek
- Központi zár elöl
- Állítható magasságú lábak
- Mindegyik fiókba 4 EVA habszivacs vagy ABS hőformált tálca helyezhető el

63,5 kg

RSC50 2.0 M5

Ft 724.700 1 050001265

h	max
70 mm	25 kg
140 mm	30 kg
280 mm	35 kg

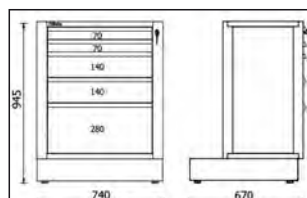
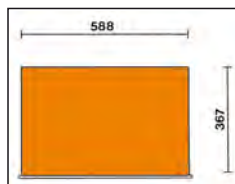

RSC50 2.0 M6

6 fiókos rögzített modul az RSC50 2.0 műhelyberendezés összeállításához

- 6 db teleszkópos csapágyazott fiók (588 mm x 367 mm)
- A fiókok habgumival bélelték
- Központi zár elől
- Állítható magasságú lábak
- Mindegyik fiókba 4 darab EVA habszivacs vagy ABS hőformált tálca helyezhető el

65,5 kg

h	max
70 mm	25 kg
140 mm	30 kg
280 mm	35 kg

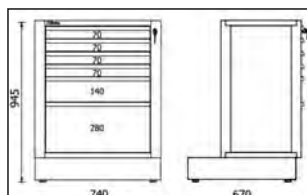
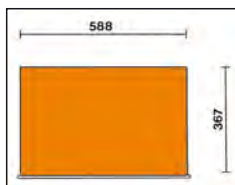

RSC50 2.0 M6

Ft 740.900 1 050001226

RSC50 2.0 M7

7 fiókos rögzített modul az RSC50 2.0 műhelyberendezés összeállításához

- 7 db teleszkópos csapágyazott fiók (588 mm x 367 mm)
- A fiókok habgumival bélelték
- Központi zár elől
- Állítható magasságú lábak
- Mindegyik fiókba 4 EVA habszivacs vagy ABS hőformált tálca helyezhető el

67,5 kg

h	max
70 mm	25 kg
280 mm	35 kg

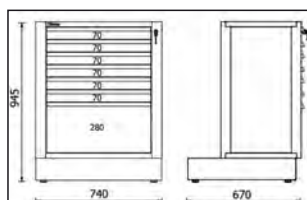
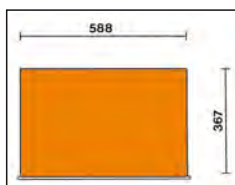

RSC50 2.0 M7

Ft 759.100 1 050001267

RSC50 2.0 M8

8 fiókos rögzített modul az RSC50 2.0 műhelyberendezés összeállításához

- 8 db teleszkópos csapágyazott fiók (588 mm x 367 mm)
- A fiókok habgumival bélelték
- Központi zár elől
- Állítható magasságú lábak
- Mindegyik fiókba 4 EVA habszivacs vagy ABS hőformált tálca helyezhető el

69,5 kg

h	max
70 mm	25 kg
140 mm	30 kg

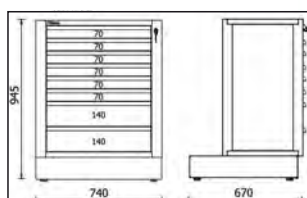
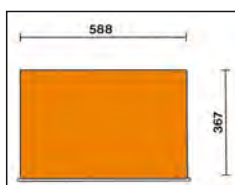

RSC50 2.0 M8

Ft 779.400 1 050001268

RSC50 2.0 M10

10 fiókos rögzített modul az RSC50 2.0 műhelyberendezés összeállításához

- 10 db teleszkópos csapágyazott fiók (588 mm x 367 mm)
- A fiókok habgumival bélelték
- Központi zár elöl
- Állítható magasságú lábak
- Mindegyik fiókba 4 EVA habszivacs vagy ABS hőformált tálca helyezhető el

h	max
70 mm	25 kg

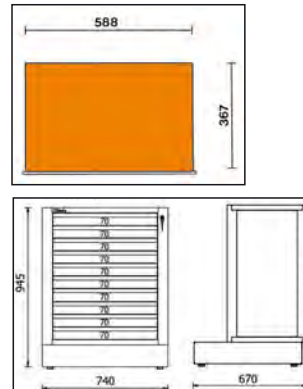

76 kg

RSC50 2.0 M10

Ft 816.200 1 050001231

RSC50 2.0 MS-2C

Rögzített kiszolgáló modul az RSC50 2.0 műhelyberendezés összeállításához

- Beépített hulladéktároló
- Beépített papírtekercstartó
- 2 db teleszkópos, csapágyazott fiók, 310 mm x 370 mm, 180 mm magas
- Fügőlegesen állítható talp

49 kg

RSC50 2.0 MS-2C

Ft 712.600 1 050001283

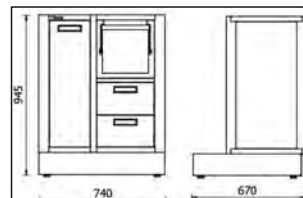

RSC50 2.0 MS-AVV

Rögzített kiszolgáló modul az RSC50 2.0 műhelyberendezés összeállításához, üres

Az alábbi dob párokkal rendelhető:

- 1900S 8x10 sűrített levegős tömlődob
- 1843 15-H05, 1844 10-H05, 1844 15-H05, 1844 15-H07, 1844 15-H05/SCK, 1844 15-H07/SCK, 1845 12-H05, 1846 10-H05, 1846 10-H07 és 1846 15-H05 kábeldob

- Beépített hulladéktároló
- Beépített papírtekercstartó
- Állítható magasságú lábak

49 kg

RSC50 2.0 MS-AVV

Ft 657.900 1 050001281

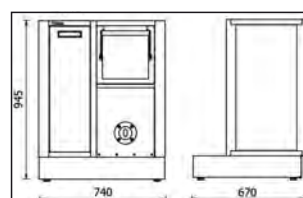

RSC50 2.0 MS-2AVV

Rögzített kiszolgáló modul az RSC50 2.0 műhelyberendezés összeállításához, üres

Az alábbi dob párokkal rendelhető:

- 1900S 8x10 sűrített levegős tömlődob
- 1843 15-H05, 1844 10-H05, 1844 15-H05, 1844 15-H07, 1844 15-H05/SCK, 1844 15-H07/SCK, 1845 12-H05, 1846 10-H05, 1846 10-H07 and 1846 15-H05 kábeldob

- Beépített hulladék tároló
- Beépített papírtekerstartó
- Állítható magasságú lábak

50 kg

RSC50 2.0 MS-2AVV

Ft 682.200 1 050001282

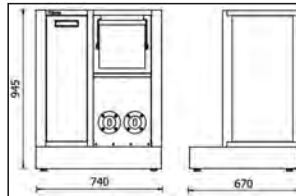

RSC50 2.0 MA

Rögzített, kétajtós modul az RSC50 2.0 műhelyberendezés összeállításához

- Zárható
- Állítható magasságú polc
- Belső méret: 615x435x740 mm
- Függőlegesen állítható talp

46 kg

RSC50 2.0 MA

Ft 587.000 1 050001262

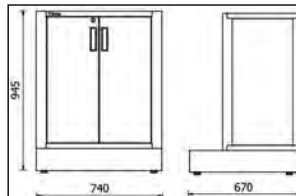

RSC50 2.0 CS

Rögzített szelektív hulladék tároló modul az RSC50 2.0 műhelyberendezés összeállításához

- 1 db teleszkópos, csapágyazott, kihúzható hulladék tároló (588x355x580 mm)
- 2 db tágas, kihúzható belső hulladék tároló rekesz szelektív gyűjtéshez
- Függőlegesen állítható talp

48 kg

RSC50 2.0 CS

Ft 682.200 1 050001285

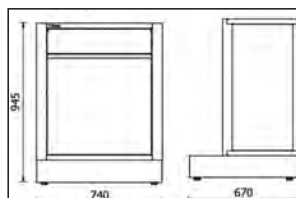

RSC50 2.0 ML

Rögzített modul beépített mosdóval az RSC50 2.0 műhelyberendezés összeállításához

Műszaki jellemzők:

- Rozsdamentes acél mosdótál
- Tartozékok:
 - 1 db keverő csaptelep
 - 1 db lefolyó
 - 1 db dugó
 - 1 db lefolyósűrő
 - 1 db szappanadagoló

Rögzített, zárható kétajtós modul:

- Hasznos belső méret: 615x435x575 mm
- Fügőlegesen állítható talp

39 kg

RSC50 2.0 ML Ft 732.800 1 050001284

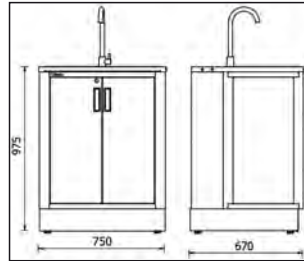

RSC50 2.0 MDO

Rögzített olajelosztó modul az RSC50 2.0 műhelyberendezés összeállításához

- 2 db tömlődob: 7 m - 1/2" tömlővel
- 2 db digitális literszámlálóval rendelkező pisztoly automatikus cseppvédevel
 - Legnagyobb szállítási mennyiség: 30 liter/perc
 - Vízkoztítás: 8÷2000 mPas
- Fügőlegesen állítható talp

92 kg

RSC50 2.0 MDO Ft 1.498.100 1 050001290

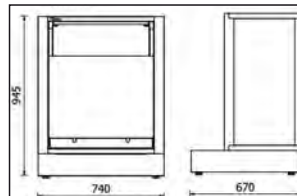

RSC50 2.0 T3

3 szintes szerszámkocsi az RSC50 2.0 műhelyberendezés összeállításához

- 4 db forgókerék, Ø 100 mm (kettő fékezhető)
- Statikus terhelhetőség: 200 kg (3 polc között elosztva)

23 kg

RSC50 2.0 T3 Ft 160.700 1 050001253

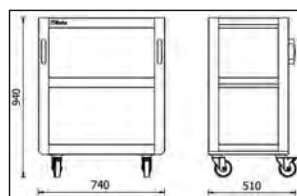

RSC50 2.0 KPF

Perforált szerszámtartó panel készlet az RSC50 2.0 műhelyberendezés összeállításához

Készlet tartalma:

- 1 db felső perforált szerszámtartó panel, 650x400x25 mm
- 1 db alsó perforált szerszámtartó panel, 650x625x25 mm, elektromos csatlakozónak kialakított 19" kerettel (nem tartozék)
- 1 pár jobb- és baloldali tartókonzol

17,5 kg

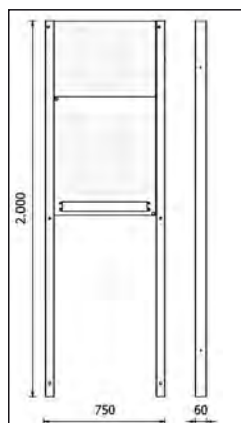

RSC50 2.0 KPF

Ft 273.100 1 050001310

RSC50 2.0 PFS

Felső perforált szerszámtartó panel az RSC50 2.0 műhelyberendezés összeállításához

- Perforáltszerszámtartó panel, 650x400x25 mm

3 kg

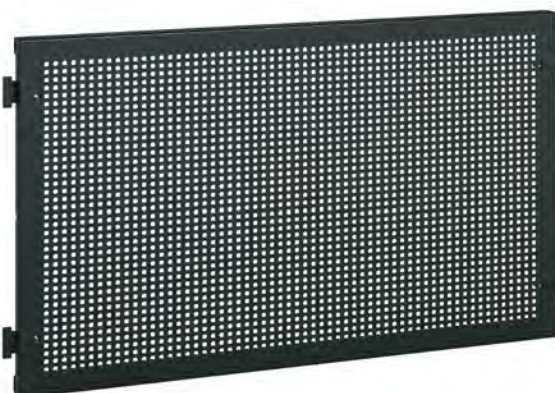

RSC50 2.0 PFS

Ft 77.750 1 050001312

RSC50 2.0 PFI

Alsó perforált szerszámtartó panel az RSC50 2.0 műhelyberendezés összeállításához

- Alsó perforált szerszámtartó panel, 650x625x25 mm
- Elektromos csatlakozónak kialakított 19" kerettel (nem tartozék)

4,5 kg



RSC50 2.0 PFI

Ft 88.850 1 050001313

RSC50 2.0 P/2MDX-SX

Egy pár jobb- és baloldali konzol perforált faliszerszámtartó rendszerekhez, az RSC50 2.0 műhelyberendezés összeállításához

8,5 kg

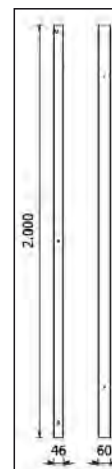

RSC50 2.0 P/2MDX-SX

Ft 106.500 1 050001352

RSC50 2.0 PM

Faliszekrény az RSC50 2.0 műhelyberendezés összeállításához

- Méretek: 740x300x400 mm
- Gázrugós megoldás az ajtó könnyebb nyitásához és zárásához
- Alumínium profilra szerelt 5000 RSC50 2.0/PLEDC vagy 5000 RSC50 2.0/PLED-ST LED szalag (külön rendelhető) a függesztett szekrény belsejének és/ vagy az alatta lévő munkaterület megvilágítására.

15 kg



30 kg

RSC50 2.0 PM

Ft 253.400 1 050001302

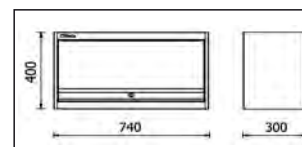

RSC50 2.0 MTP

Háromszögletű polc az RSC50 2.0 műhelyberendezés összeállításához

- Méretek: 740x300x400 mm
- Alumínium profilra szerelt 5000 RSC50 2.0/PLEDC vagy 5000 RSC50 2.0/PLED-ST LED szalag (külön rendelhető) a munkaterület megvilágítására

5 kg



10 kg

RSC50 2.0 MTP

Ft 129.100 1 050001305



 **Beta**



RSC50 2.0 PS

Redőnyös szerszámtartó fal az RSC50 2.0 műhelyberendezés összeállításához

- Fügőlegesen mozgatható, zárral rendelkező alumínium redőny
- Levehető perforált szerszámtartó panel
- Önördő szerkezettel szállítva
- 50 db horgos GPS készlettel

80 kg

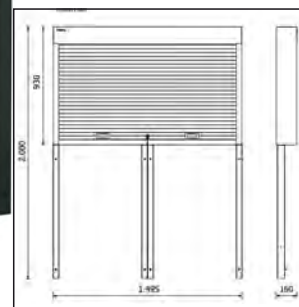

RSC50 2.0 PS

Ft 1.145.300 1 050001360

RSC50 2.0 NAC

Önálló teljes sarok az RSC50 2.0 műhelyberendezés összeállításához

- Ütéselnyelő és szénhidrogéneknek ellenálló, PVC réteggel burkolt, 964 mm x 964 mm, festett lemez sarok munkalap
- Zárható fali sarokpolc gázrugókkal a könnyebb ajtónyitásért és zárásért
- 2 db perforált szerszámtartó panel (869 mm x 1027)
- Alsó sarok modul nagy tárolórecesszel
- Fügőlegesen állítható talp

143 kg



RSC50 2.0 NAC-A

RAL 7016

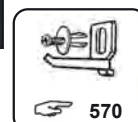

RAL 7046

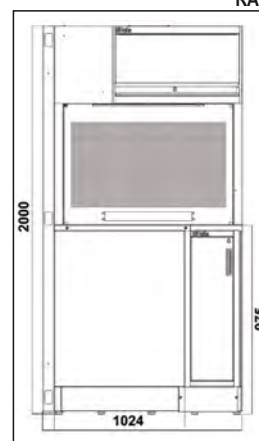

RSC50 2.0 NAC-G

RSC50 2.0 NAC-A	Ft 2.266.600	1	050001339
RSC50 2.0 NAC-G	Ft 2.266.600	1	050001340

 **Beta**

RSC50 2.0 NAC-W

Önálló teljes sarok az RSC50 2.0 műhelyberendezés összeállításához

- Rétegelt fa sarok munkalap (964 mm x 964 mm)
- Zárható fali sarokpolc gázrugókkal a könnyebb ajtónyitását és zárását
- 2 db perforált szerszámtartó panel (869 mm x 1027 mm)
- Alsó sarok modul nagy tárolórecesszel
- Fügőlegesen állítható talp

139 kg

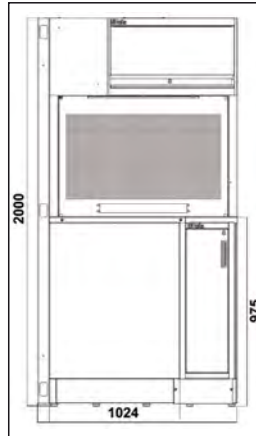
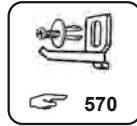

RSC50 2.0 NAC-W

RSC50 2.0 NAC-W

Ft 1.982.000 1 050001327

RSC50 2.0 NAC-X

Önálló teljes sarok az RSC50 2.0 műhelyberendezés összeállításához

- Rozsdamentes acéllal fedett MDF sarok munkalap (964 mm x 964 mm)
- Zárható fali sarokpolc gázrugókkal a könnyebb ajtónyitását és zárását
- 2 db perforált szerszámtartó panel (869 mm x 1027 mm)
- Alsó sarok modul nagy tárolórecesszel
- Fügőlegesen állítható talp

148 kg

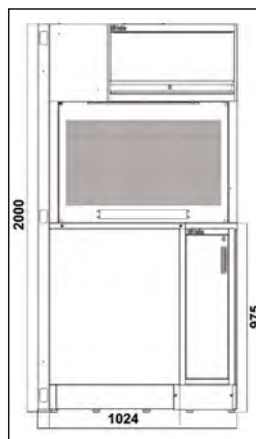

RSC50 2.0 NAC-X

RSC50 2.0 NAC-X

Ft 2.009.500 1 050001328

RSC50 2.0 KNAI

Alsó sarok modul az RSC50 2.0 műhelyberendezés összeállításához

- Ütéselnyelő és szénhidrogéneknek ellenálló karcvédett PVC réteggel burkolt 750 mm x 700 mm festett lemez munkalap
- Rögzített sarok modul nagy tárolórecesszel
- Fügőlegesen állítható talp

80 kg



RAL 7046

RAL 7016

RSC50 2.0 KNAI-A

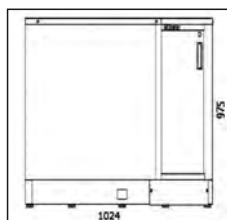

RSC50 2.0 KNAI-G

RSC50 2.0 KNAI-A

Ft 1.353.800 1 050001345

RSC50 2.0 KNAI-G

Ft 1.353.800 1 050001346

RSC50 2.0 KNAI-W

Alsó sarok modul az RSC50 2.0 műhelyberendezés összeállításához

- Rétegelt fa sarok munkalap (964 mm x 964 mm)
- Rögzített sarok modul nagy tárolórecesszel
- Függetlenül állítható talp

76 kg

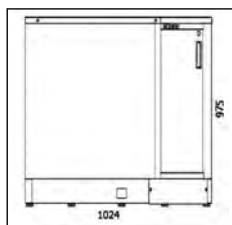

RSC50 2.0 KNAI-W

RSC50 2.0 KNAI-W

Ft 1.069.200 1 050001337

RSC50 2.0 KNAI-X

Alsó sarok modul az RSC50 2.0 műhelyberendezés összeállításához

- Rozsdamentes acéllal fedett MDF sarok munkalap (964 mm x 964 mm)
- Rögzített sarok modul nagy tárolórecesszel
- Függetlenül állítható talp

85 kg

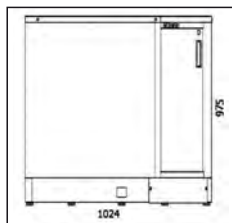

RSC50 2.0 KNAI-X

RSC50 2.0 KNAI-X

Ft 1.096.800 1 050001338

RSC50 2.0 A1

Egyajtós lemez szerszámszekrény az RSC50 2.0 műhelyberendezés összeállításához

- 4 db kivehető, állítható magasságú polc
- Praktikus visszahajtható ruhatartó sín az első polc alatt
- Zárható
- Belső méret: 590 mm x 615 mm
- Függetlenül állítható talp

67 kg

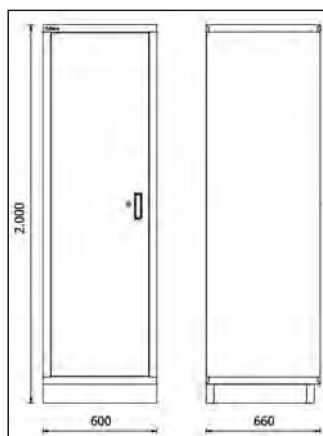

RSC50 2.0 A1

Ft 403.600 1 050001411

RSC50 2.0 A1/R59

Polc az RSC50 A1 szerszámszekrényhez

3,1 kg



RSC50 2.0 A1/R59 605x596 mm

Ft 25.100 1 050001913

RSC50 2.0 A1/RB59

Polc az RSC50 A1 szerszámszekrényhez, ruhatartó sínnel

3,4 kg

RSC50 2.0 A1/RB59 605x596 mm Ft 29.750 1 050001914



RSC50 2.0 A2

Kétajtós lemez szerszámszekrény az RSC50 2.0 műhelyberendezés összeállításához

- 4 db kivethető, állítható magasságú polc
- Zárható
- Belső méret: 910 mm x 615 mm
- Állítható magasságú lábakkal

85 kg

RSC50 2.0 A2 619.400 Ft 1 050001412

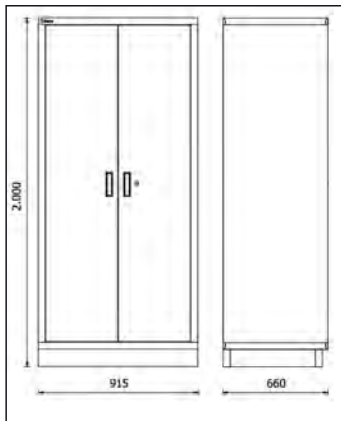

RSC50 2.0 A2/3C

3 fiókos, kétajtós lemez szerszámszekrény RSC50 2.0 műhelyberendezés összeállításához

- 4 db kivethető, állítható magasságú polc
- 3-fiókos (681 mm x 360 mm) modulal szállítva
- Zár elől
- Belső méret: 910 mm x 615 mm
- Állítható magasságú lábakkal

105,50 kg

RSC50 2.0 A2/3C 739.700 Ft 1 050001413

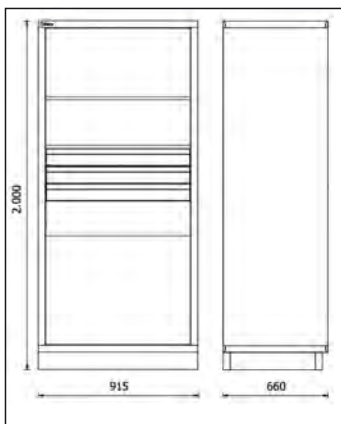
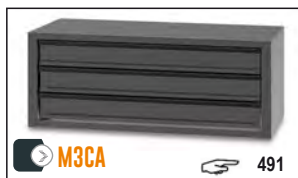

RSC50 2.0 A2/R91

Polc az RSC50 A2 szerszámszekrényhez

4,2 kg

RSC50 2.0 A2/R91 911x596 mm Ft 36.250 1 050001915



5000 RSC50 2.0/MP

Polc az RSC50 2.0 műhelyberendezés összeállításához

- Méretek: 740x140x80 mm
- Alumínium profilra szerelt 5000 RSC50 2.0/PLEDC vagy 5000 RSC50 2.0/PLED-ST LED szalag (külön rendelhető) a munkaterület megvilágítására

2,0 kg

5000 RSC50 2.0/MP

Ft 58.500 1 050001705

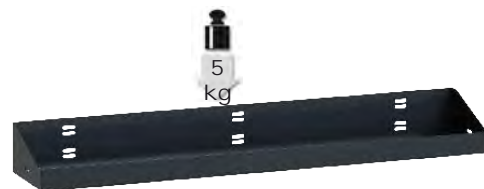

5000 RSC50/MPA140

Sarokpolc az RSC50 műhelyberendezés összeállításához

- Méretek: 630x630x35 mm, Mélység: 140 mm
- Alumínium profilra szerelt 5000 RSC50 2.0/PLEDC vagy 5000 RSC50 2.0/PLED-ST LED szalag (külön rendelhető) a munkaterület megvilágítására

3,8 kg

5000 RSC50/MPA140

Ft 77.550 1 050001706



5000 RSC50 2.0/CLL

Élvédő az RSC50 2.0 műhelyberendezés összeállításához

- Méretek: 740x125x30 mm
- A perforált szerszámtartó panelre rögzíthető
- Alumínium profilra szerelt 5000 RSC50 2.0/PLEDC vagy 5000 RSC50 2.0/PLED-ST LED szalag (külön rendelhető) a munkaterület megvilágítására

1 kg

5000 RSC50 2.0/CLL

Ft 58.500 1 050001710



5000 RSC50/CAL

Sarokvédő az RSC50 műhelyberendezés összeállításához

- Méretek: 655x655x30 mm
- Alumínium profilra szerelt 5000 RSC50 2.0/PLEDC vagy 5000 RSC50 2.0/PLED-ST LED szalag (külön rendelhető) a munkaterület megvilágítására

1,2 kg

5000 RSC50/CAL

Ft 77.550 1 050001711



5000 RSC50 2.0/KFC

10 db színes fiókelőlap az RSC50 2.0 műhelyberendezés összeállításához

Az RSC50 2.0 műhelyberendezés összeállítás fiók előlapjainak a testreszabásához.

Az antracitszürke RAL7016 (-A) munkalapokhoz ajánlott.

		Ft		
5000 RSC50 2.0/KFC2011		40.700	1	050001731
5000 RSC50 2.0/KFC3000		40.700	1	050001733
5000 RSC50 2.0/KFC5015		40.700	1	050001734
5000 RSC50 2.0/KFC7016		40.700	1	050001737

10x





MŰHELYBERENDEZÉSEK C45PRO 2.0

BÜSZKÉN MUTATJUK BE SIKERES TERMÉKCSALÁDUNK, A C45PRO 2.0 VÁLTOZATÁT.

Az új, **61,5 cm széles munkalappal** ellátott termékcsalád még praktikusabb és professzionálisabb, így a legigényesebb szakemberek igényeinek is tökéletesen megfelel.

C45PRO 2.0 to profesjonalne meble warsztatowe, które pomogą zoptymalizować stanowisko pracy. Oparte na nowym projekcie z 2021 roku i udoskonaleniach technicznych konstrukcji, mogą poszczycić się doskonałym stosunkiem jakości do ceny.

A **C45PRO 2.0 moduláris műhelyberendezéssel** a rendelkezésre álló helynek és a tervezett felhasználásnak megfelelő egyedi munkakörnyezetet alakíthat ki. Ez az előre összeállított kombinációkkal rendelkező egyszerű, rugalmas termékínálat idővel kibővíthető vagy átalakítható. Alternatív megoldásként munkaállomását teljes mértékben testre szabhatja kezdve a munkalappal - elérhető rozsdamentes acélal fedett MDF vagy rétegelt lemez verziókban - melyeket választása szerint kiegészíthet számos alkatrészsel és tartozékkal.

Alakítson ki az igényeinek megfelelő egyéni munkakörnyezetet. Legyen a műhelye, garázsa más, mint a többi. Válasszon az előre összeállított kombinációk közül, vagy valósítsa meg elképzeléseit egészen az alapoktól.



Beta

C45PRO 2.0

Konfigurálja saját műhelyét



látogasson el a www.beta-tools.com

C45PRO 2.0 DX

C45PRO 2.0 műhelyberendezés összeállítás

Az összeállítás a következőkből áll:

- 1 db rozsdamentes acélal fedett MDF munkalap, 2040 mm x 615 mm (C45PRO 2.0 PXE/3-2.0MT)
- 1 db rozsdamentes acélal fedett MDF munkalap, 1360 mm x 615 mm (C45PRO 2.0 PXE/2-1.3MT)
- 1 db 7 fiókos rögzített modul (C45PRO 2.0 M7)
- 1 db 7 fiókos szerszámkocsi (C45PRO 2.0 C7)
- 1 db rögzített szerviz modul (C45PRO 2.0 MS)
- 1 db 5 fiókos rögzített modul (C45PRO 2.0 M5)
- 1 db rögzített, kétajtós szekrény (C45PRO 2.0 MA)
- 1 db önálló teljes sarok rozsdamentes acélal fedett MDF munkalappal (C45PRO 2.0 CORNER/X)
- 5 db perforált szerszámtartó panel (C45PRO 2.0 PF)
- 5 db faliszekrény (C45PRO 2.0 PM)
- 7 db széles falikonzol (C45PRO 2.0 SL)
- 2 db keskeny falikonzol (C45PRO 2.0 SS)
- 2 db egyajtós szekrény (C45PRO 2.0 AS1)

640 kg

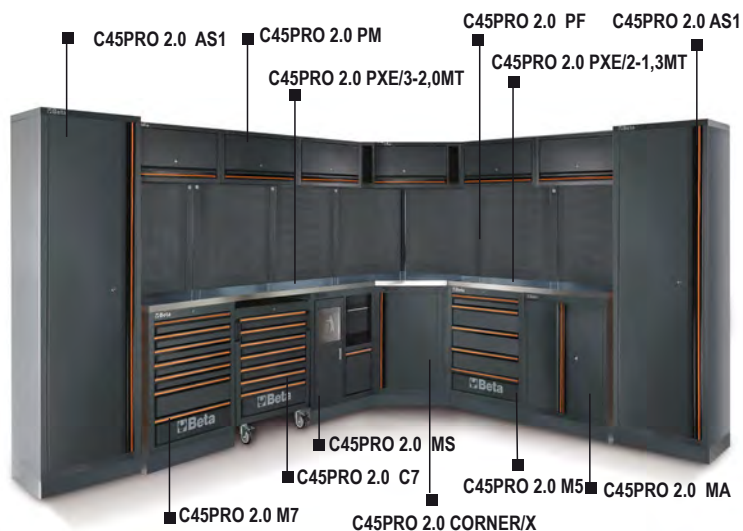

C45PRO 2.0 DX

Ft 4.685.400 1 045002031

2000
845
3718
3038

C45PRO 2.0 DW

C45PRO 2.0 műhelyberendezés összeállítás

Az összeállítás a következőkből áll:

- 1 db rétegelt fa munkalap, 2040 mm x 615 mm (C45PRO 2.0 PWE/3-2.0MT)
- 1 db rétegelt fa munkalap, 1360 mm x 615 mm (C45PRO 2.0 PWE/2-1.3MT)
- 1 db 7 fiókos rögzített modul (C45PRO 2.0 M7)
- 1 db 7 fiókos szerszámkocsi (C45PRO 2.0 C7)
- 1 db rögzített szerviz modul (C45PRO 2.0 MS)
- 1 db 5 fiókos rögzített modul (C45PRO 2.0 M5)
- 1 db rögzített, kétajtós modul (C45PRO 2.0 MA)
- 1 db önálló teljes sarok rétegelt fa munkalappal (C45PRO 2.0 CORNER/W)
- 5 db perforált szerszámartató panel (C45PRO 2.0 PF)
- 5 db faliszekrény (C45PRO 2.0 PM)
- 7 db széles falikonzol (C45PRO 2.0 SL)
- 2 db keskeny falikonzol (C45PRO 2.0 SS)
- 2 db egyajtós szekrény (C45PRO 2.0 AS1)

606 kg

C45PRO 2.0 DW

Ft 4.565.200 1 045002032

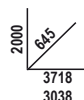
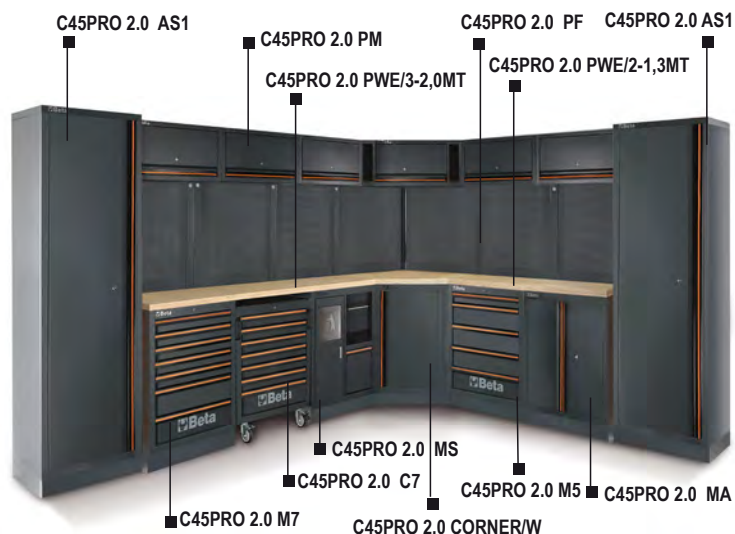

C45PRO 2.0 FX

C45PRO 2.0 műhelyberendezés összeállítás

Az összeállítás a következőkből áll:

- 1 db rozsdamentes acéllal fedett MDF munkalap, 2040 mm x 615 mm (C45PRO 2.0 PXE/3-2.0MT)
- 1 db rozsdamentes acéllal fedett MDF munkalap, 1360 mm x 615 mm (C45PRO 2.0 PXE/2-1.3MT)
- 1 db rögzített, kétajtós modul (C45PRO 2.0 MA)
- 1 db 7 fiókos szerszámkocsi (C45PRO 2.0 C7)
- 1 db 7 fiókos rögzített modul (C45PRO 2.0 M7)
- 1 db rögzített modul 2 beépített dobbal (C45PRO 2.0 ACT)
- 1 db rögzített szerviz modul (C45PRO 2.0 MS)
- 1 db önálló teljes sarok rozsdamentes acéllal fedett MDF munkalappal (C45PRO 2.0 CORNER/X)
- 2 db perforált szerszámartató panel (C45PRO 2.0 PF)
- 1 db perforált szerszámartató panel, elektromos aljzattal bővíthető (az aljzat nem tartozék) (C45PRO 2.0 PFE)
- 3 db faliszekrény (C45PRO 2.0 PM)
- 1 db alumínium redőnyös szerszámartató fal (C45PRO 2.0 PAS)
- 6 db széles falikonzol (C45PRO 2.0 SL)
- 4 db keskeny falikonzol (C45PRO 2.0 SS)
- 2 db egyajtós szekrény (C45PRO 2.0 AS1)

658 kg

C45PRO 2.0 FX

Ft 4.943.500 1 045002035

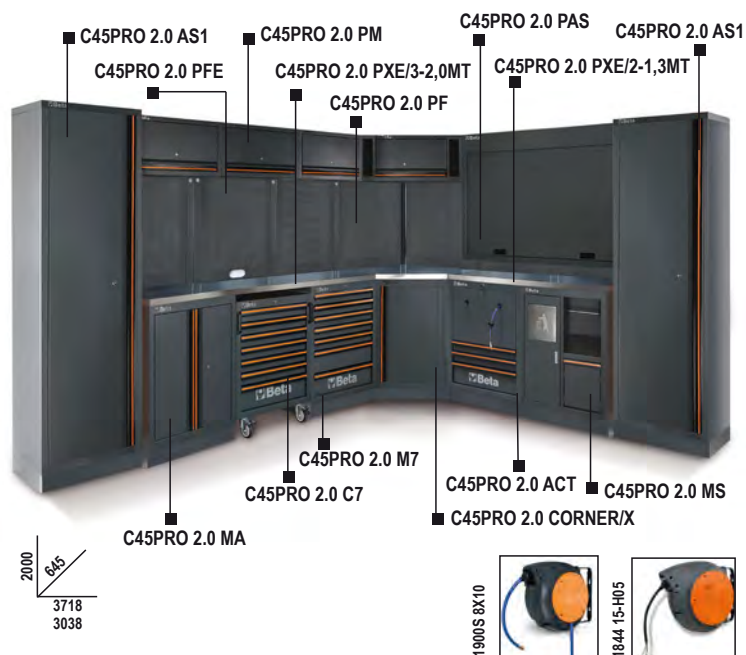

C45PRO 2.0 FW

C45PRO 2.0 műhelyberendezés összeállítás

Az összeállítás a következőkből áll:

- 1 db rétegelt fa munkalap, 2040 mm x 615 mm (C45PRO 2.0 PWE/3-2.0MT)
- 1 db rétegelt fa munkalap, 1360 mm x 615 mm (C45PRO 2.0 PWE/2-1.3MT)
- 1 db rögzített, kétajtós modul (C45PRO 2.0 MA)
- 1 db 7 fiókos szerszámkocsi (C45PRO 2.0 C7)
- 1 db 7 fiókos rögzített modul (C45PRO 2.0 M7)
- 1 db rögzített modul 2 beépített dobbal (C45PRO 2.0 ACT)
- 1 db rögzített szerviz modul (C45PRO 2.0 MS)
- 1 db önálló teljes sarok rétegelt fa munkalappal (C45PRO 2.0 CORNER/W)
- 2 db perforált szerszámartató panel (C45PRO 2.0 PF)
- 1 db perforált szerszámartató panel, elektromos aljzattal bővíthető (az aljzat nem tartozék) (C45PRO 2.0 PFE)
- 3 db faliszekrény (C45PRO 2.0 PM)
- 1 db alumínium redőnyös szerszámartató fal (C45PRO 2.0 PAS)
- 6 db széles falikonzol (C45PRO 2.0 SL)
- 4 db keskeny falikonzol (C45PRO 2.0 SS)
- 2 db egyajtós szekrény (C45PRO 2.0 AS1)

625 kg

C45PRO 2.0 FW

Ft 4.823.300 1 045002045

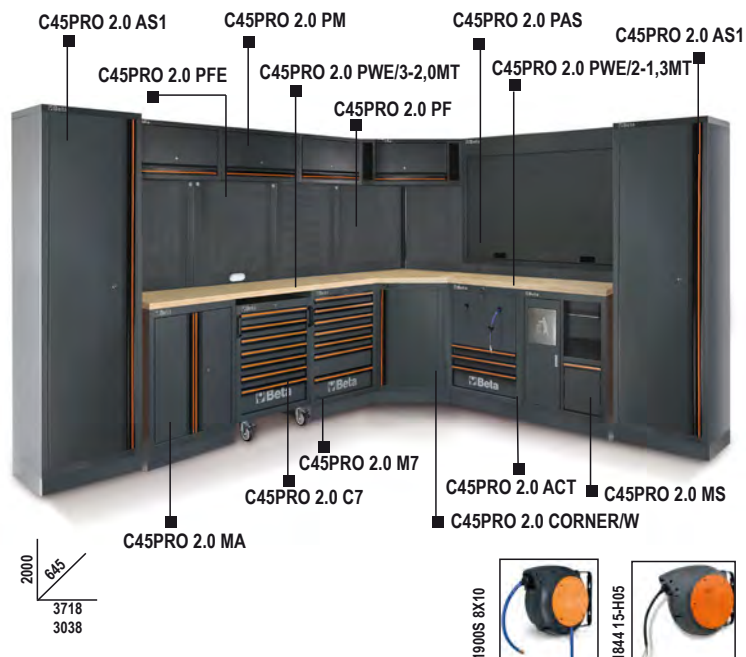

C45PRO 2.0 GX

C45PRO 2.0 műhelyberendezés összeállítás

Az összeállítás a következőkből áll:

- 1 db rozsdamentes acéllal fedett MDF munkalap, 2040 mm x 615 mm (C45PRO 2.0 PXE/3-2.0MT)
- 1 db rozsdamentes acéllal fedett MDF munkalap, 680 mm x 615 mm (C45PRO 2.0 PXE/1-0.7MT)
- 1 db rögzített modul 2 beépített dobbal (C45PRO 2.0 ACT)
- 1 db 7 fiókos szerszámkocsi (C45PRO 2.0 C7)
- 1 db 7 fiókos rögzített modul (C45PRO 2.0 M7)
- 1 db rögzített, kétajtós modul (C45PRO 2.0 MA)
- 1 db önálló teljes sarok rozsdamentes acéllal fedett MDF munkalappal (C45PRO 2.0 CORNER/X)
- 1 db perforált szerszámtartó panel (C45PRO 2.0 PF)
- 1 db perforált szerszámtartó panel, elektromos aljzattal bővíthető (az aljzat nem tartozék) (C45PRO 2.0 PFE)
- 2 db faliszekrény (C45PRO 2.0 PM)
- 1 db alumínium redőnyös szerszámtartó fal (C45PRO 2.0 PAS)
- 5 db széles falikonzol (C45PRO 2.0 SL)
- 4 db keskeny falikonzol (C45PRO 2.0 SS)
- 2 db egyajtós szekrény (C45PRO 2.0 AS1)

554 kg

C45PRO 2.0 GX Ft 4.435.200 1 045002036

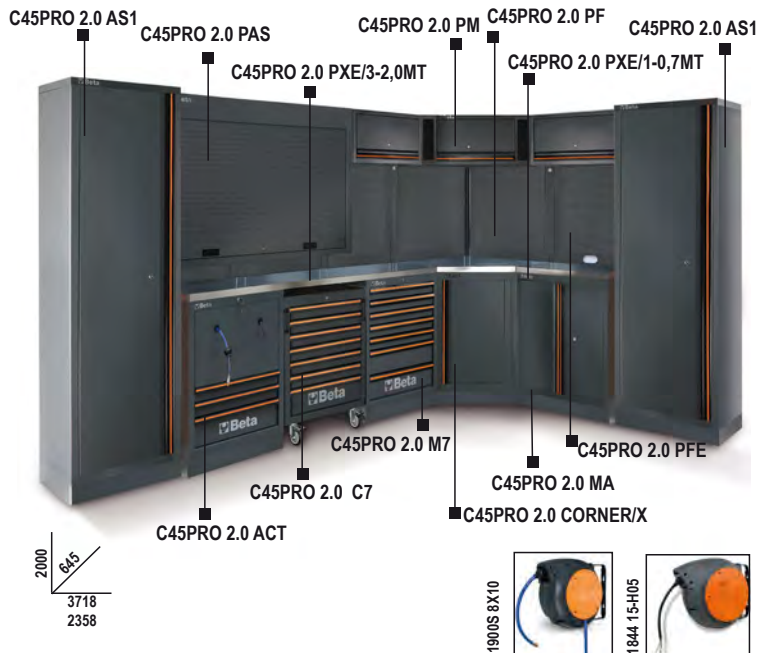

C45PRO 2.0 GW

C45PRO 2.0 műhelyberendezés összeállítás

Az összeállítás a következőkből áll:

- 1 db rétegelt fa munkalap, 2040 mm x 615 mm (C45PRO 2.0 PWE/3-2.0MT)
- 1 db rétegelt fa munkalap, 680 mm x 615 mm (C45PRO 2.0 PWE/2-0.7MT)
- 1 db rögzített modul 2 beépített dobbal (C45PRO 2.0 ACT)
- 1 db 7 fiókos szerszámkocsi (C45PRO 2.0 C7)
- 1 db 7 fiókos rögzített modul (C45PRO 2.0 M7)
- 1 db rögzített, kétajtós modul (C45PRO 2.0 MA)
- 1 db önálló teljes sarok rétegelt fa munkalappal (C45PRO 2.0 CORNER/W)
- 1 db perforált szerszámtartó panel (C45PRO 2.0 PF)
- 1 db perforált szerszámtartó panel, elektromos aljzattal bővíthető (az aljzat nem tartozék) (C45PRO 2.0 PFE)
- 2 db faliszekrény (C45PRO 2.0 PM)
- 1 db alumínium redőnyös szerszámtartó fal (C45PRO 2.0 PAS)
- 6 db széles falikonzol (C45PRO 2.0 SL)
- 2 db keskeny falikonzol (C45PRO 2.0 SS)
- 2 db egyajtós szekrény (C45PRO 2.0 AS1)

551 kg

C45PRO 2.0 GW Ft 4.317.200 1 045002037

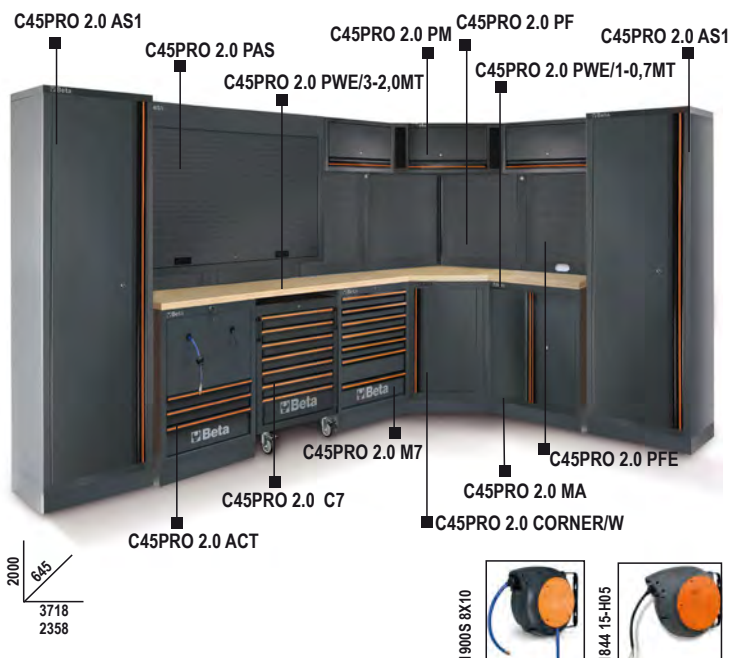

C45PRO 2.0 X

C45PRO 2.0 műhelyberendezés összeállítás

Az összeállítás a következőkből áll:

- 1 db rozsdamentes acéllal fedett MDF munkalap, 2040 mm x 615 mm, (C45PRO 2.0 PXE/3-2.0MT)
- 1 db 7 fiókos rögzített modul (C45PRO 2.0 M7)
- 1 db 7 fiókos szerszámkocsi (C45PRO 2.0 C7)
- 1 db rögzített kiszolgáló modul (C45PRO 2.0 MS)
- 3 db perforált szerszámtartó panel (C45PRO 2.0 PF)
- 3 db faliszekrény (C45PRO 2.0 PM)
- 3 db széles falikonzol (C45PRO 2.0 SL)
- 1 db keskeny falikonzol (C45PRO 2.0 SS)
- 1 db kétajtós szekrény (C45PRO 2.0 AS2)

334 kg

C45PRO 2.0 X Ft 2.332.800 1 045002001

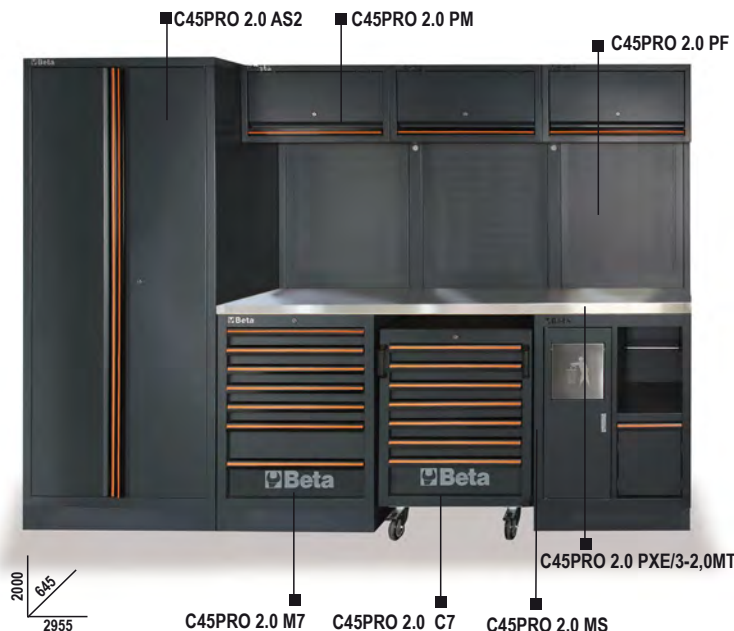

C45PRO 2.0 W

C45PRO 2.0 műhelyberendezés összeállítás

Az összeállítás a következőkből áll:

- 1 db rétegelt fa munkalap, 2040 mm x 615 mm, (C45PRO 2.0 PWE/3-2.0MT)
- 1 db 7 fiókos rögzített modul (C45PRO 2.0 M7)
- 1 db 7 fiókos szerszámkocsi (C45PRO 2.0 C7)
- 1 db rögzített kiszolgáló modul (C45PRO 2.0 MS)
- 3 db perforált szerszámartató panel (C45PRO 2.0 PF)
- 3 db faliszekrény (C45PRO 2.0 PM)
- 3 db széles falikonzol (C45PRO 2.0 SL)
- 1 db keskeny falikonzol (C45PRO 2.0 SS)
- 1 db kétajtós szekrény (C45PRO 2.0 AS2)

318 kg

C45PRO 2.0 W

Ft 2.288.300 1 045002002

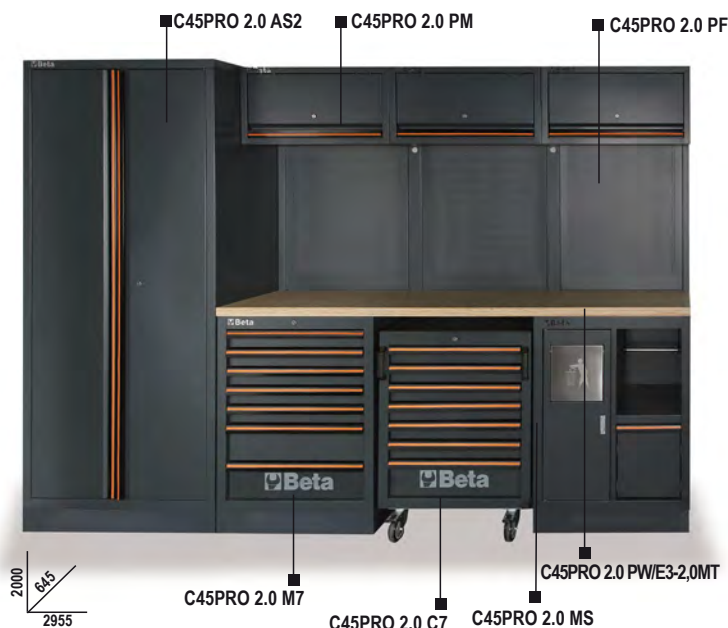

C45PRO 2.0 HX

C45PRO 2.0 műhelyberendezés összeállítás

Az összeállítás a következőkből áll:

- 1 db 1 rozsdamentes acéllal fedett MDF munkalap, 2040 mm x 615 mm, (C45PRO 2.0 PXE/3-2.0MT)
- 1 db rögzített modul 2 beépített kábeldobbal (C45PRO 2.0 ACT)
- 1 db 7 fiókos szerszámkocsi (C45PRO 2.0 C7)
- 1 db 4 fiókos rögzített modul (C45PRO 2.0 M4)
- 3 db faliszekrény (C45PRO 2.0 PM)
- 3 db perforált szerszámartató panel (C45PRO 2.0 PF)
- 3 db széles falikonzol (C45PRO 2.0 SL)
- 1 db keskeny falikonzol (C45PRO 2.0 SS)
- 1 db kétajtós szekrény (C45PRO 2.0 AS2)

333 kg

C45PRO 2.0 HX

Ft 2.501.400 1 045002038

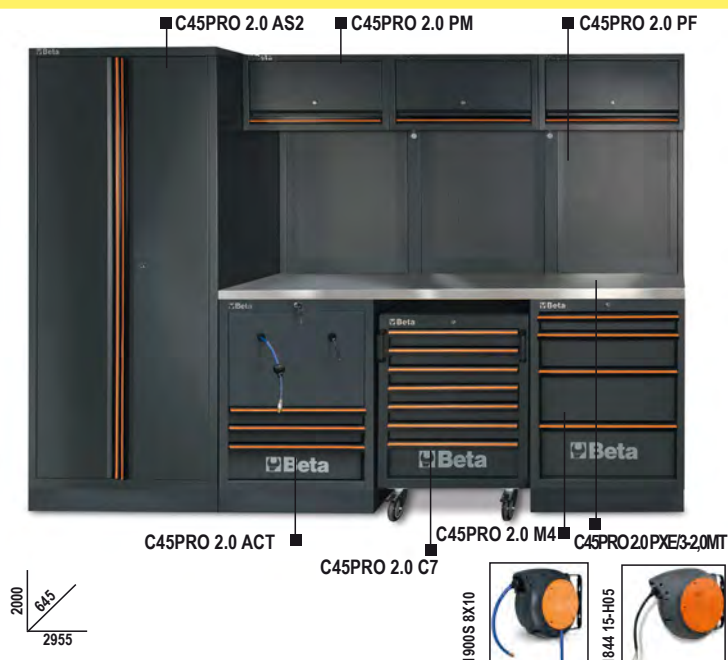

C45PRO 2.0 HW

C45PRO 2.0 műhelyberendezés összeállítás

Az összeállítás a következőkből áll:

- 1 db rétegelt fa munkalap, 2040 mm x 615 mm, (C45PRO 2.0 PWE/3-2.0MT)
- 1 db rögzített modul 2 beépített kábeldobbal (C45PRO 2.0 ACT)
- 1 db 7 fiókos szerszámkocsi (C45PRO 2.0 C7)
- 1 db 4 fiókos rögzített modul (C45PRO 2.0 M4)
- 3 db faliszekrény (C45PRO 2.0 PM)
- 3 db perforált szerszámartató panel (C45PRO 2.0 PF)
- 3 db széles falikonzol (C45PRO 2.0 SL)
- 1 db keskeny falikonzol (C45PRO 2.0 SS)
- 1 db kétajtós szekrény (C45PRO 2.0 AS2)

318 kg

C45PRO 2.0 HW

Ft 2.456.900 1 045002039

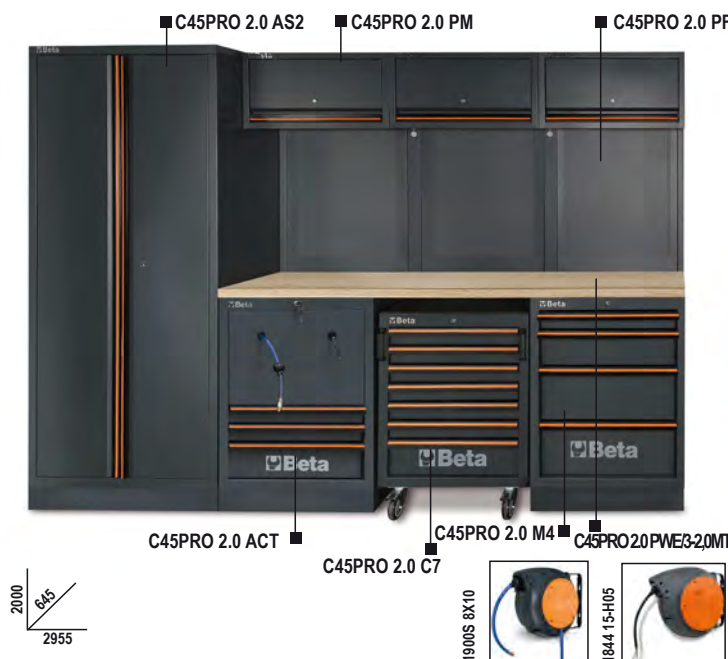

C45PRO 2.0 AX

C45PRO 2.0 műhelyberendezés összeállítás

Az összeállítás a következőkből áll:

- 1 db rozsdamentes acéllal fedett MDF munkalap, 2040 mm x 615 mm, (C45PRO 2.0 PXE/3-2.0MT)
- 1 db rögzített kiszolgáló modul (C45PRO 2.0 MS)
- 1 db 7 fiókos rögzített modul (C45PRO 2.0 M7)
- 1 db rögzített kétajtós modul (C45PRO 2.0 MA)
- 3 db faliszekrény (C45PRO 2.0 PM)
- 3 db perforált szerszámtartó panel (C45PRO 2.0 PF)
- 2 db széles falikonzol (C45PRO 2.0 SL)
- 2 db keskeny falikonzol (C45PRO 2.0 SS)

234,5 kg

C45PRO 2.0 AX Ft 1.635.600 1 045002003



C45PRO 2.0 AW

C45PRO 2.0 műhelyberendezés összeállítás

Az összeállítás a következőkből áll:

- 1 rétegelt fa munkalap, 2040x615 mm, (C45PRO 2.0 PWE/3-2.0MT)
- 1 db rögzített kiszolgáló modul (C45PRO 2.0 MS)
- 1 db 7 fiókos rögzített modul (C45PRO 2.0 M7)
- 1 db rögzített kétajtós modul (C45PRO 2.0 MA)
- 3 db faliszekrény (C45PRO 2.0 PM)
- 3 db perforált szerszámtartó panel (C45PRO 2.0 PF)
- 2 db keskeny falikonzol (C45PRO 2.0 SS)
- 2 db széles falikonzol (C45PRO 2.0 SL)

219 kg

C45PRO 2.0 AW Ft 1.591.100 1 045002004



C45PRO 2.0 BX

C45PRO 2.0 műhelyberendezés összeállítás

Az összeállítás a következőkből áll:

- 1 db rozsdamentes acéllal fedett MDF munkalap, 1360 mm x 615 mm, (C45PRO 2.0 PXE/2-1.3MT)
- 1 db 5 fiókos rögzített modul (C45PRO 2.0 M5)
- 1 db rögzített kétajtós modul (C45PRO 2.0 MA)
- 2 db faliszekrény (C45PRO 2.0 PM)
- 2 db perforált szerszámtartó panel (C45PRO 2.0 PF)
- 2 db széles falikonzol (C45PRO 2.0 SL)
- 2 db keskeny falikonzol (C45PRO 2.0 SS)
- 1 db egyajtós szekrény (C45PRO 2.0 AS1)

206 kg

C45PRO 2.0 BX Ft 1.466.000 1 045002021

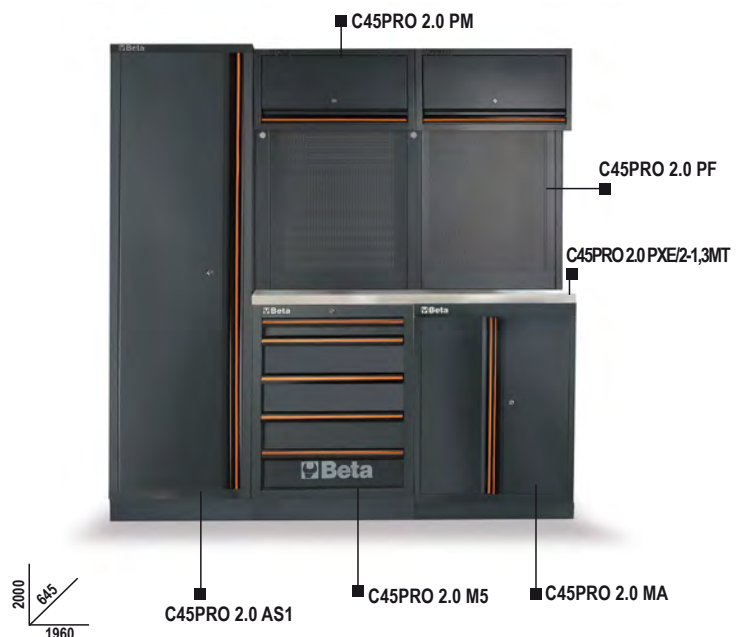

C45PRO 2.0 BW

C45PRO 2.0 műhelyberendezés összeállítás

Az összeállítás a következőkből áll:

- 1 rozsdamentes acéllal fedett MDF munkalap, 1360 mm x 615 mm, (C45PRO 2.0 PWE/2-1.3MT)
- 1 db 5 fiókos rögzített modul (C45PRO 2.0 M5)
- 1 db rögzített kétajtós modul (C45PRO 2.0 MA)
- 2 db faliszekrény (C45PRO 2.0 PM)
- 2 db perforált szerszámtartó panel (C45PRO 2.0 PF)
- 2 db széles falikonzol (C45PRO 2.0 SL)
- 2 db keskeny falikonzol (C45PRO 2.0 SS)
- 1 db egyajtós szekrény (C45PRO 2.0 AS1)

196 kg

C45PRO 2.0 BW

Ft 1.421.500 1 045002022

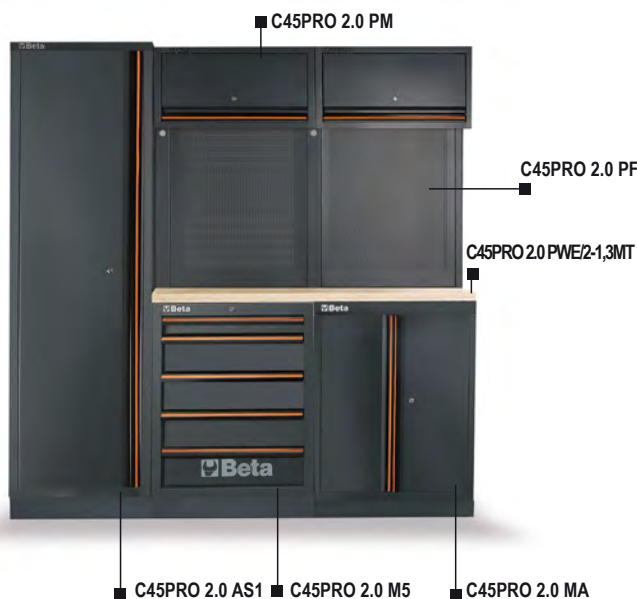

C45PRO 2.0 EX

C45PRO 2.0 műhelyberendezés összeállítás

Az összeállítás a következőkből áll:

- 2 db perforált szerszámtartó panel (C45PRO 2.0 PF)
- 2 db faliszekrény (C45PRO 2.0 PM)
- 2 db széles falikonzol (C45PRO 2.0 SL)
- 1 db keskeny falikonzol (C45PRO 2.0 SS)
- 1 db egyajtós szekrény (C45PRO 2.0 AS1)
- 1 db 7 fiókos rögzített modul és rozsdamentes acéllal fedett MDF munkalap, 1360 mm x 615 mm (C45PRO 2.0 M7A/X):
- 1 db fiók, 1248 mm x 406 mm
- 6 db fiók, 782 mm x 406 mm
- 5 db fiók, 65 mm magas
- 1 db fiók, 145 mm magas
- 1 db tárolórekesz köztes polccal és ajtóval

203 kg

C45PRO 2.0 EX

Ft 1.555.900 1 045002033



C45PRO 2.0 EW

C45PRO 2.0 műhelyberendezés összeállítás

Az összeállítás a következőkből áll:

- 2 db perforált szerszámtartó panel (C45PRO 2.0 PF)
- 2 db faliszekrény (C45PRO 2.0 PM)
- 2 db széles falikonzol (C45PRO 2.0 SL)
- 1 db keskeny falikonzol (C45PRO 2.0 SS)
- 1 db egyajtós szekrény (C45PRO 2.0 AS1):
- 1 db 7 fiókos rögzített modul és rozsdamentes acéllal fedett MDF munkalap, 1360 mm x 615 mm (C45PRO 2.0 M7A/W):
- 1 db fiók, 1248 mm x 406 mm
- 6 db fiók, 782 mm x 406 mm
- 5 db fiók, 65 mm magas
- 1 db fiók, 145 mm magas
- 1 db tárolórekesz köztes polccal és ajtóval

193 kg

C45PRO 2.0 EW

Ft 1.511.300 1 045002034



C45PRO 2.0 CX

C45PRO 2.0 műhelyberendezés összeállítás

Az összeállítás a következőkből áll:

- 1 db rozsdamentes acéllal fedett MDF munkalap, 1360 mm x 615 mm, (C45PRO 2.0 PXE/2-1.3MT)
- 1 db rögzített kiszolgáló modul (C45PRO 2.0 MS)
- 1 db 7 fiókos rögzített modul (C45PRO 2.0 M7)
- 2 db faliszekrény (C45PRO 2.0 PM)
- 2 db perforált szerszámtartó panel (C45PRO 2.0 PF)
- 2 db széles falikonzol (C45PRO 2.0 SL)
- 2 db keskeny falikonzol (C45PRO 2.0 SS)
- 1 db egyajtós szekrény (C45PRO 2.0 AS1)

225 kg

C45PRO 2.0 CX

Ft 1.564.800 1 045002023



C45PRO 2.0 CW

C45PRO 2.0 műhelyberendezés összeállítás

Az összeállítás a következőkből áll:

- 1 rétegelt fa munkalap, 1360 mm x 615 mm, (C45PRO 2.0 PWE/2-1.3MT)
- 1 db rögzített kiszolgáló modul (C45PRO 2.0 MS)
- 1 db 7 fiókos rögzített modul (C45PRO 2.0 M7)
- 2 db faliszekrény (C45PRO 2.0 PM)
- 2 db perforált szerszámtartó panel (C45PRO 2.0 PF)
- 2 db széles falikonzol (C45PRO 2.0 SL)
- 2 db keskeny falikonzol (C45PRO 2.0 SS)
- 1 db egyajtós szekrény (C45PRO 2.0 AS1)

215 kg

C45PRO 2.0 CW

Ft 1.520.200 1 045002024



C45PRO 2.0 BPX-2,0

C45PRO 2.0 műhelyberendezés összeállítás

Az összeállítás a következőkből áll:

- 1 db rozsdamentes acéllal fedett MDF munkalap, 2040 mm x 615 mm, (C45PRO 2.0 PXE/3-2.0MT)
- 1 db 7 fiókos rögzített modul (C45PRO 2.0 M7)
- 1 db 5 fiókos rögzített modul (C45PRO 2.0 M5)
- 3 db perforált szerszámtartó panel (C45PRO 2.0 PF)
- 2 db széles falikonzol (C45PRO 2.0 SL)
- 2 db keskeny falikonzol (C45PRO 2.0 SS)

181 kg

C45PRO 2.0 BPX-2,0

Ft 1.217.400 1 045002042



C45PRO 2.0 BPW-2,0

Munkapadok C45PRO 2.0 műhelyberendezés összeállításához

Az összeállítás a következőkből áll:

- 1 db rétegelt fa munkalap, 2040 mm x 615 mm, (C45PRO 2.0 PWE/3-2.0MT)
- 1 db 7 fiókos rögzített modul (C45PRO 2.0 M7)
- 1 db 5 fiókos rögzített modul (C45PRO 2.0 M5)
- 3 db perforált szerszámtartó panel (C45PRO 2.0 PF)
- 2 db széles falikonzol (C45PRO 2.0 SL)
- 2 db keskeny falikonzol (C45PRO 2.0 SS)

165 kg

C45PRO 2.0 BPW-2,0

Ft 1.172.900



1



045002052

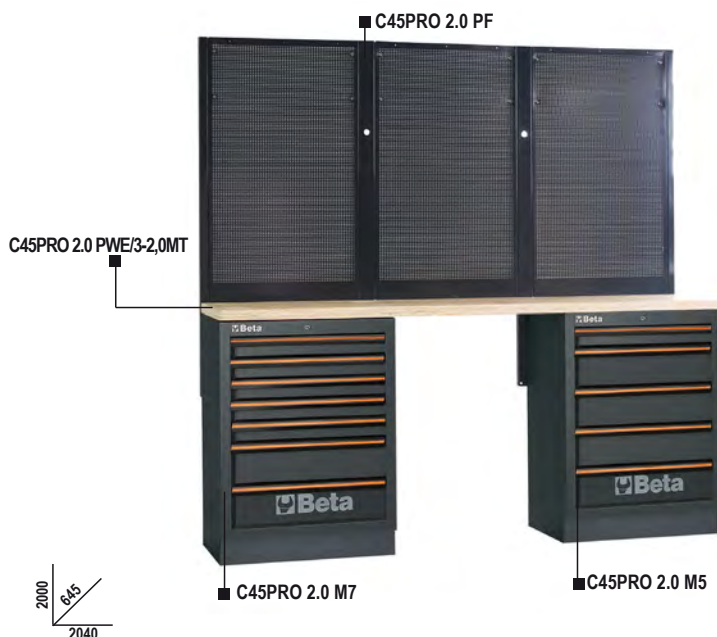

C45PRO 2.0 BPX-1,3

C45PRO 2.0 műhelyberendezés összeállítás

Az összeállítás a következőkből áll:

- 1 db rozsdamentes acéllal fedett MDF munkalap, 1360 mm x 615 mm, (C45PRO 2.0 PXE/2-1.3MT)
- 1 db 7 fiókos rögzített modul (C45PRO 2.0 M7)
- 1 db 5 fiókos rögzített modul (C45PRO 2.0 M5)
- 2 db perforált szerszámtartó panel (C45PRO 2.0 PF)
- 1 db széles falikonzol (C45PRO 2.0 SL)
- 2 db keskeny falikonzol (C45PRO 2.0 SS)

155 kg

C45PRO 2.0 BPX-1,3

Ft 1.073.100



1



045002041



C45PRO 2.0 BPW-1,3

C45PRO 2.0 műhelyberendezés összeállítás

Az összeállítás a következőkből áll:

- 1 db rétegelt fa munkalap, 1360 mm x 615 mm, (C45PRO 2.0 PWE/2-1.3MT)
- 1 db 7 fiókos rögzített modul (C45PRO 2.0 M7)
- 1 db 5 fiókos rögzített modul (C45PRO 2.0 M5)
- 2 db perforált szerszámtartó panel (C45PRO 2.0 PF)
- 1 db széles falikonzol (C45PRO 2.0 SL)
- 2 db keskeny falikonzol (C45PRO 2.0 SS)

145 kg

C45PRO 2.0 BPW-1,3

Ft 1.028.500



1



045002051

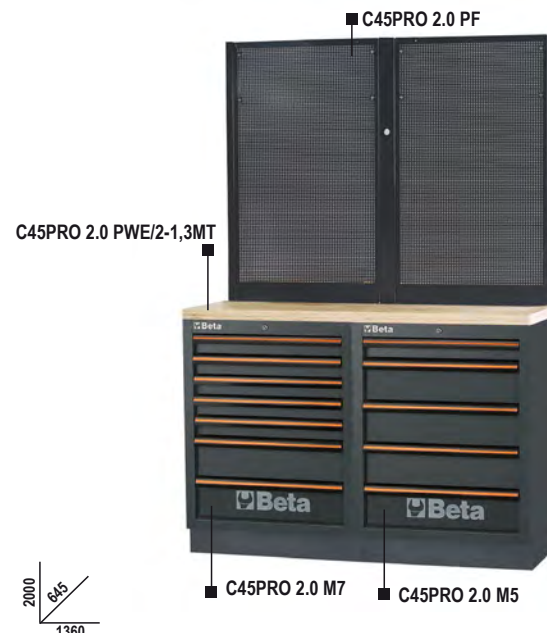

C45PRO 2.0 BLX

Munkapad C45PRO 2.0 műhelyberendezés összeállításához

- Rozsdamentes acéllal fedett MDF munkalap (1360 mm x 615 mm)
- Fémlemez szerkezet
- Állítható magasságú lábakkal
- Furatokkal a satu rögzítéséhez (1599P/150, a satu külön rendelhető)
- Kizárólag bútoregyüttes kiegészítéseként, nem önálló elemként használható



C45PRO 2.0 BLX

Ft 338.100 1 045002156

C45PRO 2.0 BLW

Munkapad C45PRO 2.0 műhelyberendezés összeállításához

- Rétegelt fa munkalap (1360 mm x 615 mm)
- Fémlemez szerkezet
- Állítható magasságú lábakkal
- Furatokkal a satu rögzítéséhez (1599P/150, a satu külön rendelhető)
- Kizárólag bútoregyüttes kiegészítéseként, nem önálló elemként használható



C45PRO 2.0 BLW

Ft 308.300 1 045002157

C45PRO 2.0 M7A/X

7 fiókos rögzített modul a C45PRO 2.0 műhelyberendezés összeállításához

- Rozsdamentes acéllal fedett MDF munkalap (1360 mm x 615 mm)
- 1 db teleszkópos, csapágyazott fiók (1248 mm x 406 mm)
- 6 db teleszkópos, csapágyazott fiók (782 mm x 406 mm):
5 db fiók 65 mm magas
1 db fiók 145 mm magas
- A fiókok habgumival béleltek
- Központi zár elől
- Függőlegesen állítható talp
- Hőformált tálcák elhelyezhetők
- 1 db tárolórekesz köztes polccal és ajtóval, belső méretek 504x424x597 mm
- Furatokkal a satu rögzítéséhez (1599P/150, a satu külön rendelhető)



81 kg

h	max
65 mm	25 kg
105 mm	40 kg
145 mm	30 kg

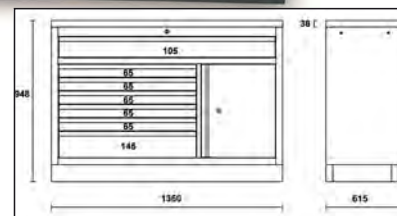

C45PRO 2.0 M7A/X

Ft 823.900 1 045002161

C45PRO 2.0 M7A/W

7 fiókos rögzített modul a C45PRO 2.0 műhelyberendezés összeállításhoz

- Rétegelt fa munkalap (1360 mm x 615 mm)
- 1 db teleszkópos, csapágyazott fiók (1248 mm x 406 mm)
- 6 db teleszkópos, csapágyazott fiók (782 mm x 406 mm):
5 db fiók 65 mm magas
1 db fiók 145 mm magas
- A fiókok habgumival bélelték
- Központi zár elől
- Függetlenül állítható talp
- Hőformált tálcák elhelyezhetők
- 1 db tárolórekesz köztes polccal és ajtóval, belső méretek , 504x424x597 mm
- Furatokkal a satu rögzítéséhez (1599P/150, a satu külön rendelhető)

80 kg

C45PRO 2.0 M7A/W

Ft 779.400 1 045002171

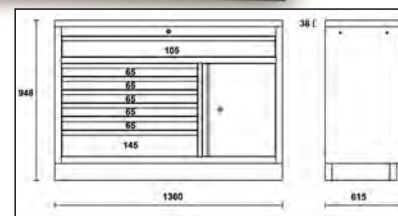

h	max
65 mm	25 kg
105 mm	40 kg
145 mm	30 kg

C45PRO 2.0 MWS/X

7 fiókos szerszámkocsi beépített hulladékátrolóval munkaállomáshoz

- Rozsdamentes acéllal fedett MDF munkalap (1680 mm)
- 1 db teleszkópos, csapágyazott fiók (1248 mm x 406 mm)
- 6 db teleszkópos, csapágyazott fiók (782 mm x 406 mm):
5 fiók 65 mm magas
1 fiók 145 mm magas
- A fiókok habgumival bélelték
- Hőformált tálcák elhelyezhetők
- Tárolórekesz köztes polccal és ajtóval, belső méretek 504 mm x 424 mm x 597 mm
- Beépített hulladékátroló
- Beépített papírtekerstartó
- 4 db robusztus kerék, Ø 150 mm, 2 rögzített és 2 elfordítható, fékezhető
- Központi zár elől
- Furatokkal a satu rögzítéséhez (1599P/150, a satu külön rendelhető)

126 kg

C45PRO 2.0 MWS/X

Ft 791.500 1 045000181

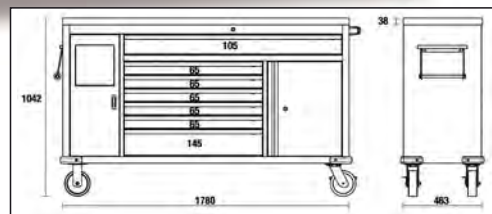

h	max
65 mm	25 kg
105 mm	40 kg
145 mm	30 kg

C45PRO 2.0 MWS/W

7 fiókos szerszámkocsi beépített hulladékátrolóval munkaállomáshoz

- Rétegelt lemez munkalap (1680 mm)
- 1 db teleszkópos, csapágyazott fiók (1248 mm x 406 mm)
- 6 db teleszkópos, csapágyazott fiók (782 mm x 406 mm):
5 fiók 65 mm magas
1 fiók 145 mm magas
- A fiókok habgumival bélelték
- Hőformált tálcák elhelyezhetők
- Tárolórekesz köztes polccal és ajtóval, belső méretek 504 mm x 424 mm x 597 mm
- Beépített hulladékátroló
- Beépített papírtekerstartó
- 4 db robusztus kerék, Ø 150 mm, 2 rögzített és 2 elfordítható, fékezhető
- Központi zár elől
- Furatokkal a satu rögzítéséhez (1599P/150, a satu külön rendelhető)

122 kg

C45PRO 2.0 MWS/W

Ft 771.300 1 045000191

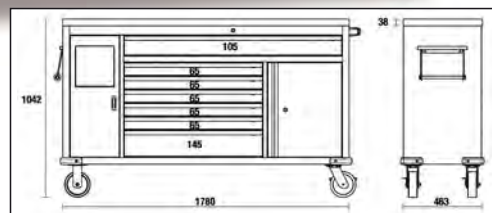

h	max
65 mm	25 kg
105 mm	40 kg
145 mm	30 kg

C45PRO 2.0 CPF

Egy pár perforált szerszámtartó panel a C45PRO MWS szerszámkocsihoz

Önhordó szerkezettel ellátva
50 db horgos GPS készlettel

11 kg

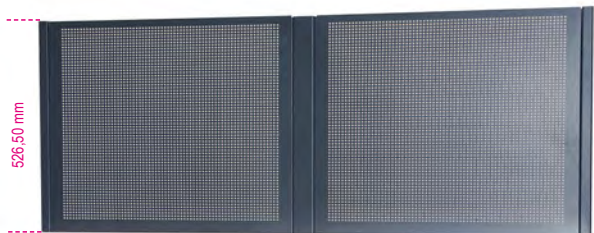

C45PRO 2.0 CPF Ft 102.400 1 045000195

C45PRO 2.0 PXE/1-0,7MT

Rozsdamentes acéllal fedett MDF munkalap (680x615 mm), munkapadhoz, a C45PRO 2.0 műhelyberendezés összeállításához

- vastagság: 38 mm
- furatokkal a satu rögzítéséhez (1599P/150, a satu külön rendelhető)
- 2 db távtartóval és 2 db külső oldalbetéttel

14 kg



C45PRO 2.0 PXE/1-0,7MT Ft 144.700 1 045002131

C45PRO 2.0 PWE/1-0,7MT

Rétegelt fa munkalap (680x615 mm), munkapadhoz, a C45PRO 2.0 műhelyberendezés összeállításához

- vastagság: 38 mm
- furatokkal a satu rögzítéséhez (1599P/150, a satu külön rendelhető)
- 2 db távtartóval és 2 db külső oldalbetéttel

8 kg



C45PRO 2.0 PWE/1-0,7MT Ft 102.400 1 045002141

C45PRO 2.0 PXE/2-1,3MT

Rozsdamentes acéllal fedett MDF munkalap (1360x615 mm), munkapadhoz, a C45PRO 2.0 műhelyberendezés összeállításához

- vastagság: 38 mm
- furatokkal a satu rögzítéséhez (1599P/150, a satu külön rendelhető)
- 2 db távtartóval és 2 db külső oldalbetéttel

27 kg



C45PRO 2.0 PXE/2-1,3MT Ft 226.700 1 045002133

C45PRO 2.0 PWE/2-1,3MT

Rétegelt fa munkalap (1360x615 mm), munkapadhoz, a C45PRO 2.0 műhelyberendezés összeállításához

- vastagság: 38 mm
- furatokkal a satu rögzítéséhez (1599P/150, a satu külön rendelhető)
- 2 db távtartóval és 2 db külső oldalbetéttel

17 kg



C45PRO 2.0 PWE/2-1,3MT Ft 182.200 1 045002143

C45PRO 2.0 PXE/3-2,0MT

Rozsdamentes acéllal fedett MDF munkalap (2040x615 mm), munkapadhoz, a C45PRO 2.0 műhelyberendezés összeállításához

- vastagság: 38 mm
- furatokkal a satu rögzítéséhez (1599P/150, a satu külön rendelhető)
- 6 db távtartóval és 2 db külső oldalbetéttel

41,5 kg



C45PRO 2.0 PXE/3-2,0MT Ft 295.300 1 045002140

C45PRO 2.0 PWE/3-2,0MT

Rétegelt fa munkalap (2040 mm x 615 mm), munkapadhoz, a C45PRO 2.0 műhelyberendezés összeállításához

- vastagság: 38 mm
- furatokkal a satu rögzítéséhez (1599P/150, a satu külön rendelhető)
- 6 db távtartóval és 2 db külső oldalbetéttel

26 kg



C45PRO 2.0 PWE/3-2,0MT Ft 250.800 1 045002150

C45PRO 2.0 C5

5 fiókos szerszámkocsi a C45PRO 2.0 műhelyberendezés összeállításához

- ABS munkalap legurulásgátló peremmel
- 5 db teleszkópos, csapágyazott fiók (532 mm x 406 mm)
- 4 db forgókerék, Ø 100 mm (kettő fékezhető)
- A fiókok habgumival bélelték
- Központi zár elöl
- Hőformált tálcák elhelyezhetők
- Keretbe épített fogantyúk a könnyebb kezelhetőség érdekében

46 kg

h	max
65 mm	25 kg
145 mm	30 kg

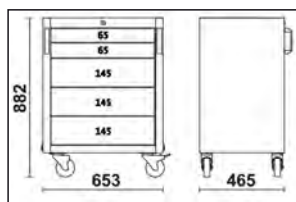
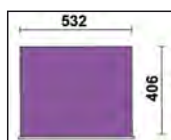

C45PRO 2.0 C5 Ft 383.000 1 045000226

 **Beta**

C45PRO 2.0 C7

7 fiókos szerszámkocsi a C45PRO 2.0 műhelyberendezés összeállításához

- ABS munkalap leguruláságtól peremmel
- 7 db teleszkópos, csapágyazott fiók (532 mm x 406 mm)
- 4 darab forgókerék, Ø 100 mm (kettő fékezhető)
- A fiókok habgumival béleltek
- Központi zár elöl
- Hőformált tálcák elhelyezhetők
- Keretbe épített fogantyúk a könnyebb kezelhetőség érdekében

📦 50 kg

C45PRO 2.0 C7

Ft 423.100 1 045000228

h	max
65 mm	25 kg
145 mm	30 kg

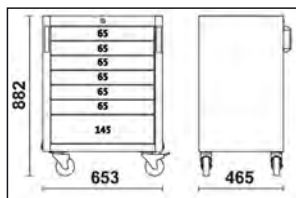
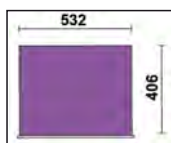

C45PRO 2.0 M4

4 fiókos rögzített modul a C45PRO 2.0 műhelyberendezés összeállításához

- 4 db teleszkópos csapágyazott fiók (566 mm x 406 mm)
- A fiókok habgumival béleltek
- Központi zár elöl
- Állítható magasságú lábak
- Hőformált tálcák elhelyezhetők

📦 46,7 kg

C45PRO 2.0 M4

Ft 307.300 1 045000234

h	max
65 mm	25 kg
145 mm	30 kg
225 mm	30 kg

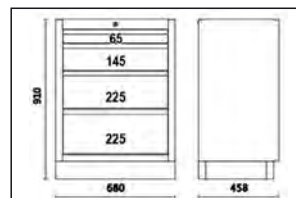
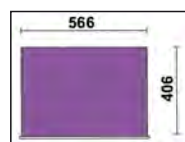

C45PRO 2.0 M5

5 fiókos rögzített modul a C45PRO 2.0 műhelyberendezés összeállításához

- 5 db teleszkópos csapágyazott fiók (566 mm x 406 mm)
- A fiókok habgumival béleltek
- Központi zár elöl
- Állítható magasságú lábak
- Hőformált tálcák elhelyezhetők

📦 49,3 kg

C45PRO 2.0 M5

Ft 325.100 1 045000235

h	max
65 mm	25 kg
145 mm	30 kg

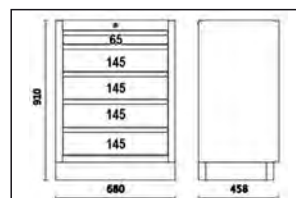
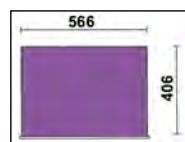

C45PRO 2.0 M7

7 fiókos rögzített modul a C45PRO 2.0 műhelyberendezés összeállításához

- 7 db teleszkópos csapágyazott fiók (566 mm x 406 mm)
- A fiókok habgumival béleltek
- Központi zár elöl
- Állítható magasságú lábak
- Hőformált tálcák elhelyezhetők

54,3 kg

h	max
65 mm	25 kg
145 mm	30 kg

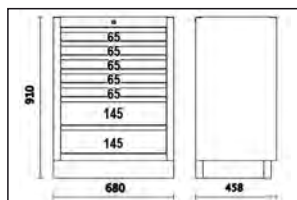
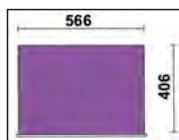

C45PRO 2.0 M7

Ft 360.700 1 045000237

C45PRO 2.0 M8

8 fiókos rögzített modul a C45PRO 2.0 műhelyberendezés összeállításához

- 8 db teleszkópos csapágyazott fiók (566 mm x 406 mm)
- A fiókok habgumival béleltek
- Központi zár elöl
- Állítható magasságú lábak
- Hőformált tálcák elhelyezhetők

56,8 kg

h	max
65 mm	25 kg
145 mm	30 kg

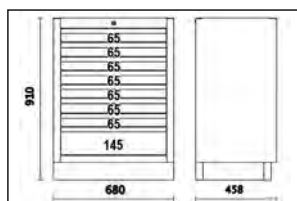
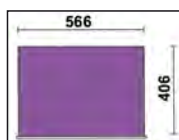

C45PRO 2.0 M8

Ft 392.300 1 045000238

C45PRO 2.0 MS

Rögzített kiszolgáló modul a C45PRO 2.0 műhelyberendezés összeállításához

- Beépített hulladékátroló
- Beépített papírtekerstartó
- Állítható magasságú lábak

37 kg

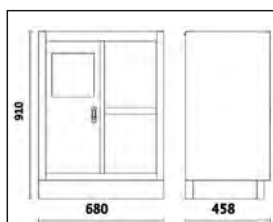

C45PRO 2.0 MS

Ft 245.300 1 045000239

C45PRO 2.0 RD/X

Rögzített szelektív hulladéktároló modul a C45PRO 2.0 műhelyberendezés összeállításához

- Rozsdamentes acéllal fedett MDF munkalap (1360 mm x 615 mm)
- Robusztus fémlemez keret, négy szelektív tároló felnyíló tetővel
- Mindegyik tároló tartalmaz:
 - egy-egy kivethető műanyag szemetest, űrtartalom: 25 l
 - 4 db forgókerék, Ø 60 mm
 - 4 db színes ragasztószalag készlettel szállítva
- Függetlenül állítható talp

80 kg

C45PRO 2.0 RD/X Ft 846.200 1 045002241



C45PRO 2.0 RD/X

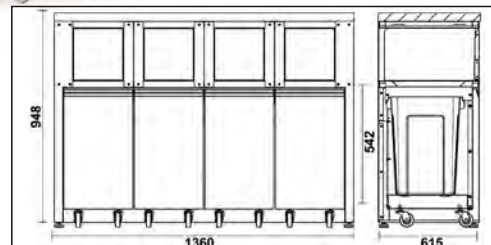

C45PRO 2.0 RD/W

Rögzített szelektív hulladéktároló modul a C45PRO 20 műhelyberendezés összeállításához

- Rétegelt fa munkalap (1360 mm x 615 mm)
- Robusztus fémlemez keret, négy szelektív tároló felnyíló tetővel
- Mindegyik tároló tartalmaz:
 - egy-egy kivethető műanyag szemetest, űrtartalom: 25 l
 - 4 db forgókerék, Ø 60 mm
 - 4 db színes ragasztószalag készlettel szállítva
- Függetlenül állítható talp

80 kg

C45PRO 2.0 RD/W Ft 801.600 1 045002240

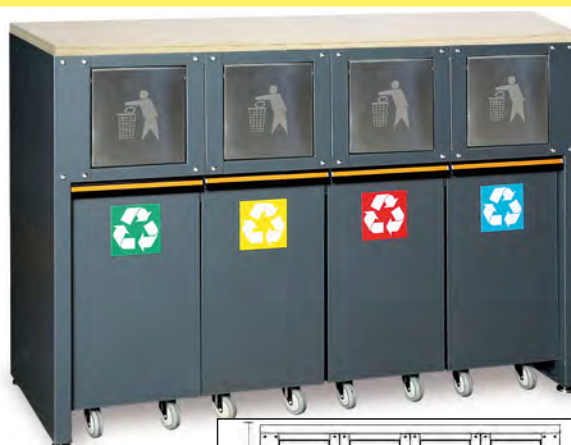

C45PRO 2.0 RD/W

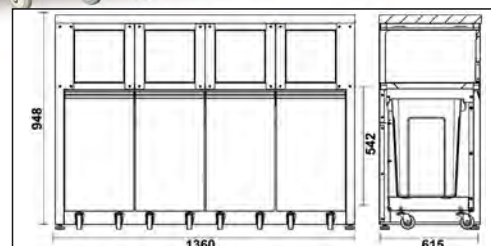

C45PRO 2.0 MA

kétajtós rögzített modul a C45PRO 2.0 műhelyberendezés összeállításához

- Zárható
- Állítható magasságú polc
- Belső méret: 670 mm x 420 mm
- Függetlenül állítható talp

29,4 kg

C45PRO 2.0 MA Ft 182.200 1 045000232

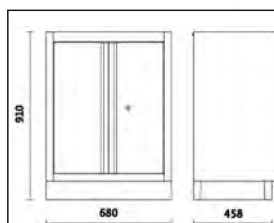

C45PRO 2.0 MAL

2 lemez ajtós, 1360 mm széles rögzített modul a C45PRO 2.0 műhelyberendezés összeállításához

- Zárható
- Állítható magasságú polc
- Belső méret: 1355 mm x 420 mm
- Függőlegesen állítható talp

📦 44,8 kg

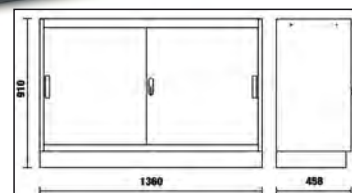

C45PRO 2.0 MAL

Ft 320.600 1 045000229

C45PRO 2.0 MAT

2 átlátszó polikarbonát ajtós, 1360 mm széles rögzített modul a C45PRO 2.0 műhelyberendezés összeállításához

- Zárható
- Állítható magasságú polc
- Belső méret: 1355 mm x 420 mm
- Függőlegesen állítható talp

📦 44,1 kg

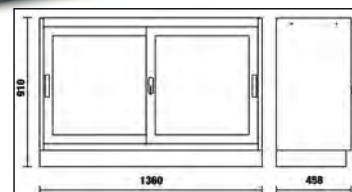

C45PRO 2.0 MAT

Ft 351.800 1 045000230

C45PRO 2.0 M3A

3 fiókos, 2 ajtós rögzített modul C45PRO 2.0 műhelyberendezés összeállításához

- 3 db teleszkópos csapágyazott fiók (566 mm x 406 mm)
- A fiókok habgumival bélelték
- Hőformált tálcák elhelyezhetők
- Központi zár elől
- Kétajtós, zárható tárolórekeszt (belső méret 670 mm x 440 mm), köztes polccal
- Függőlegesen állítható talp

📦 44 kg

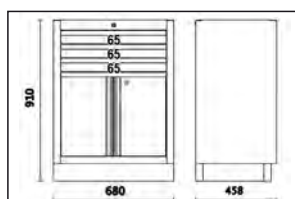
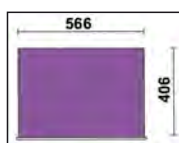
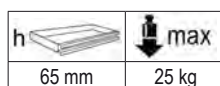

C45PRO 2.0 M3A

Ft 314.600 1 045000231

C45PRO 2.0 MRE

C45PRO 2.0 műhelyi elektromos szerszámok töltésére szolgáló fix modul

- Kivehető oldalsó rekesz, teleszkópos golyóscsapágyas csúszdákra szerelve, elektromos szerszámok elhelyezéséhez
- Rögzített oldalsó rekesz ajtóval és zárral a töltők és akkumulátorok elhelyezésére, felszerelve a következőkkel
állítható magasságú belső polccal
gumivédelemmel ellátott tömítés;
szellőzőnyílások.
- Egy 256x400x190 mm-es fiók, teleszkópos golyóscsapágyas csúszdákra szerelve.
- Központi zár elöl
- Függőlegesen állítható talp

57 kg

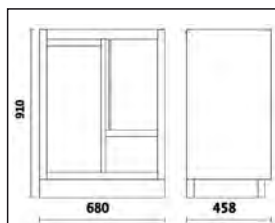

C45PRO 2.0 MRE

Ft 298.400 1 045000242

C45PRO 2.0 ML

Rögzített modul beépített mosdóval a C45PRO 2.0 műhelyberendezés összeállításához

Műszaki jellemzők:

- Rozsdamentes acél mosdótál
- Tartozékok:
 - 1 db keverő csapterlep
 - 1 db lefolyó
 - 1 db dugó
 - 1 db lefolyósűrítő
 - 1 db szappanadagoló

Rögzített, zárható kétajtós modul:

- Hasznos belső méret: 600x603x416 mm
- Függőlegesen állítható talp

44 kg

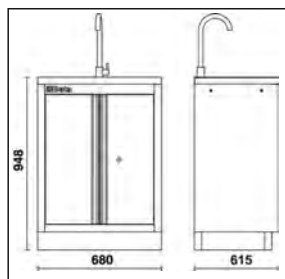

C45PRO 2.0 ML

Ft 530.400 1 045002233

C45PRO 2.0 ACT

3 fiókos rögzített modul 2 beépített dobbal a C45PRO 2.0 műhelyberendezés összeállításához

- 3 db teleszkópos csapágyazott fiók (566 mm x 406 mm)
- A fiókok habgumival bélelték
- Központi zár elöl
- Állítható magasságú lábak

Tartozékok:

- 1 db beépített sűrített levegő vagy hidegvíz tömlődob, 8 mm, hossz 10 m, 1900S 8x10
- 1 db beépített kábeldob, hossz 15 m, 1844 15-H05

50,7 kg



h	max
65 mm	25 kg
145 mm	30 kg

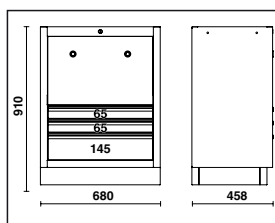
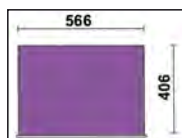

C45PRO 2.0 ACT

Ft 467.400 1 045000247

C45PRO 2.0 TC

3 fiókos rögzített, dobtárolós modul a C45PRO 2.0 műhelyberendezés összeállításához, üres

- 3 db teleszkópos csapágyazott fiók (566 mm x 406 mm)
 - A fiókok habgumival béleltek
 - Központi zár elöl
 - Állítható magasságú lábak
- Az alábbi dob párokkal rendelhető:
- 2 db sűrített levegő vagy hidegvíz tömlődob, 8 mm, hossz 10 m, 1900S modell, 8x10
 - 2 db 843 15-H05, 1844 10-H05, 1844 15-H05, 1844 15-H07, 1845 12-H05, 1846 10-H05, 1846 10-H07 and 1846 15-H05 kábeldob
 - 1 db sűrített levegő vagy hidegvíz tömlődob, 8 mm, hossz 10 m, 1900S modell, 8x10 és 1 kábeldob a fenti modellek közül

h		
	65 mm	25 kg
	145 mm	30 kg

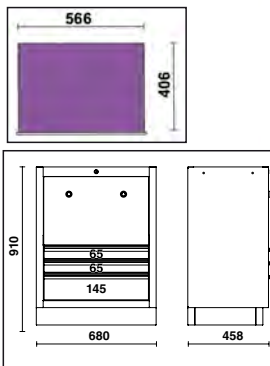

40,9 kg

C45PRO 2.0 TC **Ft** 285.800 1 045000249

C45PRO 2.0 T3

3 szintes szerszámkocsi C45PRO 2.0 műhelyberendezés összeállításához

- 4 db forgókerék, Ø 100 mm (egy kerék fékezhető)
- Statikus terhelhetőség: 200 kg (3 polc között elosztva)

19,2 kg

C45PRO 2.0 T3 **Ft** 142.500 1 045000250

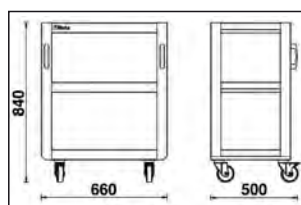

C45PRO 2.0 SS

Széles oldalfal konzolok a C45PRO 2.0 műhelyberendezés összeállításához

- Méretek: 1420x65x30 mm

1,5 kg

C45PRO 2.0 SS **Ft** 13.750 1 045000333



C45PRO 2.0 SL

széles oldalfal konzolok a C45PRO műhelyberendezés összeállításához

- Méret: 1420x65x30 mm

2 kg

C45PRO 2.0 SL **Ft** 18.400 1 045000366



C45PRO 2.0 PAS

Fali szerszámtartó rendszer a C45PRO 2.0 műhelyberendezés összeállításához

- Függetlenül mozgatható, zárral rendelkező alumínium redőny
- Két levehető perforált szerszámtartó panel.
- 1.3 m széles munkapaddal használható
- 50 db horgos GPS készlettel

📦 49,7 kg

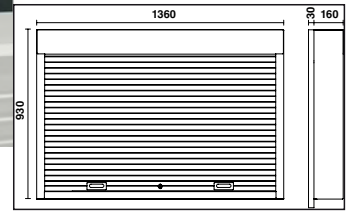
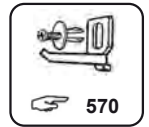

C45PRO 2.0 PAS

Ft 462.300 1 045000290

C45PRO 2.0 PF

Perforált szerszámtartó panel C45PRO 2.0 műhelyberendezés összeállításához

- Méretek: 1052x614.5x24 mm

📦 5,3 kg



C45PRO 2.0 PF

Ft 57.300 1 045000313

C45PRO 2.0 PFE

Perforált szerszámtartó panel C45PRO 2.0 műhelyberendezés összeállításához

- Méretek: 1052x614.5x24 mm
- Egy elektromos aljzattal bővíthető (az aljzat nem tartozék)

📦 5,3 kg



C45PRO 2.0 PFE

Ft 54.250 1 045000312

C45PRO 2.0 MP

Lemez polc perforált szerszámtartó panelekhez, C45PRO 2.0 műhelyberendezés összeállításához

Méretek: 614x160x80 mm

📦 2,1 kg



C45PRO 2.0 MP

Ft 24.500 1 045000315

C45PRO 2.0 CORNER/X

Ónálló teljes sarok a C45PRO 2.0 műhelyberendezés összeállításához

- Zárható fali sarokpolc 2 tárolórecesszel
- 2 db perforált szerszámtartó panel (1052 mm x 800 mm)
- Rozsdamentes acéllal fedett MDF sarok munkalap (1018 mm x 1018 mm)
- Alsó sarok modul nagy tárolórecesszel
- Függetlenül állítható talp

127 kg

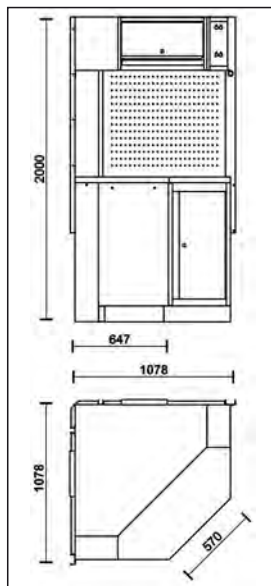

C45PRO 2.0 CORNER/X

Ft 1.079.400 1 045002401

C45PRO 2.0 CORNER/W

Ónálló teljes sarok a C45PRO 2.0 műhelyberendezés összeállításához

- Zárható fali sarokpolc 2 tárolórecesszel
- 2 db perforált szerszámtartó panel (1052 mm x 800 mm)
- Rétegelt fa sarok munkalap (1018 mm x 1018 mm)
- Alsó sarok modul nagy tárolórecesszel
- Függetlenül állítható talp

119 kg

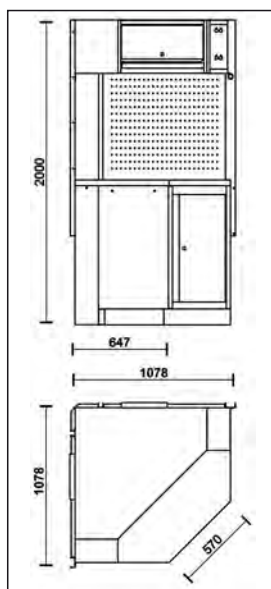

C45PRO 2.0 CORNER/W

Ft 1.048.200 1 045002411

 **Beta**

C45PRO 2.0 CAI/X

Alsó sarok modul C45PRO 2.0 műhelyberendezés összeállításához

Rozsdamentes acéllal fedett MDF sarok munkalap (1018 mm x 1018 mm)

- Rögzített sarok modul nagy tárolórekesssel
- Fügőlegesen állítható talp

77 kg

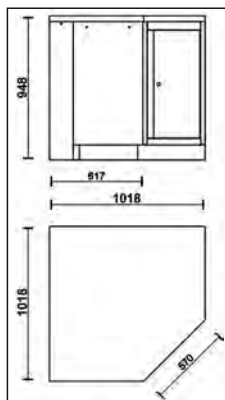

C45PRO 2.0 CAI/X

Ft 581.400 1 045002412

C45PRO 2.0 CAI/W

Alsó sarok modul C45PRO 2.0 műhelyberendezés összeállításához

Rétegelt fa sarok munkalap (1018 mm x 1018 mm)

- Rögzített sarok modul nagy tárolórekesssel
- Fügőlegesen állítható talp

69 kg

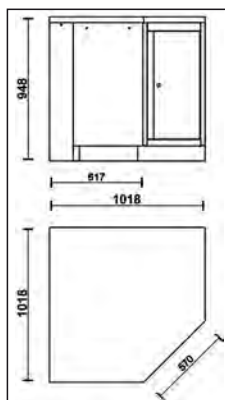

C45PRO 2.0 CAI/W

Ft 550.200 1 045002402

C45PRO 2.0 PM

Faliskezrény a C45PRO 2.0 műhelyberendezés összeállításához

- Szélesség: 680 mm
- Gázrugós megoldás az ajtó könnyebb nyitására és zárására
- Zárható

10 kg

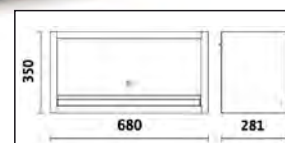

C45PRO 2.0 PM

Ft 105.300 1 045000302

SSPE

Szerszámgéptartó

- Kizárólag a C45PRO 2.0 PM faliskezrény alá szerelhető (C45PRO 2.0 műhelyberendezés)
- 5 praktikus tartó a szerszámgépek elhelyezésére
- Méretek: 680 x 280 x 150 mm

6 kg



SSPE

Ft 44.100 1 088880482

C45PRO 2.0 PML

Széles faliszekrény a C45PRO 2.0 műhelyberendezés összeállításához

- Szélesség: 1360 mm
- Gázrugós megoldás az ajtó könnyebb nyitására és zárására
- Zárható

17 kg

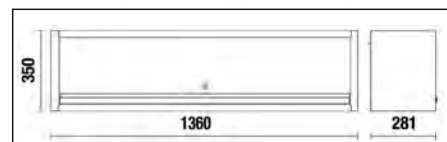

C45PRO 2.0 PML

Ft 188.300 1 045000303

C45PRO 2.0 AS1

Egyajtós lemez szerszámszekrény C45PRO 2.0 műhelyberendezés összeállításához, konzolos

- 4 db kivehető, állítható magasságú polc
- Praktikus visszahajtható ruhatartó sín az első polc alatt
- Zárható
- Balra vagy jobbra nyíló fémlemez ajtó felszerelhető
- Belső méret: 590 mm x 430 mm
- Függőlegesen állítható talp

57,5 kg

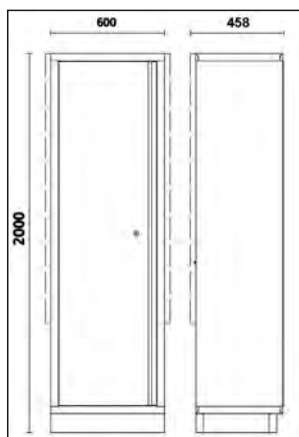

C45PRO 2.0 AS1

Ft 374.700 1 045000451

C45PRO 2.0 A1/R600

Polc a C45PRO AS1 szerszámszekrényhez

2,5 kg

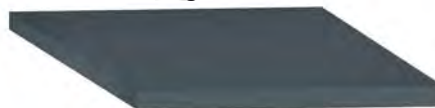

C45PRO 2.0 A1/R600

Ft 22.650 1 045000466

C45PRO 2.0 A1/RB600

Polc a C45PRO 2.0 AS1 szerszámszekrényhez, ruhatartó sínnel

3,3 kg

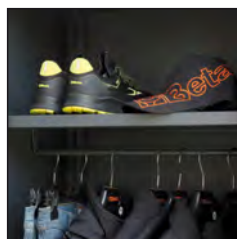

C45PRO 2.0 A1/RB600

Ft 26.300 1 045000467

C45PRO 2.0 AS2

Kétajtós lemez szerszámszekrény C45PRO 2.0 műhelyberendezés összeállításához, konzolos

- 4 db kivehető, állítható magasságú polc
- Zárható
- Balra vagy jobbra nyíló fémlemez ajtó felszerelhető
- Belső méret: 910 mm x 430 mm
- Függőlegesen állítható talp

80 kg

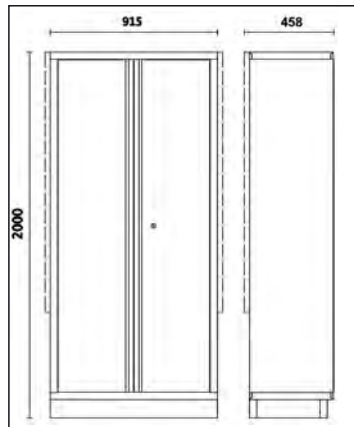

C45PRO 2.0 AS2

Ft 498.600 1 045000481

C45PRO 2.0 AS2/3C

3 fiókos, kétajtós lemez szerszámszekrény C45PRO 2.0 műhelyberendezés összeállításához, konzolos

- 4 db kivehető, állítható magasságú polc
- 3-fiókos (681 mm x 360 mm) modulal szállítva
- Zár elől
- Balra vagy jobbra nyíló fémlemez ajtó felszerelhető
- Belső méret: 910 mm x 430 mm
- Állítható magasságú lábakkal

100,5 kg

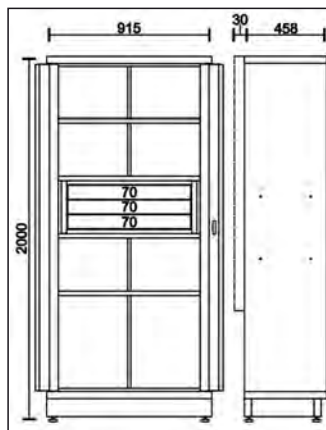
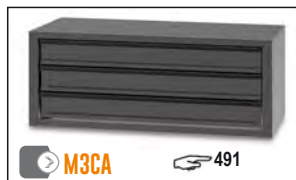

C45PRO 2.0 AS2/3C

Ft 618.800 1 045000482

C45PRO 2.0 A2/R915

Belső rakodópolc C45PRO 2.0 AS2 szekrényhez

4,5 kg

50 kg



C45PRO 2.0 A2/R915

Ft 28.350 1 045000496

C45STR

Színes ragasztószalag a C45PRO 2.0 műhelyberendezés összeállításához

• Lehetővé teszi a C45PRO 2.0 műhelyberendezés összeállítás vízszintes és függőleges elemeinek színkódolását



	L m	Ft	📦	🏠
C45STR-O/2011	30	29.350	1	045000911
C45STR-G/9006	25	26.700	1	045000912
C45STR-R/3000	25	26.700	1	045000913
C45STR-B/5015	25	26.700	1	045000914
C45STR-Y/1023	25	26.700	1	045000915
C45STR-V/6029	25	26.700	1	045000916

S4CB

Széles polcos állvány 4 polccal, alappolcok

Raktárak, műhelyek, irodák és értékesítési pontok elengedhetetlen darabja. Optimális és hatékony termék elhelyezést tesz lehetővé. Robusztus acélelemből készült, különböző típusú termékek tárolására alkalmas.

- Az egyes polcok teherbírása: 250 kg
- Teljes teherbírás: 1000 kg
- Padlóhoz rögzíthető

📦 82 kg



	mm	Ft	📦	🏠
S4CB	1552x600x1803mm	298.400	1	088880490

S4CA

Széles polcos állvány 4 polccal, kiegészítő polcok

A kiegészítő polcokkal megnövelhető az alappolcok tárolókapacitása. Robusztus acélelemből készült, különböző típusú termékek tárolására alkalmas.

- Az egyes polcok teherbírása: 250 kg
- Teljes teherbírás: 1000 kg
- Padlóhoz rögzíthető

📦 72 kg



	Ft	📦	🏠
S4CA	253.800	1	088880495



TARTOZÉK RSC55 - RSC50 2.0 - C45PRO 2.0

		5000 RSC50 2.0/PLED-ST	5000 RSC50 2.0/PLED	5000 RSC50 2.0/ASL	5000 RSC50 2.0/CTR
	A	1x	-	1x	-
	B	-	1x	1x	1x
	A	1x	1x	1x	-
	B	-	2x	1x	1x
	A	1x	2x	1x	-
	B	-	3x	1x	1x

5000 RSC50 2.0/PLEDC

Alumínium profil LED szalaggal az RSC50 műhelyberendezés összeállításához

A munkaterület jobb megvilágítása érdekében felszerelhető: munkalap alá, faliszekrénybe, faliszekrény alá, polc alá, valamint sarokelem alá.

Jellemzők:

- 6.5W IP20 LED lámpa; hossz: 50 cm
- Kábellel szállítva
- A mágneseknek köszönhetően könnyen rögzíthető

80 g



5000 RSC50 2.0/PLEDC **Ft** 17.800 1 050001712

5000 RSC50 2.0/PLED-ST

alumínium profil LED szalaggal és SOFT TOUCH kapcsolóval műhelyberendezés összeállításához

A munkaterület jobb megvilágítása érdekében felszerelhető: munkalap alá, faliszekrénybe, faliszekrény alá, polc alá, valamint sarokelem alá.

Jellemzők:

- 6.5W IP20 LED lámpa; hossz: 50 cm
- SOFT TOUCH KI/BE kapcsoló és fényerő állító
- Kábellel szállítva
- A mágneseknek köszönhetően könnyen rögzíthető

80 g



5000 RSC50 2.0/PLED-ST **Ft** 19.250 1 050001715

5000 RSC50 2.0/ASL

LED szalag tápegység műhelyberendezés összeállításához

Jellemzők:

- 24VDC 22W power supplier
- Maximum 3 db 6.5W LED szalag köthető rá

210 g



5000 RSC50 2.0/ASL **Ft** 14.950 1 050001716

5000 RSC50 2.0/CTR

LED szalagvezérlő vezeték nélküli távirányítóval az RSC50 2.0 műhelyberendezés összeállításához

Kizárólag az 5000 RSC50 2.0/PLEDC LED szalaghoz

Készlet tartalma:

1 db mini vevőegység

1 db vezeték nélküli távirányító

A mini vevőegység műszaki jellemzői:

Bemeneti feszültség: 5V - 24VDC

Kimeneti névleges áram: 5A

Kimeneti csúcsáram: 12A

Működési hőmérséklet-tartomány: -20 °C ÷ +35 °C

A vezeték nélküli távirányító műszaki jellemzői:

KI/BE kapcsoló gomb

FÉNYERŐ + / - gomb: a fényerő kézi szabályozásához

25% - 50% - 100% gomb: a fényerő automatikus beállítását teszi lehetővé

Akkumulátor: 3V CR2025 (tartozék)

Méretetek: 86x40x7 mm

Egyéb jellemzők:

- Beépített memória
- Üzem mód (kézi/automatikus fényerő beállítás)
- Fényerő szabályozás



25 g

5000 RSC50 2.0/CTR

Ft 7.450 1 050001721

CPMB/3C

munkapad alkatrésztartó 3 fiókkal

- Külső PP keret
- PET alkatrésztartó fiókok
- Rakatolható

Fiókok leírása:

- Belső fiók méret: 160x107x105 mm
- Kemény, nehezen törhető
- Az üveghatás átláthatósága az idők során nem változik
- Karcálló
- Olajnak, savaknak és agresszív vegyi anyagoknak ellenálló
- Élelmiszerekkel is használható



2,3 kg

CPMB/3C

Ft 23.900 1 088880443

KIT 6VC/3C

6 kivethető tálcából álló készlet CPMB/3C alkatrésztartó rekeszekhez

1,1 kg



6x



KIT 6VC/3C

Ft 13.150 1 088880453

CPMB/5C

munkapad alkatrésztartó 5 fiókkal

- Külső PP keret
- PET alkatrésztartó fiókok
- Rakatható

Fiókok leírása:

- Belső fiók méret: 90x86x62 mm
- Kemény, nehezen törhető
- Az üveghatás átláthatósága az idők során nem változik
- Karcálló
- Olajnak, savaknak és agresszív vegyi anyagoknak ellenálló
- Élelmiszeripari termékekkel is használható

1,7 kg

CPMB/5C Ft 28.550 1 088880445



KIT 10VC/5C

10 kivethető tálcából álló készlet CPMB/5C alkatrésztartó rekeszekhez

800 g

KIT 10VC/5C Ft 12.350 1 088880455



10x



PM/5C

5 tálcás műanyag fali szerszámtároló tartóval

- Tálca belső méretei: 95 mm x 120 mm
- C45PRO, RSC50 2.0 és RSC55 2.0 szerszámtartó falrendszerrel együtt használható

2,7 kg

PM/5C Ft 50.200 1 088880450



PM/6C

6 tálcás műanyag fali szerszámtároló tartóval

- Tálca belső méretei: 80 mm x 60 mm
- C45PRO 2.0, RSC50 2.0 és RSC55 szerszámtartó falrendszerrel együtt használható

970 g

PM/6C Ft 38.450 1 088880440



CP

Fali palacktartó állvány

- Fali szerszámtároló panelekkel együtt használható
- 2 db tartókonzollal szállítva

533 g

CP Ft 48.600 1 088880470



SPC

számítógép falikonzol

- Az RSC55, RSC50 2.0 és C45PRO 2.0 falı szerszámartó rendszerhez
- Méret: 398x243x138 mm

1,5 kg

SPC Ft 39.250 1 088880480



SP5S

5 rekeszes falı konzol

- Fémlélezből
- 5 különböző magasságú szerszámartó rekesz
- Méretek: 260x60x290 mm

1,8 kg

SP5S Ft 48.600 1 088880475



M3CA

3-fiókos modul

a C45PRO AS2 és RSC50 A2 kétajtós szerszám szekrényhez

- 3 db teljesen kivethető, teleszkópos, csapágyazott fiók, 661 mm x 360 mm
- fiók magassága: 78 mm
- fiókok habgumival béleltek
- szerelőkészlettel szállítva

20,5 kg

M3CA Ft 120.200 1 088880485



Beta

SZERSZÁMKÉSZLETEK

			SZERSZÁMKÉSZLETEK																
			Darab	RSC22	RSC23	RSC23C	RSC23T	RSC24/5	RSC24/6 - RSC24A/6 - C37/6 - C39/6	RSC24/7 - RSC24A/7 - RSC24AXL/7 RSC24AXLP/7 - RSC24AXL - RSC24L/7 RSC24L-CAB - C37/7 - C37A/7 - C39/7	RSC24/8 - RSC24A/8 - RSC24AXL/8 C37/8 - C39/8	RSC24AXL/9	C4 - C5 - C6T - C9MT	C25	C27S	RSC28	C30M		
akasztók nélkül	5902MT	Földmunkagépekhez	106	☐ 529	☐ 529	☐ 529													
	5902MT/AS	Földmunkagépekhez	99	☐ 530	☐ 530	☐ 530													
	5902VI	Ipari karbantartáshoz	107	☐ 494	☐ 494		☐ 494						☐ 494	☐ 494				☐ 494	
	5904VG/3	Autójavításhoz	132					☐ 533	☐ 533	☐ 533	☐ 533								
	5905VG/1	Autójavításhoz	94										☐ 536					☐ 536	
	5905VG/2	Autójavításhoz	118										☐ 537						
akasztókkal	5910VI/3	Ipari karbantartáshoz	297														☐ 498		
	5954VG	Autójavításhoz	138														☐ 542		
	5954VI	Ipari karbantartáshoz	133																
	5957U-P	Általános karbantartáshoz	133																
	5957VG	Autójavításhoz	174		☐ 543		☐ 543	☐ 543											
	5957VI	Ipari karbantartáshoz	162			☐ 501		☐ 501	☐ 501										
puha, habszivacs	5958U	Általános karbantartáshoz	85		☐ 516		☐ 516												
	5904VG/2M	Autójavításhoz	170				☐ 531	☐ 531	☐ 531	☐ 531	☐ 531	☐ 531					☐ 531		
	5904VU/1M	Általános karbantartáshoz	90				☐ 503	☐ 503	☐ 503	☐ 503	☐ 503	☐ 503					☐ 503		
	5904VU/2M	Általános karbantartáshoz	144				☐ 504	☐ 504	☐ 504	☐ 504	☐ 504	☐ 504					☐ 504		
	5927VU/M	Általános karbantartáshoz	108	☐ 514	☐ 514	☐ 514							☐ 501						
	5935ET/1MB	Elektrotechnika	96																
	5935VG/1MB	Autójavításhoz	98																
	5935VI/2MB	Ipari karbantartáshoz	133																
	5945VUM	Általános karbantartáshoz	231																
	5988H/7M	Autójavításhoz	333									☐ 519	☐ 519				☐ 519		
	5988L/4M	Autójavításhoz	273					☐ 520	☐ 520	☐ 520	☐ 520	☐ 520	☐ 520						
	5980U/BIKE-M	Kerékpárszerelő szerszámok	106				☐ 518		☐ 518	☐ 518	☐ 518	☐ 518	☐ 518				☐ 518		
	5988U6/M	Általános karbantartáshoz	214							☐ 521	☐ 521	☐ 521	☐ 521				☐ 521		
	5988U/7M	Általános karbantartáshoz	215				☐ 510	☐ 510	☐ 510	☐ 510	☐ 510	☐ 510	☐ 510				☐ 510		
	5988 VHB-MQ	Elektrotechnika	66				☐ 525	☐ 525	☐ 525	☐ 525	☐ 525	☐ 525	☐ 525				☐ 525		
	5989 VEM	Autójavításhoz	66				☐ 528	☐ 528	☐ 528	☐ 528	☐ 528	☐ 528	☐ 528				☐ 528		
	kemény, hőformált	5904VI/1T	Ipari karbantartáshoz	98				☐ 494	☐ 494	☐ 494	☐ 494	☐ 494	☐ 494					☐ 494	
		5904VI/2T	Ipari karbantartáshoz	153				☐ 497			☐ 497	☐ 497	☐ 497					☐ 497	
5904VI/3T		Ipari karbantartáshoz	144							☐ 495	☐ 495	☐ 495					☐ 495		
5904VG/2T		Autójavításhoz	99				☐ 532	☐ 532	☐ 532	☐ 532	☐ 532	☐ 532					☐ 532		
5904VG/3T		Autójavításhoz	102				☐ 534	☐ 534	☐ 534	☐ 534	☐ 534	☐ 534					☐ 534		
5904VG/5T		Autójavításhoz	153				☐ 535		☐ 535	☐ 535	☐ 535	☐ 535					☐ 535		
5904VU/2T		Általános karbantartáshoz	104				☐ 505	☐ 505	☐ 505	☐ 505	☐ 505	☐ 505					☐ 505		
5904VU/3T		Általános karbantartáshoz	146				☐ 506	☐ 506	☐ 506	☐ 506	☐ 506	☐ 506					☐ 506		
5904VU/4T		Általános karbantartáshoz	197				☐ 507	☐ 507	☐ 507	☐ 507	☐ 507	☐ 507							
5908VG/2T		Autójavításhoz	214														☐ 538		
5908VI/2T		Ipari karbantartáshoz	232								☐ 496	☐ 496					☐ 496		
5908VU/2T		Általános karbantartáshoz	161				☐ 508		☐ 508	☐ 508	☐ 508	☐ 508					☐ 508		
5910VI/3T		Ipari karbantartáshoz	261														☐ 499		

SZERSZÁMKÉSZLETEK

			SZERSZÁMKÉSZLETEK														
			Darab	C35	C39MD - C39SM	C39T	C45PRO 2.0	RSC51	C54S - RSC55C	RSC55	RSC55PSE - RSC55PSE	RSC50 2.0	C57SA - C57SD - C57SB C57SC - C57SP	C58P - C45PRO PAS	C59A - C59C	C59B	C59C
akasztók nélkül	5902MT	Földmunkagépekhez	106			☐ 529											
	5902MT/AS	Földmunkagépekhez	99			☐ 530											
	5902VI	Ipari karbantartáshoz	107														
	5904VG/3	Autójavításhoz	132						☐ 533			☐ 533	☐ 533		☐ 533	☐ 533	☐ 533
	5905VG/1	Autójavításhoz	94														
	5905VG/2	Autójavításhoz	118														
akasztókkal	5910VI/3	Ipari karbantartáshoz	297														
	5954VG	Autójavításhoz	138						☐ 542								
	5954VI	Ipari karbantartáshoz	133						☐ 502	☐ 502							
	5957U-P	Általános karbantartáshoz	133								☐ 515	☐ 515	☐ 515				
	5957VG	Autójavításhoz	174								☐ 543		☐ 543				
	5957VI	Ipari karbantartáshoz	162										☐ 501				☐ 501
5958U	Általános karbantartáshoz	85				☐ 516			☐ 516	☐ 516	☐ 516		☐ 516				
puha, habszivacs	5904VG/2M	Autójavításhoz	170		☐ 531	☐ 531			☐ 531			☐ 531	☐ 531		☐ 531	☐ 531	☐ 531
	5904VU/1M	Általános karbantartáshoz	90		☐ 503	☐ 503		☐ 503	☐ 503			☐ 503	☐ 503		☐ 503	☐ 503	☐ 503
	5904VU/2M	Általános karbantartáshoz	144		☐ 504	☐ 504			☐ 504			☐ 504	☐ 504		☐ 504	☐ 504	☐ 504
	5927VU/M	Általános karbantartáshoz	108														
	5935ET/1MB	Elektrotechnika	96	☐ 522													
	5935VG/1MB	Autójavításhoz	98	☐ 539													
	5935VI/2MB	Ipari karbantartáshoz	133	☐ 500													
	5945VUM	Általános karbantartáshoz	231				☐ 541										
	5988H/7M	Autójavításhoz	333						☐ 519			☐ 519				☐ 519	☐ 519
	5988L/4M	Autójavításhoz	273		☐ 520	☐ 520			☐ 520			☐ 520	☐ 520		☐ 520	☐ 520	☐ 520
	5980U/BIKE-M	Kerékpárszerelő szerszámok	106									☐ 518	☐ 518			☐ 518	☐ 518
	5988U6/M	Általános karbantartáshoz	214		☐ 521				☐ 521			☐ 521				☐ 521	☐ 521
	5988U/7M	Általános karbantartáshoz	215		☐ 510				☐ 510			☐ 510	☐ 510		☐ 510	☐ 510	☐ 510
	5988 VHB-MQ	Elektrotechnika	66		☐ 525	☐ 525		☐ 525	☐ 525				☐ 525		☐ 525	☐ 525	☐ 525
	5989 VEM	Autójavításhoz	66									☐ 528				☐ 528	
	kemény, hőformált	5904VI/1T	Ipari karbantartáshoz	98		☐ 494	☐ 494		☐ 494	☐ 494			☐ 494	☐ 494		☐ 494	☐ 494
5904VI/2T		Ipari karbantartáshoz	153		☐ 497				☐ 497			☐ 497	☐ 497		☐ 497	☐ 497	☐ 497
5904VI/3T		Ipari karbantartáshoz	144		☐ 495				☐ 495			☐ 495	☐ 495			☐ 495	☐ 495
5904VG/2T		Autójavításhoz	99		☐ 532	☐ 532		☐ 532	☐ 532			☐ 532	☐ 532		☐ 532	☐ 532	☐ 532
5904VG/3T		Autójavításhoz	102		☐ 534	☐ 534			☐ 534			☐ 534	☐ 534		☐ 534	☐ 534	☐ 534
5904VG/5T		Autójavításhoz	153		☐ 535				☐ 535			☐ 535	☐ 535		☐ 535	☐ 535	☐ 535
5904VU/2T		Általános karbantartáshoz	104		☐ 505	☐ 505			☐ 505			☐ 505	☐ 505		☐ 505	☐ 505	☐ 505
5904VU/3T		Általános karbantartáshoz	146		☐ 506	☐ 506			☐ 506			☐ 506	☐ 506		☐ 506	☐ 506	☐ 506
5904VU/4T		Általános karbantartáshoz	197		☐ 507	☐ 507			☐ 507			☐ 507	☐ 507		☐ 507	☐ 507	☐ 507
5908VG/2T		Autójavításhoz	214														
5908VI/2T		Ipari karbantartáshoz	232									☐ 496				☐ 496	☐ 496
5908VU/2T		Általános karbantartáshoz	161		☐ 508				☐ 508			☐ 508	☐ 508		☐ 508	☐ 508	☐ 508
5910VI/3T		Ipari karbantartáshoz	261														



5902VI

107 darabos szerszámkészlet

► Ipari karbantartás

Mennyiség/megnevezés

- 6 hosszú kiütő Ø 2 - 3 - 4 - 5 - 6 - 8 mm
- 1 pontozó Ø 3 mm
- 1 erősített laposvágó 200 mm
- 26 csillag-villáskulcsok 6+32 mm
- 12 villáskulcs 6x7 - 8x9 - 10x11 - 12x13 - 14x15 - 16x17 - 18x19 - 20x22 - 21x23 - 24x26 - 25x28 - 30x32 mm
- 9 imbuszkulcs Ø 1,5 - 2 - 2,5 - 3 - 4 - 5 - 6 - 8 - 10 mm
- 1 Állítható villáskulcs 300 mm
- 13 1/2"-os hatlapú dugókulcs Ø 10+22 mm
- 1 1/2"-os toldó 125 mm
- 1 1/2"-os toldó 255 mm
- 1 1/2"-os csukló
- 1 1/2"-os csúszkás T-hajtószer
- 1 1/2"-os irányváltós racsnis
- 1 vízpumpafogó 250 mm
- 1 Egyenes pofájú önzáró fogó 240 mm
- 1 erősített oldalcsípőfogó, kétkomponensű markolat ipari kivitel 160 mm
- 1 áttételes egyenes lemezolló 250 mm
- 1 műszerész olló 147 mm
- 1 robusztus kombinált fogó kétkomponensű markolat ipari kivitel 180 mm
- 1 egyenes extra hosszú félkerécsőrű fogó, kétkomponensű markolat ipari kivitel 160 mm
- 8 csavarhúzó hasítottfejű csavarokhoz ● 2,5x50 - 3x75 - 3,5x100 - 4x125 - 5,5x125 - 6,5x150 - 8x200 - 10x200 mm
- 4 Phillips®-csavarhúzó ● PH0x60 - PH1x80 - PH2x100 - PH3x150 mm
- 1 lakatos kalapács 500 g
- 1 ütéselnyelő műanyag kalapács Ø 40 mm
- 1 rajztű
- 1 fékes mérőszalag 5 m
- 1 Hézagmérő
- 5 darabos egyengető reszelő készlet markolattal 200 mm
- 1 fűrész
- 1 Olajozó fémkanna 300 cc
- 1 dekorkés 170 mm
- 1

Beta-sz.	
31	
32	
35	
42/S26	
55/S12	
96N/SC9	
111E	
920A/SB13	
920/21	
920/22	
920/25	
920/42	
920/55	
1048N	
1052	
1084GBM	
1122	
1128BMX	
1150GBM	
1166GBM	
1260	
1262	
1370	
1392	
1688A	
1692	
1708/20	
1719BMA...S5	
1726BM	
1751N	
1771BM	
1838SW	

Ft

5902VI 785.800 059021060

Készletársítási javaslat RSC22 - RSC23 - RSC23T - C25 - C27S



T80 T05 T06



T153 T138 T145 T236



T234 T33 T208 T68

5904VI/1T

98 darabos szerszámkészlet ABS hőformált tálcában

► Ipari karbantartás

Mennyiség/megnevezés

- 19 1/2"-os hatlapú dugókulcs Ø 10+24 - 26 - 27 - 30 - 32 mm
- 5 1/2"-os imbusz dugókulcs Ø 5 - 6 - 8 - 10 - 12 mm
- 1 1/2"-os toldó 125 mm
- 1 1/2"-os toldó 255 mm
- 1 1/2"-os csukló
- 1 1/2"-os csúszkás T-hajtószer
- 1 1/2"-os irányváltós racsnis
- 16 csillag-villáskulcs 6+21 mm
- 5 csillag-villáskulcs 22-24-27-30-32 mm
- 1 vízpumpafogó 250 mm
- 1 Egyenes pofájú önzáró fogó 240 mm
- 1 Erősített oldalcsípőfogó 160 mm
- 1 kombinált fogó 180 mm
- 1 Egyenes extra hosszú félkerécsőrű fogó 160 mm
- 1 egyenes belső Seeger-fogó 180 mm
- 1 hajlított belső Seeger - fogó 170 mm
- 1 egyenes külső Seeger-fogó 175 mm
- 1 hajlított külső Seeger - fogó 175 mm
- 2 erősített laposvágó 100 - 200 mm
- 5 reszelő 200 mm
- 1 lakatos kalapács 300 g
- 1 műanyag kalapács Ø 35 mm
- 8 villáskulcs 6x7 - 8x9 - 10x11 - 12x13 - 14x15 - 16x17 - 18x19 - 20x22 mm
- 9 imbuszkulcs Ø 1,5 - 2 - 2,5 - 3 - 4 - 5 - 6 - 8 - 10 mm
- 4 csavarhúzó hasítottfejű csavarokhoz ● 3x75 - 4x100 - 5,5x150 - 6,5x150 mm
- 3 Phillips®-csavarhúzó ● PH0x60 - PH1x80 - PH2x100 mm
- 6 T-szerű imbuszkulcs Ø 2,5 - 3 - 4 - 5 - 6 - 8 mm

Beta-sz.	TR
920A	T80
920ME	T80
920/21	T80
920/22	T80
920/25	T80
920/42	T80
920/55	T80
42	T05
42	T06
1048N	T153
1052	T153
1084	T138
1150	T138
1166	T138
1032	T145
1034	T145
1036	T145
1038	T145
35	T234
1719BMA8/S5	T236
1370	T234
1390	T234
55	T33
96/SC9	T33
1260	T208
1262	T208
951	T68

Ft

5904VI/1T 706.300 059041161

Készletársítási javaslat RSC23T - RSC24 - RSC24A - RSC24L7 - RSC24L-CAB
RSC24AXL - RSC24AXLP/7 - RSC24AXXL - RSC28 - C37 - C39 - C39MD - C39SM - C39T - RSC55 - RSC50 2.0 - C59 - C57 - C58BC

5904VI/3T

144 darabos szerszámkészlet ABS hőformált tálcában

► Ipari karbantartás

Mennyiség/megnevezés

- 16 csillag-villáskulcs 6÷21 mm
- 5 csillag-villáskulcs 22 - 24 - 27 - 30 - 32 mm
- 5 hosszú kiütő Ø 2 - 3 - 4 - 5 - 6 mm
- 1 pontozó Ø 4 mm
- 12 villáskulcs 6x7 - 8x9 - 10x11 - 12x13 - 14x15 - 16x17 - 18x19 - 20x22 - 21x23 - 24x26 - 27x29 - 30x32 mm
- 9 imbuszkulcs 1,5 - 2 - 2,5 - 3 - 4 - 5 - 6 - 8 - 10 mm
- 9 csavarhúzó hasítottfejű csavarokhoz ● 3x75 - 3,5x100 - 4x100 - 4x150 - 5,5x100 - 5,5x150 - 6,5x150 - 8x150 - 10x200 mm
- 2 Lapos törpe csavarhúzó ● 4x30 - 6,5x30 mm
- 6 Phillips®-csavarhúzó ● PH0x60 - PH0x100 - PH1x80 - PH1x120 - PH2x100 - PH2x150 mm
- 7 Imbusz csavarhúzó Torx®-csavarokhoz ● T6-T7-T8-T9-T10-T15-T20
- 5 1/2"-os imbusz dugókulcs ○ 5 - 6 - 8 - 10 - 12 mm
- 1 1/2"-os toldó 125 mm
- 1 1/2"-os toldó 255 mm
- 1 1/2"-os csukló
- 1 1/2"-os csúszkás T-hajtószár
- 1 1/2"-os irányváltós racsnit Ⓞ
- 19 1/2"-os hatlapú dugókulcs ○ 10÷24 - 26 - 27 - 30 - 32 mm
- 8 Erősített tizenkétszögű csőkulcs 6x7 - 8x9 - 10x11 - 12x13 - 14x15 - 16x17 - 18x19 - 20x22 mm
- 1 hajtószár
- 1 hajtószár
- 6 T-szárú imbuszkulcs ○ 2,5 - 3 - 4 - 5 - 6 - 8 mm
- 1 kombinált fogó = 180 mm
- 1 Egyenes extra hosszú félkerécsőrű fogó ● 160 mm
- 1 Erősített oldalcsípőfogó ⚡ 160 mm
- 1 vízpumpafogó 250 mm
- 1 Egyenes pófajú önzáró fogó 240 mm
- 1 egyenes belső Seeger-fogó ○ 180 mm
- 1 hajlított belső Seeger - fogó ○ 170 mm
- 1 egyenes külső Seeger-fogó ● 175 mm
- 1 hajlított külső Seeger - fogó ● 175 mm
- 1 egyenes belső Seeger-fogó ○ 140 mm
- 1 hajlított belső Seeger - fogó ○ 225 mm
- 1 egyenes külső Seeger-fogó ● 140 mm
- 1 hajlított külső Seeger - fogó ● 225 mm
- 1 lakatos kalapács 400 g
- 1 műanyag kalapács Ø 35 mm
- 1 reszelő 200 mm
- 1 reszelő 200 mm
- 1 reszelő 200 mm
- 1 digitális tolómérő
- 1 Rugalmas skálás vonalzó 300 mm
- 1 5 m
- 1 Popszegecshúzó 250 mm
- 100 alumínium popszegecs 2,9x6 mm
- 100 alumínium popszegecs 3,2x8 mm
- 100 alumínium popszegecs 3,8x10 mm
- 100 alumínium popszegecs 4x12 mm
- 100 alumínium popszegecs 4,8x12 mm
- 1 bádogos lemezolló 250 mm
- 1 Egyenes élű műszerész olló 145 mm
- 1 fűrész
- (5) fűrészlap
- 1 Olajozó fémkanna 200 cc
- Üres hőformált tálcák

Beta-sz.	TR
42	T05
42	T06
31	T31
32	T31
55	T31
96N/SC9	T31
1260	T167
1260N	T167
1262	T202
1267TX	T205
920ME	T80
920/21	T80
920/22	T80
920/25	T80
920/42	T80
920/55	T80
920A	T80
930	T73
940/1	T73
940/2	T73
951	T68
1150BM	T137
1166BM	T137
1084BM	T137
1048N	T153
1052	T153
1032	T145
1034	T145
1036	T145
1038	T145
1032	T146
1034	T146
1036	T146
1038	T146
1370	T231
1390	T231
1719BMA8/T	T231
1719BMA8/P	T231
1719BMA8/M	T231
1651DGTB	T297
1682	T297
1691BM	T297
1741B	T281
1741RV..K	T281
1741RV..K	T281
1741RV..K	T281
1741RV..K	T281
1741RV..K	T281
1112	T279
1128BM	T279
1726	T279
1728BM	T279
1751N	T279
VP6	VP6



T05 T06 T31



T167 T202 T205



T80 T73 T68



T137 T153 T145 T146



T231 T297 T281



T279 VP6

Ft

5904VI/3T

1.144.900 059041168

Készletárrsítási javaslat RSC24 8 fiókkal - RSC24A 8 fiókkal- RSC24AXL 8-9 fiókkal
RSC24AXLP/7 - RSC24AXL - RSC28 - C37 8 fiókkal - C39 8 fiókkal - C39MD - C39SM - RSC50 2.0 - RSC55 - C59B - C58BC - C57

► Ipari karbantartás

Mennyiség/megnevezés

	Beta-sz.	TR
5 1/2"-os imbusz dugókulcs \odot 5 - 6 - 8 - 10 - 12 mm	920ME	T80
1 1/2"-os toldó 125 mm	920/21	T80
1 1/2"-os toldó 255 mm	920/22	T80
1 1/2"-os csukló	920/25	T80
1 1/2"-os csúszkás T-hajtósár	920/42	T80
1 1/2"-os irányváltós racsnis \oplus	920/55	T80
19 1/2"-os hatlapú dugókulcs \odot 10÷24 - 26 - 27 - 30 - 32 mm	920A	T80
16 csillag-villáskulcs 6÷21 mm	42	T05
5 csillag-villáskulcs 22 - 24 - 27 - 30 - 32 mm	42	T06
13 1/4"-os hatlapú dugókulcs \odot 4÷14 mm	900	T91
6 1/4"-os imbusz-dugókulcs \odot 2,5 - 3 - 4 - 5 - 6 - 8 mm	900ME	T91
1 1/4" - os toldó 50 mm	900/20	T91
1 1/4" - os toldó 150 mm	900/21	T91
1 1/4"-os hajtósár	900BG/30	T91
1 1/4"-os csukló	900/25	T91
1 1/4"-os csúszkás T-hajtósár	900/42	T91
1 1/2"-os irányváltós racsnis \oplus	900/55	T91
6 T-szerű imbuszkulcs \odot 2,5 - 3 - 4 - 5 - 6 - 8 mm	951	T68
7 hajlított csillagkulcs 6x7-8x9-10x11-12x13-14x15-16x17-18x19 mm	90	T40
5 hajlított csillagkulcs 20x22 - 21x23 - 24x26 - 25x28 - 27x29 mm	90	T41
7 csavarhúzó hasítottfejű csavarokhoz \bullet 2,5x50 - 3x75 - 3,5x100 - 4x125	1260	T199
5,5x100 - 5,5x150 - 6,5x150 mm		
6 Phillips®-csavarhúzó \oplus PH0x60 - PH0x100 - PH1x80 - PH1x120 - PH2x100 - PH2x150 mm	1262	T202
3 csavarhúzó hasítottfejű csavarokhoz \bullet 8x200 - 10x150 - 10x200 mm	1260	T201
2 Lapos törpe csavarhúzó \bullet 4x30 - 6,5x30 mm	1260N	T201
2 Phillips®-csavarhúzó \oplus PH3x150 - PH4x200 mm	1262	T204
2 Csavarhúzó Phillips® - csavarokhoz, extra rövid penge \oplus PH1x30 - PH2x30 mm	1262N	T204
2 erősített laposvágó 100 - 200 mm	35	T234
1 lakatos kalapács 300 g	1370	T234
1 műanyag kalapács \varnothing 35 mm	1390	T234
1 Popszegecshúzó 250 mm	1741	T271
100 alumínium popszegecs 2,9x6 mm	1741RV...K	T271
100 alumínium popszegecs 3,2x8 mm	1741RV...K	T271
100 alumínium popszegecs 3,8x10 mm	1741RV...K	T271
100 alumínium popszegecs 4x12 mm	1741RV...K	T271
100 alumínium popszegecs 4,8x12 mm	1741RV...K	T271
1 vízpumpafogó 250 mm	1048N	T153
1 Egyenes pófájú önzáró fogó 240 mm	1052	T153
5 5 darabos egyengető reszelő készlet markolattal 200 mm	1719BMA...S5	T236
1 egyenes belső Seeger-fogó \odot 180 mm	1032	T145
1 hajlított belső Seeger - fogó \odot 170 mm	1034	T145
1 egyenes külső Seeger-fogó \bullet 175 mm	1036	T145
1 hajlított külső Seeger - fogó \bullet 175 mm	1038	T145
1 kombinált fogó \equiv 180 mm	1150BM	T137
1 Egyenes extra hosszú félkerékcsőrű fogó \bullet 160 mm	1166BM	T137
1 Erősített oldalcsípőfogó ∇ 160 mm	1084BM	T137
5 hosszú kiütő \varnothing 2 - 3 - 4 - 5 - 6 mm	31	T31
1 pontozó \varnothing 4 mm	32	T31
12 villáskulcs 6x7 - 8x9 - 10x11 - 12x13 - 14x15 - 16x17	55	T31
18x19 - 20x22 - 21x23 - 24x26 - 27x29 - 30x32 mm		
9 imbuszkulcs \odot 1,5 - 2 - 2,5 - 3 - 4 - 5 - 6 - 8 - 10 mm	96N/SC9	T31
1 bádogos lemezolló 250 mm	1112	T279
1 Egyenes élű műszerész olló 145 mm	1128BM	T279
1 fűrész	1726	T279
5 fűrészlap	1728BM	T279
1 Olajozó fémkanna 200 cc	1751N	T279
1 Üres hőformált tálcák	VP5	VP5
1 menetfúró hajtóvas M3÷M12	435/1,5	T273
1 menetfúró hajtóvas M5÷M21	435/3	T273
1 racsnis hajtóvas 2,0÷5,0 mm (M3÷M8)	436/1	T273
1 racsnis hajtóvas 4,6÷8,0 mm (M5÷M12)	436/2	T273
1 menetmetsző hajtóvas 25,4 mm	444/1	T273
1 menetmetsző hajtóvas 38,1 mm	444/2	T273
1 Menetsablon 0,25÷6 W 62÷4x1"	1707	T273
26 menetfúró M3 - 4 - 5 - 6 - 7 - 8 - 9 - 10 - 12 - 14 - 16 - 18 - 20	430	T270
14 finom menetfúró M6x0,75 - M8x1 - M10x1,25	433	T270
M12x1,5 - M14x1,5 - M16x1,5 - M18x1,5		
7 menetmetsző M3 - 4 - 5 - 6 - 7 - 8 - 9	440	T270
6 menetmetsző M10 - 12 - 14 - 16 - 18 - 20	440A	T270
2 finom menetmetsző M6x0,75 - M8x0,75	441	T270
5 finom menetmetsző M10x1,25 - M12x1,5 - M14x1,5 - M16x1,5 - M18x1,5	441A	T270



T80 T05 T06



T91 T68 T40 T41



T199 T202 T201 T204



T234 T271 T153 T236

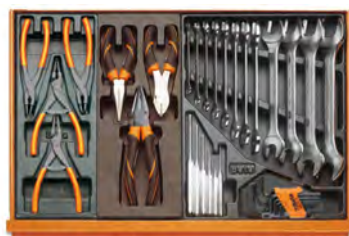

T145 T137 T31



T279 VP5



T273 T270

Ft

5908VI/2T

1.518.200 059081105

5904VI/2T

153 darabos szerszámkészlet ABS hőformált tálcában

► Ipari karbantartás

Mennyiség/megnevezés

- 16 csillag-villáskulcs 6÷21 mm
- 5 csillag-villáskulcs 22 - 24 - 27 - 30 - 32 mm
- 5 hosszú kiütő Ø 2 - 3 - 4 - 5 - 6 mm
- 1 pontozó Ø 4 mm
- 12 villáskulcs 6x7 - 8x9 - 10x11 - 12x13 - 14x15 - 16x17 - 18x19 - 20x22 - 21x23 - 24x26 - 27x29 - 30x32 mm
- 9 imbuszkulcs 1,5 - 2 - 2,5 - 3 - 4 - 5 - 6 - 8 - 10 mm
- 7 hajlított csillagkulcs 6÷29 mm
- 19 1/2"-os hatlapú dugókulcs 10÷24 - 26 - 27 - 30 - 32 mm
- 1 1/2"-os toldó 125 mm
- 1 1/2"-os toldó 255 mm
- 1 1/2"-os csukló
- 1 1/2"-os csúszkás T-hajtósár
- 1 1/2"-os irányváltós racsni
- 13 1/4"-os hatlapú dugókulcs 4÷14 mm
- 6 1/4"-os imbusz-dugókulcs 2,5÷8 mm
- 1 1/4"-os toldó 50 mm
- 1 1/4"-os toldó 150 mm
- 1 1/4"-os csukló
- 1 1/4"-os hajtósár
- 1 1/4"-os csúszkás T-hajtósár
- 1 1/2"-os irányváltós racsni
- 9 csavarhúzó hasítottfejű csavarokhoz 3x75 - 3x100 - 4x100 - 4x150 - 5,5x100 - 5,5x150 - 6,5x150 - 8x150 - 10x200 mm
- 2 Lapos törpe csavarhúzó 4x30 - 6,5x30 mm
- 7 Phillips®-csavarhúzó PH0x60 - PH0x100 - PH1x80 - PH1x120 - PH2x100 - PH2x150 - PH3x150 mm
- 2 Csavarhúzó Phillips® - csavarokhoz, extra rövid penge PH1x30 - PH2x30 mm
- 1 vízpumpafogó 250 mm
- 1 Egyenes pófajú önzáró fogó 240 mm
- 1 Erősített oldalcsipőfogó 160 mm
- 1 Egyenes extra hosszú félkerékcsőrű fogó 160 mm
- 1 kombinált fogó 180 mm
- 1 egyenes belső Seeger-fogó 180 mm
- 1 hajlított belső Seeger - fogó 170 mm
- 1 egyenes külső Seeger-fogó 175 mm
- 1 hajlított külső Seeger - fogó 175 mm
- 6 T-szárú imbuszkulcs 2,5 - 3 - 4 - 5 - 6 - 8 mm
- 5 reszelő 200 mm
- 2 erősített laposvágó 100 - 200 mm
- 1 lakatos kalapács 300 g
- 1 műanyag kalapács Ø 35 mm
- 1 Popszegecshúzó
- 100 alumínium popszegecs 2,9x6 mm
- 100 alumínium popszegecs 3,2x8 mm
- 100 alumínium popszegecs 3,8x10 mm
- 100 alumínium popszegecs 4x12 mm
- 100 alumínium popszegecs 4,8x12 mm
- 1 fékes mérőszalag 5 m
- 1 Mini fűrész
- 1 Letörhető dekorképenge, 18 mm széles 1771HD
- 1 dekorkés 170 mm

Beta-sz.	TR
42	T05
42	T06
31	T31
32	T31
55	T31
96NSC9	T31
90	T40
920A	T83
920/21	T83
920/22	T83
920/25	T83
920/42	T83
920/55	T83
900	T91
900ME	T91
900/20	T91
900/21	T91
900/25	T91
900BG/30	T91
900/42	T91
900/55	T91
1260	T167
1260N	T167
1262	T168
1262N	T168
1048N	T153
1052	T153
1084	T138
1166	T138
1150	T138
1032	T145
1034	T145
1036	T145
1038	T145
951	T68
1719BMA8/S5	T236
35	T234
1370	T234
1390	T234
1741	T271
1741RV..K	T271
1741RV..K	T271
1741RV..K	T271
1741RV..K	T271
1741RV..K	T271
1692	T294
1725CR	T294
1771RL	T294
1771	T294



T05 T06 T31



T40 T83 T91



T167 T168



T153 T138 T145 T68



T236 T234 T271 T294

Ft

5904VI/2T

999.000 059041164

Készletárusítási javaslat RSC23T - RSC24 7 - 8 fiókkal - RSC24A 7 - 8 fiókkal - RSC24AXL - RSC24AXLP/7 - RSC24AXXL - RSC24L/7 - RSC24L-CAB - RSC28 - C37 7 - 8 fiókkal - C39 7 - 8 fiókkal - C39MD - C39SM - C59 - C57 - C58BC - RSC55 - RSC50 2.0



5910VI/3 297 darabos szerszámkészlet

► Ipari karbantartás

Mennyiség/megnevezés	Beta-sz.
6 6 darabos kiütőkészlet tartós poliészterből készült összetekkerhető tokban Ø 2 - 3 - 4 - 5 - 6 - 8 mm	31/B6N
1 pontozó Ø 4 mm	32
2 erősített laposvágó 125 - 250 mm	35
1 erősített keresztvágó 200 mm	37
30 csillag-villáskulcs 6-7-8-9-10-11-12-13-14-15-16-17-18-19-20-21-22-23-24-25-26-27-28-29-30-32-35-36-38-41 mm	42
14 villáskulcs 6x7 - 8x9 - 10x11 - 12x13 - 14x15 - 16x17 - 18x19 - 20x22 - 21x23 - 24x26 - 25x28 - 27x29 - 30x32 - 36x41 mm	55
13 hajlított csillagkulcs 6x7÷30x32 mm	90
14 imbuszkulcs Ø 1,5 - 2 - 2,5 - 3 - 4 - 5 - 6 - 8 - 10 - 12 - 13 - 14 - 17 - 19 mm	96N
1 Allítható villáskulcs 250 mm	111E
1 Amerikai csőfogó 300 mm	362
25 Rövid csigafúró hengeres szárral 1÷13x0,5 mm	412/SP25
37 HSS menetfúró és menetmetsző készlet	447/C37
1 ZERO-RESET kioldó nyomatékulcsok 1/2", 40÷200 Nm	666/20
1 1/2"-os csuklós T-hajtószár	920/40
4 1/2"-os imbusz dugókulcs Ø 10-12-14-17 mm	920ME
25 20 dugókulcs és 5 tartozék fémdobozban	920A/C20X
17 12 dugókulcs és 5 tartozék 3/4"	928A/C12
12 tizenkétszögű pipakulcs 8 - 10 - 11 - 13 - 14 - 17 - 19 - 22 - 24 - 27 - 30 - 32 mm	932
14 T-szárú imbuszkulcs 2÷14 mm	951/S14
5 csuklós T - imbuszkulcs Ø 3 - 4 - 5 - 6 - 8 mm	953
3 egyenes belső Seeger-fogó Ø 180 - 225 - 300 mm	1032
3 hajlított belső Seeger - fogó Ø 170 - 210 - 290 mm	1034
3 egyenes külső Seeger-fogó Ø 140x1,3 - 175 - 225 mm	1036
3 hajlított külső Seeger - fogó Ø 135x1,3 - 175 - 220 mm	1038
2 vízpumpafogó 250 - 300 mm	1048N
1 kettős állítású önzáró fogó	1051
1 erősített oldalcsípőfogó, kétkomponensű markolat ipari kivitel 160 mm	1084GBM
1 áttételes homlokcsípőfogó 180 mm	1092V
1 bádogos lemezolló 300 mm	1112
1 Bádogos olló amerikai modell 250 mm	1114
1 műszerész olló 147 mm	1128BMX
1 robusztus kombinált fogó kétkomponensű markolat ipari kivitel 180 mm	1150GBM
1 egyenes extra hosszú félkerékcsőrű fogó, kétkomponensű markolat ipari kivitel 160 mm	1166GBM
1 hajlított extra hosszú félkerékcsőrű fogó, kétkomponensű markolat ipari kivitel 160 mm	1168GBM
9 csavarhúzó hasítottfejű csavarokhoz 2,5x50 - 3x75 - 3,5x100 - 4x125 - 5,5x125 - 6,5x150 - 8x200 - 10x200 - 12x250 mm	1260
2 Lapos törpe csavarhúzó 4x30 - 6,5x30 mm	1260N
5 Phillips®-csavarhúzó PH0x100 - PH1x120 - PH2x150 - PH3x150 - PH4x200 mm	1262
2 Csavarhúzó Phillips® - csavarokhoz, extra rövid penge PH1x30 - PH2x30 mm	1262N
7 Imbusz csavarhúzó Torx®-csavarokhoz T6 - T8 - T10 - T15 - T20 - T25 - T30	1267TX
2 lakatos kalapács 300 - 600 g	1370
2 műanyag kalapács Ø 35 - 60 mm	1390
5 Törtcsavarkiszedő M3÷M18	1430/S5
1 Kétkörmös univerzális csapágyelhúzó 23÷70 mm	1500N/1
1 Kétkörmös univerzális csapágyelhúzó 23÷100 mm	1500N/2
1 tolómérő	1650
1 fémvonalzó 300 mm	1683
1 rajztű	1688A
1 fékes mérőszalag 5 m	1692
1 Hézagmérő	1708/13
1 flexibilis mágneses csavarkiszedő 1,8 kg	1712E/2
5 reszelő 200 mm	1719BMA8/S5
1 fűrész	1726BM
1 Popszegecshúzó	1741
1 Olajozó fémkanna 200 cc	1751N

Ft

5910VI/3 3.166.400 059101044

A C30M munkapadhoz ajánlott készlet

► Ipari karbantartás

Mennyiség/megnevezés

- 16 csillag-villáskulcs 6÷21 mm
- 5 csillag-villáskulcs 22 - 24 - 27 - 30 - 32 mm
- 5 hosszú kiütő Ø 2 - 3 - 4 - 5 - 6 mm
- 1 pontozó Ø 4 mm
- 13 villáskulcs 6x7 - 8x9 - 10x11 - 12x13 - 14x15 - 16x17 - 18x19 - 20x22 - 21x23 - 24x26 - 27x29 - 30x32 mm
- 9 imbuszkulcs Ø 1,5 - 2 - 2,5 - 3 - 4 - 5 - 6 - 8 - 10 mm
- 5 hajlított csillagkulcs 20x22 - 21x23 - 24x26 - 25x28 - 27x29 mm
- 7 hajlított csillagkulcs 6x7 - 8x9 - 10x11 - 12x13 - 14x15 - 16x17 - 18x19 mm
- 5 1/2"-os imbusz dugókulcs Ø 5 - 6 - 8 - 10 - 12 mm
- 1 1/2"-os toldó 125 mm
- 1 1/2"-os toldó 255 mm
- 1 1/2"-os csukló
- 1 1/2"-os csúszkás T-hajtószár
- 1 1/2"-os irányváltós racsnit
- 19 1/2"-os hatlapú dugókulcs Ø 10÷24 - 26 - 27 - 30 - 32 mm
- 9 csavarhúzó hasítottfejű csavarokhoz ● 3x75 - 3x100 - 4x100 - 4x150 - 5,5x100 - 5,5x150 - 6,5x150 - 8x150 - 10x200 mm
- 2 Lapos törpe csavarhúzó ● 4x30 - 6,5x30 mm
- 7 Phillips®-csavarhúzó ● PH0x60 - PH0x100 - PH1x80 - PH1x120 - PH2x100 - PH2x150 - PH3x150 mm
- 2 Csavarhúzó Phillips® - csavarokhoz, extra rövid penge ● PH1x30 - PH2x30 mm
- 4 imbuszkulcs Ø 13-14-17-19 mm
- 1 bádogos lemezolló 250 mm
- 1 Egyenes élű műszerész olló 145 mm
- 1 fűrész
- (5) fűrészlap
- 1 Olajozó fémkanna 200 cc
- 1 kombinált fogó = 180 mm
- 1 Egyenes extra hosszú félkerékcserő fogó ● 160 mm
- 1 Erősített oldalcsípőfogó † 160 mm
- 1 egyenes belső Seeger-fogó Ø 180 mm
- 1 hajlított belső Seeger - fogó Ø 170 mm
- 1 egyenes külső Seeger-fogó ● 175mm
- 1 hajlított külső Seeger - fogó ● 175mm
- 2 erősített laposvágó 100 - 200 mm
- 1 lakatos kalapács 300 g
- 1 műanyag kalapács Ø 35 mm
- 1 reszelő 200 mm
- 4 csillag-villáskulcs 35-36-38-41 mm
- 1 villáskulcs 36x41 mm
- 1 Állítható villáskulcs 250 mm
- 1 Amerikai csőfogó 300 mm
- 25 Rövid csigafúró hengeres szárral
- 37 HSS menetfúró és menetmetsző készlet
- 1 ZERO-RESET kioldó nyomaték kulcsok ⊗ 40÷200 Nm
- 17 12 dugókulcs és 5 tartozék 3/4"
- 14 T-szárú imbuszkulcs
- 5 csuklós T - imbuszkulcs Ø 3-4-5-6-8 mm
- 1 egyenes belső Seeger-fogó Ø 300 mm
- 1 hajlított belső Seeger - fogó Ø 290 mm
- 1 egyenes külső Seeger-fogó ● 225 mm
- 1 hajlított külső Seeger - fogó ● 220 mm
- 1 vízpumpafogó 300 mm
- 1 kettős állítású önzáró fogó
- 1 áttételes homlokcsípőfogó † 180 mm
- 1 lakatos kalapács 600 g
- 1 műanyag kalapács Ø 60 mm
- 5 Törtcsavarkiszedő M3-M18
- 1 Kétkörmös univerzális csapáglehúzó
- 1 tolómérő
- 1 fémvonalzó
- 1 rajztű
- 1 fékes mérőszalag 5 m
- 1 Hézagmérő
- 1 flexibilis mágneses csavarkiszedő

Beta-sz.	TR
42	T05
42	T06
31	T31
32	T31
55	T31
96N/C9	T31
90	T41
90	T40
920ME	T80
920/21	T80
920/22	T80
920/25	T80
920/42	T80
920/55	T80
920A	T80
1260	T167
1260N	T167
1262	T168
1262N	T168
96N	T168
1112	T279
1128BM	T279
1726	T279
1728BM	T279
1751N	T279
1150BM	T137
1166BM	T137
1084BM	T137
1032	T145
1034	T145
1036	T145
1038	T145
35	T234
1370	T234
1390	T234
1719BMA8/S5	T234
42	T236
55	T236
111E	T236
362	T236
412/SP25	T236
447/C37	T236
666/20	T236
928A/C12	T236
951/S14	T236
953	T236
1032	T236
1034	T236
1036	T236
1038	T236
1048N	T236
1051	T236
1092V	T236
1370	T236
1390	T236
1430/S5	T236
1500/3	T236
1650	T236
1683	T236
1688	T236
1692	T236
1708/13	T236
1712E/2	T236

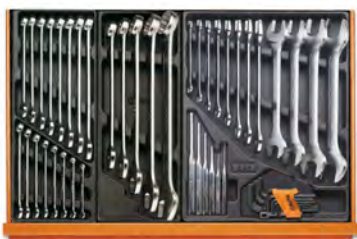

T05 T06 T31



T40 T41 T80



T167 T168 +96N



T279 T137 T145 T234 T236



5935VI/2MB

133 darabos szerszámkészlet a C35 szerszámcsomaghoz habszivacs tálcában

► Ipari karbantartás

Mennyiség/megnevezés

- 21 csillag-villáskulcs 6-7-8-9-10-11-12-13-14-15-16-17-18-19-20-21-22-24-27-30-32 mm
- 8 villáskulcs 6x7-8x9-10x11-12x13-14x15
16x17-18x19-20x22 mm
- 1 vízpumpafofogó 250 mm
- 19 1/2"-os hatlapú dugókulcs \odot 10-11-12-13-14-15-16-17-18-19-20-21-22-23-24-26-27-30-32 mm
- 1 1/2" Gömbvégű toldó 125 mm
- 1 1/2" Gömbvégű toldó 150 mm
- 1 1/2"-os csukló
- 1 1/2"-os csúszkás T-hajtószer
- 1 1/2"-os irányváltós racsnival \oplus
- 1 Állítható villáskulcs 250 mm
- 1 Egyenes pofájú önzáró fogó 240 mm
- 1 Erősített oldalcsípőfogó \ddagger 160 mm
- 1 kombinált fogó \equiv 180 mm
- 1 Egyenes extra hosszú félkerekcsőrű fogó \bullet 160 mm
- 1 egyenes belső Seeger-fogó \odot 180 mm
- 1 hajlított belső Seeger - fogó \odot 170 mm
- 1 egyenes külső Seeger-fogó \bullet 175 mm
- 1 hajlított külső Seeger - fogó \bullet 175 mm
- 13 1/4"-os hatlapú dugókulcs \odot 4-4,5-5-5,5-6-7-8-9-10-11-12-13-14 mm
- 1 1/4" - os toldó 50 mm
- 1 1/4" - os toldó 150 mm
- 1 1/4"-os csukló
- 1 1/4"-os hajtószer
- 1 1/2"-os irányváltós racsnival \oplus
- 1 1/4"-os csúszkás T-hajtószer
- 7 csavarhúzó hasítottfejű csavarokhoz \bullet 2,5x50-3x75-3,5x100-4x100-5,5x125-6,5x150-8x200 mm
- 2 Lapos törpe csavarhúzó \bullet 4x30-6,5x30 mm
- 7 Phillips®-csavarhúzó \oplus PH0x60-PH0x100-PH1x80-PH1x120-PH2x100-PH2x150-PH3x150 mm
- 2 Csavarhúzó Phillips® - csavarokhoz, extra rövid penge \oplus PH1x30-PH2x30 mm
- 1 Fáziskereső \bullet 4x30-6,5x30 mm
- 9 Hajlított gömbfejű imbuszkulcs \odot
- 6 T-szerű imbuszkulcs \odot 2,5-3-4-5-6-8 mm
- 5 hosszú kiütő \emptyset 2-3-4-5-6 mm
- 1 pontozó \emptyset 4 mm
- 1 erősített laposvágó 200 mm
- 1 bádgos lemezolló 250 mm
- 1 műszerész olló 147 mm
- 1 lakatos kalapács 500 g
- 1 műanyag kalapács \emptyset 45 mm
- 1 szögletes egyengető reszelő markolattal 200 mm
- 1 háromszög egyengető reszelő markolattal 200 mm
- 1 lapos egyengető reszelő markolattal 200 mm
- 1 félkerek egyengető reszelő markolattal 200 mm
- 1 kerek egyengető reszelő markolattal 200 mm
- 1 fűrész 440 mm

Beta-sz.	TR
42	MB12
55	MB12
1048N	MB12
920A	MB37
920AN/125	MB37
920AN/250	MB37
920/25	MB37
920/42	MB37
920/55	MB37
111E	MB37
1052	MB37
1084BM	MB37
1150BM	MB37
1166BM	MB37
1032	MB37
1034	MB37
1036	MB37
1038	MB37
900	MB37
900/20	MB37
900/21	MB37
900/25	MB37
900BG/30	MB37
900/55	MB37
900/42	MB37
1260	MB44
1260N	MB44
1262	MB44
1262N	MB44
1253	MB44
96BPC/SC9	MB44
951	MB44
31	MB55
32	MB55
35	MB55
1112	MB55
1128BMX	MB55
1370	MB55
1390	MB55
1719BMA...Q	MB55
1719BMA...T	MB55
1719BMA...P	MB55
1719BMA...M	MB55
1719BMA...R	MB55
1726	MB55



MB12



MB37

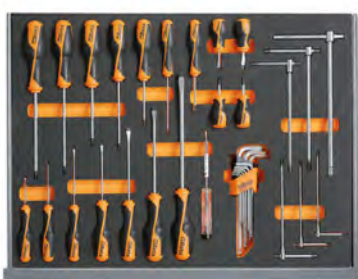

MB44



MB55

Ft

5935VI/2MB

1.043.600 059351316

Készletársítási javaslat C35



► Ipari karbantartás

Mennyiség/megnevezés	Beta-sz.
6 Hosszú kiütő Ø 2 - 3 - 4 - 5 - 6 - 8 mm	31/SP6
6 2 kiütő, 1 pontozó, 3 hidegvágó	38/SP6
18 csillag-villáskulcs 6-7-8-10-11-12-13-14-15-16-17 19-21-22-24-27-30-32 mm	42
12 villáskulcs 6x7 ± 30x32 mm	55/S12X
8 T - szárú imbuszkulcs műanyag markolattal 2 - 2,5 - 3 - 4 - 5 - 6 - 8 - 10 mm	96T/S8
8 8 részes hajlítot Torx® imbuszkulcs szerszám készlet T9 - T10 - T15 - T20 - T25 - T27 - T30 - T40	97TX/SC8
1 Állítható villáskulcs 250 mm	111E
13 1/2"-os tizenkétszögű dugókulcs Ø 10÷22 mm	920B/SB13
8 1/2"-os tizenkétszögű dugókulcs Ø 23÷32 mm	920B/SB8
4 1/2" - os csavarhúzó dugókulcs ● 1,2x6,5 - 1,2x8 - 1,6x9 - 2x12 mm	920LP
3 1/2" - os Phillips® csavarhúzó dugókulcs ⊕ PH2 - 3 - 4	920PH
1 1/2"-os toldó 125 mm	920/21
1 1/2"-os toldó 255 mm	920/22
1 1/2"-os csukló	920/25
1 1/2"-os csúszkás T-hajtószár	920/42
1 1/2"-os irányváltós racsnit ⊗	920/55
1 egyenes feszítővas	963
2 egyenes belső Seeger-fogó ⊙ 140 - 180 mm	1032
2 hajlítot belső Seeger - fogó ⊙ 130 - 170 mm	1034
2 egyenes külső Seeger-fogó ● 140 - 175 mm	1036
2 hajlítot külső Seeger - fogó ● 135 - 175 mm	1038
1 vízpumpafogó 250 mm	1048N
1 kettős állítású önzáró fogó	1051
1 Erősített oldalcsípőfogó ⚡ 160 mm	1084BM
1 áttételes homlokcsípőfogó ⚡ 180 mm	1092V
1 bádogos lemezolló 250 mm	1112
1 Bádogos olló amerikai modell 250 mm	1114
1 műszerész olló 147 mm	1128BMX
1 kombinált fogó ≡ 180 mm	1150BM
1 Egyenes extra hosszú félkeréksörű fogó ● 160 mm	1166BM
1 Hajlítot extra hosszú félkeréksörű fogó ● 160 mm	1168BM
7 csavarhúzó hasítottfejű csavarokhoz ● 2,5x50 - 3x75 - 4x100 5,5x125 - 6,5x150 - 8x200 - 10x200 mm	1260
4 Phillips®-csavarhúzó ⊕ PH0x60 - PH1x80 - PH2x100 - PH3x150 mm	1262
3 lakatos kalapács 300 - 600 - 1000 g	1370
1 műanyag kalapács Ø 35 mm	1390
1 fékes mérőszalag 5 m	1692
1 flexibilis mágneses csavarkiszedő 1,8 kg	1712E/2
1 kétélű hántoló 150 mm	1717A
1 háromélű hántoló 200 mm	1717B
5 reszelő 200 mm	1719BMA8/S5
1 fűrész	1725
1 pumpás fém olajozó kanna 200 cc	1751
1 erősített laposvágó 200 mm	35
1 erősített keresztvágó 200 mm	37
11 tizenkétszögű pipakulcs 8 - 10 - 11 - 12 - 13 - 14 - 16 - 17 19 - 22 - 24 mm	932
1 Egyenes pofájú önzáró fogó 240 mm	1052
1 Egyenes pofájú önzáró fogó 280 mm	1060
1 Egyenes pofájú önzáró fogó 290 mm	1062
1 ütéseinyelő műanyag kalapács Ø 50 mm	1392
1 Kétkörmös univerzális csapáglehúzó 25÷130 mm	1500N/2
1 tolómérő	1650
1 fémvonalzó 300 mm	1683
1 rajztű	1688A
1 Hézagmérő	1708/13
1 blankoló kés	1777BM
1 dekorkés 170 mm	1771BM
1 Oldalcsípőfogó ⚡ 160 mm	1082BM

Ft



5957VI

1.606.200 059571005

Készletársítási javaslat C57SA - C57SB - C57SP - C58BC

5954VI

133 darabos szerszámkészlet

► **Ipari karbantartás**

Mennyiség/megnevezés

Beta-sz.

5	hosszú kiütő Ø 2-3-4-5-6 mm	31
1	pontozó Ø 4 mm	32
2	erősített laposvágó 200-250 mm	35
18	csillag-villáskulcs 6÷14 - 16 - 17 - 18 - 19 - 21 - 22 - 24 - 27 - 30 mm	42
12	villáskulcs 6x7 - 8x9 - 10x11 - 12x13 - 14x15 - 16x17 18x19 - 20x22 - 21x23 - 24x26 - 27x29 - 30x32 mm	55
12	imbuszkulcs Ø 2÷10 mm	96/SC12
1	Állítható villáskulcs 250 mm	111E
1	svéd csőfogó 320 mm	374
20	1/2"-os hatlapú dugókulcs Ø 10÷24 - 26 - 27 - 28 - 30 - 32 mm	920A
6	1/2"-os imbusz dugókulcs Ø 5 - 6 - 8 - 10 - 12 - 14 mm	920ME
1	1/2"-os toldó 125 mm	920/21
1	1/2"-os toldó 255 mm	920/22
1	1/2"-os csukló	920/25
1	1/2"-os csuklós T-hajtósár	920/40
1	1/2"-os csúszkás T-hajtósár	920/42
1	1/2"-os irányváltós racsnit	920/55
6	T-szerű imbuszkulcs Ø 2,5 - 3 - 4 - 5 - 6 - 8 mm	951
2	egyenes belső Seeger-fogó Ø 140 - 180 mm	1032
1	hajlított belső Seeger - fogó Ø 170 mm	1034
2	egyenes külső Seeger-fogó Ø 140x1,3 - 175 mm	1036
1	hajlított külső Seeger - fogó Ø 175 mm	1038
1	vízpumpafogó 250 mm	1048N
1	Egyenes pófájú önzáró fogó 240 mm	1052
1	Erősített oldalcsípőfogó 160 mm	1084BM
1	áttételes homlokcsípőfogó 180 mm	1092V
1	bádogos lemezolló 250 mm	1112
1	műszerész olló 147 mm	1128BMX
1	kombinált fogó 180 mm	1150BM
1	Egyenes extra hosszú félkerekcsőrű fogó Ø 160 mm	1166BM
1	Fáziskereső	1253
2	csavarhúzó hasítottfejű csavarokhoz Ø 8x150 - 10x200 mm	1260
2	Lapos törpe csavarhúzó Ø 4x30 - 6,5x30 mm	1260N
2	Phillips®-csavarhúzó PH3x150 - PH4x200 mm	1262
2	Csavarhúzó Phillips® - csavarokhoz, extra rövid penge PH1x30 - PH2x30 mm	1262N
8	csavarhúzókészlet	1263/D8
2	lakatos kalapács 300 - 500 g	1370
1	műanyag kalapács Ø 45 mm	1390
1	fékes mérőszalag 5 m	1692
1	flexibilis mágneses csavarkiszedő 0,5 kg	1712E/1
5	reszelő 200 mm	1719BMA8/S5
1	fűrész	1726BM
1	pumpás műanyag olajozó kanna 250 cc	1754



Ft



5954VI

1.098.700 059541053

Készletlátsítási javaslat C54S-C55C



M05 M33 M204 M201



M50 M83



M137 M153 M234 M145

5904VU/1M

90 darabos szerszámkészlet habszivacs tálcában

► Univerzális alkalmazás

Mennyiség/megnevezés

- 16 csillag-villáskulcs 6÷21 mm
- 8 villáskulcs 6x7 - 8x9 - 10x11 - 12x13 - 14x15 - 16x17 - 18x19 - 20x22 mm
- 9 imbuszkulcs \odot 1,5 - 2 - 2,5 - 3 - 4 - 5 - 6 - 8 - 10 mm
- 6 imbusz csavarhúzó Torx®-csavarokhoz \odot T8-T10-T15-T20-T25-T30
- 3 csavarhúzó hasítottfejű csavarokhoz \bullet 3x75-4x100-6,5x150 mm
- 3 Phillips®-csavarhúzó \bullet PH0x60-PH1x80-PH2x100 mm
- 8 T - szárú imbuszkulcs műanyag markolattal \odot 2-2,5-3-4-5-6-7-8 mm
- 1 1/2" Gömbvégű toldó 125 mm
- 1 1/2" Gömbvégű toldó 250 mm
- 1 1/2"-os csukló
- 1 1/2"-os csúszkás T-hajtószár
- 1 1/2"-os irányváltós racsnit \odot
- 19 1/2"-os hatlapú dugókulcs \odot 10÷24 - 26 - 27 - 30 - 32 mm
- 1 Erősített oldalcsípőfogó \llcorner 160 mm
- 1 kombinált fogó \equiv 180 mm
- 1 Egyenes extra hosszú félkerekcsőrű fogó \bullet 160 mm
- 1 vízpumpa fogó 250 mm
- 1 Egyenes pófájú önzáró fogó 240 mm
- 2 erősített laposvágó 100 - 200 mm
- 1 lakatos kalapács 300 g
- 1 műanyag kalapács \varnothing 35 mm
- 1 egyenes belső Seeger-fogó \odot 180 mm
- 1 hajlított belső Seeger - fogó \odot 170 mm
- 1 egyenes külső Seeger-fogó \bullet 175 mm
- 1 hajlított külső Seeger - fogó \bullet 175 mm

Beta-sz.	TR
42	M05
55	M33
96/SC9	M33
1267TX	M204
1260	M201
1262	M201
96T	M50
920AN/125	M83
920/25	M83
920/42	M83
920/55	M83
920A	M83
1084	M137
1150	M137
1166	M137
1048N	M153
1052	M153
35	M234
1370	M234
1390	M234
1032	M145
1034	M145
1036	M145
1038	M145

Ft

5904VU/1M

641.600 059041201

Készletlétszámsítási javaslat RSC23T - RSC24 - RSC24A - RSC24AXL - RSC24AXLP/7 - RSC24AXXL - RSC24L/7 - RSC24L-CAB
RSC28 - C37 - C39 - C39T - C39SM - C39MD - RSC51 - RSC55 - RSC50 2.0 - C59 - C58BC - C57

5904VU/2M

144 darabos szerszámkészlet habszivacs tálcában

► Univerzális alkalmazás

Mennyiség/megnevezés

- 16 csillag-villáskulcs 6÷21 mm
- 8 villáskulcs 6x7 - 8x9 - 10x11 - 12x13 - 14x15 - 16x17 - 18x19 - 20x22 mm
- 9 imbuszkulcs \odot 1,5 - 2 - 2,5 - 3 - 4 - 5 - 6 - 8 - 10 mm
- 3 csavarhúzó hasítottfejű csavarokhoz \bullet 3x75-4x100-6,5x150 mm
- 3 Phillips®-csavarhúzó \oplus PH0x60-PH1x80-PH2x100 mm
- 6 Imbusz csavarhúzó Torx®-csavarokhoz \odot T8-T10-T15-T20-T25-T30
- 8 T - szárú imbuszkulcs műanyag markolattal \odot 2-2,5-3-4-5-6-7-8 mm
- 1 1/2" Gömbvégű toldó 125 mm
- 1 1/2" Gömbvégű toldó 250 mm
- 1 1/2"-os csukló
- 1 1/2"-os csúszkás T-hajtószer
- 1 1/2"-os irányváltós racsnit \oplus
- 19 1/2"-os hatlapú dugókulcs \odot 10÷24 - 26 - 27 - 30 - 32 mm
- 1 Erősített oldalcsípófogó \ddagger 160 mm
- 1 kombinált fogó \equiv 180 mm
- 1 Egyenes extra hosszú félkerecsőrű fogó \bullet 160 mm
- 1 vízpumpafogó 250 mm
- 1 Egyenes pofájú önzáró fogó 240 mm
- 2 erősített laposvágó 100 - 200 mm
- 1 Lakatos kalapács német modell műanyag nyéllel 300 g
- 1 Kalapács cserélhető Nylon-végekkel, fanyéllal \varnothing 35 mm
- 1 egyenes belső Seeger-fogó \odot 180 mm
- 1 hajlított belső Seeger - fogó \odot 170 mm
- 1 egyenes külső Seeger-fogó \bullet 175 mm
- 1 hajlított külső Seeger - fogó \bullet 175 mm
- 1 Üres hőformált tálcák
- 1 fékes mérőszalag 5 m
- 1 Mini fűrész
- 1 Letörhető dekorkéspenge, 18 mm széles1771HD
- 1 dekorkés 170 mm
- 5 Színes csavarhúzóbetét hasítottfejű csavarokhoz \bullet 0,5x3 - 0,6x4,5 - 0,8x5,5 - 1x5,5 - 1,2x6,5 mm
- 8 Színes hatszögű csavarhúzóbetét \odot 2 - 2,5 - 3 - 4 - 5 - 6 - 8 - 10 mm
- 5 Színes csavarhúzóbetét Phillips®-csavarokhoz \oplus PH0 - PH1 - PH2 - PH3 - PH4
- 4 Színes csavarhúzóbetét Pozidriv®- és Supadriv®-csavarokhoz \oplus PZ1 - PZ2 - PZ3 - PZ4
- 11 Színes csavarhúzóbetét Torx®-csavarokhoz \odot T6-T7-T8-T9-T10-T15-T20-T25-T27-T30-T40
- 8 Színes csavarhúzóbetét Tamper Resistant Torx®-csavarokhoz \oplus T9-T10-T15-T20-T25-T27-T30-T40
- 1 Betéttartó nyéllel 230 mm
- 1 Irányváltós racsnit, betéttartóval \oplus 100 mm
- 5 reszelő 200 mm
- 1 Adapter dugókulcshoz
- 1 Mágneses betéttartó

Beta-sz.	TR
	42
	M05
	55
	M33
	96/SC9
	M33
	1260
	M201
	1262
	M201
	1267TX
	M204
	96T
	M50
920AN/125	M83
920AN/250	M83
920/25	M83
920/42	M83
920/55	M83
920A	M83
1084	M137
1150	M137
1166	M137
1048N	M153
1052	M153
35	M237
1370T	M237
1390N	M237
1032	M145
1034	M145
1036	M145
1038	M145
VPM3	VPM3
1692	M294
1725CR	M294
1771RL	M294
1771	M294
860LP	M85
860PE	M85
860PH	M85
860PZ	M85
860TX	M85
860RTX	M85
851SR	M85
860/55	M85
1719BMA8/S5	M236
892/0	M85
882P	M85



M05 M33 M204 M201



M50 M83



M137 M153 M237 M145



VPM3 M294 M85 M236

Ft

5904VU/2M

833.300 059041212

Készletlétszámsági javaslat RSC23T - RSC24 - RSC24A - RSC24AXL - RSC24AXLP/7 - RSC24AXXL - RSC24L/7 - RSC24L-CAB
RSC28 - C37 - C39 - C39SM - C39MD - C39T - RSC55 - RSC50 2.0 - C59 - C58BC - C57

5904VU/2T

104 darabos szerszámkészlet ABS hőformált tálcában

► Univerzális alkalmazás

Mennyiség/megnevezés

- 7 csavarhúzó hasítottfejű csavarokhoz ● 2,5x50 - 3x75 - 3,5x100 - 4x125
5,5x100 - 5,5x150 - 6,5x150 mm
- 6 Phillips®-csavarhúzó ● PH0x60 - PH0x100 - PH1x80 - PH1x120 - PH2x100 - PH2x150 mm
- 19 1/2"-os hatlapú dugókulcs ○ 10-11-12-13-14-15-16-17-18-19
20-21-22-23-24-26-27-30-32 mm
- 1 1/2"-os toldó 125 mm
- 1 1/2"-os toldó 255 mm
- 1 1/2"-os csukló
- 1 1/2"-os csúszkás T-hajtószár 305 mm
- 1 1/2"-os irányváltós racsnit ⊗
- 1 egyenes belső Seeger-fogó ○ 180 mm
- 1 hajlított belső Seeger - fogó ○ 170 mm
- 1 egyenes külső Seeger-fogó ● 175 mm
- 1 hajlított külső Seeger - fogó ● 175 mm
- 1 vízpumpafogó 250 mm
- 1 Egyenes pófájú önzáró fogó 240 mm
- 1 Erősített oldalcsipőfogó ⊚ 160 mm
- 1 kombinált fogó ≡ 180 mm
- 1 Egyenes extra hosszú félkerekcsőrű fogó ● 160 mm
- 2 erősített laposvágó 100-200 mm
- 1 lakatos kalapács 300 g
- 1 műanyag kalapács Ø 35 mm
- 6 T-szárú imbuszkulcs ○ 2,5-3-4-5-6-8 mm
- 8 villáskulcs 6x7-8x9-10x11-12x13-14x15
16x17-18x19-20x22 mm
- 9 imbuszkulcs ○ 1,5+10 mm
- 16 csillag-villáskulcs 6-7-8-9-10-11-12-13-14-15-16-17
18-19-20-21 mm
- csillag-villáskulcs 22-24-27-30-32 mm
- 1 műszerész olló 147 mm
- 1 univerzális olló
- 1 szögletes egyengető reszelő markolattal 200 mm
- 1 lapos egyengető reszelő markolattal 200 mm
- 1 háromszög egyengető reszelő markolattal 200 mm
- 1 félkerek egyengető reszelő markolattal 200 mm
- 1 kerek egyengető reszelő markolattal 200 mm
- 1 fűrész
- 1 fűrészlap
- 1 dekorkés 170 mm
- 1 185 mm

Beta-sz.	TR
1260	T199
1262	T202
920A	T83
920/21	T83
920/22	T83
920/25	T83
920/42	T83
920/55	T83
1032	T145
1034	T145
1036	T145
1038	T145
1048N	T153
1052	T153
1084	T138
1150	T138
1166	T138
35	T234
1370	T234
1390	T234
951	T68
55	T33
96/SC9	T33
42	T05
42	T06
1128BMX	T284
1130BMX	T284
1719BMA...Q	T284
1719BMA...P	T284
1719BMA...T	T284
1719BMA...M	T284
1719BMA...R	T284
1726BM	T284
1728BM	T284
1771BM	T284
1778V18	T284



T199 T202 T83



T145 T153 T138 T234



T68 T33 T05 T06



T284

Ft

5904VU/2T

761.400 059041070

Készletértékesítési javaslat RSC23T - RSC24 - RSC24A - RSC24AXL - RSC24AXLP/7 - RSC24AXXL - RSC24L/7 - RSC24L-CAB
RSC28 - C37 - C39 - C39SM - C39MD - C39T RSC55 - RSC50 2.0 - C59 - C58BC - C57

5904VU/3T

146 darabos szerszámkészlet ABS hőformált tálcában

► Univerzális alkalmazás

Mennyiség/megnevezés

- 16 csillag-villáskulcs 6÷21 mm
- 5 csillag-villáskulcs 22 - 24 - 27 - 30 - 32 mm
- 5 hosszú kiütő Ø 2 - 3 - 4 - 5 - 6 mm
- 1 pontozó Ø 4 mm
- 12 villáskulcs 6x7 - 8x9 - 10x11 - 12x13 - 14x15 - 16x17 - 18x19 - 20x22 - 21x23 - 24x26 - 27x29 - 30x32 mm
- 9 imbuszkulcs Ø 1,5 - 2 - 2,5 - 3 - 4 - 5 - 6 - 8 - 10 mm
- 6 T - szárú imbuszkulcs műanyag markolattal Ø 2 - 2,5 - 3 - 4 - 5 - 6 mm
- 6 Imbusz csavarhúzókészlet Torx®-csavarokhoz ⚙ T10-T15-T20-T25-T27-T30
- 5 1/2"-os imbusz dugókulcs Ø 5 - 6 - 8 - 10 - 12 mm
- 1 1/2"-os toldó 125 mm
- 1 1/2"-os toldó 255 mm
- 1 1/2"-os csukló
- 1 1/2"-os csúszkás T-hajtósár
- 1 1/2"-os irányváltós racsnit
- 19 1/2"-os hatlapú dugókulcs Ø 10÷24 - 26 - 27 - 30 - 32 mm
- 13 1/4"-os hatlapú dugókulcs Ø 4-4,5-5-5,5-6-7-8-9-10-11-12-13-14 mm
- 6 1/4"-os imbusz-dugókulcs Ø 2,5-3-4-5-6-8 mm
- 1 1/4"-os toldó 50 mm
- 1 1/4"-os toldó 150 mm
- 1 1/4"-os csukló
- 1 1/4"-os hajtósár
- 1 1/4"-os csúszkás T-hajtósár 115 mm
- 1 1/2"-os irányváltós racsnit
- 1 egyenes belső Seeger-fogó ⚙ 180 mm
- 1 hajlított belső Seeger - fogó ⚙ 170 mm
- 1 egyenes külső Seeger-fogó ⚙ 175 mm
- 1 hajlított külső Seeger - fogó ⚙ 175 mm
- 1 kombinált fogó ⚙ 180 mm
- 1 Egyenes extra hosszú félkerécsőrű fogó ⚙ 160 mm
- 1 Erősített oldalcsípőfogó ⚙ 160 mm
- 1 vízpumpafogó 250 mm
- 1 Egyenes pofájú önzáró fogó 240 mm
- 4 csavarhúzó hasítottfejű csavarokhoz ⚙ 3x75 - 4x100 - 5,5x150 - 6,5x150 mm
- 3 Csavarhúzó Pozidriv®-Supadriv®-csavarokhoz ⚙ PZ0 - PZ1 - PZ2
- 7 Imbusz csavarhúzó Torx®-csavarokhoz ⚙ T6-T7-T8-T9-T10-T15-T20
- 2 erősített laposvágó 100 - 200 mm
- 1 lakatos kalapács 300 g
- 1 műanyag kalapács Ø 35 mm
- 5 reszelő 200 mm

Beta-sz.	TR
42	T05
42	T06
31	T31
32	T31
55	T31
96N/SC9	T31
96T	T52
97TTX	T55
920ME	T80
920/21	T80
920/22	T80
920/25	T80
920/42	T80
920/55	T80
920A	T80
900	T91
900ME	T91
900/20	T91
900/21	T91
900/25	T91
900BG/30	T91
900/42	T91
900/55	T91
1032	T145
1034	T145
1036	T145
1038	T145
1150	T138
1166	T138
1084	T138
1048N	T153
1052	T153
1260	T198
1269PZ	T198
1267TX	T205
35	T234
1370	T234
1390	T234
1719BMA8/55	T236



T05 T06 T31



T52 T55 T80



T91 T145 T138 T153

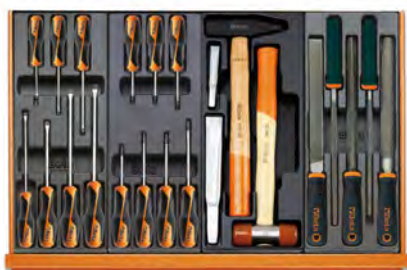

T198 T205 T234 T236

Ft

5904VU/3T

920.600 059041203

Készletlétszámok: RSC23T - RSC24 - RSC24A - RSC24AXL - RSC24AXLP/7 - RSC24AXXL - RSC24L/7 - RSC24L-CAB
C37 - C39 - C39T - C39SM - C39MD - RSC55 - RSC50 2.0 - C59 - C58BC - C57

5904VU/4T

197 darabos szerszámkészlet ABS hőformált tálcában

► Univerzális alkalmazás

Mennyiség/megnevezés

- 1 kiütő Ø 4 mm
- 1 hosszú kiütő Ø 4 mm
- 1 pontozó Ø 4 mm
- 54 52 hatszögű csavarhúzóbetét, 10 mm és 2 tartozék
- 17 csillag-villáskulcs 6-7-8-10-11-12-13-14-16-17-18-19-21-22-24-27-30 mm
- 7 hajlított csillagkulcs 6x7-8x9-10x11-12x13-14x15-16x17-18x19 mm
- 19 1/2"-os hatlapú dugókulcs ○ 10-11-12-13-14-15-16-17-18-19-20-21-22-23-24-26-27-30-32 mm
- 1 1/2"-os toldó 125 mm
- 1 1/2"-os toldó 250 mm
- 1 1/2"-os csukló
- 1 1/2"-os csúszkás T-hajtósár 305 mm
- 1 1/2"-os irányváltós racsnit
- 13 1/4"-os hatlapú dugókulcs ○ 4-4,5-5-5,5-6-7-8-9-10-11-12-13-14 mm
- 6 1/4"-os imbusz-dugókulcs ○ 2,5-3-4-5-6-8 mm
- 1 1/4"-os toldó 50 mm
- 1 1/4"-os toldó 150 mm
- 1 1/4"-os csukló
- 1 1/4"-os hajtósár
- 1 1/4"-os csúszkás T-hajtósár 115 mm
- 1 1/2"-os irányváltós racsnit
- 1 Oldalcsipőfogó 160 mm
- 1 kombinált fogó 180 mm
- 1 vízpumpafogó 250 mm
- 7 csavarhúzó hasítottfejű csavarokhoz ● 2,5x50 - 3x75 - 3,5x100 - 4x125 - 5,5x100 - 5,5x150 - 6,5x150 mm
- 6 csavarhúzó keresztfejű Phillips® csavarokhoz ● PH0x60 - PH1x80 - PH1x120 - PH2x100 - PH2x150 - PH3x150 mm
- 7 imbusz-csavarhúzó Torx®-csavarokhoz ○ T6-T7-T8-T9-T10-T15-T20
- 2 erősített laposvágó 100-200 mm
- 1 lakatos kalapács 300 g
- 1 műanyag kalapács Ø 35 mm
- 7 hajlított gömbfejű imbuszkulcs, barnított ○ 2,5-3-4-5-6-8-10 mm
- 1 imbuszkulcs ○ 12 mm
- 31 30 csavarhúzóbetét és mágneses gyorslazítású betéttartó, műanyag dobozban ● ○ ⊕ ⊕ ⊕
- 1 behajtó betéttartó adapter

Beta-sz.	TR
	30
	31
	32
867/C52	
	42
	90
920A	T83
920/21	T83
920/22	T83
920/25	T83
920/42	T83
920/55	T83
900	T91
900ME	T91
900/20	T91
900/21	T91
900/25	T91
900BG/30	T91
900/42	T91
900/55	T91
1082	T156
1150	T156
1048N	T156
1201E	T211
1202E	T213
1207E/TX	T216
35	T234
1370	T234
1390	T234
96BP	T259
96N	T259
860MIX/A31	T259
895/1	T259



T01

T83



T91

T156

T40

T211



T213

T216

T234

T259

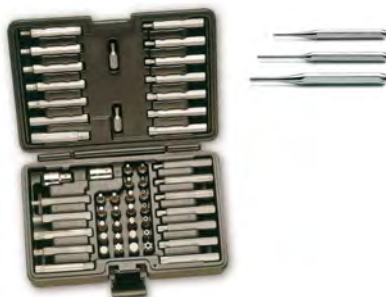

Ft

5904VU/4T

710.400 059241100

A készletet a következő elemekhez ajánljuk: RSC23T - RSC24 - RSC24A - RSC24AXL - RSC24AXLP/7 - RSC24AXXL - RSC24L/7 - RSC24L-CAB - C37 - C39 - C39T - C39SM - C39MD - RSC55 - RSC50 2.0 - C59 - C58BC - C57

► **Univerzális alkalmazás**

Mennyiség/megnevezés

- 16 csillag-villáskulcs 6÷21 mm
- 5 csillag-villáskulcs 22 - 24 - 27 - 30 - 32 mm
- 5 hosszú kiütő Ø 2 - 3 - 4 - 5 - 6 mm
- 1 pontozó Ø 4 mm
- 12 villáskulcs 6x7 - 8x9 - 10x11 - 12x13 - 14x15 - 16x17 - 18x19 - 20x22 - 21x23 - 24x26 - 27x29 - 30x32 mm
- 9 imbuszkulcs Ø 1,5 - 2 - 2,5 - 3 - 4 - 5 - 6 - 8 - 10 mm
- 7 hajlított csillagkulcs 6x7-8x9-10x11-12x13-14x15-16x17-18x19 mm
- 6 T - szárú imbuszkulcs műanyag markolattal Ø 2-2,5-3-4-5-6 mm
- 6 Imbusz csavarhúzókészlet Torx®-csavarokhoz ⚙ T10-T15-T20-T25-T27-T30
- 19 1/2"-os hatlapú dugókulcs Ø 10-11-12-13-14-15-16-17-18-19-20-21-22-23-24-26-27-30-32 mm
- 5 1/2"-os imbusz dugókulcs Ø 5-6-8-10-12 mm
- 1 1/2" Gömbvégű toldó 125 mm
- 1 1/2" Gömbvégű toldó 250 mm
- 1 1/2"-os csukló
- 1 1/2"-os csúszkás T-hajtószár 305 mm
- 1 1/2"-os irányváltós racsnit
- 13 1/4"-os hatlapú dugókulcs Ø 4-4,5-5-5,5-6-7-8-9-10-11-12-13-14 mm
- 6 1/4"-os imbusz-dugókulcs Ø 2,5-3-4-5-6-8 mm
- 1 1/4" - os toldó 50 mm
- 1 1/4" - os toldó 150 mm
- 1 1/4"-os csukló
- 1 1/4"-os hajtószár
- 1 1/4"-os csúszkás T-hajtószár 115 mm
- 1 1/2"-os irányváltós racsnit
- 1 Erősített oldalcsípőfogó 160 mm
- 1 kombinált fogó 180 mm
- 1 Egyenes extra hosszú félkerekcsőrű fogó 160 mm
- 1 egyenes belső Seeger-fogó 180 mm
- 1 hajlított belső Seeger - fogó 170 mm
- 1 egyenes külső Seeger-fogó 175 mm
- 1 hajlított külső Seeger - fogó 175 mm
- 1 vízpumpafogó 250 mm
- 1 Egyenes pófájú önzáró fogó 240 mm
- 7 Csavarhúzó Phillips®-csavarokhoz 2,5x50-3x75-3,5x100-4x125-5,5x100-5,5x150-6,5x150 mm
- 3 Csavarhúzó Phillips®-csavarokhoz 8x150-8x200-10x200 mm
- 2 Csavarhúzó hasítottfejű csavarokhoz, extra rövid penge 4x30-6,5x30 mm
- 6 Csavarhúzó Phillips®-csavarokhoz PH0x60-PH0x100-PH1x80-PH1x120-PH2x100-PH2x150 mm
- 2 Csavarhúzó Phillips®-csavarokhoz PH3x150-PH4x200 mm
- 2 Csavarhúzó Phillips®-csavarokhoz, extra rövid penge PH1x30-PH2x30 mm
- 2 erősített laposvágó 100-200 mm
- 1 lakatos kalapács 300 g
- 1 műanyag kalapács Ø 35 mm
- 1 szögletes egyengető reszelő markolattal 200 mm
- 1 háromszög egyengető reszelő markolattal 200 mm
- 1 lapos egyengető reszelő markolattal 200 mm
- 1 félkerek egyengető reszelő markolattal 200 mm
- 1 kerek egyengető reszelő markolattal 200 mm
- 1 Üres hőformált tálcák

Beta-sz.	TR
42	T05
42	T06
31	T31
32	T31
55	T31
96N/SC9	T31
90	T40
96T	T52
97TTX	T55
920A	T82
920ME	T82
920AN/125	T82
920AN/250	T82
920/25	T82
920/42	T82
920/55	T82
900	T91
900ME	T91
900/20	T91
900/21	T91
900/25	T91
900BG/30	T91
900/42	T91
900/55	T91
1084	T138
1150	T138
1166	T138
1032	T145
1034	T145
1036	T145
1038	T145
1048N	T153
1052	T153
1290	T170
1290	T171
1290N	T171
1292	T172
1292	T173
1292N	T173
35	T234
1370	T234
1390	T234
1719BMA...Q	T236
1719BMA...T	T236
1719BMA...P	T236
1719BMA...M	T236
1719BMA...R	T236
VP4	



T05 T06 T31



T40 T52 T55 T91



T82 T138 T153



T145 T170 T171 T172



T173 T234 T236 VP4

Ft

5908VU/2T 1.049.500 059081136

A készletet a következő elemekhez ajánljuk: RSC23T - 6-7-8 fiókos RSC24 - 6-7-8 fiókos RSC24A - RSC24AXL - RSC24AXLP/7 - RSC24AXLL - RSC24L/7 - RSC24L-CAB - RSC28 - 6-7-8 fiókos C37 - 6-7-8 fiókos C39 - C39MD - C39SM - RSC55 - RSC50 2.0 - C59 - C58BC - C57

5914VU/M

109 darabos szerszámkészlet a C14 húzható szerszámtáskához EVA habszivacs tálcában

► Univerzális alkalmazás

Mennyiség/megnevezés

- 31 30 darab csavarhúzóbetét, mágneses gyorskioldó betéttartóval, tokban ● ○ ⊕ ⊕ ⊕
- 1 behajtó betéttartó adapter
- 13 1/4"-os hatlapú dugókulcs ○ 4-4,5-5-5,6-7-8-9-10-11-12-13-14 mm
- 1 1/4" - os toldó 150 mm
- 1 1/4"-os csukló
- 1 1/4"-os hajtószár
- 1 1/4"-os csúszkás T-hajtószár
- 1 1/2"-os irányváltós racsnit ⊕
- 16 1/2"-os hatlapú dugókulcs ○ 10-11-12-13-14-15-16-17-18-19-21-22-24-27-30-32 mm
- 1 1/2"-os csukló
- 1 1/2" Gömbvégű toldó
- 1 1/2"-os csúszkás T-hajtószár
- 1 1/2"-os irányváltós racsnit ⊕
- 16 csillag-villáskulcs 6-7-8-9-10-11-12-13-14-15-16-17-18-19-21-22 mm
- 9 imbusz kulcs ○ 1,5-2-2,5-3-4-5-6-8-10 mm
- 1 Állítható villáskulcs 250 mm
- 1 műszerész olló 147 mm
- 1 fékes mérőszalag 5 m
- 1 dekorkés 170 mm
- 1 vízpumpafogó 250 mm
- 1 Oldalcsípőfogó 160 mm
- 1 kombinált fogó 180 mm
- 1 Egyenes extra hosszú félkerékcsőrű fogó ● 160 mm
- 3 csavarhúzó hasítottfejű csavarokhoz ● 3,5x100-5,5x125-6,5x150 mm
- 3 Phillips®-csavarhúzó ⊕ PH0x60-PH1x80-PH2x100 mm

Beta-sz.	TR
861MIX/A31	MCT1
895/1	MCT1
900	MCT1
900/...	MCT1
900/25	MCT1
900BG/30C	MCT1
900/42	MCT1
900/55	MCT1
920A	MCT1
920/25	MCT1
920AN/125	MCT1
920/42	MCT1
920/55	MCT1
42	MCT2
96/SC9	MCT2
111E	MCT2
1128BMX	MCT2
1692/5	MCT2
1771	MCT2
1048N	MCT3
1082BM	MCT3
1150BM	MCT3
1166BM	MCT3
1260	MCT3
1262	MCT3



MC T1



MC T2



MC T3

Ft

5914VU/M

512.300 059140112

A készletet a C14 húzható szerszámtáskával együtt ajánljuk
Figyelem: a szerszámtáska felső moduljának megfelelő lezárásához a fedél alatti szerszámtartó panelt ki kell venni.

► Univerzális alkalmazás

Mennyiség/megnevezés

- 22 csillag-villáskulcs 6-7-8-9-10-11-12-13-14-15-16-17-18-19-20-21-22-24-27-30-32-36 mm
- 8 villáskulcs 6x7-8x9-10x11-12x13-14x15-16x17-18x19-20x22 mm
- 9 imbuszkulcs \odot 1,5+10 mm
- 7 Hatszögű csavarhúzóbetétek \odot 4-5-6-7-8-10-12 mm
- 7 Hatszögű csavarhúzóbetétek \odot 4-5-6-7-8-10-12 mm
- 5 Csavarhúzóbetétek XZN®-csavarhoz \odot 5-6-8-10-12 mm
- 5 Csavarhúzóbetétek XZN®-csavarhoz \odot 5-6-8-10-12 mm
- 7 Csavarhúzóbetétek Torx®-csavarhoz \odot T20-T25-T30-T40-T45-T50-T55
- 6 Csavarhúzóbetétek Torx®-csavarhoz \odot T25-T30-T40-T45-T50-T55
- 7 Csavarhúzóbetétek Tamper Resistant Torx®-csavarhoz \odot T20-T25-T30-T40-T45-T50-T55
- 1 Betéttartó a 867-es betétekhez
- 1 Betéttartó a 867-es betétekhez
- 1 behajtó betéttartó adapter
- 1 behajtó betéttartó adapter
- 1 behajtó betéttartó adapter
- 1 behajtó betéttartó adapter
- 13 1/4"-os hatlapú dugókulcs \odot 4-4,5-5-5,5-6-7-8-9-10-11-12-13-14 mm
- 9 \odot 5-6-7-8-9-10-11-12-13 mm
- 5 1/4"-os imbusz-dugókulcs \odot 3-4-5-6-7 mm
- 4 csavarhúzó-dugókulcs hasítottfejú csavarokhoz, krómozott, barnított hegy \bullet 0,8x4-1x5,5-1,2x6,5-1,2x8 mm
- 4 csavarhúzó-dugókulcs Phillips®-csavarokhoz, krómozott, barnított hegy \oplus PH1-PH2-PH3-PH4
- 7 1/4"-os Torx®-imbusz dugókulcs, krómozott, fekete hegyek \odot T10-T15-T20-T25-T27-T30-T40
- 1 1/4" - os toldó 50 mm
- 1 1/4" - os toldó 100 mm
- 1 1/4" - os toldó 150 mm
- 1 1/4"-os csukló
- 1 1/4"-os hajtószár
- 1 1/4"-os csúszkás T-hajtószár
- 1 1/2"-os irányváltós racsnis \oplus
- 21 1/2"-os hatlapú dugókulcs \odot 8-10-11-12-13-14-15-16-17-18-19-20-21-22-23-24-26-27-28-30-32 mm
- 1 szűkítő közbetét 1/2" és 3/8"
- 1 1/2"-os csukló
- 1 1/2" Gömbvégű toldó 125 mm
- 1 1/2" Gömbvégű toldó 250 mm
- 1 1/2"-os csúszkás T-hajtószár
- 1 1/2"-os irányváltós racsnis \oplus
- 8 1/2"-os Torx®-dugókulcs \odot 10-12-14-16-18-20-22-24 mm
- 11 hatlapú dugókulcs \odot 10-12-13-14-15-16-17-18-19-21-22 mm
- 1 Erősített oldalcsípőfogó ∇ 160 mm
- 1 kombinált fogó \equiv 180 mm
- 1 Egyenes extra hosszú félkerekcsőrű fogó \bullet 160 mm
- 6 csavarhúzó hasítottfejú csavarokhoz \bullet 2,5x50-3x75-4x100-5,5x125-6,5x150-8x200 mm
- 1 csavarhúzó hasítottfejú csavarokhoz, extra rövid \bullet 4x30 mm
- 4 csavarhúzó keresztfejú Phillips® csavarokhoz \oplus PH0x60-PH1x80-PH2x100-PH3x150 mm
- 1 csavarhúzó keresztfejú Phillips® csavarokhoz, extra rövid \oplus PH1X30 mm
- 12 imbusz-csavarhúzó Torx®-csavarokhoz \odot T6-T7-T8-T9-T10-T15-T20-T25-T27-T30-T40-T45
- 1 Fáziskereső \bullet
- 2 erősített laposvágó 100-200 mm
- 1 lakatos kalapács 300 g
- 1 műanyag kalapács \varnothing 35 mm

Beta-sz.	TR
42	M01
55	M33
96/SC9	M33
867PE	M86
867PE/L	M86
867XZN	M86
867XZNL	M86
867TX	M86
867TXL	M86
867RTX	M86
867/1	M86
867/2	M86
895/1	M100
895/3	M100
895/6	M100
900	M100
900L	M100
900ME	M100
900LP	M100
900PH	M100
900TX	M100
900/20	M100
900/20L	M100
900/21	M100
900/25	M100
900BG/30	M100
900/42	M100
900/55	M100
920A	M100
920/15	M100
920/25	M100
920AN/125	M100
920AN/250	M100
920/42	M100
920/55	M100
920FTX	M100
920AL	M100
1084BM	M136
1150BM	M136
1166BM	M136
1201E	M213
1201EN	M213
1202E	M213
1202EN	M213
1207E/TX	M213
1253	M213
35	M234
1370	M234
1390	M234



M01



M100

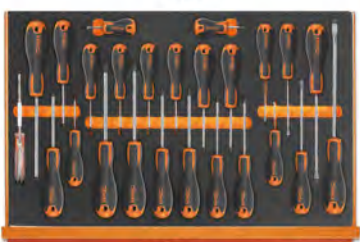

M213



M33 M86 M136 M234

5915VU/0

35 darabos szerszámkészlet

► Univerzális alkalmazás

Mennyiség/megnevezés

- 1 pontozó 4 mm
- 1 erősített laposvágó 125 mm
- 8 villáskulcs 6x7-8x9-10x11-12x13-14x15-16x17-18x19-20x22 mm
- 7 hatlapfejű külső kulcs \odot 1,5-2-2,5-3-4-5-6 mm
- 1 Állítható villáskulcs 150 mm
- 1 vízpumpafogó 250 mm
- 1 oldalcsípőfogó, csúszásmentes kétrétegű PVC bevonatú markolat ipari kivitel ∇ 160 mm
- 1 műszerész olló 147 mm
- 1 robusztus kombinált fogó csúszásmentes kétrétegű PVC bevonatú markolat ipari kivitel \equiv 180 mm
- 1 egyenes extra hosszú félkerekcsőrű fogó, csúszásmentes kétrétegű PVC bevonatú markolat ipari kivitel \bullet 160 mm
- 4 csavarhúzó hasítottfejű csavarokhoz \bullet 3x75-4x100-5,5x100-6,5x150 mm
- 3 csavarhúzó keresztfejű Phillips® csavarokhoz \oplus PH0x60-PH1x80-PH2x100 mm
- 1 lakatos kalapács 300 g
- 1 fékes mérőszalag 3 m
- 1 dekorkés 170 mm
- 1 autós elsősegély készlet
- 1 LED zseblámpa intenzív fényerővel, robusztus eloxált alumíniumból, 500 lumenig

Beta-sz.
32
35
55
96/BGS7
111E
1048N
1082G
1128BMX
1150G
1166G
1201E
1202E
1370
1692/3
1771
1778SOS
1833S



Ft

5915VU/0

188.500 059151021

Készletlétszámi javaslat C5 - C5S - C6T - C9MT

5915VU/1

45 darabos szerszámkészlet

► Univerzális alkalmazás

Mennyiség/megnevezés

- 2 kiütő \varnothing 2-3 mm
- 1 pontozó \varnothing 4 mm
- 2 laposvágó 125-150 mm
- 1 keresztvágó 150 mm
- 14 csillag-villáskulcs 6x14 - 17 - 19 - 21 - 22 - 24 mm
- 9 imbuszkulcs \odot 1,5 - 2 - 2,5 - 3 - 4 - 5 - 6 - 8 - 10 mm
- 1 Állítható villáskulcs 250 mm
- 1 vízpumpafogó 250 mm
- 1 oldalcsípőfogó, csúszásmentes kétrétegű PVC bevonatú markolat ipari kivitel ∇ 160 mm
- 1 műszerész olló 147 mm
- 1 robusztus kombinált fogó csúszásmentes kétrétegű PVC bevonatú markolat ipari kivitel \equiv 180 mm
- 1 egyenes extra hosszú félkerekcsőrű fogó, csúszásmentes kétrétegű PVC bevonatú markolat ipari kivitel \bullet 160 mm
- 4 csavarhúzó hasítottfejű csavarokhoz \bullet 3x75 - 4x100 - 5,5x100 - 6,5x150 mm
- 3 csavarhúzó keresztfejű Phillips® csavarokhoz \oplus PH0x60 - PH1x80 - PH2x100 mm
- 1 lakatos kalapács 300 g
- 1 fékes mérőszalag 5 m
- 1 dekorkés 170 mm

Beta-sz.
30
32
34
36
42
96/SC9
111E
1048N
1082G
1128BMX
1150G
1166G
1201E
1202E
1370
1692
1771



Ft

5915VU/1

229.600 059151024

Készletlétszámi javaslat C8 - C9 - C10 - C10S - C11 - CP15 - CP15L - C16 - CP17 - CP17L - C18



5915VU/2

49 darabos szerszámkészlet

► Univerzális alkalmazás

Mennyiség/megnevezés

- 8 villáskulcs, krómozott 6x7 - 8x9 - 10x11 - 12x13 - 14x15
16x17 - 18x19 - 20x22 mm
- 9 imbuszkulcs \odot 1,5 - 2 - 2,5 - 3 - 4 - 5 - 6 - 8 - 10 mm
- 13 1/4"-os hatlapú dugókulcs \odot 4 - 4,5 - 5 - 5,5 - 6 - 7 - 8 - 9 - 10 - 11 - 12 - 13 - 14 mm
- 1 1/4" - os toldó 150 mm
- 1 1/4"-os csukló
- 1 1/4"-os hajtószár
- 1 1/4"-os csúszkás T-hajtószár
- 1 1/2"-os irányváltós racsnit \oplus
- 1 vízpumpafogó 250 mm
- 1 műszerész olló 147 mm
- 1 robusztus kombinált fogó csúszásmentes kétrétegű PVC bevonatú markolat ipari kivitel \equiv 180 mm
- 4 csavarhúzó hasítottfejú csavarokhoz \bullet 3x75 - 4x100 - 5,5x150 - 6,5x150 mm
- 3 csavarhúzó keresztfejú Phillips® csavarokhoz \oplus PH0x60 - PH1x80 - PH2x100 mm
- 1 lakatos kalapács 300 g
- 1 fékes mérőszalag 3 m
- 1 Letörhető dekorkéspenge, 18 mm széles1771HD
- 1 dekorkés 170 mm

Beta-sz.
55/B8N
96/SC9
900
900/21
900/25
900BG/30
900/42
900/55
1048N
1128BMX
1150G
1201E
1202E
1370
1692
1771RL
1771

Ft

5915VU/2 199.700 059151027

Készletlétszámsítási javaslat C7 - CP15 - C20 - C20L



5915VU/3

74 darabos szerszámkészlet

► Univerzális

Mennyiség/megnevezés

- 1 hosszú kiütő \varnothing 4 mm
- 1 pontozó \varnothing 4 mm
- 1 laposvágó 150 mm
- 14 csillag-villáskulcs 6-7-8-10-11-12-13-14-15-16-17-19-22-24 mm
- 9 imbuszkulcs \odot 1,5+10 mm
- 3 T - szárú imbuszkulcs műanyag markolattal \odot 4 - 5 - 6 mm
- 1 Állítható villáskulcs 250 mm
- 13 1/2"-os hatlapú dugókulcs \odot 8+17 - 19 - 22 - 24 mm
- 1 1/2"-os toldó 125 mm
- 1 1/2"-os toldó 255 mm
- 1 1/2"-os csukló
- 1 1/2"-os csúszkás T-hajtószár
- 1 1/2"-os irányváltós racsnit \oplus
- 8 könnyített hatlapú csőkulcs 6x7 - 8x9 - 10x11 - 12x13 - 14x15 - 16x17 - 18x19 - 20x22 mm
- 2 hajtószár
- 1 Vízpumpafogó, állítható 250 mm
- 1 Egyenes pofájú önzáró fogó 240 mm
- 1 erősített oldalcsipőfogó, csúszásmentes kétrétegű PVC bevonatú markolat ipari kivitel \leq 160 mm
- 1 műszerész olló 147 mm
- 1 robusztus kombinált fogó csúszásmentes kétrétegű PVC bevonatú markolat ipari kivitel \equiv 180 mm
- 1 egyenes extra hosszú félkerekcsőrű fogó, csúszásmentes kétrétegű PVC bevonatú markolat ipari kivitel \bullet 160 mm
- 4 csavarhúzó hasítottfejú csavarokhoz \bullet 3x75 - 4x100 - 5,5x150 - 6,5x150 mm
- 3 csavarhúzó keresztfejú Phillips® csavarokhoz \oplus PH0x60 - PH1x80 - PH2x100 mm
- 1 lakatos kalapács 400 g
- 1 fékes mérőszalag 5 m
- 1 fűrész
- 1 pumpás műanyag olajozó kanna 150 cc
- 1 dekorkés 170 mm

Beta-sz.
31
32
34
42
96/SC9
96T
111E
920A
920/21
920/22
920/25
920/42
920/55
935
940
1048VN
1052
1084G
1128BMX
1150G
1166G
1201E
1202E
1370
1692
1726
1754
1771

Ft

5915VU/3 421.000 059151028

Készletlétszámsítási javaslat C7 - C9 - C10 - C10S - C11 - CP15L - C16 - CP17 - CP17L - C19 - C19L - C20 - C20L



5915VU/4 80 darabos szerszámkészlet

► Univerzális alkalmazás

Mennyiség/megnevezés

- 1 hosszú kiütő Ø 4 mm
- 1 pontozó Ø 4 mm
- 1 laposvágó 150 mm
- 15 csillag-villáskulcs 6-7-8-9-10-11-12-13-14-15-16-17-19-22-24 mm
- 9 imbuszkulcs Ø 1,5+10 mm
- 1 Állítható villáskulcs 250 mm
- 13 1/2"-os hatlapú dugókulcs Ø 8+17 - 19 - 22 - 24 mm
- 1 1/2"-os toldó 255 mm
- 1 1/2"-os csukló
- 1 1/2"-os csúszkás T-hajtósár
- 1 1/2"-os irányváltós racsní Ⓞ
- 17 tizenkétszögű pipakulcs 6+22 mm
- 1 vízpumpafogó 250 mm
- 1 Egyenes pófájú önzáró fogó 240 mm
- 1 erősített oldalcsipőfogó, kétkomponensű markolat ipari kivitel ∇ 160 mm
- 1 műszerész olló 147 mm
- 1 robusztus kombinált fogó kétkomponensű markolat ipari kivitel \equiv 180 mm
- 1 egyenes extra hosszú félkerekcsőrű fogó, kétkomponensű markolat ipari kivitel \bullet 160 mm
- 4 csavarhúzó hasítottfejű csavarokhoz \bullet 3x75 - 4x100 - 5,5x150 - 6,5x150 mm
- 3 csavarhúzó keresztfejű Phillips® csavarokhoz \oplus PH0x60 - PH1x80 - PH2x100 mm
- 1 francia lakatos kalapács 32 mm
- 1 fékes mérőszalag 5 m
- 1 fűrész
- 1 pumpás műanyag olajozó kanna 150 cc
- 1 dekorkés 170 mm

Beta-sz.

- 31
- 32
- 34
- 42
- 96/SC9
- 111E
- 920A
- 920/22
- 920/25
- 920/42
- 920/55
- 932/S17
- 1048N
- 1052
- 1084GBM
- 1128BMX
- 1150GBM
- 1166GBM
- 1201E
- 1202E
- 1370F
- 1692
- 1726
- 1754
- 1771

Ft

5915VU/4 546.700 059151045

Készletársítási javaslat C20 - C20L



5915VU/5 111 darabos szerszámkészlet

► Univerzális

Mennyiség/megnevezés

- 1 hosszú kiütő Ø 4 mm
- 1 pontozó Ø 4 mm
- 1 laposvágó 150 mm
- 17 csillag-villáskulcs 6-7-8-9-10-11-12-13-14-15-16-17-18-19-20-21-22 mm
- 8 villáskulcs 6x7-8x9-10x11-12x13-14x15-16x17-18x19-20x22 mm
- 9 Hajlított gömbfejű imbuszkulcs Ø 1,5-2-2,5-3-4-5-6-8-10 mm
- 1 Állítható villáskulcs 250 mm
- 39 11 hatlapú dugókulcs, 20 csavarhúzóbetét és 8 betéttartó
- 13 11 dugókulcs és 2 tartozék fémdobozban
- 1 vízpumpafogó 250 mm
- 1 Egyenes pófájú önzáró fogó 240 mm
- 1 oldalcsipőfogó, csúszásmentes kétrétegű PVC bevonatú markolat ipari kivitel ∇ 160 mm
- 1 Rabitz-fogó, lakkozott 220 mm
- 1 műszerész olló 147 mm
- 1 robusztus kombinált fogó csúszásmentes kétrétegű PVC bevonatú markolat ipari kivitel \equiv 180 mm
- 1 egyenes extra hosszú félkerekcsőrű fogó, csúszásmentes kétrétegű PVC bevonatú markolat ipari kivitel \bullet 160 mm
- 4 csavarhúzó hasítottfejű csavarokhoz \bullet 3x75 - 4x100 - 5,5x100 - 6,5x150 mm
- 3 csavarhúzó keresztfejű Phillips® csavarokhoz \oplus PH0x60 - PH1x80 - PH2x100 mm
- 1 lakatos kalapács 300 g
- 1 műanyag kalapács Ø 35 mm
- 1 fékes mérőszalag 3 m
- 1 reszelő
- 1 fűrész 440 mm
- 1 dekorkés 170 mm
- 1 LED lámpa, robusztus eloxált alumíniumból

Beta-sz.

- 31
- 32
- 34
- 42
- 55/S8
- 96BPC/SC9
- 111E
- 900/C11
- 920A/C11
- 1048N
- 1052
- 1082G
- 1098
- 1128BMX
- 1150G
- 1166G
- 1201E
- 1202E
- 1370
- 1390
- 1692/3
- 1719BMA8/M
- 1726
- 1771BM
- 1833XS/2

Ft

5915VU/5 536.600 059151046

Készletársítási javaslat C12 - C41S - C41H - C42S - C42H



5915VU/AS 68 darabos szerszámkészlet

► Univerzális

Mennyiség/megnevezés

- 1 hosszú kiütő Ø 4 mm
- 1 pontozó Ø 4 mm
- 1 laposvágó 150 mm
- 13 csillag-villáskulcs 1/4 - 5/16 - 3/8 - 7/16 - 1/2 - 9/16 - 5/8 - 11/16 - 3/4 - 13/16 - 7/8 - 15/16 - 1"
- 8 hajlított csillagkulcs 1/4"±1"
- 9 Ø 3/64"-3/8"
- 1 Állítható villáskulcs 250 mm
- 11 1/2" - os tizenkétszögű dugókulcs Ø 3/8 - 7/16 - 1/2 - 9/16 - 5/8 - 11/16 - 3/4 - 13/16 - 7/8 - 15/16 - 1"
- 1 1/2"-os toldó 125 mm
- 1 1/2"-os toldó 255 mm
- 1 1/2"-os csukló
- 1 1/2"-os csúszkás T-hajtószer
- 1 1/2"-os irányváltós racsnit
- 1 vízpumpafogó 250 mm
- 1 Egyenes pótfájú önzáró fogó 240 mm
- 1 erősített oldalcsípőfogó, kétkomponensű markolat ipari kivitel 160 mm
- 1 műszerész olló 147 mm
- 1 robusztus kombinált fogó kétkomponensű markolat ipari kivitel 180 mm
- 1 egyenes extra hosszú félkerekcsőrű fogó, kétkomponensű markolat ipari kivitel 160 mm
- 4 csavarhúzó hasítottfejű csavarokhoz ● 3x75 - 4x100 - 5,5x150 - 6,5x150 mm
- 3 csavarhúzó keresztfejű Phillips® csavarokhoz ⊕ PH0x60 - PH1x80 - PH2x100 mm
- 1 lakatos kalapács 300 g
- 1 fékes mérőszalag 5 m
- 1 fűrész
- 1 pumpás műanyag olajozó kanna 150 cc
- 1 dekorkés 170 mm

Beta-sz.

- 31
- 32
- 34
- 42AS
- 90AS/8
- 96AS/SC9
- 111E
- 920AS
- 920/21
- 920/22
- 920/25
- 920/42
- 920/55
- 1048N
- 1052
- 1084GBM
- 1128BMX
- 1150GBM
- 1166GBM
- 1201E
- 1202E
- 1370
- 1692
- 1726
- 1754
- 1771

Ft

5915VU/AS 463.100 059151032

Készletársítási javaslat C10 - C20 - C20L



MC10



MC20

5927VU/M 108 darabos szerszámkészlet habszivacs tálcában

► Univerzális alkalmazás

Mennyiség/megnevezés

- 16 csillag-villáskulcs 6-7-8-9-10-11-12-13-14-15-16-17-18-19-21-22 mm
- 1 Erősített oldalcsípőfogó 160 mm
- 9 imbuszkulcs Ø 1,5-2-2,5-3-4-5-6-8-10 mm
- 1 kombinált fogó 180 mm
- 1 Egyenes extra hosszú félkerekcsőrű fogó 160 mm
- 3 csavarhúzó hasítottfejű csavarokhoz ● 3,5x100-5,5x150-6,5x150 mm
- 3 csavarhúzó keresztfejű Phillips® csavarokhoz ⊕ PH0x3x60-PH1x4,5x80-PH2x6x100 mm
- 31 30 darab csavarhúzóbetét, mágneses gyorskioldó betéttartóval, tokban ● ○ ⊕ ⊕ ⊕ ⊕
- 1 vízpumpafogó 250 mm
- 1 lakatos kalapács 300 mm
- 1 pontozó 4 mm
- 1 keresztvágó 4 mm
- 13 1/4"-os hatlapú dugókulcs Ø 4-4,5-5-5,5-6-7-8-9-10-11-12-13-14 mm
- 1 1/4" - os toldó 150 mm
- 1 1/4"-os csukló
- 1 1/4"-os hajtószer
- 1 1/4"-os csúszkás T-hajtószer
- 1 1/2"-os irányváltós racsnit
- 16 1/2"-os hatlapú dugókulcs Ø 10-11-12-13-14-15-16-17-18-19-21-22-24-27-30-32 mm
- 1 1/2"-os csukló
- 1 1/2" Gömbvégű toldó 125 mm
- 1 1/4"-os csúszkás T-hajtószer
- 1 1/2"-os irányváltós racsnit
- 1 behajtó betéttartó adapter

Beta-sz. TR

- 42 MC10
- 1084BM MC10
- 96/SC9 MC10
- 1150BM MC10
- 1166BM MC10
- 1201E MC10
- 1202E MC10
- 861MX/A31 MC20
- 1048N MC20
- 1370 MC20
- 32 MC20
- 36 MC20
- 900 MC20
- 900/21 MC20
- 900/25 MC20
- 900BG/30C MC20
- 900/42 MC20
- 900/55 MC20
- 920A MC20
- 920/25 MC20
- 920AN/125 MC20
- 900/42 MC20
- 920/55 MC20
- 895/1 MC20

Ft

5927VU/M 457.900 059271021

Készletársítási javaslat RSC22 - C27S - RSC23 - RSC23C



5957U-P

133 darabos szerszámkészlet

► Ipari karbantartás

Mennyiség/megnevezés

Mennyiség/megnevezés	Beta-sz.
6 Hosszú kiütő 2 ÷ 8 mm	31/SP6
6 2 kiütő, 1 pontozó, 3 hidegvágó	38/SP6
17 csillag-villáskulcsok 6÷22 - 24 - 27 - 30 mm	42/S17X
12 villáskulcs 6x7 ÷ 30x32 mm	55/S12X
8 T - szárú imbuszkulcs műanyag markolattal 2 ÷ 10 mm	96T/S8
8 részes hajlított Torx® imbuszkulcs szerszám készlet T9 ÷ T40	97TX/SC8
1 Állítható villáskulcs 250 mm	111E
13 1/2" - os hatlapú dugókulcs Ø 10 ÷ 22 mm	920A/SB13
8 1/2" - os hatlapú dugókulcs Ø 23 ÷ 32 mm	920A/SB8
7 csavarhúzó-dugókulcs készlet Phillips®-csavarokhoz krómozott, barnított fej 1, 2, 3, 4, 5, 6, 7, 8, 9, 10, 11, 12, 13, 14, 15, 16, 17, 18, 19, 20, 21, 22, 23, 24, 25, 26, 27, 28, 29, 30, 31, 32, 33, 34, 35, 36, 37, 38, 39, 40, 41, 42, 43, 44, 45, 46, 47, 48, 49, 50, 51, 52, 53, 54, 55, 56, 57, 58, 59, 60, 61, 62, 63, 64, 65, 66, 67, 68, 69, 70, 71, 72, 73, 74, 75, 76, 77, 78, 79, 80, 81, 82, 83, 84, 85, 86, 87, 88, 89, 90, 91, 92, 93, 94, 95, 96, 97, 98, 99, 100, 101, 102, 103, 104, 105, 106, 107, 108, 109, 110, 111, 112, 113, 114, 115, 116, 117, 118, 119, 120, 121, 122, 123, 124, 125, 126, 127, 128, 129, 130, 131, 132, 133	920LH/SB7
1 egyenes belső Seeger-fogó Ø 180 mm	1032
1 hajlított belső Seeger - fogó Ø 170 mm	1034
1 egyenes külső Seeger-fogó Ø 175 mm	1036
1 hajlított külső Seeger - fogó Ø 175 mm	1038
1 vízpumpafogó 240 mm	1048N
1 Egyenes pofájú önzáró fogó 240 mm	1052
1 bádogos lemezolló 250 mm	1112
1 műszerész olló 147 mm	1128BMX
8 csavarhúzókészlet 2,5x50 - 3x75 - 4x100 - 5,5x125 - 6,5x150 - PH0 - PH1 - PH2	1263/D8
2 lakatos kalapács 300 - 600 g	1370
1 műanyag kalapács Ø 35 mm	1390
1 fékes mérőszalag 5 m	1692/5
1 flexibilis mágneses csavarkiszedő	1712E/2
1 kétélű hántoló 150 mm	1717A
1 háromélű hántoló 200 mm	1717B
5 reszelő 200 mm	1719BMA8/S5
1 Olajozó fémkanna 200 cc	1751N
1 dekorkés 170 mm	1771BM
1 1/2"-os toldó 125 mm	920/21
1 1/2"-os toldó 250 mm	920/22
1 1/2"-os csukló	920/25
1 1/2"-os csúszkás T-hajtószerű	920/42
1 1/2"-os irányváltós racsnival	920/55
1 egyenes feszítővas	963
1 Oldalsípőfogó 160 mm	1082BM
1 Erősített oldalsípőfogó 160 mm	1084BM
1 áttételes homlokcsípőfogó 180 mm	1092V
1 kombinált fogó 180 mm	1150BM
1 Egyenes extra hosszú félkerescsőrű fogó 160 mm	1166BM
1 Hajlított extra hosszú félkerescsőrű fogó 160 mm	1168BM
2 csavarhúzó hasítottfejű csavarokhoz 8x200 - 10x200 mm	1260
1 Phillips®-csavarhúzó PH3 8x150mm	1262
1 tolómérő	1650
1 fűrész 420 mm	1725

Ft

5957U-P

1.180.300 059571004

Készletársítási javaslat C57SA - C57SB - C57SP - C55PS - C55PSE - RSC55 - RSC50 2.0 I - RSC50 2.0 L



5958U

85 darabos szerszámkészlet

► **Univerzális alkalmazás**

Mennyiség/megnevezés

- 17 csillag-villáskulcs 6÷22 mm
- 12 imbuszkulcs 2÷10 mm
- 13 1/2" - os hatlapú dugókulcs 10÷22 mm
- 8 1/2" - os hatlapú dugókulcs 23÷32 mm
- 1 1/2"-os toldó 125 mm
- 1 1/2"-os toldó 255 mm
- 1 1/2"-os csukló
- 1 1/2"-os csúszkás T-hajtószár
- 1 1/2"-os irányváltós racsnit
- 1 egyenes belső Seeger-fogó 180 mm
- 1 egyenes külső Seeger-fogó 175 mm
- 1 vízpumpa fogó 250 mm
- 1 Egyenes pofájú önzáró fogó 240 mm
- 1 Erősített oldalcsipőfogó 160 mm
- 1 műszerész olló 147 mm
- 1 kombinált fogó 180 mm
- 1 Egyenes extra hosszúsú félkerékcsőrű fogó 160 mm
- 7 csavarhúzó hasítottfejű csavarokhoz 3x75 - 3,5x100 - 4x125 - 5,5x150 - 6,5x150 - 8x200 - 10x200 mm
- 4 Csavarhúzó Phillips®-csavarokhoz PH0x60 - PH1x80 - PH2x100 - PH3x150 mm
- 1 lakatos kalapács 300 g
- 1 műanyag kalapács Ø 35 mm
- 1 fékes mérőszalag 5 m
- 5 5 darabos egyengető reszelő készlet markolattal 200 mm
- 1 fűrész
- 1 pumpás műanyag olajozó kanna 150 cc
- 1 dekorkés 170 mm

Beta-sz.

- 42
- 96N/SC12
- 920A/SB13
- 920A/SB8
- 920/21
- 920/22
- 920/25
- 920/42
- 920/55
- 1032
- 1036
- 1048N
- 1052
- 1084BM
- 1128BMX
- 1150BM
- 1166BM
- 1260
- 1262/S4
- 1370
- 1390
- 1692
- 1719BMA...S5
- 1725
- 1754
- 1771

Ft



5958U

596.900 059581008

Készletlétvételek javaslat C58P - C45PRO 2.0 - RSC55 - RSC50 2.0 E - RSC50 2.0 F - RSC50 2.0 G - RSC50 2.0 H - RSC50 2.0 I - RSC50 2.0 L

5980U/BIKE

kioldó nyomatékulkcs kétirányú racsnival jobb és bal oldali meghúzáshoz, pontosság $\pm 6\%$ 2÷10 Nm

► Kerékpárjavítás

Mennyiség/megnevezés

Beta-sz.

5	csillag-villáskulcs 8-9-10-13-14 mm	42
9	hajlítót gömbfejű imbuszkulcs, barnított \odot 1,5-2-2,5-3-4-5-6-8-10 mm	96BP/SC9
8	T - szárú imbuszkulcs műanyag markolattal 2-2,5-3-4-5-6-8-10 mm	96T/S8
8	Imbusz csavarhúzókészlet Torx®-csavarokhoz \odot T8-T10-T15-T20-T25-T27-T30-T40	97TTX/S8
1	Széles nyílású állítható villáskulcs, krómozott, rövid sorozat 170 mm	111CM
1	Csővágó réz és könnyűfém csövekhez	334
1	kioldó nyomatékulkcs kétirányú racsnival jobb és bal oldali meghúzáshoz meghúzási pontosság $\pm 6\%$ 2÷10 Nm	605E
13	\odot 4-4,5-5-5,5-6-7-8-9-10-11-12-13-14 mm	900/SB13
1	1/4" - os toldó	900/21
1	1/4"-os csukló	900/25
1	1/2"-os irányváltós racsnit \oplus	900/55
1	oldalcsípőfogó, csúszásmentes kétrétegű PVC bevonatú markolat ipari kivitel \llcorner 160 mm	1082G
1	Egyenes élű műszerész olló 145 mm	1128BM
1	robustus kombinált fogó csúszásmentes kétrétegű PVC bevonatú markolat ipari kivitel \llcorner 180 mm	1150G
1	egyenes extra hosszú félkerékcsőrű fogó, csúszásmentes kétrétegű PVC bevonatú markolat ipari kivitel \bullet 180 mm	1166G
7	3x75-4x125-5,5x150-6,5x150-PH0x60-PH1x80-PH2x100 mm	1203E/D
1	lakatos kalapács 300 g	1370
1	műanyag kalapács \varnothing 35 mm	1390
1	tolómérő 150 mm	1650
1	fékes mérőszalag 3 m	1692/3
1	lapos egyengető reszelő markolattal 200 mm	1719BMA...P
1	félkerék egyengető reszelő markolattal 200 mm	1719BMA...M
1	kerék egyengető reszelő markolattal 200 mm	1719BMA...R
1	fűrész 300 mm	1725
1	dekorkés 170 mm	1771
1	lánckopás jelző 120 mm	3935
1	patentszem fogó 170 mm	3937
7	7 darabos egyszerű kúpos kulcs készlet 13-14-15-16-17-18-19 mm	3952/S7
1	pedálkulcs 15 mm	3953
1	fekete küllőhúzó kulcs 3,2 mm \square	3961 3,2
1	zöld küllőhúzó kulcs 3,3 mm \square	3961 3,3
1	piros küllőhúzó kulcs 3,5 mm \square 3	3961 3,5
1	professzionális küllőhúzó kulcs 3,2 - 4,0 mm \square 3,2 - 4,0 mm	3961U
1	fogaskerék leszedő láncos kulcs 289 mm	3967
1	gumiszerelő vas 200 mm	3969
3	3db gumiszerelő, műanyag 113 mm	3969K3
1	tárcsafék betét hátrahúzó kar 222 mm	3991
1	kulcs féktárcsa egyenesbe állításához 234 mm	3992



Ft



5980U/BIKE

701.600 059801040

A C16 - CP17 - CP17L - C20L szerszámkocsikhoz ajánlott készlet



M05 M50 M55



M137 M234 M236 M294

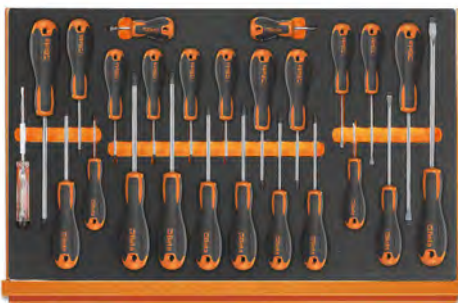

M213



M400



M401

5980U/BIKE-M

106 darabos szerszámkészlet kerékpárjavításhoz és karbantartáshoz



Mennyiség/megnevezés

- 16 csillag-villáskulcsok 6-7-8-9-10-11-12-13-14-15-16-17-18-19-20-21 mm
- 8 T - szárú imbusz kulcs műanyag markolattal 2-2,5-3-4-5-6-7-8 mm
- 5 Imbusz csavarhúzó készlet Torx®-csavarokhoz TX10-TX15-TX20-TX25-TX30
- 1 Erősített oldalcsípőfogó 160 mm
- 1 Kombinált fogó 160 mm
- 1 Egyenes extra hosszú félkerécsőrű fogó 160 mm
- 6 csavarhúzó hasítottfejtű csavarokhoz 2,5x50-3x75-4x100-5,5x125-6,5x150-8x200 mm
- 1 csavarhúzó hasítottfejtű csavarokhoz, extra rövid 4x30 mm
- 4 csavarhúzó keresztfejtű Phillips® csavarokhoz PH0x60-PH1x80-PH2x100-PH3x150 mm
- 1 csavarhúzó keresztfejtű Phillips® csavarokhoz, extra rövid 4,5x30 mm
- 12 imbusz-csavarhúzó Torx®-csavarokhoz TX6-TX7-TX8-TX9-TX10-TX15-TX20-T25-TX27-TX30-TX40-TX45
- 1 Fáziskereső
- 1 lakatos kalapács 300 g
- 1 műanyag kalapács Ø 35 mm
- 2 erősített laposvágó 100-200 mm
- 1 5 darabos egyengető reszelő készlet markolattal 200 mm
- 1 fékes mérőszalag 5 m
- 1 Mini fűrés 250 mm
- 1 dekorkés 170 mm
- 1 Letörhető dekorkéspenge, 18 mm széles 1771HD
- 1 professzionális láncbontó készülék 5-11V sebességű láncokkal kompatibilis
- 1 lánckopás jelző
- 1 patentszem fogó
- 7 egyszerű kúpos kulcs 13-14-15-16-17-18-19 mm
- 1 fekete küllőhúzó kulcs 3,2 mm □ 3,2 mm
- 1 zöld küllőhúzó kulcs 3,3 mm □ 3,3 mm
- 1 piros küllőhúzó kulcs 3,5 mm □ 3,5 mm
- 1 professzionális küllőhúzó kulcs 3,2 - 4,0 mm □ 3,2-4,0 mm
- 1 gumiszerező vas
- 1 3db gumiszerező, műanyag
- 1 lehúzó dugókulcs 16 bordás hajtóműhöz 39 mm
- 1 lehúzó dugókulcs 16 bordás hajtóműhöz 41 mm
- 1 lehúzó dugókulcs 16 bordás hajtóműhöz 46 mm
- 1 lehúzó dugókulcs 20 bordás hajtóműhöz nikkelezett központi csappal 31,5 mm
- 1 4 körmös BMX szabadonfutó lehúzó kulcs 35 mm
- 1 Shimano szabadonfutó lehúzó kulcs 22,8 mm
- 1 kazettás vezetőcsapos Shimano szabadonfutó lehúzó kulcs 23,5 mm
- 1 vezetőcsapos Campagnolo szabadonfutó lehúzó kulcs 23 mm
- 1 tárcsafék betét hátrahúzó kar
- 1 kulcs féktárcsa egyenesbe állításához
- 1 a láncvilla-sebességváltó láncvonalat beállító szerszám
- 1 hajtókar lehúzó
- 1 pedálkulcs
- 2 univerzális kormány sorozat villáskulcs 30x32-32x36 mm
- 1 fogaskerék leszedő láncos kulcs
- 1 Shimano műanyag csavar kulcs

Beta-sz.	TR
42	M05
96T	M50
97TTX	M55
1084	M137
1150	M137
1166	M137
1201E	M213
1201EN	M213
1202E	M213
1202EN	M213
1207E/TX	M213
1253	M213
1370	M234
1390	M234
35	M234
1719BMA...S5	M236
1692	M294
1725CR	M294
1771	M294
1771RL	M294
3932U	M400
3935	M400
3937	M400
3952	M400
3961 3,2	M400
3961 3,3	M400
3961 3,5	M400
3961U	M400
3969	M400
3969K3	M400
3973/1	M400
3973/2	M400
3973/3	M400
3973/4	M400
3984/1	M400
3984/2	M400
3984/3	M400
3984/4	M400
3991	M400
3992	M400
3921	M401
3948	M401
3953	M401
3955	M401
3967	M401
3971	M401

Ft

5980U/BIKE-M 924.000 059801050

5988H/7M

333 darabos szerszámkészlet habszivacs tálcában

Autójavító

Mennyiség/megnevezés



M125



M25



M105



M166



M231



M62



M78

- 13 Hatlapú dugókulcs, hosszított kivitel ○ 8-9-10-11-12-13-14-15-16-17-19-21-22 mm
- 16 hatlapú dugókulcs ○ 10-12-13-14-15-16-17-18-19-21-22-23-24-27-30-32 mm
- 7 1/2"-os Torx®-dugókulcs ○ E12-E14-E16-E18-E20-E22-E24
- 10 1/2"-os színes hátszögű csavarhúzóbetét ○ 5-6-6L-7-8-8L-10-10L-12-12L mm
- 13 1/2"-os Torx®-imbusz-dugókulcs ○ T20-T25-T27-T30-T30L-T40-T40L-T45-T50-T50L-T55-T60-T60L
- 8 1/2"-os XZN®-profilú imbusz-dugókulcs, krómzott, barnított fej ○ 5-6-6L-8-8L-10-10L-12L mm
- 18 csillag-villáskulcs 6-7-8-9-10-11-12-13-14-15-16-17-18-19-21-22-24-27 mm
- 7 hajlított csillagkulcs 6x7-8x9-10x11-12x13-14x15-16x17-18x19 mm
- 1 Adapter gyorscsatlakozóval 1/4" 10 mm-es racsnikulcshoz
- 1 Adapter gyorscsatlakozóval 3/8" 13 mm-es racsnikulcshoz
- 1 Adapter gyorscsatlakozóval 1/2" 19 mm-es racsnikulcshoz
- 12 Csillag-villáskulcs irányváltós racsnival 8-9-10-11-12-13-14-15-16-17-18-19 mm
- 9 Hajlított gömbfejű imbuszkulcs ○ 1,5-2-2,5-3-4-5-6-8-10 mm
- 1 behajtó betéttartó adapter ○ 1/4-□1/4
- 1 behajtó betéttartó adapter ○ 1/4-□3/8
- 1 behajtó betéttartó adapter ○ 5/16-□1/2
- 13 1/4"-os hatlapú dugókulcs ○ 4-4,5-5-5,5-6-7-8-9-10-11-12-13-14 mm
- 9 ○ 5-6-7-8-9-10-11-12-13 mm
- 4 csavarhúzó-dugókulcs hasítottfejű csavarokhoz, krómzott, barnított hegy ● 0,8x4-1x5,5-1,2x6,5-1,2x8 mm
- 5 1/4"-os imbusz-dugókulcs ○ 3-4-5-6-7 mm
- 4 csavarhúzó-dugókulcs Phillips®-csavarokhoz, krómzott, barnított hegy ● PH1-PH2-PH3-PH4
- 7 1/4"-os Torx®-imbusz-dugókulcs, krómzott, fekete hegyek ○ T10-T15-T20-T25-T27-T30-T40
- 1 Bővítő közbetét 1/4" - 3/8" □1/4-■3/8
- 3 1/4" - os toldó 50-100-150 mm
- 1 1/4"-os csukló
- 1 1/4"-os csúszkás T-hajtószer
- 1 1/2"-os irányváltós racsnival ⊕
- 1 1/4"-os hajtószer
- 17 Hatlapú dugókulcs 3/8" ○ 6-7-8-9-10-11-12-13-14-15-16-17-18-19-20-21-22 mm
- 1 Szűkítő közbetét 3/8" és 1/4" □3/8-■1/4
- 1 Szűkítő közbetét, belső 1/2", külső 3/8" □3/8-■1/2
- 1 Toldó - 3/8" 125 mm
- 1 Toldó - 3/8" 250 mm
- 1 Csukló 3/8"
- 1 Csúszkás T - hajtószer 3/8"
- 3/8" irányváltós racsnival ⊕
- 21 1/2"-os hatlapú dugókulcs ○ 8-10-11-12-13-4-15-16-17-18-19-20-21-22-23-24-26-27-28-30-32 mm
- 2 1/2" Gömbvégű toldó 125-250 mm
- 1 szűkítő közbetét 1/2" és 3/8" □1/2-■3/8
- 1 1/2"-os csukló
- 1 1/2"-os csúszkás T-hajtószer
- 1 1/2"-os irányváltós racsnival ⊕
- 3 3/8" - os gyertya - dugókulcs ○ 16-17-8-20,8 mm
- 31 30 darab csavarhúzóbetét, mágneses gyorskioldó betéttartóval, tokban ○ ⊕ ⊕ ⊕ ⊕
- 1 vízpumpafogó 250 mm
- 1 Oldalsípófogó ⊚ 160 mm
- 1 kombinált fogó ⊚ 180 mm
- 1 Extra hosszú laposfogó ⊚ 160 mm
- 5 Csavarhúzó Phillips®-csavarokhoz ● 3x75-4x100-5,5x100-6,5x150-8x150 mm
- 1 Csavarhúzó hasítottfejű csavarokhoz, extra rövid penge ● 6,5x30 mm
- 3 Csavarhúzó Phillips®-csavarokhoz ⊕ PH1-PH2-PH3
- 1 Csavarhúzó Phillips®-csavarokhoz, extra rövid penge ⊕ PH2
- 4 Imbusz csavarhúzókészlet Torx®-csavarokhoz ○ T20-T25-T27-T30
- 6 hosszú kiütő 2-3-4-5-6-8 mm
- 1 pontozó 4 mm
- 3 laposvágó 125-150-75 mm
- 1 keresztvágó 125 mm
- 2 lakatos kalapács 500-1000 g
- 1 flexibilis teleszkópos mágneses csavarkiszedő
- 1 műanyag kalapács Ø 35 mm
- 1 fékes mérőszalag 5 m
- 1 egyenes belső Seeger-fogó ○ 180 mm
- 1 hajlított belső Seeger - fogó ○ 170 mm
- 1 egyenes külső Seeger-fogó ● 175 mm
- 1 hajlított külső Seeger - fogó ● 175 mm
- 1 Behajtható pengéjű kábelblankoló kés ● 140 mm
- 1 elektronikai oldalsípófogó ⊚ 125 mm
- 4 csavarhúzó ● 2,0-2,5-3,0-3,5 mm
- 2 Phillips® műszerész csavarhúzó ⊕ 0-00
- 9 Imbusz csavarhúzókészlet Torx®-csavarokhoz ○ T10-T15-T20-T25-T27-T30-T40-T45-T50
- 1 Egyenes pófajú önzáró fogó 240 mm
- 1 állítható hosszúcsórú önzárófogó 175 mm
- 1 Tömlezáró fogó
- 1 Tömlezáró fogó
- 1 Tömlezáró fogó
- 1 tolmérő
- 1 Hézagmérő
- 1 Hántoló tömítéshez
- 7 Kettős csuklós dugókulcs 6x7-8x9-10x11-12x13-14x15-16x17-18x19 mm
- 1 1/2"-os csuklós hajtószer, krómzott
- 1 szerelővas 450 mm
- 1 teleszkópos vizsgáló tűkőr 670 mm
- 1 reszelő 200 mm
- 1 reszelő 200 mm
- 1 reszelő 200 mm
- 1 reszelő 200 mm
- 1 reszelő 200 mm
- 1 Acél drótkefe

Beta-sz.	TR
910AL	M125
920AL	M125
920FTX	M125
920PE	M125
920TX	M125
920XZN	M125
42	M25
90	M25
123Q1/4	M25
123Q3/8	M25
123Q1/2	M25
142	M25
96BPC/SC9	M105
895/1	M105
895/3	M105
895/6	M105
900	M105
900L	M105
900LP	M105
900ME	M105
900PH	M105
900TX	M105
900X16	M105
900/...	M105
900/25	M105
900/42	M105
900/55	M105
900BG/30	M105
910A	M105
910/15	M105
910/16	M105
910/21	M105
910/22	M105
910/25	M105
910/42	M105
910/55	M105
920A	M105
920AN	M105
920/15	M105
920/25	M105
920/42	M105
920/55	M105
956E	M105
861MIX/A31	M166
1048N	M166
1082BM	M166
1150BM	M166
1162BM	M166
1290	M166
1290N	M166
1292	M166
1292N	M166
1297TX	M166
31	M231
32	M231
34	M231
36	M231
1370	M231
1712TF	M231
1390	M231
1692	M125
1032	M62
1034	M62
1036	M62
1038	M62
1177BM	M62
1188BM	M62
1257LP	M62
1257PH	M62
977TX	M62
1052	M78
1058	M78
1481PL/A	M78
1481PL/B	M78
1481PL/C	M78
1650	M78
1708/20	M78
1716P	M78
80	M78
920/36A	M78
965	M78
1715	M231
1719BMA8/M	M231
1719BMA8/P	M231
1719BMA8/Q	M231
1719BMA8/R	M231
1719BMA8/T	M231
1737NX	M231

Ft

5988H/7M 2.403.000 059881087

RSC24/8 - RSC24A/8 - RSC24A-XL 8-9 fiókkal - RSC24AXL - RSC28 C37/8 - C39/8 - C59B - C55C8 - C55M8 - RSC55 - RSC50 2.0 - C58BC szerszámkocsikhoz ajánlott készlet

► **Autójavító**

Mennyiség/megnevezés

- 13 1/4"-os hatlapú dugókulcs ○ 4-4,5-5-5,5-6-7-8-9-10-11-12-13-14 mm
- 9 ○ 5-6-7-8-9-10-11-12-13 mm
- 9 Hajlítót gömbfejű imbuszkulcs ○ 1,5-2-2,5-3-4-5-6-8-10 mm
- 1 behajtó betéttartó adapter
- 1 behajtó betéttartó adapter
- 1 behajtó betéttartó adapter
- 5 1/4"-os imbusz-dugókulcs ○ 3-4-5-6-7 mm
- 4 csavarhúzó-dugókulcs hasítottfejű csavarokhoz, krómozott, barnított hegy ● 0,8x4-1x5,5-1,2x6,5-2x8 mm
- 4 csavarhúzó-dugókulcs Phillips®-csavarokhoz, krómozott, barnított hegy ● PH1-PH2-PH3-PH4
- 7 1/4"-os Torx®-imbusz dugókulcs, krómozott, fekete hegyek ● T10-T15-T20-T25-T27-T30-T40
- 1 Bővítő közbetét 1/4" - 3/8" □ 1/4 - ■ 3/8
- 3 1/4" - os toldó 50-100-150 mm
- 1 1/4"-os csukló
- 1 1/4"-os hajtószár
- 1 1/4"-os csúszkás T-hajtószár
- 1 1/2"-os irányváltós racsnit ⚙️
- 17 Hatlapú dugókulcs 3/8" ○ 6-7-8-9-10-11-12-13-14-15-16-17-18-19-20-21-22 mm
- 1 Szűkítő közbetét 3/8" és 1/4" □ 3/8 - ■ 1/4
- 1 Szűkítő közbetét, belső 1/2", külső 3/8" □ 3/8 - ■ 1/2
- 1 Toldó - 3/8" 125 mm
- 1 Toldó - 3/8" 250 mm
- 1 Csukló 3/8"
- 1 Csúszkás T - hajtószár 3/8"
- 1 3/8" irányváltós racsnit ⚙️
- 17 1/2"-os hatlapú dugókulcs ○ 8-10-11-12-13-14-15-16-17-18-19-20-21-22-23-24-26-27-28-30-32 mm
- 1 szűkítő közbetét 1/2" és 3/8" □ 1/2 - ■ 3/8
- 1 Csukló 3/8"
- 2 1/2" Gömbvégű toldó 125 - 250 mm
- 1 1/2"-os csúszkás T-hajtószár
- 1 1/2"-os irányváltós racsnit ⚙️
- 3 3/8" - os gyertya - dugókulcs ○ 16-17,8-20,8 mm
- 13 Hatlapú dugókulcs, hosszított kivitel ○ 8-9-10-11-12-13-14-15-16-17-19-21-22 mm
- 10 1/2"-os színes hatszögű csavarhúzóbetét ○ 5-6-6L-7-8-8L-10-10L-12-12L mm
- 7 1/2"-os Torx®-dugókulcs ○ E12-E14-E16-E18-E20-E22-E24
- 13 1/2"-os Torx®-imbusz-dugókulcs ○ T20-T25-T27-T30-T30L-T40-T40L
- 8 1/2"-os XZN®-profilú imbusz-dugókulcs, krómozott, barnított fej ○ 5-6-6L-8-8L-10-10L-12L mm
- 16 hatlapú dugókulcs ○ 10-12-13-14-15-16-17-18-19-21-22-23-24-27-30-32 mm
- 1 fékes mérőszalag 5 m
- 18 csillag-villáskulcs 6-7-8-9-10-11-12-13-14-15-16-17-18-19-21-22-24-27 mm
- 7 hajlítót csillagkulcs 6x7-8x9-10x11-12x13-14x15-16x17-18x19 mm
- 1 Adapter gyorscsatlakozóval 1/4" 10 mm-es racsnikulcshoz
- 1 Adapter gyorscsatlakozóval 3/8" 13 mm-es racsnikulcshoz
- 1 Adapter gyorscsatlakozóval 1/2" 19 mm-es racsnikulcshoz
- 12 Csillag-villáskulcs irányváltós racsnival 8-9-10-11-12-13-14-15-16-17-18-19 mm
- 31 30 darab csavarhúzóbetét, mágneses gyorskioldó betéttartóval, tokban ● ○ ⊕ ⊖ ⊕ ⊖
- 1 vízpumpafogó 250 mm
- 1 Oldalsípőfogó 160 mm
- 1 kombinált fogó 180 mm
- 1 Extra hosszú laposfogó 160 mm
- 5 Csavarhúzó Phillips®-csavarokhoz ● 3x75-4x100-5,5x100-6,5x150-8x150 mm
- 1 Csavarhúzó hasítottfejű csavarokhoz, extra rövid penge ● 6,5x30 mm
- 3 Csavarhúzó Phillips®-csavarokhoz ⊕ 4,5x80-6x100-8x150 mm
- 1 Csavarhúzó Phillips®-csavarokhoz, extra rövid penge ⊕ 6x30 mm
- 4 Imbusz csavarhúzókészlet Torx®-csavarokhoz ● T20-T25-T27-T30

Beta-sz.	TR
900	M105
900L	M105
96BPC/SC9	M105
895/1	M105
895/3	M105
895/6	M105
900ME	M105
900LP	M105
900PH	M105
900TX	M105
900/16	M105
900/...	M105
900/25	M105
900BG/30	M105
900/42	M105
900/55	M105
910A	M105
910/15	M105
910/16	M105
910/21	M105
910/22	M105
910/25	M105
910/42	M105
910/55	M105
920A	M105
920/15	M105
910/25	M105
920AN	M105
920/42	M105
920/55	M105
920/55	M105
956E	M105
910AL	M125
920PE	M125
920FTX	M125
920TX	M125
920XZN	M125
920AL	M125
1692/5	M125
42	M25
90	M25
123Q1/4	M25
123Q3/8	M25
123Q1/2	M25
142	M25
861MX/A31	M166
1048N	M166
1082BM	M166
1150BM	M166
1162BM	M166
1290	M166
1290N	M166
1292	M166
1292N	M166
1297TX	M166



M105



M125



M25



M166

Ft

5988L/4M

1.698.400 059881088

5988U6/M

214 darabos szerszámkészlet habszivacs tálcában

► Univerzális alkalmazás

Mennyiség/megnevezés

- 22 csillag-villáskulcs 6-7-8-9-10-11-12-13-14-15-16-17-18-19-20-21-22-24-27-30-32-36 mm
- 11 villáskulcs 6x7-8x9-10x11-12x13-14x15-16x17-18x19-20x22-21x23-24x27-30x32 mm
- 11 hajlított csillagkulcs 6x7-8x9-10x11-12x13-14x15-16x17-18x19-20x22-21x23-24x27-30x32 mm
- 9 Hajlított gömbfejű imbuszkulcs \odot 1,5-2-2,5-3-4-5-6-8-10 mm
- 6 csavarhúzó hasítottfejű csavarokhoz \bullet 2,5x50-3x75-4x100-5,5x125-6,5x150-8x200 mm
- 1 csavarhúzó hasítottfejű csavarokhoz, extra rövid \bullet 4x30 mm
- 4 csavarhúzó keresztfejű Phillips® csavarokhoz \oplus PH0x60-PH1x80-PH2x100-PH3x150 mm
- 1 csavarhúzó keresztfejű Phillips® csavarokhoz, extra rövid \oplus PH1x30 mm
- 12 imbusz-csavarhúzó Torx®-csavarokhoz \odot T6-T7-T8-T9-T10-T15-T20-T25-T27-T30-T40-T45
- 1 Fáziskereső \bullet
- 3 kiütő \emptyset 2-3-4 mm
- 6 hosszú kiütő \emptyset 2-3-4-5-6-8 mm
- 1 pontozó \emptyset 4 mm
- 1 laposvágó 150 mm
- 2 erősített laposvágó 200-250 mm
- 1 keresztvágó 125 mm
- 1 lakatos kalapács 500 g
- 1 műanyag kalapács \emptyset 35 mm
- 1 fékes mérőszalag 3 m
- 1 flexibilis teleszkópos mágneses csavarkiszedő
- 1 szögletes egyengető reszelő markolattal 200 mm
- 1 háromszög egyengető reszelő markolattal 200 mm
- 1 lapos egyengető reszelő markolattal 200 mm
- 1 félkerek egyengető reszelő markolattal 200 mm
- 1 kerek egyengető reszelő markolattal 200 mm
- 1 Acél drótkefe
- 1 dekorkés 170 mm
- 1 egyenes belső Seeger-fogó \odot 180 mm
- 1 hajlított belső Seeger - fogó \odot 170 mm
- 1 egyenes külső Seeger-fogó \bullet 175 mm
- 1 hajlított külső Seeger - fogó \bullet 175 mm
- 1 vízpumpafogó 250 mm
- 1 Egyenes pófájú önzáró fogó 240 mm
- 1 Oldalsípófogó \ddagger 160 mm
- 1 Rabbit-fogó, lakkozott 220 mm
- 1 bádogos lemezolló 250 mm
- 1 Egyenes élű műszerész olló 145 mm
- 1 kombinált fogó \equiv 180 mm
- 1 Egyenes extra hosszú félkerekcsőrű fogó \bullet 160 mm
- 1 Hajlított extra hosszú félkerekcsőrű fogó \bullet 160 mm
- 1 behajtó betéttartó adapter
- 1 behajtó betéttartó adapter
- 1 behajtó betéttartó adapter
- 13 1/4"-os hatlapú dugókulcs \odot 4-4,5-5-5,5-6-7-8-9-10-11-12-13-14 mm
- 9 \odot 5-6-7-8-9-10-11-12-13 mm
- 5 1/4"-os imbusz-dugókulcs \odot 3-4-5-6-7 mm
- 4 csavarhúzó-dugókulcs hasítottfejű csavarokhoz, krómozott, barnított hegy \bullet 0,8x4-1x5,5-1,2x6,5-1,2x8 mm
- 4 csavarhúzó-dugókulcs Phillips®-csavarokhoz, krómozott, barnított hegy \oplus PH1-PH2-PH3-PH4
- 7 1/4"-os Torx®-imbusz dugókulcs, krómozott, fekete hegyek \odot T10-T15-T20-T25-T27-T30-T40
- 1 1/4" - os toldó 50 mm
- 1 1/4" - os toldó 100 mm
- 1 1/4" - os toldó 150 mm
- 1 1/4"-os csukló
- 1 1/4"-os hajtószár
- 1 1/4"-os csúszkás T-hajtószár
- 1 1/2"-os irányváltós racsni \oplus
- 21 1/2"-os hatlapú dugókulcs \odot 8-10-11-12-13-14-15-16-17-18-19-20-21-22-23-24-26-27-28-30-32 mm
- 1 szűkítő közbetét 1/2" és 3/8" 125 mm
- 1 1/2"-os csukló 250 mm
- 1 1/2" Gömbvégű toldó
- 1 1/2" Gömbvégű toldó
- 1 1/2"-os csúszkás T-hajtószár
- 1 1/2"-os irányváltós racsni \oplus
- 8 1/2"-os Torx®-dugókulcs \odot 10-12-14-16-18-20-22-24 mm
- 11 hatlapú dugókulcs \odot 10-12-13-14-15-16-17-18-19-21-22 mm

Beta-sz.	TR
	42
	55
	90
96BPC/SC9	M30
1201E	M213
1201EN	M213
1202E	M213
1202EN	M213
1207E/TX	M213
1253	M213
30	M230
31	M230
32	M230
34	M230
35	M230
36	M230
1370	M230
1390	M230
1692	M230
1712TF	M230
1719BMA...Q	M230
1719BMA...T	M230
1719BMA...P	M230
1719BMA...M	M230
1719BMA...R	M230
1737NX	M230
1771	M230
1032	M129
1034	M129
1036	M129
1038	M129
1048N	M129
1052	M129
1082BM	M129
1098	M129
1112	M129
1128BM	M129
1150BM	M129
1166BM	M129
1168BM	M129
895/1	M100
895/3	M100
895/6	M100
900	M100
900L	M100
900ME	M100
900LP	M100
900PH	M100
900TX	M100
900/20	M100
900/20L	M100
900/21	M100
900/25	M100
900BG/30	M100
900/42	M100
900/55	M100
920A	M100
920/15	M100
920/25	M100
920AN/125	M100
920AN/250	M100
920/42	M100
920/55	M100
920FTX	M100
920AL	M100



M01



M30



M213



M230



M129



M100

Ft

5988U6/M

1.424.400 059881430

Készletárrsítási javaslat RSC24 8 fiókkal - RSC24A 8 fiókkal - RSC24AXL c 8-9 fiókkal - RSC24AXL/P RSC24AXXL - RSC28 - C37 8 fiókkal - C39 8 fiókkal - C39SM - C39MD - RSC55 - RSC50 2.0 - C59B - C58BC

► Elektrotechnikai karbantartás

Mennyiség/megnevezés

- 1 Egyenes potfajú önzáró fogó 240 mm
- 1 lakatos kalapács 500 g
- 1 műanyag kalapács Ø 35 mm
- 1 szögletes egyengető reszelő markolattal 200 mm
- 1 lapos egyengető reszelő markolattal 200 mm
- 1 háromszög egyengető reszelő markolattal 200 mm
- 1 félkerek egyengető reszelő markolattal 200 mm
- 1 kerek egyengető reszelő markolattal 200 mm
- 1 erősített laposvágó 200 mm
- 1 egyenes belső Seeger-fogó Ⓞ 180 mm
- 1 hajlítot belső Seeger - fogó Ⓞ 170 mm
- 1 egyenes külső Seeger-fogó ● 175 mm
- 1 hajlítot külső Seeger - fogó ● 175 mm
- 1 Erősített oldalcsípőfogó † 160 mm
- 1 kombinált fogó = 180 mm
- 1 Egyenes extra hosszú félkerekcsőrű fogó ● 160 mm
- 9 Hajlítot gömbfejű imbuszkulcs ○ 1,5-2-2,5-3-4-5-6-8-10 mm
- 1 normál csavartartó csavarhúzó ● 4x125 mm
- 1 Phillips® - csavartartó csavarhúzó ⊕ PH1x125 mm
- 1 Fáziskereső ●
- 6 Hosszú dugókulcs - csavarhúzó ○ 5,5-6-7-8-10-13 mm
- 4 Phillips® - csavarhúzó 1000V ⊕ PH0x60-PH1x80-PH2x100-PH3x150 mm
- 6 1000 V - os szigetelt csavarhúzó ● 2,5x75-3x100-4x100-5,5x125-6x150-8x175 mm
- 31 30 csavarhúzóbetét és mágneses gyorslazítású betéttartó, műanyag dobozban ● ○ ⊕ ⊕ ⊕ ⊕
- 1 VDE-mágneses betéttartó bimateriál-nyéllel ®
- 8 villáskulcs 6x7-8x9-10x11-12x13-14x15
16x17-18x19-20x22 mm
- 1 Vízpumpafogó, stifttel állítható, szigetelt, 1000V 250 mm
- 1 Oldalcsípőfogó 1000V † 140 mm
- 1 Egyenes élű műszerész olló 148 mm
- 1 Szigetelt nyelvű kábelvágó 230 mm
- 1 Kábelcsupaszoló fogó † 160 mm
- 1 Kombinált fogó 1000V = 180 mm
- 1 Egyenes félkerekcsőrű fogó, extra hosszú 1000V ● 160 mm
- 1 hajlítot félkerekcsőrű fogó, extra hosszú, krómozott ● 160 mm
- 1 Állítható villáskulcs 1000V 250 mm
- 1 Kábelkés élvédővel 1000V
- 1 Hajlítot csapos csipesz lekerekített fogazott hegygel 1000V
- 1 saruzófogó

Beta-sz.	TR
1052	MB65
1370	MB65
1390	MB65
1719BMA...Q	MB65
1719BMA...P	MB65
1719BMA...T	MB65
1719BMA...M	MB65
1719BMA...R	MB65
35	MB65
1032	MB65
1034	MB65
1036	MB65
1038	MB65
1084BM	MB65
1150BM	MB65
1166BM	MB65
96BPC/SC9	MB63
1250	MB63
1251	MB63
1253	MB63
943MQ	MB63
1272MQ	MB63
1274MQ	MB63
860MIX/A31	MB63
850MQ	MB63
55	MB64
1048MQ	MB64
1082MQ	MB64
1128BSX	MB64
1132MQ	MB64
1142MQ	MB64
1150MQ	MB64
1166MQ	MB64
1168MQ	MB64
110MQ	MB64
1777MQ	MB64
993MQ	MB64
1602	MB64



MB65



MB64



MB63

► **Elektrotechnika**

Mennyiség/megnevezés	Beta-sz.
1 pontozó Ø 4 mm	32
1 erősített laposvágó 150 mm	35
8 villáskulcs, krómzott 6x7 - 8x9 - 10x11 - 12x13 - 14x15 - 16x17 - 18x19 - 20x22 mm	55/B8N
8 8 darabos hatszögű imbuszkulcskészlet, hosszított kivétel Ø 2+10 mm	96LC/SC8
1 Állítható villáskulcs 200 mm	111E
1 VDE-mágneses betéttartó bimateriál-nyéllel	850MQ
10 10 darab csavarhúzóbetét, mágneses betéttartóval, tokban	861MIX/A10
1 Vízpumpa fogó, stifttel állítható, szigetelt, 1000V 250 mm	1048MQ
1 Oldalsíp fogó 160 mm	1082BM
1 Egyenes élű műszerész olló 148 mm	1128BSX
1 kábelvágó 170 mm	1132BM
1 kombinált fogó 180 mm	1150BM
1 Egyenes extra hosszú félkerekcsőrű fogó 160 mm	1166BM
1 Hajlított extra hosszú félkerekcsőrű fogó 160 mm	1168BM
1 normál csavartartó csavarhúzó 4x125 mm	1250
1 Phillips® - csavartartó csavarhúzó PH1x125 mm	1251
1 Fáziskereső	1253
5 csavarhúzó hasítottfejjű csavarokhoz 2,5x75 - 3,5x100 - 5,5x125 - 6,5x150 mm	1201E
1 csavarhúzó hasítottfejjű csavarokhoz, extra rövid 4x30 mm	1201EN
4 csavarhúzó keresztfejjű Phillips® csavarokhoz PH0x60 - PH1x120 - PH2x150 - PH3x150 mm	1202E
1 csavarhúzó keresztfejjű Phillips® csavarokhoz, extra rövid PH2x30 mm	1202EN
4 Phillips® - csavarhúzó 1000V PH0x60 - PH1x80 - PH2x100 - PH3x150 mm	1272MQ
5 1000 V - os szigetelt csavarhúzó 5,5x125 - 3x100 - 4x100 - 6,5x150 - 8x175 mm	1274MQ
1 Oldalvágó, krómzott	1343
1 lakatos kalapács 300 g	1370
1 műanyag kalapács Ø 35 mm	1390
1 saruzófogó	1602
1 25 m	BMESB1925NE
1 fékes mérőszalag 5 m	1692
1 félkerek egyengető reszelő markolattal 200 mm	1719BMA...M
1 kerek egyengető reszelő markolattal 200 mm	1719BMA...R
1 fűrész	1725
1 blankoló kés	1777BM



Ft

5980ET/A

432.800 059801083

Készletársítási javaslat C12 - 2028VV - 2032TV - 2032VV

5980ET/B

64 darabos szerszámkészlet

► Elektrotechnika

Mennyiség/megnevezés

- 3 hosszú kiütő Ø 2 - 3 - 4 mm
- 1 pontozó Ø 4 mm
- 1 laposvágó 150 mm
- 8 villáskulcs, krómozott 6x7 - 8x9 - 10x11 - 12x13 - 14x15 - 16x17 - 18x19 - 20x22 mm
- 9 Hajlítót gömbfejű imbuszkulcs Ø 1,5 - 2 - 2,5 - 3 - 4 - 5 - 6 - 8 - 10 mm
- 1 Sorjázó 150 mm
- 6 Hosszú dugókulcs csavarhúzó 1000V ○ 5,5 - 6 - 7 - 8 - 10 - 13 mm
- 1 Vizpumpafogó, stíftel állítható, szigetelt, 1000V 250 mm
- 1 Oldalcspifogó 1000V ☞ 160 mm
- 1 Egyenes élű műszerész olló 148 mm
- 1 Szigetelt nyelű kábelvágó 230 mm
- 1 Kábelcsupaszoló fogó ☞ 160 mm
- 1 Kombinált fogó 1000V ≡ 180 mm
- 1 Egyenes félkerékcserő fogó, extra hosszú 1000V ● 160 mm
- 1 Fáziskereső ●
- 3 Phillips® - csavarhúzó 1000V ⊕ PH0x60 - PH1x80 - PH2x100 mm
- 4 1000 V - os szigetelt csavarhúzó ● 3x100 - 4x100 - 5,5x125 - 6,5x150 mm
- 1 lakatos kalapács 300 g
- 1 műanyag kalapács Ø 35 mm
- 1 saruzófogó
- 1 Rugalmas skálás vonalzó 250 mm
- 1 rajztű 250 mm
- 1 fékes mérőszalag 5 m
- 1 Vízmérték alumíniumból 200 mm
- 1 Villanyszerelő laposvéső 10x200 mm
- 1 Csapózsín
- 1 Flexibilis négyzet alakú vizsgálótűkör 600 mm
- 1 reszelő 200 mm
- 1 reszelő 200 mm
- 1 rugó beakasztó
- 1 fűrész
- 1 ecset
- 1 Kábelkötegelő fogó
- 1 pumpás műanyag olajozó kanna 150 cc
- 100 műanyag kábelkötegelő szalag, fekete UV-álló 3,6x200 mm
- 100 műanyag kábelkötegelő szalag, fekete UV-álló 4,8x300 mm
- 1 dekorkés 170 mm
- 1 forrasztópáka 30 W
- 1 LED lámpa, robusztus eloxált alumíniumból

Beta-sz.

- 31
- 32
- 34
- 55/BN
- 96BPC/SC9
- 345SB
- 943MQ/S6
- 1048MQ
- 1082MQ
- 1128BSX
- 1132MQ
- 1142MQ
- 1150MQ
- 1166MQ
- 1253
- 1272MQ
- 1274MQ
- 1370
- 1390
- 1602
- 1682
- 1688
- 1692
- 1696
- 1701NE3
- 1705
- 1715FL/A
- 1719BMA8/M
- 1719BMA8/R
- 1723
- 1726BM
- 1738
- 1743
- 1754
- 1748N
- 1748M
- 1771BM
- 1814M
- 1833XS/2

Ft

5980ET/B 599.700 059801084

Készletlétszámjavaslat C12 - 2029/VV - 2033P/VV - 2036TV

5980MQ

46 darabos szerszámkészlet

► Elektrotechnika

Mennyiség/megnevezés

- 7 Egyoldalas villáskulcs 1000V 10 - 12 - 13 - 14 - 17 - 19 - 22 mm
- 1 Állítható villáskulcs 1000V 250 mm
- 6 Hosszú dugókulcs - csavarhúzó ○ 5,5 - 6 - 7 - 8 - 10 - 13 mm
- 4 T-szerű imbuszkulcs Ø 4 - 5 - 6 - 8 mm
- 1 Hajlítót csapos csipesz lekerekített fogazott hegygel 1000V
- 1 Vizpumpafogó, stíftel állítható, szigetelt, 1000V 250 mm
- 1 Oldalcspifogó 1000V ☞ 160 mm
- 1 Műszerészolló 145 mm
- 1 Kábelcsupaszoló fogó ☞ 160 mm
- 1 Kombinált fogó 1000V ≡ 180 mm
- 1 Hajlítót extra hosszú laposfogó ≡ 160 mm
- 1 Egyenes félkerékcserő fogó, extra hosszú 1000V ● 160 mm
- 1 Fáziskereső ●
- 4 Phillips® - csavarhúzó 1000V ⊕ PH0x60 - PH1x80 - PH2x100 - PH3x150 mm
- 5 1000 V - os szigetelt csavarhúzó ● 3x100 - 4x100 - 5,5x125 - 6,5x150 - 8x175 mm
- 1 lakatos kalapács 300 g
- 1 műanyag kalapács Ø 35 mm
- 1 fékes mérőszalag 5 m
- 1 Villanyszerelő laposvéső 200 mm
- 1 Fűrész 1000V
- 2 Kábelkés élvédővel 1000V
- 1 forrasztópáka 30 W
- 1 LED zseblámpa intenzív fényerővel, robusztus eloxált alumíniumból, 500 lumenig
- 1 Feszültség és folytonosság tesztter, 1000V

Beta-sz.

- 52MQ
- 110MQ
- 943MQ
- 951MQ
- 993MQ
- 1048MQ
- 1082MQ
- 1128MQ
- 1142MQ
- 1150MQ
- 1164MQ
- 1166MQ
- 1253
- 1272MQ
- 1274MQ
- 1370
- 1390
- 1692
- 1701NE/3
- 1725MQ
- 1777MQ
- 1814M
- 1833S
- 1760PT/N

Ft

5980MQ 793.400 059801257

5988 VHB-MQ

66 darabos szerszámkészlet EVA habszivacs tálcában

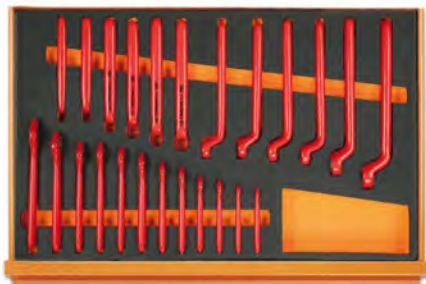

M49



M108



M161

► Elektrotechnikai karbantartás

Mennyiség/megnevezés

- 12 Egyoldalas villáskulcs 1000V 7-8-10-11-12-13-14-15-16-17-19-22 mm
- 12 Egyoldalas csillagkulcs 7-8-10-11-12-13-14-15-16-17-19-22 mm
- 4 3/8"-os imbusz-dugókulcs \odot 4-5-6-8 mm
- 11 tizenkétszögű dugókulcs \odot 7-8-10-11-12-13-14-15-16-17-19 mm
- 6 dugókulcs Torx® csavarokhoz \odot T15-T20-T25-T27-T30-T40
- 2 Dugókulcs XZN® csavarokhoz \odot 8-10 mm
- 1 3/8"-os toldó 125 mm
- 1 3/8"-os toldó 250 mm
- 1 3/8"-os T-hajtósár
- 1 3/8" irányváltós racsnis
- 1 Műszerészolló 145 mm
- 1 Vízpumpafogó, stífttel állítható, szigetelt, 1000V 250 mm
- 1 Oldalcsipőfogó 1000V ∇ 160 mm
- 1 Kombinált fogó 1000V \equiv 180 mm
- 1 Egyenes laposfogó, extra hosszú, krómozott \equiv 160 mm
- 1 Hajlított extra hosszú laposfogó \equiv 160 mm
- 4 Phillips® - csavarhúzó 1000V \oplus PH0x60 - PH1x80 - PH2x100 - PH3x150 mm
- 4 1000 V - os szigetelt csavarhúzó \bullet 2,5x75 - 3x100 - 4x100 - 5,5x125 mm
- 1 Kábelkés

Beta-sz.	TR
52MQ	M49
89MQ	M49
910MQ/PE	M108
910MQ/B	M108
910MQ/TX	M108
910MQ/XZN	M108
910MQ/21	M108
910MQ/22	M108
910MQ/T	M108
910MQ/55	M108
1128MQ	M161
1048MQ	M161
1082MQ	M161
1150MQ	M161
1162MQ	M161
1164MQ	M161
1272MQ	M161
1274MQ	M161
1777MQ/U	M161

Ft

5988 VHB-MQ 1.335.500 059880300

A készletet a következő elemekhez ajánljuk: RSC51- RSC23T - RSC24 - RSC24A - RSC24AXL - RSC24AXLP/7 - RSC24AXLL - RSC24L/7 - RSC24L-CAB - RSC28 - C37 - C39 - C39SM - C39MD - C39T - RSC55 - RSC50 2.0 - C59 - C58BC - C57

5980EL/A

57 darabos szerszámkészlet

► Elektronika

Mennyiség/megnevezés

- 13 4÷14 mm
- 9 imbuszkulcs \odot 1,5÷10 mm
- 1 hajlított fogazott csipesz 130 mm
- 1 egyenes végű csapos csipesz 150 mm
- 1 keresztcsipesz 155 mm
- 1 műszerész olló 147 mm
- 1 kábelcsupaszoló fogó ∇ 160 mm
- 1 Egyenes extra hosszú félkerekcsőrű fogó \bullet 160 mm
- 1 hosszú elektronikai lapos fogó \equiv 140 mm
- 1 Elektronikai hajlított félkerekcsőrű fogó, hosszított kivitel, polírozott \bullet 140 mm
- 1 elektronikai kombinált fogó \bullet 140 mm
- 1 elektronikai oldalcsipőfogó, keskeny ∇ 120 mm
- 1 elektronikai oldalcsipőfogó ∇ 125 mm
- 1 normál csavartartó csavarhúzó \bullet 4x125 mm
- 1 Phillips® - csavartartó csavarhúzó \oplus PH0x125 mm
- 8 csavarhúzó
- 1 lakatos kalapács 200 g
- 1 fékes mérőszalag 5 m
- 1 teleszkópos vizsgáló tükör
- 3 Tűreszelők
- 1 rugó beakasztó
- 1 ecset
- 1 Olajbefecskendező
- 1 dekorkés 170 mm
- 1 önzáró fogó lekerekített, recézett pófával, rozsdamentes acélból
- 1 forrasztópáka 25 W
- 1 ónszippantó
- 1 LED lámpa, robusztus eloxált alumíniumból

Beta-sz.

73/B13N	
96N/SC9	
991	
992	
998	
1128BMX	
1142BM	
1166BM	
1172BM	
1178BM/P	
1178BM	
1185BM	
1188BM	
1250	
1251	
1257LPH/S8	
1370	
1692	
1715	
1720/S3	
1723	
1738	
1756	
1771	
1002	
1814M	
1830T	
1833XS/2	

Ft

5980EL/A 432.200 059801081

Készletértécsítási javaslat 2032TV - 2028/VV - 2033P/VV

► Elektronika

Mennyiség/megnevezés

Beta-sz.

13	4+14 mm	73/B13N
9	imbuszkulcs \odot 1,5+10 mm	96/SC9
8	Hajlított Torx® - imbuszkulcs \odot T9 - T10 - T15 - T20 - T25 - T27 - T30 - T40	97TX/BG8
1	Állítható villáskulcs 150 mm	111E
18	13 hatlapú dugókulcs és 5 tartozék, 1/4"	900/C13-5
1	Egyenes csipesz lekerekített hegygel 130 mm	990
1	hajlított fogazott csipesz 130 mm	991
1	Hegyes végű egyenes csipesz 120 mm	999A
1	műszerész olló 147 mm	1128BMX
1	Automata vágó - és csupaszoló fogó 170 mm	1149F
1	kombinált fogó \equiv 180 mm	1150BM
1	hosszú elektronikai lapos fogó \equiv 140 mm	1172BM
1	Behajtható pengéjű kábelblankoló kés \bullet 140 mm	1177BM
1	Elektronikai hajlított félkerekcsőrű fogó, hosszított kivitel, polírozott \bullet 140 mm	1178BM/P
1	Speciális elektronikai oldalcsípőfogó, lekerekített pófával ζ 120 mm	1184BM
1	Speciális elektronikai oldalcsípőfogó, keskeny nyújtott pófával ζ 120 mm	1186BM
1	Speciális elektronikai homlokcsípőfogó, ferde vágóéllel ζ 130 mm	1191BM
8	csavarhúzó	1257LPH/S8
1	Fáziskereső \bullet	1253
1	Csavarhúzó hasítottfejű csavarokhoz, extra rövid penge \bullet 6,5x30 mm	1290N
3	Csavarhúzó Phillips®-csavarokhoz \bullet PH0x60 - PH1x80 - PH2x100 mm	1292
2	Csavarhúzó Phillips®-csavarokhoz, extra rövid penge \bullet PH1x30 - PH2x30 mm	1292N
5	Csavarhúzó hernyócsavarokhoz \bullet 2,5x60 - 3x75 - 4x100 - 5x125 - 6,5x150 mm	1294
1	lakatos kalapács 200 g	1370
1	Rugalmas skálás vonalzó 150 mm	1682
1	rajztű 220 mm	1688
1	fékes mérőszalag 5 m	1692
1	teleszkópos vizsgáló tükör 670 mm	1715
1	Tűreszelők \bullet	1720R
1	Tűreszelők \blacktriangle	1720T
1	Tűreszelők \blacksquare	1720P
1	rugó beakasztó	1723
1	ecset	1738
1	Olajbefecskendező	1756
1	dekorkés 170 mm	1771BM
1	blankoló kés	1777BM
1	önzáró fogó lekerekített, recézett pófával, rozsdamentes acélból	1002
1	forrasztópáka 25W	1814M
1	ónszippantó	1830T
1	LED lámpa, robusztus eloxált alumíniumból	1833XS/2

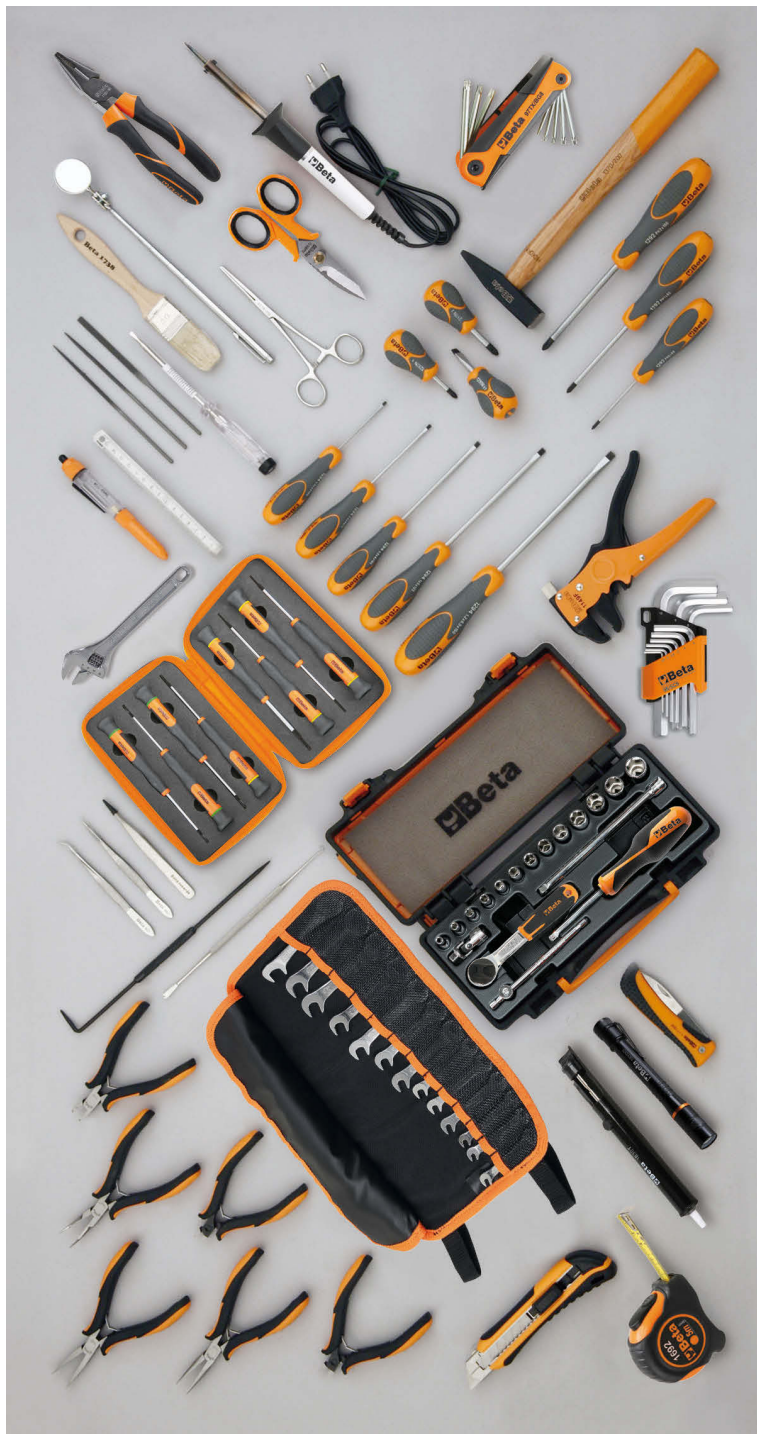

Ft



5980EL/B

607.300 059801082

Készletlátsítási javaslat 2029/11 - 2033P/11 - 2036TV



5980ID/1

24 darabos szerszámkészlet

► **Vízvezetékszerelés**

Mennyiség/megnevezés

Beta-sz.

- | | | |
|---|---|-------------|
| 1 | Állítható villáskulcs 250 mm | 111E |
| 1 | Ø 3÷28 mm | 332/2 |
| 1 | Csővágó réz és könnyűfém csövekhez Ø 3÷30 mm | 334 |
| 1 | Ø 0÷42 mm | 342 |
| 1 | 140 mm | 345SB2 |
| 2 | 320-410 mm | 376 |
| 2 | vízpumpafogó 175-250 mm | 1048N |
| 1 | műszerész olló 147 mm | 1128BMX |
| 1 | robustus kombinált fogó kétkomponensű markolat ipari kivitel = 180 mm | 1150GBM |
| 4 | csavarhúzó hasítottfejú csavarokhoz ● 3x75-4x100-5,5x150-8x150 mm | 1201E |
| 2 | csavarhúzó keresztfejú Phillips® csavarokhoz ● PH1x80-PH2x100 | 1202E |
| 1 | lakatos kalapács 500 g | 1370 |
| 1 | Colstok 2 m | 1690F |
| 1 | fékes mérőszalag 5 m | 1692/5 |
| 1 | Vízmérték alumíniumból 200 mm | 1696 |
| 1 | félkerek egyengető reszelő markolattal 200 mm | 1719BMA...M |
| 1 | Lapos reszelő 200 mm | 1719BM/RL |
| 1 | fűrész | 1725 |

Ft



5980ID/1

256.400 059801086

Beta

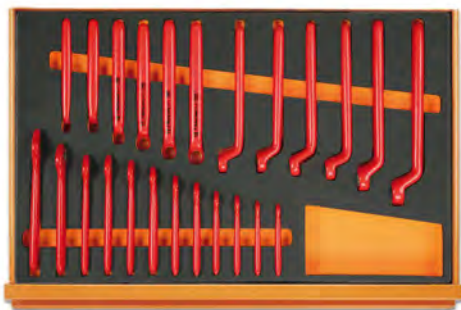

M49

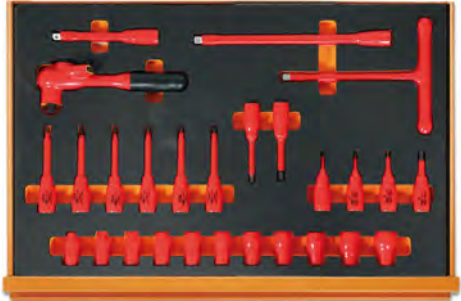

M108



M161



5989 VEM

81 darabos szerszámkészlet hibrid és elektromos gépjárművek javításához és karbantartásához

► Autójavítás

Mennyiség/megnevezés

- 1 Szigetelő aláfekvő
- 4 műanyag tereleőszlop tölthető talppal
- 1 Megaohmméter magasfeszültségű szigetelés vizsgáló
- 1 Feszültség és folytonosság tesztter, 1000V
- 1 póthegeyek digitális multiméterekhez és lakatfogókhoz
- 1 Kompozit szigetelt védőkesztyű Gr. 10
- 1 Pneumatikus vizsgáló szigetelt védőkesztyűkhöz
- 1 műanyag zárólánc
- 2 alumínium figyelmeztető tábla A1, A2
- 2 tiltó tábla D2, D3
- 12 Egyoldalas villáskulcs 1000V 7-8-10-11-12-13-14-15-16-17-19-22 mm
- 12 Egyoldalas csillagkulcs 7-8-10-11-12-13-14-15-16-17-19-22 mm
- 4 3/8"-os imbusz-dugókulcs \odot 4-5-6-8 mm
- 11 tizenkétszögű dugókulcs \odot 7-8-10-11-12-13-14-15-16-17-19 mm
- 6 dugókulcs Torx® csavarokhoz \odot TX15-TX20-TX25-TX27-TX30-TX40
- 2 Dugókulcs XZN® csavarokhoz \odot M8-M10
- 1 3/8"-os toldó 140 mm
- 1 3/8"-os toldó 265 mm
- 1 3/8"-os T-hajtószár 200 mm
- 1 3/8" irányváltós racsnit 203 mm
- 1 Vízpumpafogó, stifttel állítható, szigetelt, 1000V 250 mm
- 1 Oldalsípőfogó 1000V \llcorner 160 mm
- 1 Műszerészolló 145 mm
- 1 Kombinált fogó 1000V \equiv 180 mm
- 1 Egyenes laposfogó, extra hosszú, krómozott \equiv 160 mm
- 1 Hajlított extra hosszú laposfogó \equiv 160 mm
- 4 Phillips® - csavarhúzó 1000V \oplus PH0-PH1-PH2-PH3
- 4 1000 V - os szigetelt csavarhúzó \bullet 2,5x75-3x100-4x100-5.5x125 mm
- 1 Kábelkés 190 mm

Beta-sz.	TR
1995MQ/T	
7104 90	
1760OHM2	
1760PTN	
1760DGT-R3	
1997MQ/GM	
1996VPG	
7105 6	
7109A	
7109D	
52MQ	M49
89MQ	M49
910MQ/PE	M108
910MQ/B	M108
910MQ/TX	M108
910MQ/XZN	M108
910MQ/21	M108
910MQ/22	M108
910MQ/T	M108
910MQ/55	M108
1048MQ	M161
1082MQ	M161
1128MQ	M161
1150MQ	M161
1162MQ	M161
1164MQ	M161
1272MQ	M161
1274MQ	M161
1777MQ/U	M161

Ft

5989 VEM 2.088.100 059890116

A készletet az RSC23T - RSC24 - RSC24A - RSC24AXL - RSC24AXLP/7 - RSC24AXXL - RSC24L/7 - RSC24L-CAB - RSC28 - C37 - C39 - C39T - C39SM - C39MD - RSC51 - RSC55 - RSC50 2.0 - C59 - C58BC - C57 termékkel együtt ajánljuk

5902MT

106 darabos szerszámkészlet mezőgazdasági, építő és földmunka gépekhez

► Földmunkagépekhez

Mennyiség/megnevezés

- 2 kiütő Ø 3 - 4 mm
- 2 hosszú kiütő Ø 6 - 8 mm
- 1 pontozó Ø 4 mm
- 2 erősített laposvágó 150 - 200 mm
- 18 csillag-villáskulcs 6÷14 - 17 - 19 - 22 - 24 - 27 - 30 - 32 - 36 - 41 mm
- 10 hajlított csillagkulcs 6x7 - 8x9 - 10x11 - 12x13 - 14x15 - 16x17 - 18x19 - 20x22 - 24x27 - 30x32 mm
- 10 imbuszkulcs Ø 1,5÷12 mm
- 17 1/2"-os hatlapú dugókulcs Ø 10÷22 - 24 - 27 - 30 - 32 mm
- 1 1/2"-os toldó 125 mm
- 1 1/2"-os toldó 255 mm
- 1 1/2"-os csukló
- 1 1/2"-os csúszkás T-hajtósár
- 1 1/2"-os átnyomós irányváltós racsnival
- 11 3/4" - os hatlapú dugókulcs Ø 22 - 24 - 27 - 30 - 32 - 36 - 41 - 46 - 50 - 55 - 60 mm
- 1 3/4" - os toldó 200 mm
- 1 3/4"-os csuklós hajtósár
- 1 3/4" - os csúszkás T - hajtósár
- 1 3/4" - os irányváltós racsnival
- 1 szerelővas
- 1 vízpumpafofó 250 mm
- 1 ívelt pofájú önzáró fogó
- 1 erősített oldalcsípőfogó, kétkomponensű markolat ipari kivitel 160 mm
- 1 műszerész olló 147 mm
- 1 robusztus kombinált fogó kétkomponensű markolat ipari kivitel 180 mm
- 1 egyenes extra hosszú félkerekcsőrű fogó, kétkomponensű markolat ipari kivitel 160 mm
- 4 Lapos csavarhúzó, hatlapfejű szárvégzördéssel 6,5x150 - 8x175 - 10x200 - 12x250 mm
- 3 Csavarhúzó Phillips® - csavarokhoz, hatszögű penge, PH2x150 - PH3x175 - PH4x200 mm
- 1 amerikai gömbfejű kalapács 900 g
- 1 műanyag kalapács Ø 35 mm
- 1 Hézagmérő
- 1 háromélű hántoló 200 mm
- 5 5 darabos egyengető reszelő készlet markolattal 200 mm
- 1 fűrész

Beta-sz.

- 30
- 31
- 32
- 35
- 42
- 90
- 96N/B10
- 920A
- 920/21
- 920/22
- 920/25
- 920/42
- 920/50
- 928A
- 928/21
- 928/36A
- 928/42
- 928/55
- 964
- 1048N
- 1055
- 1084GBM
- 1128BMX
- 1150GBM
- 1166GBM
- 1260E
- 1262E
- 1377
- 1390
- 1708/20
- 1717B
- 1719BMA...S5
- 1725



Ft

5902MT 1.007.200 059021053

Készletlártsítási javaslat RSC22 - RSC23 - RSC23C - C39T



5902MT/AS

99 darabos földmunkagépekhez (CATERPILLAR)

► Földmunkagépekhez

Mennyiség/megnevezés	Beta-sz.
2 kiütő Ø 3 - 4 mm	30
2 hosszú kiütő Ø 6 - 8 mm	31
1 pontozó Ø 4 mm	32
2 erősített laposvágó 150 - 200 mm	35
20 csillag-villáskulcs 1/4+1.1/2"	42AS
6 hajlított csillagkulcs 1/4x5/16 - 3/8x7/16 - 1/2x9/16 5/8x3/4 - 11/16x13/16 - 7/8x15/16"	90AS
11 imbuszkulcs Ø 3/64+3/8"	96AS/B11
10 1/2" - os tizenkétszögű dugókulcs ○ 7/16 - 1/2 - 9/16 5/8 - 11/16 - 3/4 - 13/16 - 7/8 - 15/16 - 1"	920AS
1 1/2"-os toldó 125 mm	920/21
1 1/2"-os toldó 255 mm	920/22
1 1/2"-os csukló	920/25
1 1/2"-os csúszkás T-hajtószár	920/42
1 1/2"-os átnyomós irányváltós racsnit	920/50
12 Hattlapú dugókulcs 1/4" ○ □ 3/4", 7/8 - 15/16 - 1 - 1.1/16 - 1.1/8 - 1.1/4 - 1.5/16 1.1/2 - 1.5/8 - 1.11/16 - 1.7/8 - 2"	928AS
1 3/4" - os toldó 200 mm	928/21
1 3/4"-os csuklós hajtószár	928/36A
1 3/4" - os csúszkás T - hajtószár	928/42
1 3/4" - os irányváltós racsnit	928/55
1 szerelővas	964
1 vízpumpafogó 250 mm	1048N
1 ívelt pófajú önzáró fogó	1055
1 erősített oldalcsípőfogó, kétkomponensű markolat ipari kivitel 160 mm	1084GBM
1 műszerész olló 147 mm	1128BMX
1 robusztus kombinált fogó kétkomponensű markolat ipari kivitel 180 mm	1150GBM
1 egyenes extra hosszú félkerékcsőrű fogó, kétkomponensű markolat ipari kivitel 160 mm	1166GBM
4 Lapos csavarhúzó, hatlapfejű szárvégzöldéssel ● 6,5x150 - 8x175 - 10x200 - 12x250 mm	1260E
3 Csavarhúzó Phillips® - csavarokhoz, hatszögű penge, PH2x150 - PH3x175 - PH4x200 mm	1262E
1 amerikai gömbfejű kalapács 900 g	1377
1 műanyag kalapács Ø 35 mm	1390
1 Hézagmérő 150 - 200 mm	1708/20
1 háromélű hántoló 200 mm	1717B
5 darabos egyenetlő reszelő készlet markolattal 200 mm	1719BMA...S5
1 fűrész	1725

Ft

5902MT/AS

1.047.300 059021054

Készletlátsítási javaslat RSC22 - RSC23 - RSC23C - C39T

5904VG/2M

170 darabos szerszámkészlet habshivacs tálcában

► Autójavító

Mennyiség/megnevezés

- 16 csillag-villáskulcs 6+21 mm
- 5 csillag-villáskulcs 22 - 24 - 27 - 30 - 32 mm
- 8 T - szárú imbuszkulcs műanyag markolattal \odot 2-2,5-3-4-5-6-7-8 mm
- 5 Imbusz csavarhúzókészlet Torx®-csavarokhoz \odot T10-T15-T20-T25-T30
- 7 Hatszögű csavarhúzóbetétek \odot 4-5-6-7-8-10-12 mm
- 7 Hatszögű csavarhúzóbetétek \odot 4-5-6-7-8-10-12 mm
- 5 Csavarhúzóbetétek XZN®-csavarhoz \odot 5-6-8-10-12 mm
- 5 Csavarhúzóbetétek XZN®-csavarhoz \odot 5-6-8-10-12 mm
- 7 Csavarhúzóbetétek Torx®-csavarhoz \odot T20-T25-T30-T40-T45-T50-T55
- 6 Csavarhúzóbetétek Torx®-csavarhoz \odot T25-T30-T40-T45-T50-T55
- 7 Csavarhúzóbetétek Tamper Resistant Torx®-csavarhoz \odot T20-T25-T30-T40-T45-T50-T55
- 1 Betéttartó a 867-es betétekhez
- 1 Betéttartó a 867-es betétekhez
- 5 csavarhúzó hasítottfejű csavarokhoz \bullet 3x75 - 3,5x100 - 4x125 - 5,5x150 - 6,5x150 mm
- 3 Phillips®-csavarhúzó \oplus PH0x60 - PH1x80 - PH2x100 mm
- 1 Lapos törpe csavarhúzó \bullet 4x30 mm
- 1 Csavarhúzó Phillips® - csavarokhoz, extra rövid penge \oplus PH1x30 mm
- 5 Színes csavarhúzóbetét hasítottfejű csavarokhoz \bullet 0,5x3 - 0,6x4,5 - 0,8x5,5 - 1x5,5 - 1,2x6,5 mm
- 8 Színes hatszögű csavarhúzóbetét \odot 2 - 2,5 - 3 - 4 - 5 - 6 - 8 - 10 mm
- 5 Színes csavarhúzóbetét Phillips®-csavarokhoz \oplus PH0 - PH1 - PH2 - PH3 - PH4
- 4 Színes csavarhúzóbetét Pozidriv®- és Supadriv®-csavarokhoz \oplus PZ1 - PZ2 - PZ3 - PZ4
- 11 Színes csavarhúzóbetét Torx®-csavarokhoz \odot T6-T7-T8-T9-T10-T15-T20-T25-T27-T30-T40
- 8 Színes csavarhúzóbetét Tamper Resistant Torx®-csavarokhoz \odot T9-T10-T15-T20-T25-T27-T30-T40
- 1 Betéttartó nyéllel 230 mm
- 1 Irányváltós racsn, betéttartóval \oplus 100 mm
- 1 Mágneses betéttartó 80 mm
- 1 Adapter dugókulcshoz \blacksquare 1/4 - \square 1/4
- 2 erősített laposvágó 100 - 200 mm
- 1 lakatos kalapács 300 g
- 1 műanyag kalapács \varnothing 35 mm
- 1 1/2" Gömbvégű toldó 125 mm
- 1 1/2" Gömbvégű toldó 250 mm
- 1 1/2"-os csukló
- 1 1/2"-os csúszkás T-hajtószár
- 1 1/2"-os irányváltós racsn \oplus
- 19 1/2"-os hatlapú dugókulcs \odot 10+24 - 26 - 27 - 30 - 32 mm
- 1 kombinált fogó \equiv 180 mm
- 1 Egyenes extra hosszú félkerékcsőrű fogó \bullet 160 mm
- 1 Erősített oldalcsípőfogó ζ 160 mm
- 1 egyenes belső Seeger-fogó \odot 180 mm
- 1 hajlított belső Seeger - fogó \odot 170 mm
- 1 egyenes külső Seeger-fogó \bullet 175 mm
- 1 hajlított külső Seeger - fogó \bullet 175 mm

Beta-sz.	TR
42	M05
42	M06
96T	M50
97TTX	M55
867PE	M86
867PE/L	M86
867XZN	M86
867XZN/L	M86
867TX	M86
867TX/L	M86
867RTX	M86
867/1	M86
867/2	M86
1260	M208
1262	M208
1260N	M208
1262N	M208
860LP	M85
860PE	M85
860PH	M85
860PZ	M85
860TX	M85
860RTX	M85
851SR	M85
860/55	M85
882P	M85
8920	M85
35	M234
1370	M234
1390	M234
920AN/125	M83
920AN/250	M83
920/25	M83
920/42	M83
920/55	M83
920A	M83
1150BM	M136
1166BM	M136
1084BM	M136
1032	M145
1034	M145
1036	M145
1038	M145



M05 M06 VPM3



M50 M55 M86



M208 M85 M234



M83 M136 M145

Ft

5904VG/2M

805.300 059041198

Készletjárás javaslat RSC23T - RSC24 - RSC24A - RSC24AXL - RSC24AXLP/7 - RSC24AXXL - RSC24L/7 - RSC24L-CAB
RSC28 - C37 - C39 - C39T - C39SM - C39MD RSC55 - RSC50 2.0 - C59 - C58BC - C57

5904VG/2T

99 darabos szerszámkészlet ABS hőformált tálcában

► Autójavító

Mennyiség/megnevezés

- 16 csillag-villáskulcs 6÷21 mm
- 5 csillag-villáskulcs 22 - 24 - 27 - 30 - 32 mm
- 19 1/2"-os hatlapú dugókulcs \odot 10÷24 - 26 - 27 - 30 - 32 mm
- 5 1/2"-os imbusz dugókulcs \odot 5 - 6 - 8 - 10 - 12 mm
- 1 1/2"-os toldó 125 mm
- 1 1/2"-os toldó 255 mm
- 1 1/2"-os csukló
- 1 1/2"-os csúszkás T-hajtószer
- 1 1/2"-os irányváltós racsni \otimes
- 1 vízpumpafogó 250 mm
- 1 Egyenes pofájú önzáró fogó 240 mm
- 1 Erősített oldalcsípőfogó ∇ 160 mm
- 1 Egyenes extra hosszú félkerécsőrű fogó \bullet 160 mm
- 1 kombinált fogó \equiv 180 mm
- 1 egyenes belső Seeger-fogó \odot 180 mm
- 1 egyenes külső Seeger-fogó \bullet 175 mm
- 1 hajlított belső Seeger - fogó \odot 170 mm
- 1 hajlított külső Seeger - fogó \bullet 175 mm
- 2 erősített laposvágó 100 - 200 mm
- 1 lakatos kalapács 300 g
- 1 műanyag kalapács \emptyset 35 mm
- 4 csavarhúzó hasítottfejű csavarokhoz \bullet 3x75 - 4x100 - 5,5x150 - 6,5x150 mm
- 3 Phillips®-csavarhúzó \oplus PH0x60 - PH1x80 - PH2x100 mm
- 8 villáskulcs 6x7 - 8x9 - 10x11 - 12x13 - 14x15 - 16x17 - 18x19 - 20x22 mm
- 9 imbusz kulcs \odot 1,5 - 2 - 2,5 - 3 - 4 - 5 - 6 - 8 - 10 mm
- 6 T - szárú imbusz kulcs műanyag markolattal \odot 2 - 2,5 - 3 - 4 - 5 - 6 mm
- 6 Imbusz csavarhúzókészlet Torx®-csavarokhoz \odot T10 - T15 - T20 - T25 - T27 - T30

Beta-sz.	TR
	42
	T05
	T06
	T80
920A	T80
920ME	T80
920/21	T80
920/22	T80
920/25	T80
920/42	T80
920/55	T80
1048N	T153
1052	T153
1084	T138
1166	T138
1150	T138
1032	T145
1036	T145
1034	T145
1038	T145
35	T234
1370	T234
1390	T234
1260	T208
1262	T208
55	T33
96/SC9	T33
96T	T52
97TTX	T55



T05 T06 T80



T153 T138 T145 T234



T208 T33 T52 T55

Ft

5904VG/2T

680.700 059041191

Készletársítási javaslat RSC51 - RSC23T - RSC24 - RSC24A - RSC24AXL - RSC24AXLP/7 - RSC24AXXL - RSC24L/7 - RSC24L-CAB
RSC28 - C37 - C39 - C39SM - C39MD - C39T - RSC55 - RSC50 2.0 - C59 - C58BC - C57



► Autójavítás

Mennyiség/megnevezés

Mennyiség/megnevezés	Beta-sz.
6 6 darabos kiütőkészlet tartós poliészterből készült összeteketerhető tokban \varnothing 2÷8 mm	31/B6N
1 pontozó \varnothing 5 mm	32
1 erősített laposvágó 200 mm	35
17 csillag-villáskulcs 6÷22 mm	42
8 villáskulcs 6x7 - 8x9 - 10x11 - 12x13 - 14x15 - 16x17 - 18x19 - 20x22 mm	55
9 imbuszkulcs \varnothing 1,5 - 2 - 2,5 - 3 - 4 - 5 - 6 - 8 - 10 mm	96N/SC9
11 T - szárú imbuszkulcs műanyag markolattal \varnothing 2÷10 mm	96T/SP11
13 Torx® imbuszkulcs \varnothing T6÷T50	97TX/B13
1 Állítható villáskulcs 300 mm	111E
13 1/2" - os hatlapú dugókulcs \varnothing 10÷22 mm	920A/SB13
1 1/2"-os toldó 125 mm	920/21
1 1/2"-os toldó 255 mm	920/22
1 1/2"-os csukló	920/25
1 1/2"-os csúszkás T-hajtószerű	920/42
1 1/2"-os átnyomós irányváltós racsnit	920/50
6 csuklós T - kulcs \varnothing 8 - 10 - 12 - 13 - 17 - 19 mm	952
1 szerelővas 450 mm	965
2 egyenes belső Seeger-fogó \varnothing 180 - 225 mm	1032
2 hajlított belső Seeger - fogó \varnothing 170 - 210 mm	1034
2 egyenes külső Seeger-fogó \varnothing 175 - 225 mm	1036
2 hajlított külső Seeger - fogó \varnothing 175 - 220 mm	1038
1 vízpumpafogó 250 mm	1048N
1 Egyenes profajú önzáró fogó 240 mm	1057A
1 erősített oldalcsípőfogó, kétkomponensű markolat ipari kivitel \varnothing 200 mm	1084GBM
1 áttételes homlokcsípőfogó \varnothing 200 mm	1092V
1 bádogos lemezolló 250 mm	1112
1 műszerész olló 147 mm	1128BMX
1 robusztus kombinált fogó kétkomponensű markolat ipari kivitel \varnothing 180 mm	1150GBM
4 csavarhúzó hasítottfejű csavarokhoz \bullet 3x75 - 4x100 - 5,5x125 - 6,5x150 mm	1260
1 Lapos törpe csavarhúzó \bullet 6,5x30 mm	1260N
2 Lapos csavarhúzó, hatlapfejű szárvégzördéssel \bullet 8x175 - 10x200 mm	1260E
3 Phillips®-csavarhúzó \oplus PH0x100 - PH1x120 - PH2x100 mm	1262
1 Csavarhúzó Phillips® - csavarokhoz, extra rövid penge \oplus PH2x30 mm	1262N
1 Csavarhúzó Phillips® - csavarokhoz, hatszögű penge, \oplus PH3x175mm	1262E
1 Csavarhúzó Phillips® - csavarokhoz, hosszú penge \oplus PH2x400 mm	1262L
1 Csavarhúzó hernyócsavarokhoz, hosszú penge \bullet 6,5x400 mm	1264L
1 lakatos kalapács 500 g	1370
1 műanyag kalapács \varnothing 45 mm	1390
1 fémszalagos olajsűrőleszedő	1491
1 Hézagmérő	1708/20
5 5 darabos egyengető reszelő készlet markolattal 200 mm	1719BMA...S5
1 fűrész	1726BM
1 Olajozó fémkanna 200 cc	1751N

Ft



5904VG/3

1.072.000 059041062

Készletársítási javaslat RSC24 - RSC24A - RSC24AXL - RSC24AXLP/7 - RSC24AXXL - RSC24L/7 - RSC24L-CAB
C37 - C39 7 - 8 fiókkal - RSC55 - RSC50 2.0 - C59 - C58BC - C57

5904VG/3T

102 darabos szerszámkészlet ABS hőformált tálcában

► Autójavító

Mennyiség/megnevezés

- 21 csillag-villáskulcs 6-7-8-9-10-11-12-13-14-15-16-17
18-19-20-21-22-24-27-30-32 mm
- 8 villáskulcs 6x7-8x9-10x11-12x13-14x15
16x17-18x19-20x22 mm
- 9 imbuszkulcs \odot 1,5÷10 mm
- 6 T - szárú imbuszkulcs műanyag markolattal \odot 2-2,5-3-4-5-6 mm
- 8 csuklós T - kulcs \odot 7-8-10-12-13-14-17-19 mm
- 19 1/2"-os hatlapú dugókulcs \odot 10-11-12-13-14-15-16-17-18-19
20-21-22-23-24-26-27-30-32 mm
- 1 1/2"-os toldó 125 mm
- 1 1/2"-os toldó 255 mm
- 1 1/2"-os csukló
- 1 1/2"-os csúszkás T-hajtószer 305 mm
- 1 1/2"-os irányváltós racsnit \otimes
- 1 Erősített oldalcsípőfogó ∇ 160 mm
- 1 kombinált fogó \equiv 180 mm
- 1 Egyenes extra hosszú félkerekcsőrű fogó \bullet 160 mm
- 1 egyenes belső Seeger-fogó \odot 180 mm
- 1 hajlított belső Seeger - fogó \odot 170 mm
- 1 egyenes külső Seeger-fogó \bullet 175 mm
- 1 hajlított külső Seeger - fogó \bullet 175 mm
- 1 Egyenes pófájú önzáró fogó 240 mm
- 1 vízpumpa fogó 250 mm
- 7 csavarhúzó hasítottfejű csavarokhoz \bullet 2,5x50 -3x75 - 3,5x100 - 4x125 -5,5x100 - 5,5x150 -
6,5x150 mm
- 6 Phillips®-csavarhúzó \oplus PH0x60 - PH0x100 - PH1x80
PH1x120 - PH2x100 - PH2x150 mm
- 2 erősített laposvágó 100-200 mm
- 1 lakatos kalapács 300 g
- 1 műanyag kalapács \varnothing 35 mm
- 1 Üres hőformált tálcák

Beta-sz.	TR
42	T05
55	T06
	T33
96/SC9	T33
96T	T52
952	T63
920A	T83
920/21	T83
920/22	T83
920/25	T83
920/42	T83
920/55	T83
1084BM	T137
1150BM	T137
1166BM	T137
1032	T145
1034	T145
1036	T145
1038	T145
1052	T153
1048N	T153
1260	T199
1262	T202
35	T234
1370	T234
1390	T234
VP5	



T199 T202 T83



T145 T153 T137 T234



T52 T33 T05 T06



T63 VP5

Ft

5904VG/3T

788.800 059041510

Készletársítási javaslat RSC23T - RSC24 - RSC24A - RSC24AXL - RSC24AXLP/7 - RSC24AXXL - RSC24L/7 - RSC24L-CAB
RSC28 - C37 - C39 - C39MD - C39SM - C39T - RSC55 - RSC50 2.0 - C59 - C58BC - C57

5904VG/5T

153 darabos szerszámkészlet ABS hőformált tálcában

► Autójavító

Mennyiség/megnevezés

- 5 1/2"-os imbusz dugókulcs \odot 5 - 6 - 8 - 10 - 12 mm
- 1 1/2"-os toldó 125 mm
- 1 1/2"-os toldó 255 mm
- 1 1/2"-os csukló
- 1 1/2"-os csúszkás T-hajtószár
- 1 1/2"-os irányváltós racsnik \odot
- 19 1/2"-os hatlapú dugókulcs \odot 10+24 - 26 - 27 - 30 - 32 mm
- 16 csillag-villáskulcs 6+21 mm
- 5 csillag-villáskulcs 22 - 24 - 27 - 30 - 32 mm
- 8 csuklós T - kulcs \odot 7 - 8 - 10 - 12 - 13 - 14 - 17 - 19 mm
- 1 Üres hőformált tálcák
- 1 egyenes belső Seeger-fogó \odot 180 mm
- 1 hajlított belső Seeger - fogó \odot 170 mm
- 1 egyenes külső Seeger-fogó \odot 175 mm
- 1 hajlított külső Seeger - fogó \odot 175 mm
- 7 Csavarhúzó Phillips®-csavarokhoz \bullet 2,5x50 - 3x75 - 3,5x100 - 4x125
5,5x100 - 5,5x150 - 6,5x150 mm
- 5 Imbusz csavarhúzókészlet Torx®-csavarokhoz \odot T25 - T27 - T30 - T40 - T45
- 6 T - szárú imbusz kulcs műanyag markolattal \odot 2 - 2,5 - 3 - 4 - 5 - 6 mm
- 8 villáskulcs 6x7 - 8x9 - 10x11 - 12x13 - 14x15 - 16x17
18x19 - 20x22 mm
- 9 imbusz kulcs \odot 1,5 - 2 - 2,5 - 3 - 4 - 5 - 6 - 8 - 10 mm
- 3 Csavarhúzó Phillips®-csavarokhoz \bullet 8x150 - 8x200 - 10x200 mm
- 2 Csavarhúzó hasítottfejú csavarokhoz, extra rövid penge \bullet 4x30 - 6,5x30 mm
- 6 Csavarhúzó Phillips®-csavarokhoz \oplus PH0x60 - PH0x100 - PH1x80 - PH1x120 - PH2x100 - PH2x150 mm
- 2 Csavarhúzó Phillips®-csavarokhoz \oplus PH3x150 - PH4x200 mm
- 2 Csavarhúzó Phillips®-csavarokhoz, extra rövid penge \oplus PH1x30 - PH2x30 mm
- 2 erősített laposvágó 100 - 200 mm
- 1 lakatos kalapács 300 g
- 1 műanyag kalapács \varnothing 35 mm
- 1 kombinált fogó \equiv 180 mm
- 1 Egyenes extra hosszú félkerékcsőrű fogó \bullet 160 mm
- 1 Erősített oldalcsípőfogó ζ 160 mm
- 6 Torx®-behajtó betét \odot T6+T15
- 8 Torx®-behajtó betét \odot T20+T55
- 1 behajtó betéttartó adapter
- 1 behajtó betéttartó adapter
- 6 1/4"-os Torx®-dugókulcs \odot E4+E10
- 7 1/2"-os Torx®-dugókulcs \odot E12+E24
- 3 1/2"-os Torx®-imbusz-dugókulcs \odot T55L - T60 - T70L
- 1 vízpumpafogó 250 mm
- 1 Egyenes pófájú önzáró fogó 240 mm

Beta-sz.	TR
920ME	T80
920/21	T80
920/22	T80
920/25	T80
920/42	T80
920/55	T80
920A	T80
42	T05
42	T06
952	T63
VP6	VP6
1032	T145
1034	T145
1036	T145
1038	T145
1290	T170
1297TX	T176
96T	T52
55	T33
96N/SC9	T33
1290	T171
1290N	T171
1292	T172
1292	T173
1292N	T173
35	T234
1370	T234
1390	T234
1150BM	T137
1166BM	T137
1084BM	T137
861TX	T112
866TX	T112
895/1	T112
895/6	T112
900FTX	T112
920FTX	T112
920TX	T112
1048N	T153
1052	T153



T80 T05 T06



T63 VP6



T145 T170 T176 T52



T33 T171 T172 T173



T234 T137 T112 T153

Ft

5904VG/5T

1.093.100 059041196

Készletválasztási javaslat RSC24 7 - 8 fiókkal - RSC24A 7 - 8 fiókkal - RSC24AXL 7 - 8 fiókkal - RSC24AXLP/7 - RSC24AXXL - RSC24L/7
RSC24L-CAB - RSC28 - C37 7 - 8 fiókkal - C39 7 - 8 fiókkal - C39MD - C39SM - RSC55 - RSC50 2.0 - C59 - C58BC - C57

5905VG/1

94 darabos szerszámkészlet

► **Autójavítás**

Mennyiség/megnevezés

Beta-sz.

1	kiütő Ø 4 mm	30
6	6 darabos kiütőkészlet tartós poliészterből készült összetekkerhető tokban Ø 2 - 3 - 4 - 5 - 6 - 8 mm	31/B6N
1	pontozó Ø 4 mm	32
1	laposvágó 150 mm	34
1	keresztvágó 150 mm	36
17	csillag-villáskulcs 6÷22 mm	42
10	imbuszkulcs Ø 1,5÷12 mm	96/B10
1	Állítható villáskulcs skálával, foszfátzott 300 mm	111EN
12	Hosszú dugókulcs-csavarhúzó Ø 4÷14 mm	943BX
1	szereelővas 450 mm	965
1	vízpumpafofogó 250 mm	1048N
1	Egyenes pofájú önzáró fogó 240 mm	1052
1	állítható hegesztő fogó alumínium pofával 280 mm	1060AL
1	erősített oldalcsípőfogó, kétkomponensű markolat ipari kivitel 160 mm	1084GBM
1	Rabitz-fogó műanyaggal bevont nyéllel 250 mm	1098PL
1	áttételes egyenes lemezolló	1122
1	műszerész olló 147 mm	1128BMX
1	robustus kombinált fogó kétkomponensű markolat ipari kivitel 180 mm	1150GBM
1	csavarhúzó Dzus® fejú csavarokhoz	1201E/DZ
4	csavarhúzó hasítottfejú csavarokhoz ● 3x75 - 4x100 - 5,5x150 - 6,5x150 mm	1260
1	Lapos törpe csavarhúzó ● 4x30 mm	1260N
2	Lapos csavarhúzó, hatlapfejű szánvégződéssel ● 10x175 - 12x200 mm	1260E
3	Phillips®-csavarhúzó PH0x60 - PH1x80 - PH2x100 mm	1262
1	Csavarhúzó Phillips® - csavarokhoz, extra rövid penge PH1x30 mm	1262N
1	Csavarhúzó Phillips® - csavarokhoz, hatszögű penge, PH3x175 mm	1262E
7	Imbusz csavarhúzó Torx®-csavarokhoz ○ T6 - T8 - T10 - T15 - T20 - T25 - T30	1267TX
1	hajlított egyengető idom 1350 g	1303
1	egyengető idom	1305
1	sarok egyengető idom	1306
1	univerzális idom	1310
1	Konvex és lapostetejű idom	1314
1	kanálvas	1326
1	erősített kanalvas	1327
1	hosszú kettős kanalvas	1330
1	karosszéria reszelő	1338A
1	extra laposvágó	1342PM
1	karosszéria kalapács	1345
1	rovátkás karosszéria kalapács Ø 40 mm	1357Z/45
1	lakatos kalapács 300 g	1370
1	műanyag kalapács Ø 35 mm	1390
1	fékes mérőszalag 5 m	1692



Ft



5905VG/1

969.200 059051058

Készletlátsási javaslat C25



► Autójavítás

Mennyiség/megnevezés

Beta-sz.

6	2 kiütőből, 1 pontozóból, 2 laposvágóból és 1 keresztvágóból álló készlet összetekercselt poliészter tokban	38/B6N
13	csillag-villáskulcs 6+14 - 17 - 19 - 22 - 24 mm	42
13	villáskulcs 6x7 - 8x9 - 10x11 - 12x13 - 14x15 - 16x17 - 18x19 - 20x22 - 21x23 - 24x26 - 25x28 - 27x29 - 30x32 mm	55
3	önindítókulcs 11x13 - 14x17 - 19x22 mm	83
10	imbuszkulcs \odot 1,5+12 mm	96N/B10
6	Imbusz csavarhúzókészlet Torx®-csavarokhoz \odot T10 - T15 - T20 - T25 - T30 - T40	97TTX
2	1/2" - os gépi dugókulcs \odot 17 - 19 mm	720
20	1/2"-os hatlapú dugókulcs \odot 10+24 - 26 - 27 - 28 - 30 - 32 mm	920A
1	1/2"-os toldó 125 mm	920/21
1	1/2"-os toldó 255 mm	920/22
1	1/2"-os csukló	920/25
1	1/2"-os csúszkás T-hajtószár	920/42
1	1/2"-os irányváltós racsnit \odot	920/55
8	csuklós T - kulcs \odot 7 - 8 - 10 - 11 - 13 - 14 - 17 - 19 mm	952
1	hosszú csuklós T - szárú gyertyakulcs	959
1	keresztkulcs \odot 17x19x22x \blacksquare 1/2"	979
1	egyenes belső Seeger-fogó \odot 180 mm	1032
1	hajlított belső Seeger - fogó \odot 170 mm	1034
1	egyenes külső Seeger-fogó \bullet 175 mm	1036
1	hajlított külső Seeger - fogó \bullet 175 mm	1038
1	vízpumpafogó 250 mm	1048N
1	Egyenes pófajú önzáró fogó 240 mm	1052
1	erősített oldalcsípőfogó, kétkomponensű markolat ipari kivitel \ddagger 160 mm	1084GBM
1	áttételes egyenes lemezolló 250 mm	1122
1	műszerész olló 147 mm	1128BMX
1	robustus kombinált fogó kétkomponensű markolat ipari kivitel \equiv 180 mm	1150GBM
1	egyenes extra hosszú félkerekcsőrű fogó, kétkomponensű markolat ipari kivitel \bullet 160 mm	1166GBM
8	csavarhúzó hasítottfejű csavarokhoz \bullet 2,5x50 - 3x75 - 3,5x100 - 4x125 - 5,5x125 - 6,5x150 - 8x200 - 10x200 mm	1260
2	Lapos csavarhúzó, hatlapfejű szárvégzöldéssel \bullet 10x200 - 12x250 mm	1260E
1	Lapos törpe csavarhúzó \bullet 6,5x30 mm	1260N
4	Phillips®-csavarhúzó \odot PH0x60 - PH1x80 - PH2x100 - PH3x150 mm	1262
1	lakatos kalapács 400 g	1370
1	műanyag kalapács \odot 35 mm	1390
1	fémzalagos olajsűrűledő	1491
1	mérőműszer 3+48 V	1498

Ft



5905VG/2

909.000 059051044

Készletársítási javaslat C25

► Autójavító

Mennyiség/megnevezés

- 16 csillag-villáskulcs 6+21 mm
- 5 csillag-villáskulcs 22 - 24 - 27 - 30 - 32 mm
- 5 hosszú kiütő Ø 2 - 3 - 4 - 5 - 6 mm
- 1 pontozó Ø 4 mm
- 12 villáskulcs 6x7 - 8x9 - 10x11 - 12x13 - 14x15 - 16x17 - 18x19 - 20x22 - 21x23 - 24x26 - 27x29 - 30x32 mm
- 9 imbuszkulcs Ø 1,5 - 2 - 2,5 - 3 - 4 - 5 - 6 - 8 - 10 mm
- 5 1/2"-os imbusz dugókulcs Ø 5 - 6 - 8 - 10 - 12 mm
- 1 1/2"-os toldó 125 mm
- 1 1/2"-os toldó 255 mm
- 1 1/2"-os csukló
- 1 1/2"-os csúszkás T-hajtósár
- 1 1/2"-os irányváltós racsnit
- 19 1/2"-os hatlapú dugókulcs Ø 10+24 - 26 - 27 - 30 - 32 mm
- 1 egyenes belső Seeger-fogó Ø 180 mm
- 1 hajlított belső Seeger - fogó Ø 170 mm
- 1 egyenes külső Seeger-fogó Ø 175 mm
- 1 hajlított külső Seeger - fogó Ø 175 mm
- 1 egyenes belső Seeger-fogó Ø 140 mm
- 1 egyenes belső Seeger-fogó Ø 225 mm
- 1 egyenes külső Seeger-fogó Ø 140 mm
- 1 egyenes külső Seeger-fogó Ø 225 mm
- 9 csavarhúzó hasítottfejű csavarokhoz Ø 3x75 - 3x100 - 4x100 - 4x150 - 5,5x100 - 5,5x150 - 6,5x150 - 8x150 - 10x200 mm
- 2 Lapos törpe csavarhúzó Ø 4x30 - 6,5x30 mm
- 7 Phillips®-csavarhúzó PH0x60 - PH0x100 - PH1x80 - PH1x120 - PH2x100 - PH2x150 - PH3x150 mm
- 2 Csavarhúzó Phillips® - csavarokhoz, extra rövid penge PH1x30 - PH2x30 mm
- 2 csuklós T - kulcs Ø 7 - 8 - 10 - 12 - 13 - 14 - 17 - 19 mm
- 2 Csavarhúzó Phillips® - csavarokhoz, hosszú penge PH1x400 - PH2x400 mm
- 3 Csavarhúzó hernyócsavarokhoz, hosszú penge Ø 3x300 - 4x400 - 5x400 mm
- 6 Imbusz csavarhúzókészlet Torx®-csavarokhoz T10-T15-T20-T25-T27-T30
- 12 1/2" - os gépi dugókulcs Ø 10-13-17-18-19-21-22-24-27-30-32 mm
- 1 1/2"-os toldó 125 mm
- 3 Ø 17-19-21
- 5 1/2"-os színes hatszögű csavarhúzóbetét Ø 5L - 6L - 7L - 8L - 10L
- 4 1/2"-os Torx®-imbusz-dugókulcs T40L - T45L - T55L - T70L
- 3 1/2"-os XZN®-profilú imbusz-dugókulcs, krómzott, barnított fej Ø M6L - M8L - M12L
- 5 reszelő 200 mm
- 1 fémszalagos olajszűrőleszedő 110 mm
- 1 Olajleeresztő dugókulcs-betét, négyszög 10 mm
- 7 Olajleeresztő dugókulcs-betét, külső hatszög Ø 8-9-10-11-12-14-17 mm
- 4 Olajleeresztő dugókulcs-betét, külső négyszög Ø 8-9,5-12-13 mm
- 1 Olajleeresztő dugókulcs-betét, külső háromszög Δ 9,5 mm
- 1 Olajleeresztő dugókulcs-betét XZN®-csavarokhoz Ø M 16
- 1 Olajleeresztő kulcs 8 x 10 mm
- 2 erősített laposvágó 100 - 200 mm
- 1 lakatos kalapács 300 g
- 1 műanyag kalapács Ø 35 mm
- 1 vízpumpafogó 250 mm
- 1 Egyenes pófájú önzáró fogó 240 mm
- 1 kombinált fogó 180 mm
- 1 Egyenes extra hosszú félkerékcsőrű fogó Ø 160 mm
- 1 Erősített oldalcsípőfogó 160 mm
- 11 3/4" - os hatlapú dugókulcs Ø 22-24-27-30-32-34-36-38-41-46-50 mm
- 1 3/4" - os toldó 200 mm
- 1 3/4" - os toldó 380 mm
- 1 3/4" - os csúszkás T - hajtósár 450 mm
- 1 3/4" - os irányváltós racsnit
- 1 Üres hőformált tálcák
- 4 imbuszkulcs Ø 13-14-17-19 mm
- 1 Állítható villáskulcs 300 mm
- 1 szerelővas
- 1 bádogos lemezolló 250 mm
- 1 műszerész olló 147 mm
- 1 lakatos kalapács 1000 g
- 1 Hézagmérő
- 1 flexibilis teleszkópos mágneses csavarkiszedő
- 1 teleszkópos vizsgáló tűkőr
- 1 háromélű hántoló 200 mm
- 1 fűrész 440 mm
- 1 Acél drótkéfe
- 1 Olajozó fémkanna 200 cl
- 1 dekorkés 170 mm

Beta-sz.	TR
42	T05
42	T06
31	T31
32	T31
55	T31
96N/SC9	T31
920ME	T80
920/21	T80
920/22	T80
920/25	T80
920/42	T80
920/55	T80
920A	T80
1032	T145
1034	T145
1036	T145
1038	T145
1032	T146
1032	T146
1036	T146
1036	T146
1260	T167
1260N	T167
1262	T168
1262N	T168
952	T63
1262L	T209
1264L	T209
97TTX	T55
720	T111
720/21	T111
720LC	T111
920PE	T113
920TX	T113
920XZN	T113
1719BMA8/S5	T236
1491	T264
1494	T264
1494E	T264
1494Q	T264
1494T	T264
1494XZN	T264
1496C	T264
35	T234
1370	T234
1390	T234
1048N	T153
1052	T153
1150	T138
1166	T138
1084	T138
928A	T105
928/21	T106
928/22	T106
928/42	T106
928/55	T106
VP6	VP6
96N	VP6
111E	VP6
965	VP6
1112	VP6
1128BMX	VP6
1370	VP6
1708/20	VP6
1712	VP6
1715	VP6
1717B	VP6
1726	VP6
1737NX	VP6
1751N	VP6
1771	VP6

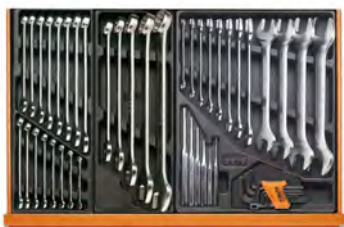

T05 T06 T31



T80 T145 T146



T167 T168 +96N +1771



T63 T209



T55 T111 T113 T236



T264 T234 T153 T138



T105 T106 VP6



Ft

5908VG/2T

1.840.100 059081017

Készletlátsítási javaslat RSC28

5935VG/1MB

98 darabos szerszámkészlet a C35 szerszámszekrényhez habszivacs tálcában



MB12



MB39



MB46

► Autójavító

Mennyiség/megnevezés

- 21 csillag-villáskulcs 6-7-8-9-10-11-12-13-14-15-16-17-18-19-20-21-22-24-27-30-32 mm
- 8 villáskulcs 6x7-8x9-10x11-12x13-14x15
16x17-18x19-20x22 mm
- 1 vízpumpafogó 250 mm
- 4 csavarhúzó hasítottfejú csavarokhoz ● 3x75-4x100-5x125-6,5x150 mm
- 3 Phillips®-csavarhúzó ● PH0x60-PH1x80-PH2x100 mm
- 6 Imbusz csavarhúzó Torx®-csavarokhoz ● T8-T10-T15-T20-T25-T30
- 9 Hajlított gömbfejú imbuszkulcs ○
- 6 T - szárú imbuszkulcs műanyag markolattal ○ 2-2,5-3-4-5-6
- 1 Egyenes pofájú önzáró fogó 240 mm
- 19 1/2"-os hatlapú dugókulcs ○ 10-11-12-13-14-15-16-17-18-19-20-21-22-23-24-26-27-30-32 mm
- 1 1/2"-os toldó 125 mm
- 1 1/2"-os toldó 250 mm
- 1 1/2"-os csukló
- 1 1/2"-os csúszkás T-hajtószár
- 1 1/2"-os irányváltós racsnit
- 5 1/2"-os színes hatszögű csavarhúzóbetét ○ 5-6-8-10-12 mm
- 1 egyenes belső Seeger-fogó ○ 180 mm
- 1 hajlított belső Seeger - fogó ○ 170 mm
- 1 egyenes külső Seeger-fogó ● 175 mm
- 1 hajlított külső Seeger - fogó ● 175 mm
- 1 erősített laposvágó 200 mm
- 1 Erősített oldalcsipőfogó ≤ 160 mm
- 1 kombinált fogó = 180 mm
- 1 Egyenes extra hosszú félkerékcsoőrű fogó ● 160 mm
- 1 lakatos kalapács 500 g
- 1 műanyag kalapács Ø 35 mm

Beta-sz.	TR
42	MB12
55	MB12
1048N	MB12
1260	MB46
1262	MB46
1267TX	MB46
96BPC/SC9	MB46
96T	MB46
1052	MB46
920A	MB39
920/21	MB39
920/22	MB39
920/25	MB39
920/42	MB39
920/55	MB39
920PE	MB39
1032	MB39
1034	MB39
1036	MB39
1038	MB39
35	MB39
1084BM	MB39
1150BM	MB39
1166BM	MB39
1370	MB39
1390	MB39

Ft

5935VG/1MB 806.700 059351321

Készletársítási javaslat C35

5940SBK

125 darabos szerszámkészlet

► Motorjavítás

Mennyiség/megnevezés

- 1 kiütő Ø 2 mm
- 1 pontozó Ø 4 mm
- 1 laposvágó 125 mm
- 10 csillag-villáskulcs 6 - 7 - 8 - 10 - 11 - 12 - 13 - 14 - 17 - 19 mm
- 6 villáskulcs 6x7 - 8x9 - 10x11 - 12x13 - 14x15 - 16x17 mm
- 9 imbuszkulcs ○ 1,5 - 2 - 2,5 - 3 - 4 - 5 - 6 - 8 - 10 mm
- 1 ZERO-RESET kioldó nyomatékcsukló ● 3/8", 10±5 Nm
- 54 52 hatszögű csavarhúzóbetét, 10 mm és 2 tartozék
- 17 12 dugókulcs és 5 tartozék
- 1 Szűkítő közbetét, belső 1/2", külső 3/8"
- 2 Gyertya-dugókulcs ○ 14 - 16 mm
- 1 Extra hosszú félkerékcsoőrű műszerészfogó ● 283 mm
- 2 egyenes belső Seeger-fogó ○ 140 - 180 mm
- 1 egyenes külső Seeger-fogó ● 140x1,3 mm
- 1 oldalcsipőfogó, csúszásmentes kétrétegű PVC bevonatú markolat ipari kivitel ≤ 160 mm
- 1 Egyenes élű műszerész olló 145 mm
- 1 robusztus kombinált fogó csúszásmentes kétrétegű PVC bevonatú markolat ipari kivitel = 180 mm
- 1 csavarhúzó Dzus® fejú csavarokhoz ●
- 4 csavarhúzó hasítottfejú csavarokhoz ● 3x75 - 4x100 - 5,5x100 - 6,5x150 mm
- 3 csavarhúzó keresztfejú Phillips® csavarokhoz ● PH0x60 - PH1x80 - PH2x100 mm
- 1 Fáziskereső ●
- 1 lakatos kalapács 300 g
- 1 fémszalagos olajsűrűleszedő
- 1 Hézagmérő
- 1 Mini fűrés
- 1 sárgaréz drótkefe
- 1 pumpás műanyag olajozó kanna 250 cc

Beta-sz.	TR
30	
32	
34	
42	
55	
96/SC9	
666/5	
867/C52	
920A/C12X	
910/16	
956C	
1009/LA	
1032	
1036	
1082G	
1128BM	
1150G	
1201E/DZ	
1201E	
1202E	
1254	
1370	
1491	
1708/13	
1725CR	
1737	
1754	

Ft

5940SBK 579.800 059401082

A C41S - C41H - C42S - C42H - C42S - C41S szerszámkocsikhoz ajánlott készlet

5941VU/M

64 szerszámból álló autójavító készlet a C41H húzható szerszámkocsihoz habszivacs tálcában

► Univerzális alkalmazás

Mennyiség/megnevezés

- 16 csillag-villáskulcs 6-7-8-9-10-11-12-13-14-15-16-17-18-19-21-22 mm
- 9 imbuszkulcs 1,5-2-2,5-3-4-5-6-8-10 mm
- 1 fékes mérőszalag 5 m
- 19 1/2"-os hatlapú dugókulcs 10-11-12-13-14-15-16-17-18-19-20-21-22-23-24-26-27-30-32 mm
- 1 1/2"-os csukló
- 1 1/2"-os csúszkás T-hajtószár
- 1 1/2"-os irányváltós racsnit
- 2 1/2" Gömbvégű toldó 125-250 mm
- 1 Állítható villáskulcs 250 mm
- 1 vízpumpafogó 250 mm
- 1 Oldalsípőfogó, kétkomponensű markolat ipari kivitel 160 mm
- 1 műszerész olló 147 mm
- 1 robusztus kombinált fogó kétkomponensű markolat ipari kivitel 180 mm
- 1 egyenes extra hosszú félkerekcsőrű fogó, kétkomponensű markolat ipari kivitel 160 mm
- 3 csavarhúzó hasítottfejű csavarokhoz 3,5x100-5,5x125-6,5x150 mm
- 3 Phillips®-csavarhúzó PH0-PH1-PH2
- 1 lakatos kalapács 300 g
- 1 dekorkés 170 mm

Beta-sz.	TR
42	MC12
96/SC9	MC12
1692/5	MC12
920A	MC21
920/25	MC21
920/42	MC21
920/55	MC21
920AN	MC21
111E	
1048N	
1082GBM	
1128BMX	
1150GBM	
1166GBM	
1260	
1262	
1370	
1771	



MC21



MC12



5941VU/M

Ft

401.200 059411002

A C41 szerszámkocsihoz ajánlott készlet

Beta

► **Univerzális alkalmazás**

Mennyiség/megnevezés

- 21 csillag-villáskulcsok 6-7-8-9-10-11-12-13-14-15-16-17-18-19-20-21-22-24-27-30-32 mm
- 9 Hajlított gömbfejű imbuszkulcs \odot 1,5-2-2,5-3-4-5-6-8-10 mm
- 1 behajtó betéttartó adapter \square 1/4 - \square 1/4
- 1 behajtó betéttartó adapter \square 1/4 - \square 3/8
- 1 behajtó betéttartó adapter \square 5/16 - \square 1/2
- 13 1/4"-os hatlapú dugókulcs \odot 4-4,5-5-5,5-6-7-8-9-10-11-12-13-14 mm
- 9 \odot 5-6-7-8-9-10-11-12-13 mm
- 5 1/4"-os imbusz-dugókulcs \odot 3-4-5-6-7 mm
- 4 csavarhúzó-dugókulcs hasítottfejű csavarokhoz, krómozott, barnított hegy \bullet 0,8x4-1x5,5x1,2x6,5-1,2x8 mm
- 4 csavarhúzó-dugókulcs Phillips®-csavarokhoz, krómozott, barnított hegy \bullet PH1-PH2-PH3-PH4
- 7 1/4"-os Torx®-imbusz dugókulcs, krómozott, fekete hegyek \odot T10-T15-T20-T25-T27-T30-T40
- 1 Bővítő közbetét 1/4" - 3/8" \square 1/4 - \blacksquare 3/8
- 1 1/4" - os toldó 50 mm
- 1 1/4" - os toldó 100 mm
- 1 1/4" - os toldó 150 mm
- 1 1/4"-os csukló
- 1 1/4"-os hajtószár 176 mm
- 1 1/4"-os csúszkás T-hajtószár 115 mm
- 1 1/2"-os irányváltós racsnit \odot 125 mm
- 17 Hatlapú dugókulcs 3/8" \odot 6-7-8-9-10-11-12-13-14-15-16-17-18-19-20-21-22 mm
- 1 Szűkítő közbetét 3/8" és 1/4" \square 3/8 - \blacksquare 1/4
- 1 Szűkítő közbetét, belső 1/2", külső 3/8" \square 3/8 - \blacksquare 1/2
- 1 Toldó - 3/8" 125 mm
- 1 Toldó - 3/8" 250
- 1 Csukló 3/8"
- 1 Csúszkás T - hajtószár 3/8" 210 mm
- 1 3/8" irányváltós racsnit \odot 200 mm
- 21 1/2"-os hatlapú dugókulcs \odot 8-10-11-12-13-14-15-16-17-18-19-20-21-22-23-24-26-27-28-30-32 mm
- 1 szűkítő közbetét 1/2" és 3/8" \square 1/2 - \blacksquare 3/8
- 1 1/2"-os csukló
- 1 1/2" Gömbvégű toldó 125 mm
- 1 1/2" Gömbvégű toldó 250 mm
- 1 1/2"-os csúszkás T-hajtószár 305 mm
- 1 1/2"-os irányváltós racsnit \odot 275 mm
- 3 3/8" - os gyertya - dugókulcs \odot 16 mm (5/8")-17,8 (11/16")-20,8 (13/16")
- 6 csavarhúzó hasítottfejű csavarokhoz \bullet 04x2,5x50-0,5x3x75-0,8x4x100-1,0x5,5x125-1,2x6,5x150-1,2x8x200 mm
- 1 csavarhúzó hasítottfejű csavarokhoz, extra rövid \bullet 0,8x4x30 mm
- 4 csavarhúzó keresztfejű Phillips® csavarokhoz \oplus PH0x60-PH1x80PH2x100PH3x150 mm
- 1 csavarhúzó keresztfejű Phillips® csavarokhoz, extra rövid \oplus PH1x30 mm
- 12 imbusz-csavarhúzó Torx®-csavarokhoz \odot T06-T07-T08-T09-T10-T15-T20-T25-T27-T30-T40-T45
- 1 Fáziskereső \bullet 0,5x3,5x100 mm
- 1 egyenes belső Seeger-fogó \odot 180 mm
- 1 hajlított belső Seeger - fogó \odot 170 mm
- 1 egyenes külső Seeger-fogó \bullet 175 mm
- 1 hajlított külső Seeger - fogó \bullet 175 mm
- 1 vízpumpafogó 250 mm
- 1 Egyenes pófajú önzáró fogó 240 mm
- 1 Egyenes pófajú önzáró fogó 240 mm
- 1 Oldalsípőfogó \ddagger 160 mm
- 1 Rábitz-fogó, lakkozott 220 mm
- 1 Egyenes élű műszerész olló 145 mm
- 1 kombinált fogó \equiv 180 mm
- 1 Egyenes extra hosszú félkerekcsőrű fogó \bullet 160 mm
- 3 kiütő \emptyset 2-3-4 mm
- 6 hosszú kiütő \emptyset 2-3-4-5-6-8 mm
- 1 pontozó \emptyset 4 mm
- 1 laposvágó 150 mm
- 2 erősített laposvágó 200-250 mm
- 1 keresztvágó 125 mm
- 1 lakatos kalapács 500 g
- 1 műanyag kalapács \emptyset 35 mm
- 1 fékes mérőszalag 3 m
- 1 flexibilis teleszkópos mágneses csavarkiszedő
- 1 szögletes egyengető reszelő markolattal 200 mm
- 1 háromszög egyengető reszelő markolattal 200 mm
- 1 lapos egyengető reszelő markolattal 200 mm
- 1 félkerek egyengető reszelő markolattal 200 mm
- 1 kerek egyengető reszelő markolattal 200 mm
- 1 Acél drótkefe
- 1 dekorkés 170 mm

Beta-sz.	TR
	42
	MM11
96BPC/SC9	MM11
895/1	MM105
895/3	MM105
895/6	MM105
900	MM105
900L	MM105
900ME	MM105
900LP	MM105
900PH	MM105
900TX	MM105
900/16	MM105
900/20	MM105
900/20L	MM105
900/21	MM105
900/25	MM105
900BG/30	MM105
900/42	MM105
900/55	MM105
910A	MM105
910/15	MM105
910/16	MM105
910/21	MM105
910/22	MM105
910/25	MM105
910/42	MM105
910/55	MM105
920A	MM105
920/15	MM105
920/25	MM105
920AN	MM105
920AN	MM105
920/42	MM105
920/55	MM105
956E	MM105
1201E	MM210
1202E	MM210
1202EN	MM210
1207E/TX	MM210
1253	MM210
1032	MM129
1034	MM129
1036	MM129
1038	MM129
1048N	MM129
1052	MM129
1052	MM129
1082BM	MM129
1098	MM129
1128BM	MM129
1150BM	MM129
1166BM	MM129
30	MM230
31	MM230
32	MM230
34	MM230
35	MM230
36	MM230
1370	MM230
1390	MM230
1692	MM230
1712TF	MM230
1719BMA...Q	MM230
1719BMA...T	MM230
1719BMA...P	MM230
1719BMA...M	MM230
1719BMA...R	MM230
1737NX	MM230
1771	MM230



MM11



MM105



MM129



MM210



MM230

Ft

5945VUM 1.254.700 059451011

A készletet a C45 termékkel együtt ajánljuk

5954VG

138 darabos szerszámkészlet

► Autójavítás**Mennyiség/megnevezés****Beta-sz.**

5	hosszú kiütő Ø 2-3-4-5-6 mm	31
1	pontozó Ø 4 mm	32
1	laposvágó 125 mm	34
18	csillag-villáskulcs 6+22 - 24 mm	42
8	villáskulcs 6x7 - 8x9 - 10x11 - 12x13 - 14x15 - 16x17 - 18x19 - 20x22 mm	55
3	hajlított csillagkulcs 12x13 - 14x15 - 17x19 mm	90
13	imbuszkulcs Ø 2+10 - 12 mm	96
4	1/2" - os gépi dugókulcs Ø 17 - 19 - 21 - 22 mm	720
20	1/2"-os hatlapú dugókulcs Ø 10-11-12-13-14-15-16-17-18-19-20-21-22-23-24-26-27-28-30-32 mm	920A
1	1/2"-os toldó	920/21
1	1/2"-os toldó	920/22
1	1/2"-os csukló	920/25
1	1/2"-os csúszkás T-hajtósár	920/42
1	1/2"-os irányváltós racsnit	920/55
3	Hosszú dugókulcs-csavarhúzó Ø 8 - 10 - 13 mm	943BX
10	csuklós T - kulcs Ø 6 - 7 - 8 - 10 - 11 - 12 - 13 - 14 - 17 - 19 mm	952
3	Gyertya-dugókulcs Ø 16 - 17,8 - 20,8 mm	956C
1	szereelővas	964
1	egyenes belső Seeger-fogó	1032
1	hajlított belső Seeger - fogó	1034
1	egyenes külső Seeger-fogó	1036
1	hajlított külső Seeger - fogó	1038
1	vízpumpafogó 250 mm	1048N
1	Egyenes pofájú önzáró fogó 240 mm	1052
1	állítható hosszúcsőrű önzárófogó 175 mm	1058
1	Oldalsípőfogó 160 mm	1082BM
1	műszerész olló 147 mm	1128BMX
1	kombinált fogó 180 mm	1150BM
1	Egyenes extra hosszú félkerekcsőrű fogó 160 mm	1166BM
1	Fáziskereső 6+24V	1254
1	csavarhúzó hasítottfejű csavarokhoz 8 x 200 mm	1260
1	Lapos törpe csavarhúzó 6,5x30 mm	1260N
1	Phillips®-csavarhúzó 8 x 150 mm	1262
1	Csavarhúzó Phillips® - csavarokhoz, extra rövid penge PH2x30 mm	1262N
5	Imbusz csavarhúzó Torx®-csavarokhoz T8 - T10 - T15 - T20 - T25	1267TX
8	csavarhúzókészlet	1263/D8
1	lakatos kalapács 300 g	1370
1	ütésselnyelő műanyag kalapács Ø 35 mm	1392
1	fékrugófogó 210 mm	1470
1	saruzófogó	1603
1	fékes mérőszalag 5 m	1692
1	Hézagmérő	1708/20
1	flexibilis mágneses csavarkiszedő 1,8 kg	1712E/2
6	Tűreszelők 160 mm	1720/B6
1	pumpás műanyag olajozó kanna 150 cc	1754

**Ft**

5954VG

1.073.400 059541054

Készletlátsítási javaslat C54VG



► Autójavítás

Mennyiség/megnevezés

Mennyiség/megnevezés	Beta-sz.
6 Hosszú kiütő Ø 2 - 3 - 4 - 5 - 6 - 8 mm	31/SP6
6 2 kiütő, 1 pontozó, 3 hidegvágó	38/SP6
17 csillag-villáskulcs 6-7-8-10-11-12-13-14-15-16-17-19-21-22-24-27-30 mm	42
12 villáskulcs 6x7 ÷ 30x32 mm	55/S12X
8 T - szárú imbuszkulcs műanyag markolattal 2 ÷ 10 mm	96T/S8
1 imbuszkulcs Ø 2,5 ÷ 12 mm	96N/G7
8 8 részes hajlítot Torx® imbuszkulcs szerszám készlet T9 ÷ T40	97TX/SC8
5 XZN®-profilú imbuszkulcs, nikkelezett Ø M5 ÷ M12	98XZN/B5
1 Állítható villáskulcs 250 mm	111E
1 ZERO-RESET kioldó nyomatékkulcsok @ 1/2", 40÷200 Nm	666/20
13 1/2" - os hatlapú dugókulcs Ø 10÷22 mm	920A/SB13
8 1/2" - os hatlapú dugókulcs Ø 23÷32 mm	920A/SB8
4 1/2" - os csavarhúzó dugókulcs ● 1,2x6,5 - 1,2x8 - 1,6x9 - 2x12 mm	920LP
3 1/2" - os Phillips® csavarhúzó dugókulcs ⚙ PH2 - 3 - 4	920PH
1 1/2"-os toldó 125 mm	920/21
1 1/2"-os toldó 255 mm	920/22
1 1/2"-os csukló	920/25
1 1/2"-os csúszkás T-hajtószer	920/42
1 1/2"-os irányváltós racsnit	920/55
2 1/2" - os gépi dugókulcs Ø 17 - 19 mm	720
10 csuklós T - kulcs Ø 7 - 8 - 10 - 11 - 12 - 13 - 14 - 15 - 17 - 19 mm	952
3 hosszú csuklós T - szárú gyertyakulcs 14 - 16 - 20,8 mm	959
1 egyenes feszítővas	963
1 keresztkulcs Ø 1/2" - 17 - 19 - 22 mm	979
2 egyenes belső Seeger-fogó Ø 140 - 180 mm	1032
2 hajlítot belső Seeger - fogó Ø 130 - 170 mm	1034
2 egyenes külső Seeger-fogó ● 140x1,3 - 175 mm	1036
2 hajlítot külső Seeger - fogó ● 135x1,3 - 175 mm	1038
1 vízpumpafogó 250 mm	1048N
1 Egyenes pófajú önzáró fogó 240 mm	1052
1 Oldalsípófogó ⚡ 160 mm	1082BM
1 Erősített oldalsípófogó ⚡ 160 mm	1084BM
1 áttételes homlokcsípőfogó ⚡ 180 mm	1092V
1 bádogos lemezolló 250 mm	1112
1 műszerész olló 147 mm	1128BMX
1 kombinált fogó ≡ 180 mm	1150BM
1 Egyenes extra hosszú félkerekcsőrű fogó ● 160 mm	1166BM
1 Hajlítot extra hosszú félkerekcsőrű fogó ● 200 mm	1168BM
2 csavarhúzó hasítottfejú csavarokhoz ● 8x200 - 10x200 mm	1260
1 Phillips®-csavarhúzó ⚙ PH3x150 mm	1262
8 csavarhúzókészlet	1263/D8
2 lakatos kalapács 300 - 600 g	1370
1 műanyag kalapács Ø 35 mm	1390
11 M5÷M16 mm	1433/C11
1 fémszalagos olajsűrűleszedő	1491
1 mérőműszer	1498
1 fékes mérőszalag 5 m	1692
1 Hézagmérő	1708/20
1 flexibilis mágneses csavarkiszedő 1,8 kg	1712E/2
1 kétélű hántoló 200 mm	1717A
1 háromélű hántoló 200 mm	1717B
5 reszelő 200 mm	1719BMA8/S5
1 fűrész	1725
1 pumpás fém olajozó kanna 200 cc	1751
1 dekorkés 170 mm	1771BM
1 tolómérő	1650

Ft



5957VG

1.866.300 059571007



HABSZIVACS TÁLCÁK M-SZÉRIA



RSC23T
RSC24
RSC24A
RSC24AXL
RSC24AXLP/7
RSC24AXXL
RSC24L/7
RSC24L-CAB
RSC28
C30M
C37
C37A
C39
C39T
C39MD
C39SM
RSC51
C57S
C58BC
C59
RSC55
RSC50 2.0

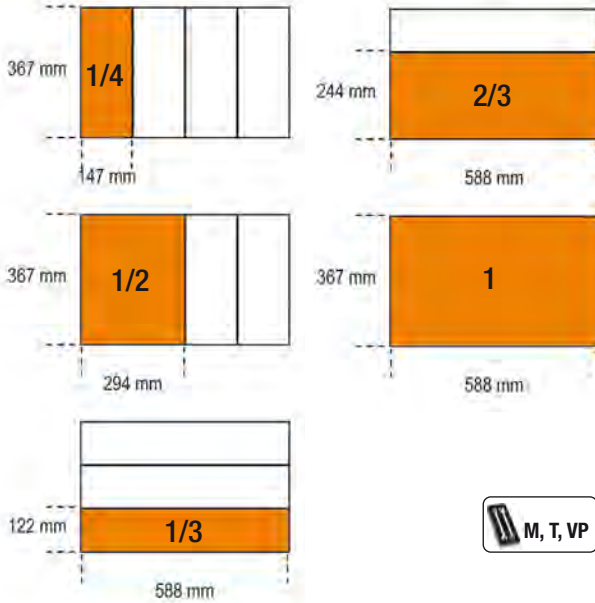

M, T, VP

544÷554
560÷568

M13



42SLIM 8-10-11-12
13-14-15-16-17
18-19 mm

1,2 kg



	Ft	
M13	73.650	1 024500013
MV13	16.000	1 024510013

M25

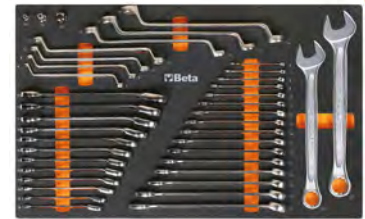

42 6-7-8-9-10-11-12-13-14-15-16-17-18-19-21-22-24-27 mm
90 6x7-8x9-10x11-12x13-14x15-16x17-18x19 mm
123Q1/4
123Q3/8
123Q1/2
142 8-9-10-11-12-13-14-15-16-17-18-19 mm

5,1 kg



	Ft	
M25	323.700	1 024500025
MV25	30.750	1 024510873

M30



55 6x7-8x9-10x11-12x13-14x15-16x17-18x19-20x22-21x23-24x27-30x32 mm
90 6x7-8x9-10x11-12x13-14x15-16x17-18x19-20x22-21x23-24x27-30x32 mm
96BPC/SC9 1,5-2-2,5-3-4-5-6-8-10 mm

4,2 kg



	Ft	
M30	187.500	1 024500030
MV30	30.750	1 024510030

M01



42 6-7-8-9-10-11-12-13-14-15-16-17-18-19-20-21-22-24-27-30-32-36 mm

4,5 kg



	Ft	
M01	201.200	1 024500001
MV10	30.750	1 024510010

M02



42 6-7-8-9-10-11-12-13-14-15-16-17-18-19-20-21-22-23-24-25-26-27-28-29-30-32 mm

6,3 kg



	Ft	
M02	227.800	1 024500002
MV02	30.750	1 024510002

M05



42 6-7-8-9-10-11-12-13-14-15-16-17-18-19-20-21 mm

1,5 kg



	Ft	
M05	99.150	1 024500005
MV15	16.000	1 024510015

M06



42 22-24-27-30-32 mm

2,1 kg



	Ft	
M06	70.250	1 024500006
MV16	21.850	1 024510016



Beta

M32

27



42AS 1/4 - 9/32 - 5/16 - 3/8 - 7/16 - 1/2 - 9/16 - 19/32 - 5/8 - 11/16 - 3/4 - 13/16 - 7/8 - 15/16 - 1 - 1.1/16 - 1.1/8 - 1.1/4

96BP/AS-SC9 1/16 - 3/32 - 1/8 - 5/32 - 3/16 - 7/32 - 1/4 - 5/16 - 3/8

4,5 kg

	Ft		
M32	196.000	1	024500032
MV31	30.750	1	024510031

M33

17



55 6x7-8x9-10x11
12x13-14x15
16x17-18x19
20x22 mm
96/SC9 1,5+10 mm

1,1 kg

	Ft		
M33	45.500	1	024500033
MV33	16.000	1	024510033

M38

4



55 21x23-24x26
27x29-30x32 mm

1,7 kg

	Ft		
M38	38.350	1	024500038
MV38	21.850	1	024510038

M40

7



90 6x7-8x9-10x11
12x13-14x15
16x17-18x19 mm

810 g

	Ft		
M40	50.600	1	024500040
MV40	16.000	1	024510040

M44

12



141 8-9-10-11-12
13-14-15-16
17-18-19 mm

1,3 kg

	Ft		
M44	128.000	1	024500044
MV44	16.000	1	024510044



Beta

M45

12



142 8-9-10-11-12
13-14-15-16
17-18-19 mm

1,3 kg

	Ft		
M45	145.700	1	024500045
MV45	16.000	1	024510045

M46

12



142SN 8-9-10-11-12
13-14-15-16
17-18-19 mm

1,4 kg

	Ft		
M46	171.800	1	024500046
MV46	16.000	1	024510046

M49

24



52MQ 7 - 8 - 10 - 11 - 12 - 13 - 14 - 15 - 16 - 17 - 19 - 22 mm
89MQ 7 - 8 - 10 - 11 - 12 - 13 - 14 - 15 - 16 - 17 - 19 - 22 mm

3,3 kg

	Ft		
M49	522.100	1	024500049
MV49	30.750	1	024510049

M50

8



96T 2-2,5-3-4-5
6-7-8 mm

1,1 kg

	Ft		
M50	59.100	1	024500050
MV50	21.850	1	024510051

M52

5



96T 2,5-3-4-5-6 mm

330 g



M52	Ft 34.950	1 024500052
MV52	16.000	1 024510052

M53

5



96TBP 2,5-3-4-5-6 mm

350 g



M53	Ft 37.000	1 024500053
MV52	16.000	1 024510052

M55

5



97TTX T10-T15-T20-T25-T30

330 g



M55	Ft 38.800	1 024500055
MV55	16.000	1 024510055



M60

23



96T 2-2,5-3-4-5-6-7-8-10 mm
 97BTX/SC8 T9-T10-T15-T20-T25-T27-T30-T40
 944BX 5-6-7-8-10-13 mm

1,9 Kg



M60	Ft 172.400	1 024500060
MV60	30.750	1 024510060

M62

21



97TTX T10-T15-T20-T25-T27-T30-T40-T45-T50
 1032 180 mm
 1034 170 mm
 1036 175 mm
 1038 175 mm
 1177BM 140 mm
 1188BM 125 mm
 1257LP 2-2,5-3-3,5 mm
 1257PH 0-00

2,3 kg



M62	Ft 208.300	1 024500875
MV62	30.750	1 024510875

M63

8



952 7-8-10-12-13-14-17-19 mm

3,4 kg



M63	Ft 156.700	1 024500063
MV63	30.750	1 024510063

M65

16

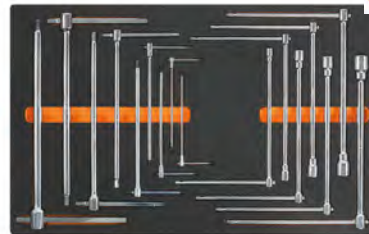

950 8-10-12-13-14-17-19 mm
 951 2,5-3-4-5-6-8-10-12-14 mm

3,6 Kg



M65	Ft 239.900	1 024500065
MV65	30.750	1 024510065

M67

6



950 7-8-10-12-13-17 mm

1,8 kg



M67	Ft 92.200	1 024500067
MV67	21.850	1 024510067

M69

9



951 2,5-3-4-5-6-8-10-12-14 mm

1,8 kg



M69	Ft 133.800	1 024500069
MV69	21.850	1 024510069



M75

16



933 7-8-9-10-11-12-13-14-15
16-17-18-19-21-22-24 mm

5,5 kg



	Ft		
M75	203.500	1	024500075
MV75	30.750	1	024510075

M78

17



80 6x7 - 8x9 - 10x11 - 12x13 - 14x15 - 16x17
- 18x19 mm

920/36A

965 450 mm

1052 240 mm

1058 175 mm

1481PL/A

1481PL/B

1481PL/C

1650 150 mm

1708/20

1716P

4,4 kg



	Ft		
M78	313.800	1	024500878
MV77	30.750	1	024510876

M82

29



920A 10-11-12-13-14
15-16-17-18-19
20-21-22-23-24
26-27-30-32 mm

920ME 5-6-8-10-12 mm

920AN/125 125 mm

920AN/250 250 mm

920/25

920/42 305 mm

920/55

4,1 kg



	Ft		
M82	200.200	1	024500082
MV84	21.850	1	024510084



M83

24



920A 10-11-12-13-14
15-16-17-18-19
20-21-22-23-24
26-27-30-32 mm

920AN/125 125 mm

920AN/250 250 mm

920/25 255 mm

920/42 305 mm

920/55

3,7 kg

12"



	Ft		
M83	162.000	1	024500083
MV87	21.850	1	024510087

M85

45



851SR 230 mm

860LP 0,5x3 - 0,6x4,5 -
0,8x5,5 - 1x5,5 -
1,2x6,5 mm

860PE 2 - 2,5 - 3 - 4 - 5 - 6 - 8
- 10 mm

860PH PH0 - PH1 - PH2 -
PH3 - PH4

860PZ PZ1 - PZ2 - PZ3 - PZ4

860TX T6 - T7 - T8 - T9 - T10
- T15 - T20 - T25 - T27
- T30 - T40

860RTX T9 - T10 - T15 - T20
- T25 - T27 - T30 - T40

860/55

882P 80 mm

892

1/4 - 1/4

450 g

1/4



	Ft		
M85	91.250	1	024500085
MV85	16.000	1	024510085

M86

46



867PE 4-5-6-7-8-10-12 mm

867PE/L 4-5-6-7-8-10-12 mm

867XZN 5-6-8-10-12 mm

867XZN/L 5-6-8-10-12 mm

867TX T20 - T25 - T30 - T40
- T45 - T50 - T55

867TX/L T25 - T30 - T40 - T45
- T50 - T55

867RTX T20 - T25 - T30 - T40
- T45 - T50 - T55

867/1

867/2

1,4 kg

10"



	Ft		
M86	65.850	1	024500086
MV86	16.000	1	024510086

M91

25



900 4 - 4,5 - 5 - 5,5 - 6 - 7
- 8 - 9 - 10 - 11 - 12
- 13 - 14 mm

900ME 2,5-3-4-5-6-8 mm

900/20 50 mm

900/21 150 mm

900/25 □ 1/4 - ■ 1/4

900BG/30

900/42

900/55

560 g

14"



	Ft		
M91	108.600	1	024500091
MV89	16.000	1	024510089

M92

22



910A 6-7-8-9-10-11-12-13-
14-15-16-17-18-19-20-
21-22 mm

910/21 125 mm

910/22 250 mm

910/25

910/42

910/55

1,5 kg

3/8"



	Ft		
M92	121.800	1	024500092
MV93	16.000	1	024510093

M94

26



900AS/L 3/16 - 7/32 - 1/4 - 9/32
- 5/16 - 11/32 - 3/8 -
7/16 - 1/2 - 9/16

900AS 3/16 - 7/32 - 5/32 - 1/4
- 9/32 - 5/16 - 11/32
- 3/8 - 7/16 - 1/2 - 9/16

900AN 50-100mm

900/25

900/55

900/42

930 g

14"



	Ft		
M94	125.600	1	024500094
MV95	16.000	1	024510095

M96

22



920A/AS 3/8 - 7/16 - 1/2 - 9/16
- 19/32 - 5/8 - 11/16
- 3/4 - 25/32 - 13/16 -
7/8 - 15/16 - 1 - 1.1/16
- 1.1/18 - 1.3/16 -
1.1/4

920/25

920AN 125-250mm

920/42

920/55

3,8 kg

12"



	Ft		
M96	166.300	1	024500096
MV97	21.850	1	024510097

M100

98



- 895/1
- 895/3
- 895/6
- 900 4-4,5-5-5,5-6-7-8-9-10-11-12-13-14 mm
- 900L 5-6-7-8-9-10-11-12-13 mm
- 900ME 3-4-5-6-7 mm
- 900LP 0,8x4 - 1x5,5 - 1,2x6,5 - 1,2x8 mm
- ⊕ 900PH PH1-PH2-PH3-PH4
- ⊗ 900TX T10 - T15 - T20 - T25 - T27 - T30 - T40
- 900/20 50 mm
- 900/20L 100 mm
- 900/21 150 mm
- 900/25
- 900BG/30
- 900/42
- ⊗ 900/55
- 920A 8-10-11-12-13-14-15-16-17-18-19-20-21-22-23-24-26-27-28-30-32 mm
- 920/15
- 920/25
- 920AN/125 125 mm
- 920AN/250 250 mm
- 920/42
- ⊗ 920/55
- ⊗ 920FTX 10-12-14-16-18-20-22-24 mm
- 920AL 10-12-13-14-15-16-17-18-19-21-22

6,7 Kg

14" 12"



	Ft	
M100	547.300	1 024500100
MV104	30.750	1 024510104

M105

116



- 900 4-4,5-5-5,5-6-7-8-9-10-11-12-13-14 mm
- 900L 5-6-7-8-9-10-11-12-13 mm
- 96BPC/SC9 1,5-2-2,5-3-4-5-6-8-10 mm
- 895/1
- 895/3
- 895/6
- 900ME 3-4-5-6-7 mm
- 900LP 0,8x4 - 1x5,5 - 1,2x6,5 - 1,2x8 mm
- ⊕ 900PH PH1-PH2-PH3-PH4
- ⊗ 900TX T10 - T15 - T20 - T25 - T27 - T30 - T40
- 900/16 □ 1/4 - ■ 3/8
- 900/... 50-100-150 mm
- 900/25
- 900BG/30
- 900/42
- ⊗ 900/55
- 910A 6-7-8-9-10-11-12-13-14-15-16-17-18-19-20-21-22 mm
- 910/15 □ 3/8 - ■ 1/4
- 910/16 □ 3/8 - ■ 1/2
- 910/21 125 mm
- 910/22 250 mm
- 910/25
- 910/42
- ⊗ 910/55
- 920A 8-10-11-12-13-14-15-16-17-18-19-20-21-22-23-24-26-27-28-30-32 mm
- 920/15 □ 1/2 - ■ 3/8
- 920/25
- 920AN 125-250 mm
- 920/42
- ⊗ 920/55
- 956E 16-17,8-20,8 mm

7,7 Kg

14" 3/8" 12"



	Ft	
M105	594.900	1 024500871
MV107	30.750	1 024510107

M108

27



- 910MQ/PE 4-5-6-8 mm
- 910MQ/B 7-8-10-11-12-13-14-15-16-17-19 mm
- ⊗ 910MQ/TX T15 - T20 - T25 - T27 - T30 - T40
- 910MQ/XZN 8-10 mm
- 910MQ/21 140 mm
- 910MQ/22 265 mm
- 910MQ/T
- 910MQ/55

2,7 Kg



	Ft	
M108	570.900	1 024500108
MV108	30.750	1 024510108

M110

36



- ⊗ 850MQ
- ⊗ 861TX/A10
- 920MQ/A 8-9-10-11-12-13-14-15-16-17-18-19-20 mm
- 920MQ/PE 5-6-8-10-12 mm
- 920MQ/21 125 mm
- 920MQ/22 250 mm
- 920MQ/55A
- 943MQ 6-7-8-10 mm

3,1 Kg



	Ft	
M110	572.300	1 024500110
MV110	30.750	1 024510110

M112

32



- ⊗ 861TX ● 1/4-T6+T15
- ⊗ 866TX ● 5/16-T20+T55
- 895/1 ○ 1/4x□1/4
- 895/6 ○ 5/16x□1/2
- ⊗ 900FTX □ 1/4-E4+E10
- ⊗ 920FTX □ 1/2-E12+E24
- ⊗ 920TX □ 1/2-T55L-T60-T70L

1,3 Kg

14" 12"



	Ft	
M112	141.000	1 024500112
MV112	16.000	1 024510112

M115

54



- ⊗ 666/20 40+200 Nm
- 920A 13-14-15-16-17-18-19-20-21-22-24-26-27-30-32 mm
- ⊗ 920FTX 12-14-16-18-20-22-24 mm
- 920PE 6-7-8-8L-10-10L-12-12L-14-14L
- ⊗ 920TX T20 - T25 - T27 - T30 - T40 - T45 - T50 - T55 - T60 - T20L - T25L - T27L - T30L - T40L - T45L - T50L
- 920/21 125 mm
- 920/22 255 mm
- 920/25
- 920/42 305 mm
- ⊗ 920/55

7,8 Kg

12"



	Ft	
M115	522.700	1 024500115
MV117	30.750	1 024510117

Beta

M118

33



- 1927P
- 720L 13-17-19-21-22-24 mm
- 720ME 5-6-8-10-12-14-17-19 mm
- 720 10-12-13-14-15-16-17
18-19-21-22-24-27-30-32 mm
- 720LC 17-19-21 mm

1,8 g



	Ft		
M118	450.800	1	024500118
MV118	30.750	1	024510118

140 MM-ES FIÓKOKHOZ ALKALMAS

M120

75



- 920A 10-11-12-13-14-15-16-17-18-19-20-21
22-24-26-27-30-32 mm
- 920AN/125 125 mm
- 920AN/250 250 mm
- 920/25
- 920/42
- 920AL 10-12-13-14-15-16-17-18-19-
22-24-27-30-32 mm
- 920FTX 10-12-14-16-18-20-22-24 mm
- 920/55
- 920PE 5-5L-6-6L-7-7L-8-8L-10-10L
-12-12L-14-14L
- 920TX T20-T25-T27-T30-T40-T45-T50-T55-T60
T20L-T25L-T27L-T30L-T40L-T45L-T50L

6,9 Kg

12"



	Ft		
M120	582.800	1	024500120
MV119	30.750	1	024510119

M121

46



- 920BP 5L-6L-8L-10L-5XL-6XL-8XL mm
- 920TX T20-T25-T27-T30-T40L-T45L
-T50L-T55L-T60L-T70L
- 920XZN 4-5-6-6L-8-8L-10-10L-12-12L
-14-14L-16-18 mm
- 920ES 7-9-10-11-12L-14L-16L-7XL-
9XL-10XL-11XL-12XL-14XL-16XL
mm
- 920/36A

6,3 Kg

12"



	Ft		
M121	548.200	1	024500121
MV121	30.750	1	024510121

M125

68



- 910AL 8-9-10-11-12-13-14-15-16-17
-19-21-22 mm
- 920PE 5-6-6L-7-8-8L-10-10L-12-12L mm
- 920FTX E12-E14-E16-E18-E20-E22-E24
- 920TX T20-T25-T27-T30-T30L-T40-T40L
-T45-T50-T50L-T55-T60-T60L
- 920XZN 5-6-6L-8-8L-10-10L-12L mm
- 920AL 10-12-13-14-15-16-17-18-19
-21-22-23-24-27-30-32 mm
- 1692/5
5 m

7,9 kg

38" 12"



	Ft		
M125	571.600	1	024500872
MV125	30.750	1	024510872

M126

26



- 928A 19-21-22-24-26-27-28-30-32
-34-35-36-38-41-46 mm
- 928ME 14-17-19-22 mm
- 928/15 □ 3/4 - ■ 1/2
- 928/16 □ 3/4 - ■ 1
- 928/21 200 mm
- 928/22 380 mm
- 928/25
- 928/42 450 mm
- 928/55

12,4 kg

34"



	Ft		
M126	437.500	1	024500126
MV139	30.750	1	024510139

M127

23



- 728 19-21-22-24-27-30-32-33-34
-35-36-38-40-41-46
- 728FTX 20-22-24 mm
- 728/15 □ 3/4 - ■ 1/2
- 728/16 □ 3/4 - ■ 1
- 728/21 175 mm
- 728/22 250 mm
- 728/25

12,5 kg

34"



	Ft		
M127	418.600	1	024500127
MV127	30.750	1	024510127

M128

50

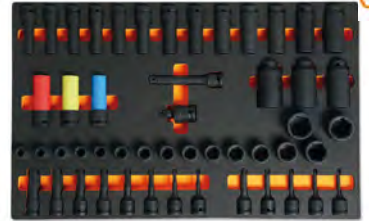

- 720 10-11-12-13-14-15-16-17-18
-19-21-22-24-27-30-32 mm
- 720L 10-11-12-13-14-15-16-17-18
-19-21-22-24-27-30-32 mm
- 720TX T30-T40-T45-T50-T55
- 720ME 5-6-8-10-12-14-17-19 mm
- 720LC 17-19-21 mm
- 720/21 125 mm
- 720/25

8,9 kg

12"



	Ft		
M128	425.000	1	024500128
MV128	30.750	1	024510128

M129

13



- 1032 180 mm
- 1034 170 mm
- 1036 175 mm
- 1038 175 mm
- 1048N 250 mm
- 1052 240 mm
- 1082BM 160 mm
- 1098 220 mm
- 1112 250 mm
- 1128BM 145 mm
- 1150BM 180 mm
- 1166BM 160 mm
- 1168BM 160 mm

3,4 Kg

Ft



	Ft		
M129	200.200	1	024500129
MV138	30.750	1	024510138

M133

3



- 1082G 160 mm
- 1150G 180 mm
- 1166G 160 mm

650 g



	Ft		
M133	38.200	1	024500133
MV133	16.000	1	024510133

M134

3



- 1082GBM 160 mm
- 1150GBM 180 mm
- 1166GBM 160 mm

750 g



	Ft		
M134	49.100	1	024500134
MV134	16.000	1	024510134

M135

3



- 1082MQ 160 mm
- 1150MQ 180 mm
- 1166MQ 160 mm

750 g



	Ft		
M135	81.100	1	024500135
MV135	16.000	1	024510135

M136

3



- 1084BM 160 mm
- 1150BM 180 mm
- 1166BM 160 mm

750 g



	Ft		
M136	54.700	1	024500136
MV131	16.000	1	024510131

M137

3



- 1084 160 mm
- 1150 180 mm
- 1166 160 mm

650 g



	Ft		
M137	45.450	1	024500137
MV132	16.000	1	024510132

M145

4



- 1032 180 mm
- 1034 170 mm
- 1036 175 mm
- 1038 175 mm

640 g



	Ft		
M145	61.350	1	024500145
MV145	16.000	1	024510145

M153

2



- 1048N 250 mm
- 1052 240 mm

1 kg



	Ft		
M153	46.750	1	024500153
MV154	16.000	1	024510154

M161

15



- 1128MQ 145 mm
- 1048MQ 250 mm
- 1082MQ 160 mm
- 1150MQ 180 mm
- 1162MQ 160 mm
- 1164MQ 160 mm
- 1272MQ PH0x60 - PH1x80 - PH2x100 - PH3x150 mm
- 1274MQ 2,5x75 - 3x100 - 4x100 - 5,5x125 mm
- 1777MQ/U

3,0 kg



	Ft		
M161	242.600	1	024500161
MV161	30.750	1	024510161



M162

8

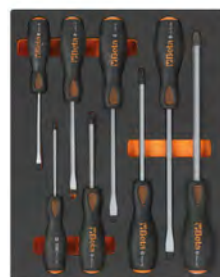

- 1241 5,5x100 - 6,5x125 - 8x150 - 10x200 mm
- 1242 PH1x100 - PH2x100 - PH3x150 - PH4x200 mm

1,4 kg



	Ft		
M162	67.250	1	024500162
MV162	21.850	1	024510162

M166

49



- 861MIX/A31
- 1048N 250 mm
- 1082BM 160 mm
- 1150BM 180 mm
- 1162BM 160 mm
- 1290 3x75 - 4x100 - 5,5x100 - 6,5x150 - 8x150 mm
- 1290N 6,5x30 mm
- 1292 4,5x80 - 6x100 - 8x150 mm
- 1292N 6x30 mm
- 1297TX T20-T25-T27-T30

2,9 kg



	Ft		
M166	208.200	1	024500879
MV880	30.750	1	024510880

M170

7



- 1290 2,5x50 - 3x75 - 3,5x100 - 4x125 - 5,5x100 - 5,5x150 - 6,5x150 mm

500 g



	Ft		
M170	36.400	1	024500170
MV170	16.000	1	024510170



M172



1292

PH0x60
PH0x100
PH1x80
PH1x120
PH2x100
PH2x150 mm



450 g



	Ft		
M172	33.200	1	024500172
MV172	16.000	1	024510172

M174



1297TX

T8 - T10 - T15 - T20
- T25 - T30



450 g



	Ft		
M174	48.600	1	024500174
MV174	16.000	1	024510174

M180



1290

3x75
4x100
5,5x150
6,5x150 mm
1292
PH0x60
PH1x80
PH2x100 mm



500 g



	Ft		
M180	37.900	1	024500180
MV180	16.000	1	024510180



M195

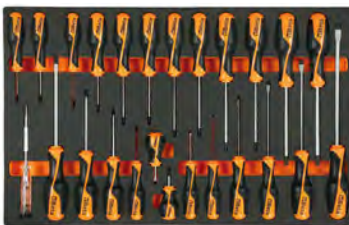

1260

2,5x50 - 3x75 - 4x100 - 5,5x125 - 6,5x150
- 8x200 mm

1260N

4x30 mm

1262

PH0x60 - PH1x80 - PH2x100 - PH3x150
mm

1262N

PH1X30 mm

1267TX

T6 - T7 - T8 - T9 - T10 - T15 - T20 - T25
- T27 - T30 - T40 - T45

1253

3,5x100 mm



2,3 kg



	Ft		
M195	147.200	1	024500195
MV195	30.750	1	024510195

M201



1260

3x75 - 4x100 -
6,5x150 mm

1262

PH0x60 - PH1x80 -
PH2x100 mm



500 g



	Ft		
M201	37.500	1	024500201
MV201	16.000	1	024510201

M204



1267TX

T8 - T10 - T15 - T20
- T25 - T30



450 g



	Ft		
M204	37.100	1	024500204
MV204	16.000	1	024510204

M208



1260

3x75
3,5x100
4x125
5,5x150
6,5x150 mm

1262

PH0x60
PH1x80
PH2x100 mm

1260N

4x30 mm

1262N

PH1x30 mm



750 g



	Ft		
M208	42.450	1	024500208
MV208	21.850	1	024510208

M209



1260N

4x30 mm

1264

2,5x60 - 3x100 -
4x125 - 5x150 -
6,5x150 mm

1262

PH0x60 - PH1x80 -
PH2x100 mm

1262N

PH1x30 mm



820 g



	Ft		
M209	41.950	1	024500209
MV208	21.850	1	024510208

M213

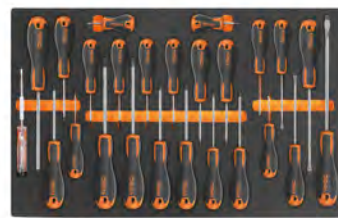

1201E

2,5x50 - 3x75 - 4x100 - 5,5x125 - 6,5x150
- 8x200 mm

1201EN

4x30 mm

1202E

PH0x60 - PH1x80 - PH2x100 - PH3x150
mm

1202EN

PH1X30 mm

1207E/TX

T6 - T7 - T8 - T9 - T10 - T15 - T20 - T25
- T27 - T30 - T40 - T45

1253

3,5x100 mm



1,8 Kg



	Ft		
M213	99.150	1	024500213
MV210	30.750	1	024510210



M214



- 1201E 2,5x50 - 3x75 - 3,5x100 - 4x125 - 5,5x100 - 5,5x150 - 6,5x150 mm

500 g



M214	Ft 20.600	1	024500214
MV211	Ft 16.000	1	024510211

M216



- 1202E PH0x60 - PH1x80 - PH1x120 - PH2x100 - PH2x150 - PH3x150 mm

450 g



M216	Ft 22.300	1	024500216
MV212	Ft 16.000	1	024510212

M217

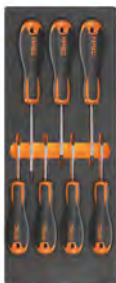

- 1207E/TX T6 - T7 - T8 - T9 - T10 - T15 - T20

500 g



M217	Ft 28.550	1	024500217
MV215	Ft 16.000	1	024510215

M218



- 1201E 3x75 - 4x100 - 5,5x150 - 6,5x150 mm
- 1202E PH0x60 - PH1x80 - PH2x100 mm

500 g



M218	Ft 21.650	1	024500218
MV220	Ft 16.000	1	024510220

M222



- 1272MQ PH0x60 mm
- 1272MQF PH1x80 - PH2x100 mm
- 1274MQF 3,5x100 - 4,5x100 - 5,5x125 - 6,5x150 mm

540 g



M222	Ft 62.100	1	024500222
MV222	Ft 16.000	1	024510222

M226



- 1274MQ 3x100 - 4x100 - 5,5x125 - 6,5x150 mm
- 1272MQ PH0x60 - PH1x80 - PH2x100 mm

500 g



M226	Ft 47.150	1	024500226
MV226	Ft 16.000	1	024510226

M227



- 944BX 6-7-8-10-13 mm

420 g



M227	Ft 57.550	1	024500227
MV227	Ft 16.000	1	024510227

M230



- 30 Ø 2-3-4 mm
- 31 Ø 2-3-4-5-6-8 mm
- 32 Ø 4 mm
- 34 150 mm
- 35 200-250 mm
- 36 125 mm
- 1370 500 g
- 1390 Ø 35 mm
- 1692 3 m
- 1712TF
- 1719BMA/Q 200 mm
- ▲ 1719BMA/T 200 mm
- 1719BMA/P 200 mm
- ▶ 1719BMA/M 200 mm
- 1719BMA/R 200 mm
- 1737NX
- 1771 170 mm

3,2 Kg



M230	Ft 189.100	1	024500230
MV230	Ft 30.750	1	024510230

M231



- 31 2-3-4-5-6-8 mm
- 32 4 mm
- 34 125-150-175 mm
- 36 125 mm
- 1370 500-1000 g
- 1390 Ø 35 mm
- 1712TF 590 mm
- 1715 670 mm
- 1719BMA8/Q 200 mm
- ▲ 1719BMA8/T 200 mm
- 1719BMA8/P 200 mm
- ▶ 1719BMA8/M 200 mm
- 1719BMA8/R 200 mm
- 1737NX

4,7 kg



M231	Ft 182.500	1	024500877
MV231	Ft 30.750	1	024510877



M234



35 100-200 mm
1370 300 g
1390 Ø 35 mm



1,3 kg



M234	Ft 47.650	1	024500234
MV232	16.000	1	024510232

M236



■ 1719BMA/Q 200 mm
▲ 1719BMA/T 200 mm
■ 1719BMA/P 200 mm
▶ 1719BMA/M 200 mm
● 1719BMA/R 200 mm



870 g



M236	Ft 47.200	1	024500236
MV236	16.000	1	024510236

M237



35 100-200 mm
1370T 300 mm
1390N Ø 35 mm



1,3 kg



M237	Ft 51.800	1	024500237
MV232	16.000	1	024510232

M240



31BM Ø 2-3-4-5-6-8 mm
32 Ø 4 mm



850 g



M240	Ft 61.950	1	024500240
MV240	16.000	1	024510240



M264



1491 Ø 65+110 mm
■ 1494 ■ 10 mm
○ 1494E ○ 8 - 9 - 10 - 11 - 12 - 14 - 17 mm
○ 1494Q ○ 8-9,5-12-13 mm
△ 1494T △ 9,5
○ 1494XZN ○ 16
1496C ■ 8x ■ 10 mm



2,1 kg



M264	Ft 109.300	1	024500264
MV264	16.000	1	024510264

M284



1128BMX 147 mm
1130BMX 185 mm
■ 1719BMA...Q 200 mm
▲ 1719BMA...P 200 mm
▶ 1719BMA...M 200 mm
● 1719BMA...R 200 mm
1726BM 400 mm
1728BM (5)
1771BM 170 mm
1778V18 185 mm



2,4 Kg



M284	Ft 110.600	1	024500284
MV284	30.750	1	024510284

M292



111E 250 mm
1128BMX 147 mm
1692/5 5 m
1771 170 mm



500 g



M292	Ft 53.200	1	024500292
MV293	16.000	1	024510293

M294



1692/5 5 m
1725CR 260 mm
1771 170 mm
1771RL



500 g



M294	Ft 36.250	1	024500294
MV294	16.000	1	024510294

M295



1650
1682 300 mm
1707
1708/20



450 g



M295	Ft 52.750	1	024500295
MV295	16.000	1	024510295



M400

29



- 3932U
- 3935 120 mm
- 3937 170 mm
- 3952 13 - 14 - 15 - 16 - 17 - 18 - 19 mm
- 3961 3,2
- 3961 3,3
- 3961 3,5
- 3961U 3,2 - 4,0 mm
- 3969 200 mm (x2)
- 3969K3 113 mm
- 3973/1
- 3973/2
- 3973/3
- 3973/4
- 3984/1 Ø35 mm
- 3984/2 Ø22,8 mm
- 3984/3 Ø23,5 mm
- 3984/4 Ø23 mm
- 3991 222 mm
- 3992 234 mm

3,1 kg



	Ft	
M400	281.200	1 024500400
MV400	30.750	1 024510400

M401

7



- 3921 440 mm
- 3948
- 3953
- 3955 30x32 - 32x36 mm
- 3967 289 mm
- 3971

2,7 kg



	Ft	
M401	170.000	1 024500401
MV401	30.750	1 024510401

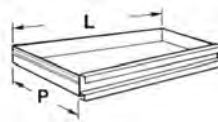

RSC22
RSC23
RSC23C
C27S

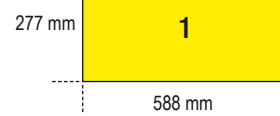
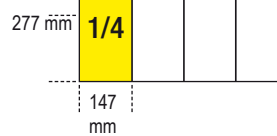

554
569



C41S
C41H

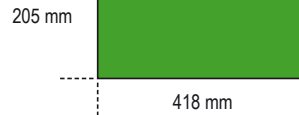

554



MC10

34



- 42 6-7-8-9-10-11-12
13-14-15-16-17
18-19-21-22 mm
- 96/SC9 1,5 - 2 - 2,5 - 3 - 4 - 5 - 6 - 8 - 10 mm
- ⌘ 1084BM 160 mm
- ≡ 1150G 180 mm
- 1166G 160 mm
- 1201E 3,5x100 - 5,5x150 - 6,5x150 mm
- ⊕ 1202E PH0x60 - PH1x80 - PH2x100 mm

3,5 kg



	Ft	
MC10	179.200	1 027500011
MCV10	26.300	1 027510010

MC12

26



- 42 6 - 7 - 8 - 9 - 10 - 11 - 12 - 13 - 14 - 15 - 16 - 17
18 - 19 - 21 - 22 mm
- 96/SC9 1,5 - 2 - 2,5 - 3 - 4 - 5 - 6 - 8 - 10 mm
- 1692/5 5 m

2,2 kg



	Ft	
MC12	117.900	1 041500012
MCV11	26.300	1 041510011

MC20

74



- 861MIX/A31
- 895/1
- 1048N 250 mm
- 1370 300 g
- 32 Ø 4 mm
- 36 Ø 4 mm
- 900 4 - 4,5 - 5 - 5,5 - 6 - 7 - 8 - 9 - 10 - 11 - 12 - 13 - 14 mm
- 900/21 150 mm
- 900/25
- 900BG/30C
- 900/42
- 900/55
- 920A 10 - 11 - 12 - 13 - 14 - 15 - 16 - 17 - 18 - 19 - 21 - 22 - 24
- 27 - 30 - 32 mm

920/25

920AN/125 125 mm

920/42

920/55



6 kg



	Ft	
MC20	278.600	1 027500020
MCV24	26.300	1 027510024

MC21

24



- 920A 10 - 11 - 12 - 13 - 14 - 15 - 16 - 17 - 18 - 19 - 20
- 21 - 22 - 23 - 24 - 26 - 27 - 30 - 32 mm
- 920/25
- 920/42
- ⊕ 920/55
- 920AN 125-250 mm

4,3 kg



	Ft	
MC21	166.400	1 041500021
MCV17	26.300	1 041510017



C35

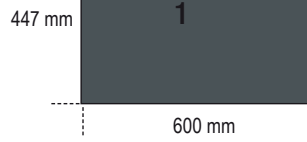

555-556

MB12

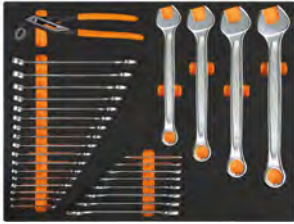

42	6 - 7 - 8 - 9 - 10 - 11 - 12 - 13 - 14 - 15 - 16 - 17 - 18 - 19 - 20 - 21 - 22 - 24 - 27 - 30 - 32 mm
55	6x7-8x9-10x11 12x13-14x15 16x17-18x19 20x22 mm
1048N	250 mm

5,4 kg



	Ft		
MB12	273.700	1	024504212
MBV13	83.800	1	024524213

MB37



920A	10 - 11 - 12 - 13 - 14 - 15 - 16 - 17 - 18 - 19 - 20 - 21 - 22 - 23 - 24 - 26 - 27 - 30 - 32 mm
920/21	125 mm
920/22	150 mm
920/25	
920/42	
920/55	
111E	250 mm
1052	240 mm
1084BM	160 mm
1150BM	180 mm
1166BM	160 mm
1032	180 mm
1034	170 mm
1036	175 mm
1038	175 mm
900	4-4,5-5-5,5-6-7-8-9-10-11-12-13-14 mm
900/20	50 mm
900/21	150 mm
900/25	
900BG/30	
900/55	
900/42	

7,0 kg



	Ft		
MB37	419.900	1	024504237
MBV27	83.800	1	024524227

MB39



920A	10 - 11 - 12 - 13 - 14 - 15 - 16 - 17 - 18 - 19 - 20 - 21 - 22 - 23 - 24 - 26 - 27 - 30 - 32 mm
920/21	125 mm
920/22	255 mm
920/25	
920/42	
920/55	
920PE	5-6-8-10-12 mm
1032	180 mm
1034	170 mm
1036	175 mm
1038	175 mm
35	200 mm
1084BM	160 mm
1150BM	180 mm
1166BM	160 mm
1370	500 g
1390	35 mm

7,2 kg



	Ft		
MB39	385.300	1	024504239
MBV29	83.800	1	024524229

MB44



1260	2,5x50 - 3x75 - 3,5x100 - 4x100 - 5,5x125 - 6,5x150 - 8x200 mm
1260N	4x30-6,5x30 mm
1262	PH0x60 - PH0x100 - PH1x80 - PH1x120 - PH2x100 - PH2x150 - PH3x150 mm
1262N	PH1x30-PH2x30 mm
1253	
96BPC/SC9	
951	2,5-3-4-5-6-8 mm

2,8 kg



	Ft		
MB44	179.100	1	024504244
MBV44	83.800	1	024524244

MB46



1260	3x75 - 4x100 - 5,5x125 - 6,5x150 mm
1262	PH0x60 - PH1x80 - PH2x100 mm
1267TX	T8 - T10 - T15 - T20 - T25 - T30
96BPC/SC9	
96T	2-2,5-3-4-5-6
1052	240 mm

2,8 kg



	Ft		
MB46	147.800	1	024504246
MBV46	83.800	1	024524246

MB47



1260	3x75 - 4x100 - 5,5x125 - 6,5x150 mm
1262	PH0x60 - PH1x80 - PH2x100 mm
1260N	4x30 mm
1262N	PH1x30 mm
96T	2,5-3-4-5-6-8 mm
96BPC/SC9	
920A	10 - 11 - 12 - 13 - 14 - 15 - 16 - 17 - 18 - 19 - 20 - 21 - 22 - 23 - 24 - 26 - 27 - 30 - 32 mm
920/21	125 mm
920/22	250 mm
920/25	
920/42	
920/55	

5,6 kg

12"



	Ft		
MB47	329.300	1	024504247
MBV70	83.800	1	024524270

MB58

17



31	Ø 2-3-4-5-6 mm
32	Ø 4 mm
35	200 mm
1112	250 mm
1128BMX	147 mm
1370	500 g
1390	Ø 45 mm
■ 1719BMA...Q	200 mm
▲ 1719BMA...T	200 mm
■ 1719BMA...P	200 mm
▶ 1719BMA...M	200 mm
● 1719BMA...R	200 mm
1726	440 mm

4,5 kg



	Ft		
MB58	171.000	1	024504258
MBV55	83.800	1	024524255

MB59

15



■ 1719BMA...Q	200 mm
▲ 1719BMA...T	200 mm
■ 1719BMA...P	200 mm
▶ 1719BMA...M	200 mm
● 1719BMA...R	200 mm
31	Ø 4-6 mm
32	Ø 4 mm
35	125-200 mm
1370	300 g
1390	Ø 35 mm
1692	5 m
1725	420 mm
1833XS/2	

3,4 kg



	Ft		
MB59	142.600	1	024504259
MBV57	83.800	1	024524257

MB65

16



1719BMA...Q	200 mm
1719BMA...P	200 mm
1719BMA...T	200 mm
1719BMA...M	200 mm
1719BMA...R	200 mm
35	200 mm
○ 1032	180 mm
○ 1034	170 mm
● 1036	175 mm
● 1038	175 mm
1052	240 mm
⚡ 1084BM	160 mm
≡ 1150BM	180 mm
● 1166BM	160 mm
1370	500 g
1390	Ø 35 mm

4,8 kg



	Ft		
MB65	221.900	1	024504265
MBV61	83.800	1	024524261

MB63

60

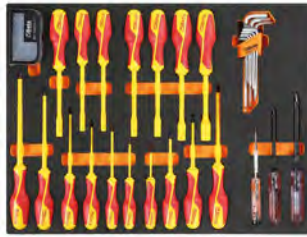

○ 96BPC/SC9	
● 1250	4x125 mm
⊕ 1251	PH1x125 mm
○ 1253	
○ 943MQ	5,5-6-7-8-10-13 mm
⊕ 1272MQ	PH0x60 - PH1x80 - PH2x100 - PH3x150 mm
● 1274MQ	2,5x75 - 3x100 - 4x100 - 5,5x125 - 6,5x150 - 8x175 mm
● 860LP	0,5x3 - 0,6x4 - 0,8x5,5 - 1,0x5,5 - 1,2x6,5 mm
○ 860PE	2 - 2,5 - 3 - 4 - 5 - 6 - 8 - 10 mm
⊕ 860PH	PH0 - PH1 - PH2 - PH3 - PH4
⊕ 860PZ	PZ1 - PZ2 - PZ3 - PZ4
⊕ 860RTX	T9 - T10 - T15 - T20 - T25 - T27 - T30 - T40
882MSR 50	○ 1/4 ● 1/4
⊕ 850MQ	

3,2 kg



	Ft		
MB63	229.300	1	024504263
MBV63	83.800	1	024524263

MB64

20



55	6x7-8x9-10x11 12x13-14x15 16x17-18x19 20x22 mm
1048MQ	250 mm
⚡ 1082MQ	140 mm
1128BSX	148 mm
1132MQ	230 mm
⚡ 1142MQ	160 mm
≡ 1150MQ	180 mm
● 1166MQ	160 mm
● 1168MQ	160 mm
110MQ	250 mm
1777MQ	
993MQ	
1602	

4,1 kg



	Ft		
MB64	410.100	1	024504264
MBV62	83.800	1	024524262



Beta

C45PRO 2.0

566 mm
406 mm
532 mm
34 mm

1

MM

557

MM11

30



42 6 - 7 - 8 - 9 - 10 - 11 - 12 - 13 - 14 - 15 - 16 - 17 - 18 - 19 - 20 - 21 - 22 - 24 - 27 - 30 - 32 mm

96BPC/SC9 1,5 - 2 - 2,5 - 3 - 4 - 5 - 6 - 8 - 10 mm

4,5 kg

	Ft	1	2
MM11	186.900	1	024580011
MMV10	30.750	1	024590010

MM26

34



42 6 - 7 - 8 - 9 - 10 - 11 - 12 - 13 - 14 - 15 - 16 - 17 - 18 - 19 - 21 - 22 - 24 - 27 mm

111E 250 mm

123Q1/4
123Q3/8
123Q1/2

142 8 - 9 - 10 - 11 - 12 - 13 - 14 - 15 - 16 - 17 - 18 - 19 mm

4,3 kg

	Ft	1	2
MM26	299.100	1	024580026
MMV26	30.750	1	024590026



MM30

31

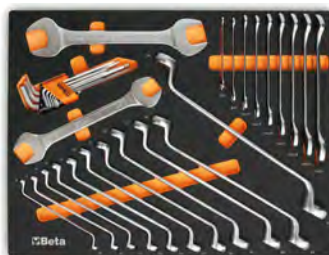

55 6x7-8x9-10x11-12x13-14x15-16x17
18x19-20x22-21x23-24x27-30x32 mm

90 6x7-8x9-10x11-12x13-14x15-16x17
18x19-20x22-21x23-24x27-30x32 mm

96BPC/SC9 1,5 - 2 - 2,5 - 3 - 4 - 5 - 6 - 8 - 10 mm

4,9 kg

	Ft	1	2
MM30	197.400	1	024580030
MMV30	30.750	1	024590030

MM60

23



96T 2 - 2,5 - 3 - 4 - 5 - 6 - 7 - 8 - 10 mm

97BTX/SC8 T9-T10-T15-T20-T25-T27-T30-T40

944BX 5-6-7-8-10-13 mm

2,2 Kg

	Ft	1	2
MM60	184.000	1	024580060
MMV60	30.750	1	024590060

MM63

8



952 7 - 8 - 10 - 12 - 13 - 14 - 17 - 19 mm

3,4 kg

	Ft	1	2
MM63	170.000	1	024580063
MMV63	30.750	1	024590063

MM100

98



- 895/1
- 895/3
- 895/6
- 900 4 - 4,5 - 5 - 5,5 - 6 - 7 - 8 - 9 - 10 - 11 - 12 - 13 - 14 mm
- 900L 5 - 6 - 7 - 8 - 9 - 10 - 11 - 12 - 13 mm
- 900ME 3-4-5-6-7 mm
- 900LP 0,8x4 - 1x5,5 - 1,2x6,5 - 1,2x8 mm
- 900PH PH1-PH2-PH3-PH4
- 900TX T10 - T15 - T20 - T25 - T27 - T30 - T40
- 900/20 50 mm
- 900/20L 100 mm
- 900/21 150 mm
- 900/25
- 900BG/30
- 900/42
- 900/55
- 920A 8-10-11-12-13-14-15-16-17-18-19-20-21-22-23-24-26-27-28-30-32 mm
- 920/15
- 920/25
- 920AN/125 125 mm
- 920AN/250 250 mm
- 920/42
- 920/55
- 920FTX 10 - 12 - 14 - 16 - 18 - 20 - 22 - 24 mm
- 920AL 10 - 12 - 13 - 14 - 15 - 16 - 17 - 18 - 19 - 21 - 22

6,7 Kg

14" 12"

	Ft	1	2
MM100	547.300	1	024580100
MMV104	30.750	1	024590104



Beta



MM105

107



- 895/1 □1/4-□1/4
- 895/3 □1/4-□3/8
- 895/6 □5/16-□1/2
- 900 4- 4,5 - 5 - 5,5 - 6 - 7 - 8 - 9 - 10 - 11 - 12 - 13 - 14 mm
- 900L 5- 6 - 7 - 8 - 9 - 10 - 11 - 12 - 13 mm
- 900ME 3-4-5-6-7 mm
- 900LP 0,8x4 - 1x5,5 - 1,2x6,5 - 1,2x8
- 900PH PH1-PH2-PH3-PH4
- 900TX T10 - T15 - T20 - T25 - T27 - T30 - T40
- 900/16 50-100-150 mm
- 900/25 176 mm
- 900BG/30 115 mm
- 900/42 125 mm
- 900/55 6- 7 - 8 - 9 - 10 - 11 - 12 - 13 - 14 - 15 - 16 - 17 - 18 - 19 - 20 - 21 - 22 mm
- 910A □3/8-■1/4
- 910/15 □3/8-■1/2
- 910/16 125 mm
- 910/21 250 mm
- 910/22 210 mm
- 910/25 200 mm
- 910/42 8- 10 - 11 - 12 - 13 - 14 - 15 - 16 - 17 - 18 - 19 - 20 - 21 - 22 - 23 - 24 - 26 - 27 - 28 - 30 - 32 mm
- 910/55 □1/2-■3/8
- 920A 125-250 mm
- 920/15 305 mm
- 920/25 275 mm
- 920AN 16 mm (5/8") - 17,8 (11/16") - 20,8 (13/16")
- 920/42 14" 38" 12"
- 920/55
- 956E

2,9 Kg

	Ft	
MM105	574.700	1 024580105
MMV107	30.750	1 024590107

MM129

12



- 1032 180 mm
- 1034 170 mm
- 1036 175 mm
- 1038 175 mm
- 1048N 250 mm
- 1052 240 mm
- 1082BM 160 mm
- 1098 220 mm
- 1128BM 145 mm
- 1150BM 180 mm
- 1166BM 160 mm
- 1168BM 160 mm

2,9 Kg

	Ft	
MM129	195.100	1 024580129
MMV129	30.750	1 024590129

MM210

25



- 1201E 2,5x50 - 3x75 - 4x100 - 5,5x125 - 6,5x150 - 8x200 mm
- 1201EN 4x30 mm
- 1202E PH0x60 - PH1x80 - PH2x100 - PH3x150 mm
- 1202EN PH1X30 mm
- 1207E/TX T6 - T7 - T8 - T9 - T10 - T15 - T20 - T25 - T27 - T30 - T40 - T45
- 1253

2,1 kg

	Ft	
MM210	99.150	1 024580211
MMV210	30.750	1 024590210



MM230

25



- 30 Ø 2-3-4 mm
- 31 Ø 2-3-4-5-6-8 mm
- 32 Ø 4 mm
- 34 150 mm
- 35 200-250 mm
- 36 125 mm
- 1370 500 g
- 1390 Ø 35 mm
- 1692 3 m
- 1712TF
- 1719BMA...Q 200 mm
- 1719BMA...T 200 mm
- 1719BMA...P 200 mm
- 1719BMA...M 200 mm
- 1719BMA...R 200 mm
- 1737NX
- 1771 170 mm

3,2 Kg

	Ft	
MM230	198.900	1 024580230
MMV230	30.750	1 024590230

MM400

29



- 3932U
- 3935 120 mm
- 3937 170 mm
- 3952 13 - 14 - 15 - 16 - 17 - 18 - 19 mm
- 3961 3,2
- 3961 3,3
- 3961 3,5
- 3961U 3,2 - 4,0 mm
- 3969 200 mm (x2)
- 3969K3 113 mm
- 3973/1
- 3973/2
- 3973/3
- 3973/4
- 3984/1
- 3984/2
- 3984/3
- 3984/4
- 3991 222 mm
- 3992 234 mm

3,1 kg

	Ft	
MM400	281.200	1 024580400
MMV400	30.750	1 024590400



MM401



3921	440 mm
3948	
3953	
3955	30x32 mm - 32x36 mm
3967	289 mm
3971	

2,7 kg

MM401	Ft 170.000	1	024580401
MMV401	Ft 30.750	1	024590401

VPM0

EVA habzivacs tálca rendező műanyag dobozzal



VPM0	Ft 12.750	1	088870350
------	-----------	---	-----------

VPM3

EVA habzivacs tálca 4 darab rendező műanyag dobozzal

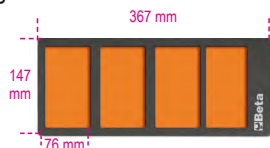

VPM3	Ft 12.750	1	088870353
------	-----------	---	-----------

VPM7

EVA habzivacs tálca 3 darab rendező műanyag dobozzal a C45PRO 2.0 szerszámoszládákhoz

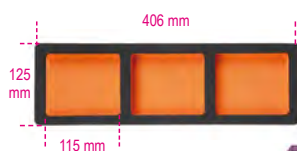

VPM7	Ft 13.350	1	088870356
------	-----------	---	-----------

VPM8

EVA hab tálca rendező műanyag dobozzal a C45PRO 2.0 szerszámkocsikhoz és szerszámoszládákhoz



VPM8	Ft 10.300	1	088870357
------	-----------	---	-----------

VPM9



VPM9	Ft 9.960	1	088870358
------	----------	---	-----------

VPM7-C

EVA habzivacs tálca 3 darab rendező műanyag dobozzal a C45PRO 2.0 szerszámkocsikhoz

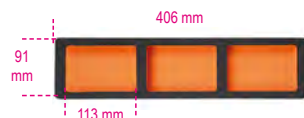

VPM7C	Ft 15.600	1	088870360
-------	-----------	---	-----------



Kemény hőformált tálcák T-széria



Szerszámkészletek hőformált tálcákon fiókos szerszámtárolókhöz, valamint az összes típusú tárolókhöz.

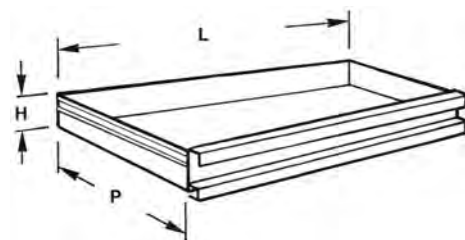

H mm	LxP mm
70	588x367

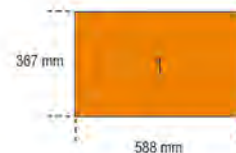
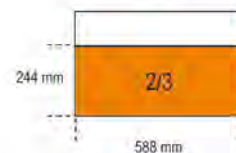
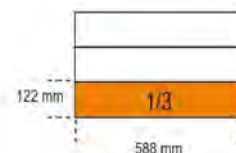
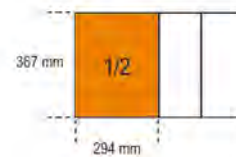
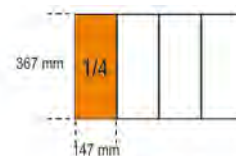

T01



42 6-7-8-10-11-12-13
14-16-17-18-19-21
22-24-27-30 mm



1 2,7 kg



T01	Ft 122.400	1	024240001
TV10	15.800	1	024000400

T05



42 6-7-8-9-10-11-12
13-14-15-16-17
18-19-20-21 mm



1 1,5 kg



T05	Ft 93.150	1	024240005
TV15	11.950	1	024000445

T06



42 22-24-27-30-32 mm



1 2,1 kg



T06	Ft 65.750	1	024240006
TV16	11.950	1	024000446

T23



42INOX 8 - 10 - 11 - 12 - 13 -
14 - 15 - 17 - 19 mm
96BPINOX 2,5-3-4-5-6-8-10 mm



1 1 kg



T23	Ft 124.100	1	024240023
TV23	11.950	1	024249906

T24



42AS 5/16-3/8-7/16-1/2
9/16-5/8-11/16-3/4
96AS/BG7 3/32-1/8-5/32-3/16
1/4-5/16-3/8



1 1 kg



T24	Ft 71.050	1	024240024
TV20	11.950	1	024000488

T28



42MP 6-7-8-9-10-11-12
13-14-15-16-17
18-19-20-21 mm



1 1,5 kg



T28	Ft 133.100	1	024240028
TV15	11.950	1	024000445

T29



42MP 22-24-27-30-32 mm



1 2,1 kg



T29	Ft 87.650	1	024240029
TV16	11.950	1	024000446

T31

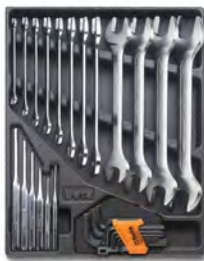

31 Ø 2-3-4-5-6 mm
32 Ø 4 mm
55 6x7-8x9-10x11
12x13-14x15
16x17-18x19
20x22-21x23
24x26-27x29
30x32 mm
96N/SC9 1,5+10 mm



1 3 kg



T31	Ft 100.300	1	024240031
TV30	15.800	1	024000401

T33



55 6x7-8x9-10x11
12x13-14x15
16x17-18x19
20x22 mm
96/SC9 1,5+10 mm



1 1 kg



T33	Ft 42.450	1	024240033
TV20	11.950	1	024000488

T34



55MP 6x7-8x9-10x11
12x13-14x15
16x17-18x19
20x22 mm
96/SC9 1,5+10 mm



1 1 kg



T34	Ft 54.350	1	024240034
TV20	11.950	1	024000488

T40



90 6x7-8x9-10x11
12x13-14x15
16x17-18x19 mm



1 810 g



T40	Ft 47.200	1	024240040
TV40	11.950	1	024000456

T41



90 20x22-21x23
24x26-25x28
27x29 mm



1 1,5 kg



T41	Ft 69.600	1	024240041
TV41	11.950	1	024000457

T45

12



142 8-9-10-11-12
13-14-15-16
17-18-19 mm

1,3 kg



	Ft		
T45	140.700	1	024240045
TV45	11.950	1	024000498

T46

12



142SN 8-9-10-11-12
13-14-15-16
17-18-19 mm

1,5 kg



	Ft		
T46	167.800	1	024240046
TV46	11.950	1	024000499

T48

12



○96BPC/SC9 1,5÷10 mm
142C 8-9-10-11-12
13-14-15-16
17-18-19 mm

1,4 kg



	Ft		
T48	119.700	1	024240048
TV47	11.950	1	024000763

T50

11



○96T 2-2,5-3-3,5-4-4,5
5-6-7-8-10 mm

1,3 kg



	Ft		
T50	79.600	1	024240050
TV50	15.800	1	024000764

T52

6



○96T 2-2,5-3-4-5-6 mm

350 g



	Ft		
T52	39.000	1	024240052
TV52	11.950	1	024000765

T55

6



○97TTX T10-T15-T20
T25-T27-T30

330 g



	Ft		
T55	44.450	1	024240055
TV55	11.950	1	024000766

T59

14



111E 250 mm
920/40 ■ 1/2
○951 2,5-3-4-5-6-8 mm
○953 4-5-6-8 mm
1370 300 - 500 g

4,7 kg



	Ft		
T59	201.100	1	024240059
TV60	23.700	1	024000420

T63

8



○952 7 - 8 - 10 - 12 - 13 - 14 - 17 - 19 mm

3,8 kg



	Ft		
T63	152.500	1	024240063
TV63	19.650	1	024000471

T64

8



○952FTX E10-E12-E14
○953TX T25 - T27 - T30 - T40 - T45

3,8 kg



	Ft		
T64	186.600	1	024240064
TV63	19.650	1	024000471

T65

8



○953 3 - 3,5 - 4 - 5 - 6 - 7 - 8 - 10 mm

2,8 kg



	Ft		
T65	145.400	1	024240065
TV63	19.650	1	024000471

T68

6



○951 2,5-3-4-5-6-8 mm

590 g



	Ft		
T68	65.000	1	024240068
TV68	11.950	1	024000470

T73

10



○930 6x7 - 8x9 - 10x11 -
12x13 - 14x15 - 16x17 -
18x19 - 20x22 mm
940/1 100 mm
940/2 170 mm

1,3 kg



	Ft		
T73	95.800	1	024240073
TV73	11.950	1	024000418

T75

16



○ 933 7-8-9-10-11-12-13
14-15-16-17-18-19
21-22-24 mm

4,2 kg



	Ft	
T75	198.100	1 024240075
TV75	23.700	1 024000422

T76

16



○ 932 7-8-9-10-11-12-13
14-15-16-17-18-19
21-22-24 mm

4,2 kg



	Ft	
T76	198.100	1 024240076
TV75	23.700	1 024000422

T77

10



○ 933 6-7-8-10-11-12-13
14-17-19 mm

1,4 kg



	Ft	
T77	98.750	1 024240077
TV77	11.950	1 024000474

T80

29



○ 920A 10-11-12-13-14
15-16-17-18-19
20-21-22-23-24
26-27-30-32 mm
○ 920ME
920/21 125 mm
920/22 255 mm
920/25 305 mm
⊕ 920/55

4,1 kg

12"



	Ft	
T80	187.300	1 024240080
TV80	15.800	1 024000403

T81

29



○ 920B 10-11-12-13-14
15-16-17-18-19
20-21-22-23-24
26-27-30-32 mm
○ 920ME
920/21 125 mm
920/22 255 mm
920/25 305 mm
⊕ 920/55

4,1 kg

12"



	Ft	
T81	187.300	1 024240081
TV80	15.800	1 024000403

T82

29



○ 920A 10-11-12-13-14
15-16-17-18-19
20-21-22-23-24
26-27-30-32 mm
○ 920ME
920AN/125 125 mm
920AN/250 250 mm
920/25 305 mm
⊕ 920/55

4,1 kg

12"



	Ft	
T82	193.500	1 024240082
TV80	15.800	1 024000403

T83

24



○ 920A 10-11-12-13-14
15-16-17-18-19
20-21-22-23-24
26-27-30-32 mm
920/21 125 mm
920/22 255 mm
920/25 305 mm
⊕ 920/55

3,6 kg

12"



	Ft	
T83	145.700	1 024240083
TV83	15.800	1 024000402

T85

81



● 861LP 0,5x3 - 0,6x4,5 - 0,8x5,5 - 1x5,5
- 1,2x6,5 - 1,2x8 - 1,6x8 mm
○ 861PE 2 - 2,5 - 3 - 4 - 5 - 6 - 8 - 10 mm
⊕ 861PH PH0 - PH1 - PH2 - PH3
⊕ 861PZ PZ1 - PZ2 - PZ3
⊕ 861TX T6 - T7 - T8 - T9 - T10 - T15 - T20
- T25 - T27 - T30 - T40
⊕ 861RTX T9 - T10 - T15 - T20 - T25 - T27 -
T30 - T40
⊕ 861TRW 1-2-3-4-5-6 mm
⊕ 861TQS 0 - 1 - 2 - 3 - 4 - 5 - 6 - 8 - 10 mm
⊕ 861SP 4-6-8-10-12 mm
851SR 230 mm
○ 900 4-4,5-5,5-5,5-6-7-8-9
10-11-12-13-14 mm
900/21 150 mm
900/25 41 mm
900BG/30 176 mm
900/42 115 mm
⊕ 900/55 125 mm
194 1/4x5/16

1,0 kg

14"



	Ft	
T85	157.400	1 024240085
TV85	15.800	1 024000747

T91

25



○ 900 4-4,5-5-5,5-6
7-8-9-10-11
12-13-14 mm
○ 900ME 2,5-3-4-5-6-8 mm
900/20 50 mm
900/21 150 mm
900/25
900BG/30
900/42 115 mm
⊕ 900/55

560 g

14"



	Ft	
T91	100.500	1 024240091
TV90	11.950	1 024000447

T92

22



○ 910A 6-7-8-9-10-11-12-13
14-15-16-17-18-19
20-21-22 mm
910/21 125 mm
910/22 250 mm
910/25
910/42 210 mm
⊕ 910/55

1,5 kg

38"



	Ft	
T92	114.800	1 024240092
TV92	11.950	1 024000458



T99



- 920INOX-A 10-12-13-14-15-16-17
18-19-21-22-24-27
30-32mm
- 920/55INOX



2,7 kg

12"



	Ft		
T99	532.800	1	024240099
TV99	11.950	1	024249908

T100



- 920A 10-12-13-14-15
16-17-18-19-21
22-24 mm
- 920/21 125 mm
- 920/25
- 920/42 305 mm
- 920/55

2,1 kg

12"



	Ft		
T100	104.200	1	024240100
TV100	11.950	1	024000495

T101



- 920B 10-12-13-14-15
16-17-18-19-21
22-24 mm
- 920/21 125 mm
- 920/25
- 920/42 305 mm
- 920/55

2,1 kg

12"



	Ft		
T101	104.200	1	024240101
TV100	11.950	1	024000495

T102



- 920AS 3/8-7/16-1/2
9/16-5/8-11/16
3/4-13/16-7/8
15/16-1-1.1/16
- 920/21 125 mm
- 920/25
- 920/42 305 mm
- 920/55

2,1 kg

12"



	Ft		
T102	113.900	1	024240102
TV100	11.950	1	024000495

T103



- 900L 6-7-8-9-10-11-12 mm
- 920AL 13-14-16-17-18-19
21-22-24-27 mm

1,1 kg

14" 12"



	Ft		
T103	134.100	1	024240103
TV103	11.950	1	024000748

T105



- 928A 22-24-27-30-32-34
36-38-41-46-50 mm

4,9 kg

3/4"



	Ft		
T105	136.300	1	024240105
TV105	11.950	1	024000484

T106



- 928/21 200 mm
- 928/22 380 mm
- 928/42 450 mm
- 928/55

4,5 kg

3/4"



	Ft		
T106	142.800	1	024240106
TV106	11.950	1	024000485

T111



- 720 10-13-15-17-18-19-21
22-24-27-30-32 mm
- 720LC 17-19-21 mm
- 720/21 125 mm

2,7 kg

12"



	Ft		
T111	114.700	1	024240111
TV111	11.950	1	024000476

T112



- 861TX ● 1/4-T6+T15
- 866TX ● 5/16-T20+T55
- 895/1 ○ 1/4x□1/4
- 895/6 ○ 5/16x□1/2
- 900FTX □ 1/4-E4+E10
- 920FTX □ 1/2-E12+E24
- 920TX □ 1/2-T55L-T60-T70L

1,3 kg

14" 12"



	Ft		
T112	136.000	1	024240112
TV112	11.950	1	024000480

T113



- 920PE 5L-6L-7L-8L-10L
- 920TX T40L-T45L
T55L-T70L
- 920XZN M6L-M8L-M12L

1,5 kg

12"



	Ft		
T113	119.000	1	024240113
TV113	11.950	1	024000489

T122



- 666/20 40 - 200 Nm

1,2 kg

12"



	Ft		
T122	132.200	1	024240122
TV122	11.950	1	024000768

T123



- 1082G 160 mm
- 1150G 180 mm
- 1166G 160 mm

550 g



	Ft		
T123	36.150	1	024240123
TV135	11.950	1	024000762

T124



- 1082GBM 160 mm
- 1150GBM 180 mm
- 1166GBM 160 mm

640 g



T124	Ft 45.800	1	024240124
TV135	Ft 11.950	1	024000762

T135



- 1082MQ 160 mm
- 1150MQ 180 mm
- 1166MQ 160 mm

1000 V

750 g



T135	Ft 76.900	1	024240135
TV135	Ft 11.950	1	024000762

T136



- 1048MQ 250 mm
- 1777MQ/U 190 mm

1000 V

700 g



T136	Ft 54.850	1	024240136
TV136	Ft 11.950	1	024000438

T137



- 1084BM 160 mm
- 1150BM 180 mm
- 1166BM 160 mm

750 g



T137	Ft 52.150	1	024240137
TV130	Ft 11.950	1	024000451

T138



- 1084 160 mm
- 1150 180 mm
- 1166 160 mm

650 g



T138	Ft 42.450	1	024240138
TV130	Ft 11.950	1	024000451

T140



- 1032 140x0,9 - 180 mm
- 1034 170 mm
- 1036 140x1,3 - 175 mm
- 1038 175 mm
- 1084 160 mm
- 1128BM 145 mm

1,1 kg



T140	Ft 105.900	1	024240140
TV140	Ft 15.800	1	024000405

T144



- 1048N 250 mm
- 1052 240 mm
- 1112 250 mm
- 1150 180 mm

1,8 kg



T144	Ft 63.650	1	024240144
TV143	Ft 15.800	1	024000409

T145



- 1032 180 mm
- 1034 170 mm
- 1036 175 mm
- 1038 175 mm

640 g



T145	Ft 57.950	1	024240145
TV145	Ft 11.950	1	024000448

T146



- 1032 140x0,9 mm
- 1032 225 mm
- 1036 140x1,3 mm
- 1036 225 mm

700 g



T146	Ft 60.850	1	024240146
TV146	Ft 11.950	1	024000449

T151



- 1047 240 mm
- 1057A 240 mm

1,3 kg



T151	Ft 52.800	1	024240151
TV150	Ft 11.950	1	024000462

T153



- 1048N 250 mm
- 1052 240 mm

1,1 kg



T153	Ft 34.750	1	024240153
TV150	Ft 11.950	1	024000462

T156



- 1082 160 mm
- 1150 180 mm
- 1048N 250 mm

1 kg



T156	Ft 44.250	1	024240156
TV148	Ft 11.950	1	024000500

T157



- 1082BM 160 mm
- 1150BM 180 mm
- 1048BM 250 mm



1,1 kg



	Ft		
T157	57.050	1	024240157
TV148	11.950	1	024000500

T160



- 1290 3x75
3x100
4x100
4x150
5,5x100
5,5x150
6,5x150
8x150
10x200 mm
- 1290N 4x30
6,5x30 mm



1,3 kg



	Ft		
T160	63.550	1	024240160
TV160	15.800	1	024000706

T161



- 1292 PH0x60
PH0x100
PH1x80
PH1x120
PH2x100
PH2x150
PH3x150 mm
- 1292N PH1x30
PH2x30 mm



1 kg



	Ft		
T161	49.950	1	024240161
TV161	15.800	1	024000707

T164



- 952 8-10-13-17-19 mm
- 959 16 mm (5/8") - 20,8 mm (13/16")
- 1260 3x75 - 4x100 - 5,5x100 - 6,5x150 - 10x200 mm
- 1262 PH0x60 - PH1x80 - PH2x100 - PH3x150 mm



5 kg



	Ft		
T164	213.700	1	024240164
TV61	23.700	1	024000721

T167



- 1260 3x75
3x100
4x100
4x150
5,5x100
5,5x150
6,5x150
8x150
10x200 mm
- 1260N 4x30
6,5x30 mm



1,3 kg



	Ft		
T167	50.550	1	024240167
TV160	15.800	1	024000706

T168



- 1262 PH0x60
PH0x100
PH1x80
PH1x120
PH2x100
PH2x150
PH3x150 mm
- 1262N PH1x30
PH2x30 mm



1 kg



	Ft		
T168	40.800	1	024240168
TV161	15.800	1	024000707

T170



- 1290 2,5x50
3x75
3,5x100
4x125
5,5x100
5,5x150
6,5x150 mm



450 g



	Ft		
T170	34.400	1	024240170
TV170	11.950	1	024000741

T171



- 1290 8x150
8x200
10x200 mm
- 1290N 4x30
6,5x30 mm



750 g



	Ft		
T171	38.200	1	024240171
TV171	11.950	1	024000742

T172



- 1292 PH0x60
PH0x100
PH1x80
PH1x120
PH2x100
PH2x150 mm



450 g



	Ft		
T172	31.400	1	024240172
TV172	11.950	1	024000743

T173



- 1292 PH3x150
PH4x200 mm
- 1292N PH1x30
PH2x30 mm



560 g



	Ft		
T173	30.700	1	024240173
TV173	11.950	1	024000744

T175



- 1297TX T6-T7-T8-T9
T10-T15-T20



410 g



	Ft		
T175	48.950	1	024240175
TV175	11.950	1	024000760

T176



- 1297TX T25-T27-T30
T40-T45



640 g



	Ft		
T176	44.750	1	024240176
TV176	11.950	1	024000761

T177



1298RTX T9-T10-T15
T20-T25-T27
T30-T40

680 g



T177	Ft 67.950	1	024240177
TV177	Ft 11.950	1	024000759

T180



1290 3x75
4x100
5,5x150
6,5x150 mm
1292 PH0x60
PH1x80
PH2x100 mm

480 g



T180	Ft 35.850	1	024240180
TV180	Ft 11.950	1	024000701

T183



1292L PH1x400-PH2x400 mm
1294L 3x300-4x400-5x400 mm

580 g



T183	Ft 48.500	1	024240183
TV183	Ft 11.950	1	024000497

T198



1260 3x75
4x100
5,5x150
6,5x150 mm
1269PZ PZ0 - PZ1 - PZ2

490 g



T198	Ft 30.500	1	024240198
TV180	Ft 11.950	1	024000701

T199



1260 2,5x50
3x75
3,5x100
4x125
5,5x100
5,5x150
6,5x150 mm

490 g



T199	Ft 27.400	1	024240199
TV170	Ft 11.950	1	024000741

T201



1260 8x200
10x150
10x200 mm
1260N 4x30
6,5x30 mm

680 g



T201	Ft 29.900	1	024240201
TV171	Ft 11.950	1	024000742

T202



1262 PH0x60
PH0x100
PH1x80
PH1x120
PH2x100
PH2x150 mm

490 g



T202	Ft 25.300	1	024240202
TV172	Ft 11.950	1	024000743

T205



1267TX T6-T7-T8-T9
T10-T15-T20

460 g



T205	Ft 35.950	1	024240205
TV175	Ft 11.950	1	024000760

T206



1267TX T25-T27-T30
T40-T45

710 g



T206	Ft 37.050	1	024240206
TV176	Ft 11.950	1	024000761

T207



1268RTX T9-T10-T15
T20-T25-T27-T30

760 g



T207	Ft 43.600	1	024240207
TV207	Ft 11.950	1	024000758

T204



1262 PH3x150
PH4x200 mm
1262N PH1x30
PH2x30 mm

610 g



T204	Ft 24.850	1	024240204
TV173	Ft 11.950	1	024000744

T208



1260 3x75
4x100
5,5x150
6,5x150 mm
1262 PH0x60
PH1x80
PH2x100 mm

530 g



T208	Ft 29.000	1	024240208
TV180	Ft 11.950	1	024000701

T209



- 1262L PH1x400-PH2x400 mm
- 1264L 3x300 - 4x400 - 5x400 mm

580 g



	Ft		
T209	36.200	1	024240209
TV183	11.950	1	024000497

T211



- 1201E 2,5x50
3x75
3,5x100
4x125
5,5x100
5,5x150
6,5x150 mm

490 g



	Ft		
T211	19.450	1	024240211
TV170	11.950	1	024000741

T213



- 1202E PH0x60
PH1x80
PH1x120
PH2x100
PH2x150
PH3x150 mm

490 g



	Ft		
T213	21.100	1	024240213
TV212	11.950	1	024000440

T216



- 1207E/TX T6-T7-T8-T9
T10-T15-T20

410 g



	Ft		
T216	27.000	1	024240216
TV175	11.950	1	024000760

T221



- 1201E 3x75
4x100
5,5x150
6,5x150 mm
- 1202E PH0x60
PH1x80
PH2x100 mm

530 g



	Ft		
T221	20.450	1	024240221
TV180	11.950	1	024000701

T226



- 1274MQ 3x100
4x100
5,5x125
6,5x150 mm
- 1272MQ PH0x60
PH1x80
PH2x100 mm

⚡ 1000 V

460 g



	Ft		
T226	44.000	1	024240226
TV180	11.950	1	024000701

T227



- 944BX 5-6-7-8-10-13 mm

490 g



	Ft		
T227	62.600	1	024240227
TV227	11.950	1	024000705

T228



- 1290INOX 3x75 - 4x100 -
5,5x150 - 6,5x150 mm
- 1292INOX PH0x60
PH1x80 - PH2x100 mm



480 g



	Ft		
T228	40.200	1	024240228
TV180	11.950	1	024000701

T231



- 1370 400 g
- 1390 Ø 35 mm
- ▲ 1719BMA/T 200 mm
- ▮ 1719BMA/P 200 mm
- ▷ 1719BMA/M 200 mm

1,7 kg



	Ft		
T231	54.150	1	024240231
TV230	15.800	1	024000411

T233



- 35 100-200 mm
- 1370F 32 mm
- 1390 Ø 35 mm

1,3 kg



	Ft		
T233	50.150	1	024240233
TV232	11.950	1	024000452

T234



- 35 100-200 mm
- 1370 300 g
- 1390 Ø 35 mm

1,3 kg



	Ft		
T234	44.450	1	024240234
TV232	11.950	1	024000452

T236



- 1719BMA/Q 200 mm
- ▲ 1719BMA/T 200 mm
- ▮ 1719BMA/P 200 mm
- ▷ 1719BMA/M 200 mm
- 1719BMA/R 200 mm

870 g



	Ft		
T236	44.050	1	024240236
TV235	11.950	1	024000453

T239



31BM Ø 2-3-4-5-6-8 mm
32 Ø 4 mm



850 g



	Ft		
T239	58.500	1	024240239
TV239	11.950	1	024000439

T241



1500N/1
1500N/3
1516/1



4,2 kg



	Ft		
T241	137.900	1	024240241
TV241	15.800	1	024000414

T259



○ 96BP 2,5-3-4-5
6-8-10 mm
○ 96N 12 mm
● 861MIX/A31
○
+
+
+
+
895/1



950 g



	Ft		
T259	61.900	1	024240259
TV263	11.950	1	024000492

T264



1491 Ø 65+110 mm
■ 1494 ■ 10 mm
○ 1494E ○ 8 - 9 - 10 - 11 - 12 - 14 - 17 mm
○ 1494Q ○ 8-9,5-12-13 mm
△ 1494T △ 9,5
○ 1494XZN ○ 16
1496C ■ 8x ■ 10 mm



2,1 kg



	Ft		
T264	103.500	1	024240264
TV264	11.950	1	024000466

T270



430 M3 - 4 - 5 - 6 - 7 - 8 - 9
10 - 12 - 14 - 16 - 18 - 20
433 M6x0,75 - M8x1 - M10x1,25
M12x1,5 - M14x1,5
M16x1,5 - M18x1,5
440 M3 - 4 - 5 - 6 - 7 - 8 - 9
440A M10 - 12 - 14 - 16 - 18 - 20
441 M6x0,75 - M8x1,0
441A M10x1,25 - M12x1,5
M14x1,5 - M16x1,5
M18x1,5

4,3 kg



	Ft		
T270	238.900	1	024240270
TV270	15.800	1	024000481

T271



1741 250 mm
1741RV2,9K 2,9x6 mm (100)
1741RV3,2K 3,2x8 mm (100)
1741RV3,8K 3,8x10 mm (100)
1741RV4K 4x12 mm (100)
1741RV4,8K 4,8x12 mm (100)

1,4 kg



	Ft		
T271	34.100	1	024240271
TV271	11.950	1	024000475

T273



435/1,5 M3+M12
435/3 M5+M21
436/1 □ 2,0+5,0 mm
(M3+M8)
436/2 □ 4,6+8 mm
(M5+M12)
444/1 Ø 25,4 mm
444/2 Ø 38,1 mm
1707 W 62+4x1"

2,1 kg



	Ft		
T273	108.600	1	024240273
TV272	15.800	1	024000482

T279



1112 250 mm
1128BM 145 mm
1726 400 mm
1728BM (x5)
1751N 200 cc

1,5 kg



	Ft		
T279	58.850	1	024240279
TV285	19.650	1	024000487

T284



1128BMX 147 mm
1130BMX 185 mm
■ 1719BMA...Q 200 mm
▲ 1719BMA...T 200 mm
■ 1719BMA...P 200 mm
▶ 1719BMA...M 200 mm
● 1719BMA...R 200 mm
1726BM 400 mm
1728BM
1771BM 170 mm
1778V18 185 mm

3,3 kg



	Ft		
T284	117.000	1	024240284
TV286	23.700	1	024249904

T291



1479RB/1
1479RB/2
1479RB/3

600 g



	Ft		
T291	46.700	1	024240291
TV291	11.950	1	024000472



T294



1692 5 m
1725CR
1771RL
1771 170 mm



590 g



	Ft		
T294	32.200	1	024240294
TV294	11.950	1	024000491

T297



1651DGTB
1682 300 mm
1691BM 5 m



490 g



	Ft		
T297	64.750	1	024240297
TV296	11.950	1	024000749

VP1 - VP2

ABS hőformált tálcák rendező műanyag dobozokkal az RSC22, RSC23, RSC23C hordozható szerszámosládához

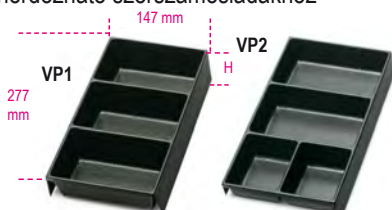

	H mm	Ft		
VP1	50	6.800	1	088880351
VP2	35	6.800	1	088880352

VP3 - VP4

ABS hőformált tálcák rendező műanyag dobozokkal minden szerszámosláda és szerszámkocsi modellhez

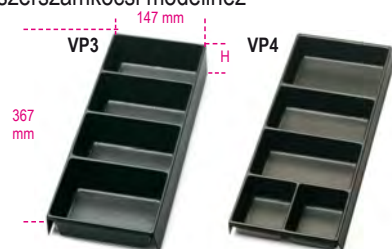

	H mm	Ft		
VP3	50	7.170	1	088880353
VP4	35	7.170	1	088880354

VP5

ABS hőformált tálcá 2 darab rendező műanyag dobozzal



	H mm	Ft		
VP5	45	8.100	1	088880355

VP6

ABS hőformált tálcá 6 darab rendező műanyag dobozzal



	H mm	Ft		
VP6	45	8.260	1	088880359

VP7-C

ABS hőformált tálcá 3 rendezőtálcával a C45PRO szerszámkocsikhoz



	H mm	Ft		
VP7-C	45	6.030	1	088880361

VP-3SC

ABS hőformált tálcá 3 darab rendező műanyag dobozzal a C04TSS-7 szerszámkocsihoz

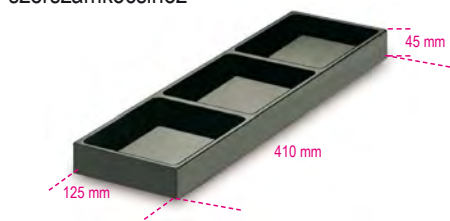

	H mm	Ft		
VP-3SC	45	8.620	1	088880356

VP-LS

ABS hőformált tálcá rendező műanyag dobozzal a C04TSS-7 szerszámkocsihoz



	H mm	Ft		
VP-LS	45	5.870	1	088880357

8889P1

párhuzamos fiókelválasztó a RSC22, RSC23, RSC23C és C27S fiókjaihoz
fiókméret 588x277 mm



	h	Ft		
8889P1/5	50 mm	22.850	1	088890005
8889P1/7	70 mm	23.450	1	088890007

8889C1

keresztirányú fiókelválasztó a RSC22, RSC23, RSC23C és C27S fiókjaihoz
fiókméret 588x277 mm



	h	Ft		
8889C1/5	50 mm	30.450	1	088890015
8889C1/7	70 mm	31.050	1	088890017

8889P2

párhuzamos fiókelválasztó szabványos, 588x367 mm fiókhöz



	h	Ft		
8889P2/7	70 mm	27.500	1	088890107

8889C2

keresztirányú fiókelválasztó szabványos, 588x367 mm fiókhöz



	h	Ft		
8889C2/7	70 mm	35.100	1	088890117

8889P3

párhuzamos fiókelválasztó a RSC24AXL, RSC24AXLP/7, RSC24AXXL fiókjaihoz

fiókméret 882x367 mm



	h	Ft		
8889P3/7	70 mm	43.800	1	088890207

8889C3

keresztirányú fiókelválasztó a RSC24AXL, RSC24AXLP/7, RSC24AXXL fiókjaihoz
882x367 mm fiókhöz

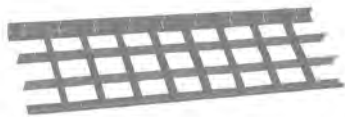

h	Ft	1	088890217
8889C3/7 70 mm	53.500	1	088890217

8889P4

párhuzamos fiókelválasztó a C41 húzható szerzőkocsihoz
fiók méret 418x205 mm



h	Ft	1	088890307
8889P4/7 70 mm	18.400	1	088890307

8889I4

keresztirányú fiókelválasztó a C41 húzható szerzőkocsihoz
fiók méret 418x205 mm

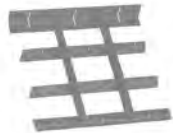

h	Ft	1	088890317
8889C4/7 70 mm	22.200	1	088890317

8889PS

párhuzamos fiókelválasztó a C45PRO 2.0 M4/M5/M7/M8/M3A/ACT/TC fiókjaihoz

fiók 566x406 mm



h	Ft	1	088890407
8889PS/7 70 mm	32.550	1	088890407

8889CS

keresztirányú fiókelválasztó a C45PRO 2.0 M4/M5/M7/M8/M3A/ACT/TC fiókjaihoz
fiók 566x406 mm

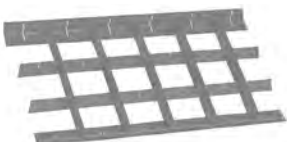

h	Ft	1	088890417
8889CS/7 70 mm	39.650	1	088890417

8889C6

keresztirányú fiókelválasztó a C35 fiókjaihoz

fiók méret 600x447 mm



h	Ft	1	088890475
8889C6/7,5 75 mm	17.000	1	088890475
8889C6/10 100 mm	16.800	1	088890480
8889C6/15 150 mm	20.650	1	088890485
8889C6/20 200 mm	32.400	1	088890490

SB

Dugókulcs tartó sínek



L mm	Ft	10	088880201
SB1 210	1.740	10	088880201
SB2 280	1.920	10	088880202
SB3 360	2.020	10	088880203

PM 1/2-Q5

mágneses dugókulcs tartó



Ft	1	088880233
PM 1/2-Q5 21.250	1	088880233

MB

Dugókulcs-csiptetők



□	Ft	50	088880210
MB0 1/4	520	50	088880210
MB1 3/8	520	50	088880211
MB2 1/2	520	50	088880212

KIT/GPS

40 mm akasztó tiplivel és csavarral

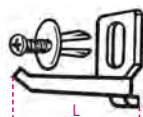

L mm	Ft	50	088880119
KIT/GPS-40 mm 40	995	50	088880119
KIT/GPS-90 mm 90	1.460	50	088880117

VE1

tipli csavarral



Ft	20	088880120
VE1 350	20	088880120

GM

rugós szerszámtartó VE1 tiplis csavarral



Ø mm	Ft	5	088880250
6,5	3.180	5	088880250
9,5	3.320	5	088880251
13	3.320	5	088880252
16	3.930	5	088880253
19	4.090	5	088880254
25	3.850	5	088880255

S55/8

villáskulcsstartó

• 3 darab VE1 tiplis csavarral szállítva

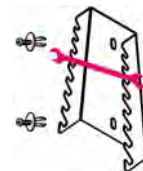

Ft	1	088880420
S55/8 10.950	1	088880420

S55/12

villáskulcsstartó

• 3 darab VE1 tiplis csavarral szállítva

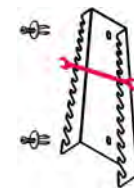

Ft	1	088880421
S55/12 13.350	1	088880421

ST2P

fogó tartó

• 3 darab VE1 tiplis csavarral szállítva

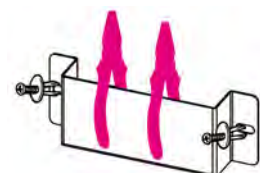

Ft	1	088880422
ST2P 11.950	1	088880422

TSPP

műanyag szerszámtartó

- 3 darab VE1 tiplis csavarral szállítva

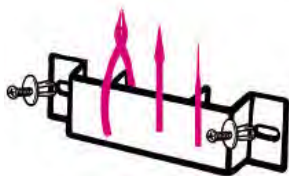

TSPP Ft 2.690 1 088880402

S952/10

T-kulcs tartó

- 3 darab VE1 tiplis csavarral szállítva

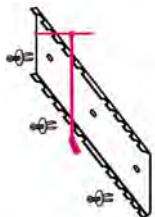

S952/10 Ft 14.150 1 088880423

S1719BM

reszelőtartó

- 3 darab VE1 tiplis csavarral szállítva



S1719BM Ft 8.260 1 088880404
1719BMA: Q-T-P-M-R
1719BMD: Q-T-P-M-R
1719BMX: Q-T-P-M-R

SGN

csavarhúzó tartó

- 3 darab VE1 tiplis csavarral szállítva



SGN Ft 4.170 1 088880405
1290N-1292N-1299N/PZ
1260N-1262N-1269N/PZ
1201EN-1202EN-1209EN/PZ

 Beta

 Beta

CB/2

hőformált tálcá 1/2"-os dugókulcshoz és tartozékokhoz, üres

- csak a C54S szerszámszekrényhez

12"

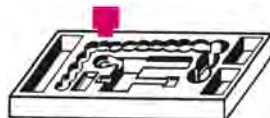

CB/2 Ft 12.750 1 088880411
920A/920B
10÷24+26-27
28-30-32 mm
920/21-920/22-920/25-
920/42-920/55

S42/17

csillag-villáskulcs tartó

- 3 darab VE1 tiplis csavarral szállítva



S42/17 Ft 13.950 1 088880428
42/S17
42MP/S17
42/S17X
42AS/17
142/S17

S951/6

T-szárú imbuszkulcs tartó

- 3 darab VE1 tiplis csavarral szállítva

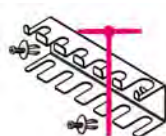

S951/6 Ft 9.310 1 088880429
951/S6
951AS/S6X
951TX/S6

SPG11 - S1203/8

csavarhúzó tartó

- 3 darab VE1 tiplis csavarral szállítva



SPG11 Ft 9.680 1 088880910
n.8 Ø = 7 mm
n.2 Ø = 10 mm
n.1 Ø = 12 mm
S1203/8 10.300 1 088880430
1203E/S8
1263/D8
1293/S8

S96T/8

imbuszkulcs tartó

- 3 darab VE1 tiplis csavarral szállítva



S96T/8 Ft 10.300 1 088880431
96T/AS8
96T/S8
97TTX/S8

96T/SPV

imbuszkulcs tartó

- 3 darab VE1 tiplis csavarral szállítva

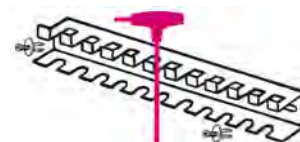

96T/SPV Ft 20.050 1 000960958
96T/S11
97TTX/S11

 Beta



Anaerob termékek

Az anaerob termékek kitöltik a fémszerkezetek apró felszíni egyenetlenségeit, s ezzel lehetővé teszik a mechanikai feszültség teljes érintkező felületen való eloszlását. Oxigén hiányában megkeményednek és a víz, gáz, olaj, üzemanyag és ipari folyadékok ellen tökéletes tömítést biztosítanak a kötések és menetek számára.

A különböző igények kielégítésére három ellenállási osztályban (alacsony, közepes, nagy) és többféle kiszerezésben kapható.

Ragasztó

Különböző anyagok, például beton, üveg, gipszkarton, kerámia, fa, fém és műanyagok ragasztására alkalmas univerzális szerelő pillanatragasztó. Az innovatív kohéziós hatásának köszönhetően gyors és szilárd adhéziót biztosít, akár rögzítés nélkül is.

Tömítőanyagok

A Beta tömítőanyagok három kulcstermékből áll.

Az akril tömítő ideális lépcsők, szegélylécek, ajtó- és ablakkeretek, valamint sok más hatékony tömítésére. Festhető és tartós, így hibátlan, tartós fugákat eredményez.

A hagyományos ecetsavas szilikon tökéletes választás a konyhai és fürdőszobai fugák tömítésére. Ez a termék zománczott felületeken, üvegen, festett fán és kerámián egyaránt kiváló tömítést biztosít.

A harmadik tömítőfajta, a professzionális semleges szilikon szagtalan, ellenáll a penészesnek, az UV sugárzásnak és az időjárás viszontagságainak. Ideális fürdőszobák és konyhák tömítésére, valamint beton, falazat és üvegfalak dilatációs hézagjainak tömítésére.

Poliuretán hab

A sokoldalú és nagy teljesítményű poliuretán hab ideális partner az építőiparban, ha szigetelésre, tömítésre vagy rögzítésre van szükség. Gyorsan tágul, és számos anyaghoz tökéletesen tapad, miközben ellenáll a nedvességnek és a szélsőséges hőmérsékleteknek. Kiváló hőszigetelő és hangszigetelő tulajdonságokkal rendelkezik, ezáltal jobb energiahatékonyságot és beltéri komfortot biztosít.

Szilikon tömítőanyag

A szilikon tömítőanyag tartós, rugalmas tömítést képez, amely megakadályozza az apró anyagok (törmelék, por stb.) kötésekre kerülését, így tömítőgyűrű helyett is alkalmazható. Rugalmasságának köszönhetően elnyeli a mozgást, nem tágul vagy törik. A légköri nedvességgel reakcióba lépve polimerizálódik, rugalmas és tartós tömítést hozva létre.

Aeroszolak

Szórópalackos termékek széles skálája kötések oldásához, zsírzáshoz, kenéshez, tisztításhoz, galvanizáláshoz és fertőtlenítéshez.

Folyadékok

Mechanikus alkatrészekre és fém tárgyakra kialakult lerakódások és rozsdák eltávolítására. Ideális az 1895 típusú ultrahangos mosótálal való együttes használatra.



FIGYELEM!

A Beta Chemicals termékei a következő országokban forgalmazhatók: Ausztria, Andorra, Belgium, Cseh Köztársaság, Dominikai Köztársaság, Egyesült Arab Emírségek, Egyesült Királyság, Franciaország, Hollandia, Írország, Kínai Népköztársaság, Lengyelország, Magyarország, Monacói Hercegség, Olaszország, Portugália, Réunion, San Marino, Spanyolország, Svájc, Szlovákia, Szlovénia, Új-Kaledónia.

9803H

Menetragasztó – nagy szilárdságú

Tartós rögzítés, azokhoz az alkatrészekhez ideális, amelyeket nem kell szétszerelni, vagy passzívált fémfelületekhez, mint a réz, alumínium, rozsdamentes acél, stb.
Nem teszi lehetővé a kéziszerszámokkal történő szétszerelést.



Hőmérséklettartomány (°C)	-50/+150
Maximális hézatképződés (mm)	0,25
Száradási/kötési idő (percek)	10/15
Gyakorlati kötési idő (óra)	3-6
Viszkózitás (mPa.s) 25°C	800/1200
Oldónyomaték ISO-10964	35-45 Nm
Uralkodó nyomaték ISO-10964	30-40 Nm

ml		Ft		
20	palack	5.300	12	098030002
50	palack	8.060	4	098030005
250	palack	20.450	4	098030025
20	palack		12	098032002
50	palack		4	098032005
250	palack		4	098032025

9802M

Menetragasztó – közepes szilárdságú

A rendszeres karbantartásnak kitett alkatrészekhez, csapágyakhoz és perselyekhez ideális.
Lehetővé teszi a kéziszerszámokkal történő szétszerelést.



Hőmérséklettartomány (°C)	-50/+150
Maximális hézatképződés (mm)	0,15
Száradási/kötési idő (percek)	10/15
Gyakorlati kötési idő (óra)	3-6
Viszkózitás (mPa.s) 25°C	500/800
Oldónyomaték ISO-10964	22-30 Nm
Uralkodó nyomaték ISO-10964	20-25 Nm

ml		Ft		
20	palack	5.300	12	098020002
50	palack	8.060	4	098020005
250	palack	20.450	4	098020025
20	palack		12	098022002
50	palack		4	098022005
250	palack		4	098022025

9801L

Menetragasztó – alacsony szilárdságú

Ideális szabályozócsavarok és az olyan könnyűfém ötvözetek rögzítéséhez, amelyek könnyen megsérülhetnek a szétszerelés során.
Könnyebb szétszerelés.



Hőmérséklettartomány (°C)	-50/+150
Maximális hézatképződés (mm)	0,10
Száradási/kötési idő (percek)	10/15
Gyakorlati kötési idő (óra)	3-6
Viszkózitás (mPa.s) 25°C	500/800
Oldónyomaték ISO-10964	6-10 Nm
Uralkodó nyomaték ISO-10964	4-8 Nm

ml		Ft		
20	palack	5.300	12	098010002
50	palack	8.060	4	098010005
250	palack	20.450	4	098010025
20	palack		12	098012002
50	palack		4	098012005
250	palack		4	098012025

9813H

Menetítő – nagy ellenállású

Tartós rögzítés, olyan csecssavarak tömítéséhez ideális, amelyeket nem kell szétszerelni, vagy passzívált fémfelületekhez, mint a réz, alumínium, rozsdamentes acél, stb.
Nem teszi lehetővé a kéziszerszámokkal történő szétszerelést.



Hőmérséklettartomány (°C)	-50/+200
Maximális hézatképződés (mm)	0,15
Száradási/kötési idő (percek)	10/15
Gyakorlati kötési idő (óra)	3-6
Viszkózitás (mPa.s) 25°C	40.000/80.000
Oldónyomaték ISO-10964	35-45 Nm
Uralkodó nyomaték ISO-10964	25-35 Nm

ml		Ft		
20	palack	4.740	12	098130002
50	összecsukható palack	8.300	6	098130305
50	tubus	7.730	4	098130505
250	tubus	19.250	4	098130525
20	palack		12	098132002
50	összecsukható palack		6	098132305
50	tubus		4	098132505
250	tubus		4	098132525

9812M

Menetítő – közepes ellenállású

A rendszeres karbantartásnak kitett alkatrészekhez ideális.
Lehetővé teszi a kéziszerszámokkal történő szétszerelést.



Hőmérséklettartomány (°C)	-50/+150
Maximális hézatképződés (mm)	0,35
Száradási/kötési idő (percek)	12/18
Gyakorlati kötési idő (óra)	3-6
Viszkózitás (mPa.s) 25°C	20.000/40.000
Oldónyomaték ISO-10964	27-35 Nm
Uralkodó nyomaték ISO-10964	20-30 Nm

ml		Ft		
20	palack	4.740	12	098120002
50	összecsukható palack	8.300	6	098120305
50	tubus	7.730	4	098120505
250	tubus	19.250	4	098120525
20	palack		12	098122002
50	összecsukható palack		6	098122305
50	tubus		4	098122505
250	tubus		4	098122525

9811L

Menetítő – alacsony ellenállású

Kis csatlakozókhoz vagy finom menetekhez ideális.
Könnyebb szétszerelés.



Hőmérséklettartomány (°C)	-50/+150
Maximális hézatképződés (mm)	0,20
Száradási/kötési idő (percek)	10/15
Gyakorlati kötési idő (óra)	3-6
Viszkózitás (mPa.s) 25°C	10.000/20.000
Oldónyomaték ISO-10964	6-10 Nm
Uralkodó nyomaték ISO-10964	4-8 Nm

ml		Ft		
20	palack	4.740	12	098110002
50	összecsukható palack	8.300	6	098110305
50	tubus	7.730	4	098110505
250	tubus	19.250	4	098110525
20	palack		12	098112002
50	összecsukható palack		6	098112305
50	tubus		4	098112505
250	tubus		4	098112525

9823H

Folyékony tömítőanyag – nagy ellenállású

Felületek tartós tömítéséhez ideális. Tartós alkalmazás csapágyfészkek vagy kopott alkatrészek helyreállításához is ajánlott.

Nem teszi lehetővé a kéziszerszámokkal történő szétszerelést.



Hőmérséklettartomány (°C)	-50/+150
Maximális hézatkitöltés (mm)	0,35
Száradási/kötési idő (percek)	10/16
Gyakorlati kötési idő (óra)	3-6
Viszkozitás (mPa.s) 25°C	100.000/200.000
Oldónyomaték ISO-10964	35-45 Nm
Uralkodó nyomaték ISO-10964	20-30 Nm

ml	Ft	📦	🏠
20 palack	4.740	12	098230002
50 összecsukható palack	8.300	6	098230305
50 tubus	7.730	4	098230505
250 tubus	19.250	4	098230525
20 palack		12	098232002
50 összecsukható palack		6	098232305
50 tubus		4	098232505
250 tubus		4	098232525

9822M

Folyékony tömítőanyag – közepes ellenállású

A rendszeres karbantartást igénylő alkatrészekhez ideális. Lehetővé teszi a kéziszerszámokkal történő szétszerelést.



Hőmérséklettartomány (°C)	-50/+150
Maximális hézatkitöltés (mm)	0,35
Száradási/kötési idő (percek)	10/15
Gyakorlati kötési idő (óra)	3-6
Viszkozitás (mPa.s) 25°C	40.000/70.000
Oldónyomaték ISO-10964	25-35 Nm
Uralkodó nyomaték ISO-10964	20-30 Nm

ml	Ft	📦	🏠
20 palack	4.740	12	098220002
50 összecsukható palack	8.300	6	098220305
50 tubus	7.730	4	098220505
250 tubus	19.250	4	098220525
20 palack		12	098222002
50 összecsukható palack		6	098222305
50 tubus		4	098222505
250 tubus		4	098222525

9821L

Folyékony tömítőanyag – alacsony ellenállású

A rendszeres karbantartást igénylő alkatrészek felületének tömítéséhez ideális.

Védi a meneteket a korróziótól és a korróziós bemaródásoktól.

Könnyebb szétszerelés.



Hőmérséklettartomány (°C)	-50/+150
Maximális hézatkitöltés (mm)	0,35
Száradási/kötési idő (percek)	20/30
Gyakorlati kötési idő (óra)	3-6
Viszkozitás (mPa.s) 25°C	60.000/90.000
Oldónyomaték ISO-10964	7-11 Nm
Uralkodó nyomaték ISO-10964	4-9 Nm

ml	Ft	📦	🏠
20 palack	4.740	12	098210002
50 összecsukható palack	8.300	6	098210305
50 tubus	7.730	4	098210505
250 tubus	19.250	4	098210525
20 palack		12	098212002
50 összecsukható palack		6	098212305
50 tubus		4	098212505
250 tubus		4	098212525

9833H

Rögzítőanyag – nagy ellenállású

Azokhoz az alkatrészekhez ideális, amelyeket nem kell szétszerelni.

Alkalmazható a már beszerelt eszközök rögzítéséhez, ahol nehéz a szétszerelés.

Nem teszi lehetővé a kéziszerszámokkal történő szétszerelést.



Hőmérséklettartomány (°C)	-50/+180
Maximális hézatkitöltés (mm)	0,15
Száradási/kötési idő (percek)	10/15
Gyakorlati kötési idő (óra)	3-6
Viszkozitás (mPa.s) 25°C	400/700
Oldónyomaték ISO-10964	35-45 Nm
Uralkodó nyomaték ISO-10964	30-40 Nm

ml	Ft	📦	🏠
20 palack	4.980	12	098330002
50 palack	7.730	4	098330005
250 palack	19.850	4	098330025
20 palack		12	098332002
50 palack		4	098332005
250 palack		4	098332025

9832M

Rögzítőanyag – közepes ellenállású

A rendszeres karbantartást igénylő alkatrészekhez ideális. Lehetővé teszi a kéziszerszámokkal történő szétszerelést.



Hőmérséklettartomány (°C)	-50/+180
Maximális hézatkitöltés (mm)	0,25
Száradási/kötési idő (percek)	12/20
Gyakorlati kötési idő (óra)	3-6
Viszkozitás (mPa.s) 25°C	2000/4000
Oldónyomaték ISO-10964	25-35 Nm
Uralkodó nyomaték ISO-10964	18-28 Nm

ml	Ft	📦	🏠
20 palack	4.980	12	098320002
50 palack	7.730	4	098320005
250 palack	19.850	4	098320025
20 palack		12	098322002
50 palack		4	098322005
250 palack		4	098322025

9831L

Rögzítőanyag – alacsony ellenállású

A rendszeres karbantartást igénylő kis méretű alkatrészekhez ideális.

Könnyebb szétszerelés.



Hőmérséklettartomány (°C)	-50/+150
Maximális hézatkitöltés (mm)	0,10
Száradási/kötési idő (percek)	10/15
Gyakorlati kötési idő (óra)	3-6
Viszkozitás (mPa.s) 25°C	500/800
Oldónyomaték ISO-10964	6-10 Nm
Uralkodó nyomaték ISO-10964	4-8 Nm

ml	Ft	📦	🏠
20 palack	4.980	12	098310002
50 palack	7.730	4	098310005
250 palack	19.850	4	098310025
20 palack		12	098312002
50 palack		4	098312005
250 palack		4	098312025

9840BF - Beta Fix

szereelőragasztó

Ultraerős szerelő pillanatragasztó.

A kohéziós hatásnak köszönhetően a kötés során nem szükséges a ragasztott darabokat rögzíteni. Alkalmas beton, üveg, gipszkarton, kerámia, fa, fémek és műanyagok ragasztására (a PE, PP, PC, PMMA, PTFE, lágy műanyagok és neoprén kivételével). Festhető.

Alkalmazási javaslat: vigye fel a ragasztót egymástól 10-20 cm távolságra függőleges csíkokban. A ragasztandó munkadarabokat erősen nyomja össze. Ne pontokban vigye fel a ragasztót. Zsír- és pormentes kemény felületen használja. A ragasztót tartsa távol víztől és kloridoktól. Mozgó csatlakozásokra ne használja.



Jellemzők:

- Ultraerős, azonnali adhézió
- Nagy mechanikai ellenállás, ragasztóerő és rugalmas modul
- Izocianátokat, ftalátokat, oldószereket és szilikonot nem tartalmaz
- Tartósan rugalmas, nem zsugorodik össze, buborékmentes, szagtalan
- Ellenáll a párnának és az időjárás viszontagságainak
- Alapozás nélkül a legtöbb, akár nedves felületre is tapad

ml 290 Ft 6.560 12 098400029

9842W - Acryl Seal

akril tömítő

Festhető fehér akril tömítő lépcső, fal, plafon, szegélyléc, párkány, fa és fém ajtó- és ablakkeret, beton és falazat közötti hézagok kitöltésére.

Alkalmazási javaslat: kemény, száraz, zsír- és pormentes felületre vigye fel. Alapozás nélkül a legtöbb felületre tapad. A repedések elkerülése érdekében festés előtt várja meg, amíg teljesen megszárad. Vízbázisú és szintetikus festékekkel egyaránt használható. Vízrel folyamatosan érintkező felületekhez nem alkalmas.



CE

DoP nr. DOP-9842W
EN 15651-1: F-EXT-INT

Jellemzők:

- Vízbázisú és szintetikus festékekkel egyaránt festhető
- Bel- és kültéri használatra
- Szagtalan
- Alapozás nélkül legtöbb felületen alkalmazható, könnyű felvinni és tisztítani

ml 310 Ft 1.920 12 098420031



9843T - Multi Sil

többcélú ecetsavas szilikon tömítő

Átlátszó ecetsavas szilikon tömítő, ellenáll a penészesnek, UV sugárzásnak, víznek és az időjárás viszontagságainak. Tökéletesen tapad üveg, festett fa, kerámia és zománczott felületekre.

Alkalmazási javaslat: kemény, száraz, zsír- és pormentes felületre vigye fel. Alapozás nélkül a legtöbb felületre tapad. Nem festhető. Nem kompatibilis PE, PP, PC, PMMA, PTFE, lágy műanyag, neoprén és bitumenes felületekkel, betonnal, márvánnyal, ólommal, vörösrézrel és galvanizált acéallal.

CE



DoP nr. DOP-9843T
EN 15651-1: F-EXT-INT-CC
EN 15651-2: G-CC
EN15651-3: S (CLASS XS1)

Jellemzők:

- Penészálló
- Kiválóan vízálló, valamint ellenáll az UV sugárzásnak és az időjárás viszontagságainak
- Tartósan rugalmas
- Tökéletesen tapad üveg, festett fa, kerámia és zománczott felületekre

ml 280 Ft 2.590 12 098430028

9844T - Neutral Sil

Semleges szilikon tömítőanyag, átlátszó

Semleges szilikon tömítőanyag, átlátszó, amely ellenáll a penészesnek, az UV-sugaraknak, a víznek és az időjárás viszontagságainak. Szagtalan. Fürdőszobák és konyhák tömítésére alkalmas.

Nem értékesíthető az alábbi országokban: Portugália, Kína, Csehország, Szlovénia, Szlovákia.

CE



DoP nr. DOP-9844T
EN 15651-1: F-EXT-INT-CC (CLASS 12.5E)
EN 15651-2: G-CC
EN15651-3: S (CLASS XS1)

Jellemzők:

- Penészálló
- Ellenáll az UV-sugaraknak, a víznek és az időjárás viszontagságainak
- Szagtalan
- Rendkívül sokoldalúan felhasználható

ml 310 Ft 4.450 12 098440031

9860 - Multi Foam

poliuretán hab

Egykomponensű, kézi poliuretán hab szigetelő. Ideális ablakkeretek, válaszfalak, plafonok padlók, valamint falon és padlón átmenő csövek réseinek kitöltésére. Kiváló tapadást biztosít betonon, téglán, kővön, vakolaton, fán, fémen és műanyagokon. Festhető, vakolható.

Alkalmazási javaslat: távolítsa el a kupakot és csavarja a kinyomócsövet a szelepre. Használat előtt legalább hússzor rázza fel. Fordítsa a palackot fejjel lefelé és nyomja meg a gombot. Ablakkeretek esetén felhordás után legalább 24 óráig rögzítse a keretet. Festés és vakolás előtt várja meg, amíg teljesen megszárad. Használat közben védje a szemét; viseljen védőkesztyűt és egyéb védőfelszerelést. PE, PP, PC, PMMA, PTFE, puha műanyag, neoprén és bitumenes felületen nem tapad meg. Vízrel folyamatosan érintkező felületekhez nem alkalmas.



Jellemzők:

- Kiváló minőségű profi poliuretán hab
- Jó hőteljesítmény
- Szakítófeszültségnek, összenyomásnak és vágásnak kiválóan ellenáll

ml 750 Ft 4.940 12 098600075

9841N

Fekete szilikon tömítő

Magas hőmérséklettel szembeni ellenállás, kényelmes túlnyomós adagoló

Akár 240 °C-ig hőálló.

Tartós rugalmas tömítés. Tömítőgyűrű helyett. Az adagolóval könnyen (egy rétegben), pontosan és egyenletesen vihető fel a termék.

A légköri nedvességgel reakcióba lépve polimerizálódva rugalmas és tartós tömítést hoz létre. Ideális olajteknők, olajpumpák, házak, sebességváltók, a motor nagy nyomásnak nem kitétt részeinek, valamint magas hőmérséklettel szembeni ellenállást igénylő alkalmazások tömítésére. Legtöbb nem porózus felületen, így üvegen, bevont fán, kerámián és lakkon tökéletesen alkalmazható. Nem alkalmas PE, PP, PC, PMMA, PTFE, puha műanyag, neoprén és bitumenes felületeken. Nem festhető.

Az alábbi országokban nem kapható: Csehország, Kína, Portugália, Szlovénia, Szlovákia



ml 200 Ft 12.550 12 098410120

9841R

Piros szilikon tömítő
Magas hőmérséklettel szembeni ellenállás,
kényelmes túlnyomásos adagoló

Akár 300 °C-ig hőálló.
Tartós rugalmas tömítés. Tömítőgyűrű helyett.
Az adagolóval könnyen (egy rétegben), pontosan és
egyenletesen vihető fel a termék. A légköri nedvességgel
reakcióba lépve polimerizálódva rugalmas és tartós tömítést
hoz létre.
Ideális kemenceajtók, lemezek, fűtési rendszerek, kimenetek,
termosztátok, szivattyúk, fűtőcsövek, a motor nagy
nyomásnak nem kitétt részeinek, valamint magas
hőmérséklettel szembeni ellenállást igénylő alkalmazások
tömítésére. Legtöbb nem porózus felületen, így üvegen,
bevonat fán, kerámián és lakkon tökéletesen alkalmazható.
Nem alkalmas PE, PP, PC, PMMA, PTFE, puha műanyag,
neoprén és bitumen felületeken.
Nem festhető.

Az alábbi országokban nem kapható: Csehország, Kína,
Portugália, Szlovénia, Szlovákia



ml	Ft	12	12
200	11.750	12	098410020

9851

Pillanatragasztó strukturális kötésekhöz

Etil-cianoakrilát alapú.
Anyagok széles skálájának, mint a fém, műanyag, bőr, fa és
sok egyéb, egynemű vagy egymással kombinált anyag típus
ragasztására. Gyors kötés.

Az 5 g tubusos kiszerezés az alábbi országokban nem
kapható: Csehország, Kína, Lengyelország, Szlovénia,
Szlovákia



Hőmérséklet (°C)	-55/+82
Viszkozitás (mPa.s) 25 °C	80-120

g	Ft	12	12
5 tubus	2.570	12	098510500
20 palack	4.980	12	098510002
50 palack	9.760	10	098510005
20 palack	12	098512002	
50 palack	10	098512005	

9710 - LUBRIBETA universal

7-in-1 többcélú oldó-kenőanyag

1. Lazítás
 2. Kenés
 3. Tisztítás, zsirtalanítás
 4. Rozsdásodás gátlás
 5. Elektromos csatlakozók oxidáció mentesítése
 6. Vízálló
 7. Fagyálló
- Silicone-free.



ml	Ft	12	12
400		12	097100040
400	4.170	12	097101040
400		12	097102040

9712 - Ultra Sblock

Lazító kenőanyag kiemelkedő penetrációval

Kenés, oxidáció mentesítés, vízhatlanítás.
Ideális rozsdafeloldáshoz az anyáktól, csavaroktól,
menetekről és fogaskerekekről.



ml	Ft	12	12
400		12	097120040
400	3.060	12	097121040
400		12	097122040

9720 - Multi Grease

Többcélú kenőzsír

Különösen hasznos a láncok, fogaskerekek és mozgó fém
alkatrészek kenésére. Ellenáll a sűrűdésnek és az
időjárásnak. Kiválóan tapad. Nem csepeg.



ml	Ft	12	12
400		12	097200040
400	3.500	12	097201040
400		12	097202040

9722 - Lithium Grease

Fehér lítium zsír

Lítiumbázisú kenőzsír, titán- és cinkoxid szappanok
hozzáadásával. Ideális fogaskerekek, csapágyak és csuklók
kenéséhez. Speciálisan a tengeri alkalmazásokhoz
kifejlesztve. Rendkívül ellenálló a víz, a tengeri só, az időjárás
és a magas hőmérséklet (150 ° C-ig) ellen. Nem csepeg.



ml	Ft	12	12
400		12	097220040
400	3.950	12	097221040
400		12	097222040

9724 - PTFE Grease

PTFE-bázisú zsír

Különösen alkalmas az ipari láncok és a nagy nyomás és
alacsony fordulatszám melletti mechanikai mozgásokhoz.
Alkalmas műanyagokra és gumira. Teljesen szintelen. Vízálló
és ellenálló az oxidációval szemben.



ml	Ft	12	12
400		12	097240040
400	4.490	12	097241040
400		12	097242040

9726 - Copper Grease

Réz zsír

Alkalmas a magas hőmérsékleten működő (akár 1000 ° C)
csuklók, csavarok, fogaskerekek, hajtótengelyek és egyéb
fém alkatrészek kenésére. Védő, kopásgátló. Megakadályozza
az oxidációt. Nem csepeg.



ml	Ft	12	12
400		12	097260040
400	5.300	12	097261040
400		12	097262040

9729 - Silic Spray

Szilikon spray

Alkalmos műanyag, gumi és fém alkatrészek kenésére. Védi a korróziótól. Alkalmazható leválasztásra, antisztatikus, vízálló. Fa, műanyag és gumi polírozására is használható. Oldószer-mentes.



ml	Ft	🚚	🏠
400		12	097290040
400	3.060	12	097291040
400		12	097292040

9738 - Cutting Oil

Kenőanyag

Kiemelkedő kenés és védelem. Maráshoz, fúráshoz, menetmetszéshez, valamint kézi és automatikus gépi megmunkáláshoz ajánlott. Magas oxidációállóság. Vízrel lemosható. Oldószert nem tartalmaz.



ml	Ft	🚚	🏠
400		12	097380040
400	3.320	12	097381040
400		12	097382040

9740 - Brake Cleaner

Féktisztító spray

Ideális féktárcsák és fékbetétek, vagy a motorok tisztításához. Maradék nélkül eltávolítja a zsírt és a kátrányt. Gyorsan elpárolog, nem károsítja a műanyagokat és a gumit.



ml	Ft	🚚	🏠
500		12	097400050
500	2.980	12	097401050
500		12	097402050

9741 - Multi Cleaner

Többcélú tisztítószer/zsírtalanító

Zsír, olaj, kátrány, szilikon és ragasztó oldására alkalmas tisztító- és zsírtalanítószert. Alkalmos fém, kemény műanyag, kerámia, acél és alumínium felület tisztítására. Nem hagy olajos nyomot maga után.

Az alábbi országokban nem kapható: Csehország, Kína, Szlovénia, Szlovákia



ml	Ft	🚚	🏠
400		12	097410040
400	3.280	12	097411040

9742 - Contact Cleaner

Elektromos és elektronikus kontakt spray

Eltávolítja a zsírt és a szennyeződést, olajos maradék nélkül. Gyorsan elpárolog. Nem károsítja a műanyagokat és a gumit.



ml	Ft	🚚	🏠
400		12	097420040
400	3.280	12	097421040
400		12	097422040

9745 - Carb Cleaner

Karburátor és fojtószelepház tisztító spray

Karburátorok, szívóvezetékek és fojtószelepházak belső és külső tisztítására ajánlott. Teljesen eltávolítja a szenes maradványt, lerakódást és szennyeződéseket. Gyorsan párolog. Nem hagy olajos nyomot maga után. Az alábbi országokban nem kapható: Csehország, Kína, Lengyelország, Szlovénia, Szlovákia



ml	Ft	🚚	🏠
400		12	097450040
400	4.410	12	097451040

9746 - Clima Cleaner

Légkondicionáló tisztító

Ipari, háztartási és gépjármű légkondicionáló berendezések tisztításához. A kiváló habképződésnek és a mellékelt csőnek köszönhetően hatékonyan eltávolítja a koszt, lerakódást és megszünteti a kellemetlen szagokat a légszűrőben, kellemes illatot hagyva maga után.

Az alábbi országokban nem kapható: Csehország, Kína, Szlovénia, Szlovákia



ml	Ft	🚚	🏠
400		12	097460040
400	5.470	12	097461040

9749 - Air Spray

Levegő spray

Sűrített levegős spray. Ideális a hézagokban, szerelvényeken, elektromos részekben, billentyűzetben és általában a kényes berendezéseken megtelepedett por eltávolítására. A csövet az aeroszolos palackra rögzítve a nehezen megközelíthető részek is könnyen elérhetővé válnak.

Az alábbi országokban nem kapható: Andorra, Csehország, Kína, Dominikai Köztársaság, Egyesült Arab Emírátsok, Kína, Lengyelország, Magyarország, Portugália, Spanyolország, Szlovénia, Szlovákia



ml	Ft	🚚	🏠
400		12	097490040



9752 - Zinc 98%

Tiszta horgany

Magas fedőképesség, ideális a fémrészek galvanizálásánál. Nagyfokú tapadás, egy nagyon világos, rugalmas fóliát képez, hasonlóan a tűzi horganyzúzóhoz. Különösen ellenáll az oxidációnak, kopásnak és időjárásnak. Átfesthető. Nem csepeg.



ml	Ft		
400		12	097520040
400	3.810	12	097521040
400		12	097522040

9755 - Welding Spray

Fröccsenésgátló hegesztő spray

Szilikonmentes fröccsenésgátló hegesztő spray. Meggátolja a salakképződést, így a hegesztés könnyebb és gyorsabb. A hegesztendő felületek és a hegesztőpisztoly védelmére egyaránt használható. Lehetővé teszi a hegesztést követő felületkezelést, pl. festést, galvanizálást, krómozás végzését. Nem füstöl. Könnyen eltávolítható. Klórmentes.

Az alábbi országokban nem kapható: Csehország, Kína, Szlovénia, Szlovákia



ml	Ft		
400		12	097550040
400	3.460	12	097551040



9765 - Deicer Spray

Jégmentő spray

Jégmentő és jégmentő spray az ablakokon kialakult jég eltávolításához. Befagyott zárakhoz és mechanikus részekhez is ideális. Akár -40 °C-ig hatékony. Nem zsíros, nem maszatol. Nem károsítja a kezelt felületet, gumit és műanyagot.

Az alábbi országokban nem kapható: Csehország, Kína, Szlovénia, Szlovákia



ml	Ft		
400		12	097650040
400	5.750	12	097651040

9775 - Water Stop

impregnáló spray

Impregnáló, víztaszító spray textil és bőr anyagokhoz. Ideális lábbelik, dzsekik és egyéb ruhadarabok impregnálására. A kezelt anyag továbbra is jól szellőző marad. Foltálló tulajdonságának köszönhetően az anyagokat könnyebb mosni. Fokozottan gyűrődés- és kopásálló.

Az alábbi országokban nem kapható: Andorra, Csehország, Kína, Dominikai Köztársaság, Egyesült Arab Emírátsok, Kína, Lengyelország, Magyarország, Portugália, Spanyolország, Szlovénia, Szlovákia



ml			
400		12	097750040

9881U

Ipari lúgos tisztítószer ultrahangos mosóberendezéshez

Ipari lúgos tisztítószer koncentrátum, vízalapú. Ultrahangos tisztításhoz és egyéb tisztító eljárásokhoz. Alkatrészek és általában fém darabok (befecskendező, karbutátor, szelep, stb.) pontos és hatékony tisztításához. Eltávolítja az olajat, zsírt, kenőanyagokat, ragasztó-, gyanta- és viaszmaradékot. Alumínium darabok tisztítására is alkalmas.



Lt	Ft		
1	16.000	1	098810010
1		1	098812010

9882R

Szelektív rozsdaeltávolító folyadék

Vízalapú szelektív rozsdaeltávolító folyadék vas, acél, rozsdamentes acél, öntöttvas és krómozott felületekre. Eltávolítja az oxidált felületet az alatta lévő fémréteg károsítása nélkül.

Hígítás: tisztán vagy maximum 1:1 arányban hígítva használható.

Minimum felhasználási hőmérséklet: 15 °C. Hatóidő: 30 perctől 24/48 óráig (vastag rozsdá). Biológiailag legombló és 100%-ban vízben oldható.



Lt	Ft		
1	19.450	1	098820010
1		1	098822010

Beta

Beta



Beta ABRASIVES

KEMÉNY VÁGÓ- ÉS CSISZOLÓKORONGOK

Az új termékcsalád fő kategóriáját a kemény korongok alkotják, a Beta Utensili ezekhez a legjobb anyagokat és megoldásokat választotta.

A vágó- és csiszolókorongok a megfelelő célszerszámokkal, sarokcsiszolóktól kezdve a telepített berendezésekig a leggyorsabb és legsokoldalúbb megoldást kívánják a szakemberek számára.

KORONG FORMÁK

T42
süllyesztett agyú vágókorong

T41
egyenes vágókorong

T27
süllyesztett agyú csiszolókorong



Minőség kompromisszumok nélkül: a legigényesebb felhasználók számára



Nagy teljesítményt biztosító kiváló minőség versenyképes áron, a legjobb ár/minőség arány.

TANÚSÍTVÁNY



A korongokon elhelyezett PIKTOGRAMOK



Viseljen védőszemüveget



Olvassa el a használati utasítást



Viseljen fülvédőt



Csak vágásra. Nem csiszolókorong.



Viseljen porvédő maszkot



Ne használja a korongot, ha sérült



Viseljen védőkesztyűt



Vas-, kén- és klórmentes ($\leq 0,1\%$)



Viseljen védőruházatot

CSAPOS DÖRZSKORONGOK

A csapos, lamellás korong rugalmas lamelláival pontos, homogén eredmény érhető el szabálytalan formákon és felületeken.



LAMELLÁS KORONGOK

A csiszolótárcsák egy hordozó felületre ragasztott csiszolóvászon lamellákból állnak, melyek kiváló választást jelentenek nagyoláshoz és simításhoz. Összességében a csiszolókorongoknál gyorsabb leválasztást, homogénebb felületet, gyengébb vibrációt, alacsonyabb zajszintet és működési hőmérsékletet biztosítanak. Különböző szemcseméretű és különböző csiszolóanyagokkal készült vászonnál, két különböző hordozóanyaggal kaphatók.



Formák

Lapos

A megmunkálandó felülethez képest maximum 15°-os szögben használandó; lapos felületek és élek megmunkálásához ajánlott.

Kúpos

A megmunkálandó felülethez képest 15°-25° között használandó; megkönnyíti az egyenetlen felületek megmunkálását. Nagyobb érintkezési felületet biztosít a korong és a munkadarab között. A lamellák teljes kopásig használhatók.



CSAPOS DÖRZSKORONGOK

A csapos lamellás korong rugalmas lamelláival pontos, homogén eredmény érhető el szabálytalan formákon és felületeken.

TERMÉK MINŐSGMEGŐRZÉSI IDEJE

Termék minőségmegőrzési ideje: gyártás időpontjától számított 3 év. A korong közepén lévő fém tárcsára gravírozott "V01" a lejárat negyedévét jelöli. Példa: A "V07/2022" jelöléssel ellátott korong 2019. III. negyedévében készült és 2022. III. negyedévéig használható.



	Negyedév
V01	jan.-márc.
V04	ápr.-jún.
V07	júl.-szept.
V10	okt.-dec.

11001

süllyesztett agyú
acél vágókorongok
A30S EN 12413



A30S



	Ø mm	S mm	F mm	max. rpm	Ft		
11001	115	3,2	22,23	13300	835	10	110010118
11001	125	3,2	22,23	12200	880	10	110010128
11001	230	3,2	22,23	6600	1.920	10	110010233

11011

süllyesztett agyú
acél csiszolókorongok
A24N EN 12413



A24N

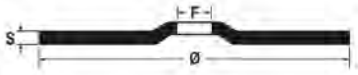

	Ø mm	S mm	F mm	max. rpm	Ft		
11011	115	6,5	22,23	13300	1.130	10	110110115
11011	125	6,5	22,23	12200	1.230	10	110110125
11011	230	6,5	22,23	6600	3.520	10	110110230

11021

süllyesztett agyú acél és rozsdamentes acél
vágókorongok
A30Q EN 12413



A30Q



	Ø mm	S mm	F mm	max. rpm	Ft		
11021	115	3,2	22,23	13300	835	10	110210118
11021	125	3,2	22,23	12200	880	10	110210128
11021	230	3,2	22,23	6600	1.920	10	110210233

11023

süllyesztett agyú acél és rozsdamentes acél
csiszolókorongok
A24Q EN 12413



A24Q



	Ø mm	S mm	F mm	max. rpm	Ft		
11023	115	6,5	22,23	13300	1.130	10	110230115
11023	125	6,5	22,23	12200	1.230	10	110230125
11023	230	6,5	22,23	6600	3.520	10	110230230

11034÷11038

egyenes, vékony, acél és rozsdamentes acél
vágókorongok

TOP LINE
Ø 65 mm
A46U EN 12413



TOP
LINE

A46U

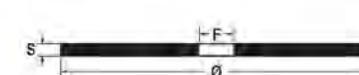

	Ø mm	S mm	F mm	max. rpm	Ft		
11034	115	1,0	22,23	13300	1.080	25	110340022
11034	115	1,6	22,23	13300	1.080	25	110340062

	Ø mm	S mm	F mm	max. rpm	Ft		
11035	125	1,0	22,23	12200	1.170	25	110350022
11035	125	1,6	22,23	12200	1.170	25	110350062

	Ø mm	S mm	F mm	max. rpm	Ft		
11038	230	2,0	22,23	6600	2.210	10	110380022



11045-11046

egyenes, vékony, acél és rozsdamentes acél
vágókorongok

PREMIUM LINE

Ø 115 mm

A46Q EN 12413



A46Q

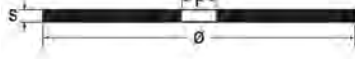

	Ø mm	S mm	F mm	max. rpm	Ft		
11045	115	1,0	22,23	13300	835	25	110450010
11045	115	1,6	22,23	13300	835	25	110450016

	Ø mm	S mm	F mm	max. rpm	Ft		
11046	125	1,0	22,23	12200	880	25	110460010
11046	125	1,6	22,23	12200	880	25	110460016

11049

egyenes, vékony, acél és rozsdamentes acél
vágókorongok

Ø 230 mm

A36Q EN 12413



A36Q

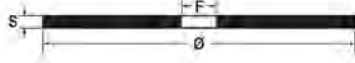

	Ø mm	S mm	F mm	max. rpm	Ft		
11049	230	2,0	22,23	6600	1.720	10	110490019

11101

csapos dörzskorongok,
rózsaszín korundszemcsés,
hengeres

szár Ø 6 x 40 mm

EN 12413

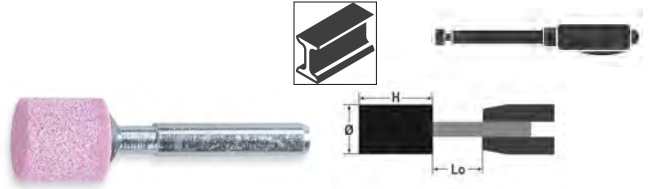

	Ø mm	h mm	max. rpm Lo=13 mm		Ft		
11101	4	8	130.000	AR60P5V	560	25	111010004
11101	5	10	130.000	AR60P5V	560	25	111010005
11101	6	10	130.00	AR60P5V	560	25	111010006
11101	8	10	119.300	AR60P5V	560	25	111010008
11101	10	10	95.400	AR60P5V	560	25	111010010
11101	10	15	95.400	AR60P5V	560	25	111010011
11101	10	20	86.600	AR60P5V	605	25	111010012
11101	10	25	72.700	AR60P5V	670	25	111010013
11101	10	32	58.700	AR60P5V	705	25	111010014
11101	12	20	79.500	AR60P5V	575	25	111010017
11101	15	15	63.600	AR60P5V	560	25	111010019
11101	16	20	59.600	AR46P5V	625	25	111010020
11101	16	25	56.900	AR46P5V	670	25	111010021
11101	16	32	45.100	AR46P5V	755	25	111010022
11101	20	20	47.700	AR46P5V	670	25	111010025
11101	20	25	46.100	AR46P5V	705	25	111010026
11101	20	30	38.900	AR46P5V	775	25	111010027
11101	20	40	29.00	AR46P5V	970	25	111010028
11101	25	25	37.200	AR36/46P5V	775	25	111010031
11101	30	30	26.200	AR36/46P5V	925	25	111010035
11101	30	40	19.500	AR36/46P5V	1.230	10	111010036
11101	32	32	23.100	AR36P5V	1.190	10	111010038
11101	40	10	23.800	AR36/46P5V	925	25	111010041
11101	40	20	23.800	AR36P5V	1.230	10	111010042
11101	40	30	19.700	AR36P5V	1.420	10	111010044
11101	40	40	14.700	AR36P5V	1.720	10	111010045
11101	50	25	18.800	AR36P5V	1.640	10	111010052
11101	60	10	15.900	AR36P5V	1.520	10	111010050

11107

csapos dörzskorongok,
rózsaszín korundszemcsés,
trapéz alakú

szár Ø 6 x 40 mm

EN 12413

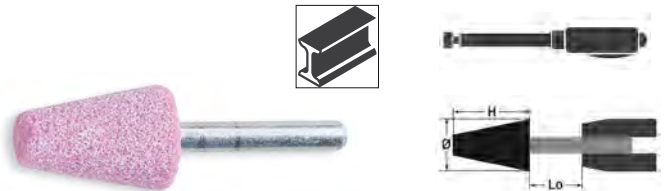

	Ø mm	h mm	max. rpm Lo=13 mm		Ft		
11107	12	20	79.500	AR60P5V	705	25	111070012
11107	15	25	60.400	AR46P5V	840	25	111070015
11107	20	30	38.900	AR46P5V	970	25	111070020
11107	25	40	23.300	AR36/46P5V	1.420	10	111070025

Beta

11111

csapos dörzskorongok,
rózsaszín korundszemcsés,
kerekített, kúp alakú

szár Ø 6 x 40 mm

EN 12413

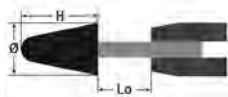

	Ø mm	h mm	max. rpm Lo=13 mm		Ft		
11111	10	20	86.600	AR60P5V	725	25	111110010
11111	15	30	51.000	AR46P5V	945	25	111110015
11111	16	45	31.400	AR46P5V	1.300	25	111110016
11111	20	28	41.500	AR46P5V	970	25	111110020
11111	20	40	29.000	AR46P5V	1.230	25	111110021
11111	30	50	15.100	AR36/46P5V	1.800	10	111110030

11116

csapos dörzskorongok,
rózsaszín korundszemcsés,
csúcsíves

szár Ø 6 x 40 mm

EN 12413



	Ø mm	h mm	max. rpm Lo=13 mm		Ft		
11116	10	20	86.600	AR60P5V	725	25	111160010
11116	18	30	43.000	AR46P5V	970	25	111160018
11116	20	50	22.500	AR36/46P5V	1.520	25	111160020

11131

csapos dörzskorongok,
rózsaszín korundszemcsés,
gömbölyű

szár Ø 6 x 40 mm

EN 12413

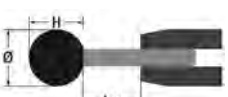

	Ø mm	h mm	max. rpm Lo=13 mm		Ft		
11131	10	10	95.400	AR60P5V	670	25	111310010
11131	15	15	63.600	AR60P5V	705	25	111310015
11131	20	20	47.700	AR46P5V	840	25	111310020
11131	25	25	37.200	AR36/46P5V	970	25	111310025
11131	30	30	26.200	AR36/46P5V	1.160	25	111310030

1120A-1120B

csiszoló tárcsák cirkónium csiszolóvászonnal,
műanyag csiszoló talp, dupla lamellás kivitel

Egyenes

PREMIUM LINE

Ø 115 mm

EN 13743

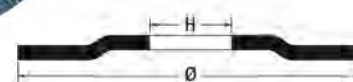

	Ø mm	P	F mm	Ft		
1120A	115	40	22,23	1.380	10	112020004
1120A	115	60	22,23	1.380	10	112020006
1120A	115	80	22,23	1.380	10	112020008
1120A	115	120	22,23	1.380	10	112020012

	Ø mm	P	F mm	Ft		
1120B	125	40	22,23	1.680	10	112020104
1120B	125	60	22,23	1.680	10	112020106
1120B	125	80	22,23	1.680	10	112020108

11204A-11204B

csiszoló tárcsák cirkónium csiszolóvászonnal,
üvegszál csiszoló talp, egylamellás kivitel

Egyenes

PREMIUM LINE

Ø 115 mm

EN 13743

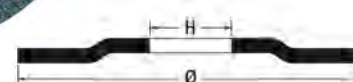

	Ø mm	P	F mm	Ft		
11204A	115	40	22,23	1.380	10	112040004
11204A	115	60	22,23	1.380	10	112040006
11204A	115	80	22,23	1.380	10	112040008
11204A	115	120	22,23	1.380	10	112040012

	Ø mm	P	F mm	Ft		
11204B	125	40	22,23	1.680	10	112040104
11204B	125	60	22,23	1.680	10	112040106
11204B	125	80	22,23	1.680	10	112040108

11210A-11210B

csiszolótárcsák cirkónium csiszolóvászonnal,
üvegszál csiszolótalp, egylamellás kivitel

Kúpos
PREMIUM LINE
Ø 115 mm
EN 13743



	Ø mm	P	F mm	Ft		
11210A	115	40	22,23	1.380	10	112100004
11210A	115	60	22,23	1.380	10	112100006
11210A	115	80	22,23	1.380	10	112100008
11210A	115	120	22,23	1.380	10	112100012

	Ø mm	P	F mm	Ft		
11210B	125	40	22,23	1.680	10	112100104
11210B	125	60	22,23	1.680	10	112100106
11210B	125	80	22,23	1.680	10	112100108

11214A

csiszolótárcsák cirkónium csiszolóvászonnal,
műanyag csiszolótalp, dupla lamellás kivitel

Egyenes
TOP LINE
Ø 115 mm
EN 13743

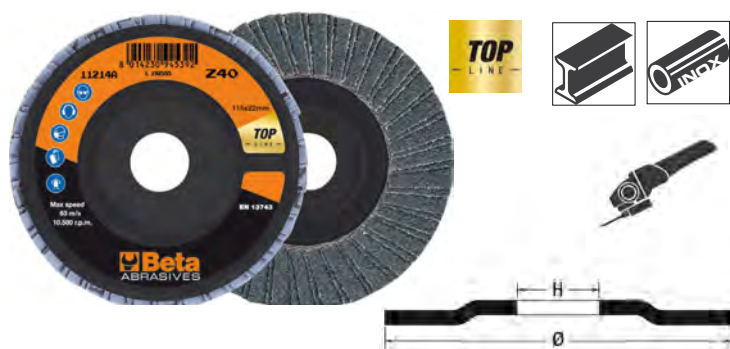

	Ø mm	P	F mm	Ft		
11214A	115	40	22,23	1.720	10	112140004
11214A	115	60	22,23	1.720	10	112140006
11214A	115	80	22,23	1.720	10	112140008
11214A	115	120	22,23	1.720	10	112140012



11216A-11216B

csiszolótárcsák cirkónium csiszolóvászonnal,
üvegszál csiszolótalp, egylamellás kivitel

Egyenes
TOP LINE
Ø 115 mm
EN 13743



	Ø mm	P	F mm	Ft		
11216A	115	40	22,23	1.720	10	112160004
11216A	115	60	22,23	1.720	10	112160006
11216A	115	80	22,23	1.720	10	112160008
11216A	115	120	22,23	1.720	10	112160012

	Ø mm	P	F mm	Ft		
11216B	125	40	22,23	2.130	10	112160104
11216B	125	60	22,23	2.130	10	112160106
11216B	125	80	22,23	2.130	10	112160108

11234A

csiszolótárcsák korund csiszolóvászonnal,
üvegszál csiszolótalp, egylamellás kivitel

Egyenes
TOP LINE
Ø 115 mm
EN 13743



	Ø mm	P	F mm	Ft		
11234A	115	40	22,23	1.520	10	112340004
11234A	115	60	22,23	1.520	10	112340006
11234A	115	80	22,23	1.520	10	112340008
11234A	115	120	22,23	1.520	10	112340012



11246A

csiszoló tárcsák kerámia bevonatú csiszolóvászonnal,
műanyag csiszolótalp, egy lamellás kivitel

Egyenes
Ø 115 mm
EN 13743



	Ø mm	P	F mm	Ft		
11246A	115	40	22,23	2.940	10	112460004
11246A	115	60	22,23	2.940	10	112460006

11248A

csiszoló tárcsák kerámia bevonatú csiszolóvászonnal,
üvegszál csiszolótalp, egy lamellás kivitel

Egyenes
Ø 115 mm
EN 13743



	Ø mm	P	F mm	Ft		
11248A	115	40	22,23	2.940	10	112480004
11248A	115	60	22,23	2.940	10	112480006

11259

filc csiszoló tárcsák,
üvegszál csiszolótalp, egy lamellás kivitel

Egyenes



	Ø mm	F mm	Ft		
11259	115	22,23	4.820	10	112590115

11260÷11268

csapos lamellás korongok,
korund csiszolóvászonnal lamellák
szár Ø 3 mm

EN 13743



	Ø mm	h mm	S mm	P	Ft		
11260	10	10	3	60	2.410	10	112600010
11260	15	15	3	60	1.920	10	112600015

	Ø mm	h mm	S mm	P	Ft		
11263	30	10	6	60	1.280	10	112630006
11263	30	15	6	60	1.280	10	112630016
11263	30	15	6	80	1.280	10	112630018
11263	30	20	6	40	1.280	10	112630024
11263	30	20	6	60	1.320	10	112630026
11263	30	20	6	80	1.320	10	112630028
11263	30	20	6	120	1.320	10	112630032

	Ø mm	h mm	S mm	P	Ft		
11264	40	15	6	60	1.380	10	112640006
11264	40	15	6	80	1.380	10	112640008
11264	40	15	6	120	1.380	10	112640012
11264	40	20	6	40	1.420	10	112640014
11264	40	20	6	60	1.420	10	112640016
11264	40	30	6	40	1.620	10	112640024
11264	40	30	6	60	1.620	10	112640026

	Ø mm	h mm	S mm	P	Ft		
11265	50	20	6	60	1.680	10	112650006
11265	50	20	6	80	1.680	10	112650008
11265	50	30	6	40	1.860	10	112650014
11265	50	30	6	60	1.860	10	112650016
11265	50	30	6	80	1.860	10	112650018
11265	50	30	6	120	1.960	10	112650022

	Ø mm	h mm	S mm	P	Ft		
11266	60	20	6	60	1.960	10	112660006
11266	60	30	6	40	2.210	10	112660014
11266	60	30	6	60	2.210	10	112660016
11266	60	30	6	80	2.210	10	112660018
11266	60	30	6	120	2.410	10	112660022
11266	60	40	6	60	2.530	10	112660026

	Ø mm	h mm	S mm	P	Ft		
11268	80	30	6	60	3.040	10	112680006
11268	80	30	6	80	3.040	10	112680008



SARUZÓFOGÓ KÁBELSARUKHOZ

		Kábelcsatlakozás	Vágási mélység	Range (mm ²)	Felhasználás
1601/PC					Telefon- és adatátviteli kábelcsatlakozókhoz 4P/6P/8P
1602				0,75-6	Szigetelt kábelcsatlakozókhoz, könnyített kivitel
1602A				0-6	Szigetelt kábelcsatlakozókhoz, standard modell
1603				1,25-5,5	Nem szigetelt kábelcsatlakozókhoz, könnyített kivitel
1603A				0-8	Nem szigetelt zárt kábelcsatlakozókhoz, standard modell
1603B				0-8	Nem szigetelt nyitott kábelcsatlakozókhoz, standard modell
1606/2				0,14-10	Nagy teherbírású, henger alakú kábelcsatlakozókhoz
1606A				0,5-6 6-16	Henger alakú kábelcsatlakozókhoz
1606T				0,1-10	Henger alakú kábelcsatlakozókhoz, 4 oldalas krimpelés
1607				6,48 5,41 1,69	Nagy teherbírású, BNC koaxiális kábelcsatlakozókhoz RG 58, RG 59, RG 62, RG 71
1608				0,5-6	Szigetelt kábelcsatlakozókhoz, nyomásszabályozóval
1608A				0,75-6	Nagy teherbírású, szigetelt kábelcsatlakozókhoz
1609				0,5-2,5	Nem szigetelt kábelcsatlakozókhoz
1609A				0,5-6	Nagy teherbírású, nem szigetelt kábelcsatlakozókhoz
1609B				10-120	Nem szigetelt kábelcsatlakozókhoz

1601/PC

Saruzófogó telefonkábelcsatlakozókhoz



RJ11-RJ12-RJ45

Ft 30.550

2 016010011

1602

Saruzófogó szigetelt kábelcsatlakozókhoz, könnyített kivitel, műanyag szárral

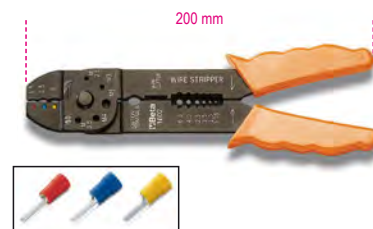

mm²
0,75÷6

Ft 7.610

5 016020001

1602/C9

Könnyített saruzófogó 450 kábelcsatlakozóval



1602/C9

Ft 65.700

1 016020045

1602

BM00180	R/6,3	50
BM00280	B/6,3	50
BM00380	G/6,3	50
BM00191	R/6,3	50
BM00291	B/6,3	50
BM00392	G/6,3	50
BM00160	R/1,6	50
BM00260	B/2,3	50
BM00360	G/3,6	50

420x185x60 mm - 1,5 kg

1602A

Saruzófógó szigetelt kábelsarukhoz, standard modell, krómozott, műanyag szárral



mm ²	Ft	1	016020005
0÷6	27.950	2	016020005

1603

Saruzófógó nem szigetelt kábelsarukhoz, könnyített kivitel, műanyag szárral

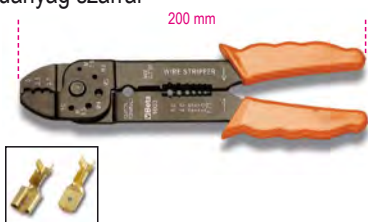

mm ²	Ft	5	016030001
1,25÷5,5	7.610	5	016030001

1603A

Saruzófógó nem szigetelt kábelsarukhoz, önzáró modell

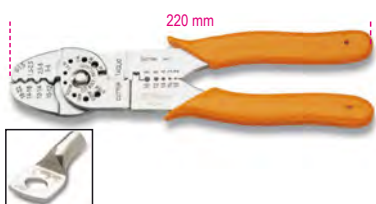

mm ²	Ft	2	016030005
0÷8	27.950	2	016030005

1603B

Saruzófógó nem szigetelt kábelsarukhoz, nyitott modell, standard modell, krómozott, műanyag szárral

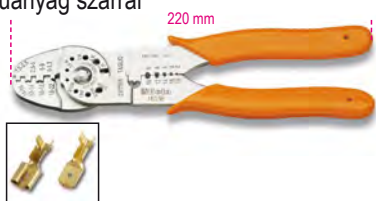

mm ²	Ft	2	016030010
0÷8	28.550	2	016030010



1606/2

Áttételes saruzófógó szigetelt kábelsarukhoz



mm ²	L mm	A mm	B mm	Ft	1	016060002
0,14÷10	175	65	20	166.400	1	016060002

1606A

Önzáró saruzófógó gyűrűs kábelsarukhoz



	mm ²	Ft	1	016060010
1606A6	0,5÷6	44.750	1	016060010
1606A16	6÷16	44.750	1	016060016

1606A/C9

Saruzófógó kábelsarukhoz 450 kábelsarúval 0,5 mm²-6 mm²



	Ft	1	016060045
1606A/C9	72.750	1	016060045

1606A6	n.	
BM00601	W/0,5	1
BM00604	N/1,5	50
BM00506	B/2,5	100
BM00508	G/4	100
BM00610	Y/6	100

420x185x60 mm - 2,5 kg



1606T

saruzófógó cső sarukhoz, 4 oldalú krimpelés

csökkentett erő kifejtés a karnál



mm ²	L mm	A mm	B mm	Ft	1	016060005
0,1÷10	173	61	13	148.600	1	016060005

1607

Áttételes saruzófógó szigetelt kábelsarukhoz (RG 58, RG 59, RG 62, RG 71)



	L mm	A mm	B mm	Ft	1	016070001
1607	220	73	19	146.600	1	016070001

1608

Saruzófógó szigetelt kábelsarukhoz, nyomásszabályzóval

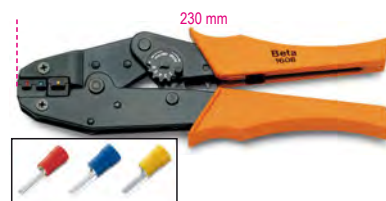

mm ²	Ft	1	016080001
0,5÷6	57.300	1	016080001

1608/C9

Önzáró saruzófógó 450
kábsarukkal, fémdobozban



1608/C9 Ft 115.400 1 016080045

1608	n.
BM00180 R/6,3	50
BM00280 B/6,3	50
BM00380 G/6,3	50
BM00191 R/6,3	50
BM00291 B/6,3	50
BM00392 G/6,3	50
BM00160 R/1,6	50
BM00260 B/2,3	50
BM00360 G/3,6	50
420x185x60 mm - 2 kg	

1608A

Áttételes saruzófógó szigetelt
kábsarukhoz



mm² Ft 115.800 1 016080005
0,75÷6



1609

Automata saruzófógó
nem szigetelt kábsarukhoz,
professzionális használatra



mm² Ft 57.300 1 016090001
0,5÷2,5

1609A

Áttételes saruzófógó nem szigetelt
kábsarukhoz csekély erőfordítással



mm² Ft 225.100 1 016090005
0,5÷6

1609B

Saruzófógó nem szigetelt kábsarukhoz

Matricaméret:
10 mm -120 mm²



L Ft 152.200 1 016090101
mm mm²
600 10÷120

1609C/C5

Saruzófógó kábsarukhoz 5 matricapárral

Hatszögű crimpelő
25 mm²-240 mm²



mm² Ft 975.700 1 016090210
50÷240
500x300x110 mm - 4 kg

1609M

Matricák a 1609C modellhez

Hatszögű crimpelő



1609M/16	mm ²	Ft	n.
1609M/16	10-16	35.200	1 016090221
1609M/35	25-35	35.200	1 016090223
1609M/70	50-70	35.200	1 016090225
1609M/120	95-120	35.200	1 016090227
1609M/150	150	35.200	1 016090229
1609M/185	185	35.200	1 016090231
1609M/240	240	35.200	1 016090233

1639S

Nylon behúzószalag

Cserélhető fejek



L Ft 9.840 1 016390010
m mm
10 4





BM MÁRKANÉVEN KAPHATÓ TERMÉKEINK

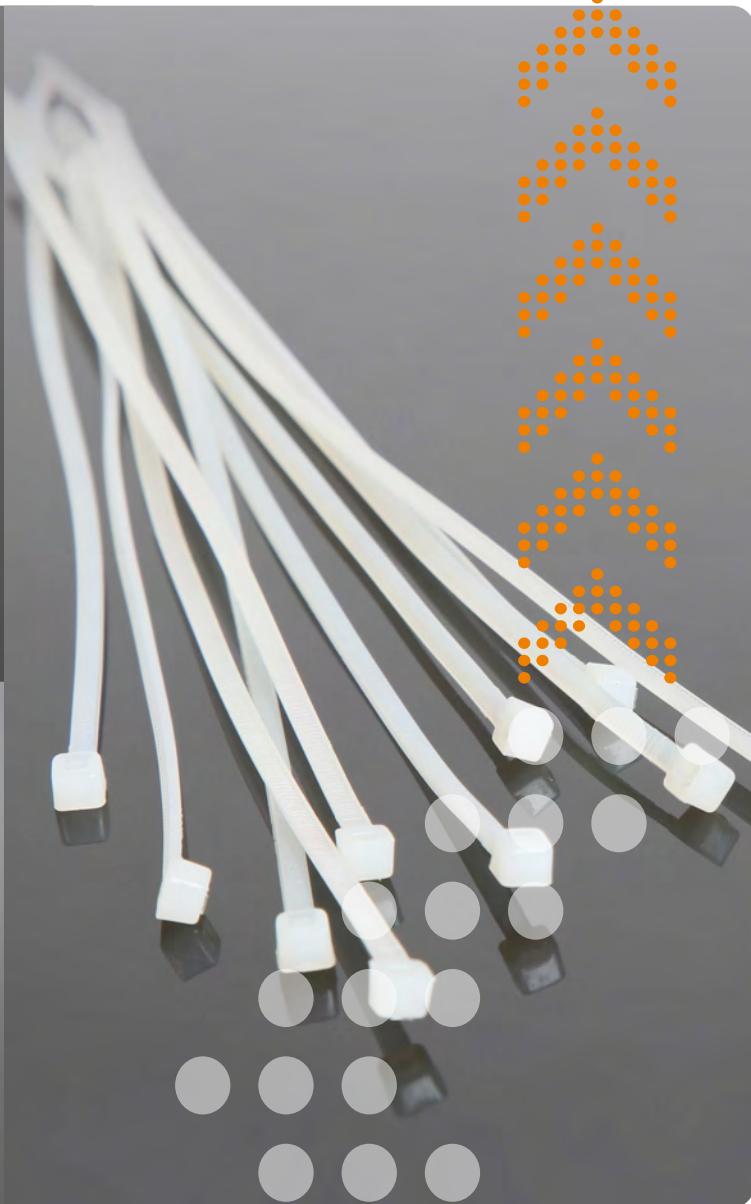
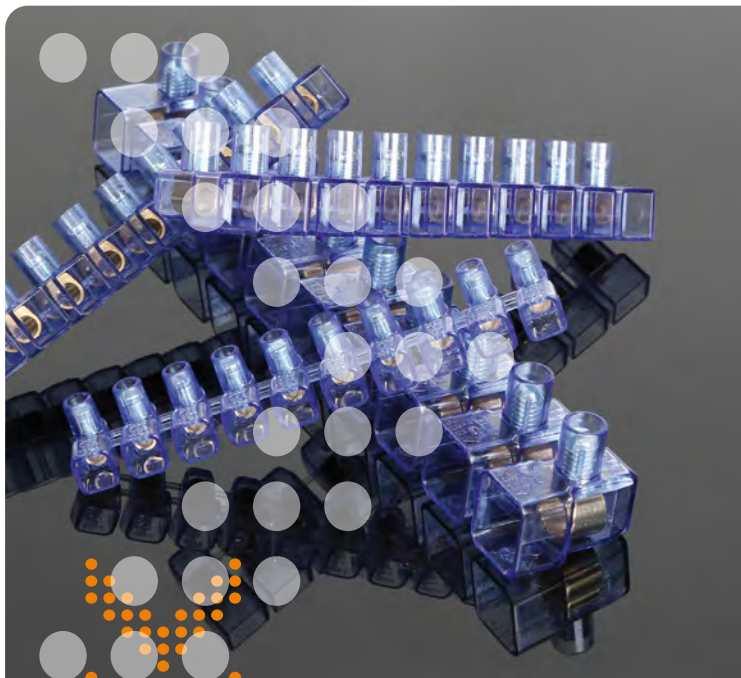

KÁBELSARUK, KÁBELKÖTEGELŐK, SORKAPCSOK, SZIGETELŐSZALAGOK

A BM Csoport 1958 óta foglalkozik csatlakozóelemek és villamos rendszerekben alkalmazott termékek tervezésével, gyártásával és forgalmazásával.

A minőség, munkabiztonság és megbízhatóság mindig is a BM alapértékeihez tartozott. Ezek az értékek és a kiválóságra való törekvés tették lehetővé a társaság fejlődését, hogy lépésről lépésre a villamossági anyagok piacának kiemelt szereplőjévé váljon. A BM Csoportot 2018-ban vásárolta meg a Beta Utensili. Ez a rész a Beta termékpalettáját kiegészítő, BM márkanev alatt forgalmazott speciális termékpalettát mutatja be.

TANÚSÍTOTT MINŐSÉG





1610-B szigetelt gyűrűs kábelsaruk

D mm	L mm	Ft	csomag	BM
4	20,6	3.790	100	BM00119
5	21,8	4.450	100	BM00125
5	22,4	4.700	100	BM00225
6	26	4.290	100	BM00231
8	29,8	6.680	100	BM00237
6	29,1	9.350	50	BM00331
8	34,5	8.260	50	BM00337

- Kérjük, a rendelésben ne a csomagok, hanem a kábelsaruk számát adja meg
- Az árak 100 darabra vonatkoznak

1614-P szigetelt érvéghüvely

D mm	L mm	Ft	csomag	BM
1,9	19	3.790	100	BM00151
1,9	19	5.340	100	BM00251
2,7	28	8.460	50	BM00350

- Kérjük, a rendelésben ne a csomagok, hanem a kábelsaruk számát adja meg
- Az árak 100 darabra vonatkoznak

1616-SM szigetelt hengeres kábelsaruk

D mm	L mm	Ft	csomag	BM
4	21	7.450	100	BM00130

- Kérjük, a rendelésben ne a csomagok, hanem a kábelsaruk számát adja meg
- Az árak 100 darabra vonatkoznak

1618-SF szigetelt hengeres hüvely

D mm	L mm	Ft	csomag	BM
3,8	23,5	8.620	100	BM00140

- Kérjük, a rendelésben ne a csomagok, hanem a kábelsaruk számát adja meg
- Az árak 100 darabra vonatkoznak

1620-M szigetelt gyorskötésű kábelsaruk

HxS mm	L mm	Ft	csomag	BM
6,3x0,8	21	7.170	100	BM00180
6,3x0,8	21	7.450	100	BM00280
6,3x0,8	24,5	8.140	50	BM00380

- Kérjük, a rendelésben ne a csomagok, hanem a kábelsaruk számát adja meg
- Az árak 100 darabra vonatkoznak

1622-F szigetelt gyorskötésű hüvely

HxS mm	L mm	Ft	csomag	BM
6,3x0,8	20,7	7.290	100	BM00190
2,8x0,5	18,5	6.150	100	BM00395
6,3x0,8	20,7	7.450	100	BM00290
6,3x0,8	24,5	10.500	50	BM00391

- Kérjük, a rendelésben ne a csomagok, hanem a kábelsaruk számát adja meg
- Az árak 100 darabra vonatkoznak

1624-FI szigetelt gyorskötésű hüvely

HxS mm	L mm	Ft	csomag	BM
6,3x0,8	22	8.060	100	BM00191
6,3x0,8	22	8.180	50	BM00291
6,3x0,8	25	10.300	50	BM00392

- Kérjük, a rendelésben ne a csomagok, hanem a kábelsaruk számát adja meg
- Az árak 100 darabra vonatkoznak

1628-C szigetelt kábelsatlakozók

D mm	L mm	Ft	csomag	BM
1,8	25	6.070	100	BM00160
2,5	26,5	7.170	100	BM00260
3,7	27	9.920	50	BM00360

- Kérjük, a rendelésben ne a csomagok, hanem a kábelsaruk számát adja meg
- Az árak 100 darabra vonatkoznak

1630-CR gyorscsatlakozók

mm ²	L mm	Ft	csomag	BM
0,25-1	15,3	6.280	500	BM00110
1,25-2,5	15,9	6.110	500	BM00210

- Kérjük, a rendelésben ne a csomagok, hanem a kábelsaruk számát adja meg
- Az árak 100 darabra vonatkoznak

1632-TS kábelsaruk

mm ²	L mm	Ft	csomag	BM
0,5	14	750	500	BM00601
0,75	14	750	500	BM00602
1	14	750	500	BM00603
1,5	14	750	500	BM00604
2,5	14	980	250	BM00506
4	17	1.560	200	BM00508
6	20	2.510	100	BM00610
0,5	14	715	500	BM00501
0,75	14	715	500	BM00502
1	14	715	500	BM00503
1,5	14	710	500	BM00504
6	20	2.410	100	BM00510

- Kérjük, a rendelésben ne a csomagok, hanem a kábelsaruk számát adja meg
- Az árak 100 darabra vonatkoznak

1634-TD kétutas kábelsaruk

mm ²	L mm	Ft	csomag	BM
2x0,5	15	2.470	200	BM00651
2x0,75	15	1.920	200	BM00652
2x1	15	1.920	200	BM00654
2x1,5	16	2.060	200	BM00656
2x2,5	18,5	2.350	100	BM00558
2x4	23	6.960	100	BM00560
2x6	26	9.070	50	BM00661
2X0,5	15	1.840	200	BM00551
2X0,75	15	1.840	200	BM00552
2X1	15	1.840	200	BM00554
2X1,5	16	1.960	200	BM00556
2X6	26	8.620	50	BM00561

- Kérjük, a rendelésben ne a csomagok, hanem a kábelsaruk számát adja meg
- Az árak 100 darabra vonatkoznak





1635-D

többszörös polipropilén sorkapocs, 12 pólusú

Szigetelő borítás: természetes polipropilén (PP)

Vezető: sárgaréz

Rögzítőcsavar: galvanizált acél

Önkéntes: EN 60335-1: 2002+A2:2006 (30.2.3. bek.), EN

60695-2-10 850 °C-on, EN 60695-2-11

Üzemi hőmérséklet: max. 85 °C

Védelmi fokozat: IP20

Referencia szabvány: EN 60998-1: 2004, EN 60998-2-1: 2004, EN 60335-1: 2002 + A2: 2006 (30.2.3. bek.), IEC/EN 60695-2-11

CE



mm ²	L mm	L1 mm	mm ²	Ft	☞	🏠
16	93,7	14,7	2,5	635	50	BM9200
20,5	116,5	17,2	4	790	50	BM9201
23,5	139,5	20,1	6	1.150	50	BM9202
25,3	175,5	22,5	16	2.020	25	BM9203
35,2	228	33,5	25	5.590	10	BM9204

1635-S

zárt végű sorkapocs, szabadon álló csatlakozókhoz

Szigetelő borítás: átlátszó polikarbonát UL94 V0

Vezető: réz

Csavar: horganyzott acél

Lángállóság: EN60695-2-10 a 850°C, EN 60335-1:2002

+A2:2006, EN60695-2-11

Működési hőmérséklet: max. 85 °C

Védelmi fokozat: IP20

Referencia szabványok: EN60998-1: EN60998-2-1:2004

CE



mm ²	L mm	L1 mm	S mm	mm ²	N	Ft	☞	🏠
1.5	15	7.5	14.5	1.5	2	575	10	BM991
				1	2÷3			
				0.75	2÷4			
2.5	17.5	9	18.2	2.5	2	585	10	BM992
				1.5	2÷3			
				1	2÷4			
4	21	10.3	20	4	2	790	10	BM9924
				2.5	2÷3			
				1.5	2÷4			
6	22.5	11.8	23	6	2	920	10	BM993
				4	2÷3			
				2.5	2÷4			
10	26	14.7	26	10	2	2.230	10	BM994
				6	2÷3			
				4	2÷4			
16	31.8	18.8	32.2	16	2	4.900	10	BM995
				10	2÷3			
				6	2÷4			

1635-S

CE



mm ²	L mm	L1 mm	S mm	mm ²	N	Ft	☞	🏠
25	36.3	22.5	41.9	25	2	1.720	25	BM9960
				16	2÷3			
				10	2÷4			
35	43.5	26.1	49.4	35	2	2.210	25	BM9961
				25	2÷3			
				16	2÷4			



1748-BV2

műanyag kábelkötegelő szalag, natúr

Anyag: poliamid PA 6.6

Lángállósági osztály: UL 94-V2

Működési hőmérséklet-tartomány: -40 °C ÷ +85 °C

Legkisebb szerelési hőmérséklet: -10 °C

Vegyszerállóság: Bázisoknak, olajoknak, zsíroknak, klorid

tartalmú oldószereknek jól ellenáll. Savakkal szemben

korlátozottan ellenálló. Fenolokkal szemben nem ellenálló

Referencia szabványok: EN 62275:2015-02

Besorolás: type 1 (EN); type 21 (UL)

CE

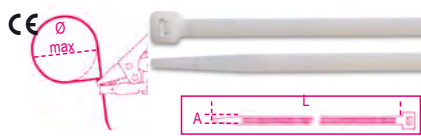

A mm	L mm	Ø MAX mm	F MAX N	Ft	☞	🏠
2.5	80	14	80	625	100	BMB0824
2.5	100	20.5	80	585	100	BMB1025
2.5	120	27	80	1.020	100	BMB1225
2.5	160	40	80	1.380	100	BMB1625
2.5	200	52.5	80	1.520	100	BMB2025
3.6	140	33	180	1.560	100	BMB1436
3.6	200	52.5	180	2.150	100	BMB2036
3.6	300	106	180	3.020	100	BMB2936
3.6	370	105	180	4.780	100	BMB3736
4.6	120	24	220	2.090	100	BMB1248
4.6	160	36	220	2.230	100	BMB1648
4.6	188	46	220	2.670	100	BMB1948
4.8	200	50	220	2.630	100	BMB2048
4.8	250	65	220	3.810	100	BMB2548
4.8	300	81	220	3.910	100	BMB3048
4.8	370	103.5	220	4.940	100	BMB3748
4.8	390	110	220	6.720	100	BMB3948
4.8	430	122.5	220	8.660	100	BMB4348
4.8	530	160	220	14.550	100	BMB5348
7.6	150	24	550	7.170	100	BMB1576
7.6	200	51	550	7.410	100	BMB2076
7.6	300	83	550	8.260	100	BMB2976
7.6	370	103.5	550	9.960	100	BMB3776
7.6	450	130.5	550	17.000	100	BMB4576
7.6	540	159	550	21.850	100	BMB5476
7.6	750	226	550	34.800	100	BMB7576
8.8	550	163.5	800	20.450	100	BMB5390
8.8	710	195	800	28.950	100	BMB7190
8.8	780	235.5	800	32.400	100	BMB7890
9.0	430	130.5	800	17.200	100	BMB4390
9.0	810	245	800	38.450	100	BMB8190
9.0	1020	295	800	53.050	100	BMB1090
9.0	1220	375.5	800	68.800	100	BMB1290
9.0	1530	460	800	93.900	100	BMB1590

- Kérjük, a rendelésben ne a csomagok, hanem a

kábelkötegelő szalagok számát adja meg

- Az árak 100 darabra vonatkoznak



1748V

műanyag kábelkötegelő szalag, zöld

Anyag: poliamid PA 6.6

Lángállósági osztály: UL 94-V2

Működési hőmérséklet tartomány: -40 °C ÷ +85 °C

Legkisebb szerelési hőmérséklet: -10 °C

Vegyszerállóság: bázisoknak, olajoknak, zsíroknak, klorid

tartalmú oldószereknek jól ellenáll. Savakkal szemben

korlátozottan ellenálló. Fenolokkal szemben nem ellenálló

Referencia szabvány: EN 62275:2015-02

Besorolás: type 1 (EN); type 21 (UL)

CE



A mm	L mm	Ø MAX mm	F MAX N	Ft	☞	🏠
2.5	100	20.5	80	575	100	BMV1025
3.6	140	33	180	1.400	100	BMV1436
4.8	200	50	220	2.390	100	BMV2048
4.8	300	81	220	3.540	100	BMV3048

- Kérjük, a rendelésben ne a csomagok, hanem a

kábelkötegelő szalagok számát adja meg

- Az árak 100 darabra vonatkoznak.

1748N

műanyag kábelkötegelő szalag, fekete

UV-álló

Anyag: poliamid PA 6.6 + korom

Lángállósági osztály: UL 94-V2

Működési hőmérséklet-tartomány: -40 °C ÷ +85 °C

Legkisebb szerelési hőmérséklet: -10 °C

Vegyszerállóság: Bázisoknak, olajoknak, zsíroknak, klorid

tartalmú oldószereknek jól ellenáll. Savakkal szemben

korlátozottan ellenálló. Fenolokkal szemben nem ellenálló

Referencia szabványok: EN 62275:2015-02

Besorolás: type 1 (EN)

CE



A mm	L mm	Ø mm	F MAX N	Ft	☞	🏠
2.5	80	14	80	625	100	BMN0824
2.5	100	20.5	80	585	100	BMN1025
2.5	120	27	80	1.040	100	BMN1225
2.5	160	40	80	1.380	100	BMN1625
2.5	200	52.5	80	1.520	100	BMN2025
3.6	140	33	180	1.560	100	BMN1436
3.6	200	52.5	180	2.150	100	BMN2036
3.6	300	106	180	3.020	100	BMN2936
3.6	370	105	180	4.860	100	BMN3736
4.6	120	24	220	2.090	100	BMN1248
4.6	160	36	220	2.270	100	BMN1648
4.8	188	46	220	2.690	100	BMN1948
4.8	200	50	220	2.630	100	BMN2048
4.8	250	65	220	3.810	100	BMN2548
4.8	300	81	220	3.910	100	BMN3048
4.8	370	103.5	220	4.940	100	BMN3748
4.8	390	110	220	6.720	100	BMN3948
4.8	430	122.5	220	8.660	100	BMN4348
4.8	530	160	220	14.550	100	BMN5348
7.6	150	24	550	7.170	100	BMN1576
7.6	200	51	550	7.410	100	BMN2076
7.6	300	83	550	8.260	100	BMN2976
7.6	370	103.5	550	9.800	100	BMN3776
7.6	450	130.5	550	17.000	100	BMN4576
7.6	540	159	550	21.850	100	BMN5476
7.6	750	226	550	34.800	100	BMN7576
8.8	550	163.5	800	20.450	100	BMN5390
8.8	710	195	800	28.950	100	BMN7190
8.8	780	235.5	800	32.400	100	BMN7890
9.0	430	130.5	800	17.200	100	BMN4390
9.0	810	245	800	38.250	100	BMN8190
9.0	1020	295	800	53.250	100	BMN1090
9.0	1220	375.5	800	68.800	100	BMN1290
9.0	1530	460	800	93.900	100	BMN1590

- Kérjük, a rendelésben ne a csomagok, hanem a

kábelkötegelő szalagok számát adja meg

- Az árak 100 darabra vonatkoznak

1748-UL

műanyag kábelkötegelő szalag, nehéz terhekhez,

fekete

UV- és ütésálló

Anyag: poliamid PA 6.6 + korom

Lángállósági osztály: UL 94-V2

Működési hőmérséklet-tartomány: -40 °C + +85 °C

Legkisebb szerelési hőmérséklet: -10 °C

Vegyszerállóság: Bázisoknak, olajoknak, zsiroknak, klorid tartalmú oldószereknek jól ellenáll. Savakkal szemben korlátozottan ellenáll. Fenolokkal szemben nem ellenáll

Referencia szabvány: EN 62275:2015-02

Besorolás: type 1 (EN); type 21 (UL)

CE



A	L	Ø MAX	F MAX	Ft		
mm	mm	mm	N			
12.4	230	57	1200	21.250	100	BMN2412
12.4	480	136.5	1200	36.450	100	BMN4912
12.4	730	216.1	1200	50.800	100	BMN7412
12.4	880	263.9	1200	60.700	100	BMN8912
12.4	1000	305	1200	72.650	100	BMN1012

- Kérjük, a rendelésben ne a csomagok, hanem a kábelkötegelő szalagok számát adja meg
- Az árak 100 darabra vonatkoznak.

1748-N2D

műanyag kábelkötegelő szalag, fekete,

UV-álló

Anyag: poliamid PA 6.6 + korom

Lángállósági osztály: UL 94-V2

Működési hőmérséklet-tartomány: -40 °C + +85 °C

Legkisebb szerelési hőmérséklet: -10 °C

Vegyszerállóság: Bázisoknak, olajoknak, zsiroknak, klorid tartalmú oldószereknek jól ellenáll. Savakkal szemben korlátozottan ellenáll. Fenolokkal szemben nem ellenáll

Referencia szabvány: EN 62275:2015-02

Besorolás: type 1 (EN)

CE



A	L	Ø MAX	F MAX	Ft		
mm	mm	mm	N			
9.0	180	40	400	10.950	100	BMN1890
9.0	265	62	540	17.200	100	BMN2690
9.0	360	93	540	20.650	100	BMN3690

- Kérjük, a rendelésben ne a csomagok, hanem a kábelkötegelő szalagok számát adja meg
- Az árak 100 darabra vonatkoznak.



1748-BVO

önkioldó műanyag kábelkötegelő szalag, fehér

Anyag: poliamid PA 6.6

Lángállósági osztály: UL 94-V0

Működési hőmérséklet-tartomány: -40 °C + +85 °C

Legkisebb szerelési hőmérséklet: -10 °C

Vegyszerállóság: Bázisoknak, olajoknak, zsiroknak, klorid tartalmú oldószereknek jól ellenáll. Savakkal szemben korlátozottan ellenáll. Fenolokkal szemben nem ellenáll

Referencia szabványok: EN 62275:2015-02

Besorolás: type 1 (EN)

CE V0



A	L	Ø MAX	F MAX	Ft		
mm	mm	mm	N			
2.5	100	20.5	80	915	100	BMB1025V0
3.6	150	36.0	180	2.210	100	BMB1536V0
3.6	200	52.5	180	3.160	100	BMB2036V0
4.8	200	49.5	230	3.460	100	BMB2048V0
4.8	300	81.0	230	5.020	100	BMB3048V0
4.8	370	106.7	230	7.210	100	BMB3848V0
7.6	370	106.7	540	12.750	100	BMB3876V0

- Kérjük, a rendelésben ne a csomagok, hanem a kábelkötegelő szalagok számát adja meg
- Az árak 100 darabra vonatkoznak

1748-BX

műanyag kábelkötegelő szalag, kék,

fém-detektorral érzékelhető

Anyag: poliamid PA 6.6 + fémpor

Lángállósági osztály: UL 94-V2

Működési hőmérséklet-tartomány: -40 °C + +85 °C

Legkisebb szerelési hőmérséklet: -10 °C

Vegyszerállóság: Bázisoknak, olajoknak, zsiroknak, klorid tartalmú oldószereknek jól ellenáll. Savakkal szemben korlátozottan ellenáll. Fenolokkal szemben nem ellenáll

Referencia szabványok: EN 62275:2015-02

Besorolás: type 1 (EN)

CE



A	L	Ø MAX	F MAX	Ft		
mm	mm	mm	N			
2.5	100	20.5	80	1.100	100	BMBX1025
3.6	150	36.0	180	2.870	100	BMBX1536
3.6	200	52.5	180	3.870	100	BMBX2036
4.8	200	49.5	230	4.740	100	BMBX2048
4.8	300	81.0	230	6.840	100	BMBX3048
4.8	370	106.7	230	9.310	100	BMBX3848
7.6	370	106.7	540	17.000	100	BMBX3876

- Kérjük, a rendelésben ne a csomagok, hanem a kábelkötegelő szalagok számát adja meg
- Az árak 100 darabra vonatkoznak

1748-BL

acélfogas műanyag kábelkötegelő szalag, natúr

Anyag: poliamid PA 6.6 + acél

Lángállósági osztály: UL 94-V2

Működési hőmérséklet-tartomány: -40 °C + +85 °C

Legkisebb szerelési hőmérséklet: -10 °C

Vegyszerállóság: Bázisoknak, olajoknak, zsiroknak, klorid tartalmú oldószereknek jól ellenáll. Savakkal szemben korlátozottan ellenáll. Fenolokkal szemben nem ellenáll

Referencia szabványok: EN 62275:2015-02

Besorolás: type 1 (EN)

CE

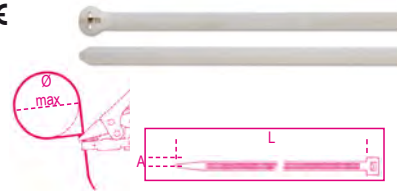

A	L	Ø MAX	F MAX	Ft		
mm	mm	mm	N			
2.5	100	20.5	180	2.190	100	BMBL1025
2.5	200	52.5	180	2.850	100	BMBL2025
3.6	140	33.0	250	4.900	100	BMBL1436
4.8	200	49.5	360	6.800	100	BMBL2048
4.8	300	81.0	360	8.740	100	BMBL3048
4.8	370	103.5	360	10.500	100	BMBL3748
7.6	370	103.5	780	19.850	100	BMBL3776

- Kérjük, a rendelésben ne a csomagok, hanem a kábelkötegelő szalagok számát adja meg
- Az árak 100 darabra vonatkoznak

1748-NL

acélfogas műanyag kábelkötegelő szalag, fekete, UV-álló

Anyag: poliamid PA 6.6 + acél + szénfekete

Lángállósági osztály: UL 94-V2

Működési hőmérséklet-tartomány: -40 °C + +85 °C

Legkisebb szerelési hőmérséklet: -10 °C

Vegyszerállóság: Bázisoknak, olajoknak, zsiroknak, klorid tartalmú oldószereknek jól ellenáll. Savakkal szemben korlátozottan ellenáll. Fenolokkal szemben nem ellenáll

Referencia szabványok: EN 62275:2015-02

Besorolás: type 1 (EN)

CE

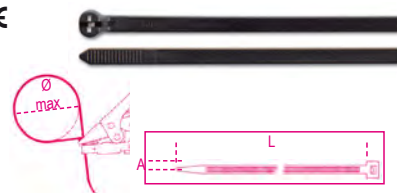

A	L	Ø MAX	F MAX	Ft		
mm	mm	mm	N			
2.5	100	20.5	180	2.190	100	BMNL1025
2.5	200	52.5	180	2.850	100	BMNL2025
3.6	140	33.0	250	4.900	100	BMNL1436
4.8	200	49.5	360	6.800	100	BMNL2048
4.8	300	81.0	360	8.740	100	BMNL3048
4.8	370	103.5	360	10.500	100	BMNL3748
7.6	370	103.5	780	19.450	100	BMNL3776

- Kérjük, a rendelésben ne a csomagok, hanem a kábelkötegelő szalagok számát adja meg
- Az árak 100 darabra vonatkoznak



1748-BR

újrahasználható műanyag kábelkötegelő szalag, natúr

Anyag: poliamid PA 6.6

Lángállósági osztály: UL 94-V2

Működési hőmérséklet-tartomány: -40 °C ÷ +85 °C

Legkisebb szerelési hőmérséklet: -10 °C

Vegyszerállóság: Bázisoknak, olajoknak, zsíroknak, klorid tartalmú oldószereknek jól ellenáll. Savakkal szemben korlátozottan ellenálló. Fenolokkal szemben nem ellenálló

Referencia szabványok: EN 62275:2015-02

Besorolás: type 1 (EN); type 21 (UL)

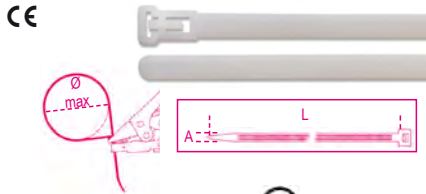

UL FILE N° E223175

A	L	Ø MAX	F MAX	Ft		
mm	mm	mm	N			
7.6	150	40	230	7.530	100	BMBR1576
7.6	200	55	230	8.060	100	BMBR2076
7.6	300	82	230	13.550	100	BMBR3076

- Kérjük, a rendelésben ne a csomagok, hanem a kábelkötegelő szalagok számát adja meg
- Az árak 100 darabra vonatkoznak

1748-BH

gyűrűs műanyag kábelkötegelő szalag, natúr

Anyag: poliamid PA 6.6

Lángállósági osztály: UL 94-V2

Működési hőmérséklet-tartomány: -40 °C ÷ +85 °C

Legkisebb szerelési hőmérséklet: -10 °C

Vegyszerállóság: Bázisoknak, olajoknak, zsíroknak, klorid tartalmú oldószereknek jól ellenáll. Savakkal szemben korlátozottan ellenálló. Fenolokkal szemben nem ellenálló

Referencia szabványok: EN 62275:2015-02

Besorolás: type 1 (EN); type 21 (UL)



UL FILE N° E223175

A	L	Ø MAX	F MAX	Ft		
mm	mm	mm	N			
2.5	110	19.0	80	2.000	100	BMBH1125
* 4.8	200	49.8	230	4.940	100	BMBH2048
* 7.6	305	78.7	550	16.200	100	BMBH3076

- Kérjük, a rendelésben ne a csomagok, hanem a kábelkötegelő szalagok számát adja meg
- Az árak 100 darabra vonatkoznak

1748-BP

befűzős műanyag kábelkötegelő szalag, natúr

Anyag: poliamid PA 6.6

Lángállósági osztály: UL 94-V2

Működési hőmérséklet-tartomány: -40 °C ÷ +85 °C

Legkisebb szerelési hőmérséklet: -10 °C

Vegyszerállóság: Bázisoknak, olajoknak, zsíroknak, klorid tartalmú oldószereknek jól ellenáll. Savakkal szemben korlátozottan ellenálló. Fenolokkal szemben nem ellenálló

Referencia szabványok: EN 62275:2015-02

Besorolás: type 1 (EN); type 21 (UL)

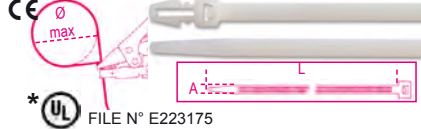

UL FILE N° E223175

A	L	Ø MAX	F MAX	Ft		
mm	mm	mm	N			
3.6	155	37.9	180	3.060	100	BMBP1536
* 4.8	200	50.8	230	5.300	100	BMBP2048

- Kérjük, a rendelésben ne a csomagok, hanem a kábelkötegelő szalagok számát adja meg
- Az árak 100 darabra vonatkoznak

1748-BT

keresztben feliratozható kábelkötegelő szalag, 25x8mm, natúr

Anyag: poliamid PA 6.6

Lángállósági osztály: UL 94-V2

Működési hőmérséklet-tartomány: -40 °C ÷ +85 °C

Legkisebb szerelési hőmérséklet: -10 °C

Vegyszerállóság: Bázisoknak, olajoknak, zsíroknak, klorid tartalmú oldószereknek jól ellenáll. Savakkal szemben korlátozottan ellenálló. Fenolokkal szemben nem ellenálló

Referencia szabványok: EN 62275:2015-02

Besorolás: type 1 (EN); type 21 (UL)

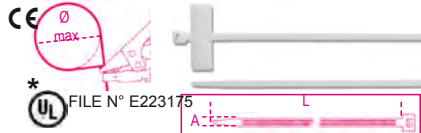

UL FILE N° E223175

A	L	Ø MAX	F MAX	Ft		
mm	mm	mm	N			
* 2.5	100	22.0	80	3.420	100	BMBT1025
2.5	200	53.5	80	5.380	100	BMBT2025

- Kérjük, a rendelésben ne a csomagok, hanem a kábelkötegelő szalagok számát adja meg
- Az árak 100 darabra vonatkoznak

1748-BT2

hosszában feliratozható kábelkötegelő szalag, 13x27mm, natúr

Anyag: poliamid PA 6.6

Lángállósági osztály: UL 94-V2

Működési hőmérséklet-tartomány: -40 °C ÷ +85 °C

Legkisebb szerelési hőmérséklet: -10 °C

Vegyszerállóság: Bázisoknak, olajoknak, zsíroknak, klorid tartalmú oldószereknek jól ellenáll. Savakkal szemben korlátozottan ellenálló. Fenolokkal szemben nem ellenálló

Referencia szabványok: EN 62275:2015-02

Besorolás: type 1 (EN)



A	L	Ø MAX	F MAX	Ft		
mm	mm	mm	N			
4.8	190	51	230	6.360	100	BMBT12248

- Kérjük, a rendelésben ne a csomagok, hanem a kábelkötegelő szalagok számát adja meg
- Az árak 100 darabra vonatkoznak

1748-BT3

külön feliratozható kábelkötegelő szalag, 20x9mm, natúr

Anyag: poliamid PA 6.6

Lángállósági osztály: UL 94-V2

Működési hőmérséklet-tartomány: -40 °C ÷ +85 °C

Legkisebb szerelési hőmérséklet: -10 °C

Vegyszerállóság: Bázisoknak, olajoknak, zsíroknak, klorid tartalmú oldószereknek jól ellenáll. Savakkal szemben korlátozottan ellenálló. Fenolokkal szemben nem ellenálló

Referencia szabványok: EN 62275:2015-02

Besorolás: type 1 (EN)



A	L	Ø MAX	F MAX	Ft		
mm	mm	mm	N			
2.5	110	22	80	3.500	100	BMBT11125

- Kérjük, a rendelésben ne a csomagok, hanem a kábelkötegelő szalagok számát adja meg
- Az árak 100 darabra vonatkoznak

1748-BA1

kábelkötegelő talp

Anyag: poliamid PA 6.6

Lángállósági osztály: UL 94-V2

Működési hőmérséklet-tartomány: -40 °C ÷ +85 °C

Legkisebb szerelési hőmérséklet: -10 °C

Vegyszerállóság: Bázisoknak, olajoknak, zsíroknak, klorid tartalmú oldószereknek jól ellenáll. Savakkal szemben korlátozottan ellenálló. Fenolokkal szemben nem ellenálló

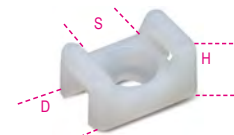

SxDxH	Ø	F	Ft		
mm	mm	mm			
15.2x9.4x6.8	3.3	3.6	4.780	100	BMB0905
22x16.2x10.8	5.2	9	10.700	100	BMB0906

- Kérjük, a rendelésben ne a csomagok, hanem a kábelkötegelő szalagok számát adja meg
- Az árak 100 darabra vonatkoznak

1748-NA1

kábelkötegelő talp

Anyag: poliamid PA 6.6

Lángállósági osztály: UL 94-V2

Működési hőmérséklet-tartomány: -40 °C ÷ +85 °C

Legkisebb szerelési hőmérséklet: -10 °C

Vegyszerállóság: Bázisoknak, olajoknak, zsíroknak, klorid tartalmú oldószereknek jól ellenáll. Savakkal szemben korlátozottan ellenálló. Fenolokkal szemben nem ellenálló



SxDxH	Ø	F	Ft		
mm	mm	mm			
15.2x9.4x6.8	3.3	3.6	4.900	100	BMN0905
22x16.2x10.8	5.2	9	8.740	100	BMN0906

- Kérjük, a rendelésben ne a csomagok, hanem a kábelkötegelő szalagok számát adja meg
- Az árak 100 darabra vonatkoznak



1748-BA2

kábelkötegelő talp - kétirányról fűzhető

Anyag: poliamid PA 6.6

Lángállósági osztály: UL 94-V2

Működési hőmérséklet-tartomány: -40 °C ÷ +85 °C

Legkisebb szerelési hőmérséklet: -10 °C

Vegyszerállóság: Bázisoknak, olajoknak, zsiroknak, klorid tartalmú oldószereknek jól ellenáll. Savakkal szemben korlátozottan ellenálló. Fenolokkal szemben nem ellenálló

CE

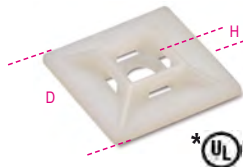

SxDxH mm	F mm	Ft		
19x19x5.4	3.6	5.910	100	BMB0901
* 28x28x7	4.8	8.180	100	BMB0902
* 28x28x5.8	4.8	7.490	100	BMB0903

1748-NA2

kábelkötegelő talp - kétirányról fűzhető
UV-álló

Anyag: poliamid PA 6.6

Lángállósági osztály: UL 94-V2

Működési hőmérséklet-tartomány: -40 °C ÷ +85 °C

Legkisebb szerelési hőmérséklet: -10 °C

Vegyszerállóság: Bázisoknak, olajoknak, zsiroknak, klorid tartalmú oldószereknek jól ellenáll. Fenolokkal szemben korlátozottan ellenálló.

CE

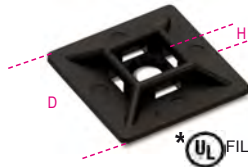

SxDxH mm	F mm	Ft		
19x19x5.4	3.6	5.910	100	BMN0901
* 28x28x7	4.8	8.180	100	BMN0902
* 28x28x5.8	4.8	7.450	100	BMN0903

- Kérjük, a rendelésben ne a csomagok, hanem a kábelkötegelő szalagok számát adja meg

- Az árak 100 darabra vonatkoznak

1748-S

önzáró rozsdamentes acél kábelkötegelő szalag

Anyag: rozsdamentes acél AISI 304

Záró mechanizmus: fémgolyó

Lángállósági osztály: nem gyúlékony

Légtechnikai besorolás: AH-1

Kiváló UV ellenállás

Működési hőmérséklet-tartomány: -60 °C ÷ +300 °C

Legkisebb szerelési hőmérséklet: -60 °C

Vegyszerállóság: kiváló

Referencia szabványok: EN 62275:2015-02

Besorolás: type 2 (EN); type 2 (UL)

CE

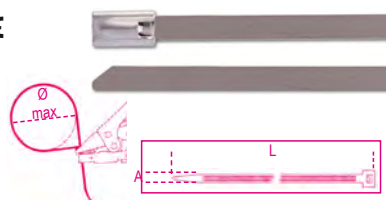

A mm	L mm	ØMAX mm	Trazione N	Ft		
4.6	125	38	890	36.050	100	BMS1345
4.6	200	61.9	890	37.450	100	BMS2045
7.9	200	61.9	1500	39.650	100	BMS2079
4.6	290	90.6	890	40.300	100	BMS3045
7.9	300	90.6	1500	45.950	100	BMS3079
4.6	360	112.8	890	43.900	100	BMS3745
7.9	360	112.8	1500	49.800	100	BMS3779
7.9	500	163.8	1500	59.300	100	BMS5079
4.6	520	163.8	890	43.900	100	BMS5245
4.6	680	214.8	890	46.550	100	BMS6845
7.9	680	214.8	1500	67.400	100	BMS6879
4.6	840	265.7	890	48.800	100	BMS8445
7.9	840	265.7	1500	79.950	100	BMS8479

1748-SC

önzáró rozsdamentes acél kábelkötegelő szalag

fekete poliészter bevonatú

Anyag: rozsdamentes acél AISI 304 + poliészter

Záró mechanizmus: fémgolyó

Lángállósági osztály: nem gyúlékony

Légtechnikai besorolás: AH-1

Kiváló UV ellenállás

Működési hőmérséklet-tartomány: -60 °C ÷ +300 °C

Legkisebb szerelési hőmérséklet: -60 °C

Vegyszerállóság: kiváló

Referencia szabványok: EN 62275:2015-02

Besorolás: type 2 (EN); type 2 (UL)

CE

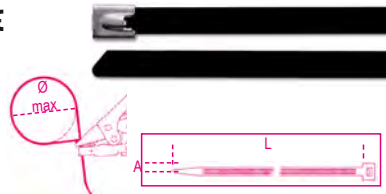

A mm	L mm	ØMAX mm	Trazione N	Ft		
4.6	125	38	450	37.450	100	BMSC1345
4.6	200	61.9	450	43.700	100	BMSC2045
7.9	200	61.9	800	44.350	100	BMSC2079
4.6	290	90.6	450	48.800	100	BMSC3045
7.9	300	90.6	800	52.000	100	BMSC3079
4.6	360	112.8	450	53.850	100	BMSC3745
7.9	360	112.8	800	58.700	100	BMSC3779
7.9	520	163.8	800	73.700	100	BMSC5079
4.6	520	163.8	450	54.650	100	BMSC5245
4.6	680	214.8	450	62.150	100	BMSC6845
7.9	680	214.8	800	84.000	100	BMSC6879
4.6	840	265.7	450	66.200	100	BMSC8445
7.9	840	265.7	800	100.800	100	BMSC8479

1748-BV

Tépőzáras kábelkötegelő szalag, fehér

Anyag: polietilén-poliamid (PE-PA)

Működési hőmérséklet tartomány: -20°C ÷ +60°C



A mm	L mm	Ø MAX mm	F MAX N	Ft		
12,7	229	55	180	105.700	10	BMBV2312
19	229	55	220	121.100	10	BMBV2319

- Kérjük, a rendelésben ne a csomagok, hanem a kábelkötegelő szalagok számát adja meg

- Az árak 100 darabra vonatkoznak.

1748-NV

Tépőzáras kábelkötegelő szalag, fekete

Anyag: polietilén-poliamid (PE-PA)

Működési hőmérséklet tartomány: -20°C ÷ +60°C



A mm	L mm	Ø MAX mm	F MAX N	Ft		
12,7	229	55	180	105.700	10	BMNV2312

- Kérjük, a rendelésben ne a csomagok, hanem a kábelkötegelő szalagok számát adja meg

- Az árak 100 darabra vonatkoznak.

1743

Kábelkötegelő fogó

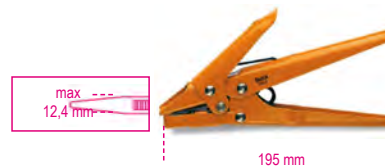

Ft		
25.900	1	017430001

1743T

Kábelkötegelő fogó

• Alkalmos vékony kábelek vágására is (3x1.5mm²; 1x17mm²)



Ft		
15.400	1	017430100



1748-N

kábelkötöző szerszám 2,5-4,8 mm széles műanyag kábelkötélgő szalaghoz
A beállított húzóerő elérésekor automatikusan levág. Húzóerő szabályozóval.

Anyag: polimer és üvegszál test, fém belső részek

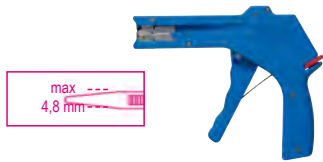

BM1100 Ft 28.750 1 BM1100

1748-ST

automata kábelkötélgő, 4,6-9 mm széles rozsdamentes acél kábelkötélgő szalagokhoz, automatikus feszítéssel és vágásszabályozással



BM1105 Ft 110.500 1 BM1105

1638M

vékony falú zsurgorcső dobozban

Zsugorodási arány: 2:1

Anyag: polietilén

Működési hőmérséklet tartomány: -55°C ÷ +125°C

Zsugorodási hőmérséklet: +70°C ÷ +125°C

Maximum VRMS: 600V

A hüvely önkilóttási foka: VW-1 (UL 224)

Halogénmentes



mm	L	Ø1	Ø2	Ft	csomag	BM
1,6	12	1,6	0,8	8.420	1	BMGBS016MNE
2,4	11	2,4	1,2	8.420	1	BMGBS024MNE
3,2	11	3,2	1,6	8.420	1	BMGBS032MNE
4,8	10	4,8	2,4	8.420	1	BMGBS048MNE
6,4	9	6,4	3,2	8.420	1	BMGBS064MNE
9,5	7	9,5	4,8	8.420	1	BMGBS095MNE
12,7	6	12,7	6,4	8.420	1	BMGBS127MNE
19	5	19,1	9,5	8.580	1	BMGBS190MNE
25,4	3,5	25,4	12,7	8.790	1	BMGBS254MNE



1639ESB

PVC szigetelőszalag

Működési hőmérséklet-tartomány: 0-90°C

Szakítószilárdság: 28N/cm, ami 18,6 N/mm²-nek felel meg

Nyúlás: 200%

Tapadás acélhoz: 2,2N/cm

Öntapadás: 2 N/cm

Dielektromos (átütési) szilárdság: 45kV/mm

Gyúlékonyság: lángálló

Referencia szabvány: IEC 60454-2

Besorolás: CEI EN 60454-3-1-5/F-PVCP/90



S	A	L	Ft	csomag	BM
0.15	15	10	390	10	BMESB1510BI
0.15	15	10	390	10	BMESB1510BL
0.15	15	10	390	10	BMESB1510GI
0.15	15	10	390	10	BMESB1510GR
0.15	15	10	435	10	BMESB1510GV
0.15	15	10	390	10	BMESB1510MA
0.15	15	10	390	10	BMESB1510NE
0.15	15	10	390	10	BMESB1510RO
0.15	15	10	390	10	BMESB1510VE
0.15	15	25	945	10	BMESB1525BI
0.15	15	25	945	10	BMESB1525BL
0.15	15	25	945	10	BMESB1525GI
0.15	15	25	945	10	BMESB1525GR
0.15	15	25	985	10	BMESB1525GV
0.15	15	25	945	10	BMESB1525MA
0.15	15	25	945	10	BMESB1525NE
0.15	15	25	945	10	BMESB1525RO
0.15	15	25	945	10	BMESB1525VE
0.15	19	25	1.030	10	BMESB1925BI
0.15	19	25	1.030	10	BMESB1925BL
0.15	19	25	1.030	10	BMESB1925GI
0.15	19	25	1.030	10	BMESB1925GR
0.15	19	25	1.070	10	BMESB1925GV
0.15	19	25	1.030	10	BMESB1925MA
0.15	19	25	1.030	10	BMESB1925NE
0.15	19	25	1.030	10	BMESB1925RO
0.15	19	25	1.030	10	BMESB1925VE
0.15	25	25	1.480	8	BMESB2525BI
0.15	25	25	1.480	8	BMESB2525BL
0.15	25	25	1.480	8	BMESB2525GI
0.15	25	25	1.480	8	BMESB2525GR
0.15	25	25	1.520	8	BMESB2525GV
0.15	25	25	1.480	8	BMESB2525MA
0.15	25	25	1.480	8	BMESB2525NE
0.15	25	25	1.480	8	BMESB2525RO
0.15	25	25	1.480	8	BMESB2525VE
0.15	50	25	2.230	4	BMESB5025NE

1639ESC

PVC szigetelőszalag

Működési hőmérséklet-tartomány: 0-80°C

Szakítószilárdság: 28N/cm, ami 18,6 N/mm²-nek felel meg

Nyúlás: 200%

Tapadás acélhoz: 2,2N/cm

Öntapadás: 2,2 N/cm

Dielektromos (átütési) szilárdság: 38kV/mm

Gyúlékonyság: lángálló

Referencia szabvány: ASTM-D-1000 ; UL510

Besorolás: CEI EN 60454-3-1-5/F-PVCP/90



S	A	L	Ft	csomag	BM
0.18	19	20	1.380	10	BMESB1920NE

1639ETA

PVC szigetelőszalag extrém hőmérsékletre

Működési hőmérséklet-tartomány: -18 ÷ +105 °C

Szakítószilárdság: 35N/cm, ami 19,4 N/mm²-nek felel meg

Nyúlás: 300%

Tapadás acélhoz: 3,1N/cm

Öntapadás: 2,7 N/cm

Dielektromos (átütési) szilárdság: 55,5kV/mm

Gyúlékonyság: lángálló

Referencia szabvány: ASTM-D-1000 ; UL510

Besorolás: CEI EN 60454-3-1-5/F-PVCP/90



S	A	L	Ft	csomag	BM
0.18	19	20	4.130	1	BMETA1920NE

1639EAB

EPR önvulkanizáló szigetelőszalag

Működési hőmérséklet-tartomány: -40 ÷ +90 °C

Szakítószilárdság: 2,4 N/mm²

Nyúlás: 750%

Dielektromos (átütési) szilárdság: 29,5kV/mm

Gyúlékonyság: lángálló

Referencia szabvány: ASTM-D-4388; ASTM-D-4325

Nedvességgel, korrózióval és vegyszerekkel szemben kiválóan ellenálló.



S	A	L	Ft	csomag	BM
0.76	19	9	8.420	1	BMEAB1909NE





SAJÁT ÜZLETÉNEK BELSŐ RENDSZERÉHEZ AJÁNLUK

- JOBB ÁTTEKINTHETŐSÉG
- HATÉKONY BEMUTATÁS
- VONALKÓD

Blister (tartó):

- nagy szakítószilárdságú PVC
- 4 méret a bemutató hely optimális kihasználása
- Rugalmas gumi rögzítés

42K



mm	Ft		
5,5x5,5	3.980	5	000429505
6x6	4.020	5	000429506
7x7	4.050	5	000429507
8x8	4.220	5	000429508
9x9	4.320	5	000429509
10x10	4.400	5	000429510
11x11	4.700	5	000429511
12x12	4.740	5	000429512
13x13	4.790	5	000429513
14x14	5.510	5	000429514
15x15	6.040	5	000429515
16x16	6.250	5	000429516
17x17	6.550	5	000429517
18x18	6.970	5	000429518
19x19	7.190	5	000429519
20x20	8.000	3	000429520
21x21	8.670	3	000429521
22x22	8.880	3	000429522
23x23	9.640	3	000429523
24x24	10.200	3	000429524
25x25	10.750	2	000429525
26x26	11.550	2	000429526
27x27	12.400	2	000429527
28x28	12.850	2	000429528
29x29	14.100	2	000429529
30x30	14.750	2	000429530
32x32	16.200	2	000429532

55K



mm	Ft		
6x7	2.580	5	000559012
8x9	2.630	5	000559021
10x11	2.720	5	000559030
10x12	3.720	5	000559033
10x13	4.070	5	000559035
12x13	3.090	5	000559042
12x14	4.160	5	000559045
13x17	4.870	5	000559051
14x15	3.870	5	000559054
14x17	5.260	5	000559057
16x17	4.360	5	000559060
17x19	5.870	2	000559063
18x19	5.170	2	000559066
19x22	6.630	2	000559069
20x22	5.870	2	000559075
21x23	6.210	2	000559078
22x24	7.190	2	000559081
24x26	7.400	2	000559087
24x27	8.040	2	000559090
25x28	8.340	2	000559096
27x29	9.430	2	000559099
27x30	10.950	2	000559102
30x32	10.500	2	000559108

90K



mm	Ft		
6x7	4.740	5	000909006
8x9	5.080	5	000909012
10x11	5.570	5	000909018
12x13	6.080	5	000909027
14x15	6.630	5	000909033
16x17	7.570	5	000909039
18x19	8.760	5	000909045
20x22	10.100	3	000909051
21x23	11.350	2	000909057

mm	Ft		
24x26	12.850	2	000909063
24x27	14.100	2	000909067
25x28	15.350	2	000909070
27x29	16.400	2	000909073
30x32	18.500	2	000909080

93K



mm	Ft		
21x22	19.150	3	000939021

94K



mm	Ft		
8x10	8.170	2	000949008
9x11	8.460	2	000949009
10x11	8.930	2	000949010
11x13	9.220	2	000949011
12x14	9.770	2	000949012
13x15	9.770	2	000949013
14x15	11.550	2	000949014
14x17	11.800	2	000949015
17x19	12.000	2	000949017
19x22	12.850	2	000949019
22x24	15.800	2	000949022
24x27	17.050	2	000949024
30x32	22.300	2	000949030

96/SC9



96/SC9	Ft		
1,5-2-2,5-3-4-5-6-8-10 mm	9.690	1	000960374

96/ST6K



96/ST6K	Ft		
2,5-3-4-5-6-8 mm	6.850	3	000969370

96N/ST6K



96N/ST6K	Ft		
2,5-3-4-5-6-8 mm	4.850	3	000969640

96BPA/SC9



96BPA/SC9	Ft		
1,5-2-2,5-3-4-5-6-8-10 mm	22.250	1	000961974

96BP-CL/SC9



96BP-CL/SC9	Ft		
1,5-2-2,5-3-4-5-6-8-10 mm	24.700	1	000961619

96BPC/SC9



96BPC/SC9	Ft		
1,5-2-2,5-3-4-5-6-8-10 mm	20.200	1	000960354

96LBP/SC9



96LBP/SC9	Ft		
1,5-2-2,5-3-4-5-6-8-10 mm	23.650	1	000961354



96/BGS7



96/BGS7	Ft	1	000960367
1,5-2-2,5-3-4-5-6 mm	14.550		

96/BG7



96/BG7	Ft	1	000960368
2,5-3-4-5-6-8-10 mm	15.400		

96TK



mm	Ft	5	000969934
2	5.570		
2,5	5.570		000969935
3	5.870		000969936
4	6.040		000969938
5	6.170		000969940
6	7.060		000969941
8	8.930		000969943
10	10.250		000969945

97BTX/SC8



97BTX/SC8	Ft	1	000970164
T9-T10-T15-T20-T25-T27-T30-T40	36.200		

97BTXL/SC8



97BTXL/SC8	Ft	1	000970364
T9-T10-T15-T20-T25-T27-T30-T40	41.800		

111E



L mm	Ft	3	001110110
100	11.550		
150	11.950		001110115
200	14.750		001110120
250	17.800		001110125
300	23.700		001110130
380	46.350		001110138
450	77.100		001110145
600	106.500		001110160

111EN



L mm	Ft	3	001110410
100	10.500		
150	11.150		001110415
200	12.950		001110420
250	16.000		001110425
300	21.650		001110430
380	42.700		001110438
450	72.850		001110445

111ER



L mm	Ft	3	001110520
200	15.400		
250	19.000		001110525
300	24.700		001110530

123/K4



123/K4	Ft	1	001230504
	15.300		

142K



mm	Ft	3	001429006
6	8.250		
7	8.250		001429007
8	8.510		001429008
9	9.140		001429009
10	9.350		001429010
11	9.680		001429011
12	10.000		001429012
13	10.750		001429013
14	11.150		001429014
15	11.800		001429015
16	12.850		001429016
17	13.250		001429017
18	14.100		001429018
19	14.300		001429019
21	18.500		001429021
22	19.150		001429022
24	22.300		001429024

192/S2



192/S2	Ft	1	001920070
8x10/12x13 mm 16x17/18x19 mm	29.950		

195K



mm	Ft	2	001959010
8x10	9.510		
12x13	10.950		001959013
14x15	11.350		001959015
16x18	13.450		001959018
17x19	14.100		001959019

374K



L mm	Ft	1	003749024
240	17.900		



410K



Ø mm	Ft	1/4"	1/2"
* 3	695	10	004109064
* 4	970	10	004109076
* 5	1.190	10	004109088
6	795	10	004109100
7	1.160	10	004109112
8	1.460	10	004109124
9	1.840	10	004109136
10	2.230	10	004109148

412K



Ø mm	Ft	1/4"	1/2"
* 3	1.580	10	004129064
* 4	2.040	10	004129076
* 5	2.630	10	004129088
6	1.780	10	004129100
7	2.670	10	004129112
8	3.400	10	004129124
9	4.370	10	004129136
10	5.020	10	004129148

415K



Ø mm	Ft	1/4"	1/2"
3	1.860	10	004159064
4	2.590	10	004159076
5	3.120	10	004159088
6	4.370	10	004159100
7	6.360	10	004159112
8	8.140	10	004159124
9	10.700	10	004159136
10	12.750	10	004159148

720LC/S3K



12"

720LC/S3K 17-19-21 mm	Ft	1/2"	1"
	18.600	1	007209663

850MQ



L mm	Ft	1/4"	1/2"
233	11.350	1	008500910

855P



L mm	Ft	1/4"	1/2"
240	34.200	1	008550010

860/58K



L mm	Ft	1/4"	1/2"
126	36.650	1	008609884

860LP



SxA mm	Ft	1/4"	1/2"
0,5x3	900	5	008600005
0,6x4,5	900	5	008600010
0,8x5,5	900	5	008600015
1x5,5	900	5	008600020
1,2x6,5	900	5	008600025

860PH



PH	Ft	1/4"	1/2"
0	900	5	008600220
1	900	5	008600225
2	900	5	008600230
3	900	5	008600245
4	1.300	5	008600250

860PZ



PZ	Ft	1/4"	1/2"
1	900	5	008600320
2	900	5	008600325
3	900	5	008600330
4	1.300	5	008600335

860PE



mm	Ft	1/4"	1/2"
2	960	5	008600101
2,5	960	5	008600102
3	960	5	008600103
4	960	5	008600104
5	960	5	008600105
6	960	5	008600106
8	1.200	5	008600108
10	1.200	5	008600110

860TX



Ø	Ft	1/4"	1/2"
T6	1.200	5	008600704
T7	1.200	5	008600705
T8	1.200	5	008600710
T9	1.200	5	008600715
T10	960	5	008600720
T15	960	5	008600725
T20	960	5	008600730
T25	960	5	008600735
T27	960	5	008600740
T30	960	5	008600745
T40	960	5	008600750

860RTX



Ø	Ft	1/4"	1/2"
T9	1.300	5	008600550
T10	1.300	5	008600555
T15	1.300	5	008600560
T20	1.300	5	008600565
T25	1.300	5	008600570
T27	1.300	5	008600575
T30	1.300	5	008600580
T40	1.300	5	008600585

860/C27



860/C27	Ft	1/2"	1"
	41.750	1	008600880

861MIX/A10



861MIX/A10	Ft	1/2"	1"
	14.050	1	008610800

861TX/A10



861TX/A10	Ft	1/2"	1"
	15.200	1	008610870

861MIX/A31



861MIX/A31 Ft 34.450 1 008610802

862F/A7



862F/A7 Ft 23.700 1 008620950

900K



mm	Ft		
4	2.150	10	009009040
4,5	2.150	10	009009045
5	2.150	10	009009050
5,5	2.150	10	009009055
6	2.150	10	009009060
7	2.150	10	009009070
8	2.150	10	009009080
9	2.150	10	009009090
10	2.150	10	009009100
11	2.150	10	009009110
12	2.150	10	009009120
13	2.170	10	009009130
14	2.190	10	009009140

900/20LK



L mm 100 Ft 4.410 5 009009819

900/25K



L mm 41 Ft 8.060 5 009009830

900BG/30K



L mm 128 Ft 4.290 5 009009834

900/55



L mm 127 Ft 21.450 5 009001155

900/55ZK



L mm 125 Ft 21.700 3 009009882

900/58K



L mm 126 Ft 33.050 2 009009884

910AK



mm	Ft		
6	3.320	5	009109006
7	3.320	5	009109007
8	3.320	5	009109008
9	3.320	5	009109009
10	3.320	5	009109010
11	3.320	5	009109011
12	3.400	5	009109012
13	3.400	5	009109013
14	3.400	5	009109014
15	3.400	5	009109015
16	3.790	5	009109016
17	3.790	5	009109017
18	3.790	5	009109018
19	3.790	5	009109019
20	4.050	5	009109020
21	4.050	5	009109021
22	4.090	5	009109022

910/21K



L mm 125 Ft 5.710 5 009109822

910/25K



L mm 54,6 Ft 10.050 5 009109830

910/55



L mm 207 Ft 23.050 3 009101155

910/58K



L mm 222 Ft 36.400 1 009109884

920AK



mm	Ft		
10	3.340	10	009209010
11	3.340	10	009209011
12	3.340	10	009209012
13	3.460	10	009209013
14	3.460	10	009209014
15	3.460	10	009209015
16	3.830	10	009209016
17	3.830	10	009209017
18	3.830	10	009209018
19	3.830	10	009209019
20	4.130	5	009209020
21	4.130	5	009209021
22	4.130	5	009209022
23	4.780	5	009209023
24	4.780	5	009209024
25	4.780	5	009209025
26	4.900	5	009209026
27	4.900	5	009209027
28	4.900	5	009209028
29	5.140	5	009209029
30	5.140	5	009209030
32	5.340	5	009209032

920/21K



L mm 125 Ft 7.650 5 009209822

920/25K

12"



L	Ft	Hand	Code
mm 75	12.000	5	009209830

920/55

12"



L	Ft	Hand	Code
mm 271	28.150	3	009201155

920/58K

12"



L	Ft	Hand	Code
mm 281	43.350	1	009209926

935K



mm	Ft	Hand	Code
6x7	3.850	5	009359105
8x9	4.130	5	009359111
10x11	4.530	5	009359115
12x13	5.130	5	009359117
14x15	5.950	5	009359126
16x17	6.510	5	009359128
18x19	7.650	5	009359131
20x22	9.220	3	009359138

937K



mm	Ft	Hand	Code
6x6	4.130	5	009379006
7x7	4.310	5	009379007
8x8	4.400	5	009379008
9x9	4.660	5	009379009
10x10	4.870	5	009379010
11x11	5.130	5	009379011
12x12	5.700	5	009379012
13x13	5.870	5	009379013
14x14	6.420	5	009379014
15x15	7.060	5	009379015
16x16	7.610	5	009379016
17x17	7.910	5	009379017
18x18	8.000	5	009379018
19x19	8.340	5	009379019
20x20	9.430	5	009379020
21x21	10.300	3	009379021
22x22	10.950	3	009379022

943BK



mm	Ft	Hand	Code
5,5	8.000	5	009439005
6	8.000	5	009439006
7	8.590	5	009439007
8	8.590	5	009439008
10	9.350	3	009439010
13	9.940	3	009439013

951K



mm	Ft	Hand	Code
2	8.930	5	009519521
2,5	8.930	5	009519525
3	8.930	5	009519530
3,5	9.220	5	009519535
4	9.220	5	009519540
4,5	10.100	5	009519545
5	10.100	5	009519550
6	11.550	5	009519560
8	12.400	5	009519580
10	15.800	5	009519610

1032K



L	Ft	Hand	Code
mm 140x0,9	12.000	5	010329013
140x1,3	11.800	5	010329014
180	12.850	5	010329017

1033K



L	Ft	Hand	Code
mm 140x0,9	13.700	5	010339013
140x1,3	13.250	5	010339014
180	13.900	5	010339017

1034K



L	Ft	Hand	Code
mm 130x0,9	13.700	5	010349013
130x1,3	13.250	5	010349014
170	13.900	5	010349017

1036K



L	Ft	Hand	Code
mm 140x0,9	13.050	5	010369013
140x1,3	12.850	5	010369014
175	13.250	5	010369017

1037K



L	Ft	Hand	Code
mm 140x0,9	14.500	5	010379013
140x1,3	13.900	5	010379014
175	14.500	5	010379017

1038K



L	Ft	Hand	Code
mm 135x0,9	14.500	5	010389013
135x1,3	13.900	5	010389014
175	14.500	5	010389017

1044NK

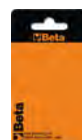

L	Ft	Hand	Code
250	14.100	5	010449025

1048NK



L	Ft	Hand	Code
mm 175	15.150	3	010489910
250	16.200	5	010489915

1048VNK



L	Ft	Hand	Code
mm 175	12.850	3	010489111
250	14.500	5	010489116

1052K



L	Ft		
mm 140	13.050	3	010529014
190	14.500	3	010529019
240	15.800	3	010529024

1082K



L	Ft		
mm 140	12.400	5	010829004
160	13.050	5	010829006

1082GK



L	Ft		
mm 140	10.750	5	010829064
160	11.150	5	010829066

1082BMK



L	Ft		
mm 140	15.550	3	010829034
160	16.850	3	010829036

1082GBMK



L	Ft		
mm 140	13.700	3	010829264
160	15.350	3	010829266

1084K



L	Ft		
mm 160	14.500	3	010849006

1084GK



L	Ft		
mm 160	12.850	5	010849066

1084BMK



L	Ft		
mm 160	17.700	3	010849036

1084GBMK



L	Ft		
mm 160	19.350	3	010849266

1088K



L	Ft		
mm 160	17.900	2	010889006

1088BMK



L	Ft		
mm 160	21.700	2	010889036

1096K



L	Ft		
mm 200	11.150	5	010969020

1098K



L	Ft		
mm 190	9.600	5	010989190
220	10.750	5	010989220

1098PLK



L	Ft		
mm 220	12.000	5	010989320

1112K



L	Ft		
mm 200	12.850	2	011129020

1122K



L	Ft		
mm 250	17.050	2	011229020

1123K



L	Ft		
mm 250	17.050	2	011239020

1124K



L	Ft		
mm 250	17.050	2	011249020

1128BAX



L mm	Ft	⚙️	📄
150	15.800	5	011280088

1128BMX



L mm	Ft	⚙️	📄
147	8.420	5	011280051

1128BSX



L mm	Ft	⚙️	📄
148	14.550	5	011280061

1128FX



L mm	Ft	⚙️	📄
145	15.400	5	011280090

1128FXS



L mm	Ft	⚙️	📄
145	18.200	5	011280095

1130BMX



L mm	Ft	⚙️	📄
185	9.430	1	011300002

1132K



L mm	Ft	⚙️	📄
170	24.400	2	011329107

1132BMK



L mm	Ft	⚙️	📄
170	29.900	2	011329137

1142BMK



L mm	Ft	⚙️	📄
160	19.800	3	011429036

1144T



L mm	Ft	⚙️	📄
112	10.050	1	011440060

1149F



L mm	Ft	⚙️	📄
175	8.300	1	011490010

1150K



L mm	Ft	⚙️	📄
160	10.950	5	011509046
180	12.000	5	011509048
200	13.050	5	011509050
220	14.300	2	011509052

1150GK



L mm	Ft	⚙️	📄
160	10.250	5	011509066
180	11.150	5	011509068
200	12.400	5	011509070
220	13.050	2	011509072

1150BMK



L mm	Ft	⚙️	📄
160	13.700	3	011509146
180	15.150	3	011509148
200	16.400	3	011509150
220	17.700	2	011509152

1150GBMK



L mm	Ft	⚙️	📄
160	12.850	3	011509266
180	13.700	3	011509268
200	15.550	3	011509270
220	16.400	2	011509272

1162K



L mm	Ft	⚙️	📄
160	13.050	5	011629006
200	15.150	5	011629010

1162GK



L mm	Ft	⚙️	📄
160	10.950	5	011629066
200	12.850	5	011629070



1162BMK



L mm	Ft	Hand	Code
160	15.800	3	011629036
200	17.700	3	011629040

1162GBMK



L mm	Ft	Hand	Code
160	13.700	3	011629266
200	16.000	3	011629270

1164K



L mm	Ft	Hand	Code
160	14.100	5	011649006
200	15.800	5	011649010

1164BMK



L mm	Ft	Hand	Code
160	17.050	3	011649036
200	19.350	3	011649040

1166K



L mm	Ft	Hand	Code
160	13.050	5	011669006
200	15.150	5	011669010

1166GK



L mm	Ft	Hand	Code
160	10.950	5	011669066
200	12.850	5	011669070

1166BMK



L mm	Ft	Hand	Code
160	15.800	3	011669036
200	17.700	3	011669040

1166GBMK



L mm	Ft	Hand	Code
160	13.700	3	011669266
200	16.000	3	011669270

1168K



L mm	Ft	Hand	Code
160	14.100	5	011689006
200	15.800	5	011689010

1168GK



L mm	Ft	Hand	Code
160	12.000	5	011689066
200	13.700	5	011689070

1168BMK



L mm	Ft	Hand	Code
160	17.050	3	011689036
200	19.350	3	011689040

1168GBMK



L mm	Ft	Hand	Code
160	15.350	3	011689266
200	17.050	3	011689270

1201E/K



SxAxL mm	Ft	Hand	Code
0,4x2,5x50	2.010	5	012019203
0,4x2,5x75	2.100	5	012019206
0,5x3x75	2.120	5	012019209
0,5x3x100	2.270	5	012019212
0,6x3,5x75	2.270	5	012019218
0,6x3,5x100	2.340	5	012019221
0,8x4x100	2.360	5	012019230
0,8x4x125	2.490	5	012019233
0,8x4x150	2.660	5	012019236
1,0x5,5x100	2.910	5	012019239
1,0x5,5x125	3.070	5	012019240
1,0x5,5x150	3.110	5	012019242
1,2x6,5x100	3.480	5	012019248
1,2x6,5x125	3.590	5	012019250
1,2x6,5x150	3.660	5	012019251
1,2x8x150	4.610	3	012019257
1,2x8x200	5.000	3	012019260
1,6x10x200	5.740	3	012019266

1201E/K



SxAxL mm	Ft	Hand	Code
0,8x4x30	2.850	3	012019303
1,2x6,5x30	3.020	3	012019306

1202E/K



PHxDxL mm	Ft	Hand	Code
0x3x60	2.100	5	012029203
0x3x100	2.340	5	012029206
1x4,5x80	2.630	5	012029209
1x4,5x120	3.000	5	012029212
2x6x100	3.590	5	012029218
2x6x150	3.850	5	012029221
3x8x150	4.830	3	012029224
4x9,5x200	6.340	3	012029227

1202E/K



PHxDxL mm	Ft	Hand	Code
1x4,5x30	2.850	3	012029303
2x6x30	3.020	3	012029306

1204E/K



SxDxL mm	Ft	Hand	Code
0,4x2,5x60	2.070	5	012049103
0,6x3x75	2.120	5	012049106
0,5x3x100	2.160	5	012049109
0,8x4x100	2.430	5	012049112
0,8x4x125	2.560	5	012049115
1,0x5x125	2.940	5	012049118
1,0x5x150	3.180	5	012049121
1,2x6,5x150	3.480	5	012049124

1207E TX/K



	Ft		
T5	3.070	5	012079105
T6	3.260	5	012079106
T7	3.330	5	012079107
T8	3.370	5	012079108
T9	3.550	5	012079109
T10	4.000	5	012079110
T15	4.050	5	012079115
T20	4.110	5	012079120
T25	4.240	5	012079125
T27	4.400	5	012079127
T30	4.440	5	012079130
T40	5.300	2	012079140
T45	5.780	2	012079145

1208E RTX/K



	Ft		
T9	3.590	5	012089109
T10	4.000	5	012089110
T15	4.240	5	012089115
T20	4.310	5	012089120
T25	4.320	5	012089125
T27	4.700	5	012089127
T30	4.960	5	012089130
T40	5.870	2	012089140

1209E PZ/K



	Ft		
PZ 0	2.430	5	012099200
1	3.110	5	012099203
2	4.000	5	012099206
3	6.000	3	012099209
4	6.550	3	012099212

1209EN-PZ/K



	Ft		
1	2.850	3	012099303
2	3.020	3	012099306

1253



SxAxL mm	Ft		
0,5x3,5x100	4.570	5	012530001

1254



SxAxL mm	Ft		
0,5x3x44	5.020	5	012540001

1260K



SxAxL mm	Ft		
0,4x2,5x50	2.770	5	012609003
0,4x2,5x75	2.870	5	012609006
0,5x3x75	2.940	5	012609009
0,5x3x100	3.050	5	012609012
0,6x3,5x75	3.130	5	012609018
0,6x3,5x100	3.180	5	012609021
0,8x4x100	3.480	5	012609030
0,8x4x125	3.610	5	012609033
0,8x4x150	3.770	5	012609036
1x5,5x100	3.980	5	012609039
1x5,5x150	4.360	5	012609042
1,5x6,5x100	4.700	5	012609048
1,2x6,5x150	5.080	5	012609051
1,2x8x150	6.170	3	012609057
1,2x8x200	6.380	3	012609060
1,6x10x200	7.700	3	012609066

1260NK



SxAxL mm	Ft		
0,8x4x30	3.660	5	012609103
1,2x6,5x30	4.070	5	012609106

1260EK



SxAxL mm	Ft		
1,2x6,5x150	6.550	3	012609156
1,2x8x175	8.040	3	012609157
1,6x10x200	9.220	2	012609159
2x12x250	10.750	2	012609162

1262K



PHxDxL mm	Ft		
0x3x60	2.940	5	012629003
0x3x100	3.110	5	012629006
1x4,5x80	3.850	5	012629009
1x4,5x120	4.200	5	012629012
2x6x100	4.660	5	012629018
2x6x150	5.130	5	012629021
3x8x150	6.850	3	012629024
4x10x200	8.630	3	012629027

1262NK



PHxDxL mm	Ft		
1x4,5x30	3.660	5	012629103
2x6x30	4.070	5	012629106

1262EK



PHxDxL mm	Ft		
2x6x150	6.550	3	012629153
3x8x175	7.950	3	012629156
4x10x200	9.890	3	012629159

1264K



SxDxL mm	Ft		
0,5x2,5x60	2.770	5	012649003
0,6x3x75	2.940	5	012649006
0,6x3x100	3.050	5	012649009
0,8x4x100	3.480	5	012649012
0,8x4x125	3.610	5	012649015
1x5x125	4.070	5	012649018
1x5x150	4.290	5	012649021
1,2x6,5x150	5.080	5	012649024

1267TXK



Ø	Ft		
T5	4.110	5	012679005
T6	4.290	5	012679006
T7	4.360	5	012679007
T8	4.570	5	012679008
T9	4.740	5	012679009
T10	4.960	5	012679010
T15	5.210	5	012679015
T20	5.510	5	012679020
T25	5.950	5	012679025
T27	6.170	5	012679027
T30	6.510	5	012679030
T40	7.530	2	012679040
T45	8.210	2	012679045

1268RTXK



⊕	Ft	👤	📦
T9	5.170	3	012689009
T10	5.340	3	012689010
T15	5.510	3	012689015
T20	5.950	3	012689020
T25	6.080	3	012689025
T27	6.510	3	012689027
T30	6.590	3	012689030
T40	7.610	2	012689040

1269PZK



PZ	Ft	👤	📦
0	3.350	5	012699000
1	4.270	5	012699001
2	5.170	5	012699002
3	7.360	3	012699003
4	9.300	3	012699004

1269N/PZK



PZ	Ft	👤	📦
1	3.660	5	012699011
2	4.070	5	012699012

1290K



SxAxL mm	Ft	👤	📦
0,4x2,5x50	3.550	5	012909003
0,4x2,5x75	3.660	5	012909006
0,5x3x75	3.740	10	012909009
0,5x3x100	3.920	10	012909012
0,6x3,5x75	4.240	10	012909018
0,6x3,5x100	4.310	10	012909021
0,8x4x100	4.270	10	012909030
0,8x4x125	4.400	10	012909033
0,8x4x150	4.700	10	012909036
1x5,5x100	4.790	10	012909039
1x5,5x150	5.300	10	012909042
1,2x6,5x100	5.950	10	012909048
1,2x6,5x150	6.250	10	012909051
1,2x8x150	7.870	3	012909057
1,2x8x200	8.250	3	012909060
1,6x10x200	9.680	3	012909066

1290NK



SxAxL mm	Ft	👤	📦
0,8x4x30	4.530	5	012909103
1,2x6,5x30	5.040	5	012909106

1290K/INOX



SxAxL mm	Ft	👤	📦
0,4x2,5x50	4.440	4	012909403
0,5x3x75	4.570	4	012909409
0,8x4x100	4.740	4	012909430
1,0x5,5x150	6.040	4	012909442
1,2x6,5x150	6.930	4	012909451

1292K



PHxDxL mm	Ft	👤	📦
0x3x60	3.370	10	012929003
0x3x100	3.850	5	012929006
1x4,5x80	4.570	10	012929009
1x4,5x120	5.080	10	012929012
2x6x100	6.040	10	012929018
2x6x150	6.460	10	012929021
3x8x150	8.170	3	012929024
4x10x200	11.150	3	012929027

1292NK



PHxDxL mm	Ft	👤	📦
1x4,5x30	4.320	5	012929103
2x6x30	4.740	5	012929106

1292K/INOX



PHxDxL mm	Ft	👤	📦
0x3x60	4.240	4	012929403
1x4,5x80	4.960	4	012929409
2x6x100	6.040	4	012929418

1294K



SxDxL mm	Ft	👤	📦
0,5x2,5x60	3.310	5	012949003
0,6x3x75	3.500	5	012949006
0,8x4x100	4.270	5	012949012
1x5x125	5.340	5	012949018

1298RTXK



⊕	Ft	👤	📦
T9	7.140	5	012989009
T10	7.310	5	012989010
T15	7.780	5	012989015
T20	7.820	5	012989020
T25	7.990	5	012989025
T27	8.510	5	012989027
T30	8.840	5	012989030
T40	9.510	2	012989040

1299PZK



PZ	Ft	👤	📦
0	4.790	5	012999000
1	5.610	5	012999003
2	7.610	5	012999006

1299N/PZK



PZ	Ft	👤	📦
1	5.470	5	012999021
2	6.040	5	012999024

1472VW



L mm	Ft	👤	📦
200	22.050	1	014720051

1473P



A Max mm	Ft		
53	17.200	1	014730020

1497BS



L mm	Ft		
230	10.950	1	014970190

1497SS



L mm	Ft		
245	9.960	1	014970195

1497RC



1497RC	Ft		
	35.600	1	014970351

1600Q 8



1600Q 8	Ft		
	13.750	1	016000008

1600Q 10



1600Q 10	Ft		
	17.600	1	016000010

1603K



mm ²	Ft		
0÷8	7.990	5	016039001

1603BK



mm ²	Ft		
0÷8	29.700	2	016039010

1651DGTB

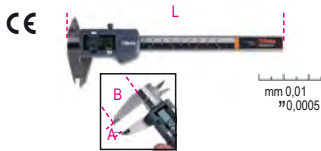

A Max mm	Ft		
150	48.600	1	016510211
200	63.150	1	016510212
300	82.600	1	016510213

1651DGTB/IP

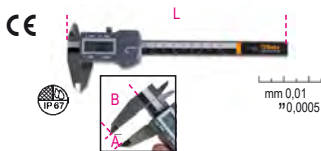

A Max mm	Ft		
150	79.350	1	016510711

1691BM



L m	Ft		
5	7.570	1	016910205
8	11.350	1	016910208
10	13.750	1	016910210



1691MG

CE



L m	Ft		
5	6.800	1	016910405
8	9.510	1	016910408
10	10.100	1	016910410

1692

CE



L m	Ft		
2	3.680	5	016920052
3	4.570	5	016920053
5	6.560	5	016920055
8	9.430	5	016920058

1693

CE



IP54



H mm	Ft		
100	58.100	1	016930020

1729CG



L mm	Ft		
310	11.150	2	017290200

1729DM 450



L mm	Ft		
450	12.750	4	017290450



1729J



L mm 405 Ft 17.000 4 017290400

1729MF



1729MF Ft 11.150 1 017290500

1741U



Ø mm	2,4	3	3,2	4	4,8
Alumíni	•	•	•	•	•
Acél	•	•	•	•	•
Rozsdamentes acél	•	•	•	•	•

1741U Ft 21.850 1 017410450

1741



Ø mm	2,4	3,2	4	4,8	5
Alumíni	•	•	•	•	•
Acél	•	•	•	•	•
Rozsdamentes acél	•	•	•	•	•

1741 Ft 17.600 1 017410003

1741P



260 mm

Ø mm	2,4	3	3,2	4	4,8	5
Alumíni	•	•	•	•	•	•
Acél	•	•	•	•	•	•
Rozsdamentes acél	•	•	•	•	•	•

1741P Ft 24.500 1 017410303

1741TR



285 mm

Ø mm	2,4	3	3,2	4	4,8
Alumíni	•	•	•	•	•
Acél	•	•	•	•	•
Rozsdamentes acél	•	•	•	•	•

1741TR Ft 19.250 1 017410410

1760K



CE 180 mm CAT III-1000V

1760K Ft 17.600 1 017600140

1762K



Ø mm	2-2,5-3	Ft	15.150	2	017629001
	3,5-4-4,5				

1771



1771 Ft 4.410 10 017710000

1771BM



L mm 170 Ft 9.680 10 017710050

1771HD



L mm 190 Ft 10.950 5 017710100

1772R



L mm 125 Ft 8.140 5 017720006

1773A



L mm 180 Ft 8.580 10 017730000

1773S



L mm 190 Ft 4.010 1 017730100

1777BMT



L mm 170 Ft 13.150 5 017770050



1777T



L	Ft		
mm 160	12.350	5	017770030

1778MT



L	Ft		
mm 180	46.750	1	017780055

1783



L	Ft		
mm 215	7.170	5	017830021
240	8.020	5	017830024

1820



1820 30	Ft		
30W	22.850	1	018200003
L = 210mm			
1820 60	26.300	1	018200006
60W			
L = 220mm			
1820 80	37.250	1	018200008
80W			
L = 260mm			

1822



1822 120	Ft		
120W	56.900	1	018220012
LxA = 250x125 mm			
1822 180	60.100	1	018220018
180W			
LxA = 250x125mm			
1822 320	74.900	1	018220032
320W			
LxA = 250x140mm			

1833XSW



L	Ft		
145	22.050	1	018330011

1833S



L	Ft		
mm 150	17.600	1	018330002

1833M



L	Ft		
mm 162	22.050	1	018330003

1833MW



L	Ft		
mm 160	40.300	1	018330013

1833L



L	Ft		
mm 196	36.850	1	018330004

1833XL



L	Ft		
mm 300	46.150	1	018330005

1836AW



1836AW	Ft		
	33.200	1	018360051

1836B



1836B	Ft		
	60.100	1	018360200

1837F/USB



L	Ft		
460	59.100	1	018370060



1838COMPACT



IP65
IK07



L mm 120 Ft 28.950 1 018380011

1838PN



IP65
IK07



L mm 175 Ft 25.900 1 018380008

1838POCKET



IP65
IK07



L mm 98 Ft 31.350 1 018380080

1838SLIM

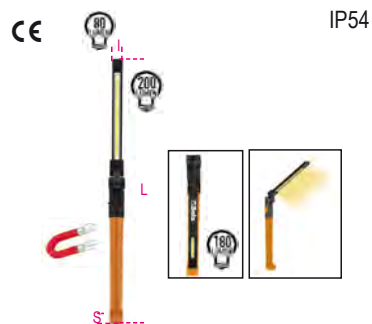

IP54



L mm 307 Ft 33.600 1 018380221

1838SW



IP65
IK07



L mm 260 Ft 44.750 1 018380142

1839BRW



IP20
IK07



L mm 101 Ft 42.300 1 018390002

1875SP/K3



1875SP/K3 Ft 8.620 1 018750010

1949F2



Ø 1/4" GAS BSP



g 125 Ft 8.020 1 019490028

1949XS



Ø 1/4" GAS



g 20 Ft 3.180 25 019490025

M01K



42

6 - 7 - 8 - 9 - 10 - 11 - 12 - 13 - 14 - 15
- 16 - 17 - 18 - 19 - 20 - 21 - 22 - 24 - 27
- 30 - 32 - 36 mm

4,5 kg



M01K Ft 201.200 1 024509001

M63K



952

7 - 8 - 10 - 12 - 13 - 14 - 17 - 19 mm

3,4 kg



M63K Ft 156.700 1 024509063

M129K



1032 180 mm
1034 170 mm
1036 175 mm
1038 175 mm
1048N 250 mm
1052 240 mm
1082BM 160 mm
1098 220 mm
1112 250 mm
1128BM 145 mm
1150BM 180 mm
1166BM 160 mm
1168BM 160 mm

3,4 Kg



M129K Ft 200.200 1 024509129

M213K

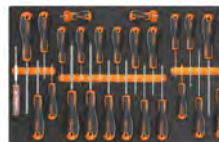

1201E 2,5x50 - 3x75 - 4x100 - 5,5x125 - 6,5x150
- 8x200 mm
1201EN 4x30 mm
1202E PH0x60 - PH1x80 - PH2x100 - PH3x150
mm
1202EN PH1X30 mm
1207E/TX T6 - T7 - T8 - T9 - T10 - T15 - T20 - T25
- T27 - T30 - T40 - T45
1253 3,5x100 mm

1,8 Kg



M213K Ft 99.150 1 024509213



SHOP
in Shop



SZERKESZSE MEG EGYEDI BETA BEMUTATÓFALÁT

www.beta-tools.com/planner3d/

38/DS1

Fali állvány75 ütőszerszámmal



495x260x332 mm

Állvány
szerszámmal
38/DS1 **Ft** 334.500 1 000380701

		n.
30	Ø 2 - 3 - 4 - 5 - 6 mm	5
31	Ø 2 - 3 - 4 - 5 - 6 - 8 - 10 mm	5
32	Ø 3 - 4 - 5 mm	5

Állvány
üres
38/DVS1 **Ft** 52.400 1 000380751

38/DS2

Fali állvány65 ütőszerszámmal



495x260x332 mm

Állvány
szerszámmal
38/DS2 **Ft** 633.000 1 000380702

		n.
34	125 - 150 - 175 mm	5
35	100 - 125 - 150 - 200 - 250 - 300 mm	5
36	125 - 150 mm	5
37	150 - 200 mm	5

Állvány
üres
38/DVS2 **Ft** 52.400 1 000380752

942BX/DG

Fali állvány 43 hatlapú dugókulcs-
csavarhúzóval, rövid kivitel



330x260x332 mm

Állvány
szerszámmal
942BX/DG **Ft** 334.900 1 009420701

		n.
942BX	5 - 5,5 mm	3
	6 - 7 mm	6
	8 - 9 - 10 mm	5
	11 mm	2
	12 mm	3
	13 mm	5

Állvány
üres
942BX/DVG **Ft** 46.350 1 009420751

943BX/DG

Fali állvány 43 hatlapú dugókulcs-
csavarhúzóval, hosszított kivitel



330x260x332 mm

Állvány
szerszámmal
943BX/DG **Ft** 360.500 1 009430701

		n.
943BX	5 - 5,5 mm	3
	6 - 7 mm	6
	8 - 9 - 10 mm	5
	11 mm	2
	12 mm	3
	13 mm	5

Állvány
üres
943BX/DVG **Ft** 46.350 1 009430751

944BX/DG

Fali állvány 43 hatlapú dugókulcs-
csavarhúzóval, hosszított kivitel



330x260x332 mm

Állvány
szerszámmal
944BX/DG **Ft** 416.300 1 009440701

		n.
944BX	5 - 5,5 mm	3
	6 - 7 mm	6
	8 - 9 - 10 mm	5
	11 mm	2
	12 mm	3
	13 mm	5

Állvány
üres
944BX/DVG **Ft** 46.350 1 009440751

943MQ/BG

Fali állvány 30 hatlapú dugókulcs-
csavarhúzóval



△ 1000 V ⚡ 330x260x332 mm

Állvány
szerszámmal
943MQ/BG **Ft** 292.700 1 009430281

		n.
943MQ	5,5 - 6 - 7 - 8 - 10 - 13 mm	5

Állvány
üres
943BG-MQ/DV **Ft** 46.350 1 009430285

1203/E1P

Fali bemutató állvány
82 csavarhúzóval



495x260x310 mm

Állvány
szerszámmal **Ft** 1 012031301

		n.
1201	0,4x2,5x50 - 0,5x3x75 - 0,6x3,5x100 0,8x4x100 - 0,8x4x125 mm 1,0x5,5x100 - 1,0x5,5x150 - 1,2x6,5x150 mm 1,2x8x150 mm	7 6 6 5
1202	PH0x3x60 mm PH1x4,5x80 - PH2x6x100 mm PH3x8x150 mm	7 6 5

Állvány
üres **Ft** 1 012031351

1203/E5P

Fali bemutató állvány
82 csavarhúzóval



495x260x310 mm

Állvány
szerszámmal **Ft** 1 012031305

		n.
1202	PH0x3x60 mm PH1x4,5x80 - PH1x4,5x120 PH2x6x100 - PH2x6x150 mm PH3x8x150 mm	7 6 6 5
1204	0,4x2,5x60 - 0,5x3x100 - 0,8x4x100 mm 1,0x5x125 mm	7 6
1209PZ	PZ0x3x60 mm PZ1x4,5x80 - PZ2x6x100 mm	7 6

Állvány
üres **Ft** 1 012031355

1263/E78

Fali állvány 78 csavarhúzóval



495x260x310 mm

Állvány
szerszámmal **Ft** 1 012630510

1260	2,5x75-3x75-3,5x100 mm 4x100-4x125-5,5x100-5,5x150-6,5x150 mm 8x150 mm	7 6 4
1262	PH0x60 mm PH1x80-PH2x100 mm PH3x150	7 6 4

Állvány
üres **Ft** 1 012630511

1203/E4P

Fali bemutató állvány
85 csavarhúzóval



495x260x310 mm

Állvány
szerszámmal **Ft** 1 012031304

		n.
1201	0,4x2,5x50 - 0,5x3x75 - 0,8x4x125 mm 1,0x5,5x100 - 1,0x5,5x150 - 1,2x6,5x150 mm	7 6
1204	0,4x2,5x60 - 0,5x3x100 - 0,8x4x100 mm 1,0x5x125 mm	7 6
1209PZ	PZ0x3x60 mm PZ1x4,5x80 - PZ2x6x100 mm	7 6

Állvány
üres **Ft** 1 012031354

1203/E10P

Fali bemutató állvány
80 csavarhúzóval



495x260x310 mm

Állvány
szerszámmal **Ft** 1 012031310

		n.
1207TX	T6 T7 T8 T9 - T10 - T15 - T20 - T25 T27 - T30	4 3 7 6 3
1208RTX	T9 - T10 T15 - T20 - T25 T27 - T30	3 6 3

Állvány
üres **Ft** 1 012031360

1263/E74

fali bemutató állvány
74 csavarhúzóval



495x260x310 mm

Állvány
szerszámmal **Ft** 1 012630540

1264	2,5x60 mm 3x75 mm 3x100 - 4x100 mm 4x125 - 5x150 mm 5x125 - 6,5x150 mm	7 3 4 2 4
1262	PH 8x150 PH 3x60 - 3x100 mm PH 4,5x80 - 4,5x120 mm PH 6x100 mm PH 6x150 mm	3 7 6 10 5

Állvány
üres **Ft** 1 012630541

1263/E85

Fali állvány
85 csavarhúzóval



495x260x377 mm

Állvány
szerszámmal
1263/E85 **Ft** 323.500 1 012630550

		n.
● 1260	2,5x50 mm	7
	2,5x75 mm	6
	3x75 - 3x100 - 3,5x100 mm	7
	4x100 - 4x125 - 5,5x125	6
	5,5x150 - 6,5x150 mm	4
	8x150 mm	4
● 1260E	10x200 mm	3
	12x250 mm	2
	4x30 - 6,5x30 mm	6

Állvány
üres
1263/EV85 **Ft** 53.450 1 012630551

1263/E70

Fali állvány
70 csavarhúzóval



495x260x327 mm

Állvány
szerszámmal
1263/E70 **Ft** 318.700 1 012630560

		n.
⊕ 1262	PH0x60 - PH0x100 mm	7
	PH1x80 - PH1x120 mm	6
	PH2x100 mm	9
	PH2x150 - PH3x150 mm	5
	PH4x200 mm	4
⊕ 1262E	PH2x150 mm	5
	PH3x175 mm	4
⊕ 1262N	PH1x30 - PH2x30 mm	6

Állvány
üres
1263/EV70 **Ft** 53.450 1 012630561

1263/E50

Fali állvány
50 csavarhúzóval



330x260x269 mm

Állvány
szerszámmal
1263/E50 **Ft** 167.300 1 012630570

		n.
● 1264	2,5x60 - 3x75 - 3x100 mm	7
	4x100 - 4x125 - 5x125 - 5x150 mm	6
	6,5x150 mm	5

Állvány
üres
1263/EV50 **Ft** 46.350 1 012630571

1263/E62

Fali állvány
62 csavarhúzóval



495x260x257 mm

Állvány
szerszámmal
1263/E62 **Ft** 308.000 1 012630590

		n.
⊖ 1267TX	T5	5
	T6	6
	T7	5
	T8	6
	T9	5
	T10 - T15 - T20	6
	T25	5
	T27 - T30	4
	T40 - T45	2

Állvány
üres
1263/EV62 **Ft** 53.450 1 012630591

1263/E39

Fali állvány
39 csavarhúzóval



330x260x257 mm

Állvány
szerszámmal
1263/E39 **Ft** 217.900 1 012630595

		n.
⊕ 1268RTX	T9x60 - T10x80 - T15x80	6
	T20x100 - T25x100 mm	4
	T27x115 mm	3
	T30x115 mm	2
	T40x130 mm	2

Állvány
üres
1263/EV39 **Ft** 46.350 1 012630596

1263/E40

Fali állvány
40 csavarhúzóval



330x260x327 mm

Állvány
szerszámmal
1263/E40 **Ft** 193.500 1 012630580

		n.
⊕ 1269	PZ0x60 mm	7
	PZ1x80 mm	6
	PZ2x100 - PZ3x150 - PZ4x200 mm	5
⊕ 1269N	PZ1x30 - PZ2x30 mm	6

Állvány
üres
1263/EV40 **Ft** 46.350 1 012630581

1273MQ/E1

Fali állvány 40 csavarhúzóval



△ 1000 V

330x260x332 mm

Állvány
szerszámmal
1273MQ/E1 Ft 245.500 1 012730312

Állvány szerszámmal	Állvány szerszámmal	Állvány szerszámmal	Állvány szerszámmal	Állvány szerszámmal
1272MQ	PH0x60 - PH1x80 mm	5		
	PH2x100 mm	3		
	PH3x150 mm	2		
1274MQ	3x100 - 4x100 - 5,5x125 - 6,5x150 mm	5		
	8x175 mm	3		
	10x200 mm	2		

Állvány
üres
1273BG-MQ/DV Ft 46.350 1 012730651

1273MQ/E4

fali bemutató állvány
43 csavarhúzóval



△ 1000 V

330x260x332 mm

Állvány
szerszámmal
1273MQ/E4 Ft 333.100 1 012730315

1272MQF	4,5x80 - 6x100 mm	3		
1274MQF	3,5x100 - 4,5x100 - 5,5x125 - 6,5x150 mm	3		
1275MQ/C	4,5x80 - 6x100 mm	5		
1276MQ/C	4,5x80 - 6x100 mm	5		
1279MQ/F	4,5x80 mm	3		
	6x100 mm	2		

Állvány
üres
1273BG-MQ/DV4 Ft 46.350 1 012730655

1293BX/DA

Fali állvány 90 csavarhúzóval



495x260x332 mm

Állvány
szerszámmal
1293BX/DA Ft 432.700 1 012930701

1290	3x75 - 3,5x100 - 4x100 - 4x125 5,5x100 - 5,5x150 mm 6,5x150 mm	7 6 6		
	8x150 mm	3		
	10x200 mm	2		
1290N	4x30 - 6,5x30 mm	3		
1292	PH0x60 - PH1x80 mm	7		
	PH2x100 mm	6		
	PH3x150 mm	5		
1292N	PH1x30 - PH2x30 mm	3		

Állvány
üres
1293BX/DVA Ft 53.650 1 012930751

1293BX/DD

Fali állvány 48 csavarhúzóval



330x260x332 mm

Állvány
szerszámmal
1293BX/DD Ft 204.800 1 012930704

1294	2,5x60 - 3x75 - 3x100 - 4x100 4x150 - 5x125 mm 6,5x150 mm	7 6 6		
------	---	-------------	--	--

Állvány
üres
1293BX/DVD Ft 46.750 1 012930754

1293BX/DE

Fali állvány 42 csavarhúzóval



330x260x332 mm

Állvány
szerszámmal
1293BX/DE Ft 305.700 1 012930705

1299PZ	PZ0x60 - PZ1x80 mm	7		
	PZ2x100 mm	6		
	PZ3x150 - PZ4x200 mm	5		
1299N/PZ	PZ1x30 - PZ2x30 mm	6		

Állvány
üres
1293BX/DVE Ft 46.750 1 012930755

1293BX/DF

Fali állvány 59 csavarhúzóval



330x260x332 mm

Állvány
szerszámmal
1293BX/DF Ft 404.000 1 012930706

1297TX	T6 - T8 - T10 - T15 - T20 - T25 T27 - T30 T40	7 6 5		
--------	---	-------------	--	--

Állvány
üres
1293BX/DVF Ft 46.750 1 012930756

C68

Beta bemutató állvány, 5 üres panellel



1000x560x2200 mm

		Ft		
C68/1	1 m	995.300	1	068000001
C68/2	2 m	1.734.200	1	068000002
C68/3	3 m	2.473.100	1	068000003
C68/4	4 m	3.211.900	1	068000004
C68/5	5 m	3.950.800	1	068000005
C68/6	6 m	4.689.700	1	068000006
C68/7	7 m	5.428.500	1	068000007
C68/8	8 m	6.167.400	1	068000008
C68/9	9 m	6.906.300	1	068000009
C68/10	10 m	7.645.100	1	068000010

C68N

Beta bemutatóállvány, üres



1000x560x2200 mm

		Ft		
C68N/1	1 m	857.700	1	068000031
C68N/2	2 m	1.596.600	1	068000032
C68N/3	3 m	2.335.400	1	068000033
C68N/4	4 m	3.074.300	1	068000034
C68N/5	5 m	3.813.200	1	068000035
C68N/6	6 m	4.552.000	1	068000036
C68N/7	7 m	5.290.900	1	068000037
C68N/8	8 m	6.029.800	1	068000038
C68N/9	9 m	6.768.600	1	068000039
C68N/10	10 m	7.507.500	1	068000040

C68 G

Bemutató gondola



1000x1120x1600 mm

		Ft		
C68G/1	1 m	906.100	1	068000051
C68G/2	2 m	1.668.400	1	068000052
C68G/3	3 m	2.430.800	1	068000053
C68G/4	4 m	3.193.100	1	068000054

C88 R/1

Robur bemutató állvány, 5 üres panellel



1000x560x2200 mm

		Ft		
C88R/1	1 m	995.300	1	088000001

C88NR/1

Robur bemutatóállvány, üres



1000x560x2200 mm

		Ft		
C88NR/1	1 m	857.700	1	088000031

C88VE

kiállító tálca C88 falhoz

a 8120 cikkszámú lánc-tekercesek elhelyezésére alkalmas



		Ft		
C88VE		106.100	1	088000120

C88SE

bemutató állvány oldalhegesztett lánc-tekercesekhez



		Ft		
C88SE		256.700	1	088000130

1700x600x600 mm



6888

Szerszámtartók a C60 - C61 - C68 - C88 típusú bemutató állványhoz

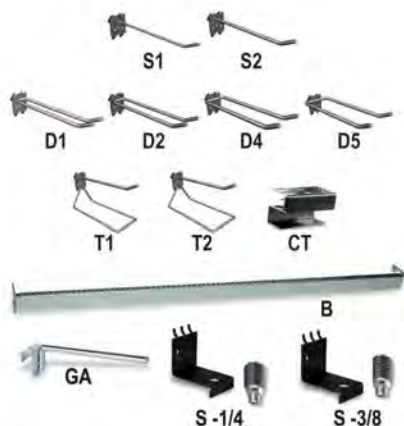

	Ft		
6888S1	2.040	10	068880011
6888S2	2.040	10	068880012
6888D1	3.240	5	068880021
6888D2	3.240	5	068880022
6888D4	3.320	5	068880024
6888D5	3.320	5	068880025
6888T1	4.570	5	068880031
6888T2	4.570	5	068880032
6888CT	8.620	1	068880044
6888B	30.750	1	068880100
6888GA	10.100	3	068880120
6888S-1/4	18.350	1	068880605
6888S-3/8	18.350	1	068880610

6800 VE

Vitrin a C68 és C68 R/1 bemutató állványhoz

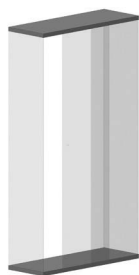

	Ft		
6800VE/1	1 m	496.800	1 068000401
6800VE/2	2 m	757.500	1 068000402
6800VE/3	3 m	1.018.200	1 068000403
6800VE/4	4 m	1.278.900	1 068000404
6800VE/5	5 m	1.539.700	1 068000405

6600 M/22

108 darab szerszám, akasztókkal, panel nélkül



	Ft		
6800AE	99.200	1	068000145
6800AI	204.900	1	068000140
6800AD/P	349.000	1	068000143



	Ft		
6600 M/22	734.000	1	066000022

6600 M/27

25 darab szerszám akasztókkal, panel nélkül



	Ft		
6800CB/100	114.600	1	068000104
6800FB/100	40.300	1	068000109
6800FO/100	27.550	1	068000108
6800PL	116.200	1	068000137
6800RP/100	36.850	1	068000150
6800GR/37	15.600	1	068000159



	Ft		
6600 M/27	511.800	1	066000027

6600 M/29

173 darabos szerszámkészlet, akasztókkal, panel nélkül



	Ft		
6800PM/40	36.850	1	068000171
6800PM/80	49.600	1	068000172

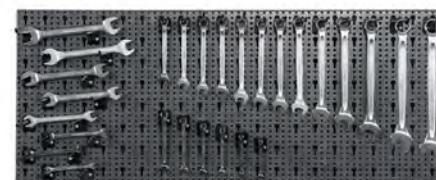

	Ft		
6600 M/29	976.300	1	066000029

6600 M/14

154 darabos szerszámkészlet, akasztókkal, panel nélkül

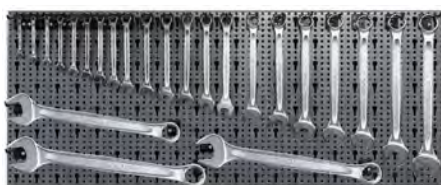

	Ft		
6600 M/14	1.108.900	1	066000014

6600 M/33

37 darab szerszám, akasztókkal, panel nélkül



	Ft		
6600 M/33	817.200	1	066000033



6600 M/40

100 darab szerszám
akasztókkal, panel nélkül



6600 M/40 Ft 1.214.700 1 066000040

6600 M/51

257 darab szerszám
akasztókkal, panel nélkül



6600 M/51 Ft 1.295.400 1 066000051

6600 M/61

71 darab szerszám
akasztókkal, panel nélkül

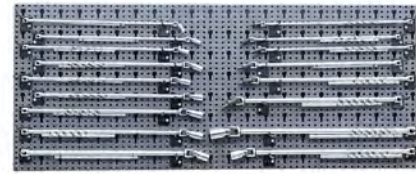

6600 M/61 Ft 1.174.900 1 066000061

6600 M/42

65 szerszámból álló készlet
akasztókkal, panel nélkül



6600 M/42 Ft 784.500 1 066000042

6600 M/52

176 darab szerszám
akasztókkal, panel nélkül



6600 M/52 Ft 847.000 1 066000052

6600 M/63

110 darab szerszám
akasztókkal, panel nélkül

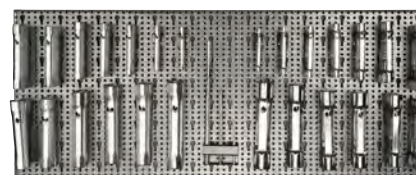

6600 M/63 Ft 1.063.700 1 066000063

6600 M/44

48 darabos szerszámkészlet,
akasztókkal, panel nélkül

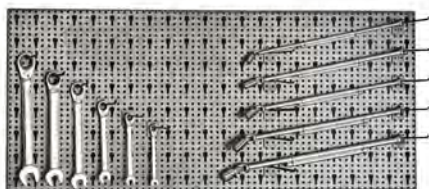

6600 M/44 Ft 679.600 1 066000044

6600 M/58

150 darab szerszám
akasztókkal, panel nélkül



6600 M/58 Ft 921.000 1 066000058

6600 M/73

68 darab szerszám
akasztókkal, panel nélkül



6600 M/73 Ft 695.000 1 066000073

6600 M/47

65 darab szerszám
akasztókkal, panel nélkül



6600 M/47 Ft 730.600 1 066000047

6600 M/59

220 darabos szerszámkészlet
akasztókkal, panel nélkül



6600 M/59 Ft 981.200 1 066000059

6600 M/112

329 darab szerszám akasztókkal, panel nélkül

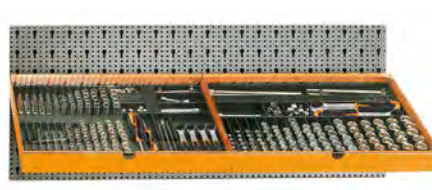

6600 M/112 Ft 1.154.000 1 066000112

6600 M/116

306 darab szerszám akasztókkal, panel nélkül



6600 M/116 Ft 1.080.200 1 066000116

6600 M/120

163 darab szerszám akasztókkal, panel nélkül



6600 M/120 Ft 793.100 1 066000120

6600 M/125

133 darab szerszám akasztókkal, panel nélkül



6600 M/125 Ft 683.700 1 066000125

6600 M/126

58 darab szerszám akasztókkal, panel nélkül



6600 M/126 Ft 411.500 1 066000126

6600 M/131

92 darab szerszám akasztókkal, panel nélkül



6600 M/131 Ft 1.296.800 1 066000131

6600 M/174

13 darab szerszám akasztókkal, panel nélkül



6600 M/174 Ft 1.942.500 1 066000174

6600 M/217

74 darabos szerszámkészlet akasztókkal, panel nélkül



6600 M/217 Ft 1.265.200 1 066000217

6600 M/218

58 darabos szerszámkészlet akasztókkal, panel nélkül



6600 M/218 Ft 668.800 1 066000218

6600 M/223

58 darabos szerszámkészlet akasztókkal, panel nélkül



6600 M/223 Ft 875.500 1 066000223

6600 M/230

78 darabos szerszámkészlet akasztókkal, panel nélkül



6600 M/230 Ft 1.124.500 1 066000230

6600 M/236

31 darabos szerszámkészlet akasztókkal, panel nélkül



6600 M/236 Ft 632.000 1 066000236

6600 M/241

43 darabos szerszámkészlet akasztókkal, panel nélkül



6600 M/241 Ft 544.700 1 066000241

INDUSTRIAL FINISHING

INDUSTRIAL FINISHING

6600 M/242

91 darabos szerszámkészlet akasztókkal, panel nélkül



6600 M/242 Ft 1.308.100 1 066000242

6600 M/326

155 darabos szerszámkészlet akasztókkal, panel nélkül



6600 M/326 Ft 642.200 1 066000326

6600 M/380

71 darabos szerszámkészlet akasztókkal, panel nélkül



6600 M/380 Ft 334.100 1 066000380

6600 M/253

60 darabos szerszámkészlet akasztókkal, panel nélkül



6600 M/253 Ft 916.000 1 066000253

6600 M/327

101 darabos szerszámkészlet akasztókkal, panel nélkül



6600 M/327 Ft 526.000 1 066000327

6600 M/406

107 darabos szerszámkészlet akasztókkal, panel nélkül



6600 M/406 Ft 561.000 1 066000406

6600 M/315

149 darabos szerszámkészlet akasztókkal, panel nélkül



6600 M/315 Ft 914.500 1 066000315

6600 M/330

110 darabos szerszámkészlet akasztókkal, panel nélkül



6600 M/330 Ft 431.800 1 066000330

6600 M/417

43 darabos szerszámkészlet akasztókkal, panel nélkül



6600 M/417 Ft 485.600 1 066000417

6600 M/320

98 darabos szerszámkészlet akasztókkal, panel nélkül



6600 M/320 Ft 795.200 1 066000320

6600 M/371

162 darabos szerszámkészlet akasztókkal, panel nélkül



6600 M/371 Ft 520.500 1 066000371

6600 M/427

24 darabos szerszámkészlet akasztókkal, panel nélkül



6600 M/427 Ft 524.300 1 066000427

6600 M/430

29 darabos szerszámkészlet akasztókkal, panel nélkül



6600 M/430 Ft 511.500 1 066000430

6600 M/440

140 darabos szerszámkészlet akasztókkal, panel nélkül

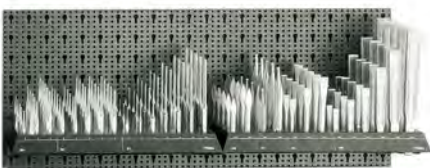

6600 M/440 Ft 967.500 1 066000440

6600 M/456

41 darabos szerszámkészlet akasztókkal, panel nélkül



6600 M/456 Ft 783.400 1 066000456

6600 M/465

36 darabos szerszámkészlet akasztókkal, panel nélkül



6600 M/465 Ft 887.000 1 066000465

6600 M/480

18 darabos szerszámkészlet akasztókkal, panel nélkül



6600 M/480 Ft 559.900 1 066000480

6600 M/485

12 darabos szerszámkészlet akasztókkal, panel nélkül



6600 M/485 Ft 402.400 1 066000485

6600 M/510

16 darabos szerszámkészlet akasztókkal, panel nélkül



6600 M/510 Ft 554.000 1 066000510

6600 M/532

24 darabos szerszámkészlet akasztókkal, panel nélkül



6600 M/532 Ft 453.000 1 066000532

6600 M/534

51 darabos szerszámkészlet akasztókkal, panel nélkül



6600 M/534 Ft 725.200 1 066000534

6600 M/542

53 darabos szerszámkészlet akasztókkal, panel nélkül



6600 M/542 Ft 449.600 1 066000542

6600 M/548

37 darabos szerszámkészlet akasztókkal, panel nélkül



6600 M/548 Ft 410.100 1 066000548

6600 M/555

28 darab szerszámból álló készlet szerszámtartóval, fal nélkül



6600 M/555 Ft 987.200 1 066000555

6600 M/561

60 darabos szerszámkészlet akasztókkal, panel nélkül



6600 M/561 Ft 591.100 1 066000561

6600 M/565

324 darab szerszámából álló készlet szerszámtartóval, fal nélkül



6600 M/565 Ft 409.100 1 066000565

6600 M/566

324 darab szerszámából álló készlet szerszámtartóval, fal nélkül



6600 M/566 Ft 836.600 1 066000566

6600 M/567

294 darab szerszámából álló készlet szerszámtartóval, fal nélkül



6600 M/567 Ft 1.736.400 1 066000567

6600 M/589

31 darab szerszámából álló készlet szerszámtartóval, fal nélkül



6600 M/589 Ft 537.700 1 066000589

6600 M/592

40 darab szerszámából álló készlet szerszámtartóval, fal nélkül



6600 M/592 Ft 593.500 1 066000592

6600 M/643

90 darabos szerszámkészlet akasztókkal, panel nélkül



6600 M/643 Ft 992.000 1 066000643

6600 M/650

28 darabos szerszámkészlet akasztókkal, panel nélkül



6600 M/650 Ft 1.212.100 1 066000650

6600 M/657

17 darabos szerszámkészlet akasztókkal, panel nélkül



6600 M/657 Ft 981.000 1 066000657

6600 M/658

14 darabos szerszámkészlet akasztókkal, panel nélkül

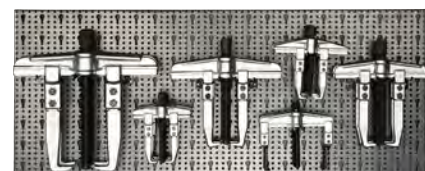

6600 M/658 Ft 1.098.600 1 066000658

6600 M/716

64 darabos szerszámkészlet akasztókkal, panel nélkül



6600 M/716 Ft 1.186.500 1 066000716



6600 M/811

53 darabszerszámból álló készlet
szerszámtartóval, fal nélkül



6600 M/811 Ft 451.800 1 066000811

6600 M/812

27 darab szerszámból álló készlet
szerszámtartóval, fal nélkül



6600 M/812 Ft 1.109.500 1 066000812

6600 M/813

31 darabos szerszámkészlet akasztókkal,
panel nélkül



6600 M/813 Ft 558.900 1 066000813



6600 M/842

36 darabos szerszámkészlet akasztókkal,
panel nélkül



6600 M/842 Ft 727.300 1 066000842

6600 M/14K

150 darab szerszámból álló készlet
szerszámtartóval, fal nélkül



6600 M/14K Ft 953.500 1 0660009014

6600 M/40K

93 darab szerszámból álló készlet
szerszámtartóval, fal nélkül



6600 M/40K Ft 1.070.400 1 0660009040

6600 M/217K

38 darab szerszámból álló készlet
szerszámtartóval, fal nélkül



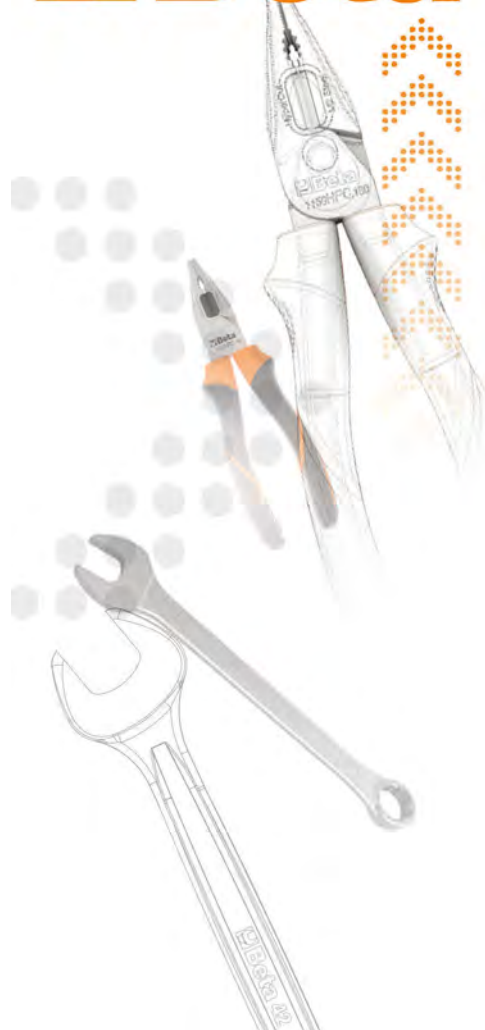

6600 M/217K Ft 660.400 1 0660009217



8600 R/11

374 darab kábelszerelvény akasztókkal, panel nélkül





	Ft		
8600 R/11	769.300	1	086000011

8600 R/12

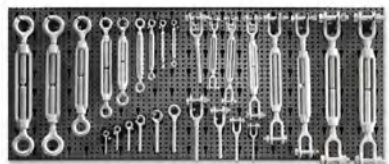
259 darab kábelszerelvény akasztókkal, panel nélkül



	Ft		
8600 R/12	750.800	1	086000012

8600 R/13

230 darab kábelszerelvény akasztókkal, panel nélkül



	Ft		
8600 R/13	636.000	1	086000013

8600 R/113

1862 darab kábelszerelvény akasztókkal, panel nélkül





	Ft		
8600 R/113	885.400	1	086000113

8600 R/114

1045 darab kábelszerelvény akasztókkal, panel nélkül





	Ft		
8600 R/114	873.700	1	086000114

8600 R/225

64 darab 8. BIZTONSÁGI FOKÚ szerelvény akasztókkal, panel nélkül





	Ft		
8600 R/225	595.500	1	086000225

8600 R/412

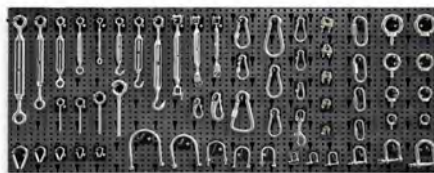
348 darab ROZSDAMENTES ACÉL kábelszerelvény akasztókkal, panel nélkül





	Ft		
8600 R/412	880.400	1	086000412



8600 R/511

11 darab oldalhegesztett lánc tekercs kiállító tálcával



	Ft		
8600 R/511	734.000	1	086000511

8600 R/601

50 darab racsnis rögzítőheveder polccal és akasztókkal, panel nélkül

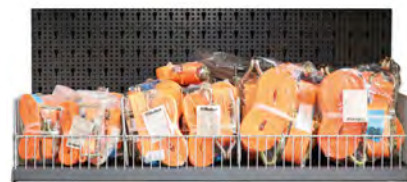

	Ft		
8600 R/601	503.300	1	086000601
C88/R601	142.900	1	088000160

8600 R/602

120 darab kábelszerelvény, polccal és akasztókkal, fal nélkül



	Ft		
8600 R/602	596.600	1	086000602

8600 R/611

52 darab emelőheveder polccal és akasztókkal, panel nélkül



	Ft		
8600 R/611	383.600	1	086000611
C88/R611	83.400	1	088000161



MUNKAVÉDELMI CIPŐK

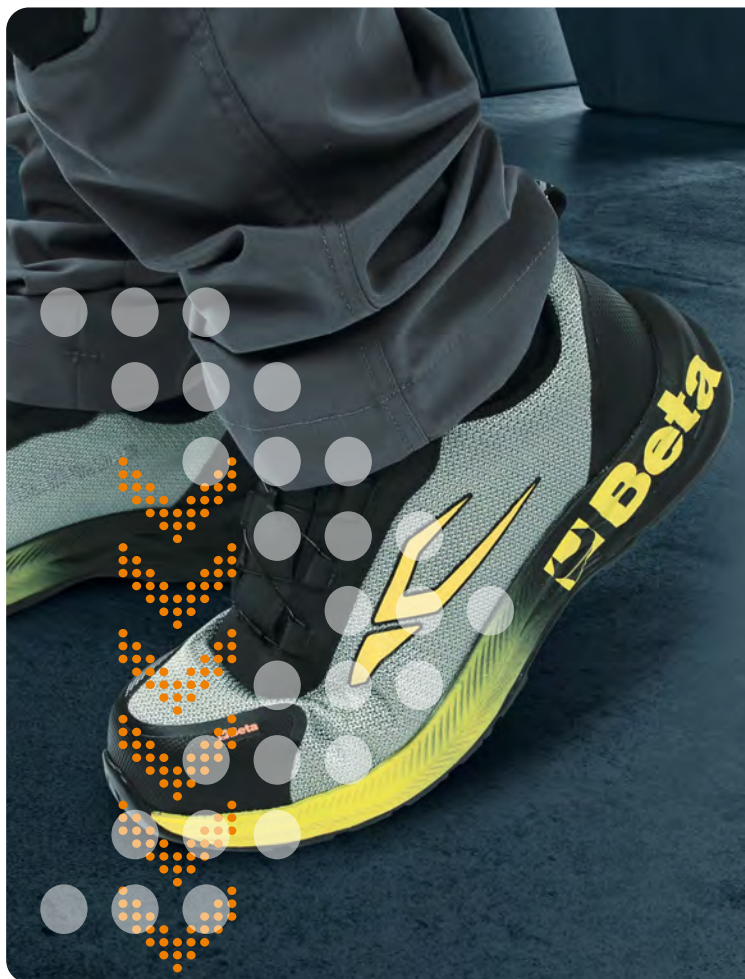

Áthatolásvédett középtalp



Orrvédővel



Antisztatikus lábbeli



Energiaelnyelő sarokrész



Olaj-, szénhidrogén és oldószerálló talp



Csúszásmentes talp



Hajlásállóság > 60.000



Kontakthőellenálló talp (300 °C/perc)



Fémmentes lábbeli, nem tartalmaz fémet



A lábbelit úgy terveztük, hogy a viselő testétől folyamatosan levezesse az elektrosztatikus töltést a földre



Széles fejrész (11) a maximális komfortért



Hideg (-20 °C) ellen szigetelt cipők

FIGYELMEZTETÉSEK

Használat előtt győződjön meg róla, hogy a cipő megfelel a felhasználási igényeknek, illetve a típusának és a munkahelynek megfelelő védelmi osztályba tartozik. A Beta Utensili által gyártott cipők kielégítik az érvényes EURÓPAI SZABVÁNYOK előírásait.

A munkáltató köteles megfelelő egyéni védőfelszerelést biztosítani az esetlegesen kockázatot jelentő munkakörnyezetben dolgozó munkavállalók számára (egyéni védőfelszerelés jellemzői és kategóriái).

ELAVULÁS

A cipők pontos tárolási ideje számos tényező miatt - úgymint a tárolás során uralkodó páratartalom és az anyagok idők során bekövetkező strukturális változásai - nem határozható meg pontosan. Általánosságban elmondható, hogy a tisztán poliuretánból készült vagy poliuretán talpú cipők maximális élettartama a gyártástól számítva három év. A kizárólag PVC anyagú cipők élettartama a gyártástól számított öt év, míg a bőr felsőrésszel és gumiból, hőképlékeny anyagból és EVA anyagú cipők élettartama a gyártástól számított tíz év. Az élettartam ellenőrzött körülmények között csomagolt és tárolt új lábbelikre vonatkozik, vagyis ahol a hőmérséklet és a relatív páratartalom nem változik meg hirtelen.

EURÓPAI SZABVÁNYOK ÉS MAGYARÁZATUK EN ISO 20345:2011 - EN ISO 20347:2012

MEGFELELÉS AZ EN ISO 20345:2011 SZABVÁNYNAK

Ez a nemzetközi szabvány alap és kiegészítő (választható) követelményeket ír elő az általános célú biztonsági lábbelikre.

Az EN ISO 20345:2011 szabványnak megfelelő lábbelik jelölése "S" (=Safety, azaz biztonsági), az orr részük 200 Joule energiájú behatásnak ellenáll.

MEGFELELÉS AZ EN ISO 20347:2012 SZABVÁNYNAK

Ez a nemzetközi szabvány alap és kiegészítő (választható) követelményeket ír elő azokra a munkalábbelikre, amelyek nincsenek kitéve semmilyen mechanikai kockázatnak (ütés vagy nyomás). Az EN ISO 20347:2012 szabványnak megfelelő lábbelik jelölése "O" (= Occupational, azaz munka). A tulajdonságaik a fenti lábbelikkal szinte teljesen megegyeznek azzal a különbséggel, hogy nem követelmény az orrvédő és az áthatolásvédett középtalp.

Az EN ISO 20345:2011 szerinti alapvető követelmények mellett a lábbelik kiegészítő követelményeknek is megfelehetnek, amit a lábbeli nyelvén található címkén kell szimbólummal vagy betűvel jelölni.

EURÓPAI SZABVÁNYOK ÉS MAGYARÁZATUK EN ISO 20345:2022 - EN ISO 20347:2022

MEGFELELÉS AZ EN ISO 20345:2022 SZABVÁNYNAK

Ez a nemzetközi szabvány alap és kiegészítő (választható) követelményeket ír elő az általános célú biztonsági lábbelikre.

Az EN ISO 20345:2022 szabványnak megfelelő lábbelik jelölése "S" (=Safety, azaz biztonsági), az orr részük 200 Joule energiájú behatásnak ellenáll.

MEGFELELÉS AZ EN ISO 20347:2022 SZABVÁNYNAK

Ez a nemzetközi szabvány alap és kiegészítő (választható) követelményeket ír elő azokra a munkalábbelikre, amelyek nincsenek kitéve semmilyen mechanikai kockázatnak (ütés vagy nyomás). Az EN ISO 20347:2022 szabványnak megfelelő lábbelik jelölése "O" (= Occupational, azaz munka). A tulajdonságaik a fenti lábbelikkal szinte teljesen megegyeznek azzal a különbséggel, hogy nem követelmény az orrvédő és az áthatolásvédett középtalp.

Az EN ISO 20345:2022 szerinti alapvető követelmények mellett a lábbelik kiegészítő követelményeknek is megfelehetnek, amit a lábbeli nyelvén található címkén kell szimbólummal vagy betűvel jelölni.

Tájékoztatás az átszúródásvédő betéttel ellátott lábbelikről

A cipő talpátszúródás elleni védelmét a laboratóriumunkban, szabványos szögekkel és hatóerővel teszteltük. A kisebb átmérőjű szögek, illetve a nagyobb statikus vagy dinamikus terhelés esetén nagyobb az átszúródás kockázata. Ilyen körülmények között további megelőző intézkedéseket is figyelembe kell venni. A munkavédelmi lábbelik jelenleg három különböző átszúródásvédő betéttel kaphatók. A fém vagy nem fém betétet a munka során előforduló kockázatok figyelembevételével kell kiválasztani. Mindhárom betét védelmet nyújt a talpátszúródás ellen, mindazonáltal megvannak a saját előnyeik vagy hátrányaik, így például:

- Talpátszúródás ellen védő fém betét: az átszúródással szembeni ellenállást kevésbé befolyásolja a hegyes tárgy formája (pl. átmérő, geometria, hegy), viszont a cipő gyártásához meghatározott méretkorlátok miatt a betét nem fedi le a teljes talprészt.
- Talpátszúródás ellen védő nem fém betét (PL): könnyű, rugalmas és a fémbetéhez képest nagyobb felületet fed le, de az átszúródás elleni védelem foka nagy mértékben függhet a hegyes tárgy formájától (pl. átmérő, geometria, hegy).
- Talpátszúródás ellen védő nem fém betét (PS): könnyű, rugalmas és a fémbetéhez képest nagyobb felületet fed le, de az átszúródás elleni védelem foka nagy mértékben függhet a hegyes tárgy formájától (pl. átmérő, geometria, hegy). A PS besorolású betétek a PL betéteknél nagyobb védelmet nyújtanak a kisebb átmérőjű tárgyak ellen.



OSZTÁLYOZÁS

- I. osztály: Bőrből vagy egyéb anyagból készült lábbeli a tisztán gumi és tisztán polimer kivételével.
- II. osztály: Tiszta gumi (vulkanizált) vagy tiszta polimer (fröccsöntött).

ALAPKÖVETELMÉNYEK

- **A teljes cipő:** felsőrész magassága; sarokrész; talprész szerkezeti teljesítménye (kialakítás és a felsőrész/talprész kötésének erőssége); lábujjvédelem és az orrvédő tulajdonságai (kivéve az EN ISO 20347 szabvány alá tartozó cipők); csúszásállóság.
- **Felsőréssz:** a felsőrész, bélés, nyelv, talpbetét/talpbélés tulajdonságai (szakitószilárdság, kopásállóság, nyúlási tulajdonságok, vízgőz átteresztőképesség, pH, talpbetét abszorpció és deszorpció).
- **Talp:** felépítés és szakitószilárdság, kopásállóság, hajtogatással szembeni ellenállás, hidrolízissel szembeni ellenállás, a rétegek közti kötés erőssége és a szénhidrogén olajoknak való ellenállás.

VÉDELMI OSZTÁLY	EN ISO 20345:2011				EN ISO 20347:2012				EN ISO 20345:2011		EN ISO 20347:2012		MINIMÁLIS KÖVETELMÉNYEK
	SB	S1	S2	S3	OB	O1	O2	O3	S4	S5	O4	O5	
Zárt kéregréz	0	X	X	X	0	X	X	X	X	X	X	X	
200 joule energiájú behatásnak ellenálló orrvédő	X	X	X	X	-	-	-	-	X	X	-	-	
A Antisztatikus lábbeli	0	X	X	X	0	X	X	X	X	X	X	X	Elektromos ellenállás >100 kΩ, ≤1000 MΩ
E Energiaelnyelő sarok	0	X	X	X	0	X	X	X	X	X	X	X	> 20 Joules
WRU Vízáteresztéssel szemben ellenálló felsőrész	0	-	X	X	0	-	X	X	-	-	-	-	Vízáteresztés: <0.2 g x 60 perc Vízfelvétel: <30% x 60 perc
P Talpátszűrődés elleni védelem	0	0	-	X	0	0	-	X	0	X	0	X	> 1100 N
CI Hideg elleni védelem	0	0	0	0	0	0	0	0	0	0	0	0	A talp belső felületének hőmérsékletváltozása: <10 °C
HI Hőszigetelt	0	0	0	0	0	0	0	0	0	0	0	0	A talp belső felületének hőmérsékletváltozása: <22° C
HRO Hőálló járótalp	0	0	0	0	0	0	0	0	0	0	0	0	Hőállóság max. 300°
WR Vízállóság	0	0	0	0	0	0	0	0	-	-	-	-	Vízfelvétel: < 3 cm ²
FO Fűtőolaj ellen védő járótalp	0	X	X	X	0	0	0	0	X	X	0	0	Járótalp volumennövekedés <12%
SRC Csúszásmentes járótalp	X	X	X	X	X	X	X	X					SRA + SRB követelmény

X	A védelmi osztályra kötelezően előírt követelmény
O	A kötelezően előírt követelmények melletti opcionális követelmény, amennyiben a jelölés tartalmazza
-	Nem kötelezően előírt követelmény, ellenőrizze a cipő jelölését

Antisztatikus lábbeli:

Antisztatikus lábbelit az elektrosztatikusság minimalizálása érdekében szükséges viselni ott, ahol meg kell előzni a gyúlékony anyagok és gőzök begyulladását, valamint a feszültség alatt álló alkatrészek okozta esetleges áramütést. Az antisztatikus lábbeli nem nyújt védelmet az áramütés ellen, mivel mindössze a padló és a viselő lába között hoz létre elektromos ellenállást. Amennyiben az áramütésveszély nem küszöbölhető ki teljesen, a munkahelyi balesetmegelőzésre vonatkozó tervekben további óvintézkedéseket szükséges tenni. Az antisztatikus követelmények teljesüléséhez a lábbelit tilos átalakítani.

Szigetelő lábbeli:

A szigetelő lábbelik védelmet nyújtanak a maximum 1000 V feszültség véletlen érintése esetén feltéve, hogy a felhasználási körülmények nem változnak, például a villamos ellenállás pára hatására nem változik. Felhívjuk a figyelmet, hogy a lábbeli villamos ellenállása nem a felsőrészre, hanem a talprészre vonatkozik.

Lábbelik villamos osztályai:

00 osztály 500V CA vagy 750V CC

0 osztály 1000V CA vagy 1500V CC

Disszipatív lábbeli EPA környezetbe:

A kifejezetten EPA (ESDS) környezetre tervezett disszipatív lábbelik lehetővé teszik, hogy a villamos töltés a viselő testétől folyamatos és kontrollált módon oszoljon szét, ezzel védve a villamos alkatrészeket és eszközöket az elektrosztatikus jelenségek ellen. A CEI EN 61340-5-1:2016 alapján a földelési ellenállás referenciaértéke a viselő/lábbeli/padló között <1 × 109 Ω.



OSZTÁLYOZÁS

- I. osztály: Bőrből vagy egyéb anyagból készült lábbeli a tisztán gumi és tisztán polimer kivételével.
- II. osztály: Tiszta gumi (vulkanizált) vagy tiszta polimer (fröccsöntött).

ALAPKÖVETELMÉNYEK

- **A teljes cipő:** felsőrész magassága; sarokrész; talprész szerkezeti teljesítménye (kialakítás és a felsőrész/talprész kötésének erőssége); lábujjvédelem és az orrvédő tulajdonságai (kivéve az EN ISO 20347 szabvány alá tartozó cipők); csúszásállóság.
- **Felsőréssz:** a felsőrész, bélés, nyelv, talpbetét/talpbélés tulajdonságai (szakítószilárdság, kopásállóság, nyúlási tulajdonságok, vízgőz átteresztőképesség, pH, talpbetét abszorpció és deszorpció).
- **Talp:** felépítés és szakítószilárdság, kopásállóság, hajtogatással szembeni ellenállás, hidrolízissel szembeni ellenállás, a rétegek közti kötés erőssége és a szénhidrogén olajoknak való ellenállás.

VÉDELMI OSZTÁLY	EN ISO 20345:2022											EN ISO 20347:2022					MINIMÁLIS KÖVETELMÉNYEK
	SB	S1	S2	S3	S3L	S3S	S6	S7	S7L	S7S	OB	O1	O2	O3	O3L	O3S	
Osztály	I o II	I	I	I	I	I	I	I	I	I	I o II	I	I	I	I	I	
Zárt sarokrész	0	X	X	X	X	X	X	X	X	X	0	X	X	X	X	X	
200 joule energiájú behatásnak ellenálló orrvédő	X	X	X	X	X	X	X	X	X	X	-	-	-	-	-	-	
Megerősített járótalp	0	0	0	X	X	X	0	X	X	X	0	0	0	X	X	X	
P Talpátszűrődés elleni védelem (P fém betét)	0	0	0	X	-	-	0	X	-	-	0	0	0	X	-	-	
PL Talpátszűrődés elleni védelem (nem fém betét, szöggel bevizsgálva, Ø 4,5 mm)	0	0	0	-	X	-	0	-	X	-	0	0	0	-	X	-	
PS Talpátszűrődés elleni védelem (nem fém betét, szöggel bevizsgálva, Ø 3,0 mm)	0	0	0	-	-	X	0	-	-	X	0	0	0	-	-	X	
A Antisztatikus lábbeli	0	X	X	X	X	X	X	X	X	X	0	X	X	X	X	X	
HI Hőszigetelt talpbetét	0	0	0	0	0	0	0	0	0	0	0	0	0	0	0	0	
CI Hideg ellen szigetelt talpbetét	0	0	0	0	0	0	0	0	0	0	0	0	0	0	0	0	
E Energiaelnyelő sarokrész	0	X	X	X	X	X	X	X	X	X	0	X	X	X	X	X	
WR Vízállóság	0	0	0	0	0	0	0	X	X	X	0	0	0	0	0	0	
SC Kopásálló orrmerevítő	0	0	0	0	0	0	0	0	0	0	0	0	0	0	0	0	
SR Glicerines kerámiapadlón csúszásálló	X	X	X	X	X	X	X	X	X	X	X	X	X	X	X	X	
WPA Vízáteresztéssel és vízfelvétellel szembeni ellenállás	0	0	X	X	X	X	-	-	-	-	0	0	X	X	X	X	
HRO Kontakthővel szemben ellenálló járótalp	0	0	0	0	0	0	0	0	0	0	0	0	0	0	0	0	
FO Szénhidrogéneknek való ellenállás	0	0	0	0	0	0	0	0	0	0	0	0	0	0	0	0	
LG Bordázott talp	0	0	0	0	0	0	0	0	0	0	0	0	0	0	0	0	

X	A védelmi osztályra kötelezően előírt követelmény
O	A kötelezően előírt követelmények melletti opcionális követelmény, amennyiben a jelölés tartalmazza
-	Nem kötelezően előírt követelmény, ellenőrizze a cipő jelölését

Részlegesen vezetőképes cipők

Részlegesen vezetőképes cipők viselete olyan helyzetekben ajánlott, amikor az elektrosztatikus töltést a lehető legrövidebb időn belül kell a minimumra csökkenteni, például robbanóanyagok mozgatása során.

Nem ajánlott vezetőképes cipőt viselni, amennyiben fennáll váltó- vagy egyenáramú villamos készülékekből vagy feszültség alatt lévő egységekből eredő áramütés veszélye. A lábbelik részleges elektromos vezetőképeségének biztosítása érdekében az új cipők maximális ellenállása 100 kΩ.

Antisztatikus lábbeli

Antisztatikus lábbelit az elektrosztatikusság minimalizálása érdekében szükséges viselni ott, ahol meg kell előzni a gyúlékony anyagok és gőzök begyulladását, valamint a feszültség alatt álló alkatrészek okozta esetleges áramütést. Az antisztatikus lábbeli nem nyújt védelmet az áramütés ellen, mivel mindössze a padló és a viselő lába között hoz létre elektromos ellenállást. Amennyiben az áramütésveszély nem küszöbölhető ki teljesen, a munkahelyi balesetmegelőzésre vonatkozó tervekben további óvintézkedéseket szükséges tenni. Az antisztatikus követelmények teljesüléséhez a lábbelit tilos átalakítani.

NB A szabvány korábbi változata szerint tanúsított cipők tanúsítványa annak érvényességéig marad hatályban.

EN ISO 20345:2011		S1P SR / S1PS SR										
LINIA	ARTYKUL	WYMAGANIA				SUGEROWANE SEKTORY						
		TOVÁBBI KÖVETELMÉNYEK				JÁRMŰIPAR	ÉPÍTŐIPAR	VILLAMOSSÁG	IPAR	SZOLGÁLTATÁS-LOGISZTIKA	FŰTÉS ÉS VÍVÉZETÉKSZERELÉS	
	7246NB	FO				X	X		X	X	X	631
	7247NB	FO				X	X		X	X	X	631
	7248NB	FO RS				X	X		X		X	632
	7270Y	FO ESD	X	X		X	X	X	X	X	X	643
	7271V	FO ESD	X	X		X	X	X	X	X	X	643
	7272V	FO ESD	X	X		X	X	X	X	X	X	644
	7340VA	HRO FO	X	X		X		X	X	X	X	645
	7340G	HRO FO	X	X		X		X	X	X	X	645
	7341V	HRO FO	X	X		X		X	X	X	X	646
	7341Y	HRO FO	X	X		X		X	X	X	X	646
	7371V	HRO FO ESD	X	X		X		X	X	X	X	642

EN ISO 20345:2011		S1P SRC										
LINIA	ARTYKUL	WYMAGANIA				SUGEROWANE SEKTORY						
	7212G	ESD		X		X		X	X	X	X	635
	7212B	ESD		X		X		X	X	X	X	634
	7213G	ESD		X		X		X	X	X	X	635
	7222PEK			X		X	X	X	X	X	X	633
	7223PEK			X		X	X	X	X	X	X	634
	7246E						X		X	X	X	629
	7316NB	ESD		X		X	X	X	X	X	X	637
	7316NG	ESD		X		X	X	X	X	X	X	637
	7317NA			X		X	X	X	X	X	X	637
	7352B	HRO		X		X		X	X	X	X	639
	7352G	HRO ESD	X	X		X		X	X	X	X	639
	7352LG	HRO				X		X	X	X	X	639
	7372B	HRO	X	X		X		X	X	X	X	642
	7376A	HRO	X	X		X		X	X	X	X	642

EN ISO 20347:2012		O2 SRC										
LINIA	ARTYKUL	WYMAGANIA				SUGEROWANE SEKTORY						
	7241NFT	FO				X		X			X	631
	7243NFT	FO RS				X		X			X	631

EN ISO 20347:2012		O1 / O2 SRC										
LINIA	ARTYKUL	WYMAGANIA				SUGEROWANE SEKTORY						
	7362B	FO HRO	X	X		X	X					641
	7363N	FO HRO	X	X		X	X					641

EN ISO 20345:2022		S3 SR / S3S SR												
LINIA	ARTYKUL	WYMAGANIA				SUGEROWANE SEKTORY								
		TOVÁBBI KÖVETELMÉNYEK				MEZŐGAZDASÁG	JÁRMŰIPAR	ÉPÜLET	IPAR	VILLAMOSSÁG	SZOLGÁLTATÁS-LOGISZTIKA	OLAJ- ÉS GÁZIPAR	FŰTÉS ÉS VÍVÉZETÉKSZERELÉS	
	7241NC	FO				X	X	X	X		X	X	630	
	7243NC	FO RS				X	X	X	X			X	631	
	7245NB	FO RS				X	X	X	X			X	638	
	7273G	FO ESD	X	X		X	X	X	X	X	X	X	644	
	7274G	FO ESD	X	X		X	X	X	X	X	X	X	644	
	7275N	FO ESD	X	X		X	X	X	X	X	X	X	644	
	7276N	FO ESD	X	X		X	X	X	X	X	X	X	645	
	7342N	HRO FO	X	X		X	X	X	X	X	X	X	646	
	7343N	HRO FO	X	X		X	X	X	X	X	X	X	646	

EN ISO 20345:2011		S3 SRC											
LINIA	ARTYKUL	WYMAGANIA				SUGEROWANE SEKTORY							
	7214FN			X		X	X	X	X	X	X	X	635
	7214G	ESD		X		X	X	X	X	X	X	X	636
	7215FN			X		X	X	X	X	X	X	X	636
	7218FN	RS		X		X	X	X	X	X	X	X	636
	7218G	RS ESD		X		X	X	X	X	X	X	X	636
	7220PEK			X		X	X	X	X	X	X	X	633
	7221PEK	RS		X		X	X	X	X	X	X	X	633
	7241EN					X	X	X	X	X	X	X	629
	7243EN	RS				X	X	X	X	X	X	X	629
	7293HM	HRO HI	X			X	X				X	X	647
	7294HM	HRO HI	X			X	X				X	X	647
	7294HMC	HRO HI CI WR	X			X	X				X	X	647
	7320NA			X		X	X	X	X	X	X	X	638
	7321NA	RS		X		X	X	X	X	X	X	X	638
	7322SA			X		X	X	X	X	X	X	X	638
	7323SA	RS		X		X	X	X	X	X	X	X	668
	7354N	HRO	X			X	X	X	X	X	X	X	640
	7356G	HRO	X			X	X	X	X	X	X	X	640
	7356V	HRO	X			X	X	X	X	X	X	X	640
	7356LN	HRO	X			X	X	X	X	X	X	X	640
	7357G	HRO	X			X	X	X	X	X	X	X	641
	7357V	HRO	X			X	X	X	X	X	X	X	641
	7381N	HRO WR	X	X		X	X	X	X	X	X	X	642
	7382N	HRO WR	X	X		X	X	X	X	X	X	X	643

EN ISO 20345:2011		S5 SRC											
LINIA	ARTYKUL	WYMAGANIA				SUGEROWANE SEKTORY							
	7328A					X	X	X			X	X	632
	7328N					X	X	X			X	X	632



7241EN

mérsékeltén vízálló bőrcipő

- Acél orrvédő
- Áthatlásvédett középtalp rugalmas acélból

**EN ISO
20345
2011**



EU	UK	mm	Ft		
35	2,5	230	16.000	1	072410835
36	3,5	237	16.000	1	072410836
37	4,5	244	16.000	1	072410837
38	5	250	16.000	1	072410838
39	6	257	16.000	1	072410839
40	6,5	264	16.000	1	072410840
41	7	270	16.000	1	072410841
42	8	277	16.000	1	072410842
43	9	284	16.000	1	072410843
44	10	290	16.000	1	072410844
45	10,5	297	16.000	1	072410845
46	11	304	16.000	1	072410846
47	12	310	16.000	1	072410847
48	13	317	16.000	1	072410848



CE

S3 SRC

7243EN

mérsékeltén vízálló bokacipő gyorskioldással

- Acél orrvédő
- Áthatlásvédett középtalp rugalmas acélból

**EN ISO
20345
2011**



EU	UK	mm	Ft		
35	2,5	230	17.000	1	072430835
36	3,5	237	17.000	1	072430836
37	4,5	244	17.000	1	072430837
38	5	250	17.000	1	072430838
39	6	257	17.000	1	072430839
40	6,5	264	17.000	1	072430840
41	7	270	17.000	1	072430841
42	8	277	17.000	1	072430842
43	9	284	17.000	1	072430843
44	10	290	17.000	1	072430844
45	10,5	297	17.000	1	072430845
46	11	304	17.000	1	072430846
47	12	310	17.000	1	072430847
48	13	317	17.000	1	072430848



CE

S3 RS SRC

7246E

perforált hasítottbőr félcipő

- Acél orrvédő
- Áthatlásvédett középtalp rugalmas acélból

**EN ISO
20345
2011**



EU	UK	mm	Ft		
35	2,5	230	17.000	1	072460435
36	3,5	237	17.000	1	072460436
37	4,5	244	17.000	1	072460437
38	5	250	17.000	1	072460438
39	6	257	17.000	1	072460439
40	6,5	264	17.000	1	072460440
41	7	270	17.000	1	072460441
42	8	277	17.000	1	072460442
43	9	284	17.000	1	072460443
44	10	290	17.000	1	072460444
45	10,5	297	17.000	1	072460445
46	11	304	17.000	1	072460446
47	12	310	17.000	1	072460447
48	13	317	17.000	1	072460448



CE

S1P SRC



7241NC

BASIC bőr munkavédelmi cipő, vízlepergető

- Acél orrvédő
- Áthatolásbiztos acélbetét

EU	UK	mm	Ft		
35	2,5	228	20.250	1	072411635
36	3,5	235	20.250	1	072411636
37	4,5	242	20.250	1	072411637
38	5	248	20.250	1	072411638
39	6	255	20.250	1	072411639
40	6,5	262	20.250	1	072411640
41	7	268	20.250	1	072411641
42	8	275	20.250	1	072411642
43	9	282	20.250	1	072411643
44	10	288	20.250	1	072411644
45	10,5	295	20.250	1	072411645
46	11	302	20.250	1	072411646
47	12	308	20.250	1	072411647
48	13	315	20.250	1	072411648



CE

S3 FO SR

EN ISO
20345
2022



7241NFT

BASIC bőr munkavédelmi cipő, vízlepergető

- Orrvédő nélkül
- Áthatolásbiztos betét nélkül

EU	UK	mm	Ft		
35	2,5	228	17.600	1	072410735
36	3,5	235	17.600	1	072410736
37	4,5	242	17.600	1	072410737
38	5	248	17.600	1	072410738
39	6	255	17.600	1	072410739
40	6,5	262	17.600	1	072410740
41	7	268	17.600	1	072410741
42	8	275	17.600	1	072410742
43	9	282	17.600	1	072410743
44	10	288	17.600	1	072410744
45	10,5	295	17.600	1	072410745
46	11	302	17.600	1	072410746
47	12	308	17.600	1	072410747
48	13	315	17.600	1	072410748



CE

O2 FO SR

EN ISO
20347
2022



7243NC

BASIC bőr munkavédelmi cipő, vízlepergető

- Acél orrvédő
- Áthatolásbiztos acélbetét

EU	UK	mm	Ft		
35	2,5	228	20.850	1	072431635
36	3,5	235	20.850	1	072431636
37	4,5	242	20.850	1	072431637
38	5	248	20.850	1	072431638
39	6	255	20.850	1	072431639
40	6,5	262	20.850	1	072431640
41	7	268	20.850	1	072431641
42	8	275	20.850	1	072431642
43	9	282	20.850	1	072431643
44	10	288	20.850	1	072431644
45	10,5	295	20.850	1	072431645
46	11	302	20.850	1	072431646
47	12	308	20.850	1	072431647
48	13	315	20.850	1	072431648



CE

S3 FO SR RS

EN ISO
20345
2022



7243NFT

BASIC bőr munkavédelmi cipő, vízlepergető

- Orrvédő nélkül
- Áthatolásbiztos betét nélkül

EU	UK	mm	Ft		
35	2,5	228	18.200	1	072430535
36	3,5	235	18.200	1	072430536
37	4,5	242	18.200	1	072430537
38	5	248	18.200	1	072430538
39	6	255	18.200	1	072430539
40	6,5	262	18.200	1	072430540
41	7	268	18.200	1	072430541
42	8	275	18.200	1	072430542
43	9	282	18.200	1	072430543
44	10	288	18.200	1	072430544
45	10,5	295	18.200	1	072430545
46	11	302	18.200	1	072430546
47	12	308	18.200	1	072430547
48	13	315	18.200	1	072430548



CE

O2 FO SR RS

EN ISO
20347
2022



7245NB

BASIC bőr munkavédelmi cipő, vízlepergető, első védőnyelvvel

- Acél orrvédő
- Áthatolásbiztos acélbetét

EU	UK	mm	Ft		
35	2,5	228	22.650	1	072451635
36	3,5	235	22.650	1	072451636
37	4,5	242	22.650	1	072451637
38	5	248	22.650	1	072451638
39	6	255	22.650	1	072451639
40	6,5	262	22.650	1	072451640
41	7	268	22.650	1	072451641
42	8	275	22.650	1	072451642
43	9	282	22.650	1	072451643
44	10	288	22.650	1	072451644
45	10,5	295	22.650	1	072451645
46	11	302	22.650	1	072451646
47	12	308	22.650	1	072451647
48	13	315	22.650	1	072451648



CE

S3 FO SR RS

EN ISO
20345
2022



7246NB

BASIC perforált hasítottbőr cipő

- Acél orrvédő
- Áthatolásbiztos acélbetét

EU	UK	mm	Ft		
35	2,5	228	19.650	1	072461635
36	3,5	235	19.650	1	072461636
37	4,5	242	19.650	1	072461637
38	5	248	19.650	1	072461638
39	6	255	19.650	1	072461639
40	6,5	262	19.650	1	072461640
41	7	268	19.650	1	072461641
42	8	275	19.650	1	072461642
43	9	282	19.650	1	072461643
44	10	288	19.650	1	072461644
45	10,5	295	19.650	1	072461645
46	11	302	19.650	1	072461646
47	12	308	19.650	1	072461647
48	13	315	19.650	1	072461648



CE

S1P FO SR

EN ISO
20345
2022



7247NB

BASIC bőr munkavédelmi szandál

- Acél orrvédő
- Áthatolásbiztos acélbetét

EU	UK	mm	Ft		
35	2,5	228	19.450	1	072470635
36	3,5	235	19.450	1	072470636
37	4,5	242	19.450	1	072470637
38	5	248	19.450	1	072470638
39	6	255	19.450	1	072470639
40	6,5	262	19.450	1	072470640
41	7	268	19.450	1	072470641
42	8	275	19.450	1	072470642
43	9	282	19.450	1	072470643
44	10	288	19.450	1	072470644
45	10,5	295	19.450	1	072470645
46	11	302	19.450	1	072470646
47	12	308	19.450	1	072470647
48	13	315	19.450	1	072470648



CE

S1P FO SR

EN ISO
20345
2022



7248NB

BASIC hasítottbőr cipő

- Acél orrvédő
- Áthatolásbiztos acélbetét

EU	UK	mm	Ft		
35	2,5	228	20.850	1	072481635
36	3,5	235	20.850	1	072481636
37	4,5	242	20.850	1	072481637
38	5	248	20.850	1	072481638
39	6	255	20.850	1	072481639
40	6,5	262	20.850	1	072481640
41	7	268	20.850	1	072481641
42	8	275	20.850	1	072481642
43	9	282	20.850	1	072481643
44	10	288	20.850	1	072481644
45	10,5	295	20.850	1	072481645
46	11	302	20.850	1	072481646
47	12	308	20.850	1	072481647
48	13	315	20.850	1	072481648

CE



S1P FO SR RS

EN ISO 20345 2022



7328A

„Top Visibility” nitril-PVC munkavédelmi csizma
Öntisztító, csúszásmentes járőfelület.

- Acél orrvédő
- Rugalmas, áthatolásvédett acél köztalp

EU	UK	mm	Ft		
38	5	253	17.600	1	073280638
39	6	260	17.600	1	073280639
40	6,5	267	17.600	1	073280640
41	7	273	17.600	1	073280641
42	8	280	17.600	1	073280642
43	9	287	17.600	1	073280643
44	10	293	17.600	1	073280644
45	10,5	300	17.600	1	073280645
46	11	307	17.600	1	073280646
47	12	313	17.600	1	073280647

CE



S5 SRC

EN ISO 20345 2011



7328N

nitril-PVC munkavédelmi csizma
Öntisztító, csúszásmentes járőfelület.

- Acél orrvédő
- Rugalmas, áthatolásvédett acél köztalp

EU	UK	mm	Ft		
38	5	253	17.600	1	073280838
39	6	260	17.600	1	073280839
40	6,5	267	17.600	1	073280840
41	7	273	17.600	1	073280841
42	8	280	17.600	1	073280842
43	9	287	17.600	1	073280843
44	10	293	17.600	1	073280844
45	10,5	300	17.600	1	073280845
46	11	307	17.600	1	073280846
47	12	313	17.600	1	073280847

CE



S5 SRC

EN ISO 20345 2011





7220PEK

mérsékeltén vízálló bőrcipő nylon betétekkel és kopásálló megerősítéssel az orr területén

- Orrvédő kompozit anyagból
- Áthatolásvédett középtalp kompozit szálból

EU	UK	mm	Ft	☞	☞
35	2,5	228	29.550	1	072200235
36	3,5	235	29.550	1	072200236
37	4,5	242	29.550	1	072200237
38	5	248	29.550	1	072200238
39	6	255	29.550	1	072200239
40	6,5	262	29.550	1	072200240
41	7	268	29.550	1	072200241
42	8	275	29.550	1	072200242
43	9	282	29.550	1	072200243
44	10	288	29.550	1	072200244
45	10,5	295	29.550	1	072200245
46	11	302	29.550	1	072200246
47	12	308	29.550	1	072200247
48	13	315	29.550	1	072200248

A KÉSZLET EREJÉIG!



CE

S3 SRC

EN ISO 20345 2011

METAL FREE



7221PEK

mérsékeltén vízálló bőr bokacipő nylon betétekkel kopásálló erősítéssel az orr területén, és gyorskioldással

- Orrvédő kompozit anyagból
- Áthatolásvédett középtalp kompozit szálból

EU	UK	mm	Ft	☞	☞
35	2,5	228	30.950	1	072210235
36	3,5	235	30.950	1	072210236
37	4,5	242	30.950	1	072210237
38	5	248	30.950	1	072210238
39	6	255	30.950	1	072210239
40	6,5	262	30.950	1	072210240
41	7	268	30.950	1	072210241
42	8	275	30.950	1	072210242
43	9	282	30.950	1	072210243
44	10	288	30.950	1	072210244
45	10,5	295	30.950	1	072210245
46	11	302	30.950	1	072210246
47	12	308	30.950	1	072210247
48	13	315	30.950	1	072210248

A KÉSZLET EREJÉIG!



CE

S3 RS SRC

EN ISO 20345 2011

METAL FREE



7222PEK

perforált hasítottbőr cipő, jól szellőző mesh betétekkel

- Kompozit orr rész
- Kompozitszálás, áthatolásvédett köztalp

EU	UK	mm	Ft	☞	☞
35	2,5	228	28.550	1	072220135
36	3,5	235	28.550	1	072220136
37	4,5	242	28.550	1	072220137
38	5	248	28.550	1	072220138
39	6	255	28.550	1	072220139
40	6,5	262	28.550	1	072220140
41	7	268	28.550	1	072220141
42	8	275	28.550	1	072220142
43	9	282	28.550	1	072220143
44	10	288	28.550	1	072220144
45	10,5	295	28.550	1	072220145
46	11	302	28.550	1	072220146
47	12	308	28.550	1	072220147
48	13	315	28.550	1	072220148

A KÉSZLET EREJÉIG!



CE

S1P SRC

EN ISO 20345 2011

METAL FREE



7223PEK

hasítottbőr cipő jól szellőző mesh betétekkel és kopásálló megerősítéssel az orr területén

- Orrvédő kompozit anyagból
- Áthatolásvédett középtalp kompozit szálból

A KÉSZLET EREJÉIG!

EU	UK	mm	Ft	☞	☞
35	2,5	228	30.750	1	072230135
36	3,5	235	30.750	1	072230136
37	4,5	242	30.750	1	072230137
38	5	248	30.750	1	072230138
39	6	255	30.750	1	072230139
40	6,5	262	30.750	1	072230140
41	7	268	30.750	1	072230141
42	8	275	30.750	1	072230142
43	9	282	30.750	1	072230143
44	10	288	30.750	1	072230144
45	10,5	295	30.750	1	072230145
46	11	302	30.750	1	072230146
47	12	308	30.750	1	072230147
48	13	315	30.750	1	072230148

CE



S1P SRC

EN ISO
20345
2011

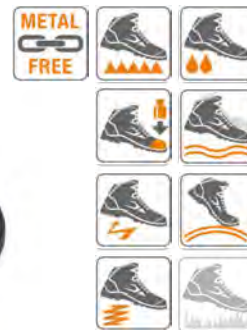

FLEX



7212B

Perforált hasítottbőr cipő, mesh betéttel, Kopásgátló betét az orr részen Rendkívül rugalmas és könnyű - a 42-es méret körülbelüli súlya: 490g Nem javasolt nagy igénybevételt jelentő használatra (építőipar, mezőgazdaság, nehézipar)

- Kompozit orrvédő
- Kompozitszálás, áthatolásbiztos betét

A KÉSZLET EREJÉIG!

EU	UK	mm	Ft	☞	☞
35	2,5	228	33.000	1	072120235
36	3,5	235	33.000	1	072120236
37	4,5	242	33.000	1	072120237
38	5	248	33.000	1	072120238
39	6	255	33.000	1	072120239
40	6,5	262	33.000	1	072120240
41	7	268	33.000	1	072120241
42	8	275	33.000	1	072120242
43	9	282	33.000	1	072120243
44	10	288	33.000	1	072120244
45	10,5	295	33.000	1	072120245
46	11	302	33.000	1	072120246
47	12	308	33.000	1	072120247
48	13	315	33.000	1	072120248

CE



S1P SRC ESD

EN ISO
20345
2011



 **Beta**

72126

perforált hasítottbőr cipő. Kopásgátló betét az orr részen. Rendkívül rugalmas és könnyű - a 42-es méret körülbelüli súlya: 490 g Nem javasolt nagy igénybevételt jelentő munkákhoz (építőipar, mezőgazdaság, nehézipar)

- Kompozit orrvédő
- Kompozitszál, áthatolásvédekt köztalp

EU	UK	mm	Ft		
35	2,5	228	33.000	1	072120335
36	3,5	235	33.000	1	072120336
37	4,5	242	33.000	1	072120337
38	5	248	33.000	1	072120338
39	6	255	33.000	1	072120339
40	6,5	262	33.000	1	072120340
41	7	268	33.000	1	072120341
42	8	275	33.000	1	072120342
43	9	282	33.000	1	072120343
44	10	288	33.000	1	072120344
45	10,5	295	33.000	1	072120345
46	11	302	33.000	1	072120346
47	12	308	33.000	1	072120347
48	13	315	33.000	1	072120348

A KÉSZLET EREJÉIG!



CE

S1P SRC ESD

72136

perforált hasítottbőr cipő, jól szellőző mesh betétekkel Rendkívül rugalmas és könnyű - a 42-es méret körülbelüli súlya: 490g Nem javasolt nagy igénybevételt jelentő munkákhoz (építőipar, mezőgazdaság, nehézipar)

- Kompozit orrvédő
- Kompozitszál, áthatolásbiztos betét

EU	UK	mm	Ft		
35	2,5	228	33.000	1	072130135
36	3,5	235	33.000	1	072130136
37	4,5	242	33.000	1	072130137
38	5	248	33.000	1	072130138
39	6	255	33.000	1	072130139
40	6,5	262	33.000	1	072130140
41	7	268	33.000	1	072130141
42	8	275	33.000	1	072130142
43	9	282	33.000	1	072130143
44	10	288	33.000	1	072130144
45	10,5	295	33.000	1	072130145
46	11	302	33.000	1	072130146
47	12	308	33.000	1	072130147
48	13	315	33.000	1	072130148

A KÉSZLET EREJÉIG!



CE

S1P SRC ESD

7214FN

action nabuk bőr cipő, mérsékelten vízálló kopásálló orrvédő betéttel Rendkívül rugalmas és könnyű - a 42 méret körülbelüli súlya: 500 g Nem javasolt nehéz igénybevételhez (építőipar, mezőgazdaság, nehézipar)

- Orrvédő kompozit anyagból
- Áthatolásvédekt középtalp kompozit szálból

EU	UK	mm	Ft		
35	2,5	228	35.600	1	072140035
36	3,5	235	35.600	1	072140036
37	4,5	242	35.600	1	072140037
38	5	248	35.600	1	072140038
39	6	255	35.600	1	072140039
40	6,5	262	35.600	1	072140040
41	7	268	35.600	1	072140041
42	8	275	35.600	1	072140042
43	9	282	35.600	1	072140043
44	10	288	35.600	1	072140044
45	10,5	295	35.600	1	072140045
46	11	302	35.600	1	072140046
47	12	308	35.600	1	072140047
48	13	315	35.600	1	072140048

A KÉSZLET EREJÉIG!



CE

S3 SRC

 **Beta**

72146

Action vízálló nubuk cipő kopásálló betéttel az orr részen
Rendkívül rugalmas és könnyű - a 42-es méret körülbelüli súlya:
500g Nem javasolt nagy igénybevételt jelentő munkákhoz (építőipar,
mezőgazdaság, nehézipar)

EU	UK	mm	Ft		
35	2,5	228	35.600	1	072140235
36	3,5	235	35.600	1	072140236
37	4,5	242	35.600	1	072140237
38	5	248	35.600	1	072140238
39	6	255	35.600	1	072140239
40	6,5	262	35.600	1	072140240
41	7	268	35.600	1	072140241
42	8	275	35.600	1	072140242
43	9	282	35.600	1	072140243
44	10	288	35.600	1	072140244
45	10,5	295	35.600	1	072140245
46	11	302	35.600	1	072140246
47	12	308	35.600	1	072140247
48	13	315	35.600	1	072140248

- Kompozit orrvédő
- Kompozitszálas, áthatolásbiztos betét

A KÉSZLET EREJÉIG!



CE

S3 SRC ESD



EN ISO
20345
2011



7215FN

action nubuk bőr mokasszin, mérsékelten vízálló
kopásálló orrvédő betéttel Rendkívül rugalmas és könnyű - a 42
méret körülbelüli súlya: 490 g Nem javasolt nehéz igénybevételhez
(építőipar, mezőgazdaság, nehézipar)

EU	UK	mm	Ft		
35	2,5	228	36.050	1	072150135
36	3,5	235	36.050	1	072150136
37	4,5	242	36.050	1	072150137
38	5	248	36.050	1	072150138
39	6	255	36.050	1	072150139
40	6,5	262	36.050	1	072150140
41	7	268	36.050	1	072150141
42	8	275	36.050	1	072150142
43	9	282	36.050	1	072150143
44	10	288	36.050	1	072150144
45	10,5	295	36.050	1	072150145
46	11	302	36.050	1	072150146
47	12	308	36.050	1	072150147
48	13	315	36.050	1	072150148

- Orrvédő kompozit anyagból
- Áthatolásvédett középtalp kompozit szálból

A KÉSZLET EREJÉIG!



CE

S3 SRC



EN ISO
20345
2011



7218FN

action nubuk bőr bokacipő, mérsékelten vízálló kopásálló orrvédő
betéttel és gyorskioldással Rendkívül rugalmas és könnyű - a 42
méret körülbelüli súlya: 510 g Nem javasolt nehéz igénybevételhez
(építőipar, mezőgazdaság, nehézipar)

EU	UK	mm	Ft		
35	2,5	228	37.250	1	072180035
36	3,5	235	37.250	1	072180036
37	4,5	242	37.250	1	072180037
38	5	248	37.250	1	072180038
39	6	255	37.250	1	072180039
40	6,5	262	37.250	1	072180040
41	7	268	37.250	1	072180041
42	8	275	37.250	1	072180042
43	9	282	37.250	1	072180043
44	10	288	37.250	1	072180044
45	10,5	295	37.250	1	072180045
46	11	302	37.250	1	072180046
47	12	308	37.250	1	072180047
48	13	315	37.250	1	072180048

- Orrvédő kompozit anyagból
- Áthatolásvédett középtalp kompozit szálból

A KÉSZLET EREJÉIG!



CE

S3 RS SRC



EN ISO
20345
2011



7218G

Action vízálló nubuk bokacipő kopásálló betéttel az orr részen és
gyorskioldással Rendkívül rugalmas és könnyű - a 42-es méret
körülbelüli súlya: 550g Nem javasolt nagy igénybevételt jelentő
munkákhoz (építőipar, mezőgazdaság, nehézipar)

EU	UK	mm	Ft		
35	2,5	228	37.250	1	072180135
36	3,5	235	37.250	1	072180136
37	4,5	242	37.250	1	072180137
38	5	248	37.250	1	072180138
39	6	255	37.250	1	072180139
40	6,5	262	37.250	1	072180140
41	7	268	37.250	1	072180141
42	8	275	37.250	1	072180142
43	9	282	37.250	1	072180143
44	10	288	37.250	1	072180144
45	10,5	295	37.250	1	072180145
46	11	302	37.250	1	072180146
47	12	308	37.250	1	072180147
48	13	315	37.250	1	072180148

- Kompozit orrvédő
- Kompozitszálas, áthatolásbiztos betét

A KÉSZLET EREJÉIG!



CE

S3 RS SRC ESD



EN ISO
20345
2011





7316NB

jól szellőző hálós hasítottbőr cipő,
a sarok stabilitását segítő alátámasztással

- Kompozit orrvédő
- Kompozitszál, áthatolásbiztos betét

EU	UK	mm	Ft	♂	♀
35	2,5	228	39.250	1	073160735
36	3,5	235	39.250	1	073160736
37	4,5	242	39.250	1	073160737
38	5	248	39.250	1	073160738
39	6	255	39.250	1	073160739
40	6,5	262	39.250	1	073160740
41	7	268	39.250	1	073160741
42	8	275	39.250	1	073160742
43	9	282	39.250	1	073160743
44	10	288	39.250	1	073160744
45	10,5	295	39.250	1	073160745
46	11	302	39.250	1	073160746
47	12	308	39.250	1	073160747
48	13	315	39.250	1	073160748

CE



S1P SRC ESD

7316NG

jól szellőző hálós hasítottbőr cipő,
a sarok stabilitását segítő alátámasztással

- Kompozit orrvédő
- Kompozitszál, áthatolásbiztos betét

EU	UK	mm	Ft	♂	♀
35	2,5	228	39.250	1	073160635
36	3,5	235	39.250	1	073160636
37	4,5	242	39.250	1	073160637
38	5	248	39.250	1	073160638
39	6	255	39.250	1	073160639
40	6,5	262	39.250	1	073160640
41	7	268	39.250	1	073160641
42	8	275	39.250	1	073160642
43	9	282	39.250	1	073160643
44	10	288	39.250	1	073160644
45	10,5	295	39.250	1	073160645
46	11	302	39.250	1	073160646
47	12	308	39.250	1	073160647
48	13	315	39.250	1	073160648

CE



S1P SRC ESD

7317NA

perforált hasítottbőr cipő,
a sarokrésznél mikroszál erősítéssel

- Kompozit orrvédő
- Áthatolásvédett középtalp kompozit szálból

EU	UK	mm	Ft	♂	♀
35	2,5	228	33.600	1	073170135
36	3,5	235	33.600	1	073170136
37	4,5	242	33.600	1	073170137
38	5	248	33.600	1	073170138
39	6	255	33.600	1	073170139
40	6,5	262	33.600	1	073170140
41	7	268	33.600	1	073170141
42	8	275	33.600	1	073170142
43	9	282	33.600	1	073170143
44	10	288	33.600	1	073170144
45	10,5	295	33.600	1	073170145
46	11	302	33.600	1	073170146
47	12	308	33.600	1	073170147
48	13	315	33.600	1	073170148

CE



S1P SRC

7320NA

Mikroszálás cipő, vízlepergető, kopásgátló erősítéssel az orr részen és sarok stabilitását segítő alátámasztással

- Kompozit orrvédő
- Áthatolásbiztos betét kompozit szálból

EU	UK	mm	Ft		
35	2,5	228	35.400	1	073200535
36	3,5	235	35.400	1	073200536
37	4,5	242	35.400	1	073200537
38	5	248	35.400	1	073200538
39	6	255	35.400	1	073200539
40	6,5	262	35.400	1	073200540
41	7	268	35.400	1	073200541
42	8	275	35.400	1	073200542
43	9	282	35.400	1	073200543
44	10	288	35.400	1	073200544
45	10,5	295	35.400	1	073200545
46	11	302	35.400	1	073200546
47	12	308	35.400	1	073200547
48	13	315	35.400	1	073200548

CE



S3 SRC

EN ISO
20345
2011

METAL
FREE



7321NA

Mikroszálás bokacipő, vízlepergető, gyorskioldással, kopásgátló erősítéssel az orr részen és sarok stabilitását segítő alátámasztással

- Kompozit orrvédő
- Áthatolásbiztos betét kompozit szálból

EU	UK	mm	Ft		
35	2,5	228	36.450	1	073210535
36	3,5	235	36.450	1	073210536
37	4,5	242	36.450	1	073210537
38	5	248	36.450	1	073210538
39	6	255	36.450	1	073210539
40	6,5	262	36.450	1	073210540
41	7	268	36.450	1	073210541
42	8	275	36.450	1	073210542
43	9	282	36.450	1	073210543
44	10	288	36.450	1	073210544
45	10,5	295	36.450	1	073210545
46	11	306	36.450	1	073210546
47	12	308	36.450	1	073210547
48	13	315	36.450	1	073210548

CE



S3 RS SRC

EN ISO
20345
2011

METAL
FREE



7322SA

magas kopásállóságú szövetcipő, sarok stabilitását segítő alátámasztás

- Kompozit orr rész
- Kompozitszál, áthatolásvédett köztalp

EU	UK	mm	Ft		
35	2,5	228	38.250	1	073220435
36	3,5	235	38.250	1	073220436
37	4,5	242	38.250	1	073220437
38	5	248	38.250	1	073220438
39	6	255	38.250	1	073220439
40	6,5	262	38.250	1	073220440
41	7	268	38.250	1	073220441
42	8	275	38.250	1	073220442
43	9	282	38.250	1	073220443
44	10	288	38.250	1	073220444
45	10,5	295	38.250	1	073220445
46	11	302	38.250	1	073220446
47	12	308	38.250	1	073220447
48	13	315	38.250	1	073220448

CE



S3 SRC

EN ISO
20345
2011

METAL
FREE



7323SA

magas kopásállóságú szövet bokacipő, gyorskioldással és sarok stabilitását segítő alátámasztással

- Kompozit orr rész
- Kompozitszál, áthatolásvédett köztalp

EU	UK	mm	Ft		
35	2,5	228	39.450	1	073230435
36	3,5	235	39.450	1	073230436
37	4,5	242	39.450	1	073230437
38	5	248	39.450	1	073230438
39	6	255	39.450	1	073230439
40	6,5	262	39.450	1	073230440
41	7	268	39.450	1	073230441
42	8	275	39.450	1	073230442
43	9	282	39.450	1	073230443
44	10	288	39.450	1	073230444
45	10,5	295	39.450	1	073230445
46	11	302	39.450	1	073230446
47	12	308	39.450	1	073230447
48	13	315	39.450	1	073230448

CE



S3 RS SRC

EN ISO
20345
2011

METAL
FREE





7352B

jól szellőző mesh szövet cipő TPU betétekkel
A sarok stabilitását segítő alátámasztás, elasztikus bebujós szár és EVA talprész nagy ellenállású nitril gumitalppal

- Orrvédő kompozit anyagból
- Áthatolásvédett középtalp kompozit szálból
- KIEMELKEDŐEN KÖNNYŰ: 42-es méret súlya kb.: 450 g

**EN ISO
20345
2011**

EU	UK	mm	Ft	W	CS
38	5	254	58.700	1	073520138
39	6	261	58.700	1	073520139
40	6,5	268	58.700	1	073520140
41	7	274	58.700	1	073520141
42	8	281	58.700	1	073520142
43	9	288	58.700	1	073520143
44	10	294	58.700	1	073520144
45	10,5	301	58.700	1	073520145
46	11	308	58.700	1	073520146
47	12	314	58.700	1	073520147
48	13	321	58.700	1	073520148



CE

S1P HRO SRC

METAL
FREE



7352G

jól szellőző mesh szövet cipő TPU betétekkel
Sarok stabilitását segítő alátámasztás, hagyományos fűzés, szélesített kivitel.
EVA talprész nagy ellenállású nitril gumitalppal

- Kompozit orr rész
- Kompozitszálás, áthatolásvédett köztalp
- RENDKÍVÜL KÖNNYŰ - a 42-es méret körülbelüli súlya: 450 gramm

**EN ISO
20345
2011**

EU	UK	mm	Ft	W	CS
38	5	254	60.700	1	073520338
39	6	261	60.700	1	073520339
40	6,5	268	60.700	1	073520340
41	7	274	60.700	1	073520341
42	8	281	60.700	1	073520342
43	9	288	60.700	1	073520343
44	10	294	60.700	1	073520344
45	10,5	301	60.700	1	073520345
46	11	308	60.700	1	073520346
47	12	314	60.700	1	073520347
48	13	321	60.700	1	073520348



CE

S1P HRO SRC ESD



METAL
FREE



7352LG

jól szellőző női mesh szövet cipő TPU betétekkel
Jól láthatóságot biztosító fényvisszaverő mesh felsőrész
Sarok stabilitását segítő alátámasztás, elasztikus bebujós szár és EVA talprész nagy ellenállású nitril gumitalppal

- Üvegszál orr rész
- Kompozitszálás, áthatolásvédett köztalp
- RENDKÍVÜL KÖNNYŰ - a 38-es méret körülbelüli súlya: 390 gramm

**EN ISO
20345
2011**

EU	UK	mm	Ft	W	CS
34	2	228	60.500	1	073520234
35	2,5	234	60.500	1	073520235
36	3,5	241	60.500	1	073520236
37	4,5	248	60.500	1	073520237
38	5	254	60.500	1	073520238
39	6	261	60.500	1	073520239
40	6,5	268	60.500	1	073520240
41	7	274	60.500	1	073520241
42	8	281	60.500	1	073520242



CE

S1P HRO SRC

METAL
FREE



7354N

vízálló mesh szövet cipő TPU betétekkel
A sarok stabilitását segítő alátámasztás, elasztikus bebújós szár és EVA talprész nagy ellenállású nitril gumitalppal

- Orrvédő kompozit anyagból
- Áthatolásvédett középtalp kompozit szálból
- RENDKÍVÜL KÖNNYŰ: a 42-es méret körülbelüli súlya 460 g

**EN ISO
20345
2011**

EU	UK	mm	Ft		
38	5	254	60.500	1	073540038
39	6	261	60.500	1	073540039
40	6,5	268	60.500	1	073540040
41	7	274	60.500	1	073540041
42	8	281	60.500	1	073540042
43	9	288	60.500	1	073540043
44	10	294	60.500	1	073540044
45	10,5	301	60.500	1	073540045
46	11	308	60.500	1	073540046
47	12	314	60.500	1	073540047
48	13	321	60.500	1	073540048



METAL
FREE



CE

S3 HRO SRC

7356G

vízálló mikroszálás cipő TPU betéttel
Sarok stabilitását segítő alátámasztás, elasztikus bebújós szár és EVA talprész nagy ellenállású nitril gumitalppal

- Kompozit orr rész
- Kompozitszálás, áthatolásvédett köztalp
- RENDKÍVÜL KÖNNYŰ - a 42-es méret körülbelüli súlya: 460 gramm

**EN ISO
20345
2011**

EU	UK	mm	Ft		
38	5	254	62.550	1	073560038
39	6	261	62.550	1	073560039
40	6,5	268	62.550	1	073560040
41	7	274	62.550	1	073560041
42	8	281	62.550	1	073560042
43	9	288	62.550	1	073560043
44	10	294	62.550	1	073560044
45	10,5	301	62.550	1	073560045
46	11	308	62.550	1	073560046
47	12	314	62.550	1	073560047
48	13	321	62.550	1	073560048



METAL
FREE



CE

S3 HRO SRC

7356V

vízálló mikroszálás cipő TPU betéttel
Sarok stabilitását segítő alátámasztás, elasztikus bebújós szár és EVA talprész nagy ellenállású nitril gumitalppal

- Kompozit orr rész
 - Kompozitszálás, áthatolásvédett köztalp
 - RENDKÍVÜL KÖNNYŰ - a 42-es méret körülbelüli súlya: 460 gramm
- A KÉSZLET EREJÉIG!**

**EN ISO
20345
2011**

EU	UK	mm	Ft		
38	5	254	62.550	1	073560138
39	6	261	62.550	1	073560139
40	6,5	268	62.550	1	073560140
41	7	274	62.550	1	073560141
42	8	281	62.550	1	073560142
43	9	288	62.550	1	073560143
44	10	294	62.550	1	073560144
45	10,5	301	62.550	1	073560145
46	11	308	62.550	1	073560146
47	12	314	62.550	1	073560147
48	13	321	62.550	1	073560148



METAL
FREE



CE

S3 HRO SRC

7356LN

vízálló mikroszálás női cipő TPU betéttel
Sarok stabilitását segítő alátámasztás, elasztikus bebújós szár és EVA talprész nagy ellenállású nitril gumitalppal

- Üvegszál orr rész
- Kompozitszálás, áthatolásvédett köztalp
- RENDKÍVÜL KÖNNYŰ - a 38-es méret körülbelüli súlya: 400 gramm

**EN ISO
20345
2011**

EU	UK	mm	Ft		
34	2	228	62.150	1	073560234
35	2,5	234	62.150	1	073560235
36	3,5	241	62.150	1	073560236
37	4,5	248	62.150	1	073560237
38	5	254	62.150	1	073560238
39	6	261	62.150	1	073560239
40	6,5	268	62.150	1	073560240
41	7	274	62.150	1	073560241
42	8	281	62.150	1	073560242



METAL
FREE



CE

S3 HRO SRC

7357G

vízálló mikroszálás bokacipő TPU betéttel

Sarok stabilitását segítő alátámasztás, elasztikus bebújós szár és EVA talprész nagy ellenállású nitril gumitalppal

- Kompozit orr rész
- Kompozitszálás, áthatolásvédett köztalp
- RENDKÍVÜL KÖNNYŰ - a 42-es méret körülbelüli súlya: 480 gramm

EN ISO 20345 2011

EU	UK	mm	Ft	cs	lap
38	5	254	69.250	1	073570038
39	6	261	69.250	1	073570039
40	6,5	268	69.250	1	073570040
41	7	274	69.250	1	073570041
42	8	281	69.250	1	073570042
43	9	288	69.250	1	073570043
44	10	294	69.250	1	073570044
45	10,5	301	69.250	1	073570045
46	11	308	69.250	1	073570046
47	12	314	69.250	1	073570047
48	13	321	69.250	1	073570048

CE



S3 HRO SRC

METAL FREE



7357V

Vízálló mikroszálás bokacipő TPU betéttel

Sarok stabilitását segítő alátámasztás, elasztikus bebújós szár és EVA talprész nagy ellenállású nitril gumitalppal

- Kompozit orr rész
- Kompozitszálás, áthatolásvédett köztalp
- RENDKÍVÜL KÖNNYŰ - a 42-es méret körülbelüli súlya: 480 gramm

EN ISO 20345 2011

EU	UK	mm	Ft	cs	lap
38	5	254	69.250	1	073570138
39	6	261	69.250	1	073570139
40	6,5	268	69.250	1	073570140
41	7	274	69.250	1	073570141
42	8	281	69.250	1	073570142
43	9	288	69.250	1	073570143
44	10	294	69.250	1	073570144
45	10,5	301	69.250	1	073570145
46	11	308	69.250	1	073570146
47	12	314	69.250	1	073570147
48	13	321	69.250	1	073570148

CE



A KÉSZLET EREJÉIG!

S3 HRO SRC

METAL FREE



7362B

jól szellőző mesh szövet munkacipő TPU betétekkel

Sarok stabilitását segítő alátámasztás, elasztikus bebújós szár és EVA talprész nagy ellenállású nitril gumitalppal

- Orrvédő nélkül
- Átszűrődás ellen védő köztalp nélkül
- RENDKÍVÜL KÖNNYŰ - a 42-es méret körülbelüli súlya: 330 gramm

EN ISO 20347 2012

EU	UK	mm	Ft	cs	lap
39	6	261	53.250	1	073620039
40	6,5	268	53.250	1	073620040
41	7	274	53.250	1	073620041
42	8	281	53.250	1	073620042
43	9	288	53.250	1	073620043
44	10	294	53.250	1	073620044
45	10,5	301	53.250	1	073620045
46	11	308	53.250	1	073620046
47	12	314	53.250	1	073620047
48	13	321	53.250	1	073620048

CE



A KÉSZLET EREJÉIG!

01 FO HRO SRC

METAL FREE



7363N

vízálló mesh szövet munkacipő TPU betétekkel

Sarok stabilitását segítő alátámasztás, elasztikus bebújós szár és EVA talprész nagy ellenállású nitril gumitalppal

- Orrvédő nélkül
- Átszűrődás ellen védő köztalp nélkül
- RENDKÍVÜL KÖNNYŰ - a 42-es méret körülbelüli súlya: 330 gramm

EN ISO 20347 2012

EU	UK	mm	Ft	cs	lap
39	6	261	55.450	1	073630039
40	6,5	268	55.450	1	073630040
41	7	274	55.450	1	073630041
42	8	281	55.450	1	073630042
43	9	288	55.450	1	073630043
44	10	294	55.450	1	073630044
45	10,5	301	55.450	1	073630045
46	11	308	55.450	1	073630046
47	12	314	55.450	1	073630047
48	13	321	55.450	1	073630048

CE



02 FO HRO SRC

METAL FREE



7371V

Kiválóan szellőző mesh szövettel.

Sarok stabilitást segítő alátámasztás, hagyományos fűzés, szélesített kivitel.

EVA középtalp és nagy ellenállású nitril gumitalp.

- Orrvédő kompozit anyagból
- Áthatolásvédelem középtalp kompozit szálból
- RENDKÍVÜL KÖNNYŰ: a 42-es méret körülbelüli súlya 450 g

EN ISO
20345
2022

EU	UK	mm	Ft	☑	☑
38	5	254	60.700	1	073710038
39	6	261	60.700	1	073710039
40	6,5	268	60.700	1	073710040
41	7	274	60.700	1	073710041
42	8	281	60.700	1	073710042
43	9	288	60.700	1	073710043
44	10	294	60.700	1	073710044
45	10,5	301	60.700	1	073710045
46	11	308	60.700	1	073710046
47	12	314	60.700	1	073710047
48	13	321	60.700	1	073710048

CE



S1PS HRO FO SR ESD



7372B

ellenálló, kiválóan szellőző szőtt vászoncipő.

Sarok stabilitását segítő alátámasztás, hagyományos fűzés, szélesített kivitel.

EVA talprész nagy ellenállású nitril gumitalppal.

- Kompozit orrvédő
- Kompozitszálas, áthatolásbiztos betét
- RENDKÍVÜL KÖNNYŰ - a 42-es méret körülbelüli súlya: 450g

EN ISO
20345
2011

EU	UK	mm	Ft	☑	☑
38	5	254	62.150	1	073720038
39	6	261	62.150	1	073720039
40	6,5	268	62.150	1	073720040
41	7	274	62.150	1	073720041
42	8	281	62.150	1	073720042
43	9	288	62.150	1	073720043
44	10	294	62.150	1	073720044
45	10,5	301	62.150	1	073720045
46	11	308	62.150	1	073720046
47	12	314	62.150	1	073720047
48	13	321	62.150	1	073720048

CE



S1P HRO SRC



7376A

perforált, jól szellőző mikroszálas és mesh szandál

Sarok stabilitását segítő alátámasztás, hagyományos fűzés, elasztikus fűző, szélesített kivitel.

EVA talprész nagy ellenállású nitril gumitalppal.

- Kompozit orrvédő
- Kompozitszálas, áthatolásbiztos betét
- RENDKÍVÜL KÖNNYŰ - a 42-es méret körülbelüli súlya: 490 g

EN ISO
20345
2011

EU	UK	mm	Ft	☑	☑
39	6	261	62.950	1	073760039
40	6,5	268	62.950	1	073760040
41	7	274	62.950	1	073760041
42	8	281	62.950	1	073760042
43	9	288	62.950	1	073760043
44	10	294	62.950	1	073760044
45	10,5	301	62.950	1	073760045
46	11	308	62.950	1	073760046
47	12	314	62.950	1	073760047
48	13	321	62.950	1	073760048

CE

A KÉSZLET EREJÉIG!



S1P HRO SRC



7381N

Magas kopásállóságú szövetből készült vízálló cipő TPU betétekkel.

- Kompozit orrvédő
- Kompozitszálas, áthatolásbiztos betét

EN ISO
20345
2011

EU	UK	mm	Ft	☑	☑
38	5	254	72.050	1	073810038
39	6	261	72.050	1	073810039
40	6,5	268	72.050	1	073810040
41	7	274	72.050	1	073810041
42	8	281	72.050	1	073810042
43	9	288	72.050	1	073810043
44	10	294	72.050	1	073810044
45	10,5	301	72.050	1	073810045
46	11	308	72.050	1	073810046
47	12	314	72.050	1	073810047
48	13	321	72.050	1	073810048

CE



S3 SRC HRO WR



7382N

Magas kopásállóságú szövetből készült vízálló bokacipő TPU betétekkel.

- Kompozit orrvédő
- Kompozitszálás, áthatolásbiztos betét

EN ISO
20345
2011



EU	UK	mm	Ft	👤	📄
38	5	254	80.750	1	073820038
39	6	261	80.750	1	073820039
40	6,5	268	80.750	1	073820040
41	7	274	80.750	1	073820041
42	8	281	80.750	1	073820042
43	9	288	80.750	1	073820043
44	10	294	80.750	1	073820044
45	10,5	301	80.750	1	073820045
46	11	308	80.750	1	073820046
47	12	314	80.750	1	073820047
48	13	321	80.750	1	073820048

CE



S3 SRC HRO WR

FitEvolution

A Beta FitEvolution munkavédelmi lábbeli termékcsalád 7 egyedi tervezésű modellt kínál, különböző színekben és anyagokban. Forradalmi jellemzője a legmodernebb technológián alapuló, innovatív, szabadalmaztatott Fit4You rendszer, amely a testmagasságnak, testsúlynak, valamint az egyéni munkakörülményeknek és használatnak megfelelő testreszabott kényelmet és alátámasztást biztosít.

Minden csomag három – PUHA, KÖZEPES és KEMÉNY – ETPU betétet tartalmaz, amelyek révén a lábbeli tökéletesen biztosítja a kívánt keménységet, így minden helyzetben személyre szabott kényelmet nyújt.



7270Y

FitEVOLUTION jól szellőző, mesh szövet cipő, szabadalmaztatott FIT 4 YOU betétekkel. Sarok stabilitását segítő alátámasztás és hagyományos fűzés. Kétrétegű poliuretán talp

- kompozit orrvédő
- kompozitszálás, áthatolásbiztos betét
- 3 különböző szilárdságú ETPU betét a személyre szabott kényelemért

EN ISO
20345
2022



EU	UK	mm	Ft	👤	📄
37	4,5	251	66.000	1	072700137
38	5	257	66.000	1	072700138
39	6	263	66.000	1	072700139
40	6,5	269	66.000	1	072700140
41	7	276	66.000	1	072700141
42	8	282	66.000	1	072700142
43	9	290	66.000	1	072700143
44	10	296	66.000	1	072700144
45	10,5	304	66.000	1	072700145
46	11	311	66.000	1	072700146
47	12	317	66.000	1	072700147
48	13	324	66.000	1	072700148

CE

FIT4YOU



S1PS FO SR ESD

7271V

FitEVOLUTION perforált hasítottbőr cipő szabadalmaztatott FIT 4 YOU betétekkel. Sarok stabilitását segítő alátámasztás és hagyományos fűzés. Kétrétegű poliuretán talp

- kompozit orrvédő
- kompozitszálás, áthatolásbiztos betét
- 3 különböző szilárdságú ETPU betét a személyre szabott kényelemért

EN ISO
20345
2022



EU	UK	mm	Ft	👤	📄
37	4,5	251	66.000	1	072710137
38	5	257	66.000	1	072710138
39	6	263	66.000	1	072710139
40	6,5	269	66.000	1	072710140
41	7	276	66.000	1	072710141
42	8	282	66.000	1	072710142
43	9	290	66.000	1	072710143
44	10	296	66.000	1	072710144
45	10,5	304	66.000	1	072710145
46	11	311	66.000	1	072710146
47	12	317	66.000	1	072710147
48	13	324	66.000	1	072710148

CE

FIT4YOU



S1PS FO SR ESD

7272V

FitEVOLUTION ellenálló és jól szellőző szőtt vászon cipő, szabadalmaztatott FIT 4 YOU betétekkel.

Sarok stabilitását segítő alátámasztás és hagyományos fűzés. Kétrétegű poliuretán talp

- kompozit orrvédő
- kompozitszálás, áthatolásbiztos betét
- 3 különböző szilárdságú ETPU betét a személyre szabott kényelemért

**EN ISO
20345
2022**

EU	UK	mm	Ft		
37	4,5	251	66.000	1	072720137
38	5	257	66.000	1	072720138
39	6	263	66.000	1	072720139
40	6,5	269	66.000	1	072720140
41	7	276	66.000	1	072720141
42	8	282	66.000	1	072720142
43	9	290	66.000	1	072720143
44	10	296	66.000	1	072720144
45	10,5	304	66.000	1	072720145
46	11	311	66.000	1	072720146
47	12	317	66.000	1	072720147
48	13	324	66.000	1	072720148

FIT4YOU



CE

S1PS FO SR ESD

7273G

FitEVOLUTION vízlepergető nubuk cipő szabadalmaztatott FIT 4 YOU betétekkel.

Sarok stabilitását segítő alátámasztás és hagyományos fűzés. Kétrétegű poliuretán talp

- kompozit orrvédő
- kompozitszálás, áthatolásbiztos betét
- 3 különböző szilárdságú ETPU betét a személyre szabott kényelemért

**EN ISO
20345
2022**

EU	UK	mm	Ft		
37	4,5	251	67.600	1	072730137
38	5	257	67.600	1	072730138
39	6	263	67.600	1	072730139
41	7	276	67.600	1	072730141
40	6,5	269	67.600	1	072730140
42	8	282	67.600	1	072730142
43	9	290	67.600	1	072730143
44	10	296	67.600	1	072730144
45	10,5	304	67.600	1	072730145
46	11	311	67.600	1	072730146
47	12	317	67.600	1	072730147
48	13	324	67.600	1	072730148

FIT4YOU



CE

S3S FO SR ESD

7274G

FitEVOLUTION vízlepergető nubuk bokacipő szabadalmaztatott FIT 4 YOU betétekkel.

Sarok stabilitását segítő alátámasztás és hagyományos fűzés. Kétrétegű poliuretán talp

- kompozit orrvédő
- kompozitszálás, áthatolásbiztos betét
- 3 különböző szilárdságú ETPU betét a személyre szabott kényelemért

**EN ISO
20345
2022**

EU	UK	mm	Ft		
37	4,5	251	69.850	1	072740237
38	5	257	69.850	1	072740238
39	6	263	69.850	1	072740239
40	6,5	269	69.850	1	072740240
41	7	276	69.850	1	072740241
42	8	282	69.850	1	072740242
43	9	290	69.850	1	072740243
44	10	296	69.850	1	072740244
45	10,5	304	69.850	1	072740245
46	11	311	69.850	1	072740246
47	12	317	69.850	1	072740247
48	13	324	69.850	1	072740248

FIT4YOU



CE

S3S FO SR ESD

7275N

FitEVOLUTION vízlepergető mikroszálás cipő szabadalmaztatott FIT 4 YOU betétekkel.

Sarok stabilitását segítő alátámasztás és hagyományos fűzés. Kétrétegű poliuretán talp

- kompozit orrvédő
- kompozitszálás, áthatolásbiztos betét
- 3 különböző szilárdságú ETPU betét a személyre szabott kényelemért

**EN ISO
20345
2022**

EU	UK	mm	Ft		
37	4,5	251	67.600	1	072750237
38	5	257	67.600	1	072750238
39	6	263	67.600	1	072750239
40	6,5	269	67.600	1	072750240
41	7	276	67.600	1	072750241
42	8	282	67.600	1	072750242
43	9	290	67.600	1	072750243
44	10	296	67.600	1	072750244
45	10,5	304	67.600	1	072750245
46	11	311	67.600	1	072750246
47	12	317	67.600	1	072750247
48	13	324	67.600	1	072750248

FIT4YOU



CE

S3S FO SR ESD

7276N

FitEVOLUTION vízlepergető mikroszálas bokacipő szabadalmaztatott FIT 4 YOU betétekkel.

Sarok stabilitását segítő alátámasztás és hagyományos fűzés. Kétrétegű poliuretán talp

- kompozit orrvédő • kompozitszálas, áthatolásbiztos betét
- 3 különböző szilárdságú ETPU betét a személyre szabott kényelemért

FIT4YOU

EN ISO
20345
2022



S3S FO SR ESD

CE

EU	UK	mm	Ft		
37	4,5	251	69.850	1	072760237
38	5	257	69.850	1	072760238
39	6	263	69.850	1	072760239
40	6,5	269	69.850	1	072760240
41	7	276	69.850	1	072760241
42	8	282	69.850	1	072760242
43	9	290	69.850	1	072760243
44	10	296	69.850	1	072760244
45	10,5	304	69.850	1	072760245
46	11	311	69.850	1	072760246
47	12	317	69.850	1	072760247
48	13	324	69.850	1	072760248

RENEGADE

Az új munkavédelmi lábbelicsalád, a Renegade tervezése során az abszolút biztonságot és stílust tartottuk szem előtt. A Renegade-ben a magas fokú védelem megnyerő, modern megjelenéssel párosul. A hat egyedi színű és anyagú modellből álló termékcsalád tökéletesen megfelel azoknak, akik bármilyen munkakörnyezetben ki szeretnének tűnni.

A Renegade kialakítása a legújabb generációs sportcipőket idézi, a kiemelkedő alátámasztást és csillapítást biztosító talp pedig egész nap kényelmes viseletet garantál. A széles, 11-es fejrész sima és kényelmes járást biztosít anélkül, hogy összenyomná a lábat. A merész, szokatlan stílusú Renegade ideális választás a modern szakemberek számára.

A 7340VA modell a Beta első gyorsfűzős rendszerű cipője.



7340VA

RENEGADE jól szellőző mesh szövetvászoncipő ATOP gyorsfűzővel

Sarok stabilitását segítő alátámasztás

EVA talprész nagy ellenállású nitril gumitalppal

Szélesített kivitel

- kompozit orrvédő
- kompozitszálas, áthatolásbiztos betét

EN ISO
20345
2022



S1PS FO SR HRO

CE

EU	UK	mm	Ft		
37	4,5	248	76.100	1	073400537
38	5	254	76.100	1	073400538
39	6	261	76.100	1	073400539
40	6,5	268	76.100	1	073400540
41	7	274	76.100	1	073400541
42	8	281	76.100	1	073400542
43	9	288	76.100	1	073400543
44	10	294	76.100	1	073400544
45	10,5	301	76.100	1	073400545
46	11	308	76.100	1	073400546
47	12	314	76.100	1	073400547
48	13	321	76.100	1	073400548

7340G

RENEGADE jól szellőző mesh szövet cipő

Sarok stabilitását segítő alátámasztás

EVA talprész nagy ellenállású nitril gumitalppal

Hagyományos fűzés

Szélesített kivitel

- kompozit orrvédő
- kompozitszálas, áthatolásbiztos betét

EN ISO
20345
2022



S1PS FO SR HRO

CE

EU	UK	mm	Ft		
37	4,5	248	61.950	1	073400637
38	5	254	61.950	1	073400638
39	6	261	61.950	1	073400639
40	6,5	268	61.950	1	073400640
41	7	274	61.950	1	073400641
42	8	281	61.950	1	073400642
43	9	288	61.950	1	073400643
44	10	294	61.950	1	073400644
45	10,5	301	61.950	1	073400645
46	11	308	61.950	1	073400646
47	12	314	61.950	1	073400647
48	13	321	61.950	1	073400648

7341V

RENEGADE ellenálló, kiválóan szellőző szőtt vászoncipő.

Sarok stabilitását segítő alátámasztás

EVA talprész nagy ellenállású nitril gumitalppal

Hagyományos fűzés

Szélesített kivitel

EU	UK	mm	Ft		
37	4.5	248	64.950	1	073410537
38	5	254	64.950	1	073410538
39	6	261	64.950	1	073410539
40	6.5	268	64.950	1	073410540
41	7	274	64.950	1	073410541
42	8	281	64.950	1	073410542
43	9	288	64.950	1	073410543
44	10	294	64.950	1	073410544
45	10.5	301	64.950	1	073410545
46	11	308	64.950	1	073410546
47	12	314	64.950	1	073410547
48	13	321	64.950	1	073410548

CE

- kompozit orrvédő
- kompozitszálás, áthatolásbiztos betét



S1PS FO SR HRO

EN ISO
20345
2022

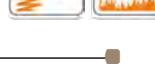

7341Y

RENEGADE ellenálló, kiválóan szellőző szőtt vászoncipő

Sarok stabilitását segítő alátámasztás

EVA talprész nagy ellenállású nitril gumitalppal

Hagyományos fűzés

Szélesített kivitel

EU	UK	mm	Ft		
37	4.5	248	64.950	1	073410637
38	5	254	64.950	1	073410638
39	6	261	64.950	1	073410639
40	6.5	268	64.950	1	073410640
41	7	274	64.950	1	073410641
42	8	281	64.950	1	073410642
43	9	288	64.950	1	073410643
44	10	294	64.950	1	073410644
45	10.5	301	64.950	1	073410645
46	11	308	64.950	1	073410646
47	12	314	64.950	1	073410647
48	13	321	64.950	1	073410648

CE

- kompozit orrvédő
- kompozitszálás, áthatolásbiztos betét



S1PS FO SR HRO

EN ISO
20345
2022



7342N

RENEGADE vízlepergető mikroszálás cipő

Sarok stabilitását segítő alátámasztás

EVA talprész nagy ellenállású nitril gumitalppal

Hagyományos fűzés

Szélesített kivitel

EU	UK	mm	Ft		
37	4.5	248	69.000	1	073420537
38	5	254	69.000	1	073420538
39	6	261	69.000	1	073420539
40	6.5	268	69.000	1	073420540
41	7	274	69.000	1	073420541
42	8	281	69.000	1	073420542
43	9	288	69.000	1	073420543
44	10	294	69.000	1	073420544
45	10.5	301	69.000	1	073420545
46	11	308	69.000	1	073420546
47	12	314	69.000	1	073420547
48	13	321	69.000	1	073420548

CE

- kompozit orrvédő
- kompozitszálás, áthatolásbiztos betét



S3S FO SR HRO

EN ISO
20345
2022



7343N

RENEGADE mikroszálás bokacipő, vízlepergető

Sarok stabilitását segítő alátámasztás

EVA talprész nagy ellenállású nitril gumitalppal

Hagyományos fűzés

Szélesített kivitel

EU	UK	mm	Ft		
37	4.5	248	75.300	1	073430537
38	5	254	75.300	1	073430538
39	6	261	75.300	1	073430539
40	6.5	268	75.300	1	073430540
41	7	274	75.300	1	073430541
42	8	281	75.300	1	073430542
43	9	288	75.300	1	073430543
44	10	294	75.300	1	073430544
45	10.5	301	75.300	1	073430545
46	11	308	75.300	1	073430546
47	12	314	75.300	1	073430547
48	13	321	75.300	1	073430548

CE

- kompozit orrvédő
- kompozitszálás, áthatolásbiztos betét



S3S FO SR HRO

EN ISO
20345
2022





HEAVY DUTY



7293HM

mérsékeltlen vízálló, faggyúzott full-grain bőrcipő nagyteljesítményű VIBRAM® járófelülettel, kopásálló betéttel a saroknál, és poliuretán orrvédővel

- Üvegszálás orrvédő
- Áthatolásvédett középtalp kompozit szálból

EN ISO 20345 2011

EU	UK	mm	Ft		
39	6	263	80.750	1	072930639
40	6,5	270	80.750	1	072930640
41	7	276	80.750	1	072930641
42	8	283	80.750	1	072930642
43	9	289	80.750	1	072930643
44	10	296	80.750	1	072930644
45	10,5	302	80.750	1	072930645
46	11	309	80.750	1	072930646
47	12	315	80.750	1	072930647
48	13	322	80.750	1	072930648



CE

S3 HRO HI SRC



7294HM

mérsékeltlen vízálló, faggyúzott full-grain bőr félcipő nagyteljesítményű VIBRAM® járófelülettel, kopásálló betéttel a saroknál, és poliuretán orrvédővel

- Üvegszálás orrvédő
- Áthatolásvédett középtalp kompozit szálból

EN ISO 20345 2011

EU	UK	mm	Ft		
39	6	263	85.400	1	072940639
40	6,5	270	85.400	1	072940640
41	7	276	85.400	1	072940641
42	8	283	85.400	1	072940642
43	9	289	85.400	1	072940643
44	10	296	85.400	1	072940644
45	10,5	302	85.400	1	072940645
46	11	309	85.400	1	072940646
47	12	315	85.400	1	072940647
48	13	322	85.400	1	072940648



CE

S3 HRO HI SRC



7294HMC

mérsékeltlen vízálló, faggyúzott full-grain bőr bokacipő nagyteljesítményű VIBRAM® járófelülettel, kopásálló betéttel a saroknál, és poliuretán orrvédővel
Tepor membránnal, vízhatlan, szélálló, és rendkívül légáteresztő

- Üvegszálás orrvédő
- Áthatolásvédett középtalp kompozit szálból

EN ISO 20345 2011

EU	UK	mm	Ft		
39	6	263	95.350	1	072940739
40	6,5	270	95.350	1	072940740
41	7	276	95.350	1	072940741
42	8	283	95.350	1	072940742
43	9	289	95.350	1	072940743
44	10	296	95.350	1	072940744
45	10,5	302	95.350	1	072940745
46	11	309	95.350	1	072940746
47	12	315	95.350	1	072940747
48	13	322	95.350	1	072940748



CE

S3 HRO HI CI WR SRC



ACCESSORIES

7397S

FIT4YOU puha betétek

Szabadalmaztatott FIT4YOU rendszerű puha betétek a FitEVOLUTION lábbelikhez



EU	UK	Ft		
39/40	6/6,5	6.440	1	073970139
37/38	4,5/5	6.440	1	073970137
41/42	7/8	6.440	1	073970141
43/44	9/10	6.440	1	073970143
45/46	10,5/11	6.440	1	073970145
47/48	12/13	6.440	1	073970147

7397M

FIT4YOU közepes betétek

Szabadalmaztatott FIT4YOU rendszerű közepes betétek a FitEVOLUTION lábbelikhez



EU	UK	Ft		
37/38	4,5/5	6.440	1	073970237
39/40	6/6,5	6.440	1	073970239
41/42	7/8	6.440	1	073970241
43/44	9/10	6.440	1	073970243
45/46	10,5/11	6.440	1	073970245
47/48	12/13	6.440	1	073970247

7397H

FIT4YOU kemény betétek

Szabadalmaztatott FIT4YOU rendszerű kemény betétek a FitEVOLUTION lábbelikhez



EU	UK	Ft		
37/38	4,5/5	6.440	1	073970337
39/40	6/6,5	6.440	1	073970339
41/42	7/8	6.440	1	073970341
43/44	9/10	6.440	1	073970343
45/46	10,5/11	6.440	1	073970345
47/48	12/13	6.440	1	073970347

7398 0/G

anatómiailag formázott EVA hab talpbetét csillapító sarokrészsel (a 0-Gravity cipőkhöz ajánlott kiegészítő)



EU	UK	Ft		
38	5	3.280	1	073981238
39	6	3.280	1	073981239
40	6,5	3.280	1	073981240
41	7	3.280	1	073981241
42	8	3.280	1	073981242
43	9	3.280	1	073981243
44	10	3.280	1	073981244
45	10,5	3.280	1	073981245
46	11	3.280	1	073981246
47	12	3.280	1	073981247
48	13	3.280	1	073981248

7398ESD

anatómiailag formázott, szellőző talpbetét szagálló antibakteriális felső réteggel. ESD tanúsítású lábbelikhez



EU	UK	Ft		
35	2,5	3.770	1	073981435
36	3,5	3.770	1	073981436
37	4,5	3.770	1	073981437
38	5	3.770	1	073981438
39	6	3.770	1	073981439
40	6,5	3.770	1	073981440
41	7	3.770	1	073981441
42	8	3.770	1	073981442
43	9	3.770	1	073981443
44	10	3.770	1	073981444
45	10,5	3.770	1	073981445
46	11	3.770	1	073981446
47	12	3.770	1	073981447
48	13	3.770	1	073981448

7398U

anatómiailag formázott, TPR GEL anyagú, erősen csillapító hatású talpbetét, talpboltozat tartó, és sarokrészi párna



EU	UK	Ft		
36 - 40	3,5 - 6,5	6.070	1	073980058
41 - 46	7 - 11	6.070	1	073980063

7398UP

anatómiailag formázott, citrusos illatú TPE GEL anyagú talpboltozat tartó talpbetét



EU	UK	Ft		
36 - 40	3,5 - 6	5.510	1	073980076
41 - 46	7 - 11	5.510	1	073980081

7398GEL

Talpfarmát követő gél-betétes talpbetét



EU	UK	Ft		
35	2,5	2.000	1	073980835
36	3,5	2.000	1	073980836
37	4,5	2.000	1	073980837
38	5	2.000	1	073980838
39	6	2.000	1	073980839
40	6,5	2.000	1	073980840
41	7	2.000	1	073980841
42	8	2.000	1	073980842
43	9	2.000	1	073980843
44	10	2.000	1	073980844
45	10,5	2.000	1	073980845
46	11	2.000	1	073980846
47	12	2.000	1	073980847
48	13	2.000	1	073980848

7398EF

anatómiai formázott poliuretán hab talpbetét a sarokrészen emelt csillapító betéttel



EU	UK	Ft	📦	🏠
35	2,5	3.830	1	073981135
36	3,5	3.830	1	073981136
37	4,5	3.830	1	073981137
38	5	3.830	1	073981138
39	6	3.830	1	073981139
40	6,5	3.830	1	073981140
41	7	3.830	1	073981141
42	8	3.830	1	073981142
43	9	3.830	1	073981143
44	10	3.830	1	073981144
45	10,5	3.830	1	073981145
46	11	3.830	1	073981146
47	12	3.830	1	073981147
48	13	3.830	1	073981148

7399 A/N...

10 pár cipőfűző



cm	Ft	📦	🏠
100	7.210	1	073990010
120	8.500	1	073990012
140	10.300	1	073990017

A megadott árak 10 párra vonatkoznak.

7421

kompressziós térdzokni nylon és pamut erősítéssel az orrnál és a saroknál
Ellenálló, gombaölő és szellőző bambusz szálal talprész



📏	EU	Ft	📦	🏠
M	39-42	7.650	1	074210002
L	43-46	7.650	1	074210004

7422P

magasszárú zokni újrahasonított frottír anyagból, rezgéselnyelő frottír orr- és sarokrész
2 pár színváltozatok:
fekete – szürke, narancs és barna betétekkel
szürke – fekete, narancs és barna betétekkel



📏	EU	Ft	📦	🏠
M	39-42	6.680	1	074220102
L	43-46	6.680	1	074220104

7425

bokazokni szellőző textilbetétekkel és nylon/pamut erősítéssel az orrnál és a saroknál
Ellenálló, gombaölő és szellőző bambusz szálal kevert nylon talprész



📏	EU	Ft	📦	🏠
M	39-42	5.020	1	074250002
L	43-46	5.020	1	074250004

7426P

Maxi sneaker zokni újrahasonított frottírból, frottír talprész, rezgéselnyelő orr- és sarokrész
2 pár színváltozatok:
szürke, fekete és kék betétekkel
fekete, kék és szürke betétekkel



📏	EU	Ft	📦	🏠
M	39-42	6.230	1	074260102
L	43-46	6.230	1	074260104

7427

maxi sneaker zokni védő és szellőző betétekkel a sípcsont és a rüszk területén.
Nylon és pamut erősítéssel az orrnál és a saroknál, és ellenálló, gombaölő és szellőző bambusz szálal talprész



📏	EU	Ft	📦	🏠
M	39-42	4.250	1	074270002
L	43-46	4.250	1	074270004

7430T

Sneaker zokni újrahasonított pamutból, rezgéselnyelő frottír orr- és sarokrész
3 pár színváltozatok:
melange szürke – fekete és bordó betétekkel
fekete – szürke betétekkel
melange szürke – fekete betétekkel



📏	EU	Ft	📦	🏠
M	39-42	8.020	1	074300202
L	43-46	8.020	1	074300204

7431P

két pár sneaker zokni szellőző betétekkel és nejlón/pamut erősítéssel az orrnál és a sarokrésznél

Ellenálló, gombásodásgátló és szellőző bambusz szálal nejlón talprésszel.
Egy pár fekete/narancs és egy pár fekete/ szürke színű zokni.



📏	EU	Ft	📦	🏠
M	39-42	3.770	1	074310102
L	43-46	3.770	1	074310104



MUNKARUHÁZAT

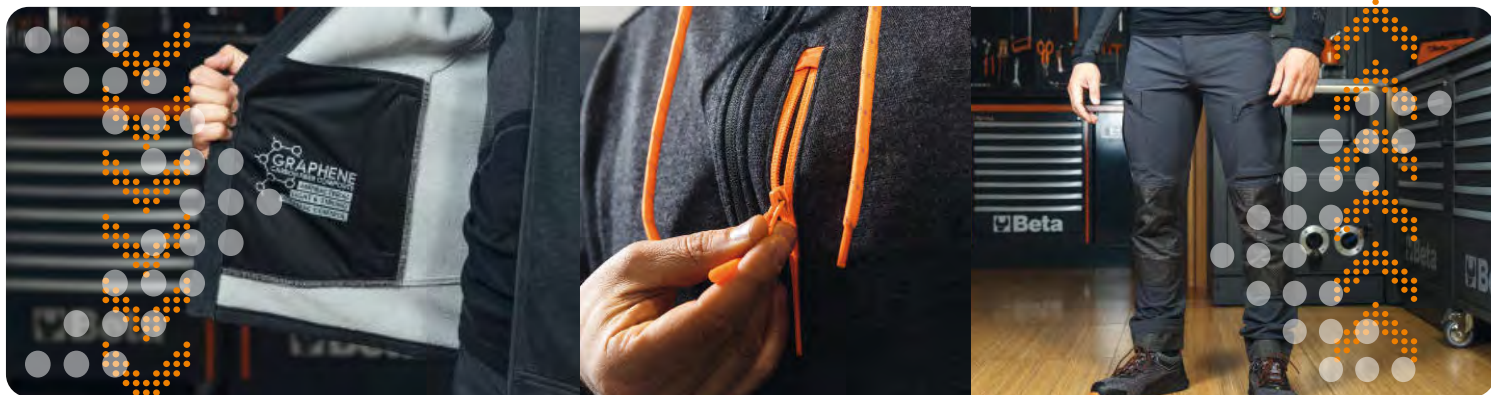

Az elmúlt évek során a Beta munkaruha családja nagy népszerűsége tett szert és széles körben ismertté vált a legigényesebb szakemberek körében. A termék sikere a választék állandó fejlesztésében és bővítésében rejlik. Beta Utensili S.p.a. cég által gyártott munkaruházat a következő szabványnak felel meg: EN ISO 13688:2013

Az egyéni védőeszköz védelmet biztosít viselőjének a kisebb mértékű behatásokkal szemben, úm. kisebb horzsolások, napsütés, szél, hideg, nem mérgező por és szennyeződés. Ez a védelem az 1992. 12. 04-i, 475 számú törvénytervezet első kategóriájának felel meg.

UTASÍTÁS HASZNÁLATHOZ ÉS TÁROLÁSHOZ

A munkaruhát az előírásoknak megfelelően kell viselni annak érdekében, hogy megvédje viselőjét. A ruhákat szellős, száraz helyen eredeti csomagolásban kell tárolni védve a sugárzó hőtől, napsütéstől, portól és az időjárás viszontagságaitól.

MÉRETVÁLTOZÁS

Minden természetes szál mosás közben változtatja a méretét (összemeget). A méretváltozás mértéke (1%-5%) függ a különböző paraméterektől, különösen a szál fajtájától és a víz hőmérsékletétől.

SEZONÁLIS TERMÉKEK

Annak érdekében, hogy az év minden napján a legmegfelelőbb termékek álljanak rendelkezésre, munkaruházati kollekciónkat három szezonális termékcsaládra osztottuk:



TAVASZ-NYÁR: márciustól szeptemberig ajánljuk, könnyű, légáteresztő munkaruhákat tartalmaz.



ŐSZ-TÉL: szeptembertől márciusig ajánljuk, meleg, strapabíró munkaruhákat tartalmaz, amelyek tökéletesen ellenállnak a zord időjárási körülményeknek.

MINDEN ÉVSZAKBAN: Ez a termékcsalád egész évben viselhető, sokoldalú, praktikus munkaruhákat tartalmaz, amelyek minden évszakban páratlan kényelmet biztosítanak.

Mindegyik termékcsalád a minőséget ötvözi a kényelemmel és a dizajnnal, hogy az év minden időszakában megoldást nyújtson a felmerülő, különleges igényekre.

A MEGFELELŐ MÉRET MEGHATÁROZÁSA

		FÉRFI RUHÁZAT						NŐI RUHÁZAT							
		I	F	D	E	UK	USA	I	F	D	E	UK	USA		
FÉRFI RUHÁZAT	XS	46	38	42	40	30	32	NŐI RUHÁZAT	XS	38	34	32	34	6	2
	S	48	40	44	42	32	34		S	40	36	34	36	8	4
	M	50	42	46	44	34	36		M	42	38	36	38	10	6
	L	52	44	48	46	36	38		L	44	40	38	40	12	8
	XL	54	46	50	48	38	40		XL	46	42	40	42	14	10
2XL	56	48	52	50	40	42	2XL	48	44	42	44	16	12		
3XL	58	50	54	52	42	44	3XL	50	46	44	46	18	14		
4XL	60	52	56	54	44	46									
5XL	62	54	58	56	46	48									

A RUHA VISELŐJÉNEK MÉRETEI EN ISO 13688:2013

FÉRFI RUHÁZAT										
	XS	S	M	L	XL	2XL	3XL	4XL	5XL	
A	88-92	92-96	96-104	104-108	108-116	116-124	124-132	132-140	140-148	
B	79-83	83-87	87-91	91-95	95-100	100-107	107-112	112-120	120-128	
H	158-164	164-170	170-176	176-182	182-188	188-194	194-200	200-206	206-212	

NŐI RUHÁZAT								
	XS	S	M	L	XL	2XL	3XL	
A	72-77	77-82	82-87	87-93	93-99	99-105	105-111	
B	162-165	164-167	168-171	170-173	172-175	174-177	176-179	

ÚTMUTATÓ MUNKA- ÉS EGYÉB RUHÁZAT KIVÁLASZTÁSÁHOZ - 2025 ÁRLISTA

Kategória	Katalógusszám	Tétel típus	Oldal	Szín	Ajánlott összeállítások (a nadrággal megegyező színű és anyagú szövet)											
					Bermuda	Oldal	Kertész nadrág	Oldal	Overáll	Oldal	Mellény	Oldal	Dzseki	Oldal		
MUNKANADRÁGOK, KÖNNYÍTETT KIVITEL	7610G	Trekking	653	7611G	656											
	7610N		653													
	7660B	Top Line	653	7661B	657											
	7660G		654	7661G	657											
	7820SG	Stretch	655	7821SG	657											
	7860G	Beta Easy	655	7861G	657	7863G	658	7865G	659	7867G	661	7869G	660			
	7860B		655	7861B	658			7865B	658	7867B	660					
7930MG	Cotton	656	7931MG	658			7935MG	659	7937MG	661						
MUNKANADRÁGOK, EGÉSZ ÉVRE	7600G	Trekking	652													
	7600N		652													
	7640GG	Graphene	653													
	7650	Top Line	653										7653G	659		
	7650B		653													
	7818BL		654													
	7818CM		654	7815CM	657											
	7818G		654													
	7819G		654													
	7830SN	Stretch	655	7831SN	657											
	7840BL	Beta Easy	655											7849BL	659	
	7850G		655													
	7900G	Beta Easy	656				7903G	658	7905G	659	7907G	661	7909G	660		
7940	Multiprotection	656											7949	660		
7818LN	Lady	654														

ÚTMUTATÓ MUNKA- ÉS EGYÉB RUHÁZAT KIVÁLASZTÁSÁHOZ - 2025 ÁRLISTA

Kategória	Katalógusszám	Tétel típus	Oldal	Szín	Ajánlott összeállítások (a nadrággal megegyező színű és anyagú szövet)									
					Bermuda	Oldal	Kertész nadrág	Oldal	Overáll	Oldal	Mellény	Oldal	Dzseki	Oldal
MUNKAFARMER	7530		652											
	7528		652		7529	656								
	7527		652											

PÓLÓINGEK	7552BL		665		MINDEN TERMÉKKEL PÁROSÍTHATÓ A MEGFELELŐ SZÍNÖSSZEÁLLÍTÁS ESETÉN									
	7552G		665											
	7552N		665											

PÓLÓK	7548M		664		MINDEN TERMÉKKEL PÁROSÍTHATÓ A MEGFELELŐ SZÍNÖSSZEÁLLÍTÁS ESETÉN									
	7548C		664											
	7553BL		665											
	7553G		665											
	7553N		665											
	7553V		665											
	7550G	Top Line	664											
	7550N		664											

INGEK	7545F		664											
-------	-------	--	-----	--	--	--	--	--	--	--	--	--	--	--

HOSSZÚ UJJÚ FELSŐK	7637G		663		MINDEN TERMÉKKEL PÁROSÍTHATÓ A MEGFELELŐ SZÍNÖSSZEÁLLÍTÁS ESETÉN									
	7637B		663											
	7642G		663											
	7643G		663											
	7644GG	Graphene	663											
	7664N	Top Line	664											
	7665N		664											

POLÁR/ MIKROPOLÁR PULÓVEREK	7636N		662		MINDEN TERMÉKKEL PÁROSÍTHATÓ A MEGFELELŐ SZÍNÖSSZEÁLLÍTÁS ESETÉN									
	7654B		663											
	7654N	Top Line	663											
	7657B		663											
	7657N		664											

MELLÉNYEK	7579QN		660		MINDEN TERMÉKKEL PÁROSÍTHATÓ A MEGFELELŐ SZÍNÖSSZEÁLLÍTÁS ESETÉN									
	7647GG	Graphene	660											

DZSEKIK ÉS SOFTSHELL RUHÁZATOK	7648GG	Graphene	661		MINDEN TERMÉKKEL PÁROSÍTHATÓ A MEGFELELŐ SZÍNÖSSZEÁLLÍTÁS ESETÉN									
	7658CM		661											
	7659N	Top Line	661											
	7669N		662											

VATTÁZOTT DZSEKIK	7670G	Top Line	662		MINDEN TERMÉKKEL PÁROSÍTHATÓ A MEGFELELŐ SZÍNÖSSZEÁLLÍTÁS ESETÉN									
	7679GG	Graphene	662											
	7780QN		662											
	7750N		662											

ÚTMUTATÓ MUNKA- ÉS EGYÉB RUHÁZAT KIVÁLASZTÁSÁHOZ - 2025 ÁRLISTA

Kategória	Katalógusszám	Tétel típus	Oldal	Szín	Ajánlott összeállítások (a nadrággal megegyező színű és anyagú szövet)									
					Bermuda	Oldal	Kertész nadrág	Oldal	Overáll	Oldal	Mellény	Oldal	Dzseki	Oldal
VÍZHATLAN RUHÁZAT	7971B	Vízálló esőnadrág	665										7978B	666
	7981N	vízhatlan sapka	667											

KIEGÉSZÍTŐK	7980NC	Téli sapka	668		MINDEN TERMÉKKEL PÁROSÍTHATÓ A MEGFELELŐ SZÍNÖSSZEÁLLÍTÁS ESETÉN									
	7980RN	Kötött téli sapka	667											
	7980L	Sapka lámpával	667											
	7982N	Sapka	667											
	7984G	Öv	667											
	7985N	Nyakmelegítő	667											
	7996N	Technikai alálöltöző szett	666											
	7997GN	Podkoszulka termoaktywna	666											
	7998GN	Kalesony termoaktywna	666											



PANTS



7527
farmernadrág,
60% pamut, 27% poliészter és 3%
elasztikus szövet
Normál szabású

CE

Jeans



MEZMÉRÉS	IT	Ft	1	2
XS	46	24.500	1	075270046
S	48	24.500	1	075270048
M	50	24.500	1	075270050
L	52	24.500	1	075270052
XL	54	24.500	1	075270054
2XL	56	24.500	1	075270056
3XL	58	24.500	1	075270058

7528

Elasztikus farmernadrág (munkaruha)
98% pamut-denim, 2% elasztán, ~340g/m²

CE

Jeans



MEZMÉRÉS	IT	Ft	1	2
XS	46	26.900	1	075280046
S	48	26.900	1	075280048
M	50	26.900	1	075280050
L	52	26.900	1	075280052
XL	54	26.900	1	075280054
2XL	56	26.900	1	075280056
3XL	58	26.900	1	075280058

7530

elasztikus munkanadrág,
98% pamut és 2% elasztikus szövet,
poliészter erősítésekkel
Slim fit

CE

Jeans



MEZMÉRÉS	IT	Ft	1	2
XS	46	31.550	1	075300046
S	48	31.550	1	075300048
M	50	31.550	1	075300050
L	52	31.550	1	075300052
XL	54	31.550	1	075300054
2XL	56	31.550	1	075300056
3XL	58	31.550	1	075300058

76006

„work trekking” nadrág, HEAVY,
90% nejlón, 10% elasztikus szövet, 265 g/m²,
megerősített anyag a térdnél és a háton, elasztikus
lábszár rész függőlegesen záródó cipzárral
Sötétszürke, fluoreszkáló zöld betétekkel
Slim fit

CE

**TREKKING
HEAVY**



MEZMÉRÉS	IT	Ft	1	2
XS	46	33.000	1	076000000
S	48	33.000	1	076000001
M	50	33.000	1	076000002
L	52	33.000	1	076000003
XL	54	33.000	1	076000004
2XL	56	33.000	1	076000005
3XL	58	33.000	1	076000006

7600N

„work trekking” nadrág, HEAVY,
90% nejlón, 10% elasztikus szövet, 265 g/
m², megerősített anyag a térdnél és a háton,
elasztikus lábszár rész függőlegesen záródó
cipzárral
Slim fit

CE

**TREKKING
HEAVY**



MEZMÉRÉS	IT	Ft	1	2
XS	46	33.000	1	076000100
S	48	33.000	1	076000101
M	50	33.000	1	076000102
L	52	33.000	1	076000103
XL	54	33.000	1	076000104
2XL	56	33.000	1	076000105
3XL	58	33.000	1	076000106

7610G

„work trekking” nadrág, LIGHT
90% nejlon, 10% elasztikus szövet, 140 g/m²,
megerősített anyag a térdnél és az ülőrészen,
elasztikus lábszár rész és behúzó
Sötétszürke, sárga betétekkel
Slim fit

CE

TREKKING
LIGHT

	IT	Ft		
XS	46	32.000	1	076100000
S	48	32.000	1	076100001
M	50	32.000	1	076100002
L	52	32.000	1	076100003
XL	54	32.000	1	076100004
2XL	56	32.000	1	076100005
3XL	58	32.000	1	076100006

7640GG

sokszébes, elasztikus munkanadrág,
90% nejlon grafénnal, 10% spandex, 250 g/m²,
600D Oxford poliészterrel erősített, szürke
Hőszabályozó, vízlepergető, gyorsan szárad
Slim fit

CE

GRAPHENE
CARBON FIBER COMPOSITE
ANTIBACTERIAL
LIGHT & STRONG
THERMAL CONTROL



	I	Ft		
XS	46	41.700	1	076400010
S	48	41.700	1	076400011
M	50	41.700	1	076400012
L	52	41.700	1	076400013
XL	54	41.700	1	076400014
2XL	56	41.700	1	076400015
3XL	58	41.700	1	076400016

7650B

sokszébes elasztikus munkanadrág,
90% nejlon - 10% spandex, 260 g/m², kék
600D poliészterrel erősített térdvédőzsebek,
hátsó zsebek és lábszárak, elszakíthatatlan
ülőrész **A KÉSZLET EREJÉIG!**

CE

TOP
line

	IT	Ft		
XS	46	41.700	1	076500100
S	48	41.700	1	076500101
M	50	41.700	1	076500102
L	52	41.700	1	076500103
XL	54	41.700	1	076500104
2XL	56	41.700	1	076500105
3XL	58	41.700	1	076500106

7610N

„work trekking” nadrág, LIGHT
90% nejlon, 10% elasztikus szövet, 140 g/m²,
megerősített anyag a térdnél és az ülőrészen,
elasztikus lábszár rész és behúzó
Fekete, sárga betétekkel
Slim fit

CE

TREKKING
LIGHT

	IT	Ft		
XS	46	32.000	1	076100100
S	48	32.000	1	076100101
M	50	32.000	1	076100102
L	52	32.000	1	076100103
XL	54	32.000	1	076100104
2XL	56	32.000	1	076100105
3XL	58	32.000	1	076100106

7650

sokszébes elasztikus munkanadrág
90% nejlon - 10% spandex, 260 g/m²,
antracitszürke
600D poliészterrel erősített térdvédőzsebek,
hátsó zsebek és lábszárak, elszakíthatatlan
ülőrész **A KÉSZLET EREJÉIG!**

CE

TOP
line

	IT	Ft		
XS	46	41.700	1	076500000
S	48	41.700	1	076500001
M	50	41.700	1	076500002
L	52	41.700	1	076500003
XL	54	41.700	1	076500004
2XL	56	41.700	1	076500005
3XL	58	41.700	1	076500006

7660B

sokszébes elasztikus munkanadrág,
könnyített kivitel,
86% nejlon - 14% spandex, 140 g/m², kék
300D poliészterrel erősített térdvédőzsebek
és hátsó zsebek, elszakíthatatlan ülőrész
Slim fit **A KÉSZLET EREJÉIG!**

CE

TOP
line

	IT	Ft		
XS	46	35.800	1	076600100
S	48	35.800	1	076600101
M	50	35.800	1	076600102
L	52	35.800	1	076600103
XL	54	35.800	1	076600104
2XL	56	35.800	1	076600105
3XL	58	35.800	1	076600106

7660G

sokzsebes elasztikus munkanadrág, könnyített kivitel, 86% nejlón - 14% spandex, 140 g/m², antracitszürke 300D poliészterrel erősített térdvédőzsebek és lábszárak, elszakíthatatlan ülőrész Slim fit

A KÉSZLET EREJÉIG!

CE



TOP line



MAXIMUM	IT	Ft		
XS	46	35.800	1	076600000
S	48	35.800	1	076600001
M	50	35.800	1	076600002
L	52	35.800	1	076600003
XL	54	35.800	1	076600004
2XL	56	35.800	1	076600005
3XL	58	35.800	1	076600006

7818BL

sokzsebes munkanadrág, T/C vászon, 260 g/m², kék
A szár belső oldalán elasztikus szövet betéttel 300D poliészterrel erősített térdvédőzsebek és lábszárak, szakadásbiztos ülőrész és elasztikus szövet betét a szár belső oldalán és a derékrészen a mozgás megkönnyítésére

CE



MAXIMUM	IT	Ft		
XS	46	32.000	1	078180100
S	48	32.000	1	078180101
M	50	32.000	1	078180102
L	52	32.000	1	078180103
XL	54	32.000	1	078180104
2XL	56	32.000	1	078180105
3XL	58	32.000	1	078180106

7818LN

sokzsebes női munkanadrág, fekete szín rózsaszín betétekkel, 100% elasztikus pamut, 220 g/m² 300D poliészterrel erősített térdvédőzsebek és lábszárak, szakadásbiztos ülőrész és elasztikus szövet betét a szár belső oldalán a mozgás megkönnyítésére

CE

lady



MAXIMUM	IT	Ft		
XS	38	32.000	1	078180200
S	40	32.000	1	078180201
M	42	32.000	1	078180202
L	44	32.000	1	078180203
XL	46	32.000	1	078180204
2XL	48	32.000	1	078180205
3XL	50	32.000	1	078180206

7818G

sokzsebes munkanadrág, T/C vászon, 260 g/m², szürke 300D poliészterrel erősített térdvédőzsebek és lábszárak, szakadásbiztos ülőrész és elasztikus szövet betét a szár belső oldalán és a derékrészen a mozgás megkönnyítésére

CE



MAXIMUM	IT	Ft		
XS	46	32.000	1	078180000
S	48	32.000	1	078180001
M	50	32.000	1	078180002
L	52	32.000	1	078180003
XL	54	32.000	1	078180004
2XL	56	32.000	1	078180005
3XL	58	32.000	1	078180006

7818CM

sokzsebes munkanadrág, T/C vászon, 260 g/m², terepszínű szürke 300D poliészterrel erősített térdvédőzsebek és lábszárak, magas szakítószilárdságú ülőrész és elasztikus szövet betét a szár belső oldalán és a derékrészen a mozgás megkönnyítésének érdekében

CE

A KÉSZLET EREJÉIG!



MAXIMUM	IT	Ft		
XS	46	33.800	1	078180300
S	48	33.800	1	078180301
M	50	33.800	1	078180302
L	52	33.800	1	078180303
XL	54	33.800	1	078180304
2XL	56	33.800	1	078180305
3XL	58	33.800	1	078180306

7819G

sokzsebes munkanadrág, levehető lengőzsebekkel, T/C vászon, 260 g/m², szürke 300D poliészterrel erősített térdvédőzsebek és lábszárak, magas szakítószilárdságú ülőrész és elasztikus szövet betét a szár belső oldalán és a derékrészen a mozgás megkönnyítésének érdekében

CE



MAXIMUM	IT	Ft		
XS	46	32.000	1	078190000
S	48	32.000	1	078190001
M	50	32.000	1	078190002
L	52	32.000	1	078190003
XL	54	32.000	1	078190004
2XL	56	32.000	1	078190005
3XL	58	32.000	1	078190006

7830SN

elasztikus munkanadrág,
T/C twill anyagból, 200 g/m², fekete
Slim fit, szakadásbiztos ülőrész és oldalt
gumírozott derékrész

CE

STRETCH



IT	Ft		
XS 46	28.550	1	078300100
S 48	28.550	1	078300101
M 50	28.550	1	078300102
L 52	28.550	1	078300103
XL 54	28.550	1	078300104
2XL 56	28.550	1	078300105
3XL 58	28.550	1	078300106

7840BL

T/C twill munkanadrág 245 g, kék
Derékban oldalt elasztikus

CE

Beta EASY



IT	Ft		
XS 46	18.200	1	078400100
S 48	18.200	1	078400101
M 50	18.200	1	078400102
L 52	18.200	1	078400103
XL 54	18.200	1	078400104
2XL 56	18.200	1	078400105
3XL 58	18.200	1	078400106
4XL 60	18.200	1	078400107

7860B

Munkanadrág, könnyített kivitel,
T/C twill anyagból, 180 g/m², Oxford
betétekkel, kék

CE

Beta EASY

LIGHT



IT	Ft		
XS 46	23.700	1	078600700
S 48	23.700	1	078600701
M 50	23.700	1	078600702
L 52	23.700	1	078600703
XL 54	23.700	1	078600704
2XL 56	23.700	1	078600705
3XL 58	23.700	1	078600706
4XL 60	23.700	1	078600707
5XL 62	23.700	1	078600708

7820SG

Sokszéles elasztikus munkanadrág,
39% pamut, 61% poliészter, elasztikus,
mechanikus hasadásgátló anyaggal, 170 g/m²,
szürke
Térdvédőzsebek és oldalt gumírozott derékrész
Normál szabású

CE

STRETCH



IT	Ft		
XS 46	27.550	1	078200100
S 48	27.550	1	078200101
M 50	27.550	1	078200102
L 52	27.550	1	078200103
XL 54	27.550	1	078200104
2XL 56	27.550	1	078200105
3XL 58	27.550	1	078200106

7850G

Cargo munkanadrág,
100% pamut, 240 g/m²,
oldalt gumírozott derékrész, nagy
oldalzebek fényvisszaverő betétekkel
szürke, fluoreszkáló zöld részekkel
Slim fit

CE



IT	Ft		
XS 46	20.650	1	078500100
S 48	20.650	1	078500101
M 50	20.650	1	078500102
L 52	20.650	1	078500103
XL 54	20.650	1	078500104
2XL 56	20.650	1	078500105
3XL 58	20.650	1	078500106
4XL 60	20.650	1	078500107

7860G

munkanadrág, könnyített kivitel,
T/C twill, 180 g/m², Oxford betétekkel,
szürke

CE

Beta EASY

LIGHT



IT	Ft		
XS 46	23.700	1	078600800
S 48	23.700	1	078600801
M 50	23.700	1	078600802
L 52	23.700	1	078600803
XL 54	23.700	1	078600804
2XL 56	23.700	1	078600805
3XL 58	23.700	1	078600806
4XL 60	23.700	1	078600807
5XL 62	23.700	1	078600808

79006

munkanadrág,
T/C vászon, 260 g/m², Oxford betétekkel,
szürke
Új kialakítás – jobb viselhetőség

CE

Beta EASY



MEZŐMUNKÁS	IT	Ft	☒	☒
XS	46	26.100	1	079000800
S	48	26.100	1	079000801
M	50	26.100	1	079000802
L	52	26.100	1	079000803
XL	54	26.100	1	079000804
2XL	56	26.100	1	079000805
3XL	58	26.100	1	079000806
4XL	60	26.100	1	079000807

7940

többszörös védelmet nyújtó munkanadrág
T/C twill, 250 g/m², kék,
hőálló, lángálló, elektromos ív, hegesztési
szikrák és vegyi anyagok elleni védelem.

CE



7949



66U

DPI: III^A Categoria
EN ISO 11611:2015 - Classe 1
EN ISO 11612:2015 - A1 B1
C1
EN ISO 1149-5:2018
EN13034:2005+A1:2009
- Type 6
IEC 61482-2:2018 - APC 1

MEZŐMUNKÁS	IT	Ft	☒	☒
XS	46	38.050	1	079400000
S	48	38.050	1	079400001
M	50	38.050	1	079400002
L	52	38.050	1	079400003
XL	54	38.050	1	079400004
2XL	56	38.050	1	079400005

7930MG

Sokszéles munkanadrág, 97% pamut, 3%
elasztikus szövet, 220 g/m², szürke

CE

Cotton



MEZŐMUNKÁS	IT	Ft	☒	☒
XS	46	26.500	1	079300400
S	48	26.500	1	079300401
M	50	26.500	1	079300402
L	52	26.500	1	079300403
XL	54	26.500	1	079300404
2XL	56	26.500	1	079300405
3XL	58	26.500	1	079300406

BERMUDA



7529

Elastikus bermuda munkanadrág
98% pamut-denim, 2% elasztán, ~340g/m²

CE

Jeans



MEZŐMUNKÁS	IT	Ft	☒	☒
XS	46	21.450	1	075290046
S	48	21.450	1	075290048
M	50	21.450	1	075290050
L	52	21.450	1	075290052
XL	54	21.450	1	075290054
2XL	56	21.450	1	075290056
3XL	58	21.450	1	075290058

7611G

„work trekking” bermudanadrág, LIGHT
90% nejlón, 10% elasztikus szövet, 140 g/m²,
megerősített ülőrész.
Sötétszürke, sárga betétekkel.
Slim fit

CE

TREKKING
LIGHT

MEZŐMUNKÁS	IT	Ft	☒	☒
XS	46	24.500	1	076110000
S	48	24.500	1	076110001
M	50	24.500	1	076110002
L	52	24.500	1	076110003
XL	54	24.500	1	076110004
2XL	56	24.500	1	076110005
3XL	58	24.500	1	076110006



Beta

7661B

sokzsebes elasztikus bermuda munkanadrág, könnyített kivitel, 86% nejlón - 14% spandex, 140 g/m², kék 300D poliészterrel erősített hátszöbek, magas szakítószilárdságú ülőrész Slim fit

A KÉSZLET EREJÉIG!

CE



TOP line



IT	Ft	☒	☒
XS 46	31.150	1	076610100
S 48	31.150	1	076610101
M 50	31.150	1	076610102
L 52	31.150	1	076610103
XL 54	31.150	1	076610104
2XL 56	31.150	1	076610105
3XL 58	31.150	1	076610106



7661G

sokzsebes elasztikus bermuda munkanadrág, könnyített kivitel, 86% nejlón - 14% spandex, 140 g/m², antracitszürke 300D poliészterrel erősített hátszöbek, magas szakítószilárdságú ülőrész Slim fit

A KÉSZLET EREJÉIG!

CE



TOP line



IT	Ft	☒	☒
XS 46	31.150	1	076610000
S 48	31.150	1	076610001
M 50	31.150	1	076610002
L 52	31.150	1	076610003
XL 54	31.150	1	076610004
2XL 56	31.150	1	076610005
3XL 58	31.150	1	076610006



7815CM

sokzsebes bermuda munkanadrág, T/C vászon, 260 g/m², terepszínű szürke, magas szakítószilárdságú ülőrész és elasztikus szövet betét a szár belső oldalán és a derékrészben a mozgás megkönnyítésének érdekében

A KÉSZLET EREJÉIG!

CE



IT	Ft	☒	☒
XS 46	26.500	1	078150300
S 48	26.500	1	078150301
M 50	26.500	1	078150302
L 52	26.500	1	078150303
XL 54	26.500	1	078150304
2XL 56	26.500	1	078150305
3XL 58	26.500	1	078150306

7831SN

elasztikus bermuda munkanadrág, T/C twill anyagból, 200 g/m², fekete Slim fit, szakadásbiztos ülőrész és oldalt gumírozott derékrész

A KÉSZLET EREJÉIG!

CE



IT	Ft	☒	☒
XS 46	21.650	1	078310100
S 48	21.650	1	078310101
M 50	21.650	1	078310102
L 52	21.650	1	078310103
XL 54	21.650	1	078310104
2XL 56	21.650	1	078310105
3XL 58	21.650	1	078310106

7821SG

Sokzsebes elasztikus bermuda munkanadrág, 39% pamut, 61% poliészter, elasztikus, mechanikus hasadásgátló anyaggal, 170 g/m², szürke

Oldalt gumírozott derékrész Normál szabású

CE



IT	Ft	☒	☒
XS 46	21.650	1	078210100
S 48	21.650	1	078210101
M 50	21.650	1	078210102
L 52	21.650	1	078210103
XL 54	21.650	1	078210104
2XL 56	21.650	1	078210105
3XL 58	21.650	1	078210106

7861G

Bermuda munkanadrág, könnyített kivitel T/C twill, 180 g/m², Oxford betétekkel, szürke Új kialakítás – jobb viselhetőség

Beta EASY

CE LIGHT



IT	Ft	☒	☒
XS 46	19.650	1	078610800
S 48	19.650	1	078610801
M 50	19.650	1	078610802
L 52	19.650	1	078610803
XL 54	19.650	1	078610804
2XL 56	19.650	1	078610805
3XL 58	19.650	1	078610806
4XL 60	19.650	1	078610807
5XL 62	19.650	1	078610808



7861B

Bermuda munkanadrág, könnyített kivitel,
T/C twill anyagból, 180 g/m², Oxford
betétekkel, kék

CE **BetaEASY**

LIGHT



Méret	IT	Ft	1	2
XS	46	19.650	1	078610700
S	48	19.650	1	078610701
M	50	19.650	1	078610702
L	52	19.650	1	078610703
XL	54	19.650	1	078610704
2XL	56	19.650	1	078610705
3XL	58	19.650	1	078610706
4XL	60	19.650	1	078610707
5XL	62	19.650	1	078610708

7931MG

Bermuda munkanadrág, 97% pamut, 3%
elasztikus szövet, 220 g/m², szürke

CE

Cotton



Méret	IT	Ft	1	2
XS	46	21.450	1	079310400
S	48	21.450	1	079310401
M	50	21.450	1	079310402
L	52	21.450	1	079310403
XL	54	21.450	1	079310404
2XL	56	21.450	1	079310405
3XL	58	21.450	1	079310406



Beta



OVERALLS



7863G

kertész nadrág, könnyített kivitel
T/C twill, 180 g/m², Oxford betétekkel, szürke
Új kialakítás – jobb viselhetőség

CE **BetaEASY**

LIGHT



Méret	IT	Ft	1	2
XS	46	28.950	1	078630800
S	48	28.950	1	078630801
M	50	28.950	1	078630802
L	52	28.950	1	078630803
XL	54	28.950	1	078630804
2XL	56	28.950	1	078630805
3XL	58	28.950	1	078630806
4XL	60	28.950	1	078630807
5XL	62	28.950	1	078630808

7903E

kertész nadrág,
T/C vászon, 260 g/m², Oxford betétekkel,
szürke

Új kialakítás – jobb viselhetőség

CE

BetaEASY



Méret	IT	Ft	1	2
XS	46	32.800	1	079030800
S	48	32.800	1	079030801
M	50	32.800	1	079030802
L	52	32.800	1	079030803
XL	54	32.800	1	079030804
2XL	56	32.800	1	079030805
3XL	58	32.800	1	079030806
4XL	60	32.800	1	079030807

7865B

Overál, könnyített kivitel,
T/C twill anyagból, 180 g/m², Oxford
betétekkel, kék

CE

BetaEASY

LIGHT



Méret	IT	Ft	1	2
XS	46	37.650	1	078650700
S	48	37.650	1	078650701
M	50	37.650	1	078650702
L	52	37.650	1	078650703
XL	54	37.650	1	078650704
2XL	56	37.650	1	078650705
3XL	58	37.650	1	078650706
4XL	60	37.650	1	078650707
5XL	62	37.650	1	078650708

7865G

overall, könnyített kivitel,
T/C twill, 180 g/m², Oxford betétekkel, szürke
Új kialakítás – jobb viselhetőség

CE

Beta EASY

LIGHT



IT	Ft		
XS 46	37.650	1	078650800
S 48	37.650	1	078650801
M 50	37.650	1	078650802
L 52	37.650	1	078650803
XL 54	37.650	1	078650804
2XL 56	37.650	1	078650805
3XL 58	37.650	1	078650806
4XL 60	37.650	1	078650807
5XL 62	37.650	1	078650808

7905G

overall (munkaruha)
T/C vászon, 260 g/m², Oxford betétekkel,
szürke
Új kialakítás – jobb viselhetőség

CE

Beta EASY



IT	Ft		
XS 46	40.700	1	079050800
S 48	40.700	1	079050801
M 50	40.700	1	079050802
L 52	40.700	1	079050803
XL 54	40.700	1	079050804
2XL 56	40.700	1	079050805
3XL 58	40.700	1	079050806
4XL 60	40.700	1	079050807

7935MG

Overál, 97% pamut, 3% elasztikus szövet, 220 g/m²,
szürke

CE

Cotton



IT	Ft		
XS 46	46.550	1	079350400
S 48	46.550	1	079350401
M 50	46.550	1	079350402
L 52	46.550	1	079350403
XL 54	46.550	1	079350404
2XL 56	46.550	1	079350405
3XL 58	46.550	1	079350406



WORK JACKETS



7653G

sokszeseb, elasztikus munkadzseki
90% nejlon, 10% spandex, 260 g/m²,
antracitszürke

A KÉSZLET EREJÉIG!

CE



TOP line



Ft		
XS 41.900	1	076530000
S 41.900	1	076530001
M 41.900	1	076530002
L 41.900	1	076530003
XL 41.900	1	076530004
2XL 41.900	1	076530005
3XL 41.900	1	076530006

7849BL

T/C twill munkadzseki 245 g, kék
Elasztikus deréksáv

CE

Beta EASY



Ft		
XS 19.650	1	078490100
S 19.650	1	078490101
M 19.650	1	078490102
L 19.650	1	078490103
XL 19.650	1	078490104
XXL 19.650	1	078490105
XXXL 19.650	1	078490106
XXXXL 19.650	1	078490107



78696

munkadzseki, könnyített kivitel,
T/C twill, 180 g/m², Oxford betétekkel, szürke
Új kialakítás – jobb viselhetőség

CE **BetaEASY**

LIGHT



	Ft		
XS	25.700	1	078690800
S	25.700	1	078690801
M	25.700	1	078690802
L	25.700	1	078690803
XL	25.700	1	078690804
XXL	25.700	1	078690805
XXXL	25.700	1	078690806
XXXXL	25.700	1	078690807
5XL	25.700	1	078690808

7949

többszörös védelmet nyújtó munkadzseki,
T/C twill 250 g/m², kék,
hőálló, lángálló, elektromos ív, hegesztési
szikrák és vegyi anyagok elleni védelem.

CE

DPI: III^a Categoria
EN ISO 11611:2015 - Classe 1
EN ISO 11612:2015 - A1 B1 C1
EN 1149-5:2018
EN13034:2005+A1:2009 - Type 6
IEC 61482-2:2018 - APC 1



	Ft		
XS	43.900	1	079490000
S	43.900	1	079490001
M	43.900	1	079490002
L	43.900	1	079490003
XL	43.900	1	079490004
XXL	43.900	1	079490005
XXXL	43.900	1	079490006
XXXXL	43.900	1	079490007

764766

softshell munkamellény,
külső: 96% poliészter, 4% spandex, 280 g/m²;
belső: 100% poliészter grafénnal,
szürke/fekete
Hőszabályozó, víztaszító és szellőző

CE

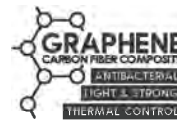

	Ft		
XS	33.400	1	076470010
S	33.400	1	076470011
M	33.400	1	076470012
L	33.400	1	076470013
XL	33.400	1	076470014
XXL	33.400	1	076470015
XXXL	33.400	1	076470016

79096

munkadzseki,
T/C vászon, 260 g/m², Oxford betétekkel,
szürke
Új kialakítás – jobb viselhetőség

CE **BetaEASY**



	Ft		
XS	28.950	1	079090800
S	28.950	1	079090801
M	28.950	1	079090802
L	28.950	1	079090803
XL	28.950	1	079090804
XXL	28.950	1	079090805
XXXL	28.950	1	079090806
XXXXL	28.950	1	079090807

SLEEVELESS JACKETS



7579QN

sokszébes munkamellény kétféle anyagból
100% 300D vízálló nejlón és softshell anyag,
96% poliészter, 4% spandex, poliészter
vattázás, 160 g/m²
fekete/antracitszürke

CE



	Ft		
S	33.200	1	075790201
M	33.200	1	075790202
L	33.200	1	075790203
XL	33.200	1	075790204
XXL	33.200	1	075790205
XXXL	33.200	1	075790206

7867B

Munkamellény, könnyített kivitel,
T/C twill anyagból, 180 g/m², Oxford
betétekkel, kék

CE

BetaEASY

LIGHT



	Ft		
XS	21.850	1	078670700
S	21.850	1	078670701
M	21.850	1	078670702
L	21.850	1	078670703
XL	21.850	1	078670704
XXL	21.850	1	078670705
XXXL	21.850	1	078670706
XXXXL	21.850	1	078670707
5XL	21.850	1	078670708

Beta

Beta

7867G

munkamellény, könnyített kivitel,
T/C twill, 180 g/m², Oxford betétekkel, szürke
Új kialakítás – jobb viselhetőség

CE

BetaEASY

LIGHT



Méret	Ft	1	078670800
XS	21.850	1	078670800
S	21.850	1	078670801
M	21.850	1	078670802
L	21.850	1	078670803
XL	21.850	1	078670804
XXL	21.850	1	078670805
XXXL	21.850	1	078670806
XXXXL	21.850	1	078670807
5XL	21.850	1	078670808

7907G

munkamellény,
T/C vászon, 260 g/m², Oxford betétekkel,
szürke
Új kialakítás – jobb viselhetőség

CE

BetaEASY

Méret	Ft	1	079070800
XS	24.300	1	079070800
S	24.300	1	079070801
M	24.300	1	079070802
L	24.300	1	079070803
XL	24.300	1	079070804
XXL	24.300	1	079070805
XXXL	24.300	1	079070806
XXXXL	24.300	1	079070807

7937MG

Munkamellény, 97% pamut, 3% elasztikus
szövet, 220 g/m², szürke

CE

Cotton



Méret	Ft	1	079370400
XS	24.700	1	079370400
S	24.700	1	079370401
M	24.700	1	079370402
L	24.700	1	079370403
XL	24.700	1	079370404
XXL	24.700	1	079370405
XXXL	24.700	1	079370406

JACKETS

**7648GG**

softshell munkadzseki, 96% poliészter, 4%
spandex, 310 g/m²
Belső: kétrétegű polár - 100% poliészter
grafénnal
Levehető kapucnival
Hőszabályozó, vízálló, szélálló, szellőző TPU
membránnal (vízállóság: max. 8 000 mm,
páraáteresztő képesség: 5 000 mvp)
Szürke/fekete

CE

GRAPHENE
CARBON FIBER COMPOSITE
ANTIBACTERIAL
TIGHT & STRONG
THERMAL CONTROL



Méret	Ft	1	076480010
XS	53.850	1	076480010
S	53.850	1	076480011
M	53.850	1	076480012
L	53.850	1	076480013
XL	53.850	1	076480014
XXL	53.850	1	076480015
XXXL	53.850	1	076480016

**Beta****7658CM**

softshell dzseki, 94% poliészter, 6%
spandex, 290 g/m², terepszínű szürke
Vízálló, szélálló, szellőző TPU membránnal
(vízállóság: max. 8 000 mm, páraáteresztő
képesség: 8 000 mvp)

A KÉSZLET EREJÉIG!

TOP line



Méret	Ft	1	076580100
S	52.650	1	076580101
M	52.650	1	076580102
L	52.650	1	076580103
XL	52.650	1	076580104
XXL	52.650	1	076580105
XXXL	52.650	1	076580106

7659N

softshell dzseki, 94% poliészter, 6%
spandex, 290 g/m², levehető kapucnival és
ujjakkal, fekete Vízálló, szélálló, szellőző
TPU membránnal (vízállóság: max. 8 000
mm, páraáteresztő képesség: 8 000 mvp)

A KÉSZLET EREJÉIG!

TOP line



Méret	Ft	1	076590000
S	67.600	1	076590001
M	67.600	1	076590002
L	67.600	1	076590003
XL	67.600	1	076590004
XXL	67.600	1	076590005
XXXL	67.600	1	076590006

7669N

sokszabes elasztikus munkadzseki, könnyített kivitel, 86% nejlón, 14% spandex, 140 g/m², fekete Levehető ujjakkal és kapucnival. Vízálló, szélálló

A KÉSZLET EREJÉIG!



TOP line



	Ft		
XS	47.150	1	076690000
S	47.150	1	076690001
M	47.150	1	076690002
L	47.150	1	076690003
XL	47.150	1	076690004
XXL	47.150	1	076690005
XXXL	47.150	1	076690006

7670G

Oxford 300D poliészter dzseki vízálló, PU-bevonatú, antracitszürke Levehető kapucnival és erősített ujjakkal. Vízálló, szélálló és szellőző (vízállóság: max. 2 000 mm, páraáteresztő képesség: 2 000 mvp) 210T poliészter bélés, poliészter vattázás, törzsrés: 120 g/m², ujjak: 100 g/m²

A KÉSZLET EREJÉIG!

CE

TOP line



	Ft		
S	47.150	1	076700001
M	47.150	1	076700002
L	47.150	1	076700003
XL	47.150	1	076700004
XXL	47.150	1	076700005
XXXL	47.150	1	076700006

76796G

munkadzseki grafén béléssel, 80 g/m² Elöl és hátul: 100% 75D poliészter Oldalak és ujjak: 96% poliészter, 4% spandex Hőszabályozó, vízálló, szélálló és szellőző (vízállóság: max. 8 000 mm, páraáteresztő képesség: 5 000 mvp) Szürke/fekete

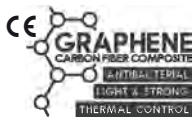

	Ft		
XS	44.100	1	076790010
S	44.100	1	076790011
M	44.100	1	076790012
L	44.100	1	076790013
XL	44.100	1	076790014
XXL	44.100	1	076790015
XXXL	44.100	1	076790016

7780QN

bomber munkadzseki, sokszabes

A KÉSZLET EREJÉIG!

CE



	Ft		
S	56.050	1	077800201
M	56.050	1	077800202
L	56.050	1	077800203
XL	56.050	1	077800204
XXL	56.050	1	077800205
XXXL	56.050	1	077800206

7750N

bomber munkadzseki, sokszabes, 100% poliészter, 100% poliészter vattázás, 120 g/m², fekete

CE



	Ft		
XS	35.400	1	077500000
S	35.400	1	077500001
M	35.400	1	077500002
L	35.400	1	077500003
XL	35.400	1	077500004
XXL	35.400	1	077500005
XXXL	35.400	1	077500006
XXXXL	35.400	1	077500007

SWEATSHIRT & FLEECE



7636N

mikropolár pulóver rövid cipzárral, 180 g/m² fekete, fényvisszaverő részekkel



	Ft		
XS	11.550	1	076360500
S	11.550	1	076360501
M	11.550	1	076360502
L	11.550	1	076360503
XL	11.550	1	076360504
XXL	11.550	1	076360505
XXXL	11.550	1	076360506



7637B

kapucnis felső, hosszú cipzáras, 250 g/m²
100% poliészter polár, 100D softshell anyag
betétekkel, kétrétegű polár 270 g/m²
kék/fekete



	Ft		
XS	37.450	1	076370100
S	37.450	1	076370101
M	37.450	1	076370102
L	37.450	1	076370103
XL	37.450	1	076370104
XXL	37.450	1	076370105
XXXL	37.450	1	076370106

7637G

hosszú ujjú, kapucnis felső, hosszú cipzáras,
250 g/m²
polár, 100% poliészter, 100D softshell anyagú
betétek, kötött polár, 270 g/m²
melanzs szürke/fekete



	Ft		
XS	37.450	1	076370000
S	37.450	1	076370001
M	37.450	1	076370002
L	37.450	1	076370003
XL	37.450	1	076370004
XXL	37.450	1	076370005
XXXL	37.450	1	076370006

7642G

kerek nyakú, hosszú ujjú felső, 240 g/m²,
60% pamut, 40% poliészter,
melange szürke – fekete betétekkel



	Ft		
XS	14.150	1	076420000
S	14.150	1	076420001
M	14.150	1	076420002
L	14.150	1	076420003
XL	14.150	1	076420004
XXL	14.150	1	076420005
XXXL	14.150	1	076420006

7643G

Rövid cipzáras hosszú ujjú felső, 80% pamut,
20% poliészter, 280 g/m², antracit/világos
szürke



	Ft		
XS	21.650	1	076430000
S	21.650	1	076430001
M	21.650	1	076430002
L	21.650	1	076430003
XL	21.650	1	076430004
XXL	21.650	1	076430005
XXXL	21.650	1	076430006

7644GG

stretch felső, hosszú cipzáras, 280 g/m²,
60% pamut, 40% poliészter grafénnal
szürke
Hőszabályozó, szellőző, könnyen kezelhető

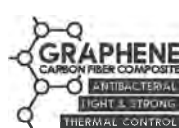

	Ft		
XS	29.750	1	076440010
S	29.750	1	076440011
M	29.750	1	076440012
L	29.750	1	076440013
XL	29.750	1	076440014
XXL	29.750	1	076440015
XXXL	29.750	1	076440016

7654B

elasztikus mikropolár pulóver rövid cipzárral,
180 g/m², kék
95% poliészter, 5% spandex

A KÉSZLET EREJÉIG!



	Ft		
XS	20.050	1	076540100
S	20.050	1	076540101
M	20.050	1	076540102
L	20.050	1	076540103
XL	20.050	1	076540104
XXL	20.050	1	076540105
XXXL	20.050	1	076540106

7654N

elasztikus mikropolár pulóver rövid cipzárral,
180 g/m², fekete 95% poliészter, 5% spandex

A KÉSZLET EREJÉIG!



	Ft		
XS	20.050	1	076540000
S	20.050	1	076540001
M	20.050	1	076540002
L	20.050	1	076540003
XL	20.050	1	076540004
XXL	20.050	1	076540005
XXXL	20.050	1	076540006

7657B

elasztikus polár pulóver hosszú cipzárral, 280
g/m², kék
95% poliészter, 5% spandex

A KÉSZLET EREJÉIG!



	Ft		
XS	25.700	1	076570100
S	25.700	1	076570101
M	25.700	1	076570102
L	25.700	1	076570103
XL	25.700	1	076570104
XXL	25.700	1	076570105
XXXL	25.700	1	076570106



7657N

elasztikus polár pulóver hosszú cipzárral, 280 g/m², fekete
95% poliészter, 5% spandex

A KÉSZLET EREJÉIG!

Méret	Ft	1	10
XS	25.700	1	076570000
S	25.700	1	076570001
M	25.700	1	076570002
L	25.700	1	076570003
XL	25.700	1	076570004
XXL	25.700	1	076570005
XXXL	25.700	1	076570006

7664N

hosszú ujjú felső, hosszú cipzáras, 280 g/m², fekete 60% pamut, 40% poliészter

A KÉSZLET EREJÉIG!

Méret	Ft	1	10
XS	23.500	1	076640000
S	23.500	1	076640001
M	23.500	1	076640002
L	23.500	1	076640003
XL	23.500	1	076640004
XXL	23.500	1	076640005
XXXL	23.500	1	076640006

7665N

hosszú ujjú kapucnis felső, hosszú cipzáras, 280 g/m², fekete
60% pamut, 40% poliészter

A KÉSZLET EREJÉIG!

Méret	Ft	1	10
XS	25.100	1	076650000
S	25.100	1	076650001
M	25.100	1	076650002
L	25.100	1	076650003
XL	25.100	1	076650004
XXL	25.100	1	076650005
XXXL	25.100	1	076650006

SHIRT & T-SHIRT**7545F**

kockás flanel munkaing, 100% pamut, 190 g/m²



Méret	Ft	1	10
XS	17.800	1	075450200
S	17.800	1	075450201
M	17.800	1	075450202
L	17.800	1	075450203
XL	17.800	1	075450204
XXL	17.800	1	075450205
XXXL	17.800	1	075450206

7548M

Modern nyomatú póló, 100% pamut, 150 g/m²

A KÉSZLET EREJÉIG!

Méret	Ft	1	10
XS	11.150	1	075480400
S	11.150	1	075480401
M	11.150	1	075480402
L	11.150	1	075480403
XL	11.150	1	075480404
XXL	11.150	1	075480405
XXXL	11.150	1	075480406

7548C

Klasszikus nyomatú póló, 100% pamut, 150 g/m²

A KÉSZLET EREJÉIG!

Méret	Ft	1	10
XS	11.150	1	075480500
S	11.150	1	075480501
M	11.150	1	075480502
L	11.150	1	075480503
XL	11.150	1	075480504
XXL	11.150	1	075480505
XXXL	11.150	1	075480506

7550G

munkapóló, poliészter, 120 g/m², 37.5° technológia, szürke – fekete, narancs és fényvisszaverő betétekkel



Méret	Ft	1	10
XS	18.000	1	075500400
S	18.000	1	075500401
M	18.000	1	075500402
L	18.000	1	075500403
XL	18.000	1	075500404
XXL	18.000	1	075500405
XXXL	18.000	1	075500406

7550N

munkapóló, poliészter, 120 g/m², 37.5° technológia, fekete – szürke, narancs és fényvisszaverő betétekkel



Méret	Ft	1	10
XS	18.000	1	075500500
S	18.000	1	075500501
M	18.000	1	075500502
L	18.000	1	075500503
XL	18.000	1	075500504
XXL	18.000	1	075500505
XXXL	18.000	1	075500506



7552BL

Három gombos munka pólóing, piqué pamut, 200 g/m³, kék



	Ft		
XS	8.260	2	075520300
S	8.260	2	075520301
M	8.260	2	075520302
L	8.260	2	075520303
XL	8.260	2	075520304
XXL	8.260	2	075520305
XXXL	8.260	2	075520306

7553BL

„Work” póló, pamutdszörzé, 150 g/m², kék



	Ft		
XS	5.590	5	075530300
S	5.590	5	075530301
M	5.590	5	075530302
L	5.590	5	075530303
XL	5.590	5	075530304
XXL	5.590	5	075530305
XXXL	5.590	5	075530306

7553V

„Work” póló pamutdszörzé, 150 g/m², zsályazöld



	Ft		
XS	5.590	5	075530600
S	5.590	5	075530601
M	5.590	5	075530602
L	5.590	5	075530603
XL	5.590	5	075530604
XXL	5.590	5	075530605
XXXL	5.590	5	075530606

7552G

Három gombos pólóing, pamut, 200 g/m², melanzs szürke



	Ft		
XS	8.260	2	075520500
S	8.260	2	075520501
M	8.260	2	075520502
L	8.260	2	075520503
XL	8.260	2	075520504
XXL	8.260	2	075520505
XXXL	8.260	2	075520506

7553G

„Work” póló, pamutdszörzé, 150 g/m², melanzs szürke



	Ft		
XS	5.590	5	075530400
S	5.590	5	075530401
M	5.590	5	075530402
L	5.590	5	075530403
XL	5.590	5	075530404
XXL	5.590	5	075530405
XXXL	5.590	5	075530406

**7971B**

Vízálló esőnadrág

CE



EN 343

7552N

Három gombos pólóing, piqué pamut, 200 g/m², fekete



	Ft		
XS	8.260	2	075520400
S	8.260	2	075520401
M	8.260	2	075520402
L	8.260	2	075520403
XL	8.260	2	075520404
XXL	8.260	2	075520405
XXXL	8.260	2	075520406

7553N

„Work” munkapóló, pamutdszörzé, 150 g/m², fekete



	Ft		
XS	5.590	5	075530500
S	5.590	5	075530501
M	5.590	5	075530502
L	5.590	5	075530503
XL	5.590	5	075530504
XXL	5.590	5	075530505
XXXL	5.590	5	075530506

	Ft		
XS	9.800	1	079710200
S	9.800	1	079710201
M	9.800	1	079710202
L	9.800	1	079710203
XL	9.800	1	079710204
XXL	9.800	1	079710205
XXXL	9.800	1	079710206

7978B

Vízálló esőkabát

CE



EN 343

	Ft		
XS	15.400	1	079780200
S	15.400	1	079780201
M	15.400	1	079780202
L	15.400	1	079780203
XL	15.400	1	079780204
XXL	15.400	1	079780205
XXXL	15.400	1	079780206

**UNDERWEAR****7996N**

technikai alöltöző szett - póló, hosszú ujjú + alsónadrág, 92% poliészter, 8% spandex, 160 g/m², fekete



	Ft		
XS-S	18.200	1	079960000
M-L	18.200	1	079960002
XL-XXL	18.200	1	079960004

7997GN

stretch alöltöző (felső) 70% poliamid, 28% poliészter grafénnal, 2% elasztán, 230 g/m²
Fekete, szürke betétekkel
Hőszabályozó, szellőző



	Ft		
XS-S	17.600	1	079970000
M-L	17.600	1	079970002
XL-XXL	17.600	1	079970004

7998GN

stretch alöltöző nadrág, 70% poliamid, 28% poliészter grafénnal, 2% elasztán, 230 g/m²
Fekete, szürke betétekkel
Hőszabályozó, szellőző

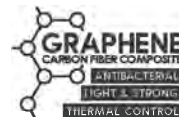

	Ft		
XS-S	13.750	1	079980000
M-L	13.750	1	079980002
XL-XXL	13.750	1	079980004





ACCESSORIES

7800G

Térdvédő (pár) munkaruházathoz



7800G	Ft	1	078000500
	6.560		

7980L

Téli sapka újratölthető LED lámpával, 100% akril, LED lámpa 3 fényerősség beállítással, max. 60 lumen egységes méret, fekete

- USB csatlakozóval tölthető
- Lámpa fényerősség: max. 60 lumen
- Töltési idő: 80 perc
- Elem üzemidő: 85 ± 290 perc



7980L	Ft	10	079800200
	6.280		

7980NC

polár téli sapka, 100% poliészter, kifordítható, terepszínű fekete



7980NC	Ft	10	079800112
	5.750		

7980RN

kötött téli sapka, 100% akril, 3M Thinsulate™ bélés, egy méretben fekete



7980RN	Ft	10	079800120
	5.380		

7981N

vízhatlan sapka, 100% PU-val bevont nylon, vízlepergetővel kezelt



	Ft	1	079810158
L = Ø 58 cm	9.390		
XL = Ø 60 cm	9.390	1	079810160

7982N

Sapka, 100% poliészter, tépőzáras, fekete



7982N	Ft	10	079820000
	4.410		

7984G

öv, 100% TPE, horgany kromátozott fémcsat, egy méretben: 125 cm, rövidíthető, szélesség 35 mm, fekete



7984G	Ft	1	079840525
	7.650		

7985N

mikropolár nyakmelegítő behúzó zsinórral sapkaként is használható, fekete, szürke és fényvisszaverő betétekkel



7985N	Ft	10	079850000
	5.380		

7104 90

műanyag terelőoszlop tölthető talppal



7104 90	H mm	Ft	4	071040004
	90	11.950		

7105 6

műanyag zárólánc



7105 6	Ø mm	L m	Ft	1	071050006
	6	25	28.950		

7109A

alumínium figyelmeztető tábla



	H mm	Ft	1	
7109A 1	140	5.020	1	071090001
7109A 2	140	5.020	1	071090002
7109A 3	140	5.020	1	071090003
7109A 4	140	5.020	1	071090004

7109D

tiltó tábla



	H mm	Ft	1	
7109D 1	115	5.020	1	071090051
7109D 2	115	5.020	1	071090052
7109D 3	115	5.020	1	071090053



7061TC

Védőszemüveg polikarbonát üveggel

CE EASY

EN166:2001
EN170
2C-1.2 1F



7061TC Ft 4.210 1 070610001

7076BC

Védőszemüveg polikarbonát üveggel

CE SPORT

EN166:2001
EN172
5-1.7 1F



7076BC Ft 9.680 1 070760009

7076BD

Védőszemüveg sötét polikarbonát üveggel

CE SPORT

EN166:2001
EN172
5-3.1 1F



7076BD Ft 9.680 1 070760019

7076BP

Védőszemüveg sötét fényszűrő polikarbonát üveggel

CE SPORT

EN ISO 12312-1:2013+A1:2015
EN 1836
3P



7076BP Ft 15.400 1 070760029

7076BU

védőszemüveg polikarbonát üveggel

CE

EN ISO 12311:2013
UV 500



7076BU Ft 7.940 1 070760039

7093BC

Védőszemüveg polikarbonát üveggel

CE IMPACT

EN166:2001
EN170
2C-1.2 1F



7093BC Ft 14.550 1 070930009

7093BD

Védőszemüveg sötét polikarbonát üveggel

CE IMPACT

EN166:2001
EN172
5-3.1 1F



7093BD Ft 14.550 1 070930019



C62M/WW

Próbababa, fém talp



185 cm

C62M/WW Ft 111.700 1 062000362

C64

ruházat és lábbeli bemutatóállvány, üres



2400 mm

560 mm

L	Ft	1	064000021
1 m	626.500	1	064000021
2 m	1.134.200	1	064000022
3 m	1.641.900	1	064000023
4 m	2.149.600	1	064000024

C64G

ruházat és lábbeli bemutató gondola, üres

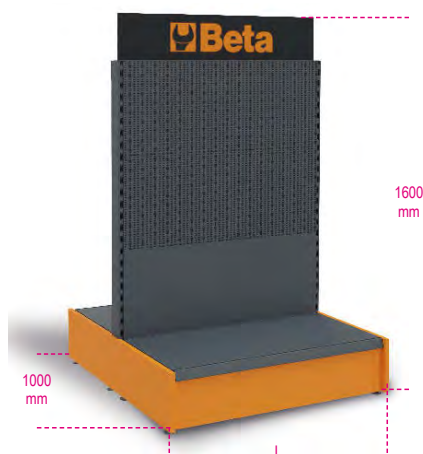

L	Ft	1	064000051
1 m	770.000	1	064000051
2 m	1.396.400	1	064000052

C64CW

öltöző



C64CW	Ft	1	064000610
	266.400	1	064000610

6200AP/S10

10 darab ruhafogas



6200AP/S10	Ft	1	062000331
	19.250	1	062000331

6800BA

vállfartató rúd a C64 típusú bemutatóállványhoz



6800BA	Ft	1	068000130
	55.850	1	068000130

6800RS

cipőtartó a C64 típusú bemutatóállványhoz



6800RS	Ft	1	068000135
	48.150	1	068000135

6888GS

cipőtartó a C64 típusú bemutatóállványhoz



6888GS	Ft	2	068880122
170x120 mm	11.950	2	068880122

6888GW

akasztó a C64 típusú bemutatóállványhoz



6888GW	Ft	2	068880121
400 mm	3.340	2	068880121

9562TB

cipő szőnyeg, csúszásmentes, gumibevonátú alsórész



9562TB	L mm	H mm	Ft	1	095620500
	800	600	22.050	1	095620500

9565S

lemezacél hordószék kivehető műbőrrel



9565S	H cm	ø cm	Ft	1	095650300
	60	38	97.550	1	095650300

Beta



Robur

A Robur 1930 óta gyárt a Beta Utensili elismert minőségi szabványainak megfelelő kábel szerelvényeket.

A piac követelményeinek és elvárásainak átfogó ismeretéből adódó szakértelem, szervezettség és technológia a folyamatos növekedés kulcsa.

1984 óta a Robur legmodernebb, minden igényt kielégítő gyártóbázisa Sulmona.



Bliszteres csomagolás

MEGENGEDETT TERHELÉS

WLL: Maximális üzemi terhelhetőség (emelő szerkezetnél)

WFL: Üzemi terhelhetőség (nem emelő szerkezetnél)

BF: statikus terhelhetőség

LC: húzó erő

Új termék 2025

8143SL

Kézi láncos emelő önzáró horoggal

CE



EN12157
Műszaki adatok:
• Biztonsági együttható: 4
• Sorozatszámot tartalmazó azonosító címke

Tanúsítványok:
• Gyártói tanúsítvány
• CE megfelelőségi nyilatkozat
• Vizsgálati jelentés 2.2 UNI EN10204
• Műszaki termékspecifikáció

Méret

Egységár

WLL	t	L m	sforzo / effort kg	Ft		
1	3	44	132.500	1	081430310	
2	3	44	174.400	1	081430320	
				177.200	1	081430410
				230.000	1	081430420

Egységcsomag

Cikkszám

NAGY SZAKÍTÓSZILÁRDSÁGÚ FESZÍTŐSZERELVÉNYEK

A **Robur** nagy szakítószilárdságú feszítőszerelvényeit úgy tervezték, hogy **strukturális alkalmazásokban**, például merevítésekben, feszített szerkezetekben és rögzítő rendszerekben megfelelő feszültséget biztosítsanak a kábeleknak és huzaloknak. Emellett terhek mozgatásához emelőrendszerekben is használatosak.

A nagy **mechanikai ellenállás**, az **5:1 biztonsági együttható**, a felületeket az időjárás viszontagságaitól védő **tűzhorganyzás**, a **kiváló minőségű acél**, valamint a testek és csatlakozók hőkezelése miatt a nagy szakítószilárdságú feszítőszerelvények **minden munkához elengedhetetlenek**, ahol a **biztonság elsődleges szempont**.



Különleges csomagolások szabad szolgáltatáshoz



ØxE "		Ft		
3/8x6	1	7.000	1	081059010
1/2x9	1	14.150	1	081059012

8109

Mindkét oldalon kengyeles feszítőszerelvény, horganyzott

CE

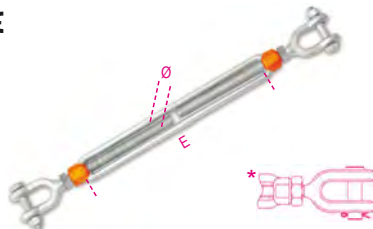

MŰSZAKI ADATOK

- Min. biztonsági koefficiens: 5
 - Feszítőszerelvényanya hőkezelése: normál hőkezelés
 - Feszítőszerelvény kengyelek hőkezelése: díjazás ellenében
- LABORELEMZÉSEK**
- Kémiai elemzés
 - Szakítópróba
- RENDELKEZÉSRE ÁLLÓ TANÚSÍTVÁNYOK**
- Termékleírás
 - Vizsgálati jelentés 2.2 UNI EN10204

ØxE "	≈ mm	WLL kg	Ft		
3/8x6	M10x150	540	8.340	5	081090010
1/2x6	M12x150	1000	13.750	5	081090011
1/2x9	M12x230	1000	16.400	5	081090012
1/2x12	M12x300	1000	20.850	5	081090013
5/8x6	M16x150	1590	25.100	2	081090015
5/8x9	M16x230	1590	29.750	2	081090016
5/8x12	M16x300	1590	33.400	2	081090017
3/4x6	M20x150	2360	35.200	2	081090018
3/4x9	M20x230	2360	40.700	2	081090020
3/4x12	M20x300	2360	45.350	2	081090019
3/4x18	M20x460	2360	54.050	2	081090021
7/8x12	M22x300	3270	68.200	1	081090022
7/8x18	M22x460	3270	82.400	1	081090023
1x6	M24x150	4540	67.400	1	081090024
1x12	M24x300	4540	96.950	1	081090025
1x18	M24x460	4540	111.700	1	081090026
* 1.1/4x12	M33x300	6900	157.100	1	081090031
* 1.1/4x18	M33x460	6900	176.500	1	081090032
* 1.1/4x24	M33x610	6900	244.500	1	081090033
* 1.1/2x12	M39x300	9710	227.900	1	081090034
* 1.1/2x18	M39x460	9710	261.100	1	081090038
* 1.1/2x24	M39x610	9710	312.600	1	081090039
* 1.3/4x18	M45x460	12700	380.200	1	081090036

Különleges csomagolások szabad szolgáltatáshoz



ØxE "		Ft		
3/8x6	1	8.910	1	081099010
1/2x9	1	17.000	1	081099012



8105

Mindkét oldalon szemes feszítőszerelvény, horganyzott

CE



MŰSZAKI ADATOK

- Min. biztonsági koefficiens: 5
 - Feszítőszerelvényanya hőkezelése: normál hőkezelés
 - Feszítőszerelvény szemek hőkezelése: díjazás ellenében
- LABORELEMZÉSEK**
- Kémiai elemzés
 - Szakítópróba
- RENDELKEZÉSRE ÁLLÓ TANÚSÍTVÁNYOK**
- Termékleírás
 - Vizsgálati jelentés 2.2 UNI EN10204

ØxE "	≈ mm	WLL kg	Ft		
3/8x6	M10x150	540	6.400	5	081050010
1/2x6	M12x150	1000	10.500	5	081050011
1/2x9	M12x230	1000	13.550	5	081050012
5/8x6	M16x150	1590	16.200	2	081050014
5/8x9	M16x230	1590	20.050	2	081050016
5/8x12	M16x300	1590	24.100	2	081050015
3/4x6	M20x150	2360	25.900	2	081050017
3/4x9	M20x230	2360	30.150	2	081050020
3/4x12	M20x300	2360	35.800	2	081050018
3/4x18	M20x460	2360	47.150	2	081050021
7/8x12	M22x300	3270	50.800	1	081050022
1x6	M24x150	4540	53.850	1	081050024
1x12	M24x300	4540	77.550	1	081050025
1x18	M24x460	4540	91.100	1	081050026
1.1/4x12	M33x300	6900	132.400	1	081050031
1.1/4x18	M33x460	6900	136.400	1	081050032
1.1/4x24	M33x610	6900	185.000	1	081050033
1.1/2x12	M39x300	9710	163.600	1	081050034
1.1/2x18	M39x460	9710	198.800	1	081050035
1.3/4x18	M45x460	12700	300.800	1	081050036



8110

kengyeles-szemes feszítőszerelvény, nagy szakítószilárdságú horganyzott acél

CE



MŰSZAKI ADATOK

- biztonsági együttható: 5
 - feszítőszerelvényanya hőkezelése: normál hőkezelés
 - feszítőszerelvény szemek hőkezelése: edzés és lágyítás
 - azonosító kód
- LABORATÓRIUMI TESZTEK**
- vegylelemzés
 - szakítópróba
- TANÚSÍTVÁNYOK**
- Műszaki termékspecifikáció
 - Vizsgálati jelentés 2.2 UNI EN10204
 - Ellenőrző tanúsítvány 3.1 UNI EN10204
 - CE megfelelési nyilatkozat

ØxE "	≈ mm	WLL kg	Ft		
3/8x6	M10x150	540	7.570	5	081100004
1/2x6	M12x150	1000	11.950	5	081100006
1/2x9	M12x230	1000	14.950	5	081100010
5/8x6	M16x150	1590	20.850	2	081100014
5/8x9	M16x230	1590	24.500	2	081100015
5/8x12	M16x300	1590	28.550	2	081100016
3/4x6	M20x150	2360	30.950	2	081100019
3/4x9	M20x230	2360	35.600	2	081100020
3/4x12	M20x300	2360	40.500	2	081100021
7/8x12	M22x300	3270	59.300	1	081100022
1x6	M24x150	4540	60.700	1	081100027
1x12	M24x300	4540	87.050	1	081100029
* 1.1/4x12	M33x300	6900	145.300	1	081100034
* 1.1/4x18	M33x460	6900	172.500	1	081100035
* 1.1/4x24	M33x610	6900	213.800	1	081100036
* 1.1/2x12	M39x300	9710	203.600	1	081100038
* 1.1/2x18	M39x460	9710	230.800	1	081100039
* 1.3/4x18	M45x460	12700	351.800	1	081100044

* Fokák átmenő és hasított csappal



FESZÍTŐSZERELVÉNYEK

A **Robur** bevált feszítőszerelvényeinek eredeti konstrukciója a pontos mérettűrés, a DIN 1480 szabványú modelleknél nagyobb szilárdság.

A gyártó és a termékeken található azonosító kód által garantált nyomkövethetőség miatt rendkívül népszerű az olasz tervezők és statikusok körében.

Az első osztályú, hat vegyértékű krómtól mentes egyenes galvanizálásnak köszönhetően az elemek tartósak és a szabadon álló elemek megjelenése tetszetős.



8005Z

Mindkét oldalon szemes feszítőszerelvény, galvanizált

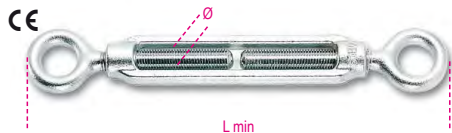

MŰSZAKI ADATOK

- Min. biztonsági koefficiens: 4
- LABORELEMZÉSEK
- Kémiai elemzés
- Szakítópróba
- RENDELKEZÉSRE ÁLLÓ TANÚSÍTVÁNYOK
- Termékleírás
- Vizsgálati jelentés 2.2 UNI EN10204
- * CE-Megfelelőségi nyilatkozat

Ø mm	≈	L min mm	WFL kg	Ft	📦	🏠
M5	3/16	118	115	1.070	400	080050105
M6	1/4	130	160	1.180	300	080050106
M8	5/16	158	300	1.800	200	080050108
M10	3/8	192	470	2.590	100	080050110
M11	7/16	206	580	3.380	80	080050111
M12	1/2	226	690	3.970	60	080050112
M14	9/16	256	940	5.430	15	080050114
M16	5/8	290	1290	8.180	10	080050116
M18	11/16	358	1660	11.950	1	080050118
M20	3/4	358	2130	13.550	60	080050120
M22	7/8	400	2630	18.600	1	080050122
M24	1"	436	3060	23.500	1	080050124
M27	1 1/8	474	4000	34.000	1	080050125
M30	1 3/16	498	4860	41.300	1	080050130
M33	1 1/4	516	6040	47.950	1	080050126
M36	1 3/8	532	6500	59.500	1	080050136
M39	1 1/2	544	7900	70.250	1	080050139

Speciális csomagolás



Ø mm	≈	📦	Ft	🏠	🏠
M5	3/16	30	36.050	1	080050705
M6	1/4	30	39.900	1	080050706
M8	5/16	20	40.550	1	080050708
M10	3/8	15	43.700	1	080050710
M11	7/16	15	57.050	1	080050711
M12	1/2	15	66.950	1	080050712

Különleges csomagolások szabad szolgálatához



Ø mm	📦	Ft	🏠	🏠
M5	2	2.510	1	080059305
M6	2	2.870	1	080059306
M8	1	2.390	1	080059108
M10	1	3.140	1	080059110
M11	1	4.090	1	080059111
M12	1	4.530	1	080059112
M14	1	5.870	1	080059114
M16	1	8.790	1	080059116

8005TZ

Mindkét oldalon szemes feszítőszerelvény, horganyzott



MŰSZAKI ADATOK

- Min. biztonsági koefficiens: 4
- LABORELEMZÉSEK
- Kémiai elemzés
- Szakítópróba
- RENDELKEZÉSRE ÁLLÓ TANÚSÍTVÁNYOK
- Termékleírás
- Vizsgálati jelentés 2.2 UNI EN10204
- CE-Megfelelőségi nyilatkozat

Ø mm	≈	WFL kg	Ft	📦	🏠
M12	1/2	690	5.380	15	080050512
M16	5/8	1290	9.270	1	080050516
M20	3/4	2130	13.350	1	080050520
M24	1"	3060	24.300	1	080050524
M27	1 1/8	4000	33.000	1	080050527
M30	1 3/16	4860	38.050	1	080050530
M36	1 3/8	6500	60.950	1	080050536

Különleges csomagolások szabad szolgálatához



Ø mm	📦	Ft	🏠	🏠
M12	1	6.400	1	080059512



Robur

8006Z

Feszítőszerelvény horoggal és szemmel, galvanizált

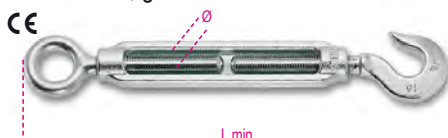

MŰSZAKI ADATOK

- Min. biztonsági koefficiens: 4
- LABORELEMZÉSEK
- Kémiai elemzés
- Szakítópróba
- RENDELKEZÉSRE ÁLLÓ TANÚSÍTVÁNYOK
- Termékleírás
- Vizsgálati jelentés 2.2 UNI EN10204
- * CE-Megfelelőségi nyilatkozat

Ø mm	≈	L min mm	WFL kg	Ft	📦	🏠
M5	3/16	121	25	1.140	400	080060105
M6	1/4	132	45	1.260	250	080060106
M8	5/16	170	95	1.900	180	080060108
M10	3/8	204	140	2.810	100	080060110
M11	7/16	221	165	3.680	15	080060111
M12	1/2	244	300	4.330	15	080060112
M14	9/16	284	420	6.230	10	080060114
M16	5/8	322	570	9.230	1	080060116
M18	11/16	373	700	13.350	1	080060118
M20	3/4	391	900	16.000	1	080060120
M22	7/8	433	1100	21.450	1	080060122
M24	1"	470	1300	28.750	1	080060124
M27	1 1/8	503	2300	39.250	1	080060127

Speciális csomagolás



Ø mm	≈	📦	Ft	🏠	🏠
M5	3/16	30	38.400	1	080060705
M6	1/4	30	42.350	1	080060706
M8	5/16	20	42.800	1	080060708
M10	3/8	15	47.500	1	080060710

Különleges csomagolások szabad szolgálatához



Ø mm	📦	Ft	🏠	🏠
M5	2	2.850	1	080069305
M6	2	3.180	1	080069306
M8	1	2.430	1	080069108
M10	1	3.320	1	080069110
M11	1	4.250	1	080069111
M12	1	4.820	1	080069112
M14	1	6.920	1	080069114

8007Z

Mindkét oldalon horgos feszítőszerelvény, galvanizált

CE

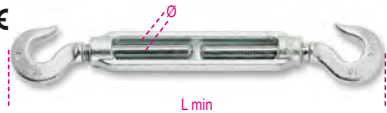

MŰSZAKI ADATOK

- Min. biztonsági koeficiens: 4
- LABORELEMZÉSEK
- Kémiai elemzés
- Szakítópróba
- RENDELKEZÉSRE ÁLLÓ TANÚSÍTVÁNYOK
- Termékleírás
- Vizsgálati jelentés a 2.2 UNI EN10204
- CE-Megfelelőségi nyilatkozat

Ø mm	≈	L min mm	WFL kg	Ft	📦	🚚
M5	3/16	124	25	1.200	30	080070105
M6	1/4	134	45	1.320	30	080070106
M8	5/16	181	95	2.000	20	080070108
M10	3/8	211	140	3.040	15	080070110
M11	7/16	231	165	3.970	15	080070111
M12	1/2	262	300	4.780	15	080070112
M14	9/16	312	420	7.090	1	080070114
M16	5/8	354	570	10.100	1	080070116
M18	11/16	388	700	14.550	1	080070118
M20	3/4	424	900	18.600	1	080070120
M22	7/8	466	1100	24.100	1	080070122
M24	1"	504	1300	34.000	1	080070124
M27	1 1/8	532	2300	44.350	1	080070127

Különleges csomagolások szabad szolgálatához



Ø mm	≈	Ft	📦	🚚
M5	2	2.980	1	080079305
M6	2	3.180	1	080079306
M8	1	2.410	1	080079108
M10	1	3.260	1	080079110
M11	1	4.410	1	080079111
M12	1	5.220	1	080079112

8008N

Mindkét oldalon toldatos feszítőszerelvény, természetes színű

CE

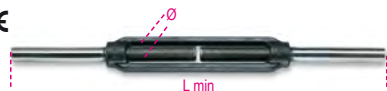

MŰSZAKI ADATOK

- Min. biztonsági koeficiens: 4
- LABORELEMZÉSEK
- Kémiai elemzés
- Szakítópróba
- RENDELKEZÉSRE ÁLLÓ TANÚSÍTVÁNYOK
- Termékleírás
- Vizsgálati jelentés a 2.2 UNI EN10204
- CE-Megfelelőségi nyilatkozat

Ø mm	≈	L min mm	WFL kg	Ft	📦	🚚
M5	3/16	160	115	1.050	30	080080205
M6	1/4	180	160	1.160	30	080080206
M8	5/16	210	300	1.600	20	080080208
M10	3/8	250	470	2.170	15	080080210
M12	1/2	280	690	3.200	15	080080212
M14	9/16	340	940	4.490	5	080080214
M16	5/8	380	1290	6.070	5	080080216
M18	11/16	410	1660	8.990	3	080080218
M20	3/4	440	2130	10.700	3	080080220
M22	7/8	480	2630	13.350	2	080080222
M24	1"	520	3060	17.400	2	080080224
M27	1 1/8	560	4000	27.100	1	080080227
M30	1 1/4	600	4860	34.000	1	080080230
M33	1 1/4	600	6040	36.450	1	080080233
M36	1 3/8	600	6500	47.150	1	080080236
M39	1 1/2	600	7900	53.850	1	080080239

Különleges csomagolások szabad szolgálatához



Ø mm	≈	Ft	📦	🚚
M5	2	2.890	1	080089305
M6	2	2.940	1	080089306
M8	1	2.170	1	080089208
M10	1	2.850	1	080089210
M12	1	3.600	1	080089212
M14	1	5.020	1	080089214

8008TZN

kétcsonkos huzalfeszítő csőanya DIN 1478 fekete végződések, horganyzott test

CE



MŰSZAKI ADATOK

- biztonsági együttható: 4
- LABORELEMZÉSEK• vegyi elemzés• szakítópróba
- RENDELKEZÉSRE ÁLLÓ TANÚSÍTVÁNYOK•
- Termékleírás• Vizsgálati jelentés a 2.2 UNI EN10204 szerint•
- EK Megfelelőségi nyilatkozat

Ø mm	≈	WFL kg	Ft	📦	🚚
M12	1/2	690	4.410	10	080080512
M16	5/8	1290	7.290	1	080080516
M20	3/4	2130	10.700	1	080080520
M24	1	3060	19.000	1	080080524
M27	1.1/8	4000	27.550	1	080080527
M30	1.3/16	4860	32.800	1	080080530
M36	1.3/8	6500	51.400	1	080080536

8009Z

Speciális csomagolások

CE

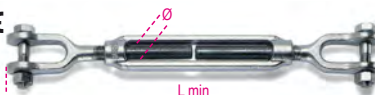

Ø mm	≈	Ft	📦	🚚	
M8	5/16	5	33.000	1	080090708
M10	3/8	5	39.600	1	080090710
M12	1/2	5	53.050	1	080090712

Különleges csomagolások szabad szolgálatához



Ø mm	≈	Ft	📦	🚚
M8	1	6.680	1	080099008
M10	1	7.610	1	080099010
M12	1	10.300	1	080099012

8009TZ

kétvillás, csőnyás feszítőszerelvény DIN 1478 horganyzott

CE



MŰSZAKI ADATOK

- biztonsági együttható: 4
- LABORELEMZÉSEK• vegyi elemzés• szakítópróba
- RENDELKEZÉSRE ÁLLÓ TANÚSÍTVÁNYOK•
- Termékleírás• Vizsgálati jelentés a 2.2 UNI EN10204 szerint•
- EK Megfelelőségi nyilatkozat

Ø mm	≈	WFL kg	Ft	📦	🚚
M12	1/2	690	10.500	10	080090512
M16	5/8	1290	16.400	1	080090516
M20	3/4	2130	23.500	1	080090520
M24	1	3060	39.250	1	080090524
M27	1.1/8	4000	59.300	1	080090527
M30	1.3/16	4860	74.300	1	080090530

Különleges csomagolások szabad szolgálatához



Ø mm	≈	Ft	📦	🚚
M12	1	10.500	1	080099512



8010Z

Feszítőszerelvény szemmel és kengyellel, galvanizált



MŰSZAKI ADATOK

- Min. biztonsági együttható: 4
- LABORELEMZÉSEK
- Kémiai elemzés
- Szakítópórá
- RENDELKEZÉSRE ÁLLÓ TANÚSÍTVÁNYOK
- Termékleírás
- Vizsgálati jelentés 2.2 UNI EN10204
- CE-Megfelelőségi nyilatkozat

Ø mm	≈	L min mm	WFL kg	Ft	📦	🚚
M8	5/16	175	300	3.850	20	080100008
M10	3/8	215	470	4.820	15	080100010
M12	1/2	250	690	6.720	10	080100012
M14	9/16	299	940	9.270	10	080100014
M16	5/8	331	1290	11.750	1	080100016
M18	11/16	382	1660	17.200	1	080100018
M20	3/4	382	2130	18.600	1	080100020
M22	7/8	433	2630	25.900	1	080100022
M24	1"	461	3060	30.950	1	080100024
M27	1 1/8	492	4000	47.150	1	080100027
M30	1 3/16	529	4860	59.500	1	080100030

Különleges csomagolások szabad szolgálatához



Ø mm	📦	Ft	🚚
M8	1	4.330	1
M10	1	5.340	1
M12	1	7.250	1
M14	1	10.300	1

8010TZ

szemes és villás huzalfeszítő csőanya DIN 1478 horganyzott



MŰSZAKI ADATOK

- biztonsági együttható: 4
- LABORELEMZÉSEK• vegyi elemzés• szakítópórá
- RENDELKEZÉSRE ÁLLÓ TANÚSÍTVÁNYOK•
- Termékleírás• Vizsgálati jelentés a 2.2 UNI EN10204 szerint•
- EK Megfelelőségi nyilatkozat

Ø mm	≈	WFL kg	Ft	📦	🚚
M12	1/2	690	7.890	10	080100612
M16	5/8	1290	12.950	1	080100616
M20	3/4	2130	18.400	1	080100620
M24	1	3060	31.550	1	080100624
M27	1.1/8	4000	46.150	1	080100627
M30	1.3/16	4860	56.050	1	080100630

8011Z

Horgos-kengyeles feszítőszerelvény, galvanizált



MŰSZAKI ADATOK

- biztonsági együttható: 4
- LABORATÓRIUMI TESZTEK
- vegyelemzés
- szakítópórá
- TANÚSÍTVÁNYOK
- Termékspecifikáció
- Vizsgálati jelentés 2.2 UNI EN10204
- CE Megfelelőségi nyilatkozat

Ø mm	≈	L min mm	WFL kg	Ft	📦	🚚
M12	1/2	270	300	6.070	1	080110112
M16	5/8	360	570	12.550	1	080110116
M20	3/4	420	900	20.650	1	080110120
M24	1"	490	1300	34.800	1	080110124
M27	1 1/8	500	2300	48.150	1	080110127

8011TZ

Horgos-kengyeles csőnyás feszítőszerelvény, DIN 1478, galvanizált



MŰSZAKI ADATOK

- biztonsági együttható: 4
- LABORATÓRIUMI TESZTEK
- vegyelemzés
- szakítópórá
- TANÚSÍTVÁNYOK
- Termékspecifikáció
- Vizsgálati jelentés 2.2 UNI EN10204
- CE Megfelelőségi nyilatkozat

Ø mm	≈	L min mm	WFL kg	Ft	📦	🚚
M12	1/2	260	300	6.960	1	080110612
M16	5/8	350	570	12.750	1	080110616
M20	3/4	400	900	19.450	1	080110620
M24	1"	490	1300	33.400	1	080110624
M27	1 1/8	500	2300	44.350	1	080110627

8001Z

Feszítőanya, galvanizált



MŰSZAKI ADATOK

- Min. biztonsági együttható: 4
- Gyártási száma
- LABORELEMZÉSEK
- Kémiai elemzés
- Szakítópórá
- RENDELKEZÉSRE ÁLLÓ TANÚSÍTVÁNYOK
- Termékleírás
- Vizsgálati jelentés 2.2 UNI EN10204
- CE-Megfelelőségi nyilatkozat

Ø mm	≈	L mm	WFL kg	Ft	📦	🚚
M5	3/16	80	115	640	100	080010105
M6	1/4	80	160	670	100	080010106
M8	5/16	105	300	1.060	25	080010108
M10	3/8	125	470	1.360	20	080010110
M11	7/16	135	580	1.680	15	080010111
M12	1/2	140	690	1.800	20	080010112
M14	9/16	170	940	2.530	15	080010114
M16	5/8	190	1290	3.460	15	080010116
M18	11/16	205	1660	5.470	10	080010118
M20	3/4	220	2130	6.320	10	080010120

Ø mm	≈	L mm	WFL kg	Ft	📦	🚚
M22	7/8	240	2630	8.020	8	080010122
M24	1"	260	3060	9.800	5	080010124
M27	1 1/8	270	4000	15.400	1	080010127
M30	1 3/16	280	4860	19.450	1	080010130
M33	1 1/4	290	6040	21.450	1	080010133
M36	1 3/8	300	6500	27.300	1	080010136
M39	1 1/2	300	7900	32.800	1	080010139

Különleges csomagolások szabad szolgálatához



Ø mm	📦	Ft	🚚
M5	2	1.940	1
M6	2	2.130	1
M8	1	1.680	1
M10	1	1.960	1
M11	1	2.370	1
M12	1	2.450	1
M14	1	3.260	1
M16	1	4.130	1
M18	1	6.150	1
M20	1	6.920	1
M22	1	8.740	1
M24	1	10.500	1

8001TZ

Feszítőanya, horganyzott



DIN 1478

MŰSZAKI ADATOK

- Min. biztonsági együttható: 4
- Gyártási száma
- LABORELEMZÉSEK
- Kémiai elemzés
- Szakítópórá
- RENDELKEZÉSRE ÁLLÓ TANÚSÍTVÁNYOK
- Termékleírás
- Vizsgálati jelentés 2.2 UNI EN10204
- CE-Megfelelőségi nyilatkozat

Ø mm	≈	L mm	WFL kg	Ft	📦	🚚
M12	1/2	125	690	2.980	10	080010512
M16	5/8	170	1290	4.530	5	080010516
M20	3/4	200	2130	6.030	5	080010520
M24	1	255	3060	10.500	3	080010524
* M27	1.1/8	255	4000	14.150	1	080010527
M30	1.3/16	255	4860	16.000	1	080010530
M36	1.3/8	295	6500	28.950	1	080010536
M42	1.5/8	330	9700	40.700	1	080010542

Különleges csomagolások szabad szolgálatához



Ø mm	📦	Ft	🚚
M12	1	3.580	1
M16	1	5.020	1
M20	1	6.560	1
M24	1	10.950	1



8002ZD

Feszítőcsavar szem, jobbmenetes, galvanizált

Feszítőcsavar szem, balmenetes



MŰSZAKI ADATOK

• Min. biztonsági együttható: 4

LABORELEMZÉSEK

- Kémiai elemzés
- Szakítópróba

RENDELKEZÉSRE ÁLLÓ TANÚSÍTVÁNYOK

- Termékleírás
- Vizsgálati jelentés 2.2 UNI EN10204

Ø mm	≈ "	E mm	WFL kg	Ft		
M5	3/16	37	115	220	200	080020105
M6	1/4	40	160	270	150	080020106
M8	5/16	52	300	400	100	080020108
M10	3/8	60	470	640	100	080020110
M11	7/16	65	580	905	1	080020111
M12	1/2	72	690	1.140	50	080020112
M14	9/16	85	940	1.400	1	080020114
M16	5/8	95	1290	2.370	1	080020116
M18	11/16	103	1660	3.460	1	080020118
M20	3/4	110	2130	3.870	1	080020120
M22	7/8	120	2630	5.670	1	080020122
M24	1"	130	3060	7.170	1	080020124
M27	1 1/8	135	4000	9.880	1	080020127
M30	1 3/16	140	4860	11.550	1	080020130
M33	1 1/4	148	6040	13.950	1	080020133
M36	1 3/8	150	6500	17.000	1	080020198
M39	1 1/2	150	7900	19.850	1	080020199

Ø mm	≈ "	E mm	WFL kg	Ft		
M5	3/16	37	115	220	1	080020305
M6	1/4	40	160	270	1	080020306
M8	5/16	52	300	400	1	080020308
M10	3/8	60	470	640	1	080020310
M11	7/16	65	580	905	1	080020311
M12	1/2	72	690	1.140	1	080020312
M14	9/16	85	940	1.400	1	080020314
M16	5/8	95	1290	2.370	1	080020316
M18	11/16	103	1660	3.460	1	080020318
M20	3/4	110	2130	3.870	1	080020320
M22	7/8	120	2630	5.670	1	080020322
M24	1"	130	3060	7.170	1	080020324
M27	1 1/8	135	4000	9.880	1	080020327
M30	1 3/16	140	4860	11.550	1	080020330
M33	1 1/4	148	6040	13.950	1	080020333
M36	1 3/8	150	6500	17.000	1	080020398
M39	1 1/2	150	7900	19.850	1	080020399



Robur

8003ZD

Feszítőcsavar horog, jobbmenetes, galvanizált

Feszítőcsavar szem, balmenetes



MŰSZAKI ADATOK

• Min. biztonsági együttható: 4

LABORELEMZÉSEK

- Kémiai elemzés
- Szakítópróba

RENDELKEZÉSRE ÁLLÓ TANÚSÍTVÁNYOK

- Termékleírás
- Vizsgálati jelentés 2.2 UNI EN10204

Ø mm	≈ "	E mm	WFL kg	Ft		
M5	3/16	40	25	295	150	080030105
M6	1/4	40	45	335	120	080030106
M8	5/16	52	95	495	100	080030108
M10	3/8	60	140	880	70	080030110
M11	7/16	65	165	1.200	1	080030111
M12	1/2	70	300	1.540	30	080030112
M14	9/16	85	420	2.370	1	080030114
M16	5/8	95	570	3.520	1	080030116
M18	11/16	103	700	4.740	1	080030118
M20	3/4	110	900	6.400	1	080030120
M22	7/8	120	1100	8.340	1	080030122
M24	1"	130	1300	12.750	1	080030124
M27	1 1/8	135	2300	15.200	1	080030127

Ø mm	≈ "	WFL kg	E mm	Ft		
M5	3/16	40	25	295	1	080030305
M6	1/4	40	45	335	1	080030306
M8	5/16	52	95	495	1	080030308
M10	3/8	60	140	880	1	080030310
M11	7/16	65	165	1.200	1	080030311
M12	1/2	70	300	1.540	1	080030312
M14	9/16	85	420	2.370	1	080030314
M16	5/8	95	570	3.520	1	080030316
M18	11/16	103	700	4.740	1	080030318
M20	3/4	110	900	6.400	1	080030320
M22	7/8	120	1100	8.340	1	080030322
M24	1"	130	1300	12.750	1	080030324
M27	1 1/8	135	2300	15.200	1	080030327



8004ND

Jobbmenetes feszítő szár, fekete

Kérésre balmenettel



MŰSZAKI ADATOK

Min. biztonsági együttható: 4

LABORELEMZÉSEK

- Kémiai elemzés
- Szakítópróba

RENDELKEZÉSRE ÁLLÓ TANÚSÍTVÁNYOK

- Termékleírás
- Vizsgálati jelentés 2.2 UNI EN10204

Ø mm	≈ "	E mm	WFL kg	Ft		
M5	3/16	40	115	230	1	080040005
M6	1/4	44	160	270	1	080040006
M8	5/16	53	300	320	1	080040008
M10	3/8	63	470	475	1	080040010
M12	1/2	70	690	790	1	080040012
M14	9/16	85	940	1.080	1	080040014
M16	5/8	95	1290	1.500	1	080040016
M18	11/16	103	1660	2.020	1	080040018
M20	3/4	110	2130	2.530	1	080040020
M22	7/8	120	2630	3.140	1	080040022
M24	1"	130	3060	4.450	1	080040024
M27	1 1/8	135	4000	7.130	1	080040027
M30	1 3/16	140	4860	8.830	1	080040030
M33	1 1/4	150	6040	9.070	1	080040033
M36	1 3/8	150	6500	11.950	1	080040098
M39	1 1/2	150	7900	12.950	1	080040099

Ø mm	≈ "	E mm	WFL kg	Ft		
M5	3/16	40	115	230	1	080040105
M6	1/4	44	160	270	1	080040106
M8	5/16	53	300	320	1	080040108
M10	3/8	63	470	475	1	080040110
M12	1/2	70	690	790	1	080040112
M14	9/16	85	940	1.080	1	080040114
M16	5/8	95	1290	1.500	1	080040116
M18	11/16	103	1660	2.020	1	080040118
M20	3/4	110	2130	2.530	1	080040120
M22	7/8	120	2630	3.140	1	080040122
M24	1"	130	3060	4.450	1	080040124
M27	1 1/8	135	4000	7.130	1	080040127
M30	1 3/16	140	4860	8.830	1	080040130
M33	1 1/4	150	6040	9.070	1	080040133
M36	1 3/8	150	6500	11.950	1	080040198
M39	1 1/2	150	7900	12.950	1	080040199



8009FD

Jobbmenetes feszítő szerelvény kengyeles
- horganyzott
Kérésre balmenettel



MŰSZAKI ADATOK

Min. biztonsági koefficiens: 4

LABORELEMZÉSEK

• Kémiai elemzés

• Szakítópróba

RENDELKEZÉSRE ÁLLÓ TANÚSÍTVÁNYOK

• Termékleírás

• Vizsgálati jelentés 2.2 UNI EN10204

Ø mm	≈ "	E mm	WFL kg	Ft		
M8	5/16	53	300	2.490	1	080090208
M10	3/8	63	470	2.940	1	080090210
M12	1/2	70	690	3.970	1	080090212
M14	9/16	85	940	5.470	1	080090214
M16	5/8	95	1290	6.230	1	080090216
M18	11/16	103	1660	8.830	1	080090218
M20	3/4	110	2130	9.070	1	080090220
M22	7/8	120	2630	12.950	1	080090222
M24	1"	130	3060	14.950	1	080090224
M27	1 1/8	135	4000	23.500	1	080090227
M30	1 3/16	140	4860	30.350	1	080090230

Ø mm	≈ "	WFL kg	G mm	Ft		
M8	5/16	53	300	2.490	1	080090408
M10	3/8	63	470	2.940	1	080090410
M12	1/2	70	690	3.970	1	080090412
M14	9/16	85	940	5.470	1	080090414
M16	5/8	95	1290	6.230	1	080090416
M18	11/16	103	1660	8.830	1	080090418
M20	3/4	110	2130	9.070	1	080090420
M22	7/8	120	2630	12.950	1	080090422
M24	1"	130	3060	14.950	1	080090424
M27	1 1/8	135	4000	23.500	1	080090427
M30	1 3/16	140	4860	30.350	1	080090430

8048

Szemes húzórudak, jobbmenetes,
természetes színű



UNI 6058

ØxL mm	WFL kg	F mm	E mm	Ft		
M8x50	430	6	39	1.560	20	080480108
M8x65	430	6	54	1.680	20	080480109
M10x80	690	8	66	2.610	10	080480110
M10x100	690	8	86	2.610	10	080480210
M10x130	690	8	116	2.940	10	080480111
M12x70	1020	10	53	2.690	8	080480212
M12x95	1020	10	78	2.750	8	080480112
M12x125	1020	10	108	3.380	8	080480113
M14x110	1420	12	91	3.810	6	080480114
M16x100	1980	14	79	3.140	6	080480115
M16x130	1980	14	109	3.260	6	080480116
M18x150	2390	16	126	7.330	2	080480118
M20x160	3100	18	134	9.070	2	080480120
M22x180	3890	18	152	14.150	1	080480122
M24x200	4460	20	168	16.200	1	080480124
M24x220	4460	20	188	17.400	1	080480125
M27x220	5900	22	185	21.250	1	080480127

8302Z

Speciális csomagolások



Ø mm	E mm	F mm	WFL kg	Ft		
M5	48	8	115	250	200	083020005
M6	55	10	160	305	150	083020006
M8	60	12	300	410	100	083020008
M10	73	14	470	700	100	083020010
M12	90	17	690	1.360	50	083020012



Ø mm	E mm	WFL kg	Ft		
M5	48	100	28.250	1	083020705
M6	55	75	25.600	1	083020706
M8	60	50	23.000	1	083020708
M10	73	50	39.400	1	083020710
M12	90	25	38.150	1	083020712

8303Z

Speciális csomagolások



Ø mm	C mm	E mm	WFL kg	Ft		
M5	6,0	48	25	295	120	083030005
M6	8,0	55	45	320	100	083030006
M8	10,0	60	95	520	75	083030008
M10	12,5	73	140	880	50	083030010
M12	16,0	90	220	1.480	20	083030012



Ø mm	C mm	WFL kg	Ft		
M5	6,0	60	19.950	1	083030705
M6	8,0	50	18.000	1	083030706
M8	10,0	30	17.600	1	083030708
M10	12,5	25	24.800	1	083030710
M12	16,0	10	16.600	1	083030712

8702N - 8702Z - 8702ZC

kengyel foglalat kovácsolt acélból

zárt
fekete



MŰSZAKI ADATOK

• azonosítókód

LABORATÓRIUMI TESZTEK

• vegyelemzés

• szakítópróba

TANÚSÍTVÁNYOK

• Műszaki termékspecifikáció

• Vizsgálati jelentés 2.2 UNI EN10204

• Ellenőrző tanúsítvány 3.1 UNI EN10204

M	ØB mm	ØA mm	ØD mm	Ft		
6	6,8	13	19	21.250	1	087020106
8	8,8	20	22	25.300	1	087020108
9	9,8	20	22	25.300	1	087020109
10	10,8	20	22	25.300	1	087020110
11	11,8	25	27	31.350	1	087020111
12	12,8	25	27	31.350	1	087020112
13	13,8	25	27	31.350	1	087020113
14	14,8	32	32	43.700	1	087020114
15	15,9	32	32	43.700	1	087020115
16	17,0	32	32	43.700	1	087020116
18	19,0	39	37	56.450	1	087020118
19	20,0	39	37	56.450	1	087020119
20	21,1	39	37	56.450	1	087020120
22	23,2	43	43	78.550	1	087020122
24	25,4	50	52	90.700	1	087020124
25	26,4	50	52	90.700	1	087020125
26	27,4	50	52	90.700	1	087020126

A kengyel kovácsolását megfelelő présgépen és
szerszámmal szakember végezheti.

8702Z horganyzott

M	ØB mm	ØA mm	ØD mm	Ft		
6	6,8	13	19	22.050	1	087020306
8	8,8	20	22	26.700	1	087020308
9	9,8	20	22	26.700	1	087020309
10	10,8	20	22	26.700	1	087020310
11	11,8	25	27	32.800	1	087020311
12	12,8	25	27	32.800	1	087020312
13	13,8	25	27	32.800	1	087020313
14	14,8	32	32	45.950	1	087020314
15	15,9	32	32	45.950	1	087020315
16	17,0	32	32	45.950	1	087020316
18	19,0	39	37	59.300	1	087020318
19	20,0	39	37	59.300	1	087020319
20	21,1	39	37	59.300	1	087020320
22	23,2	43	43	81.350	1	087020322
24	25,4	50	52	94.750	1	087020324
25	26,4	50	52	94.750	1	087020325
26	27,4	50	52	94.750	1	087020326

8702ZC tűzhorganyzott

M	ØB mm	ØA mm	ØD mm	Ft		
6	6,8	13	19	23.500	1	087020206
8	8,8	20	22	28.950	1	087020208
9	9,8	20	22	28.950	1	087020209
10	10,8	20	22	28.950	1	087020210
11	11,8	25	27	35.800	1	087020211
12	12,8	25	27	35.800	1	087020212
13	13,8	25	27	35.800	1	087020213
14	14,8	32	32	53.050	1	087020214
15	15,9	32	32	53.050	1	087020215
16	17,0	32	32	53.050	1	087020216
18	19,0	39	37	68.400	1	087020218
19	20,0	39	37	68.400	1	087020219
20	21,1	39	37	68.400	1	087020220
22	23,2	43	43	92.900	1	087020222
24	25,4	50	52	108.500	1	087020224
25	26,4	50	52	108.500	1	087020225
26	27,4	50	52	108.500	1	087020226

8709N - 8709Z - 8709ZC

kengyel foglalat kovácsolt acélból

nyitott

fekete



MŰSZAKI ADATOK

- azonosító kód
- LABORÁTORIUMI TESZTEK
- vegyelemzés
- szakítópróba
- TANÚSÍTVÁNYOK
- Műszaki termékspecifikáció
- Vizsgálati jelentés 2.2 UNI EN10204
- Ellenőrző tanúsítvány 3.1 UNI EN10204

M	Ø B mm	Ø A mm	Ø C mm	Ft		
6	6,8	13	17	28.950	1	087090106
8	8,8	20	21	37.450	1	087090108
9	9,8	20	21	37.450	1	087090109
10	10,8	20	21	37.450	1	087090110
11	11,8	25	25	46.750	1	087090111
12	12,8	25	25	46.750	1	087090112
13	13,8	25	25	46.750	1	087090113
14	14,8	32	30	65.200	1	087090114
15	15,9	32	30	65.200	1	087090115
16	17,0	32	30	65.200	1	087090116
18	19,0	39	35	84.600	1	087090118
19	20,0	39	35	84.600	1	087090119
20	21,1	39	35	84.600	1	087090120
22	23,2	43	41	108.100	1	087090122
24	25,4	50	51	110.900	1	087090124
25	26,4	50	51	110.900	1	087090125
26	27,4	50	51	110.900	1	087090126

A kengyel kovácsolását megfelelő présgépen és szerszámmal szakember végezheti.

8709Z horganyzott

M	Ø B mm	Ø A mm	Ø C mm	Ft		
6	6,8	13	17	29.750	1	087090306
8	8,8	20	21	39.250	1	087090308
9	9,8	20	21	39.250	1	087090309
10	10,8	20	21	39.250	1	087090310
11	11,8	25	25	48.800	1	087090311
12	12,8	25	25	48.800	1	087090312
13	13,8	25	25	48.800	1	087090313
14	14,8	32	30	68.400	1	087090314
15	15,9	32	30	68.400	1	087090315
16	17,0	32	30	68.400	1	087090316
18	19,0	39	35	88.650	1	087090318
19	20,0	39	35	88.650	1	087090319
20	21,0	39	35	88.650	1	087090320
22	23,2	43	41	116.200	1	087090322
24	25,4	50	51	116.200	1	087090324
25	26,4	50	51	116.200	1	087090325
26	27,4	50	51	116.200	1	087090326

8709ZC tűzhorganyzott

M	Ø B mm	Ø A mm	Ø C mm	Ft		
6	6,8	13	17	30.950	1	087090206
8	8,8	20	21	41.300	1	087090208
9	9,8	20	21	41.300	1	087090209
10	10,8	20	21	41.300	1	087090210
11	11,8	25	25	53.250	1	087090211
12	12,8	25	25	53.250	1	087090212
13	13,8	25	25	53.250	1	087090213
14	14,8	32	30	77.300	1	087090214
15	15,9	32	30	77.300	1	087090215
16	17,0	32	30	77.300	1	087090216
18	19,0	39	35	98.400	1	087090218
19	20,0	39	35	98.400	1	087090219
20	21,1	39	35	98.400	1	087090220
22	23,2	43	41	125.500	1	087090222
24	25,4	50	51	138.100	1	087090224
25	26,4	50	51	138.100	1	087090225
26	27,4	50	51	138.100	1	087090226

SZORÍTÓKENGYELEK

A professzionális szorítókegyelek különböző rögzítő és feszítő rendszerekkel együtt acélmagos acélsodrony kötélén is alkalmazhatók. A kereskedelmi forgalomban kapható számos termékkel ellentétben a Beta szorítókegyelei NEM öntöttvasból készülnek.

A szorítókegyelek alapja melegen kovácsolt és a hasonló termékekhez képest nehezebb, így optimális mechanikai teljesítményt nyújtanak még a nagy igénybevételt jelentő munkáknál is.

Az első osztályú, hat vegyértékű krómtól mentes galvanizálás jó korrózióállóságot és megjelenést biztosít.

A Beta több évtizedes története során ezek az ismertetőjegyek tették a 8016 modellt a Robur márka egyik ikonikus termékévé és az „olasz stílusú” szorítókegyeleket világszerte elismertté.



8015

szorítókegyel, amerikai típus, acél test, tűzhorganyzott

CE

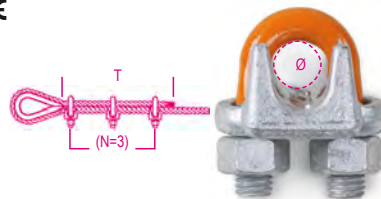

dimenziói EN 13411-5 tipo B

MŰSZAKI ADATOK

- azonosító kód
- LABORÁTORIUMI TESZTEK
- vegyelemzés
- torziós vizsgálat
- TANÚSÍTVÁNYOK
- Műszaki termékspecifikáció
- Vizsgálati jelentés 2.2 UNI EN10204
- Gyártói tanúsítvány UNI EN13411-5
- CE Megfelelőségi nyilatkozat

Ø mm	Ø "	NxT	Nm	Ft		
8	5/16	3x133	40,7	1.060	12	080150808
9-10	3/8	3x165	61	1.480	12	080150810
11-13	1/2	3x292	88	2.270	6	080150813
14-16	5/8	3x305	129	3.200	6	080150816
18-20	3/4	4x460	176	4.410	6	080150820
22	7/8	4x480	305	7.000	6	080150822
24-26	1	5x660	305	7.610	5	080150826
28-30	1-1/8	6x860	305	8.140	2	080150830

8016

Szorítókegyel acélból, galvanizált

CE

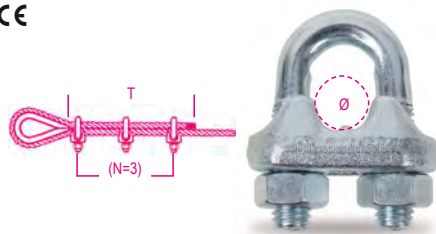

LABORELEMZÉSEK

- Kémiai elemzés
- Nyomaték teszt
- RENDELKEZÉSRE ÁLLÓ TANÚSÍTVÁNYOK
- Termékleírás
- Vizsgálati jelentés 2.2 UNI EN10204
- * CE-Megfelelőségi nyilatkozat

Ø mm	Ø "	NxT	Nm	Ft		
3	1/8	3x80	1,53	285	500	080160003
5	3/16	3x110	3,02	360	300	080160005
6	1/4	3x120	5,19	400	200	080160006
8	5/16	5x210	5,19	495	150	080160008
10	3/8	5x240	12,54	745	70	080160010
11	7/16	5x260	12,54	800	70	080160011
12-13	1/2	5x300	24,76	1.070	40	080160013
14	9/16	5x295	24,76	1.170	35	080160014
16	5/8	5x335	24,76	1.380	30	080160016
18	11/16	5x380	42,42	1.860	30	080160018
20	3/4	5x540	42,42	2.020	30	080160020
22	7/8	7x595	42,42	2.370	25	080160022
24-26	1"	7x700	67,56	3.260	15	080160026
28	1 1/16	8x840	67,56	4.050	5	080160028
30-32	1 1/8	8x990	67,56	4.090	5	080160030
34-36	1 1/4	8x1155	105,80	5.380	4	080160034
38-40	1 1/2	8x1320	105,80	7.250	2	080160040
45-50	2"	8x1500	206	11.150	1	080160050

Speciális csomagolás



Ø mm	Ø "	NxT	Ft			
3	1/8	100	100	31.900	1	080160703
5	3/16	50	50	20.250	1	080160705
6	1/4	50	50	22.550	1	080160706
8	5/16	30	30	16.650	1	080160708
10	3/8	30	30	25.150	1	080160710
11	7/16	25	25	22.550	1	080160711
12-13	1/2	15	15	18.100	1	080160713

Különleges csomagolások szabad szolgálatához



Ø mm	Ft			
3	6	2.150	1	080169403
5	4	1.900	1	080169405
6	4	2.130	1	080169406
8	4	2.450	1	080169408
10	2	1.960	1	080169410
11	1	1.420	1	080169011
12-13	1	1.680	1	080169013
14	1	1.760	1	080169014
16	1	1.960	1	080169016
18	1	2.490	1	080169018
20	1	2.530	1	080169020
22	1	2.980	1	080169022
24-26	1	3.930	1	080169026

8016FR

Szorítókegyel acélból, hidegen préselt test, horganyzott

CE

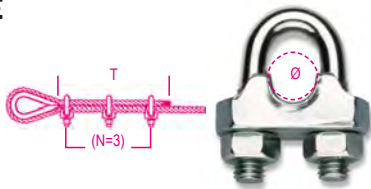

LABORELEMZÉSEK

- Kémiai elemzés
- RENDELKEZÉSRE ÁLLÓ TANÚSÍTVÁNYOK
- Termékleírás
- Vizsgálati jelentés 2.2 UNI EN10204
- CE-Megfelelőségi nyilatkozat

Ø mm	Ø "	N x T	Nm	Ft		
3	1/8	3x80	1,25	265	500	080160253
5	3/16	3x110	2,46	310	300	080160255
6	1/4	3x120	4,24	380	200	080160256
8	5/16	5x210	4,24	440	150	080160258

8018E

Szorítókegyel galvanizált



LABORELEMZÉSEK

- Kémiai elemzés
- RENDELKEZÉSRE ÁLLÓ TANÚSÍTVÁNYOK
- Termékleírás
- Vizsgálati jelentés 2.2 UNI EN10204

Ø mm	A mm	L mm	Nm	Ft		
4+6	M6	34	4,24	575	100	080180001



Robur

8016U2

Szorítókegyel, horganyzott

CE

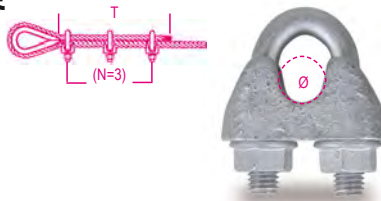

dimenzi EN 13411-5 tipo A

MŰSZAKI ADATOK

- Azonosítókód
- LABORELEMZÉSEK
- Kémiai elemzés
- Nyomaték teszt
- RENDELKEZÉSRE ÁLLÓ TANÚSÍTVÁNYOK
- Termékleírás
- Vizsgálati jelentés 2.2 UNI EN10204
- Gyártói tanúsítvány UNI EN 13411-5
- CE-Megfelelőségi nyilatkozat

Ø mm	Ø "	N x T	Nm	Ft		
5	3/16	3x156	2,0	155	300	080160855
6,5	1/4	3x192	3,5	210	150	080160856
8	5/16	4x320	6	430	70	080160858
10	3/8	4x320	9	445	60	080160860
12	1/2	4x384	20	845	25	080160862
14	9/16	4x448	33	1.320	15	080160864
16	5/8	4x512	49	1.960	10	080160866
19	3/4	4x512	68	2.270	10	080160869
22	7/8	5x680	107	3.260	10	080160872
26	1	5x760	147	5.870	5	080160876
30	1.1/8	6x984	212	7.530	5	080160880
34	1.1/4	6x1080	296	10.300	5	080160884
40	1.1/2	6x1176	363	12.750	5	080160890

Különleges csomagolások szabad szolgáltatáshoz



Ø mm		Ft		
5	4	1.860	1	080169805
6	4	2.370	1	080169806
8	4	3.620	1	080169808
10	2	2.450	1	080169810
12	1	2.370	1	080169612
14	1	2.690	1	080169614
16	1	3.620	1	080169616
19	1	3.970	1	080169619
22	1	5.180	1	080169622
26	1	8.460	1	080169626

8016UGK

szorítókegyel, öntöttvasból, TÜZIHORGANYZOTT test, GEOMET-GEOKOTE U-csapszeg és anyja

CE

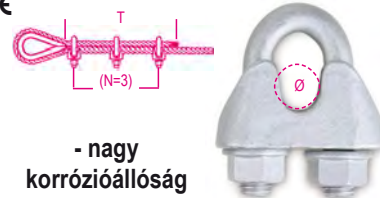

- nagy
korrózióállóság
azonosítókód

dimenzi EN 13411-5 tipo A

MŰSZAKI ADATOK

- azonosítókód
- LABORATÓRIUMI TESZTEK
- vegyelemzés
- torziós vizsgálat
- TANÚSÍTVÁNYOK
- Műszaki termékspecifikáció
- Vizsgálati jelentés 2.2 UNI EN10204
- Gyártói tanúsítvány UNI EN13411-5
- CE megfelelelőségi nyilatkozat

Ø mm	Ø "	N x T	Nm	Ft		
8	5/16	4x320	6	845	70	080160758
10	3/8	4x320	9	935	60	080160760
12	1/2	4x448	33	1.680	25	080160762
14	9/16	4x384	20	2.450	15	080160764
16	5/8	4x512	49	3.620	10	080160766
19	3/4	4x512	68	4.090	10	080160769
22	7/8	5x680	107	5.870	10	080160772
26	1	5x760	147	9.640	5	080160776
30	1.1/8	6x984	212	11.550	1	080160780
34	1.1/4	6x1080	296	16.400	1	080160784
40	1.1/2	6x1176	363	20.450	1	080160790

8018T

Szorítókegyel, galvanizált



RUM-MU-21:1980

LABORELEMZÉSEK

- Kémiai elemzés
- RENDELKEZÉSRE ÁLLÓ TANÚSÍTVÁNYOK
- Termékleírás
- Vizsgálati jelentés 2.2 UNI EN10204

Ø mm	A mm	L mm	Nm	Ft		
8+10	M8	42	10,20	585	200	080180003



Robur

Robur

8020A

kötélszív, könnyített kivitel, galvanizált

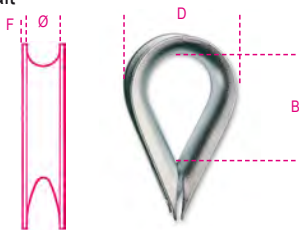

TANÚSÍTVÁNYOK

- Műszaki termékspecifikáció
- Vizsgálati jelentés 2.2 UNI EN10204

Ø mm	F mm	B mm	D mm	Ft		
2-3	1,0	20	18	105	150	080200503
4	1,2	23	19	115	150	080200504
5	1,2	24	23	130	100	080200505
6	1,2	27	28	135	100	080200506
8	1,4	33	32	210	50	080200508
10	1,8	41	38	305	30	080200510
12	2,2	44	45	405	30	080200512
14	2,2	52	49	520	50	080200514
16	3,0	58	58	730	50	080200516
18	3,7	64	68	1.030	50	080200518
20	3,7	73	74	1.340	35	080200520
22	3,7	83	79	1.500	30	080200522
24	3,7	93	88	1.960	20	080200525

Speciális csomagolás



Ø mm	S mm	Ft		
2-3	0,8	150	15.800	1 080200703
4	1,0	150	17.000	1 080200704
5	1,0	100	12.950	1 080200705
6	1,0	100	13.350	1 080200706
8	1,2	50	10.500	1 080200708
10	1,5	30	9.230	1 080200710

Robur

8021A

Kötélszív, erősített kivitel, galvanizált

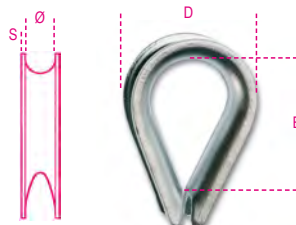

RENDELKEZÉSRE ÁLLÓ TANÚSÍTVÁNYOK

- Termékleírás
- Vizsgálati jelentés 2.2 UNI EN10204

Ø mm	S mm	B mm	D mm	Ft		
2-3	0,6	15	16	175	150	080210103
5	1,7	29	28	250	120	080210105
6	1,8	33	30	275	100	080210106
8	2,5	36	37	370	100	080210108
10	2,5	42	43	455	80	080210110
12	2,5	48	50	585	100	080210112
14	2,7	58	57	790	70	080210114
16	3	61	62	965	50	080210116
18	3,5	71	71	1.260	70	080210118
20	4	79	79	1.860	30	080210120
22	4	87	84	2.170	25	080210122
24	4	93	92	2.530	25	080210124
26	4	103	103	3.140	20	080210126
28	5	107	116	7.330	1	080210128
30	5	118	121	7.330	1	080210130
32	5,5	138	135	8.830	1	080210132
35	6	140	147	12.350	1	080210135
40	6,0	174	170	17.400	1	080210140

EMELŐKENGYELEK

A hasonló termékekkel ellentétben a Robur nagy szakítószilárdságú emelőkengyelei teljes egészében edzett króm-molibdén ötvözetű acélból készülnek, és úgy tervezték, hogy laboratóriumi tesztek során meghaladják a 20.000 teljes terheléses ciklust. Kategóriájukban a referenciaszabványok követelményeit meghaladó biztonsági tényezőnek (5:1 helyett 6:1) és az alacsony hőmérséklet mellett is kiváló rugalmasságnak köszönhetően a nagy igénybevételt jelentő munkákhoz a legjobb választást jelentik. A Robur lágyacél kengyelei hosszú távon is megbízhatóak és hatékonyak. Mindez a kiváló minőségű alapanyagának, mechanikai megmunkálásának és a hőkezelésnek (normalizálásnak) köszönhető, melynek révén a termék tényleges munkaterhelése és biztonsági tényezője nagyobb, mint a hasonló, kereskedelmi forgalomban kapható termékeké.

Az egyes darabok egyértelmű, kitörölhetetlen jelölése – a műszaki vizsgálatot végző cégek vagy illetékes szervek által végzett ellenőrzések esetén – azonosíthatóvá teszi a kengyelek eredetét.



8026R

egyenes emelőkengyel csavaros csappal, nagyszilárdságú ötvöztött acél tűzihorganyzott

CE

EN 13889



MŰSZAKI ADATOK

- legkisebb biztonsági együttható: 6
- hőkezelés: lágyítás
- gyártási sorozatszám a csapra és a kengyelen
- vizsgálati terhelés teszt (2 x wll)

RENDELKEZÉSRE ÁLLÓ TANÚSÍTVÁNYOK

- Termékleírás
- 2.2 UNI EN10204 típusú Tesztjelentés
- 3.1 UNI EN10204 típusú Ellenőrzési tanúsítvány
- EK Megfelelőségi Nyilatkozat

ØD mm	ØA mm	H mm	WLL kg	Ft		
11	10	17	1000	2.850	5	080260210
16	13	21	2000	5.300	5	080260212
19	16	27	3250	8.950	3	080260216
22	19	32	4750	12.950	2	080260219
25	22	37	6500	19.850	2	080260222

Különleges csomagolások szabad szolgálatához



ØD mm	Ft		
16	5.790	1	080269212
19	9.640	1	080269216

8029R

Speciális csomagolások

CE



EN 13889

ØD mm	ØA mm	H mm	WLL kg	Ft		
8	6	13	500	1.740	20	080290106
10	8	13,5	750	2.130	15	080290108
11	10	17	1000	2.980	15	080290110
13	11	18,5	1500	3.970	10	080290111
16	13	20,5	2000	4.090	8	080290112
19	16	27	3250	7.000	8	080290116
22	19	32	4750	10.300	4	080290120
25	22	37	6500	15.400	4	080290122
28	26	43,5	8500	21.250	1	080290124

ØD mm	ØA mm	H mm	WLL kg	Ft	📦	🚚
32	29	48	9500	39.450	1	080290128
35	32	53	12000	52.850	1	080290132
38	35	59	13500	69.250	1	080290135
42	38	62	17000	90.700	1	080290138
50	45	75	25000	155.100	1	080290145
57	50	83	35000	271.300	1	080290150
65	57	95	42500	467.200	1	080290157
70	65	105	55000	534.400	1	080290165

Különleges csomagolások szabad
szolgáltatáshoz



ØD mm	📦	Ft	📦	🚚
8	1	2.370	1	080299106
10	1	2.690	1	080299108
11	1	3.620	1	080299110
13	1	4.570	1	080299111
16	1	4.700	1	080299112
19	1	7.890	1	080299116



ØD mm	ØA mm	📦	Ft	📦	🚚
8	6	10	19.600	1	080290706
10	8	10	23.900	1	080290708
11	10	10	33.450	1	080290710
13	11	5	22.300	1	080290711
16	13	4	18.400	1	080290712
19	16	4	31.500	1	080290716
22	19	2	23.250	1	080290720
25	22	2	34.600	1	080290722

8031R

anyás-sasszeges ívelt emelőkengyel
nagyzilárdságú ötvöztött acél
tűzhorganyzott

CE



EN 13889

MŰSZAKI ADATOK

- legkisebb biztonsági együttható: 6
- hőkezelés: lágyítás
- gyártási sorozatszám a csapon és a kengyelen
- LABORATÓRIUMI ELEMZÉS
- vegyi analízis • metallográfiai analízis
- szakítópróba • fátörésipróba (min. 20.000 ciklus)
- vizsgálati terhelés teszt (2 x wll)

RENDELKEZÉSRE ÁLLÓ TANÚSÍTVÁNYOK

- Termékleírás
- 2.2 UNI EN10204 típusú Tesztjelentés
- 3.1 UNI EN10204 típusú Ellenőrzési tanúsítvány
- EK Megfelelőségi Nyilatkozat

ØD mm	ØA mm	H mm	WLL kg	Ft	📦	🚚
11	10	17	1000	3.200	5	080310110
13	11	18	1500	4.940	5	080310111
16	13	21	2000	5.020	5	080310112
19	16	27	3250	8.620	3	080310116
22	19	32	4750	12.350	2	080310120

ØA mm	ØD mm	H mm	WLL kg	Ft	📦	🚚
22	25	37	6500	17.000	2	080310122
26	28	43	8500	25.100	1	080310124
29	32	48	9500	43.100	1	080310128
32	35	53	12000	55.850	1	080310132
35	38	59	13500	78.550	1	080310135
38	42	62	17000	95.950	1	080310138
45	50	75	25000	168.000	1	080310145
50	57	83	35000	294.700	1	080310150
65	70	105	55000	603.200	1	080310165
75	83	127	85000	915.000	1	080310183

Különleges csomagolások szabad
szolgáltatáshoz



ØD mm	📦	Ft	📦	🚚
16	1	6.230	1	080319112
19	1	10.500	1	080319116

8032

ívelt emelőkengyel, négyzetes furatú
csappal
nagyzilárdságú ötvöztött acél
tűzhorganyzott

CE

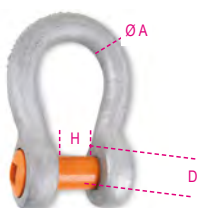

MŰSZAKI ADATOK

- legkisebb biztonsági együttható: 6
- hőkezelés: lágyítás
- gyártási sorozatszám a csapon és a kengyelen
- LABORATÓRIUMI ELEMZÉS
- vegyi analízis
- metallográfiai analízis
- szakítópróba
- fátörésipróba (min. 20.000 ciklus)
- vizsgálati terhelés teszt (2 x wll)

RENDELKEZÉSRE ÁLLÓ TANÚSÍTVÁNYOK

- Termékleírás
- 2.2 UNI EN10204 típusú Tesztjelentés
- 3.1 UNI EN10204 típusú Ellenőrzési tanúsítvány
- EK Megfelelőségi Nyilatkozat

ØD mm	ØA mm	H mm	WLL kg	Ft	📦	🚚
11	10	17	1000	3.810	5	080320010
16	13	21	2000	4.820	5	080320012
19	16	27	3250	8.790	3	080320016
22	19	32	4750	15.200	2	080320020
25	22	37	6500	22.050	2	080320022

Különleges csomagolások szabad
szolgáltatáshoz



ØD mm	📦	Ft	📦	🚚
16	1	5.790	1	080329012
19	1	9.640	1	080329016



8025

egyenes emelőkengyel, széles típus
szénacél
horganyzott

CE



MŰSZAKI ADATOK

- Min. biztonsági koeficiens: 5
- Hőkezelés: normál hőkezelés
- Gyártási száma
- LABORELEMZÉSEK
- Kémiai elemzés
- Metallográfiai elemzés
- Szakítópróba

RENDELKEZÉSRE ÁLLÓ TANÚSÍTVÁNYOK

- Termékleírás
- Vizsgálati jelentés 2.2 UNI EN10204
- Ellenőrzési tanúsítvány 3.1 UNI EN10204
- CE-Megfelelőségi nyilatkozat

Ø mm	≈	B x C mm	WLL kg	Ft	📦	🚚
5	3/16	21x10	70	670	250	080250005
6	1/4	25x12	100	905	250	080250006
8	5/16	33x16	250	1.520	150	080250008
10	3/8	42x20	400	1.680	180	080250010
11	7/16	46x22	500	2.040	130	080250011
12	1/2	50x24	600	2.210	100	080250012
14	9/16	57x28	800	2.870	70	080250014
16	5/8	61x32	1000	3.740	10	080250016
18	11/16	65x36	1300	5.430	10	080250018
20	3/4	70x40	1600	6.360	10	080250020
22	7/8	74x44	2000	8.830	10	080250022
25	1"	80x48	2800	11.750	2	080250025

Speciális csomagolás



Ø mm	≈	📦	Ft	📦	🚚
5	3/16	25	18.900	1	080250705
6	1/4	25	25.500	1	080250706
8	5/16	25	42.700	1	080250708
10	3/8	15	28.350	1	080250710
11	7/16	12	27.600	1	080250711
12	1/2	12	29.800	1	080250712
14	9/16	10	32.350	1	080250714

Különleges csomagolások szabad
szolgáltatáshoz



Ø mm	📦	Ft	📦	🚚
5	4	3.380	1	080259205
6	4	4.330	1	080259206
8	2	3.600	1	080259208
10	2	3.870	1	080259210
11	1	2.530	1	080259011
12	1	2.750	1	080259012
14	1	3.380	1	080259014
16	1	4.250	1	080259016
18	1	6.360	1	080259018
20	1	7.170	1	080259020
22	1	9.350	1	080259022
25	1	12.350	1	080259025

8026A

egyenes emelőkengyel, UNI típus
szénacél
horganyzott

CE

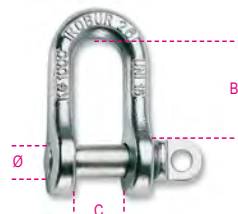

MŰSZAKI ADATOK

- Min. biztonsági koefficiens: 5
- Hőkezelés: normál hőkezelés
- Gyártási száma

LABORELEMZÉSEK

- Kémiai elemzés
- Metallográfiai elemzés
- Szakítópróba

RENDELKEZÉSRE ÁLLÓ TANÚSÍTVÁNYOK

- Termékleírás
- Vizsgálati jelentés 2.2 UNI EN10204
- Ellenőrzési tanúsítvány 3.1 UNI EN10204
- CE-Megfelelőségi nyilatkozat

Ø mm	≈ "	B x C mm	WLL kg	Ft		
12	1/2	42x20	630	2.130	35	080260012
14	9/16	46x22	800	2.630	30	080260014
16	5/8	50x24	1000	3.380	20	080260016
18	11/16	54x26	1300	4.780	15	080260018
20	3/4	58x28	1600	6.030	10	080260020
22	7/8	69x32	2000	7.890	10	080260022
25	1"	79x36	2500	11.150	5	080260025
28	1.1/8	90x40	3150	15.400	2	080260028
32	1.1/4	100x45	4000	21.250	1	080260032
36	1.3/8	110x50	5000	30.350	1	080260036
40	1.9/16	120x55	6300	41.900	1	080260040
42	1.5/8	131x60	8000	57.300	1	080260042
45	1.3/4	143x65	10000	78.150	1	080260045
50	2"	155x70	12500	97.150	1	080260050

Különleges csomagolások szabad
szolgáltatáshoz



Ø mm		Ft		
12	1	2.710	1	080269012
14	1	3.260	1	080269014
16	1	3.810	1	080269016
18	1	5.790	1	080269018
20	1	6.920	1	080269020
22	1	8.830	1	080269022
25	1	12.350	1	080269025



8028

ívelt emelőkengyel
szénacél
horganyzott

CE

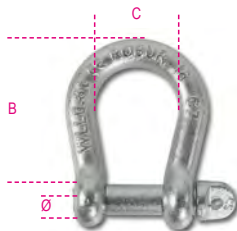

MŰSZAKI ADATOK

- Min. biztonsági koefficiens: 5
- Hőkezelés: normál hőkezelés
- Gyártási száma

LABORELEMZÉSEK

- Kémiai elemzés
- Metallográfiai elemzés
- Szakítópróba

RENDELKEZÉSRE ÁLLÓ TANÚSÍTVÁNYOK

- Termékleírás
- Vizsgálati jelentés 2.2 UNI EN10204
- Ellenőrzési tanúsítvány 3.1 UNI EN10204
- CE-Megfelelőségi nyilatkozat

Ø mm	≈ "	B x C mm	WLL kg	Ft		
5	3/16	20x16	80	580	100	080280105
6	1/4	24x20	100	860	70	080280106
8	5/16	32x24	200	1.500	35	080280108
10	3/8	40x33	300	1.720	25	080280110
12	1/2	48x39	500	2.710	15	080280112
14	9/16	56x46	600	3.870	7	080280114
16	5/8	64x46	800	5.830	10	080280116
18	11/16	71x59	950	7.170	5	080280118
20	3/4	80x65	1100	10.300	5	080280120
22	7/8	88x72	1500	12.950	5	080280122
25	1"	100x81	2000	19.850	2	080280125
28	1.1/8	112x91	2600	30.750	1	080280128
32	1.1/4	128x104	3200	42.100	1	080280132
38	1.1/2	152x124	4500	83.800	1	080280138

Különleges csomagolások szabad
szolgáltatáshoz



Ø mm		Ft		
5	4	2.870	1	080289305
6	4	4.130	1	080289306
8	2	3.720	1	080289308
10	2	4.010	1	080289310
12	1	3.320	1	080289112
14	1	4.450	1	080289114
16	1	6.320	1	080289116
18	1	8.020	1	080289118
20	1	11.150	1	080289120
22	1	14.150	1	080289122

8049 WLL (t)

	A°	M8	M10	M12	M16	M20	M24	M30
	0°	0,3	0,6	1	1,6	2,5	4	6,3
	0°	0,6	1,2	2	3,2	5	8	12,6
	90°	0,3	0,6	1	1,6	2,5	4	6,3
	90°	0,6	1,2	2	3,2	5	8	12,6
	0°	0,4	0,8	1,4	2,2	3,5	5,6	8,8
	45°	0,3	0,6	1	1,6	2,5	4	6,3
	60°	0,3	0,6	1	1,6	2,5	4	6,3
	0°	0,6	1,3	2,1	3,4	5,3	8,4	13,2
	46°	0,3	0,6	1	1,6	2,3	4	6,3

8049

Gyűrűs anya, állítható, dupla csuklóval,
ötvözött acélból

CE

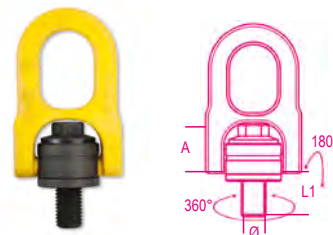

MŰSZAKI ADATOK

- Min. biztonsági koefficiens: 5
- Hőkezelés: díjazás ellenében
- Gyártási száma

LABORELEMZÉSEK

- Kémiai elemzés
- Metallográfiai elemzés
- Szakítópróba

RENDELKEZÉSRE ÁLLÓ TANÚSÍTVÁNYOK

- Termékleírás
- Vizsgálati jelentés 2.2 UNI EN10204
- Ellenőrzési tanúsítvány 3.1 UNI EN10204
- CE-Megfelelőségi nyilatkozat

Ø mm	A mm	L1 mm	WLL 90° kg	Ft		
M8	31,5	14	300	57.900	1	080490008
M10	31,5	17	600	60.300	1	080490010
M12	31,5	21	1000	61.950	1	080490012
M16	45	27	1600	71.250	1	080490016
M20	45	30	2500	73.050	1	080490020
M24	60,5	36	4000	125.100	1	080490024
M30	60,5	45	6300	130.400	1	080490030



8049A WLL (kg)

	B°	M6	M8	M10	M12	M16	M20	M24	M30	M36
	0°	400	600	900	1000	2000	4000	6300	10600	11800
	0°	800	1200	1800	2000	4000	8000	12600	21200	23600
	90°	200	300	450	500	1120	2000	3150	5300	8000
	90°	400	600	900	1000	2000	4000	6300	10600	16000
	0°	250	400	600	700	1400	2800	4250	7100	10700
	45°	200	300	450	500	1120	2000	3150	5300	8000
	60°	200	300	450	500	1120	2000	3150	5300	8000
	0°	400	600	900	1000	2100	4200	6300	11200	16000
	45°	250	400	600	750	1500	3000	4750	8000	10700

8049A

gyűrűs anya,
dupla csuklóval, teher alatt elfordul,
hegesztett gyűrűvel
nagyzilárdságú ötvöztött acél

CE



MŰSZAKI ADATOK

• biztonsági együttható: 4

• hőkezelés: edzés

• azonosító kód

LABORATÓRIUMI TESZTEK

• vegyelemzés

• fémszerkezet vizsgálat

• szakítópróba

• fáradáspróba (20.000 ciklus)

• terhelési teszt (minden darabra)

TANÚSÍTVÁNYOK

• Műszaki termékspecifikáció

• Vizsgálati jelentés 2.2 UNI EN10204

• Ellenőrző tanúsítvány 3.1 UNI EN10204

• CE megfelelőségi nyilatkozat

Ø	E	A	WLL	Ft		
mm	mm	mm	kg			
M6	13	30	200	19.250	1	080490106
M8	13	30	300	19.650	1	080490108
M10	19	30	450	20.450	1	080490110
M12	19	30	500	21.850	1	080490112
M14	19	30	1120	22.250	1	080490114
M16	20	30	1120	23.050	1	080490116
M18	30	40	2000	28.950	1	080490118
M20	30	40	2000	33.400	1	080490120
M24	30	40	3150	49.000	1	080490124
M30	35	50	5300	84.600	1	080490130
M36	54	50	8000	89.050	1	080490136

8049V

gyűrűs anya
eltolt csuklóval
nagyzilárdságú ötvöztött acél
360°-ban elforgatható szemescsavar forgócsuklóval

CE



MŰSZAKI ADATOK

• biztonsági együttható: 4

• hőkezelés: edzés és lágyítás

• azonosító kód

LABORATÓRIUMI TESZTEK

• vegyelemzés

• fémszerkezet vizsgálat

• szakítópróba

• fáradáspróba (20.000 ciklus)

• terhelési teszt (minden darabra)

TANÚSÍTVÁNYOK

• Műszaki termékspecifikáció

• Vizsgálati jelentés 2.2 UNI EN10204

• Ellenőrző tanúsítvány 3.1 UNI EN10204

• CE megfelelőségi nyilatkozat

Ø	E	B	WLL	Ft		
mm	mm	mm	kg			
M10	13,5	37	630	32.000	1	080490310
M12	18	37,5	1000	39.250	1	080490312
M16	24	37,5	1500	41.900	1	080490316
M20	35,5	54	2500	60.700	1	080490320
M24	35,5	54	4000	62.550	1	080490324

8068S

hegesztett konzol emeléshez,
egyetlen alap, pozicionáló rugókkal,
nagyzilárdságú ötvöztött acél

- Kompakt méretek emelési műveletekhez
- Teljes terhelés mellett 20 000 munkaciklus kapacitásra tesztelve
- Értékesítése előtt minden részt terheléssel ellenőrzünk
- Biztonsági együttható: minden irányban 4

CE



MŰSZAKI ADATOK

• biztonsági együttható: 4

• hőkezelés: edzés

• azonosító kód

LABORATÓRIUMI TESZTEK

• vegyelemzés

• fémszerkezet vizsgálat

• szakítópróba

• fáradáspróba (20.000 ciklus)

• terheléspróba (minden egyes darabon)

TANÚSÍTVÁNYOK

• Műszaki termékspecifikáció

• Vizsgálati jelentés 2.2 UNI EN10204

• Ellenőrző tanúsítvány 3.1 UNI EN10204

• CE megfelelőségi nyilatkozat

WLL	B	M	A	Ft		
Kg	mm	mm	mm			
1500	78	37	41	4.740	1	080680115
2500	88	40	42	6.190	1	080680125
4000	94	42	45	8.870	1	080680140
6700	118	51	55	16.400	1	080680167

Figyelem:

- Az összekötőelemnek megfelelő mechanikai ellenállásúnak és hegeszthetőnek kell lenni.
- A hegesztést az erre képezített személyek végeztetik.

8041

külső fülceszavar emeléshez,
nagyzilárdságú ötvöztött acélból

CE



MŰSZAKI ADATOK

• biztonsági együttható: 4

• hőkezelés: lágyítás

• gyártási sorozat száma

LABORATÓRIUMI ELEMZÉS

• vegyi analízis

• metallográfiai analízis

• szakítópróba

• fáradáspróba (20.000 ciklus)

• teszt terhelés (a sorozat 100%-án)

RENDELKEZÉSRE ÁLLÓ TANÚSÍTVÁNYOK

• Termékleírás

• 2.2 UNI EN10204 típusú Tesztjelentés

• 3.1 UNI EN10204 típusú Ellenőrzési tanúsítvány

• EK Megfelelőségi Nyilatkozat

Ø	WLL	E	Ft		
mm	mm	mm	kg		
M6	1	11	400	1.560	10 080410206
* M8	1,25	13	800	1.560	10 080410208
* M10	1,5	17	1000	2.410	6 080410210
* M12	1,75	20,5	1600	3.620	4 080410212
M14	2	20,5	3000	6.030	2 080410214
M16	2,5	27	4000	9.070	2 080410217
M18	2,5	27	5000	9.070	2 080410218
M20	3,0	30	6000	17.000	2 080410221
M22	2,5	30	7000	17.000	2 080410222
M24	3	36	8000	20.450	2 080410225
M27	3	41	10000	31.150	1 080410227
* M30	3,5	45	12000	31.150	1 080410230

(* Méretjellemzők DIN 580:2010

A Robur Műszaki Kiadvány szerint növelt WLL

Különleges csomagolások szabad
szolgáltatáshoz



Ø	Ft		
mm			
* M8	1	2.490	1 080419208
* M10	1	3.500	1 080419210
* M12	1	4.820	1 080419212



Robur

Robur

8043

belső fűlescsavar emeléshez,
nagyszilárdságú ötvöztött acélból

CE

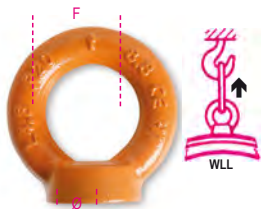

MŰSZAKI ADATOK

- biztonsági együttható: 4
 - hőkezelés: lágyítás
 - gyártási sorozat száma
- LABORÁTORIUMI ELEMZÉS
- vegyi analízis
 - metallográfiai analízis
 - szakítópróba
 - fáradáspróba (20.000 ciklus)
 - teszt terhelés (a sorozat 100%-án)

RENDELKEZÉSRE ÁLLÓ TANÚSÍTVÁNYOK

- Termékleírás
- 2.2 UNI EN10204 típusú Tesztjelentés
- 3.1 UNI EN10204 típusú Ellenőrzési tanúsítvány
- EK Megfelelőségi Nyilatkozat

Ø mm	mm	F mm	WLL kg	Ft		
M6	1	20	400	1.520	10	080430206
* M8	1,25	20	800	1.520	10	080430208
* M10	1,50	25	1000	2.370	6	080430210
* M12	1,75	30	1600	3.580	4	080430212
M14	2	35	3000	5.870	2	080430214
M16	2	40	4000	8.500	2	080430217
M18	2,5	40	5000	8.500	2	080430218
M20	2,5	50	6000	16.400	2	080430221
M22	2,5	50	7000	16.400	2	080430222
M24	3	55	8000	19.250	2	080430225
M27	3	60	10000	29.750	1	080430227
* M30	3,5	60	12000	29.750	1	080430230

(* Méretjellemzők DIN 582:2010

A Robur Műszaki Kiadvány szerint növelt WLL

Különleges csomagolások szabad
szolgáltatáshoz



Ø mm	mm	Ft		
* M8	1	2.370	1	080439208
* M10	1	3.380	1	080439210
* M12	1	4.570	1	080439212

SEZEMESCSAVAROK ÉS EMEŐ GYŰRŰS ANYÁK

A Robur emelő gyűrűs anyái és szemescsavarjai alacsony széntartalmú acélból készülnek, minimális alumíniumtartalommal. A DIN 580/582 szabvány szerint az anyag szemcseméretére vonatkozó szigorú paramétereknek kell megfelelniük. A kiváló mechanikai kivitelezés is hozzájárul a különbséghez: az emelő gyűrűs anyák/szemescsavarok tövében lévő gallérok belső hornyolása jobb tapadást és teljes érintkezést eredményez az emelendő test felületével. Ezen jellemzők alapján a Robur emelő gyűrűs anyái/szemescsavarjai ideálisak összetett emelési feladatokra és intenzív használatra. Pl.: folyamatos ciklikus működésű környezetben vagy -20°C ÷ +200°C hőmérséklet-tartományban.



8040EZ

Speciális csomagolások

CE



DIN 580:2018-04(**)

Ø mm	mm	E mm	WLL kg	Ft		
* M6	1	11	90	845	60	080400406
M8	1,25	13	140	845	60	080400408
M10	1,5	17	230	1.140	40	080400410
M12	1,75	20,5	340	1.520	20	080400412
* M14	2	20,5	480	2.000	20	080400414
M16	2	27	700	2.490	10	080400416
* M18	2,5	27	930	3.040	10	080400418
M20	2,5	30	1200	3.870	10	080400420
* M22	2,5	30	1450	4.980	10	080400422
M24	3	36	1800	7.330	5	080400424
* M27	3	41	2400	9.070	5	080400427
M30	3,5	45	3200	15.200	2	080400430
* M33	3,5	54	3900	21.250	2	080400433
* M33F	2	54	3900	21.250	2	080400434
M36	4	54	4600	21.850	2	080400436
* M36F	3	54	4600	21.850	2	080400437
M42	4,5	63	6300	40.100	1	080400442
* M42F	3	63	6300	40.100	1	080400443
M48	5	68	8600	64.350	1	080400448
* M48F	3	68	8600	64.350	1	080400449
M56	5,5	78	11500	105.300	1	080400456
* M56F	4	78	11500	105.300	1	080400457
M64	6	90	16000	154.700	1	080400464
* M64F	4	90	16000	154.700	1	080400465

Speciális szemescsavar



Ø mm	mm	Ft		
M6	1	19.050	1	080400906
M8	1,25	19.050	1	080400908
M10	1,5	25.600	1	080400910
M12	1,75	25.600	1	080400912

Különleges csomagolások szabad
szolgáltatáshoz



Ø mm	mm	Ft		
M6	4	4.210	1	080409606
M8	4	4.210	1	080409608
M10	2	3.140	1	080409610
M12	1	2.170	1	080409412
* M14	1	2.530	1	080409414
M16	1	3.140	1	080409416
* M18	1	3.700	1	080409418
M20	1	4.450	1	080409420

Ø mm	mm	Ft		
* M22	1	5.870	1	080409422
M24	1	7.940	1	080409424
* M27	1	9.920	1	080409427
M30	1	15.600	1	080409430

8040EN

szemescsavar,
fekete

CE



DIN 580:2018-04(**)

MŰSZAKI ADATOK

- biztonsági együttható: 6
- hőkezelés: normál hőkezelés
- azonosító kód

LABORÁTORIUMI VIZSGÁLATOK

- vegyelemzés
- fémszerkezet vizsgálat
- szakítópróba

TANÚSÍTVÁNYOK

- Műszaki termékspecifikáció
- Vizsgálati jelentés 2.2 UNI EN10204
- Ellenőrző tanúsítvány 3.1 UNI EN10204
- CE megfelelőségi nyilatkozat

Ø mm	mm	E mm	WLL kg	Ft		
* M6	1	11	90	815	60	080400306
M8	1,25	13	140	815	60	080400308
M10	1,5	17	230	1.110	40	080400310
M12	1,75	20,5	340	1.520	20	080400312
* M14	2	20,5	480	1.900	20	080400314
M16	2	27	700	2.370	10	080400316
* M18	2,5	27	930	2.940	10	080400318
M20	2,5	30	1200	3.620	10	080400320
* M22	2,5	30	1450	4.780	10	080400322
M24	3	36	1800	6.720	5	080400324
* M27	3	41	2400	8.460	5	080400327
M30	3,5	45	3200	14.150	2	080400330
* M33	3,5	54	3900	19.850	2	080400333
* M33F	2	54	3900	19.850	2	080400334
M36	4	54	4600	20.850	2	080400336
* M36F	3	54	4600	20.850	2	080400337
M42	4,5	63	6300	38.450	1	080400342
* M42F	3	63	6300	38.450	1	080400343
M48	5	68	8600	62.950	1	080400348
* M48F	3	68	8600	62.950	1	080400349
M56	5,5	78	11500	100.400	1	080400356
* M56F	4	78	11500	100.400	1	080400357
M64	6	90	16000	146.200	1	080400364
* M64F	4	90	16000	146.200	1	080400365

*Méretezés a Robur műszaki fájlnak megfelelően

Különleges csomagolások szabad
szolgáltatáshoz



Ø mm	mm	Ft		
M6	4	3.970	1	080409506
M8	4	3.970	1	080409508
M10	2	2.890	1	080409510
M12	1	2.040	1	080409312
* M14	1	2.450	1	080409314
M16	1	2.890	1	080409316
* M18	1	3.460	1	080409318
M20	1	4.010	1	080409320
* M22	1	5.470	1	080409322
M24	1	7.330	1	080409324
* M27	1	9.070	1	080409327
M30	1	14.750	1	080409330

8042EZ

Speciális csomagolások

CE

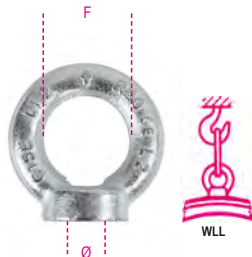

DIN582:2018-04(**)

Ø mm	h _a mm	F mm	WLL kg	Ft	📦	🚚
* M6	1	14	90	845	60	080420406
M8	1,25	20	140	845	60	080420408
M10	1,5	25	230	1.140	40	080420410
M12	1,75	30	340	1.560	30	080420412
* M14	2	30	480	2.000	30	080420414
M16	2	35	700	2.490	20	080420416
* M18	2,5	35	930	3.040	20	080420418
M20	2,5	40	1200	3.810	10	080420420
* M22	2,5	40	1450	4.940	10	080420422
M24	3	50	1800	7.330	5	080420424
* M27	3	55	2400	8.830	5	080420427
M30	3,5	60	3200	14.150	3	080420430
M36	4	70	4600	21.650	2	080420436
* M36F	3	70	4600	21.650	2	080420437
M42	4,5	80	6300	39.250	1	080420442
* M42F	3	80	6300	39.250	1	080420443
M48	5	90	8600	63.550	1	080420448
* M48F	3	90	8600	63.550	1	080420449



Ø mm	h _a mm	Ft	📦	🚚
M6	1	20	18.300	1 080420906
M8	1,25	20	18.300	1 080420908
M10	1,5	20	24.950	1 080420910
M12	1,75	15	25.600	1 080420912

Különleges csomagolások szabad szolgáltatáshoz



Ø mm	📦	Ft	📦	🚚
M6	4	4.090	1	080429606
M8	4	4.090	1	080429608
M10	2	2.940	1	080429610
M12	1	2.170	1	080429412
* M14	1	2.450	1	080429414
M16	1	3.040	1	080429416
* M18	1	3.500	1	080429418
M20	1	4.330	1	080429420
* M22	1	5.470	1	080429422
M24	1	8.460	1	080429424
* M27	1	9.350	1	080429427
M30	1	14.550	1	080429430

Robur

8042EN

emelő gyűrűs anya,
fekete

CE



DIN582:2018-04(**)

MŰSZAKI ADATOK

- biztonsági együttható: 6
- hőkezelés: normál hőkezelés
- azonosító kód
- LABORATÓRIUMI VIZSGÁLATOK
- vegyelemzés
- fémszerkezet vizsgálat
- szakítópróba
- TANÚSÍTVÁNYOK
- Műszaki termékspecifikáció
- Vizsgálati jelentés 2.2 UNI EN10204
- Ellenőrző tanúsítvány 3.1 UNI EN10204
- CE megfelelési nyilatkozat

Ø mm	h _a mm	F mm	WLL kg	Ft	📦	🚚
* M6	1	14	90	815	60	080420306
M8	1,25	20	140	815	60	080420308
M10	1,5	25	230	1.080	40	080420310
M12	1,75	30	340	1.520	30	080420312
* M14	2	30	480	1.940	30	080420314
M16	2	35	700	2.270	20	080420316
* M18	2,5	35	930	2.890	20	080420318
M20	2,5	40	1200	3.500	10	080420320
* M22	2,5	40	1450	4.700	10	080420322
M24	3	50	1800	6.720	5	080420324
* M27	3	55	2400	8.140	5	080420327
M30	3,5	60	3200	12.950	3	080420330
M36	4	70	4600	19.850	2	080420336
* M36F	3	70	4600	19.850	2	080420337
M42	4,5	80	6300	36.850	1	080420342
* M42F	3	80	6300	36.850	1	080420343
M48	5	90	8600	60.300	1	080420348
* M48F	3	90	8600	60.300	1	080420349

*Méreterezés a Robur műszaki fajlank megfelelően

Különleges csomagolások szabad szolgáltatáshoz



Ø mm	📦	Ft	📦	🚚
M6	4	3.970	1	080429506
M8	4	3.970	1	080429508
M10	2	2.890	1	080429510
M12	1	2.000	1	080429312
* M14	1	2.370	1	080429314
M16	1	2.890	1	080429316
* M18	1	3.380	1	080429318
M20	1	4.090	1	080429320
* M22	1	5.300	1	080429322
M24	1	7.610	1	080429324
* M27	1	9.070	1	080429327
M30	1	13.750	1	080429330

8044

Emelő gyűrűs anya,
természletes színű

CE



UNI 2948

MŰSZAKI ADATOK

- Min. biztonsági koeficiens: 4
- Hőkezelés: normál hőkezelés
- Gyártási száma

LABORELEMZÉSEK

- Kémiai elemzés
- Metallográfiai elemzés
- Szakítópróba

RENDELKEZÉSRE ÁLLÓ TANÚSÍTVÁNYOK

- Termékleírás
- Vizsgálati jelentés 2.2 UNI EN10204
- Ellenőrzési tanúsítvány 3.1 UNI EN10204
- CE-Megfelelési nyilatkozat

Ø mm	h _a mm	WLL kg	Ft	📦	🚚
M8	1,25	80	1.080	4	080440008
M10	1,5	160	1.760	4	080440010
M12	1,75	250	3.100	4	080440012
M14	2	250	4.980	2	080440014
M16	2	400	5.020	2	080440016
M20	2,5	630	8.460	2	080440020
M24	3	1000	14.750	2	080440024

Robur

EMELŐLÁNCOK

A legkorszerűbb hőkezelésnek alávetett Robur emelőláncok **nagy szilárdságú ötvözt**

anyagokból készülnek, és megfelelnek az EN 818-4 európai műszaki szabványnak.

A felhasznált kiváló minőségű anyagok alapján az emelőláncok folyamatos intenzív használatra alkalmasak; széles hőmérsékleti tartományban (-40 °C ÷ +200 °C) a teherbírás csökkenése nélkül biztonságosan használhatók.

A terheket a 81/2008 számú olasz törvényerejű rendeletnek megfelelően megfelelően képzett személyzet függeszti és emeli. A láncok sorozatszámokkal ellátott azonosító címkékkel és a vonatkozó szerelési tanúsítványokkal (gyártói tanúsítványok) rendelkeznek.



WLL Ton		UNI EN 818	
Ø D mm	WLL ↑	45°	60°
		0° < β ≤ 45°	45° < β ≤ 60°
6	1,12	1,6	1,12
7	1,5	2,12	1,5
8	2	2,8	2
10	3,15	4,25	3,15
13	5,3	7,5	5,3
16	8	11,2	8
20	12,5	17	12,5
Ø D mm	WLL ↑	45°	60°
		0° < β ≤ 45°	45° < β ≤ 60°
6	2,36	1,7	
7	3,15	2,24	
8	4,25	3	
10	6,7	4,75	
13	11,2	8	
16	17	11,2	
20	26,5	19	

8091

rögzítő emelőheveder

1 karos lánc

táskában

Kérésre Self-locking-gal és megrövidítve

CE

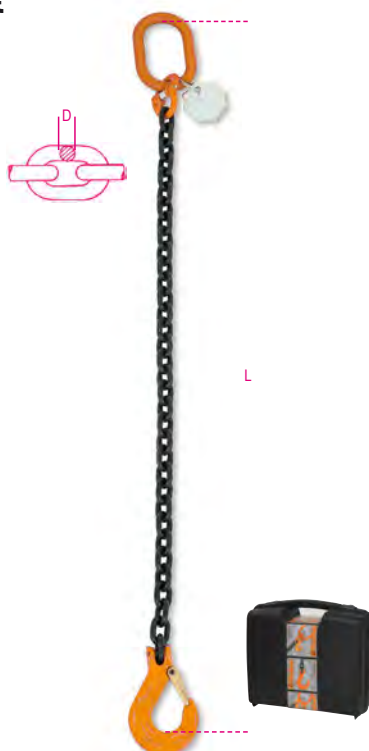

UNI EN 818-4

MŰSZAKI ADATOK

- Min. biztonsági koefficiens: 4
- Szériaaazonosítólap
- MELLÉKELT TANÚSÍTVÁNYOK
- Gyártói tanúsítvány UNI EN818-4
- CE-Megfelelőségi nyilatkozat

RENDELKEZÉSRE ÁLLÓ TANÚSÍTVÁNYOK

- Termékleírás

D mm	L m	WLL ton	Ft	
6*	1	1,12	38.050	1 080910001
6*	2	1,12	46.750	1 080910002
6*	3	1,12	55.250	1 080910003
6*	4	1,12	63.750	1 080910004
7*	1	1,5	41.700	1 080910021
7*	2	1,5	52.650	1 080910022
7*	3	1,5	63.550	1 080910023
7*	4	1,5	74.300	1 080910024
8*	1	2	46.550	1 080910041
8*	2	2	59.500	1 080910042
8*	3	2	72.450	1 080910043
8*	4	2	91.100	1 080910044
10*	1	3,15	59.500	1 080910051
10*	2	3,15	78.550	1 080910052
10*	3	3,15	103.600	1 080910053
10*	4	3,15	123.100	1 080910054
13*	1	5,3	95.750	1 080910131
13*	2	5,3	128.700	1 080910132
13*	3	5,3	159.900	1 080910133
13*	4	5,3	192.700	1 080910134
16*	1	8	187.400	1 080910161
16*	2	8	236.000	1 080910162
16*	3	8	285.800	1 080910163
16*	4	8	335.600	1 080910164
20	1	12,5	366.000	1 080910171
20	2	12,5	460.300	1 080910172
20	3	12,5	554.700	1 080910173
20	4	12,5	649.800	1 080910174

* Súlynak megfelelő facsomagolás

8091SL

emelőlánc,

1 karos, önzáró horog

8. osztály

CE

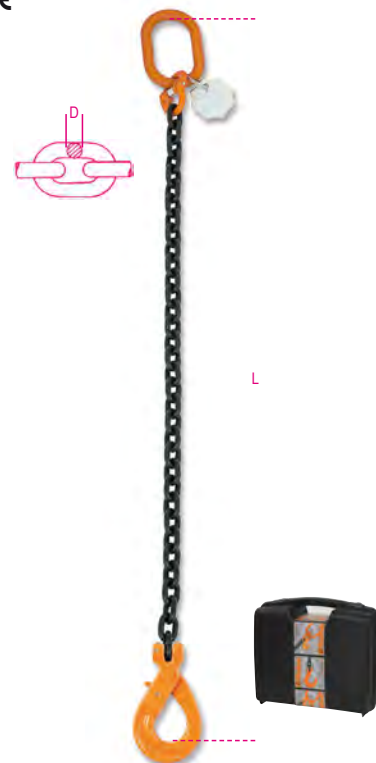

UNI EN 818-4

MŰSZAKI ADATOK

- biztonsági együttható: 4
- emelőlánc azonosító
- MELLÉKELT TANÚSÍTVÁNYOK
- Gyártói tanúsítvány UNI EN818-4
- CE megfelelési nyilatkozat

RENDELKEZÉSRE ÁLLÓ TANÚSÍTVÁNYOK

- Termékleírás

D mm	L m	WLL ton	Ft	
6*	1	1,12	48.150	1 080910201
6*	2	1,12	56.450	1 080910202
6*	3	1,12	64.950	1 080910203
6*	4	1,12	73.500	1 080910204
7*	1	1,5	55.050	1 080910221
7*	2	1,5	66.000	1 080910222
7*	3	1,5	76.900	1 080910223
7*	4	1,5	87.650	1 080910224
8*	1	2	59.900	1 080910241
8*	2	2	70.250	1 080910242
8*	3	2	85.800	1 080910243
8*	4	2	104.500	1 080910244
10*	1	3,15	74.900	1 080910251
10*	2	3,15	93.900	1 080910252
10*	3	3,15	119.000	1 080910253
10*	4	3,15	143.700	1 080910254
13	0,6	5,3	115.800	1 080910330
13*	1	5,3	131.600	1 080910331
13*	2	5,3	174.100	1 080910332
13*	3	5,3	196.800	1 080910333
13*	4	5,3	238.500	1 080910334
16	0,6	8	234.000	1 080910360
16*	1	8	247.400	1 080910361
16*	2	8	310.900	1 080910362
16*	3	8	346.200	1 080910363
16*	4	8	410.500	1 080910364
20	1	12,5	578.900	1 080910401
20	2	12,5	672.100	1 080910402
20	3	12,5	769.200	1 080910403
20	4	12,5	862.300	1 080910404

* Műanyag táskában

8092

rögzítő emelőheveder

2 karos lánc

táskában

Kérésre Self-locking-gal és megrövidítve

CE



EN 818-4

MŰSZAKI ADATOK

- Min. biztonsági koefficiens: 4
- Szériaazonosítólap

MELLÉKELT TANÚSÍTVÁNYOK

- Gyártói tanúsítvány UNI EN818-4
- CE-Megfelelőségi nyilatkozat
- RENDELKEZÉSRE ÁLLÓ TANÚSÍTVÁNYOK**
- Termékleírás

D mm	L m	WLL ton	Ft	📄	📄
6*	1	1,6	55.850	1	080920001
6*	2	1,6	73.050	1	080920002
6*	3	1,6	89.850	1	080920003
6*	4	1,6	112.600	1	080920004
7*	1	2,12	64.950	1	080920021
7*	2	2,12	86.850	1	080920022
7*	3	2,12	114.600	1	080920023
7*	4	2,12	136.400	1	080920024
8*	1	2,8	73.700	1	080920041
8*	2	2,8	99.600	1	080920042
8*	3	2,8	130.800	1	080920043
8*	4	2,8	156.700	1	080920044
10*	1	4,25	106.500	1	080920051
10*	2	4,25	144.900	1	080920052
10*	3	4,25	182.200	1	080920053
10*	4	4,25	220.600	1	080920054
13*	1	7,5	169.600	1	080920131
13*	2	7,5	234.400	1	080920132
13	3	7,5	290.300	1	080920133
13	4	7,5	378.500	1	080920134
16*	1	11,2	340.100	1	080920161
16	2	11,2	453.400	1	080920162
16	3	11,2	552.600	1	080920163
16	4	11,2	651.800	1	080920164
20	2	17,0	915.000	1	080920172
20	3	17,0	1.105.300	1	080920173
20	4	17,0	1.295.500	1	080920174

* Súlynak megfelelő facsomagolás

Robur**8092SL**emelőlánc,
2 karos, önzáró horog
8. biztonsági fok

CE



EN 818-4

MŰSZAKI ADATOK

- biztonsági együttható: 4
- emelőlánc azonosító
- MELLÉKELT TANÚSÍTVÁNYOK**
- Gyártói tanúsítvány UNI EN818-4
- CE megfeleléségi nyilatkozat
- RENDELKEZÉSRE ÁLLÓ TANÚSÍTVÁNYOK**
- Termékleírás

D mm	L m	WLL ton	Ft	📄	📄
6*	1	1,6	75.700	1	080920201
6*	2	1,6	89.250	1	080920202
6*	3	1,6	106.500	1	080920203
6*	4	1,6	132.800	1	080920204
7*	1	2,12	91.300	1	080920221
7*	2	2,12	108.900	1	080920222
7*	3	2,12	140.900	1	080920223
7*	4	2,12	162.800	1	080920224
8*	1	2,8	95.150	1	080920241
8*	2	2,8	126.300	1	080920242
8*	3	2,8	152.200	1	080920243
8*	4	2,8	183.400	1	080920244
10*	1	4,25	148.600	1	080920251
10*	2	4,25	175.300	1	080920252
10*	3	4,25	213.000	1	080920253
10*	4	4,25	262.300	1	080920254
13*	1	7,5	261.100	1	080920331
13*	2	7,5	307.700	1	080920332
13*	3	7,5	381.800	1	080920333
13*	4	7,5	469.200	1	080920334
16*	1	11,2	489.900	1	080920361
16*	2	11,2	603.200	1	080920362
16*	3	11,2	704.500	1	080920363
16*	4	11,2	801.600	1	080920364
20	2	17,0	1.481.800	1	080920402
20	3	17,0	1.672.100	1	080920403
20	4	17,0	1.862.300	1	080920404

* Műanyag táskában

8094

rögzítő emelőheveder

4 karos lánc

táskában

Kérésre Self-locking-gal és megrövidítve

CE



EN 818-4

MŰSZAKI ADATOK

- Min. biztonsági koefficiens: 4
- Szériaazonosítólap
- MELLÉKELT TANÚSÍTVÁNYOK**
- Gyártói tanúsítvány UNI EN818-4
- CE-Megfelelőségi nyilatkozat
- RENDELKEZÉSRE ÁLLÓ TANÚSÍTVÁNYOK**
- Termékleírás

D mm	L m	WLL ton	Ft	📄	📄
6*	1	2,36	116.200	1	080940001
6*	2	2,36	155.900	1	080940002
6*	3	2,36	190.300	1	080940003
6*	4	2,36	222.700	1	080940004
7*	1	3,15	136.400	1	080940021
7*	2	3,15	179.800	1	080940022
7*	3	3,15	222.300	1	080940023
7*	4	3,15	266.000	1	080940024
8*	1	4,25	164.400	1	080940041
8*	2	4,25	214.600	1	080940042
8*	3	4,25	266.400	1	080940043
8	4	4,25	331.200	1	080940044
10*	1	6,7	216.600	1	080940051
10	2	6,7	298.800	1	080940052
10	3	6,7	383.000	1	080940053
10	4	6,7	459.500	1	080940054
13	1	11,2	360.700	1	080940131
13	2	11,2	491.900	1	080940132
13	3	11,2	621.500	1	080940133
13	4	11,2	753.000	1	080940134
16	1	17	708.500	1	080940161
16	2	17	906.900	1	080940162
16	3	17	1.105.300	1	080940163
16	4	17	1.303.600	1	080940164
20	2	26,5	1.659.900	1	080940172
20	3	26,5	2.040.500	1	080940173
20	4	26,5	2.413.000	1	080940174

* Súlynak megfelelő facsomagolás

Robur**Robur**

Robur

8094SL

emelőlánc,
4 karos, önzáró horog
8. biztonsági fok

CE



EN 818-4

MŰSZAKI ADATOK

• biztonsági együttható: 4

• emelőlánc azonosító

MELLÉKELT TANÚSÍTVÁNYOK

• Gyártói tanúsítvány UNI EN818-4

• CE megfeleléségi nyilatkozat

RENDELKEZÉSRE ÁLLÓ TANÚSÍTVÁNYOK

• Termékleírás

D mm	L m	WLL ton	Ft		
6*	1	2,36	155.900	1	080940201
6*	2	2,36	195.500	1	080940202
6*	3	2,36	230.000	1	080940203
6*	4	2,36	262.300	1	080940204
7*	1	3,15	188.700	1	080940221
7*	2	3,15	232.400	1	080940222
7*	3	3,15	275.500	1	080940223
7*	4	3,15	319.000	1	080940224
8*	1	4,25	207.300	1	080940241
8*	2	4,25	257.500	1	080940242
8*	3	4,25	319.400	1	080940243
8	4	4,25	384.200	1	080940244
10*	1	6,7	281.800	1	080940251
10	2	6,7	360.300	1	080940252
10	3	6,7	448.600	1	080940253
10	4	6,7	524.300	1	080940254
13	1	11,2	510.100	1	080940331
13	2	11,2	641.700	1	080940332
13	3	11,2	771.300	1	080940333
13	4	11,2	902.800	1	080940334
16	1	17	957.500	1	080940361
16	2	17	1.157.900	1	080940362
16	3	17	1.360.300	1	080940363
16	4	17	1.554.700	1	080940364
20	2	26,5	2.510.100	1	080940402
20	3	26,5	2.886.600	1	080940403
20	4	26,5	3.263.200	1	080940404

* Műanyag táskában

8096

rögzítő emelőheveder
közelítő horgokkal
1 karos lánc, táskában

CE



EN 818-4

MŰSZAKI ADATOK

• Min. biztonsági koefficiens: 4

• Szériaazonosítólap

MELLÉKELT TANÚSÍTVÁNYOK

• Gyártói tanúsítvány UNI EN818-4

• CE-Megfeleléségi nyilatkozat

RENDELKEZÉSRE ÁLLÓ TANÚSÍTVÁNYOK

• Termékleírás

D mm	L m	WLL ton	Ft		
6*	1	1,12	45.150	1	080960001
6*	2	1,12	53.650	1	080960002
6*	3	1,12	62.150	1	080960003
6*	4	1,12	69.000	1	080960004
7*	1	1,5	50.200	1	080960021
7*	2	1,5	60.950	1	080960022
7*	3	1,5	69.650	1	080960023
7*	4	1,5	80.550	1	080960024
8*	1	2	55.250	1	080960041
8*	2	2	68.200	1	080960042
8*	3	2	80.950	1	080960043
8*	4	2	99.800	1	080960044
10*	1	3,15	76.300	1	080960051
10*	2	3,15	101.200	1	080960052
10*	3	3,15	120.200	1	080960053
10*	4	3,15	139.300	1	080960054
13*	1	5,3	125.100	1	080960131
13*	2	5,3	148.200	1	080960132
13*	3	5,3	179.400	1	080960133
13*	4	5,3	222.300	1	080960134
16*	1	8	246.200	1	080960161
16*	2	8	280.200	1	080960162
16*	3	8	330.000	1	080960163
16	4	8	393.100	1	080960164
20	1	12,5	500.000	1	080960171
20	2	12,5	595.100	1	080960172
20	3	12,5	688.300	1	080960173
20	4	12,5	781.400	1	080960174

*A súly tartalmazza a fakoffer súlyát!

8096SL

emelőlánc,
1 karos, önzáró, kengyeles horgokkal
8. biztonsági fok

CE



EN 818-4

MŰSZAKI ADATOK

• biztonsági együttható: 4

• emelőlánc azonosító

MELLÉKELT TANÚSÍTVÁNYOK

• Gyártói tanúsítvány UNI EN818-4

• CE megfeleléségi nyilatkozat

RENDELKEZÉSRE ÁLLÓ TANÚSÍTVÁNYOK

• Termékleírás

D mm	L m	WLL ton	Ft		
6*	1	1,12	53.450	1	080960201
6*	2	1,12	61.950	1	080960202
6*	3	1,12	70.450	1	080960203
6*	4	1,12	78.750	1	080960204
7*	1	1,5	60.950	1	080960221
7*	2	1,5	71.850	1	080960222
7*	3	1,5	82.800	1	080960223
7*	4	1,5	93.700	1	080960224
8*	1	2	66.000	1	080960241
8*	2	2	78.750	1	080960242
8*	3	2	91.700	1	080960243
8*	4	2	110.500	1	080960244
10*	1	3,15	91.700	1	080960251
10*	2	3,15	116.600	1	080960252
10*	3	3,15	136.000	1	080960253
10*	4	3,15	155.100	1	080960254
13*	1	5,3	160.700	1	080960331
13*	2	5,3	193.900	1	080960332
13*	3	5,3	225.100	1	080960333
13*	4	5,3	257.900	1	080960334
16*	1	8	306.500	1	080960361
16*	2	8	355.100	1	080960362
16*	3	8	404.900	1	080960363
16	4	8	453.000	1	080960364
20	1	12,5	712.600	1	080960401
20	2	12,5	805.700	1	080960402
20	3	12,5	898.800	1	080960403
20	4	12,5	996.000	1	080960404

* Műanyag táskában

8097

rögzítő emelőheveder
közelítő horgokkal
2 karos lánc, táskában

CE



EN 818-4

MŰSZAKI ADATOK

- Min. biztonsági koefficiens: 4
- Szériaazonosítólap

MELLÉKELT TANÚSÍTVÁNYOK

- Gyártói tanúsítvány UNI EN818-4
- CE-Megfelelőségi nyilatkozat

RENDELKEZÉSRE ÁLLÓ TANÚSÍTVÁNYOK

- Termékleírás

D mm	L m	WLL ton	Ft		
6*	1	1,6	70.250	1	080970001
6*	2	1,6	83.800	1	080970002
6*	3	1,6	104.000	1	080970003
6*	4	1,6	123.500	1	080970004
7*	1	2,12	81.550	1	080970021
7*	2	2,12	104.900	1	080970022
7*	3	2,12	126.300	1	080970023
7*	4	2,12	148.200	1	080970024
8*	1	2,8	91.100	1	080970041
8*	2	2,8	117.400	1	080970042
8*	3	2,8	148.200	1	080970043
8*	4	2,8	174.100	1	080970044
10*	1	4,25	140.500	1	080970051
10*	2	4,25	178.500	1	080970052
10*	3	4,25	215.400	1	080970053
10*	4	4,25	253.800	1	080970054
13*	1	7,5	227.500	1	080970131
13*	2	7,5	293.100	1	080970132
13	3	7,5	352.200	1	080970133
13	4	7,5	417.800	1	080970134
16	1	11,2	441.300	1	080970161
16	2	11,2	540.500	1	080970162
16	3	11,2	641.700	1	080970163
16	4	11,2	738.900	1	080970164
20	2	17,0	1.056.700	1	080970172
20	3	17,0	1.247.000	1	080970173
20	4	17,0	1.433.200	1	080970174

*A súly tartalmazza a fakoffer súlyát!

**8097SL**

emelőlánc,
2 karos, önzáró, kengyeles horgokkal
8. biztonsági fok

CE



EN 818-4

MŰSZAKI ADATOK

- biztonsági együttható: 4
- emelőlánc azonosító

MELLÉKELT TANÚSÍTVÁNYOK

- Gyártói tanúsítvány UNI EN818-4
- CE megfelelési nyilatkozat

RENDELKEZÉSRE ÁLLÓ TANÚSÍTVÁNYOK

- Termékleírás

D mm	L m	WLL ton	Ft		
6*	1	1,6	86.450	1	080970201
6*	2	1,6	100.000	1	080970202
6*	3	1,6	120.600	1	080970203
6*	4	1,6	143.300	1	080970204
7*	1	2,12	103.600	1	080970221
7*	2	2,12	127.100	1	080970222
7*	3	2,12	148.600	1	080970223
7*	4	2,12	170.400	1	080970224
8*	1	2,8	112.600	1	080970241
8*	2	2,8	138.900	1	080970242
8*	3	2,8	169.600	1	080970243
8*	4	2,8	195.500	1	080970244
10*	1	4,25	170.900	1	080970251
10*	2	4,25	209.300	1	080970252
10*	3	4,25	246.200	1	080970253
10*	4	4,25	284.600	1	080970254
13*	1	7,5	298.800	1	080970331
13*	2	7,5	364.400	1	080970332
13	3	7,5	443.300	1	080970333
13	4	7,5	489.900	1	080970334
16	1	11,2	591.100	1	080970361
16	2	11,2	690.300	1	080970362
16	3	11,2	791.500	1	080970363
16	4	11,2	860.300	1	080970364
20	2	17,0	1.481.800	1	080970402
20	3	17,0	1.672.100	1	080970403
20	4	17,0	1.862.300	1	080970404

* Műanyag táskában

8098

rögzítő emelőheveder
közelítő horgokkal
4 karos lánc, táskában

CE



EN 818-4

MŰSZAKI ADATOK

- Min. biztonsági koefficiens: 4
- Szériaazonosítólap

MELLÉKELT TANÚSÍTVÁNYOK

- Gyártói tanúsítvány UNI EN818-4
- CE-Megfelelőségi nyilatkozat

RENDELKEZÉSRE ÁLLÓ TANÚSÍTVÁNYOK

- Termékleírás

D mm	L m	WLL ton	Ft		
6*	1	2,36	144.100	1	080980001
6*	2	2,36	177.300	1	080980002
6*	3	2,36	210.100	1	080980003
6*	4	2,36	244.100	1	080980004
7*	1	3,15	169.200	1	080980021
7*	2	3,15	204.500	1	080980022
7*	3	3,15	246.600	1	080980023
7*	4	3,15	290.300	1	080980024
8*	1	4,25	188.700	1	080980041
8*	2	4,25	239.300	1	080980042
8*	3	4,25	290.700	1	080980043
8	4	4,25	355.900	1	080980044
10*	1	6,7	261.100	1	080980051
10	2	6,7	351.000	1	080980052
10	3	6,7	427.500	1	080980053
10	4	6,7	504.000	1	080980054
13	1	11,2	439.300	1	080980131
13	2	11,2	570.900	1	080980132
13	3	11,2	708.500	1	080980133
13	4	11,2	830.000	1	080980134
16	1	17	884.600	1	080980161
16	2	17	1.081.000	1	080980162
16	3	17	1.283.400	1	080980163
16	4	17	1.481.800	1	080980164
20	2	26,5	2.101.200	1	080980172
20	3	26,5	2.481.800	1	080980173
20	4	26,5	2.858.300	1	080980174

*A súly tartalmazza a fakoffer súlyát!

8098SL

emelőlánc,
4 karos, önzáró, kengyeles horgokkal
8. biztonsági fok

CE



EN 818-4

MŰSZAKI ADATOK

- biztonsági együttható: 4

- emelőlánc azonosító

MELLÉKELT TANUSÍTVÁNYOK

- Gyártói tanúsítvány UNI EN818-4

- CE megfelelőségi nyilatkozat

RENDELKEZÉSRE ÁLLÓ TANUSÍTVÁNYOK

- Termékleírás

D mm	L m	WLL ton	Ft	📄	📄
6*	1	2,36	177.300	1	080980201
6*	2	2,36	217.000	1	080980202
6*	3	2,36	242.900	1	080980203
6*	4	2,36	283.800	1	080980204
7*	1	3,15	213.400	1	080980221
7*	2	3,15	248.600	1	080980222
7*	3	3,15	290.700	1	080980223
7*	4	3,15	334.400	1	080980224
8*	1	4,25	241.700	1	080980241
8*	2	4,25	281.800	1	080980242
8	3	4,25	333.600	1	080980243
8*	4	4,25	398.800	1	080980244
10*	1	6,7	322.300	1	080980251
10	2	6,7	412.600	1	080980252
10	3	6,7	489.900	1	080980253
10	4	6,7	564.800	1	080980254
13	1	11,2	581.000	1	080980331
13	2	11,2	712.600	1	080980332
13	3	11,2	850.200	1	080980333
13	4	11,2	973.700	1	080980334
16	1	17	1.129.600	1	080980361
16	2	17	1.332.000	1	080980362
16	3	17	1.530.400	1	080980363
16	4	17	1.724.700	1	080980364
20	2	26,5	2.951.400	1	080980402
20	3	26,5	3.332.000	1	080980403
20	4	26,5	3.708.500	1	080980404

* Műanyag táskában



8100

lánc,
nagyzilárdságú ötvözött acélból

CE

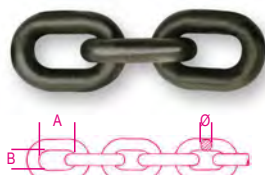

EN 818-2

MŰSZAKI ADATOK

- biztonsági együttható: 4

- hőkezelés: lágyítás

- gyártási sorozatszám

LABORATÓRIUMI ELEMZÉS

- vegyi analízis

- metallográfiai analízis

- szakítópróba

RENDELKEZÉSRE ÁLLÓ TANUSÍTVÁNYOK

- Termékleírás

- 2.2 UNI EN10204 típusú Tesztjelentés

- EN818-2 Gyártói Tanúsítvány

- EK Megfelelőségi Nyilatkozat

WLL kg	Ø mm	A mm	B mm	Ft/m	📄	📄
1120	6	18	7,8	8.990	1	081000011
1500	7	21	9,1	11.550	1	081000016
2000	8	24	10,4	13.550	1	081000020
3150	10	30	13,0	20.250	1	081000032
5300	13	39	16,9	34.800	1	081000053
8000	16	48	20,8	52.850	1	081000080
12500	20	60	26,0	94.350	1	081000125

8085R

közösítő emelő láncszem,
nagyzilárdságú ötvözött acél

WLL 1 láncfelfüggesztésnél értendő.

CE



EN 1677-4

MŰSZAKI ADATOK

- biztonsági együttható: 4

- hőkezelés: edzés

- azonosító kód

LABORATÓRIUMI TESZTEK

- kémiai elemzés, metallográfiai elemzés

- terhelhetőségi teszt (WLL x 2,5)

- szakítópróba

- fáradáspróba (min. 20.000 ciklus)

TANUSÍTVÁNYOK

- Műszaki termékspecifikáció

- Vizsgálati jelentés 2.2 UNI EN10204

- Ellenőrző tanúsítvány 3.1 UNI EN10204

- CE megfelelőségi nyilatkozat

WLL kg	Ø mm	A mm	B mm	Ft	📄	📄
* 1600	7	110	60	4.780	1	080850215
** 2120	8	110	60	6.760	1	080850220
3150	10	135	75	9.550	1	080850232
5300	13	160	90	16.800	1	080850253
8000	16	180	100	33.600	1	080850280
11200	19	200	110	54.650	1	080850311
16000	20	260	140	89.650	1	080850316
17000	22	300	160	127.500	1	080850317

* Ø 6 láncsal szállítva, WLL= 1120 kg

8086

hármasközösítő emelő láncszem,
nagyzilárdságú ötvözött acél

CE



EN 1677-4

MŰSZAKI ADATOK

- Min. biztonsági koefficiens: 4

- Hőkezelés: díjazás ellenében

- Gyártási száma

LABORELEMZÉSEK

- Kémiai elemzés, metallográfiai elemzés

- Terhelhetőségi teszt (WLL x 2,5)

- Szakítópróba

- Fáradáspróba (Min. 20.000 ciklus)

RENDELKEZÉSRE ÁLLÓ TANUSÍTVÁNYOK

- Termékleírás

- Vizsgálati jelentés 2.2 UNI EN10204

- Ellenőrzési tanúsítvány 3.1 UNI EN10204

- CE-Megfelelőségi nyilatkozat

WLL kg	Ø mm	B mm	C mm	Ft	📄	📄
* 3150	7	135	75	30.950	1	080860021
4250	8	160	90	47.550	1	080860042
6700	10	180	100	61.350	1	080860067
11200	13	200	110	99.400	1	080860100
17000	16	260	140	145.300	1	080860117
21200	18	340	180	259.500	1	080860121
26500	20	350	190	368.400	1	080860126

A munkaterhelés 3 vagy 4 karos hevederekre vonatkozik. és a β szög 45°-nál kisebb.

(*) Ø 6 mm-es láncsal kombinálva, WLL= 2360 kg.

8090R

összekötő emelő tag,
nagyzilárdságú ötvözött acél

CE

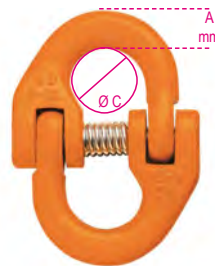

EN 1677-1

MŰSZAKI ADATOK

- Min. biztonsági koefficiens: 4

- Hőkezelés: díjazás ellenében

- Gyártási száma

LABORELEMZÉSEK

- Kémiai elemzés, metallográfiai elemzés

- Terhelhetőségi teszt (WLL x 2,5)

- Szakítópróba

- Fáradáspróba (Min. 20.000 ciklus)

RENDELKEZÉSRE ÁLLÓ TANUSÍTVÁNYOK

- Termékspecifikáció

- Vizsgálati jelentés 2.2 UNI EN10204

- Ellenőrzési tanúsítvány 3.1 UNI EN10204

- CE-Megfelelőségi nyilatkozat

WLL kg	Ø mm	ØC max	A mm	Ft	📄	📄
1120	6	13	7,5	4.050	1	080900111
1500	7	18	9	5.260	1	080900115
2000	8	18	11	6.400	1	080900120
3150	10	22	13,0	7.850	1	080900131
5300	13	30	16	14.150	1	080900153
8000	16	32	22	30.950	1	080900180
12500	20	40	25	70.850	1	080900312

8060R

emelőhorog
kengyeles, lánchoz való típus,
nagyzilárdságú ötvözött acél

CE



EN 1677-2

MŰSZAKI ADATOK

- biztonsági együttható: 4
- hőkezelés: lágyítás
- csap, fül, test sorozatszám

LABORATÓRIUMI ELEMZÉS

- vegyi analízis, metallográfiai analízis
- vizsgálati terhelés teszt (WLL x 2,5)
- szakítópróba
- fáradáspróba (min. 20.000 ciklus)

RENDELKEZÉSRE ÁLLÓ TANÚSÍTVÁNYOK

- Termékleírás
- 2.2 UNI EN10204 típusú Tesztjelentés
- 3.1 UNI EN10204 típusú Ellenőrzési tanúsítvány
- EK Megfelelőségi Nyilatkozat

WLL	Ø mm	C	Ft	📄	🖨️
kg	mm	mm			
1120	6	19	7.610	1	080600111
1500	7	19	8.140	1	080600115
2000	8	21	8.500	1	080600120
3150	10	27	14.750	1	080600132
5300	13	35	23.500	1	080600153
8000	16	48	74.300	1	080600180
12500	20	54	132.400	1	080600225

8058R

emelőhorog
villás önzáró típusú
nagyzilárdságú ötvözött acél

CE



EN 1677-3

MŰSZAKI ADATOK

- biztonsági együttható: 4
- hőkezelés: lágyítás
- gyártási sorozat száma

LABORATÓRIUMI ELEMZÉS

- vegyi analízis, metallográfiai analízis
- szakítópróba
- fáradáspróba (min. 20.000 ciklus)
- teszt terhelés (a sorozat 100%-án)

RENDELKEZÉSRE ÁLLÓ TANÚSÍTVÁNYOK

- Termékleírás
- 2.2 UNI EN10204 típusú Tesztjelentés
- 3.1 UNI EN10204 típusú Ellenőrzési tanúsítvány
- EK Megfelelőségi Nyilatkozat

WLL	Ø mm	J min	Ft	📄	🖨️
kg	mm	mm			
1120	6	28	16.200	1	080580112
2000	7-8	34	19.850	1	080580120
3150	10	44	30.950	1	080580132
5300	13	52	61.350	1	080580153
8000	16	67	138.100	1	080580180
12500	20	77	344.500	1	080580225

8061R

villás közelítő horog
biztosító rögzítőfüllel
nagyzilárdságú ötvözött acél

CE



EN 1677-1

MŰSZAKI ADATOK

- biztonsági együttható: 4
- hőkezelés: lágyítás
- gyártási sorozat száma

LABORATÓRIUMI ELEMZÉS

- vegyi analízis, metallográfiai analízis
- szakítópróba
- fáradáspróba (min. 20.000 ciklus)
- teszt terhelés (a sorozat 100%-án)

RENDELKEZÉSRE ÁLLÓ TANÚSÍTVÁNYOK

- Termékleírás
- 2.2 UNI EN10204 típusú Tesztjelentés
- 3.1 UNI EN10204 típusú Ellenőrzési tanúsítvány
- EK Megfelelőségi Nyilatkozat

WLL	Ø mm	E	Ft	📄	🖨️
kg	mm	mm			
1120	6	8	5.670	1	080610211
2000	7-8	11	6.440	1	080610220
3150	10	13	11.750	1	080610231
5300	13	17	20.650	1	080610253
8000	16	20	46.550	1	080610280
12500	20	24	110.900	1	080610312

8052

nagy ellenállású ötvözött acél emelőhorog
drótkötélhez

CE



EN 1677-2

MŰSZAKI ADATOK

- biztonsági együttható: 4
- hőkezelés: lágyítás
- gyártási sorozat száma

LABORATÓRIUMI ELEMZÉS

- vegyi analízis, metallográfiai analízis
- szakítópróba
- fáradáspróba (min. 20.000 ciklus)
- vizsgálati terhelés teszt (2 x wll)

RENDELKEZÉSRE ÁLLÓ TANÚSÍTVÁNYOK

- Termékleírás
- 2.2 UNI EN10204 típusú Tesztjelentés
- 3.1 UNI EN10204 típusú Ellenőrzési tanúsítvány
- EK Megfelelőségi Nyilatkozat

WLL	C	Ft	📄	🖨️	
kg	mm				
8052 0,8	800	18	2.890	1	080520008
8052 1,12	1120	22,5	3.870	1	080520011
8052 2	2000	30	8.180	1	080520020
8052 3,15	3150	36	12.550	1	080520031
8052 4	4000	39,5	16.200	1	080520040

8055S	WLL	A	E	Ft	📄	🖨️
	kg	mm	mm			
8055S 5,4	5400	40	31.550	1	080550145	
8055S 8,0	8000	51	55.250	1	080550170	
8055S 11,5	11500	58	110.100	1	080550215	
8055S 16,0	16000	66	147.800	1	080550260	
8055S 22,0	22000	87	346.600	1	080550320	

8057R

emelőhorog
füles önzáró típusú
nagyzilárdságú ötvözött acél

CE

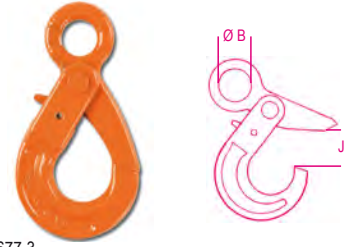

EN 1677-3

MŰSZAKI ADATOK

- biztonsági együttható: 4
- hőkezelés: lágyítás
- gyártási sorozat száma

LABORATÓRIUMI ELEMZÉS

- vegyi analízis, metallográfiai analízis
- szakítópróba
- fáradáspróba (min. 20.000 ciklus)
- teszt terhelés (a sorozat 100%-án)

RENDELKEZÉSRE ÁLLÓ TANÚSÍTVÁNYOK

- Termékleírás
- 2.2 UNI EN10204 típusú Tesztjelentés
- 3.1 UNI EN10204 típusú Ellenőrzési tanúsítvány
- EK Megfelelőségi Nyilatkozat

WLL	Ø mm	J min	ØB	Ft	📄	🖨️
kg	mm	mm	mm			
1120	6	28	22	13.150	1	080570112
2000	7-8	34	25	15.600	1	080570120
3150	10	44	32	28.150	1	080570132
5300	13	54	40	97.950	1	080570153

8063

emelőhorog
forgatható (terhelés alatt nem)
nagyzilárdságú ötvözött acél

CE



EN 1677-1

MŰSZAKI ADATOK

- biztonsági együttható: 4
- hőkezelés: lágyítás
- gyártási sorozat száma

LABORATÓRIUMI ELEMZÉS

- vegyi analízis, metallográfiai analízis
- szakítópróba
- fáradáspróba (min. 20.000 ciklus)
- teszt terhelés (a sorozat 100%-án)

RENDELKEZÉSRE ÁLLÓ TANÚSÍTVÁNYOK

- Termékleírás
- 2.2 UNI EN10204 típusú Tesztjelentés
- 3.1 UNI EN10204 típusú Ellenőrzési tanúsítvány
- EK Megfelelőségi Nyilatkozat

WLL	A	E	Ft	📄	🖨️
kg	mm	mm			
800	32	20,5	6.440	1	080630008
1120	38	20,5	8.140	1	080630011
2000	44,5	22	9.920	1	080630020
3150	44,5	27	12.350	1	080630031

8063SL

önzáró forgóhorog
(nem terhelés alatt)
nagyzilárdságú ötvözött acél
8. minőségi osztály

CE



EN 1677-1

MŰSZAKI ADATOK

- biztonsági együttható: 4
 - hőkezelés: edzés és lágyítás
 - azonosító kód
- LABORATÓRIUMI TESZTEK**
- kémiai elemzés, metallográfiai elemzés
 - szakítópróba
 - fáradáspróba (min. 20.000 ciklus)
 - terheléspróba (minden egyes darabon)

TANÚSÍTVÁNYOK

- Műszaki termékspecifikáció
- Vizsgálati jelentés 2.2 UNI EN10204
- Ellenőrzési tanúsítvány 3.1 UNI EN10204
- CE Megfelelőségi nyilatkozat

WLL	Ø	B	J	Ft	📦	🚚
kg	mm	mm	mm			
1120	6	32	45	17.000	1	080630311
2000	8	35	59	23.700	1	080630320
3150	10	42	54	40.900	1	080630331
5300	13	49	83	62.550	1	080630353

8064S

állítható emelőhorog
szénacél

CE

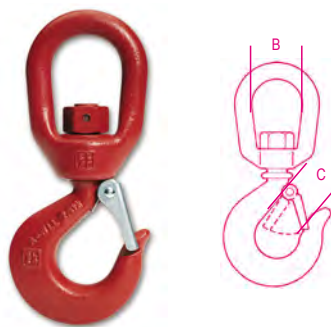

EN 1677-5

MŰSZAKI ADATOK

- Min. biztonsági együttható: 5
 - Hőkezelés: díjazás ellenében
 - Gyártási száma
- LABORELEMZÉSEK**
- Kémiai elemzés, metallográfiai elemzés
 - Terhelhetőségi teszt (WLL x 2,5)
 - Szakítópróba
 - Fáradáspróba (Min. 20.000 ciklus)
- RENDELKEZÉSRE ÁLLÓ TANÚSÍTVÁNYOK**
- Termékleírás
 - Vizsgálati jelentés 2.2 UNI EN10204
 - Ellenőrzési tanúsítvány 3.1 UNI EN10204
 - CE-Megfelelőségi nyilatkozat

WLL	B	C	Ft	📦	🚚
kg	mm	mm			
800	31	20	15.800	1	080640107
1000	40	22	22.250	1	080640110
1600	47	23	29.150	1	080640115
2000	47	27	31.800	1	080640120
3200	64	35	55.650	1	080640130
5000	77	43	101.600	1	080640150
7500	90	53	148.200	1	080640175
10000	96	58	246.200	1	080640199

8065SC

terhelés alatt forgó emelőhorog,
csapágyas
szénacél

CE



EN 1677-5

MŰSZAKI ADATOK

- Min. biztonsági együttható: 5
 - Hőkezelés: díjazás ellenében
 - Gyártási száma
- LABORELEMZÉSEK**
- Kémiai elemzés, metallográfiai elemzés
 - Terhelhetőségi teszt (WLL x 2,5)
 - Szakítópróba
 - Fáradáspróba (Min. 20.000 ciklus)

RENDELKEZÉSRE ÁLLÓ TANÚSÍTVÁNYOK

- Termékleírás
- Vizsgálati jelentés 2.2 UNI EN10204
- Ellenőrzési tanúsítvány 3.1 UNI EN10204
- CE-Megfelelőségi nyilatkozat

WLL	B	C	Ft	📦	🚚
kg	mm	mm			
800	38	20	31.550	1	080650107
1000	38	22	34.600	1	080650110
1600	47	23	42.700	1	080650115
2000	47	27	48.800	1	080650120
3200	54	35	85.800	1	080650130
5000	72	43	127.100	1	080650150
7500	82	53	215.000	1	080650175

8062

Szemes horog ötvözött acélból

CE

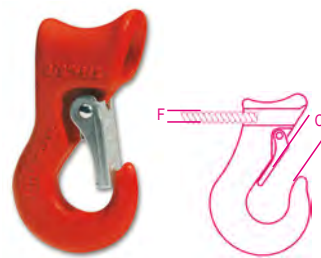

MŰSZAKI ADATOK

- Min. biztonsági együttható: 5
 - Hőkezelés: díjazás ellenében
 - Gyártási száma
- LABORELEMZÉSEK**
- Kémiai elemzés, metallográfiai elemzés
 - Terhelhetőségi teszt (WLL x 2,5)
 - Szakítópróba
- RENDELKEZÉSRE ÁLLÓ TANÚSÍTVÁNYOK**
- Termékleírás
 - Vizsgálati jelentés 2.2 UNI EN10204
 - Ellenőrzési tanúsítvány 3.1 UNI EN10204
 - CE-Megfelelőségi nyilatkozat

WLL	C	F	Ft	📦	🚚
kg	mm	mm			
1500	19	10-13	19.250	1	080620013
2000	21	16	26.900	1	080620016
3000	26	18	44.950	1	080620018

8051S

füles emelőhorog
szénacél
horganyzott

CE



MŰSZAKI ADATOK

- Min. biztonsági együttható: 4
- Hőkezelés: normál hőkezelés
- Gyártási száma

LABORELEMZÉSEK

- Kémiai elemzés
- Metallográfiai elemzés
- Szakítópróba

RENDELKEZÉSRE ÁLLÓ TANÚSÍTVÁNYOK

- Termékleírás
- Vizsgálati jelentés 2.2 UNI EN10204
- Ellenőrzési tanúsítvány 3.1 UNI EN10204
- CE-Megfelelőségi nyilatkozat

WLL	C	F	Ft	📦	🚚
kg	mm	mm			
250	14	12	1.400	10	080510202
500	18	16,5	3.100	5	080510205

Különleges csomagolások szabad
szolgáltatáshoz



WLL	📦	Ft	📦	🚚
kg				
250	1	1.980	1	080519202
500	1	3.830	1	080519205

8134

permanens emelőmágnesek

CE

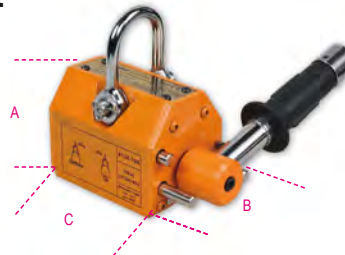

EN13155

Műszaki adatok:

- Biztonsági együttható: 3
- Azonosító címke

Tanúsítványok:

- Gyártói tanúsítvány
- A gépekről szóló 2006/42/EK irányelvnek megfelelő megfelelőségi nyilatkozat
- Vizsgálati jelentés 2.2 UNI EN10204
- Kezelési és karbantartási útmutató

WLL	A	B	D	Ft	📦	🚚
kg	mm	mm	mm			
100	70	64	92	203.600	1	081340010
300	96	88	165	357.100	1	081340030
600	120	118	236	664.000	1	081340060
1000	168	168	264	1.097.200	1	081340100

8135

acéllemez megfogó
csuklós fülescsavarral

CE



EN13155

MŰSZAKI ADATOK

- Biztonsági együttható: 3
- Sorozatszám azonosító tábla

TANÚSÍTVÁNYOK

- Gyártói tanúsítvány
- CE megfelelőségi nyilatkozat
- Vizsgálati jelentés 2.2 UNI EN10204
- Műszaki termékspecifikáció

WLL t	A mm	E mm	h kg	Ft		
0,75	0-15	2	2	58.300	1	081350005
1,0	0-20	5	5	78.750	1	081350010
2,0	0-25	8	8	117.000	1	081350020
3,0	0-30	15	15	198.800	1	081350032
5,0	0-50	23	23	279.400	1	081350050

8135H

vízszintes lemezfogó sík felületű
munkadarabokhoz
max. 30HRC/300HB keménységű anyagokhoz

CE



EN13155

Műszaki adatok:

- Biztonsági együttható: 3
- Sorozatszámot tartalmazó azonosító tábla

Tanúsítványok:

- Gyártói tanúsítvány
- CE megfelelőségi nyilatkozat
- Vizsgálati jelentés 2.2 UNI EN10204

WLL t	A mm	E mm	h kg	Ft		
0,75	25	22	2,5	55.650	1	081350307
1,5	30	25	4,0	73.050	1	081350315
3,0	45	30	6,0	107.700	1	081350330



HALADÓMŰVEK ÉS GERENDAFOGÓK EMELŐKHÖZ

Az EN 13157 szabványnak megfelelően tervezett, kézi emelőkhöz tartozó haladóművek hatékonyan segítik a nehéz terhek mozgatását. A görgőcsapágyas kerekek, a véghelyzet védelem, a kisiklástgátlók és a normalizált acélból készült központi csavar biztonságos, szilárd rögzítést eredményeznek.

A gerendafogók egyszerű, kényelmes megoldást jelentenek szerkezeti gerendák ideiglenes vagy tartós felfüggesztéséhez.

Termékeink teljes nyomkövethetőségét a gyártási és sorozatazonosító számmal ellátott azonosító címke biztosítja.

**8143**

kézi láncos emelő

CE

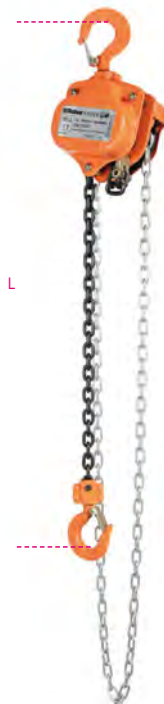

EN13157

WLL t	h L m	szorzo / effort kg	Ft		
0,5	3	27	94.100	1	081430005
1	3	44	110.900	1	081430010
1,5	3	44	147.000	1	081430015
2	3	44	161.100	1	081430020
3	3	45	208.100	1	081430030
5	3	47	308.900	1	081430050
10	3	52	632.300	1	081430100

0,5	6	27	141.300	1	081430105
1	6	44	158.700	1	081430110
1,5	6	44	205.700	1	081430115
2	6	44	223.500	1	081430120
3	6	45	319.800	1	081430130
5	6	47	453.400	1	081430150
10	6	52	910.200	1	081430200

8143SL

Kézi láncos emelő önzáró horoggal

CE



EN13157

Műszaki adatok:

- Biztonsági együttható: 4
- Sorozatszámot tartalmazó azonosító címke

Tanúsítványok:

- Gyártói tanúsítvány
- CE megfelelőségi nyilatkozat
- Vizsgálati jelentés 2.2 UNI EN10204
- Műszaki termékspecifikáció

WLL t	h L m	szorzo / effort kg	Ft		
1	3	44	132.500	1	081430310
2	3	44	174.400	1	081430320

1	6	44	177.200	1	081430410
2	6	44	230.000	1	081430420

8146

karos láncos emelő

CE



EN13157

WLL t	L m	sforzo / effort kg	Ft		
0,75	1,5	21*	115.000	1	081460008
1,5	1,5	41*	163.600	1	081460015
3,0	1,5	41	218.600	1	081460030
6,0	1,5	46	355.500	1	081460060

0,75	3,0	21*	128.700	1	081460108
1,5	3,0	41*	181.800	1	081460115
3,0	3,0	41	250.600	1	081460130
6,0	3,0	46	426.300	1	081460160

Robur

8146SL

Kézi karos láncos emelő önzáró horoggal

CE



EN13157

MŰSZAKI ADATOK

- Biztonsági együttható: 4
 - Sorozatszámot tartalmazó azonosító címke
- ### TANÚSÍTVÁNYOK
- Gyártói tanúsítvány
 - CE megfelelési nyilatkozat
 - Vizsgálati jelentés 2.2 UNI EN10204
 - Műszaki termékspecifikáció

WLL t	L m	sforzo / effort kg	Ft		
0,75	1,5	21	144.900	1	081460308
1,5	1,5	41	190.300	1	081460315
3,0	1,5	41	251.000	1	081460330

0,75	3,0	21	157.100	1	081460408
1,5	3,0	41	209.300	1	081460415
3,0	3,0	41	283.800	1	081460430

Robur

8146C

Kompakt karos láncos emelő

CE

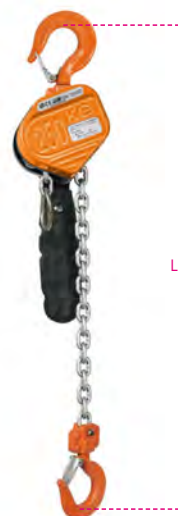

WLL t	L m	sforzo / effort kg	Ft		
0,25	1,5	20,7	105.700	1	081460002

Robur



HALADÓMŰVEK ÉS GERENDAFOGÓK EMELŐKHOZ

Az EN 13157 szabványnak megfelelően tervezett, kézi emelőkhöz tartozó haladóművek hatékonyan segítik a nehéz terhek mozgását.

A görgőcsapágyas kerek, a véghelyzet védelem, a kisiklást gátlók és a normalizált acélból készült központi csavar biztonságos, szilárd rögzítést eredményeznek.

A gerendafogók egyszerű, kényelmes megoldást jelentenek szerkezeti gerendák ideiglenes vagy tartós felfüggesztéséhez. Termékeink teljes nyomkövetettségét a gyártási és sorozatazonosító számmal ellátott azonosító címke biztosítja.



8147C

láncos haladómű
kézi emelőkhöz

tartógerendákhoz (INP, IPB, IPE, HEA, HEB, stb.) alkalmas



EN 13157

Műszaki adatok:

- Biztonsági együttható: 4
- Azonosító címke

Tanúsítványok:

- Gyártói tanúsítvány
- CE Megfelelőségi nyilatkozat
- Vizsgálati jelentés 2.2 UNI EN10204
- Műszaki termékfajta

WLL t	L min mm	L max mm	Lm	Ft	1	2
1,0	58	220	3	117.400	1	081470510
2,0	66	220	3	150.600	1	081470520
3,0	74	220	3	230.400	1	081470530
5,0	90	220	3	317.400	1	081470550

A terméket szétszedett állapotban szállítjuk és használat előtt a használati útmutatónak megfelelően kell összeszerelni.

8147S

haladómű

kézi gerendafogókhöz

tartógerendákhoz (INP, IPB, IPE, HEA, HEB, stb.) alkalmas

CE



EN 13157

Műszaki adatok:

- Biztonsági együttható: 4
- Azonosító címke

Tanúsítványok:

- Gyártói tanúsítvány
- CE Megfelelőségi nyilatkozat
- Vizsgálati jelentés 2.2 UNI EN10204
- Műszaki termékfajta

WLL t	L min mm	L max mm	øF mm	Ft	1	2
0,5	50	220	25	75.700	1	081470005
1,0	58	220	30	96.950	1	081470010
2,0	66	220	40	123.500	1	081470020

A terméket szétszedett állapotban szállítjuk és használat előtt a használati útmutatónak megfelelően kell összeszerelni.

8147P

gerendafogó kézi emelőkhöz

tartógerendákhoz (INP, IPB, IPE, HEA, HEB, stb.) alkalmas

CE

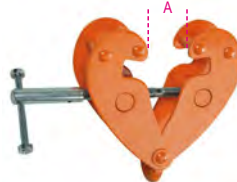

Műszaki adatok:

- Biztonsági együttható: 4
- Azonosító címke

Tanúsítványok:

- Gyártói tanúsítvány
- CE Megfelelőségi nyilatkozat
- Vizsgálati jelentés 2.2 UNI EN10204
- Műszaki termékfajta

WLL t	A min mm	A max mm	Ft	1	2
1,0	90	180	49.800	1	081470210
2,0	90	190	60.300	1	081470220
3,0	85	280	102.000	1	081470230
5,0	85	280	148.600	1	081470250



8148

kézi csőrő,

alumíniumötvözet test,

csőrőkarral, drótkötéllel és horoggal szállítva

Az EN 13517 szabványnak megfelelő, kiemelkedő minőségű anyagból készült könnyű, hordozható Robur karos kézi csőrő terhek emelésére, húzására, megfeszítésére és rögzítésére bármilyen irányban egyaránt alkalmas.

Stabil rögzítési ponthoz kötve a terhek pontos elhelyezését teszi lehetővé és minden irányban – függőlegesen, vízszintesen és ferdén – biztonságos munkavégzést biztosít. Kompakt, praktikus kialakításának köszönhetően felszerelése és használata egyszerű.

A Robur kézi csőrő tetszőleges hosszúságú drótkötéllel használható, a referencia szabványnak megfelelően kiegészítő kampós csigákkal – a csőrőház vizsgálata mellett – a teherbírása 2-, 3-, 4-, vagy akár többszöröse is növelhető.

CE



EN 13157

- Biztonsági együttható: 4:1

WLL t	L m	A mm	øf mm	Ft	1	2
0,8	20	426	8,3	169.200	1	081480008
1,6	20	545	11	264.800	1	081480016
3,2	20	660	16	435.800	1	081480032

0,8	30	426	8,3	188.300	1	081480108
1,6	30	545	11	293.700	1	081480116
3,2	30	660	16	489.700	1	081480132

0,8	50	426	8,3	227.300	1	081480308
1,6	50	545	11	340.300	1	081480316
3,2	50	660	16	592.900	1	081480332

8148F

galvanizált acélsodrony kötél
keresztmetszeten

nagyszilárdságú horoggal

CE



WLL t	L m	øF	Ft	1	2
0,8	20	8,3	45.950	1	081480520
1,6	20	11	72.650	1	081480521
3,2	20	16	141.300	1	081480523

0,8	30	8,3	64.950	1	081480530
1,6	30	11	101.600	1	081480531
3,2	30	16	195.100	1	081480533

0,8	50	8,3	104.000	1	081480550
1,6	50	11	148.200	1	081480551
3,2	50	16	298.400	1	081480553

8120

oldalhegesztett lánc
statikus csatlakozásokhoz
horganyzott



MŰSZAKI ADATOK

- biztonsági együttható: 4
- RENDELKEZÉSRE ÁLLÓ TANÚSÍTVÁNYOK
- Termékleírás
- 2.2 UNI EN10204 típusú Tesztjelentés

Ø mm	nr	WFL kg	m	Ft	📦	🚚
1,5	10	8	150	87.650	1	081200015
1,6	12	15	150	91.300	1	081200016
2,2	14	25	75	53.450	1	081200022
2,7	16	40	75	66.200	1	081200027
3,0	17	55	75	73.050	1	081200030
3,4	18	100	60	74.300	1	081200034
3,8	19	110	50	71.850	1	081200038
4,4	20	200	40	66.600	1	081200044
4,8	21	250	30	63.550	1	081200048
5,5	22	300	25	63.550	1	081200055
5,8	23	310	25	71.850	1	081200058
6,5	24	400	25	81.550	1	081200065
7,0	25	450	25	99.400	1	081200070
7,5	26	550	20	88.650	1	081200075
* 8,0	27	600	25	128.300	1	081200080
* 9,0	28	800	25	161.100	1	081200090
* 10,0	30	1000	20	163.200	1	081200100
* 12,0	32	1400	15	172.900	1	081200120

Figyelem: a termék NEM alkalmazható emeléshez

(*) TEKERCESES kiszerezésben

8120B

oldalhegesztett lánc
statikus csatlakozásokhoz,
horganyzott



MŰSZAKI ADATOK

- biztonsági együttható: 4
- RENDELKEZÉSRE ÁLLÓ TANÚSÍTVÁNYOK
- Termékleírás
- 2.2 UNI EN10204 típusú Tesztjelentés

Ø mm	nr	WFL kg	m	Ft	📦	🚚
1,5	10	8	200	109.300	1	081200315
1,6	12	15	200	115.400	1	081200316
2,2	14	25	100	68.200	1	081200322
2,7	16	40	100	87.250	1	081200327
3,0	17	55	75	72.850	1	081200330
3,4	18	100	100	115.800	1	081200334
3,8	19	110	75	102.800	1	081200338
4,4	20	200	50	79.550	1	081200344
4,8	21	250	50	102.800	1	081200348
5,5	22	300	40	98.400	1	081200355
5,8	23	310	30	84.200	1	081200358
6,5	24	400	30	95.950	1	081200365
7,0	25	450	25	96.950	1	081200370
7,5	26	550	25	106.900	1	081200375
8,0	27	600	15	82.400	1	081200380
9,0	28	800	15	97.350	1	081200390
10,0	30	1000	10	79.750	1	081200400
12,0	32	1400	8	92.100	1	081200420

Figyelem: a termék NEM alkalmas emeléshez

8121MZC

Oldalhegesztett lánc tekerces
statikus csatlakozásokhoz,
tűzhorganyzott



TANÚSÍTVÁNYOK

- Termékspecifikáció
- Vizsgálati jelentés 2.2 UNI EN10204

Ø mm	nr	WFL kg	m	Ft	📦	🚚
6,0	23	310	50	157.100	1	081210306
8,0	27	600	50	268.400	1	081210308
10,0	30	1000	50	424.700	1	081210310
12,0	32	1400	50	609.300	1	081210312
14,0	34	1800	50	858.300	1	081210314

8120D

kalibrált láncok DIN766
galvanikusan horganyzott
kérésre bármilyen méretben kapható (>30m)



MŰSZAKI ADATOK

- biztonsági együttható: 4
- TANÚSÍTVÁNYOK
- Műszaki termékspecifikáció
- Vizsgálati jelentés 2.2 UNI EN10204

Ø mm	P mm	WFL kg	m	Ft	📦	🚚
4	16	200	30	54.850	1	081200640
5	18,5	320	30	77.300	1	081200650
6	18,5	400	30	117.000	1	081200660
7	22	630	30	140.900	1	081200670
8	24	800	30	186.200	1	081200680
10	28	1250	30	284.200	1	081200700

kalibrált láncok DIN766

tűzhorganyzott

Ø mm	P mm	WFL kg	m	Ft	📦	🚚
4	16	200	30	68.200	1	081200840
5	18,5	320	30	93.300	1	081200850
6	18,5	400	30	138.500	1	081200860
7	22	630	30	162.800	1	081200870
8	24	800	30	216.200	1	081200880
10	28	1250	30	326.700	1	081200900

8129

zárólánc,
vörösre és fehérre festett horganyzott fémből



Ø mm	m	Ft	📦	🚚
5	30	115.800	1	081290050

Figyelem: a termék NEM használható emeléshez vagy rögzítéshez

8130

lopásvédő lánc ötvöztött acélból
edzett és lágyított
horganyzott



Ø mm	L mm	Ft	📦	🚚
6	800	7.000	1	081300068
8	1000	15.200	1	081300081
8	1200	17.200	1	081300082
10	1500	26.300	1	081300105

8074

Speciális csomagolások



DIN 5299 tipo C

DxL mm	A mm	WFL kg	Ft	📦	🚚
* 4x40	6	20	285	100	080740040
5x50	7	30	290	100	080740050
6x60	8	40	320	100	080740060
7x70	9	60	410	50	080740070
8x80	11	75	495	50	080740080
9x90	12	100	670	25	080740090
10x100	13	120	905	25	080740100
11x120	16	140	1.230	20	080740101
12x140	22	140	1.720	15	080740102
13x160	24	200	2.370	10	080740103
* 14x180	32	250	4.940	5	080740104



DxL mm	A mm	WFL kg	Ft	📦	🚚
6x60	8	50	18.000	1	080740760
7x70	9	25	11.500	1	080740770
8x80	11	25	13.900	1	080740780
9x90	12	15	11.350	1	080740790
10x100	13	15	15.300	1	080740800
11x120	16	10	13.900	1	080740801
12x140	22	10	19.350	1	080740802

8074A

gyűrűs karabiner, galvanizált



DIN 5299 tipo A

MŰSZAKI ADATOK

- Min. biztonsági koeficiens: 4
- RENDELKEZÉSRE ÁLLÓ TANÚSÍTVÁNYOK
- Termékleírás
- Vizsgálati jelentés 2.2 UNI EN10204

øAxL mm	D mm	WFL kg	Ft		
5x50	7,4	30	390	50	080740405
6x60	8,7	40	450	50	080740406
8x80	10,5	75	615	25	080740408
10x100	13,3	120	1.080	10	080740410

8074G

Karabiner horog anyával, galvanizált

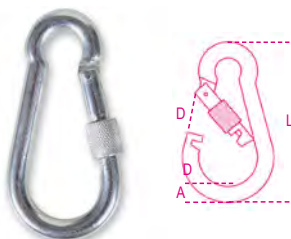

MŰSZAKI ADATOK

- Min. biztonsági koeficiens: 4
- RENDELKEZÉSRE ÁLLÓ TANÚSÍTVÁNYOK
- Termékleírás
- Vizsgálati jelentés 2.2 UNI EN10204

øAxL mm	D mm	WFL kg	Ft		
5x50	7,5	30	440	50	080740305
6x60	8,5	40	500	50	080740306
8x80	10,3	75	670	25	080740308
10x100	10,6	120	1.140	10	080740310



8080

Gyorscsatlakozó szem, galvanizált



MŰSZAKI ADATOK

- Min. biztonsági koeficiens: 4
- RENDELKEZÉSRE ÁLLÓ TANÚSÍTVÁNYOK
- Termékleírás
- Vizsgálati jelentés 2.2 UNI EN10204

DxL mm	A mm	WFL kg	Ft		
3,5x36	5	20	230	100	080800003
4x40	6	30	250	100	080800004
5x49	6	50	305	100	080800005
6x57	8	60	380	100	080800006
7x66	8	100	495	50	080800007
8x74	11	140	585	50	080800008
9x80	11	160	845	25	080800009
10x89	11	220	990	25	080800010
12x105	15	300	1.720	20	080800012
14x122	16,5	400	3.700	3	080800014

8050 D1=D45

biztosítóelem készlet emelőhorgokhoz



	Ft		
8050D1 8064S-8065SC/800-8055S/1250	3.640	1	080500945
8050D2 8064S-8065SC/1000 8062/1500-8055S/1600	4.250	1	080500946
8050D3 8064S-8065SC/1600-2000 8055S/2500-3200	4.570	1	080500947
8050D4 8064S-8065SC/3200-8055S/5400	7.610	1	080500948
8050D5 8064S-8065SC/5000-8055S/8000	8.830	1	080500949
8050D6 8064S/7500-8055S/11500	13.950	1	080500950
8050D11 8062/2000	7.250	1	080500955
8050D12 8062/3000	8.020	1	080500956
8050D13 8062/5000	14.550	1	080500957
8050D22 8064S/10000 8055S/16000	19.250	1	080500966
8050D23 8055S/22000	26.500	1	080500967
8050D24 8051S/250	335	1	080500969
8050D25 8051S/500	395	1	080500970
8050D32 8060/8000	14.750	1	080500977
8050D 33 8052/800	1.480	1	080500978
8050D 34 8052/1120	1.640	1	080500979
8050D 35 8052/2000	2.020	1	080500980
8050D 36 8052/3150	2.210	1	080500981
8050D 37 8052/4000	2.610	1	080500982

8050D38 8060R/1120	960	1	080500983
8050D53 8060R/1500	1.300	1	080500994
8050D39 8060R/2000	1.300	1	080500984
8050D40 8060R/3150	2.270	1	080500985
8050D41 8060R/5300	3.500	1	080500986
8050D42 8063/800	335	1	080500987
8050D43 8063/1120	475	1	080500988
8050D44 8063/2000	620	1	080500989
8050D45 8063/3150	760	1	080500990



8050D46 8061R/1120	990	1	080500991
8050D47 8061R/2000	990	1	080500992
8050D48 8061R/3150	1.360	1	080500993
8050D54 8061R/5300	1.360	1	080500995
8050D30 8061R/8000	10.700	1	080500975



8050D49 8057R - 8058R - 8063SL /1120	2.730	1	080500849
8050D50 8057R - 8058R - 8063SL /2000	2.980	1	080500850
8050D51 8057R - 8058R - 8063SL /3150	3.260	1	080500851
8050D52 8057R - 8058R - 8063SL /5300	7.290	1	080500852

8058R/PS

csapszeg készlet 8058R-8061R horgokhoz



	Ø mm	Ft		
8058R/PS 1,12	6	3.180	1	080580512
8058R/PS 2,0	7-8	3.640	1	080580520
8058R/PS 3,15	10	7.290	1	080580532
8058R/PS 5,3	13	12.550	1	080580553

8060R/PS

csapszeg készlet 8060R horgokhoz



	Ø mm	Ft		
8060R/PS 1,12	6	3.180	1	080600511
8060R/PS 1,5	7	3.640	1	080600515
8060R/PS 2,0	8	3.640	1	080600520
8060R/PS 3,15	10	7.290	1	080600532
8060R/PS 5,3	13	12.550	1	080600553



8135/KLA1

működtető kar készlet
a 8135 megfogóhoz



8135 t	Ft		
0,75	7.170	1	081350605
1,00	8.910	1	081350610
2,00	10.300	1	081350615
3,00	12.550	1	081350620
5,00	19.250	1	081350625

A javításokért a felelősség a szerelőt terheli.

8135/KM0

rugókészlet a 8135 megfogóhoz



8135 t	Ft		
0,75	3.180	1	081350655
1,00	4.620	1	081350660
2,00	6.070	1	081350665
3,00	7.810	1	081350670
5,00	11.550	1	081350675

A javításokért a felelősség a szerelőt terheli.

8143/RKL

kiakadástgátlós felső és alsó horog készlet
a 8143 kézi, láncos emelőhöz



8143 WLL t	Ft		
0,5	645	1	081430500
1,0	745	1	081430501
1,5	935	1	081430499
2,0	1.120	1	081430502
3,0	1.320	1	081430503
5,0	1.540	1	081430504

8143/RPC

horog csap készlet
a 8143 kézi, láncos emelőhöz



8143 WLL t	Ft		
0,5	775	1	081430510
1,0	1.060	1	081430511
1,5	1.070	1	081430509
2,0	1.150	1	081430512
3,0	1.860	1	081430513
5,0	2.020	1	081430514

8143/RPF

zár készlet
a 8143 kézi, láncos emelőhöz



8143 WLL t	Ft		
0,5	350	1	081430520
1,0	370	1	081430521
1,5	380	1	081430519
2,0	525	1	081430522
3,0	410	1	081430523
5,0	645	1	081430524

8143/RKCI

alsó horog készlet
a 8143 kézi, láncos emelőhöz



8143 WLL t	Ft		
0,5	4.980	1	081430560
1,0	6.560	1	081430561
1,5	10.700	1	081430559
2,0	12.350	1	081430562
3,0	40.100	1	081430563
5,0	55.250	1	081430564
10,0	86.850	1	081430565

8146/RK

biztosítóelemek, csapok és zárak
a 8146C-8146 kézi KAROS láncos emelőkhöz



8146C-8146 WLL t	Ft		
0,25	2.490	1	081460902

8146/RKL

kiakadástgátló felső és alsó horoghoz
a 8146 kézi, láncos emelőhöz



8146 WLL t	Ft		
0,75	745	1	081460500
1,5	855	1	081460501
3,0	1.320	1	081460502
6,0	1.500	1	081460503

8146/RPC

horog csap készlet
a 8146 kézi, láncos emelőhöz



8146 WLL t	Ft		
0,75	775	1	081460510
1,5	1.150	1	081460511
3,0	1.210	1	081460512
6,0	1.210	1	081460513

8146/RKFC

zár készlet
a 8146 kézi, láncos emelőhöz



8146 WLL t	Ft		
0,75	2.040	1	081460520
1,5	2.630	1	081460521
3,0	2.810	1	081460522
6,0	3.300	1	081460523

8146/RKCI

alsó horog készlet
a 8146 kézi, láncos emelőhöz



8146 WLL t	Ft		
0,75	5.710	1	081460560
1,5	12.350	1	081460561
3,0	40.100	1	081460562
6,0	75.700	1	081460563

8147S/RKR

Kerék készlet 8147S haladóműhöz



WLL t	Ft		
0,5	24.500	1	081470900
1,0	28.750	1	081470901
2,0	43.700	1	081470902

8147C/RKR

Kerék készlet 8147C láncos haladóműhöz



WLL t	Ft		
1,0	29.350	1	081470951
2,0	45.350	1	081470952
3,0	77.550	1	081470953
5,0	109.300	1	081470955

8148/RA

keresztmű a 8148 kézi csörlőben használt drótkötelekhez



8148 t	Ft		
0,8	9.070	1	081480900
1,6	12.350	1	081480901
3,2	15.800	1	081480902

8148/RKS

3 darabos biztonsági csapszeg készlet a 8148 kézi csörlőkhöz



8148 t	Ft		
0,8	1.680	1	081480903
1,6 - 3,2	2.090	1	081480904

8148/RKCM

2 darabos markolatvédő készlet a 8148 kézi csörlőkhöz



8148/RKCM	Ft		
	760	1	081480905

8148/RKCL

2 darabos emelőrúd védő készlet a 8148 kézi csörlőkhöz



8148/RKCL	Ft		
	810	1	081480906

8148/RP

horgonycsapok a 8148 kézi csörlőkhöz



8148 t	Ft		
0,8	6.960	1	081480907
1,6	9.350	1	081480908
3,2	11.750	1	081480909

8148/RKG

2 darabos védőburkolat készlet a 8148 kézi csörlőkhöz



8148 t	Ft		
0,8	7.170	1	081480910
1,6	8.180	1	081480911
3,2	8.620	1	081480912

8149

lánc

CE

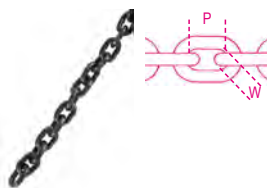

EN 818-7

MŰSZAKI ADATOK

- biztonsági együttható: 4
- hőkezelés: lágyítás
- gyártási sorozatszám

LABORATÓRIUMI ELEMZÉS

- vegyi analízis
- metallográfiai analízis
- szakítópróba

RENDELKEZÉSRE ÁLLÓ TANÚSÍTVÁNYOK

- Termékleírás
- 2.2 UNI EN10204 típusú Tesztjelentés
- EK Megfelelőségi Nyilatkozat

Ø mm	WLL Kg	P mm	W mm	Ft/m		
4	500	12	4,8	6.840	1	081490012
5	800	15	6,0	8.460	1	081490015
6	1100	18	7,2	9.470	1	081490018
6,3	1200	19	7,6	10.500	1	081490019
8	2000	24	9,6	14.150	1	081490024
10	3200	30	12	22.050	1	081490030

8149CM

lánc a 8143 kézi láncos emelőhöz



Ø mm	B mm	t mm	Ft/m		
4,8	8,2	22,2	2.190	1	081490901

* FIGYELEM: Amennyiben a rendelésben másképp nem szerepel, a terméket egy hosszúságú láncsal szállítjuk!

8149CM/RA

tartalék hegesztett gyűrű lánc a 8143 kézi, láncos emelőhöz



L m	Ft		
3	27.950	1	081490903
6	42.100	1	081490906

*Hegesztett zárt gyűrű. A lánc cseréje előtt olvassa el a kézikönyvet.

8149 CMC

Lánc 8147C haladóműhöz



Ø mm	B mm	Ft		
4,7	7	1.680	1	081490600

Robur

ROZSDAMENTES ACÉL

Az általános rozsdamentes acéllal (AISI 304) ellentétben a Beta által használt AISI 316 acél nagyfokú ellenállást biztosít az időjárás viszontagságaival, valamint a sós és szerves savas korrózióval szemben. Az AISI 316 rozsdamentes acélban nagy arányban található az alábbi fémek:

- **Króm** (felületi réteget képez, amely megvédi az alapanyagot az oxidációtól);
- **Molibdén** (növeli a kloridokkal, pl. tengervízzel és a jégtelenítőkkel szembeni korrózióállóságot);
- **Nikkel** (lehetővé teszi az acélváz stabilitásának megőrzését az idők során).

Ezenkívül az alacsony széntartalom miatt ez az acél ellenállóbb a szemcseközi korrózióval szemben (a korrózió egy különleges típusa, a szerelvény felületén alig észlelhető, továbbá korróziós környezetben váratlan anyagtörést okozhat).

Az AISI 316 acél néhány további kiemelt jellemzője: könnyen tisztítható, kiváló higiéniai tényező, nem mágneses tulajdonságokkal és jó mechanikai teljesítménnyel rendelkezik alacsony hőmérsékleten.

Kétségtelen, hogy mindig is az egyenletes, állandó minőség tette és teszi ma is a Robur rozsdamentes acélból készült termékeit kiemelten megbízhatóvá. Ez biztosítja, hogy minden múltban, jelenben és jövőben legyártott termék azonos teljesítményszintet érjen el.

Robur
INOX
STAINLESS STEEL



8205

Speciális csomagolások

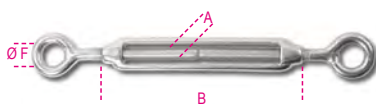

A mm	B mm	ØF mm	WFL kg	Ft	📦	🚚
M4	62	8	75	2.730	10	082050204
M5	72	11	115	3.280	10	082050205
M6	92	12	160	4.330	8	082050206
M8	122	14	300	6.680	8	082050208
M10	150	16	470	10.100	4	082050210
M12	201	18	690	17.200	1	082050212
M14	225	22	940	42.700	1	082050214
M16	244	26	1290	43.700	1	082050216
M20	295	29	2130	62.950	1	082050220
M24	350	33	3000	144.100	1	082050224



A mm	B mm	📦	Ft	🚚
M4	62	5	15.350	1 082050704
M5	72	5	18.450	1 082050705
M6	92	4	19.500	1 082050706
M8	122	4	30.050	1 082050708
M10	150	2	22.700	1 082050710



8206

Horgos és szemes feszítőszerelvény AISI 316

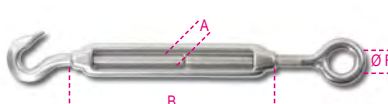

LABORELEMZÉSEK

- Kémiai elemzés
 - Szakítópróba
- RENDELKEZÉSRE ÁLLÓ TANÚSÍTVÁNYOK
- Termékleírás
 - Vizsgálati jelentés 2.2 UNI EN10204

A mm	B mm	ØF mm	WFL kg	Ft	📦	🚚
M5	72	11	25	3.320	10	082060205
M6	92	12	45	4.570	5	082060206
M8	122	14	95	7.000	5	082060208
M10	150	16	140	10.700	1	082060210
M12	201	18	300	17.800	1	082060212
M14	225	22	420	42.900	1	082060214
M16	244	26	570	43.900	1	082060216
M20	295	29	875	64.150	1	082060220

8207

Mindkét oldalon horgos feszítőszerelvény AISI 316

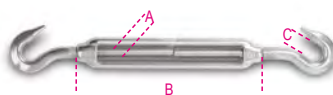

LABORELEMZÉSEK

- Kémiai elemzés
 - Szakítópróba
- RENDELKEZÉSRE ÁLLÓ TANÚSÍTVÁNYOK
- Termékleírás
 - Vizsgálati jelentés 2.2 UNI EN10204

A mm	B mm	C mm	WFL kg	Ft	📦	🚚
M5	72	9	25	3.520	10	082070205
M6	92	9	45	4.620	5	082070206
M8	122	10	95	7.130	5	082070208
M10	150	12	140	10.950	1	082070210
M12	201	14	300	18.000	1	082070212
M14	225	15	420	43.700	1	082070214
M16	244	16	570	45.150	1	082070216
M20	295	19	875	66.400	1	082070220

8209

Mindkét oldalon kengyeles feszítőszerelvény AISI 316

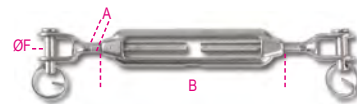

LABORELEMZÉSEK

- Kémiai elemzés
 - Szakítópróba
- RENDELKEZÉSRE ÁLLÓ TANÚSÍTVÁNYOK
- Termékleírás
 - Vizsgálati jelentés 2.2 UNI EN10204

A mm	B mm	ØF mm	WFL kg	Ft	📦	🚚
M5	72	5	115	5.870	5	082090205
M6	92	6	160	6.920	5	082090206
M8	122	8	300	9.920	5	082090208
M10	150	10	470	16.200	1	082090210
M12	201	12	690	26.300	1	082090212
M14	225	14	940	35.400	1	082090214
M16	244	16	1290	53.450	1	082090216
M20	295	20	2130	93.900	1	082090220
M24	350	24	3060	227.900	1	082090224

8210

Kengyeles és anyás feszítőszerelvény AISI 316

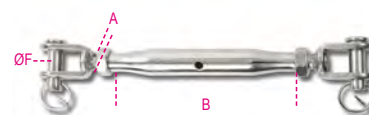

LABORELEMZÉSEK

- Kémiai elemzés
 - Szakítópróba
- RENDELKEZÉSRE ÁLLÓ TANÚSÍTVÁNYOK
- Termékleírás
 - Vizsgálati jelentés 2.2 UNI EN10204

A mm	B mm	ØF mm	WFL kg	Ft	📦	🚚
M5	81	5	115	7.410	3	082100205
M6	92	6	160	8.910	3	082100206
M8	112	8	300	12.950	1	082100208
M10	121	10	470	20.250	1	082100210
M12	150	12	690	33.600	1	082100212
M14	169	14	940	43.700	1	082100214
M16	190	16	1290	64.550	1	082100216
M20	220	20	2130	112.100	1	082100220

8210FTP

drótkötél feszítő szerelvény, kengyel és préselhető cső végekkel
AISI 316 rozsdamentes acél

Nikkellel, krómmal és molibdénnel ötvözött acél a nagyobb korrózióállóság érdekében.



LABORATÓRIUMI VIZSGÁLATOK

- vegyelemzés
 - szakítópróba
- ### TANÚSÍTVÁNYOK
- Műszaki termékspecifikáció
 - Vizsgálati jelentés 2.2 UNI EN10204

Ø mm	A mm	ØD mm	WFL kg	Ft	📦	🚚
M5	159	2,70	150	8.260	2	082100605
M6	179	3,30	250	9.760	2	082100606
M8	216	4,30	350	13.350	1	082100608
M10	241	5,30	550	20.450	1	082100610
M12	300	6,30	1000	29.750	1	082100612
M14	345	7,30	1350	45.150	1	082100614
M16	383	8,30	1625	65.800	1	082100616
M20	484	10,50	2125	111.700	1	082100620

8201T

Csőnyás feszítő, rozsdamentes acél (AISI 316)



LABORATÓRIUMI ELEMZÉS

- vegyi elemzés
 - szakítópróba
- ### RENDELKEZÉSRE ÁLLÓ TANÚSÍTVÁNYOK
- Termékleírás
 - Vizsgálati jelentés a 2.2 UNI EN10204 szerint

Ø mm	Ø" "	WFL kg	L mm	Ft	📦	🚚
M6	1/4	160	95	1.640	5	082010406
M8	5/16	300	105	2.430	5	082010408
M10	3/8	470	125	4.090	3	082010410
M12	1/2	690	150	7.130	3	082010412
M14	9/16	940	165	7.570	1	082010414
M16	5/8	1290	190	12.950	1	082010416
M20	3/4	2130	210	19.450	1	082010420

8210F

Kengyel feszítőszerelvényhez, rozsdamentes acél (AISI 316)

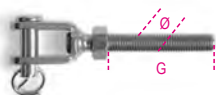

LABORATÓRIUMI TESZTEK

- vegyelemzés
 - szakítópróba
- ### TANÚSÍTVÁNYOK
- Műszaki termékspecifikáció
 - Vizsgálati jelentés 2.2 UNI EN10204

Ø mm	Ø" "	G mm	WFL kg	Ft	📦	🚚
M5	3/16	38,5	115	2.450	4	082100305
M6	1/4	49	160	2.730	4	082100306
M8	5/16	56	300	3.990	4	082100308
M10	3/8	61	470	6.800	2	082100310
M12	1/2	81	690	10.700	2	082100312
M14	9/16	93	940	17.000	2	082100314

Ø mm	Ø" "	G mm	WFL kg	Ft	📦	🚚
M5	3/16	38,5	115	2.450	4	082100405
M6	1/4	49	160	2.730	4	082100406
M8	5/16	56	300	3.990	4	082100408
M10	3/8	61	470	6.800	2	082100410
M12	1/2	81	690	10.700	2	082100412
M14	9/16	93	940	17.400	2	082100414

8248

szemes feszítő
Rozsdamentes acél 316L
jobbmenetes



UNI 6058

RENDELKEZÉSRE ÁLLÓ TANÚSÍTVÁNYOK

- Termékleírás
- 2.2 UNI EN10204 típusú Tesztjelentés

ØxL mm	F mm	Ft	📦	🚚
8X120	6	3.180	1	082480008
10x80	8	4.290	1	082480010
10x130	8	5.750	1	082480012
12x95	10	6.520	1	082480016
12x125	10	7.730	1	082480018

8249

Rögzítő szemescsavar jobbos menettel
AISI 316



LABORELEMZÉSEK

- Kémiai elemzés
 - Szakítópróba
- ### RENDELKEZÉSRE ÁLLÓ TANÚSÍTVÁNYOK
- Termékleírás
 - Vizsgálati jelentés 2.2 UNI EN10204

A mm	WFL kg	D mm	Ft	📦	🚚
M5	100	50	1.190	10	082490205
M6	160	55	1.500	10	082490206
M8	300	60	2.410	5	082490208
M10	470	80	4.290	5	082490210
M12	690	120	7.490	2	082490212

8249E

Horog rögzítőbetéhez, rozsdamentes acél
(AISI 316)



LABORATÓRIUMI ELEMZÉS

- vegyi elemzés
 - szakítópróba
- ### RENDELKEZÉSRE ÁLLÓ TANÚSÍTVÁNYOK
- Termékleírás
 - Vizsgálati jelentés a 2.2 UNI EN10204 szerint

A mm	E mm	ØF mm	WFL kg	Ft	📦	🚚
M5	39	9	25	570	5	082490305
M6	43	10,5	45	680	5	082490306
M8	57	14,5	95	1.190	3	082490308

8216

Speciális csomagolások

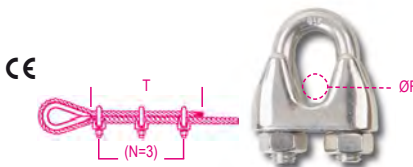

ØF mm	" "	T mm	N mm	Ft	📦	🚚
2	5/64	80	3	1.380	20	082160202
3	1/8	80	3	1.400	20	082160203
4	5/32	80	3	1.580	20	082160204
5	3/16	110	3	1.780	20	082160205
6	1/4	120	5	2.000	10	082160206
8	5/16	210	5	2.650	10	082160208
10	3/8	240	5	3.700	8	082160210
12-13	1/2	300	5	5.140	5	082160213
16	5/8	335	5	7.570	5	082160216
20	3/4	540	5	9.550	5	082160220
22	7/8	595	7	15.400	3	082160222



ØF mm	" "	Ft	📦	🚚	
2	5/64	10	15.500	1	082160702
3	1/8	10	15.700	1	082160703
4	5/32	10	17.750	1	082160704
5	3/16	10	20.050	1	082160705
6	1/4	5	11.250	1	082160706
8	5/16	5	14.900	1	082160708
10	3/8	4	16.650	1	082160710

Különleges csomagolások szabad
szolgáltatáshoz



ØF mm	📦	Ft	📦	🚚
2	4	5.830	1	082169402
3	4	5.870	1	082169403
4	4	6.600	1	082169404
5	2	3.990	1	082169405
6	2	4.490	1	082169406
8	2	5.830	1	082169408
10	2	7.890	1	082169410



ø D mm	"		Ft		
4	5/32	10	16.400	1	082250704
5	3/16	10	18.000	1	082250705
6	1/4	5	9.790	1	082250706
8	5/16	5	15.950	1	082250708
10	3/8	4	18.400	1	082250710

8227

Hosszú egyenes kengyelcsavar
AISI 316



LABORELEMZÉSEK

- Kémiai elemzés
 - Szakítópróba
- RENDELKEZÉSRE ÁLLÓ TANÚSÍTVÁNYOK
- Termékleírás
 - Vizsgálati jelentés 2.2 UNI EN10204

ø D mm	"	A mm	WFL kg	Ft		
4	5/32	8	50	1.210	10	082270204
5	3/16	10	70	1.400	10	082270205
6	1/4	13,5	100	1.780	5	082270206
8	5/16	17	250	2.910	5	082270208
10	3/8	21	400	4.820	2	082270210
12	1/2	25	600	7.610	1	082270212

8228

Ivelt kengyelcsavar
AISI 316

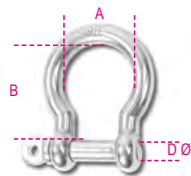

LABORELEMZÉSEK

- Kémiai elemzés
 - Szakítópróba
- RENDELKEZÉSRE ÁLLÓ TANÚSÍTVÁNYOK
- Termékleírás
 - Vizsgálati jelentés 2.2 UNI EN10204

ø D mm	A mm	B mm	WFL kg	Ft		
4	13	20	60	1.110	10	082280204
5	17	23	80	1.280	10	082280205
6	20	27	100	1.460	10	082280206
8	28	36	200	2.310	5	082280208
10	36	44	300	3.700	5	082280210
12	41	53	500	5.910	5	082280212
16	54	74	800	12.950	1	082280216
19	66	86	1100	23.700	1	082280219

8240F

Emelő fülescsavar, A4
belső, KOVÁCSOLT, rozsdamentes acél (AISI 316)



MŰSZAKI ADATOK

- Min. biztonsági együttható: 6
- Gyártási száma

LABORELEMZÉSEK

- Kémiai elemzés
- Metallográfiai elemzés
- Szakítópróba

RENDELKEZÉSRE ÁLLÓ TANÚSÍTVÁNYOK

- Termékleírás
- Vizsgálati jelentés 2.2 UNI EN10204
- Ellenőrzési tanúsítvány 3.1 UNI EN10204
- CE-Megfelelőségi nyilatkozat

ø mm	WFL mm	WLL kg	Ft		
M6	1,0	120	3.320	4	082400406
* M8	1,25	200	3.700	4	082400408
* M10	1,5	400	6.230	4	082400410
* M12	1,75	600	10.100	4	082400412
* M14	2	1000	16.200	2	082400414
* M16	2	1200	16.200	2	082400416
* M20	2,5	2000	26.300	2	082400420
* M24	3	2700	49.600	2	082400424
* M30	3,5	4000	110.100	1	082400430

8240

Emelő szemecsavar
AISI 316



LABORELEMZÉSEK

- Kémiai elemzés
 - Szakítópróba
- RENDELKEZÉSRE ÁLLÓ TANÚSÍTVÁNYOK
- Termékleírás
 - Vizsgálati jelentés 2.2 UNI EN10204

A mm	B mm	ø C mm	WFL kg	Ft		
M6	41	15	90	950	10	082400206
M8	50	20	140	1.420	10	082400208
M10	62	25	230	2.850	5	082400210
M12	74	30	340	4.820	5	082400212

8220

Kötélszív
AISI 316

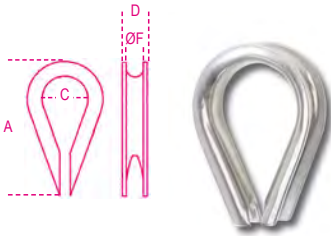

LABORELEMZÉSEK

- Kémiai elemzés
- RENDELKEZÉSRE ÁLLÓ TANÚSÍTVÁNYOK
- Termékleírás
 - Vizsgálati jelentés 2.2 UNI EN10204

ø F mm	D mm	A mm	C mm	Ft		
2	4,5	21	7,5	450	15	082200202
3	6	24	10	495	15	082200203
4	6,6	28	11	570	10	082200204
5	8,5	30	13	680	10	082200205
6	10	37	15	775	10	082200206
8	12,5	51	23	1.210	5	082200208
10	14,6	56	27	1.500	5	082200210
12	18	68	32	2.040	5	082200212
14	19	69	34	2.650	5	082200214
16	22	83	37	2.980	5	082200216
18	23	81	38	3.520	1	082200218
20	27,8	105	45	4.130	1	082200220
22	29,6	112	45	5.380	1	082200222

8225

Speciális csomagolások



ø D mm	"	A mm	WFL kg	Ft		
4	5/32	8	50	1.460	20	082250204
5	3/16	11	70	1.600	20	082250205
6	1/4	13	100	1.740	10	082250206
8	5/16	17	250	2.830	10	082250208
10	3/8	21	400	4.090	8	082250210
12	1/2	25	600	6.680	3	082250212
16	5/8	32	1000	14.750	1	082250216
19	3/4	38	1600	24.500	1	082250219
22	7/8	43	2000	38.050	1	082250222
25	1	46	2800	55.650	1	082250225



8242F

Emelő fülescsavar, A4
külső, KOVÁCSOLT, rozsdamentes acél (AISI 316)

CE



MŰSZAKI ADATOK

• Min. biztonsági koefficiens: 6

• Gyártási száma

LABORELEMZÉSEK

• Kémiai elemzés

• Metallográfiai elemzés

• Szakítópróba

RENDELKEZÉSRE ÁLLÓ TANÚSÍTVÁNYOK

• Termékleírás

• Vizsgálati jelentés 2.2 UNI EN10204

• Ellenőrzési tanúsítvány 3.1 UNI EN10204

• CE-Megfelelőségi nyilatkozat

Ø mm	WLL mm	WLL kg	Ft	📦	🚚
M6	1,0	120	3.320	4	082420406
* M8	1,25	200	3.700	4	082420408
* M10	1,5	400	6.230	4	082420410
* M12	1,75	600	10.100	4	082420412
* M14	2	1000	16.200	2	082420414
* M16	2	1200	16.200	2	082420416
* M20	2,5	2000	26.300	2	082420420
* M24	3	2700	49.600	2	082420424
* M30	3,5	4000	110.100	1	082420430

8242

Emelő gyűrűs anya
AISI 316



A mm	B mm	Ø C mm	WFL mm	Ft	📦	🚚
M6	27	15	90	950	10	082420206
M8	36	20	140	1.420	10	082420208
M10	45	25	230	2.850	5	082420210
M12	55	30	340	4.820	5	082420212

8274

Speciális csomagolások

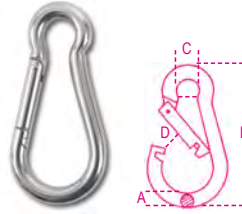

Ø A x L mm	Ø C mm	D mm	WFL mm	Ft	📦	🚚
4,5x40	6,5	6	20	1.300	20	082740204
5x50	7	6,5	30	1.300	20	082740205
6x60	8,5	7,5	40	1.380	10	082740206
7x70	10	9	60	1.640	10	082740207
8x80	12	10	75	2.210	10	082740208
9x90	12,5	10,5	100	3.040	10	082740209
10x100	15	13	120	3.770	8	082740210
11x120	19	18	140	5.380	1	082740211
12x140	22	21	140	7.330	1	082740212
13x160	22	26	200	9.230	1	082740213



Ø A x L mm	Ø C mm	📦	Ft	📦	🚚
4,5x40	6,5	10	14.550	1	082740704
5x50	7	10	14.550	1	082740705
6x60	8,5	5	7.740	1	082740706
7x70	10	5	9.220	1	082740707
8x80	12	5	12.400	1	082740708
9x90	12,5	5	17.100	1	082740709
10x100	15	4	16.950	1	082740710

8274A

Gyűrűs karabiner, rozsdamentes acél (AISI 316)

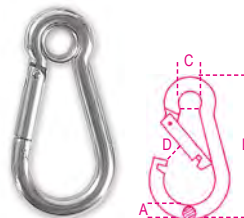

LABORATÓRIUMI ELEMZÉS

• vegyi elemzés

• szakítópróba

RENDELKEZÉSRE ÁLLÓ TANÚSÍTVÁNYOK

• Termékleírás

• Vizsgálati jelentés a 2.2 UNI EN10204 szerint

Ø A x L mm	Ø C mm	D mm	WFL mm	Ft	📦	🚚
5x50	6,5	7	30	1.280	10	082740405
6x60	7,5	7,5	40	1.540	5	082740406
8x80	9,5	10	75	2.530	5	082740408

8274G

Karabiner horog anyával, rozsdamentes acél (AISI 316)

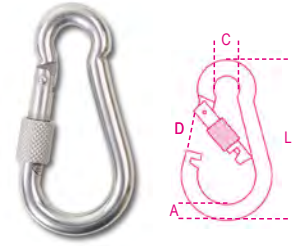

LABORELEMZÉSEK

• Kémiai elemzés

• Szakítópróba

RENDELKEZÉSRE ÁLLÓ TANÚSÍTVÁNYOK

• Termékleírás

• Vizsgálati jelentés 2.2 UNI EN10204

Ø A x L mm	Ø C mm	D mm	WFL mm	Ft	📦	🚚
6x60	8,5	6,5	40	1.700	5	082740306
8x80	12	8,5	75	3.060	5	082740308
10x100	15	12	120	5.830	3	082740310

8276

Asszimmetrikus karabiner horog
AISI 316

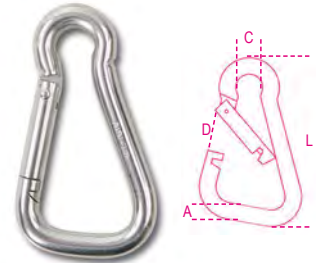

LABORELEMZÉSEK

• Kémiai elemzés

• Szakítópróba

RENDELKEZÉSRE ÁLLÓ TANÚSÍTVÁNYOK

• Termékleírás

• Vizsgálati jelentés 2.2 UNI EN10204

Ø A x L mm	Ø C mm	D mm	WFL mm	Ft	📦	🚚
6x60	8,5	10	40	1.540	5	082760206
8x80	12	14	75	2.650	5	082760208
10x100	15	18	120	4.700	3	082760210

Robur

Robur

8276G

Asszimmetrikus karabiner horog,
rozsdamentes acél (AISI 316)

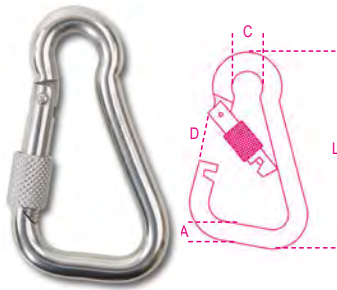

LABORELEMZÉSEK

- Kémiai elemzés
- Szakítópróba
- RENDELKEZÉSRE ÁLLÓ TANUSÍTVÁNYOK
- Termékleírás
- Vizsgálati jelentés 2.2 UNI EN10204

ø A x L mm	ø C mm	D mm	WFL kg	Ft		
6x60	8,5	9	40	1.960	3	082760306
8x80	12	12,5	75	3.520	3	082760308
10x100	15	16	120	6.400	3	082760310

8278

Trapézhorog
AISI 316

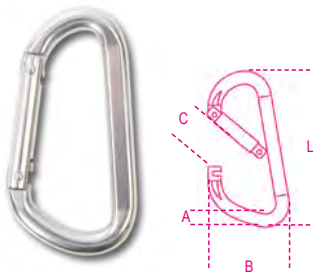

LABORELEMZÉSEK

- Kémiai elemzés
- Szakítópróba
- RENDELKEZÉSRE ÁLLÓ TANUSÍTVÁNYOK
- Termékleírás
- Vizsgálati jelentés 2.2 UNI EN10204

ø A x L mm	B mm	C mm	WFL kg	Ft		
8x80	45	14	75	5.910	3	082780208
10x100	55	16	120	9.230	3	082780210

Robur

8280

Gyorscsatlakozó szem
AISI 316

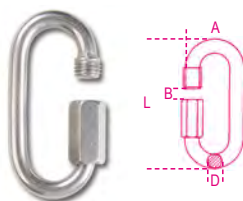

LABORELEMZÉSEK

- Kémiai elemzés
- Szakítópróba
- RENDELKEZÉSRE ÁLLÓ TANUSÍTVÁNYOK
- Termékleírás
- Vizsgálati jelentés 2.2 UNI EN10204

ø D x L mm	A mm	B mm	WFL kg	Ft		
3,5x35	17	5	20	1.520	10	082800203
4x40	19	6	30	1.600	10	082800204
5x50	23	7	50	1.960	5	082800205
6x60	26	8	60	2.310	5	082800206
7x70	30	9	100	2.650	5	082800207
8x80	33	10	140	3.740	2	082800208
10x90	40	12	220	6.110	2	082800210
12x100	47	14	300	9.230	1	082800212

8250

Rugós füles horgok retesszel
AISI 316



LABORELEMZÉSEK

- Kémiai elemzés
- Szakítópróba
- RENDELKEZÉSRE ÁLLÓ TANUSÍTVÁNYOK
- Termékleírás
- Vizsgálati jelentés 2.2 UNI EN10204

L mm	A mm	ø B mm	WFL kg	Ft		
50	25	8	40	1.900	5	082500205
70	31	12,5	90	2.890	5	082500207
100	47	20	190	4.700	2	082500210

8264

Forgószem
AISI 316

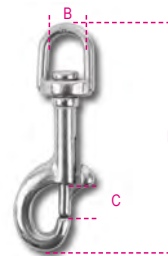

LABORELEMZÉSEK

- Kémiai elemzés
- Szakítópróba
- RENDELKEZÉSRE ÁLLÓ TANUSÍTVÁNYOK
- Termékleírás
- Vizsgálati jelentés 2.2 UNI EN10204

B mm	L mm	C mm	WFL kg	Ft		
12	88	12	60	5.060	5	082640212
16	90	12	60	5.260	5	082640216
19	93	12	60	5.300	2	082640219

8267

Rugós füles horog
AISI 316



LABORELEMZÉSEK

- Kémiai elemzés
- Szakítópróba
- RENDELKEZÉSRE ÁLLÓ TANUSÍTVÁNYOK
- Termékleírás
- Vizsgálati jelentés 2.2 UNI EN10204

A mm	L mm	B mm	WFL kg	Ft		
10	87	21	30	4.490	5	082670210
12	118	22	70	7.530	2	082670213

Robur

8272

Mindkét oldalos szemes forgószem
AISI 316

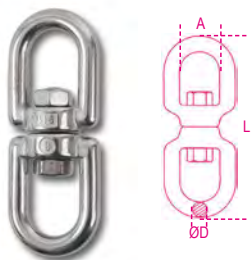

LABORELEMZÉSEK

- Kémiai elemzés
- Szakítópróba
- RENDELKEZÉSRE ÁLLÓ TANÚSÍTVÁNYOK
- Termékleírás
- Vizsgálati jelentés 2.2 UNI EN10204

Ø D mm	A mm	L mm	WFL kg	Ft		
4	11	50	90	2.530	5	082720204
5	13	60	115	3.320	5	082720205
6	15	66	140	4.090	5	082720206
8	19	90	250	6.600	3	082720208
10	23	112	300	10.100	1	082720210
13	33	148	650	20.450	1	082720213
16	38	184	1000	38.250	1	082720216
19	40	223	1600	68.400	1	082720219

8273

Karabiner horog gyorscsatlakozóval
és szemes forgószem
Nemesacél AISI 316

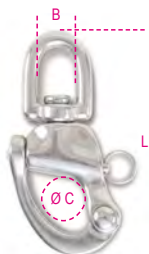

LABORELEMZÉSEK

- Kémiai elemzés
- Szakítópróba
- RENDELKEZÉSRE ÁLLÓ TANÚSÍTVÁNYOK
- Termékleírás
- Vizsgálati jelentés 2.2 UNI EN10204

Ø C x L mm	B mm	WFL kg	BF kg	Ft		
12x70	12	230	1100	7.730	1	082730012
16x85	14,50	440	2000	10.700	1	082730016
22x120	20	700	3500	17.000	1	082730022

8282S

Szimmetrikus "S" horog, rozsdamentes acél
(AISI 316)

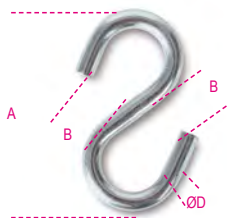

LABORATÓRIUMI ELEMZÉS

- vegyi elemzés
- szakítópróba
- RENDELKEZÉSRE ÁLLÓ TANÚSÍTVÁNYOK
- Termékleírás
- Vizsgálati jelentés a 2.2 UNI EN10204 szerint

Ø D mm	B mm	A mm	WFL kg	Ft		
3	5,5	34	4	135	40	082820303
4	7,0	40	5	275	30	082820304
5	9,0	46	12	450	20	082820305
6	10	54	18	750	15	082820306

8284

"Pelikán" horog Nemesacél AISI 316



LABORELEMZÉSEK

- Kémiai elemzés
- Szakítópróba
- RENDELKEZÉSRE ÁLLÓ TANÚSÍTVÁNYOK
- Termékleírás
- Vizsgálati jelentés 2.2 UNI EN10204

Ø C mm	B mm	L mm	WFL kg	Ft		
6	11	73	200	7.490	3	082840006
8	14	98	300	10.100	3	082840008
10	23	143	450	20.850	1	082840010

8285

Kengyeles vég
AISI 316

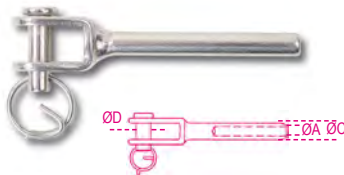

LABORELEMZÉSEK

- Kémiai elemzés
- Szakítópróba
- RENDELKEZÉSRE ÁLLÓ TANÚSÍTVÁNYOK
- Termékleírás
- Vizsgálati jelentés 2.2 UNI EN10204

Ø A M	Ø C mm	Ø D mm	WFL kg	Ft		
3	6,3	6	180	1.500	5	082850203
4	7,5	8	200	2.410	3	082850204
5	9	10	330	3.280	2	082850205
6	12,5	12	720	6.800	2	082850206
7	12,5	12	850	7.290	2	082850207
8	15,5	16	1120	9.800	2	082850208
10	18	16	1300	13.750	2	082850210
12	20	19	2400	16.400	2	082850212

8286

Szemes vég
AISI 316



LABORELEMZÉSEK

- Kémiai elemzés
- Szakítópróba
- RENDELKEZÉSRE ÁLLÓ TANÚSÍTVÁNYOK
- Termékleírás
- Vizsgálati jelentés 2.2 UNI EN10204

Ø D M	Ø A mm	Ø C mm	WFL kg	Ft		
3	6,5	6,3	180	1.540	5	082860203
4	8,5	7,5	200	1.780	3	082860204
5	10	9	330	2.410	2	082860205
6	12,5	12,6	720	3.950	2	082860206
7	12,5	14,2	850	4.250	2	082860207
8	14,5	16	1120	7.130	2	082860208
10	16,4	18	1300	12.550	2	082860210
12	19,3	20	2400	17.800	2	082860212

8287

Közcsavar
AISI 316

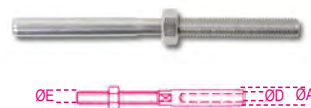

LABORELEMZÉSEK

- Kémiai elemzés
- Szakítópróba
- RENDELKEZÉSRE ÁLLÓ TANÚSÍTVÁNYOK
- Termékleírás
- Vizsgálati jelentés 2.2 UNI EN10204

Ø D M	Ø A mm	E mm	WFL kg	Ft		
3	6,2	M6	180	1.340	5	082870203
4	7,5	M8	200	1.900	3	082870204
5	8,7	M10	330	2.650	2	082870205
6	12,6	M12	720	4.860	2	082870206
7	12,6	M14	850	6.760	2	082870207
8	16	M16	1120	9.800	2	082870208
10	18	M16	1300	10.950	2	082870210
12	20	M20	2400	14.950	2	082870212

 **Robur**

 **Robur**

8290

Szemesvég
AISI 316



LABORELEMZÉSEK

- Kémiai elemzés
- RENDELKEZÉSRE ÁLLÓ TANÚSÍTVÁNYOK
- Termékleírás
- Vizsgálati jelentés 2.2 UNI EN10204

ø A	B	ø C	L	Ft		
5 mm	18 mm	4,3 mm	40 mm	480	5	082900205
6	22	5,2	44	680	5	082900206
8	23	5,2	51	1.070	5	082900208

8381SX

U csőbilincs, rozsdamentes acél (AISI 304)

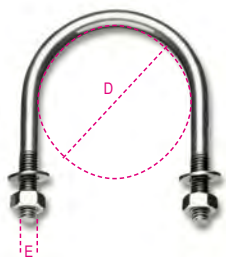

AISI 304

LABORELEMZÉSEK

- Kémiai elemzés
- RENDELKEZÉSRE ÁLLÓ TANÚSÍTVÁNYOK
- Vizsgálati jelentés 2.2 UNI EN10204

D	D	E	Ft		
11 mm	1/8" gas	M6 mm	1.190	20	083810401
14	1/4"	M6	1.210	20	083810402
18	3/8"	M6	1.260	20	083810403
22	1/2"	M6	1.280	20	083810404
27	3/4"	M6	1.300	20	083810405
34	1"	M6	1.380	20	083810406
43	1 1/4"	M6	1.580	20	083810407
49	1 1/2"	M8	2.830	10	083810408
61	2"	M8	3.120	10	083810409
77	2 1/2"	M8	3.580	10	083810410
89	3"	M8	3.990	10	083810412
115	4"	M8	5.140	10	083810413
168	6"	M10	9.800	1	083810416
220	8"	M10	11.750	1	083810418

Robur

8279

oldalhegesztett lánc tekercs
statikus csatlakozásokhoz,
AISI 304 rozsdamentes acél



MŰSZAKI ADATOK

- biztonsági együttható: 4
- TANÚSÍTVÁNYOK
- Műszaki termékspecifikáció
- Vizsgálati jelentés 2.2 UNI EN10204

Ø mm	nr	WFL	m	Ft		
2	13	20	50	115.800	1	082790020
3	17	55	50	210.900	1	082790030
4	19	100	50	297.600	1	082790040
5	21	250	40	326.700	1	082790050
6	23	310	30	332.800	1	082790060
8	27	400	15	326.700	1	082790080
10	30	1000	10	512.100	1	082790400

Figyelem: a termék NEM emeléshez tervezett

8293

racsnis rögzítőrendszer AISI 304
nagy szakítószilárdságú poliészter heveder,
terheléshatár 300 kg
kampós horog
felfüggeszhető csomagolásban

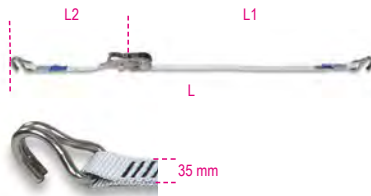

L	L2	L1	STF	Ft		
m	mm	mm	daN			
6	5700	300	100	33.200	1	082930106

LC = 300 kg

8297C

gyűrűs rögzítő rendszer
mini racsival AISI 304
nagy szakítószilárdságú poliészter heveder,
terheléshatár 700 kg
felfüggeszhető csomagolásban

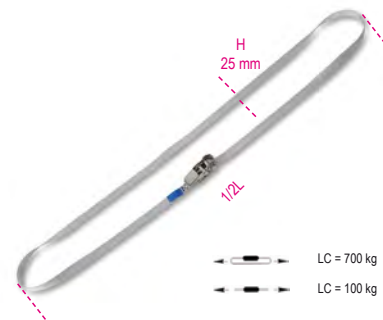

L	H	Ft		
m	mm			
5	25	12.750	1	082970350

8297F

2 gyűrűs rögzítőrendszer
csattal AISI 304
nagy szakítószilárdságú poliészter heveder,
terheléshatár 250 kg
felfüggeszhető csomagolásban

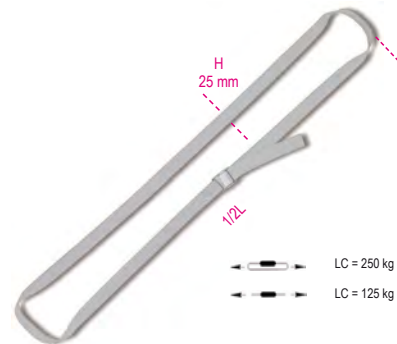

L	H	Ft		
m	mm			
3	25	12.750	1	082970230

LC = 250 kg

Robur

Robur

HEVEDER

Biztonsági faktor 7:1
Gyártó tanúsítvány
UNI EN 1492 szerint
MŰSZAKI ADATOK

- Min. biztonsági koeficiens: 7
 - Gyártási száma

LABORELEMZÉSEK

- Szakítópróba

RENDELKEZÉSRE ÁLLÓ TANÚSÍTVÁNYOK

- Termékleírás
- Vizsgálati jelentés 2.2 UNI EN10204
- Gyártói tanúsítvány UNI EN1492
- CE-Megfelelőségi nyilatkozat

POLIÉSZTER HEVEDEREK

Az UNI EN 1492 európai szabványnak megfelelő poliészter hevederek **könnyűek, könnyen kezelhetőek és hajlékonyak.** Nem károsítják a rakomány felületét, és a teher mozgatása során rugalmasságuknak köszönhetően a húzásokat kontrollálni és tompítani lehet. Ezek a hevederek ideális **megoldást jelentenek a kényes terhek** emelési kihívásaira, amelyeket a kábel- vagy lánchevederek megsérthetnek, valamint korrozív környezetben vagy elektromos vezetés veszélye esetén is alkalmazhatók. A gyártó adatait, a CE-jelölést, a tételszámot és a teherbírasi adatokat tartalmazó, **hevederre varrt címkét védőréteg borítja, így az hosszú idő elteltével is olvasható marad.**



				$\beta = 0^\circ + 45^\circ$	$\beta = 45^\circ + 60^\circ$
	1t	0,8t	2t	1,4t	1t
	2t	1,6t	4t	2,8t	2t
	3t	2,4t	6t	4,2t	3t
	4t	3,2t	8t	5,6t	4t
	5t	4t	10t	7t	5t
	6t	4,8t	12t	8,4t	6t
	8t	6,4t	16t	11,2t	8t
	10t	8t	20t	14t	10t
	12t	9,6t	24t	16,8t	12t
	15t	12t	30t	21t	15t
	20t	16t	40t	28t	20t
	25t	20t	50t	35t	25t
	30t	24t	60t	42t	30t
	40t	32t	80t	56t	40t
	50t	40t	100t	70t	50t

8150

1 t lila emelőheveder
kétrétegű, lapos szalag, erősített karikákkal,
nagy ellenállású polieszter (PES)

CE



EN 1492-1

L m	H mm	WLL ton	Ft		
0,5	30	1	2.130	1	081500005
1	30	1	2.670	1	081500010
1,5	30	1	3.420	1	081500015
2	30	1	3.790	1	081500020
2,5	30	1	4.330	1	081500025
3	30	1	4.820	1	081500030
3,5	30	1	5.340	1	081500035
4	30	1	6.190	1	081500040
5	30	1	7.290	1	081500050
6	30	1	8.380	1	081500060
8	30	1	10.950	1	081500080

8153

2 t zöld emelőheveder
kétrétegű, lapos szalag, erősített karikákkal,
nagy ellenállású polieszter (PES)

CE



EN 1492-1

L m	H mm	WLL ton	Ft		
1	60	2	4.210	1	081530010
1,5	60	2	5.670	1	081530015
2	60	2	6.520	1	081530020
2,5	60	2	7.650	1	081530025
3	60	2	8.870	1	081530030
3,5	60	2	10.300	1	081530035
4	60	2	10.950	1	081530040
5	60	2	13.350	1	081530050
6	60	2	15.800	1	081530060
8	60	2	20.050	1	081530080
10	60	2	24.300	1	081530100



8156

3 t sárga emelőheveder
kétrétegű, lapos szalag, erősített karikákkal,
nagy ellenállású polieszter (PES)

CE



EN 1492-1

L m	H mm	WLL ton	Ft		
1	90	3	5.950	1	081560010
1,5	90	3	7.890	1	081560015
2	90	3	9.760	1	081560020
2,5	90	3	11.550	1	081560025
3	90	3	13.550	1	081560030
3,5	90	3	15.200	1	081560035
4	90	3	16.800	1	081560040
5	90	3	20.250	1	081560050
6	90	3	23.700	1	081560060
8	90	3	30.950	1	081560080
10	90	3	37.850	1	081560100
12	90	3	47.350	1	081560120

8157

4 t szürke emelőheveder
kétrétegű, lapos szalag, erősített karikákkal,
nagy ellenállású polieszter (PES)

CE



EN 1492-1

L m	H mm	WLL ton	Ft		
2	120	4	13.350	1	081570020
3	120	4	17.800	1	081570030
4	120	4	22.850	1	081570040
5	120	4	27.950	1	081570050
6	120	4	32.400	1	081570060
8	120	4	41.900	1	081570080
10	120	4	51.400	1	081570100
12	120	4	75.300	1	081570120

8158

5 t piros emelőheveder
kétrétegű, lapos szalag, erősített karikákkal,
nagy ellenállású polieszter (PES)

CE



EN 1492-1

L m	H mm	WLL ton	Ft		
2	150	5	18.400	1	081580020
3	150	5	24.300	1	081580030
4	150	5	30.950	1	081580040
5	150	5	37.250	1	081580050
6	150	5	44.100	1	081580060
8	150	5	56.900	1	081580080
10	150	5	69.650	1	081580100
12	150	5	102.000	1	081580120

8159

6 t barna emelőheveder
kétrétegű, lapos szalag, erősített karikákkal,
nagy ellenállású polieszter (PES)

CE



EN 1492-1

L m	H mm	WLL ton	Ft		
2	180	6	22.850	1	081590020
3	180	6	33.800	1	081590030
4	180	6	43.500	1	081590040
5	180	6	52.400	1	081590050
6	180	6	61.350	1	081590060
8	180	6	79.950	1	081590080
10	180	6	98.800	1	081590100

Robur

8160

8 t kék emelőheveder
kétrétegű, lapos szalag, erősített karikákkal,
nagy ellenállású polieszter (PES)

CE



EN 1492-1

L m	H mm	WLL ton	Ft		
3	240	8	46.550	1	081600030
4	240	8	59.300	1	081600040
5	240	8	70.450	1	081600050
6	240	8	83.600	1	081600060
8	240	8	107.300	1	081600080
10	240	8	133.600	1	081600100

8161

Emelőheveder, narancs színű,
10t kétrétegű lapos heveder,
20t négyrétegű lapos heveder,
erősített hurkok

CE

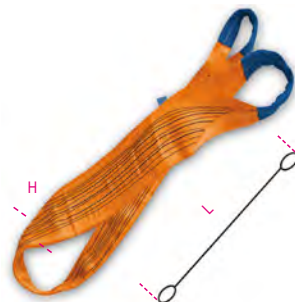

EN 1492-1

L m	H mm	WLL ton	Ft		
3	300	10	63.950	1	081610030
4	300	10	94.100	1	081610040
5	300	10	113.000	1	081610050
6	300	10	131.600	1	081610060
8	300	10	173.700	1	081610080
10	300	10	211.700	1	081610100
12	300	10	254.300	1	081610120
3	300	20	209.300	1	081612030
4	300	20	262.800	1	081612040
5	300	20	316.600	1	081612050
6	300	20	370.000	1	081612060
8	300	20	476.900	1	081612080
10	300	20	583.000	1	081612100
12	300	20	692.300	1	081612120

8170

1 t emelőheveder
végtelenített heveder, lila,
nagy ellenállású polieszter (PES)

CE

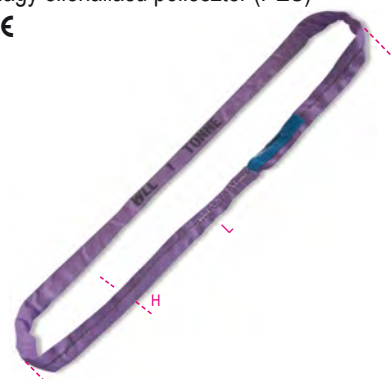

EN 1492-2

L m	WLL ton	H mm	Ft		
0,5	1	45	2.410	1	081700010
1	1	45	3.140	1	081700020
1,5	1	45	4.410	1	081700030
2	1	45	5.790	1	081700040
2,5	1	45	7.130	1	081700050
3	1	45	8.380	1	081700060
4	1	45	11.150	1	081700080
5	1	45	13.750	1	081700100

8173

2 t emelőheveder
végtelenített heveder, zöld,
nagy ellenállású polieszter (PES)

CE

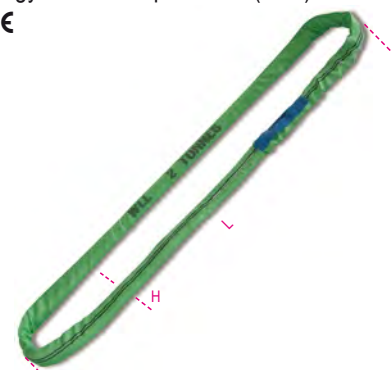

EN 1492-2

L m	H mm	WLL ton	Ft		
0,5	50	2	3.140	1	081730010
1	50	2	4.820	1	081730020
1,5	50	2	7.000	1	081730030
2	50	2	9.190	1	081730040
2,5	50	2	11.350	1	081730050
3	50	2	13.350	1	081730060
4	50	2	18.000	1	081730080
5	50	2	22.450	1	081730100
6	50	2	26.900	1	081730120
8	50	2	35.200	1	081730160

Robur

Robur

Robur

8176

3 t emelőheveder
végtelenített heveder, sárga,
nagy ellenállású polieszter (PES)

CE



EN 1492-2

L m	H mm	WLL ton	Ft		
0,5	60	3	3.480	1	081760010
1	60	3	6.320	1	081760020
1,5	60	3	9.190	1	081760030
2	60	3	11.750	1	081760040
2,5	60	3	14.750	1	081760050
3	60	3	17.800	1	081760060
4	60	3	23.700	1	081760080
5	60	3	29.550	1	081760100
6	60	3	35.600	1	081760120
8	60	3	46.950	1	081760160

8177

4 t emelőheveder
végtelenített heveder, szürke,
nagy ellenállású polieszter (PES)

CE



EN 1492-2

L m	H mm	WLL ton	Ft		
0,5	65	4	6.960	1	081770010
1	65	4	7.490	1	081770020
1,5	65	4	11.150	1	081770030
2	65	4	14.550	1	081770040
2,5	65	4	18.200	1	081770050
3	65	4	21.850	1	081770060
4	65	4	28.550	1	081770080
5	65	4	35.600	1	081770100
6	65	4	42.500	1	081770120
8	65	4	56.900	1	081770160

8178

5 t emelőheveder
végtelenített heveder, piros,
nagy ellenállású polieszter (PES)

CE

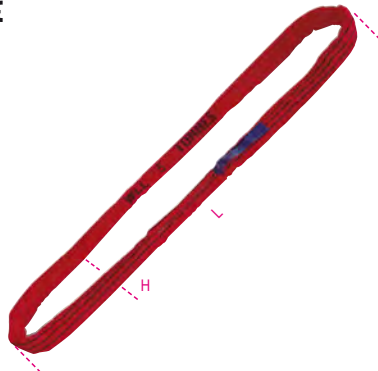

EN 1492-2

L m	H mm	WLL ton	Ft		
0,5	70	5	9.310	1	081780010
1	70	5	10.950	1	081780020
1,5	70	5	13.750	1	081780030
2	70	5	18.200	1	081780040
2,5	70	5	22.250	1	081780050
3	70	5	26.500	1	081780060
4	70	5	35.200	1	081780080
5	70	5	44.100	1	081780100
6	70	5	52.650	1	081780120
8	70	5	70.450	1	081780160

8179M

6 t emelőheveder
végtelenített heveder, barna
nagy ellenállású polieszter (PES)

CE



EN 1492-2

L m	H mm	WLL ton	Ft		
1	80	6	11.750	1	081790020
1,5	80	6	17.200	1	081790030
2	80	6	22.450	1	081790040
2,5	80	6	27.950	1	081790050
3	80	6	32.600	1	081790060
4	80	6	43.700	1	081790080
5	80	6	54.850	1	081790100
6	80	6	64.950	1	081790120
8	80	6	86.650	1	081790160

8179B

8 t emelőheveder végtelenített szalag, kék
nagy szakítószilárdságú polieszter szövet
(PES)

CE

EN 1492-2

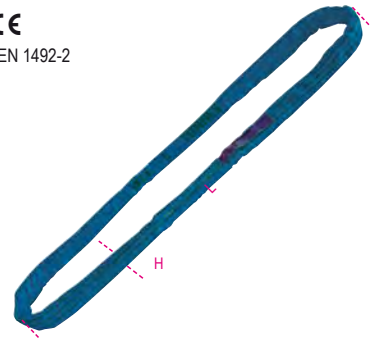

L m	H mm	WLL ton	Ft		
1	85	8	14.950	1	081790220
1,5	85	8	22.450	1	081790230
2	85	8	30.150	1	081790240
2,5	85	8	37.250	1	081790250
3	85	8	43.100	1	081790260
4	85	8	57.500	1	081790280
5	85	8	73.900	1	081790300
6	85	8	86.450	1	081790320
8	85	8	115.000	1	081790360



Robur

Robur

8179A

10t+50t emelőheveder végtelenített szalag, narancs nagy szakítószilárdságú poliészter szövet (PES)

CE
EN 1492-2



L m	H mm	WLL ton	Ft		
1	95	10	22.450	1	081790502
1,5	95	10	30.950	1	081790503
2	95	10	43.900	1	081790504
2,5	95	10	51.200	1	081790505
3	95	10	67.600	1	081790506
4	95	10	88.250	1	081790508
5	95	10	98.800	1	081790510
6	95	10	130.800	1	081790512
8	95	10	160.300	1	081790516
10	95	10	219.800	1	081790520
12	95	10	234.000	1	081790524
2	100	12	75.300	1	081791204
2,5	100	12	89.050	1	081791205
3	100	12	102.800	1	081791206
3,5	100	12	115.800	1	081791207
4	100	12	130.000	1	081791208
4,5	100	12	131.600	1	081791209
5	100	12	157.100	1	081791210
5,5	100	12	170.900	1	081791211
6	100	12	184.200	1	081791212
6,5	100	12	198.400	1	081791213
7	100	12	212.100	1	081791214
7,5	100	12	225.500	1	081791215
8	100	12	238.900	1	081791216
8,5	100	12	253.000	1	081791217
9	100	12	266.800	1	081791218
9,5	100	12	280.200	1	081791219
10	100	12	293.500	1	081791220
2	110	15	93.300	1	081791504
2,5	110	15	109.300	1	081791505
3	110	15	124.300	1	081791506
3,5	110	15	140.900	1	081791507
4	110	15	156.300	1	081791508
4,5	110	15	171.700	1	081791509
5	110	15	187.000	1	081791510
5,5	110	15	203.600	1	081791511
6	110	15	218.600	1	081791512
6,5	110	15	234.800	1	081791513
7	110	15	250.200	1	081791514
7,5	110	15	265.600	1	081791515
8	110	15	281.800	1	081791516
8,5	110	15	297.600	1	081791517
9	110	15	313.000	1	081791518
9,5	110	15	332.800	1	081791519
10	110	15	344.100	1	081791520
2	130	20	109.700	1	081792004
2,5	130	20	128.700	1	081792005
3	130	20	147.800	1	081792006
3,5	130	20	166.400	1	081792007
4	130	20	186.200	1	081792008
4,5	130	20	204.900	1	081792009
5	130	20	223.900	1	081792010
5,5	130	20	243.300	1	081792011
6	130	20	262.300	1	081792012
6,5	130	20	281.000	1	081792013
7	130	20	299.600	1	081792014
7,5	130	20	319.000	1	081792015
8	130	20	338.100	1	081792016
8,5	130	20	357.500	1	081792017
9	130	20	376.500	1	081792018
9,5	130	20	395.500	1	081792019
10	130	20	414.600	1	081792020

2	135	25	121.500	1	081792504
2,5	135	25	145.300	1	081792505
3	135	25	169.200	1	081792506
3,5	135	25	192.300	1	081792507
4	135	25	217.000	1	081792508
4,5	135	25	240.500	1	081792509
5	135	25	264.400	1	081792510
5,5	135	25	288.300	1	081792511
6	135	25	312.100	1	081792512
6,5	135	25	336.400	1	081792513
7	135	25	360.300	1	081792514
7,5	135	25	383.400	1	081792515
8	135	25	407.700	1	081792516
8,5	135	25	431.600	1	081792517
9	135	25	455.500	1	081792518
9,5	135	25	479.400	1	081792519
10	135	25	502.000	1	081792520

2	160	30	142.500	1	081793004
2,5	160	30	171.700	1	081793005
3	160	30	200.800	1	081793006
3,5	160	30	230.000	1	081793007
4	160	30	259.100	1	081793008
4,5	160	30	288.300	1	081793009
5	160	30	317.000	1	081793010
5,5	160	30	346.200	1	081793011
6	160	30	375.300	1	081793012
6,5	160	30	404.500	1	081793013
7	160	30	432.800	1	081793014
7,5	160	30	462.300	1	081793015
8	160	30	491.900	1	081793016
8,5	160	30	520.200	1	081793017
9	160	30	548.600	1	081793018
9,5	160	30	578.900	1	081793019
10	160	30	607.300	1	081793020

2	165	40	198.400	1	081794004
2,5	165	40	221.500	1	081794005
3	165	40	257.500	1	081794006
3,5	165	40	293.900	1	081794007
4	165	40	330.400	1	081794008
4,5	165	40	366.400	1	081794009
5	165	40	403.200	1	081794010
5,5	165	40	439.700	1	081794011
6	165	40	475.700	1	081794012
6,5	165	40	512.100	1	081794013
7	165	40	548.600	1	081794014
7,5	165	40	585.000	1	081794015
8	165	40	619.400	1	081794016
8,5	165	40	659.900	1	081794017
9	165	40	694.300	1	081794018
9,5	165	40	730.800	1	081794019
10	165	40	765.200	1	081794020

3	180	50	298.400	1	081795006
3,5	180	50	340.900	1	081795007
4	180	50	382.600	1	081795008
4,5	180	50	423.500	1	081795009
5	180	50	464.800	1	081795010
5,5	180	50	506.100	1	081795011
6	180	50	548.600	1	081795012
6,5	180	50	591.100	1	081795013
7	180	50	629.600	1	081795014
7,5	180	50	672.100	1	081795015
8	180	50	712.600	1	081795016
8,5	180	50	753.000	1	081795017
9	180	50	793.500	1	081795018
9,5	180	50	838.100	1	081795019
10	180	50	876.500	1	081795020

8166

Dörzsölésgátló burkolat hevederekhez, nagy szakítószilárdságú poliészter (PES) Elastomer alsó réteggel



H mm	a mm	L m	Ft		
70	45	3	9.680	1	081660073
80	52	3	11.350	1	081660083
110	70	3	13.750	1	081660103
155	100	3	28.950	1	081660153
170	110	3	31.800	1	081660170
235	150	4	86.850	1	081660235

H mm			
70	8150	8170-8173	081660073
80	8153	8176	081660083
110	8153-8156	8177-8178	081660103
155	8157	8178-8179A 8179B-8179M	081660153
170	8158	-	081660170
235	8159	-	081660235

8090F

összekötő emelő tag, poliészter hevederekhez, nagyszilárdságú ötvöztött acél

CE

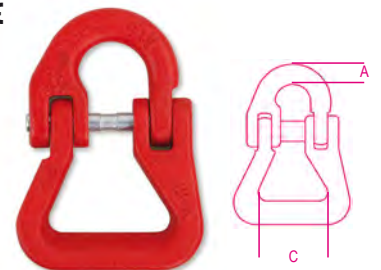

EN 1677-1

MŰSZAKI ADATOK

- Min. biztonsági együttható: 4
- Hőkezelés: díjazás ellenében
- Gyártási száma
- LABORELEMZÉSEK
- Kémiai elemzés, metallográfiai elemzés*
- Terhelhetőségi teszt (WLL x 2,5)
- Szakítópróba
- Fáradáspróba (min. 20.000 ciklus)
- RENDELKEZÉSRE ÁLLÓ TANÚSÍTVÁNYOK
- Termékleírás
- Vizsgálati jelentés 2.2 UNI EN10204
- Ellenőrzési tanúsítvány 3.1 UNI EN10204
- CE-Megfelelőségi nyilatkozat

WLL kg	Ø mm	A mm	C mm	Ft		
2000	7-8	10,5	40	11.750	1	080900220
3150	10	12	50	14.950	1	080900232
5300	13	17	60	22.650	1	080900253
8000	16	21	75	35.000	1	080900280

RÖGZÍTŐ HEVEDER

2:1

UNI EN 12195 szabvány szerint

MŰSZAKI ADATOK

• Min. biztonsági együttható: 2

• Azonosító kód

LABORELEMZÉSEK

• Racsni terhelési teszt

• Fémrészek deformálódási teszt

• Komplettermékre szakítópróba

RENDELKEZÉSRE ÁLLÓ TANUSÍTVÁNYOK

• Termékleírás

• Vizsgálati jelentés 2.2 UNI EN10204

8180

Racsni rögzítő heveder, egyhorgos

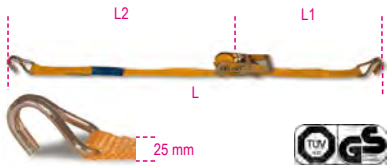

EN 12195-2

L m	L2 mm	L1 mm	STF daN	Ft		
4	3750	250	200	5.670	1	081800004
6	5750	250	200	6.560	1	081800006
8	7750	250	200	7.330	1	081800008

LC = 750 kg

8181

Racsni rögzítő heveder, egyhorgos

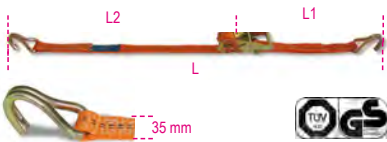

EN 12195-2

L m	L2 mm	L1 mm	STF daN	Ft		
4	3600	400	180	6.960	1	081810004
6	5600	400	180	7.940	1	081810006
8	7600	400	180	8.660	1	081810008

LC = 1000 kg

8181 6/B4

4 darab 8181 racsni rögzítőheveder táskában, 6 m nagy szakítószilárdságú poliészter szalag (PES) egyhorgos



EN12195-2

L2 mm	L1 mm	L m	STF daN	Ft		
5600	400	6	180	33.300	3	081810916

8182T

racsni rögzítő rendszer, LC 1500kg nagy szakítószilárdságú poliészter szalag (PES)

OLDALFAL rögzítő horgok

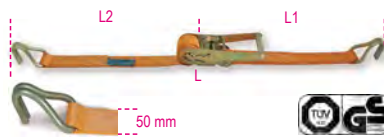

EN 12195-2

L m	L2 mm	L1 mm	STF daN	Ft		
8,5	8100	400	300	12.350	1	081821085
10,5	10100	400	300	13.350	1	081821105

LC = 1500 kg

8182

Racsni rögzítő heveder, egyhorgos

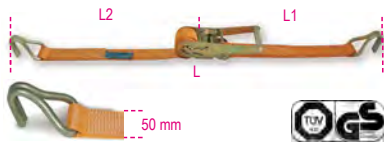

EN 12195-2

L m	L2 mm	L1 mm	STF daN	Ft		
4,5	4100	400	300	10.950	1	081820045
6,5	6100	400	300	12.950	1	081820065
8,5	8100	400	300	13.950	1	081820085
10,5	10100	400	300	16.000	1	081820105
14,5	14100	400	300	18.000	1	081820145
16,5	16100	400	300	20.650	1	081820165

LC = 2000 kg

> 8182LP 8100



L2 mm	Ft		
8100	7.690	1	081820902

hosszú rész

> 8182SP 400



L1 mm	Ft		
400	7.940	1	081820905

rövid rész

> 8182SP/BHN



L1 mm	Ft		
400	2.890	1	081820906

Rövid heveder szimpla horgokkal és anyával

8182 8,5/B2

2 darab 8182 racsni rögzítőheveder táskában, 8,5 m nagy szakítószilárdságú poliészter szalag (PES) egyhorgos



EN 12195-2

L2 mm	L1 mm	L m	STF daN	Ft		
8100	400	8,5	300	29.350	4	081821885

8182H

racsni rögzítő rendszer, LC 2500kg nagy szakítószilárdságú poliészter szalag (PES) horgos rögzítés

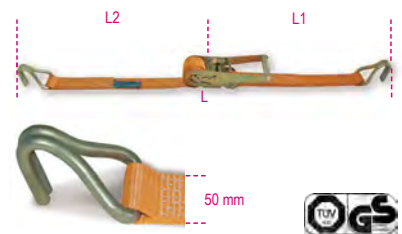

EN 12195-2

L m	L2 mm	L1 mm	STF daN	Ft		
6,5	6100	400	300	14.150	1	081820406
8,5	8100	400	300	15.400	1	081820408
10,5	10100	400	300	17.000	1	081820410
14,5	14100	400	300	21.450	1	081820414

LC = 2500 kg

8184

irányváltós racsni rögzítőheveder, hosszú karos, egyhorgos, LC 2500 kg, nagy szakítószilárdságú poliészter heveder (PES)



EN12195-2

L m	L2 mm	L1 mm	STF daN	Ft		
6,5	6100	400	500	15.800	1	081840065
8,5	8100	400	500	16.400	1	081840085
10,5	10100	400	500	17.800	1	081840105

LC = 2500 kg



8183

racsnis rögzítőheveder, egyhorgos, LC 5000 kg, nagy szakítószilárdságú poliészter heveder (PES)



EN 12195-2

L	L2	L1	STF	Ft		
m	mm	mm	daN			
8,5	8000	500	500	44.750	1	081830085
12,5	12000	500	500	53.250	1	081830125

LC = 5000 kg

8181S

racsnis rögzítő rendszer, LC 1000 kg nagy szakítószilárdságú poliészter szalag (PES) platórögzítő horgok

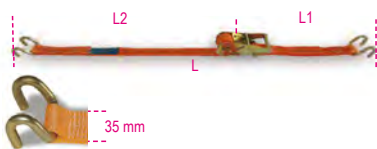

EN 12195-2

L	L2	L1	STF	Ft		
m	mm	mm	daN			
6	5600	400	180	7.690	1	081810206

LC = 1000 kg

8182TS

racsnis rögzítő rendszer, LC 1500kg nagy szakítószilárdságú poliészter szalag (PES) horgos rögzítés

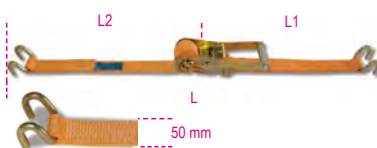

EN 12195-2

L	L2	L1	STF	Ft		
m	mm	mm	daN			
8,5	8100	400	300	12.750	1	081821285
10,5	10100	400	300	14.150	1	081821305

LC = 1500 kg

8182S

Racsnis rögzítő heveder, kéthorgos

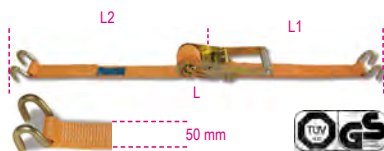

EN 12195-2

L	L1	L2	STF	Ft		
m	mm	mm	daN			
6,5	400	6100	300	12.750	1	081820265
8,5	400	8100	300	14.550	1	081820285
10,5	400	10100	300	16.000	1	081820305

LC = 2000 kg

8182SLP 8100



L2	L1	Ft		
mm	mm			
8100	-	7.530	1	081820912

hosszú rész

8182SSP 400



L1	Ft		
mm			
400	7.690	1	081820915

rövid rész

8182SSP/BHN



L1	Ft		
mm			
400	2.750	1	081820916

Rövid heveder dupla horgokkal és anyával

8182H/2

racsnis rögzítőheveder, kéthorgos, LC 2500 kg, nagy szakítószilárdságú poliészter heveder (PES)

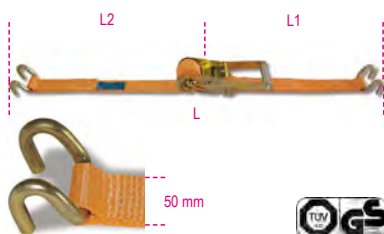

EN 12195-2

L	L1	L2	STF	Ft		
m	mm	mm	daN			
8,5	8100	400	300	16.200	1	081820385

LC = 2500 kg

8182E

racsnis rögzítő rendszer furgonokba és teherautókba, terheléshatár 1.000 kg nagy szakítószilárdságú poliészter heveder (PES)



EN 12195-2

L	L2	L1	STF	Ft		
m	mm	mm	daN			
4	3500	500	220	7.940	1	081820440

LC = 1000 kg

	L2	L1	Ft		
	mm	mm			
8182EL 2500	2500		2.450	1	081820942
8182EC 1500	1500		5.260	1	081820945

8182GD

racsnis rögzítőheveder delta karabinerrel, LC 2000 kg, nagy szakítószilárdságú poliészter heveder (PES)



EN 12195-2

L	L2	L1	STF	Ft		
m	mm	mm	daN			
8,5	8100	400	300	16.800	1	081820485

LC = 2000 kg

Robur

Robur

8182A

racsnis rögzítő rendszer 2 tartógyűrűvel nagy szakítószilárdságú poliészter heveder (PES) terheléshatár 2.000 kg



EN 12195-2

L	L2	L1	STF	Ft		
m	mm	mm	daN			
8,5	8100	400	300	14.550	1	081820585

LC = 2000 kg

8190

kéthorgos racsnis teherkötöző 8. biztonsági fokozatú



EN12195/3

MŰSZAKI ADATOK

- Min. biztonsági koefficiens: 2
 - Hőkezelés: díjazás ellenében
 - Termék-specifikáció
- RENDELKEZÉSRE ÁLLÓ TANÚSÍTVÁNYOK**
- Termékleírás
 - Vizsgálati jelentés 2.2 UNI EN10204
 - Ellenőrzési tanúsítvány 3.1 UNI EN10204

Ø mm	LC daN	Ø mm	LC daN	Ft		
10	6300	8	4000	37.050	1	081900010
13	10000	-	-	57.900	1	081900013

* FIGYELEM: A termék használható 8mm-es láncsal, de figyelembe kell venni a terhelhetőség (WLL) csökkenését (LC 400daN)

8190B

horgos teherkötöző rögzítőlánc



EN12195/3

MŰSZAKI ADATOK

- Min. biztonsági koefficiens: 2
 - Hőkezelés: díjazás ellenében
 - Emelőlánc azonosító
- MELLÉKELT TANÚSÍTVÁNYOK**
- Gyártói tanúsítvány
- RENDELKEZÉSRE ÁLLÓ TANÚSÍTVÁNYOK**
- Vizsgálati jelentés 2.2 UNI EN10204
 - Termékleírás

Ø mm	LC daN	L m	L1 m	Ft		
8	4000	3,5	3,30	80.700	1	081901308
10	6300	3,5	3,28	123.100	1	081901310
13	10000	3,5	3,23	180.200	1	081901313

8185

Racsnis rögzítő heveder



EN 12195-2

L	STF	Ft		
m	daN			
5	200	4.700	1	081850005
8	200	5.670	1	081850008

8186

Racsnis rögzítő heveder



EN 12195-2

L	STF	Ft		
m	daN			
5	180	5.670	1	081860005
8	180	7.210	1	081860008

8187

Racsnis rögzítő heveder



EN 12195-2

L	STF	Ft		
m	daN			
5	350	10.300	1	081870005
8	350	12.350	1	081870008

8188C

Racsnis rögzítő heveder, LC 750 kg, nagy szakítószilárdságú poliészter szalag (PP)



EN 12195-2

L	STF	Ft		
m	daN			
1,5	72	1.860	3	081880315
2,5	72	2.230	3	081880325
5	72	2.750	3	081880350

8188CG/25

Racsnis 2 horgos rögzítő heveder,
LC 400 kg
nagy szakítószilárdságú polieszter szalag
(PES)



EN 12195-2

L	L1	L2	STF	Ft		
m	mm	mm	daN			
3	480	170	120	4.170	1	081880430
5	480	170	120	4.490	1	081880450

8188CU/25

racsnis rögzítőheveder, egyhorgos,
LC 400 kg,
nagy szakítószilárdságú poliészter szalag
(PES)



EN 12195-2

L	L1	L2	Ft		
m	mm	mm			
5	300	4700	4.290	1	081880750



8188F

Rögzítő heveder LC 200 kg,
nagy szakítószilárdságú polieszter szalag (PP)

- 1,5 m
- 2,0 m
- 2,5 m
- 3,0 m
- 5,0 m

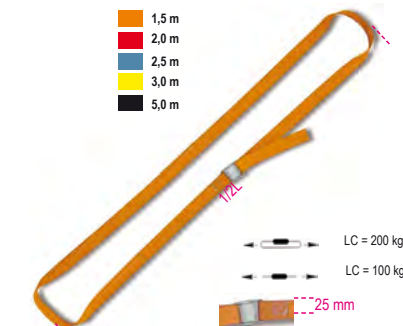

EN 12195-2

L	Ft		
m			
1,5	1.070	10	081880215
2,0	1.150	10	081880220
2,5	1.280	10	081880225
3,0	1.360	10	081880230
5,0	1.740	6	081880250

8188F35

rögzítő heveder, LC 500 kg,
nagy szakítószilárdságú polipropilén szalag
(PP)



EN 12195-2

L	Ft		
m			
5	3.870	1	081880295

8188FG2

2 horgos rögzítő heveder
LC 250 kg
nagy szakítószilárdságú polypropilén szalag
(PP)



EN 12195-2

L	L1	L2	Ft		
m	mm	mm			
3	450	110	5.510	1	081881530

8188/K8

rögzítőheveder készlet
8 tartozékkal



8188/K8	Ft		
	16.200	1	081880801

8488K	0,65m - 7kg
8488K	0,80m - 7kg
8188CL	4m - 500kg
8188FP	2,5m - 250kg

8189

Poliészterszalag (PES)
racsnis hevederhez



H	L	LC	Ft		
mm	m	kg			
25	100	750	37.650	1	081890902
35	100	1000	47.550	1	081890903
50	100	2000	76.300	1	081890905

8189A

csúszásmentes szőnyeg
teherrögzítéshez



L	H	S	μ	Ft		
m	mm	mm				
5	250	8	0,6	29.750	1	081890525

8189PA

2 sarokvédő
polieszter rögzítő hevederekhez

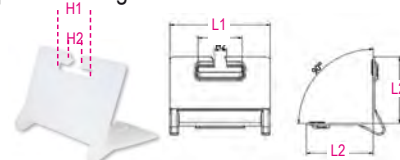

L1xL2	H1	H2	Ft		
mm	mm	mm			
135x90	60	18	1.860	1	081890090

Termék	Vizsgálati jelentés 2.2 (UNI EN 10204)	Teszt tanúsítvány 3.1(UNI EN 10204)	Gyártói tanúsítvány	CE-Megfelelőségi nyilatkozat
8001Z	✓	✓		✓
8001TZ	✓	✓		✓
8002ZD	✓			
8003ZD	✓			
8004ND	✓			
8005Z	✓			✓
8005TZ	✓			✓
8006Z	✓			✓
8007Z	✓			✓
8008N	✓			✓
8008TZN	✓			✓
8009FD	✓			
8009Z	✓			✓
8009TZ	✓			✓
8010Z	✓			✓
8010TZ	✓			✓
8011Z	✓			✓
8011TZ	✓			✓
8015	✓		✓	✓
8016	✓			✓
8016DA	✓			✓
8016FR	✓			
8016U2	✓		✓	✓
8016UGK	✓		✓	✓
8018E	✓			
8018T	✓			
8020A	✓			
8021A	✓			
8025	✓	✓		✓
8026A	✓	✓		✓
8026R	✓	✓		✓
8028	✓	✓		✓
8029R	✓	✓		✓
8031R	✓	✓		✓
8032	✓	✓		✓
8040EN	✓	✓		✓
8040EZ	✓	✓		✓
8042EN	✓	✓		✓
8042EZ	✓	✓		✓
8041	✓	✓		✓
8043	✓	✓		✓
8044	✓	✓		✓
8048	✓			
8049	✓	✓		✓
8049A	✓	✓		✓
8049V	✓	✓		✓
8051S	✓	✓		✓
8052	✓	✓		✓
8057R	✓	✓		✓
8058R	✓	✓		✓
8060R	✓	✓		✓
8061R	✓	✓		✓
8062	✓	✓		✓
8063	✓	✓		✓
8063SL	✓	✓		✓
8064S	✓	✓		✓
8065SC	✓	✓		✓
8068S	✓	✓		✓
8074	✓			
8074A	✓			
8074G	✓			
8080	✓			
8080FM	✓			
8085R	✓	✓		✓
8086	✓	✓		✓
8090	✓	✓		✓

Termék	Vizsgálati jelentés 2.2 (UNI EN 10204)	Teszt tanúsítvány 3.1(UNI EN 10204)	Gyártói tanúsítvány	CE-Megfelelőségi nyilatkozat
8090F	✓	✓		✓
8090R	✓	✓		✓
8091			✓	✓
8091SL			✓	✓
8092			✓	✓
8092SL			✓	✓
8094			✓	✓
8094SL			✓	✓
8096			✓	✓
8096SL			✓	✓
8097			✓	✓
8097SL			✓	✓
8098			✓	✓
8098SL			✓	✓
8100	✓	✓		✓
8105	✓	✓		✓
8109	✓	✓		✓
8110	✓			
8114	✓			
8116	✓			
8120 - 8120D	✓			
8120B	✓			
8121MZC	✓			
8134	✓		✓	✓
8135-H	✓		✓	✓
8143-SL	✓		✓	✓
8146-SL	✓		✓	✓
8146C	✓		✓	✓
8147C-S-P	✓		✓	✓
8148	✓		✓	✓
8149	✓		✓	✓
8150	✓		✓	✓
8153	✓		✓	✓
8156	✓		✓	✓
8157	✓		✓	✓
8158	✓		✓	✓
8159	✓		✓	✓
8160	✓		✓	✓
8161	✓		✓	✓
8166	✓			
8170	✓		✓	✓
8173	✓		✓	✓
8176	✓		✓	✓
8177	✓		✓	✓
8178	✓		✓	✓
8179M-B-A	✓		✓	✓
8180	✓			
8181	✓			
8181S	✓			
8182	✓			
8182A-GD	✓			
8182E	✓			
8182H-H2	✓			
8182M	✓			
8182S	✓			
8182T	✓			
8182T-TS	✓			
8182TS	✓			
8185	✓			
8186	✓			
8187	✓			
8188C	✓			
8188CG/25	✓			
8188CU	✓			
8188F	✓			
8188VF/35	✓			

Termék	Vizsgálati jelentés 2.2 (UNI EN 10204)	Teszt tanúsítvány 3.1(UNI EN 10204)	Gyártói tanúsítvány	CE-Megfelelőségi nyilatkozat
8188FG2	✓			
8190	✓	✓		
8190B	✓		✓	
8302Z	✓			
8303Z	✓			
8317DZ	✓			
8317SZ	✓			
8381SL	✓			
8381SP	✓			
8383C	✓			
8383P	✓			
8515V	✓			
8515Z	✓			
8531	✓			
8532	✓			
8535	✓			
8201T	✓			
8205	✓			
8206	✓			
8207	✓			
8209	✓			
8210	✓			
8210F	✓			
8210FTP	✓			
8216	✓			✓
8220	✓			
8225	✓			
8227	✓			
8228	✓			
8240	✓			
8240F	✓	✓		✓
8242	✓			
8242F	✓	✓		✓
8248	✓			
8249	✓			
8249G	✓			
8250	✓			
8264	✓			
8267	✓			
8272	✓			
8273	✓			
8274	✓			
8274A	✓			
8274G	✓			
8276	✓			
8276G	✓			
8278	✓			
8280	✓			
8282	✓			
8282S	✓			
8284	✓			
8285	✓			
8286	✓			
8287	✓			
8290	✓			
8293	✓			
8297C	✓			
8297F	✓			
8381SX	✓			
8702...	✓	✓		
8709...	✓	✓		



BETA COLLECTION



Beta Collection

Exkluzív termékek, amelyek által a Beta karaktere jut kifejezésre, több mint 200 kiváló minőségű, eredeti termék: sportruházat, technikai ruházat és számos személyes ajándék.

Ideális reklámkampanyóhoz, elengedhetetlen a kikapcsolódáshoz.



9501TLD

CVC női felső, 80% pamut, 20% poliészter, 320 g/m²



	Ft		
S	41.900	1	095010061
M	41.900	1	095010062
L	41.900	1	095010063
XL	41.900	1	095010064

9503TL

póló, 100% jersey pamut, 160 g



	Ft		
S	19.000	1	095030051
M	19.000	1	095030052
L	19.000	1	095030053
XL	19.000	1	095030054
XXL	19.000	1	095030055

9504TL

dzseki, kívül 100% poliészter, vízhatlanított

A KÉSZLET EREJÉIG!



	Ft		
S	58.100	1	095040051
M	58.100	1	095040052
L	58.100	1	095040053
XL	58.100	1	095040054
XXL	58.100	1	095040055

9510W

elasztikus hosszú ujjú férfi ing, 120 g/m², 97% pamut, 3% elasztán. Fehér, fekete logóval. Hátsó vállrésznél két oldalt szűkítővarrás, félcápa gallér. Fehér gombok, két mandzsettagomb. Slim fit



	Ft		
XS	52.650	1	095100100
S	52.650	1	095100101
M	52.650	1	095100102
L	52.650	1	095100103
XL	52.650	1	095100104
XXL	52.650	1	095100105

953480

kétgombos pólóing, pamutdszörz, 200 g/m², kék, szürke betétekkel



	Ft		
S	29.750	1	095340071
M	29.750	1	095340072
L	29.750	1	095340073
XL	29.750	1	095340074
XXL	29.750	1	095340075

9534W0

kétgombos pólóing, pamutdszörz, 200 g/m², narancsszínű betétekkel



	Ft		
S	29.750	1	095340031
M	29.750	1	095340032
L	29.750	1	095340033
XL	29.750	1	095340034
XXL	29.750	1	095340035

9572LB

Beta-March póló, 100% pamut, 200 g/m² narancsszínű, fekete betétekkel



	Ft		
S	22.650	1	095720801
M	22.650	1	095720802
L	22.650	1	095720803
XL	22.650	1	095720804
XXL	22.650	1	095720805

9577R

munkaoverál, motorsport stílus, elasztikus szövet, 260 g/m², fekete-narancs, fehér és fényvisszaverő betétekkel

CE



		Ft		
S	48	67.600	1	095770151
M	50	67.600	1	095770152
L	52	67.600	1	095770153
XL	54	67.600	1	095770154
XXL	56	67.600	1	095770155
XXXL	58	67.600	1	095770156

9579C

Munkaköpeny, poliészter/pamut



	Ft		
M	29.750	1	095791002
L	29.750	1	095791003
XL	29.750	1	095791004

9525CM

Egyenes siltes terepszínű versenysapka, 100% poliészter, hátul lyukakkal, műanyag patenttal állítható



	Ft		
9525CM	11.150	1	095250098

9525TR

Sapka, 50% pamut, 50% poliészter, hátul hálós, műanyag patenttal állítható, fekete



	Ft		
9525TR	11.150	1	095250011

9525WB

Baseball sapka, 100% poliészter, felül lyukacsos, tépőzárral állítható méret, fehér



	Ft		
9525WB	7.890	1	095251032



9543C

csősál, 100% mikroszálás poliészter, varratmentes



	L cm	H cm	Ft		
9543C	25	50	4.010	1	095430100

9574B

munkakesztyű, elasztizált gumis csukló rész, erősített hüvelykujj és mutatóujj, érintőképernyős eszközök használatra alkalmas műbőrből
A KÉSZLET EREJÉIG!

CE



	TG.	Ft		
M	9	17.600	1	095740102
L	10	17.600	1	095740103
XL	11	17.600	1	095740104
XXL	12	17.600	1	095740105

95740

munkakesztyű, elasztizált gumis csukló rész, erősített hüvelykujj és mutatóujj, érintőképernyős eszközök használatra alkalmas műbőrből
A KÉSZLET EREJÉIG!

CE



	TG.	Ft		
M	9	17.600	1	095740202
L	10	17.600	1	095740203
XL	11	17.600	1	095740204
XXL	12	17.600	1	095740205

9580S

napszemüveg

CE



EN ISO 12312-1:2013+A1:2015
UV400
FILTER CAT. III

	Ft		
9580S	15.800	1	095800100

9593A

kronográf óra, acélházas, vízálló 5 ATM, szilikon szíj



	Ft		
9593A	131.600	1	095930050

9593M

automata óra, acélház, 5 ATM vízálló, acél szíjjal



	Ft		
9593M	165.600	1	095930120

9593W

analóg óra, soft touch műanyag ház acélgyűrűvel, vízálló 3 ATM, szilikon szíj



	Ft		
9593W	28.950	1	095930150

9593SB

multifunkciós okoskarkötő, érintőképernyő, fitneszmérő, pulzusmérő, lépésszámláló, alvásfigyelő, szilikon pánt, fekete

Kompatibilitás: IOS 8.2 vagy újabb / Android 4.4 vagy újabb
Bluetooth 4.2
IP67

CE

IP67



	Ft		
9593SB	50.200	1	095930205

9541BIKE

oxford poliészter hátizsák, méret 41x24x16 cm



	L cm	S cm	H cm	Ft		
9541BIKE	24	16	41	9.070	1	095410021

9541F

bevont szövet/poliészter hátizsák, oxford 600D, méret 50x33x16 cm



	L cm	S cm	H cm	Ft		
9541F	33	16	50	38.250	1	095410011



9541PC

sokzsebes munkahátizsák laptoptartó rekesssel,
100% poliészter

- 3 rekeszes hátizsák vízzáró cipzárral
- laptoptartó rekesz
- párnázott hordozó fül
- USB csatlakozó
- hálós palack-/esernyőtartó oldalzseb
- vállpánton szemüvegtartó zseb
- állítható mellheveder



	L	S	H	Ft		
	cm	cm	cm			
9541PC	34	18	52	33.200	1	095410041

9541S

Hátizsák vízálló bélésel, 210D vízálló poliészter, 33x45 cm



	L	H	Ft		
	cm	cm			
9541S	33	45	5.180	1	095410031

9544C

keményfalú gurulós bőrönd 4 dupla kerékkel,
TSA zár, USB csatlakozó + 3,5 mm jack



	L	S	H	Ft		
	cm	cm	cm			
9544C	40	20	55	68.400	1	095440101

9557J 2.0

bevont szövet/poliészter sporttáska, oxford
600d, méret 47x28x25 cm



	L	S	H	Ft		
	cm	cm	cm			
9557J 2.0	47	25	28	40.700	1	095570020

9539CB

kerékpáros bukósisak levehető állvédővel,
állítható méret



	Ft		
S-M	79.950	1	095390010
L-XL	79.950	1	095390011

9542AL

hosszú ujjú szélvédő, vízálló, légáteresztő
textilköpeny

A KÉSZLET EREJÉIG!



	Ft		
S	73.050	1	095420042
M	73.050	1	095420043
L	73.050	1	095420044
XL	73.050	1	095420045
XXL	73.050	1	095420046
XXXL	73.050	1	095420047



9542C

lycra kertész nadrág, szilikon gumi a lábnál,
antibakteriális légáteresztő ülőbetéttel

A KÉSZLET EREJÉIG!



	Ft		
S	54.250	1	095420061
M	54.250	1	095420062
L	54.250	1	095420063
XL	54.250	1	095420064
XXL	54.250	1	095420065
XXXL	54.250	1	095420066

9542G

Téli trikó, légáteresztő szövet bélésel, hosszú
cipzár, hátul három zseb, szilikon gumi a trikó
szélén

A KÉSZLET EREJÉIG!



	Ft		
S	56.900	1	095420012
M	56.900	1	095420013
L	56.900	1	095420014
XL	56.900	1	095420015
XXL	56.900	1	095420016

95426W

téli dzseki, szélálló és jó légáteresztő képességű szövetből és bolyhos szövetből; hosszú cipzár, szilikonmentes gumírozott sáv deréktájon; hozzásimuló Lycra csuklórész; hátsó fényvisszaverő betétek, 3 külső hátsó zseb, egyikük cipzáras

A KÉSZLET EREJÉIG!



Méret	Ft	☎	💻
S	98.600	1	095420101
M	98.600	1	095420102
L	98.600	1	095420103
XL	98.600	1	095420104
XXL	98.600	1	095420105
XXXL	98.600	1	095420106

9542M

légáteresztő mikroszálas rövidujjú trikó, fedett hosszú cipzár, három hátsó zseb, egyikük cipzárral, szilikon gumi a trikó szélén

A KÉSZLET EREJÉIG!



Méret	Ft	☎	💻
S	57.100	1	095420051
M	57.100	1	095420052
L	57.100	1	095420053
XL	57.100	1	095420054
XXL	57.100	1	095420055
XXXL	57.100	1	095420056



9542S

Téli sport nadrág, Lycra, antibakteriális légáteresztő ülőbetéttel

A KÉSZLET EREJÉIG!



Méret	Ft	☎	💻
S	76.300	1	095420022
M	76.300	1	095420023
L	76.300	1	095420024
XL	76.300	1	095420025
XXL	76.300	1	095420026
XXXL	76.300	1	095420027



9598W-N

Whistle® mountain bike, alumínium váz, Suntour XCT30 villa, 29" 100 mm, Shimano RD-TX500 hátsó váltó, 7 sebességes, hidraulikus Shimano BR-M200 tárcsafék és 29" alumínium kerék, fluoreszkáló narancsszín / matt antracitszürke



	Ft	☎	💻
9598W M-N	516.200	1	095980130
9598W L-N	516.200	1	095980132

9597TRIOWAY

TRIOWAY BY ATALA®

TRIOWAY by ATALA® kiegészítő elektromos hajtásrendszer, REHA COMFORT kerekesszékhez kapcsolható (tartozék), vázba épített lítium akkumulátor, irány- és sebességvezérlés a kormányban, beépített kerekesszék rögzítő rendszerrel

CE



KÉRÉSRE ELÉRHETŐ



VÁZ

- Gyors rögzítő/oldó rendszer karos hajtású kerekesszékhez
- Összecsukható kétpántos váz
- Függőlegesen állítható kormány
- Tárcsafék, 180 mm
- Elülső LED lámpa
- Elülső abroncsos gumikerék

TELJESÍTMÉNY

- Szabályozható sebesség, max. 15 km/óra
- Előre-hátra gomb
- Hatótávolság: 20 km
- Gázkar a kormányon

AKKUMULÁTOR

- 7Ah újratölthető lítium akkumulátor
- Vázba épített, cserélhető akkumulátor
- 230V 50Hz töltőkábel (tartozék)

TARTOZÉKOK

- Multifunkciós kijelző: maradék akkumulátorkapacitás, töltöttségi szint kijelző
- Csengő
- Irányjelzők
- Mobiltelefon tartó (tartozék)
- On/Off gomb
- Beépített GYORSRÖGZÍTŐ RENDSZER A KEREKESZÉK ALATTREHA

COMFORT KEREKESZÉK (tartozék)

- Összecsukható kétpántos váz
- 24" tömör PU gumikerékek
- Levehető kartámasz
- Állítható, levehető lábtámasz
- Nejlón ülés hátsó zsebbel

9597TRIOWAY

☎ 095970200

9598WHP-N

Whistle® mountain bike, alumínium váz, Suntour XCM PL villa, 29" 100 mm, kormányról vezérelhető lockout, Shimano XT RD-M8100 Shadow Plus hátsó váltó, 12 sebességes, hidraulikus Shimano BL-MT201/BR-MT200 tárcsafék és 29" alumínium kerék, fehér / matt vörös



9598WHP M-N	Ft	1	095980140
9598WHP L-N	971.700	1	095980142

9599CB-N2

Atala® city bike, Hi-Ten Tig TKK 700c váz, Shimano® Tourney RD-TZ50 6 sebességes hátsó váltó, V-Brakes® fék, 28" alumínium kerekek, csomagtartóval, kitámasztóval és csengővel, matt fekete



9599CB-N2	Ft	1	095990031
	302.800		

9599CB-WN

Atala® city bike, alumínium váz, 6 sebességes Shimano® váltó, V-Brake® fék, 28" alumínium kerekek, fehér

- Alumínium váz
- Hi-Ten Tig TKK 700c villa
- Shimano Tourney RD-TZ50 6 sebességes váltó
- Alumínium V-Brake fék
- 28" alumínium kerekek
- Szín: fehér



9599CB-WN	Ft	1	095990024
	302.800		

9597P

oszlopos pumpa nyomásmérővel

- Adapter az összes kerékpár szeletpúshoz (Schrader, Presta/Sclaverand, Regina)
- Maximum nyomás: 12 bar/ 180 psi



9597P	Ft	1	095970100
	29.350		

9548KB

futóbicikli, acél váz, 12" kerék belső gumival, 3 éves kortól ajánlott; legnagyobb teherbírás: 30 kg



9548KB	Ft	1	095480110
	75.900		

9548KB 20

Atala® 20" gyermek mountain bike, Hi-Ten Tig 20" acélváz, 30-mm teleszkópos villa, RD-TY21SS 6V hátsó váltó, alumínium V-fék és 36 lyukas alumínium kerék, fluoreszkáló sárga / matt kék



9548KB 20	Ft	1	095480120
	244.900		

9548KB 24

Atala® 24" gyermek mountain bike, Hi-Ten Tig 24" acélváz, teleszkópos villa, Shimano Tourney RD-TYZ50 6V hátsó váltó, alumínium V-fék és 36 lyukas alumínium kerék, matt fluoreszkáló narancsszín



9548KB 24	Ft	1	095480122
	260.700		



Beta



9547T

„Kinder trolley”, szerszámkoci szerszámokkal 3 év feletti gyermekek számára

CE



9547T Ft 30.950 1 095470100

9547WSK

„Kinder Work Station” munkapad szerszámokkal 3 éves kortól

CE



9547WSK H cm 74 Ft 56.900 1 095473801

9548G

„Kinder Garage” 6 szintes, autómosóval, lifttel és rámpákkal



9548 G H cm 69 Ft 30.950 1 095480100

9524SC

Miniatűr Beta műhely/garázs berendezés gyűjtők részére



A KÉSZLET EREJÉIG!

1:18 Ft 41.900 1 095240018

9526RMN

két csomag 55 lapos Modiano® francia kártya



9526RMN Ft 13.350 1 095260001

9528C

Futball labda, PU borítású, 5-ös méret

- kerület: 68-70 cm
- panelek száma: 12
- súly: 410-430 g
- ajánlott nyomás: 6-8 lbs/0,41-0,55 bar/6-8 psi



9528C Ft 13.150 1 095280100

9520P

Esernyőtartó, festett horganyzott fém, lézergravírozott logóval és cseppptálcával, fekete



9520P Ft 31.350 1 095200100

9521

automata fekete nejlón esernyő, T210 alumínium tokszár, 3 szelvény



9521 Ft 14.550 1 095210000

95210B

esernyő 210T nylon, 100 cm átmérő



95210B ø cm 100 Ft 16.000 1 095210021

9522A

ergonomikus sörnýtő



9522A Ft 8.020 1 095220010



9523A

alumínium palack, 500 ml



9523A	ml	Ft		
	500	5.510	1	095230005

9523T

rozsdamentes acél termosz, 500 ml, kétrétegű vákuumtechnológia, cseppegésmentes kupak, narancsszín

- a hideg italokat 24 órán át hidegen tartja
- a meleg italokat 12 órán át melegen tartja



EC1935/EC2023

9523T	ml	L mm	Ft	
	500	255	10.050	1 095230050

9528B

Műanyag palack, 500 ml



9528B	ml	Ft		
	500	3.160	1	095280005

9526F

Mini hűtő, F energiaosztály, 63 l űrtartalom, fekete

CE



9526F	L mm	S mm	H mm	Ft	
	474	450	640	245.300	1 095260005

9526MC

Kapszulás kávéfőző

CE



9526MC	L mm	S mm	H mm	Ft	
	358	128	255	106.900	1 095260020

9527 6T

6 darabos kávécsésze készlet



9527 6T	Ft		
	45.950	1	095270001

9527T

Fekete kerámia bögre lézergravírozott BETA logóval



9527T	Ft		
	8.910	1	095270030

9586K

többfunkciós acél zsebkés, 10 funkció



9586K	Ft		
	7.690	1	095860100



9549ABW

vezeték nélküli BT V5.0 fülhallgató beépített mikrofonnal, mágneses töltés, USB-C töltőállomás, fekete

CE



9549ABW	L mm	H mm	S mm	Ft	
	61	34,5	41	15.600	1 095490091

9549BP

hordozható akkumulátor 10000mAh



9549BP	Ft		
	10.700	1	095490052

9549BRW

vezeték nélküli töltő állomás, gyorsöltő funkcióval és töltöttségi szint kijelzéssel

- 1 m hosszú, adapterhez csatlakoztatható USB-USB C kábellel szállítva
- Minden vezeték nélküli töltést támogató eszközzel kompatibilis
- Bemenet: DC 5V/2A, 9V/2A, 12V/1.5A
- Kimenet: 5W/ 7.5W/ 10W/ 15W

CE



9549BRW	Ø mm	H mm	Ft	
	58	6	15.200	1 095490100

9549C

USB kulcs, 32 GB



9549C	Ft		
	9.800	1	095490062

9549CR

4 az 1-ben töltőkábel, fonott nejlon, gyorsöltés támogatás

- USB-A tápegység csatlakozó
- Lightning csatlakozó Apple termékekhez
- Micro USB töltőcsatlakozó
- USB-C töltőcsatlakozó
- USB-C töltő- és adatátviteli csatlakozó



9549CR	L mm 120	Ft 8.260	1	095490042
--------	----------------	-------------	---	-----------

9549MPC

multiport töltőállomás, 6 USB csatlakozó egyszerre több eszköz töltéséhez maximum 65W felvett teljesítményig

- 4 USB aljzat, 5V 2.4A
- 1 USB aljzat, Q.C 3.0
- 1 USB-C aljzat, 20W PD

önálló KI/BE kapcsolóval, Watt összteljesítményt, port számot és áramerősséget jelző LED



CE

9549MPC	L mm 110	S mm 72	H mm 35	Ft 25.300	1	095490082
---------	----------------	---------------	---------------	--------------	---	-----------

9549SBW

vezeték nélküli, hordozható BT hangszóró, 6 funkció

BT verzió: 5.0

FUNKCIÓK:

- BT lejátszás
- Lejátszás TF kártyáról
- Lejátszás USB-ről
- 3.5 mm jack aljzat
- FM rádió
- hívás funkció

CE



9549SBW	L mm 73	S mm 73	H mm 124	Ft 20.650	1	095490072
---------	---------------	---------------	----------------	--------------	---	-----------

9547

Asztali számológép

CE



9547	Ft 9.430	1	095470000
------	-------------	---	-----------

9592AC

Fekete alumínium toll érintőképernyőhöz való gumivéggel
Egyedi tokban



9592AC	Ft 1.780	1	095920010
--------	-------------	---	-----------

9592B/C50

50 darabos golyóstoll készlet



9592B/C50	Ft 22.850	1	095920050
-----------	--------------	---	-----------

9592B/P

feliratozott golyóstoll



9592B/P	Ft 685	500	095920051
---------	-----------	-----	-----------

9592MG/3

3 db grafitceruza tokban



9592MG/3	Ft 11.150	1	095920103
----------	--------------	---	-----------

9588M

puha hőformált tálcá 1 tollal és 2 notesszel



9588M	Ft 9.730	1	095880011
-------	-------------	---	-----------

9587 9x14

jegyzetfüzet, 9x14 cm



9587 9X14	L cm 9	H cm 14	Ft 6.230	5	095870009
-----------	--------------	---------------	-------------	---	-----------

9587 13x21

jegyzetfüzet, 13x21 cm



9587 13X21	L cm 13	H cm 21	Ft 7.980	5	095870013
------------	---------------	---------------	-------------	---	-----------

9588/10PI

Jegyzetkönyv + öntapadós lapok



9588S/10PI	Ft 12.550	1	095880055
------------	--------------	---	-----------

7,5x7,5 cm



9588S/10...

Jegyzetkönyv



	Ft	1	095881001
9588S/10A 21x29 cm	13.350	1	095881001
9588S/10B 15x21 cm	12.750	1	095881002
9588S/10C 10x15 cm	9.350	1	095881003
9588S/10D 7,5x10,5 cm	5.950	1	095880054

9589A/36

36 tekercs ragasztószalag Beta logoval, barna



	Ft	1	095890035
9589A/36	64.150	1	095890035

9589B/36

36 tekercs ragasztószalag Beta logoval, fehér



	Ft	1	095890036
9589B/36	68.200	1	095890036

9594

Falióra hő- és levegő páratartalommérővel, átmérő 26 cm



	Ft	1	095940051
9594 Ø cm 26	13.950	1	095940051

9595C

bőr kulcstartó



	Ft	1	095950011
9595C	4.170	1	095950011

9595T

krómozott fém kulcstartó, bársonyokban



	Ft	1	095950021
9595T	3.520	1	095950021

9596

Nyakra akasztható teleföntartó fém karabinerrel



	Ft	10	095961001
9596	2.310	10	095961001

9569MS

tartós polipropilén bevásárló szatyor, duplafüles



	L cm	H cm	Ft	5	095690052
9569MS	60	40	3.040	5	095690052

9569MS-2

tartós polipropilén bevásárló szatyor



	L cm	H cm	Ft	5	095690055
9569MS-2	45	40	3.040	5	095690055

9569P

Poliétilén bevásárló szatyor



	L cm	H cm	Ft	50	095691001
9569P	34	44	370	50	095691001

9569S

nemszövet harmonikás bevásárló szatyor, 38x42 cm



	L cm	H cm	Ft	50	095690051
9569S	38	42	1.150	50	095690051



9563G

irodai fotel, vendégeknek



9563G	Ft	1	095630050
	115.800		

9563U

ergonómikus irodai fotel



9563U	Ft	1	095630020
	240.500		

9565K

hordóasztal két széssel



9565K	Ft	1	095650500
	418.200		

9565S

lemezacél hordószék kivehető műbőrrel



9565S	H cm	ø cm	Ft	1	095650300
	60	38	97.550		

9565T

lemezacél hordóasztal lakkozott rétegelt nyírfa asztallappal

A függőleges beállításhoz dupla távtartó csövekkel (7 cm és 20 cm) szállítva.



9565T	H cm	ø cm	Ft	1	095650200
	95→108	70	223.100		

9566K

Bútor garnitúra, asztal és három 9566S/3 állítható magasságú bárshék



9566K	H mm	Ft	1	095660500
	920 ÷ 1120	173.300		

9566S/3

3 db állítható magasságú bárshék



9566S/3	H mm	Ft	1	095660300
	620 ÷ 840	124.700		

9562P2

multilogo szőnyeg, 200x80 cm

• különösen alkalmas a C55 műhelyberendezéshez vagy motorkerékpár alá



9562P2	L cm	H cm	Ft	1	095620400
	200	80	77.300		

9562P12

multilogo szőnyeg tekercs, 12 m x 80 cm

A szőnyeg tetszőleges méretűre vágható



9562P12	L m	H cm	Ft	1	095620425
	12	80	390.300		

9562TB

cipő szőnyeg, csúszásmentes, gumibevonátú alsórész



9562TB	L mm	H mm	Ft	1	095620500
	800	600	22.050		

9562T1

garázsszőnyeg, 100x80 cm

különösen alkalmas a BETA 3071 és 3071B motorkerékpár emelő alá

• könnyen tisztítható, csúszásmentes, gumibevonátú alsórész



9562T1	L cm	H cm	Ft	1	095620150
	100	80	40.500		

9562T2

munkapad alátétszőnyeg, 200x160 cm

- Védi a padlót az olaj- és benzincseppektől, környezetbarát
- Könnyen tisztítható, csúszásmentes, gumibevonotú alsórész



	L	H	Ft		
	cm	cm			
9562T2	200	160	110.100	1	095620200

9562T3

garázsoszlopgyűrű

Méret: 300x160 cm

- Különösen alkalmas motorkerékpár emelők alá



	L	H	Ft		
	cm	cm			
9562T3	300	160	160.300	1	095620300

9559

Egyoldalon nyomott reklámfelirat, 3x0,8 m



	L	H	Ft		
	m	m			
9559	3	0,8	13.350	1	095591001

9559/30MT

10 db nemszövet Beta logó tekercs



	Ft		
9559/30MT	125.900	1	095591031

9559/S

Kültéri molinó, 3x0,8 m

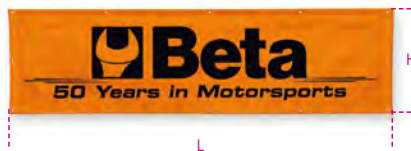

	L	H	Ft		
	m	m			
9559/S	3	0,8	46.750	1	095591011

9561V

vitrolazászló, 4x0,75 m

krómozott fém rúd

50 cm-es cementöntvény talp



	L	H	Ft		
	mt	mt			
9561V	0,75	4	287.900	1	095610001

9561VV

reklámszázló 3,50x0,75 m, zászlórúddal



	L	H	Ft		
	mt	mt			
9561VV 4,0	0,75	3,50	164.800	1	095610101

9561VV 2,5

reklámszázló 2x0,50 m, zászlórúddal



	L	H	Ft		
	mt	mt			
9561VV 2,5	0,50	2,5	100.000	1	095610201

9562

Oldalponyvával zárható pavilon, 3 m x 3 m



	L	H	S	Ft		
	cm	cm	cm			
9562	300	348	300	840.100	1	095620020





MEGSZÜNT TERMÉKEK – HELYETTESÍTŐ/AJÁNLOTT TERMÉKEK

	MEGSZÜNT TERMÉK
	HELYETTESÍTŐ TERMÉK
	JAVASOLT TERMÉK

42AS 1/4	000420106	42AS 1/4 NEW	000421106
42AS 9/32	000420107	42AS 9/32 NEW	000421107
42AS 5/16	000420108	42AS 5/16 NEW	000421108
42AS 3/8	000420110	42AS 3/8 NEW	000421110
42AS 7/16	000420111	42AS 7/16 NEW	000421111
42AS 1/2	000420113	42AS 1/2 NEW	000421113
42AS 9/16	000420114	42AS 9/16 NEW	000421114
42AS 19/32	000420115	42AS 19/32 NEW	000421115
42AS 5/8	000420116	42AS 5/8 NEW	000421116
42AS 11/16	000420117	42AS 11/16 NEW	000421117
42AS 3/4	000420119	42AS 3/4 NEW	000421119
42AS 13/16	000420121	42AS 13/16 NEW	000421121
42AS 7/8	000420122	42AS 7/8 NEW	000421122
42AS 15/16	000420124	42AS 15/16 NEW	000421124
42AS 1	000420125	42AS 1 NEW	000421125
42AS 1.1/16	000420127	42AS 1.1/16 NEW	000421127
42AS 1.1/8	000420129	42AS 1.1/8 NEW	000421129
42AS 1.1/4	000420132	42AS 1.1/4 NEW	000421132
42AS 1.5/16	000420133	42AS 1.5/16 NEW	000421133
42AS 1.3/8	000420135	42AS 1.3/8 NEW	000421135
42AS 1.7/16	000420136	42AS 1.7/16 NEW	000421136
42AS 1.1/2	000420138	42AS 1.1/2 NEW	000421138
42AS/B9N	000420159	42AS/B9N	000421159
42AS/13	000420163	42AS/13	000421163
42AS/16	000420166	42AS/16	000421166
42AS/17	000420168	42AS/17	000421168
42MP 6	000420606	42MP 6	000421606
42MP 7	000420607	42MP 7	000421607
42MP 8	000420608	42MP 8	000421608
42MP 9	000420609	42MP 9	000421609
42MP 10	000420610	42MP 10	000421610
42MP 11	000420611	42MP 11	000421611
42MP 12	000420612	42MP 12	000421612
42MP 13	000420613	42MP 13	000421613
42MP 14	000420614	42MP 14	000421614
42MP 15	000420615	42MP 15	000421615
42MP 16	000420616	42MP 16	000421616
42MP 17	000420617	42MP 17	000421617
42MP 18	000420618	42MP 18	000421618
42MP 19	000420619	42MP 19	000421619
42MP 20	000420620	42MP 20	000421620
42MP 21	000420621	42MP 21	000421621
42MP 22	000420622	42MP 22	000421622
42MP 24	000420624	42MP 24	000421624
42MP 27	000420627	42MP 27	000421627
42MP 30	000420630	42MP 30	000421630
42MP 32	000420632	42MP 32	000421632
42MP/S17	000420652	42MP/S17	000421652
42MP/S21	000420653	42MP/S21	000421653
42MP/B9N	000420661	42MP/B9N	000421661
42HS/AS 1/4	000424106		
42HS/AS 5/16	000424108		
42HS/AS 3/8	000424110		
42HS/AS 7/16	000424111		
42HS/AS 1/2	000424113		
42HS/AS 9/16	000424114		
42HS/AS 5/8	000424116		
42HS/AS 11/16	000424117		
42HS/AS 3/4	000424119		
42HS/AS 13/16	000424121		
42HS/AS 7/8	000424122		
42HS/AS 15/16	000424124		
42HS/AS 1	000424125		
42HS/AS 1.1/16	000424127		
42HS/AS 1.1/8	000424129		
42HS/AS 1.1/4	000424132		
42HS/AS 1.5/16	000424133		
55MP 6X7	000550603		
55MP 8X9	000550606		
55MP 10X11	000550609		
55MP 12X13	000550612		
55MP 14X15	000550615		
55MP 16X17	000550618		
55MP 18X19	000550621		
55MP 20X22	000550624		
55MP 21X23	000550627		
55MP 24X26	000550630		
55MP 25X28	000550633		
55MP 27X29	000550636		
55MP 30X32	000550639		
55MP/S8	000550650		
55MP/S13	000550651		
55MP/S12	000550653		
96C-AS 1/16	000961702	96AS 1/16	000960702
96C-AS 3/32	000961706	96AS 3/32	000960706
96C-AS 1/8	000961710	96AS 1/8	000960710

96C-AS 5/32	000961714	96AS 5/32	000960714
96C-AS 3/16	000961716	96AS 3/16	000960716
96C-AS 7/32	000961718	96AS 7/32	000960718
96C-AS 1/4	000961720	96AS 1/4	000960720
96C-AS 5/16	000961724	96AS 5/16	000960724
96C-AS 3/8	000961728	96AS 3/8	000960728
97BTX-C 09	000971609	97BTX 09	000970109
97BTX-C 10	000971610	97BTX 10	000970110
97BTX-C 15	000971615	97BTX 15	000970115
97BTX-C 20	000971620	97BTX 20	000970120
97BTX-C 25	000971625	97BTX 25	000970125
97BTX-C 27	000971627	97BTX 27	000970127
97BTX-C 30	000971630	97BTX 30	000970130
97BTX-C 40	000971640	97BTX 40	000970140
188 10	001880010		
188 15	001880015		
339A	003390011		
339A/R	003390061		
366 350	003660035		
388 14	003880014		
388 16	003880016		
410AS 1/16	004100371		
410AS 5/64	004100372		
410AS 3/32	004100373		
410AS 7/64	004100374		
410AS 1/8	004100375		
410AS 9/64	004100376		
410AS 5/32	004100377		
410AS 11/64	004100378		
410AS 3/16	004100379		
410AS 13/64	004100380		
410AS 7/32	004100381		
410AS 15/64	004100382		
410AS 1/4	004100383		
410AS 17/64	004100384		
410AS 9/32	004100385		
410AS 19/64	004100386		
410AS 5/16	004100387		
410AS 21/64	004100388		
410AS 11/32	004100389		
410AS 23/64	004100390		
410AS 3/8	004100391		
410AS/SP21	004100429		
410AS/SPV1	004100430		
410AS/SEL21	004100433		
423 6	004230006	423CO 6	004230106
423 7	004230007	423CO 7	004230107
423 8	004230008	423CO 8	004230108
423 10	004230010	423CO 10	004230110
423A 6,5	004230015	423A-CO 6,5	004230115
423A 8,0	004230020	423A-CO 8	004230120
426/SB6	004260106		
428/C14	004280201	428FP/C7	004280203
428/C14	004280201	428FC/C7	004280204
428/SPV	004280202	428F/SPV	004280205
429/C14	004290201	429FP/C7	004290203
429/C14	004290201	429FC/C7	004290204
437K/16	004370016		
437K/8	004370020		
598/200SL	005980022		
599DGT-AN/10	005990610	599DGT-AW/135	005990713
599DGT-AN/20	005990620	599DGT-AW/340	005990734
665/6	006650006	666/5	006660705
665/10	006650010	666/10	006660710
665/10X	006650011	666/10X	006660711
665/20	006650020	666/20	006660720
665/30	006650030	666/30	006660730
665SW	006650100		
665LB/6	006650106	666-LBF.FT/5	006660765
665LB/10	006650110	666-LBF.FT/10	006660780
665LB/10X	006650111	666-LBF.FT/10X	006660781
665LB/20	006650120	666-LBF.FT/20	006660782
665LB/30	006650130	666-LBF.FT/30	006660783
720FTX 10	007200410		
720TC 90	007200769		
720TC 100	007200770		
720TC 110	007200771		
720TC 120	007200772		
720TC 135	007200773		
852 10	008520010		
860MIX/A10	008600900	861MIX/A10	008610800
860MIX/A31	008600902	861MIX/A31	008610802
860PHZ/A10	008600910	861PHZ/A10	008610810
860PE/A10	008600920	861PE/A10	008610820
860TX/A10	008600970	861TX/A10	008610870
861RIBE 5	008610705		
861RIBE 6	008610706		
861RIBE 7	008610707		
861RIBE 8	008610708		
861RIBE 9	008610709		
861XZN 5	008610725		
861XZN 6	008610726		

861XZN 8	008610728		
866RTX 40	008660520		
866RTX 45	008660525		
866RTX 50	008660530		
866RTX 55	008660535		
866RTX 60	008660540		
866RTX 70	008660545		
900/55	009000870	900/55	009001155
900MC 4	009002040		
900MC 5	009002050		
900MC 6	009002060		
900MC 7	009002070		
900MC 8	009002080		
900MC 9	009002090		
900MC 10	009002100		
900MC 11	009002110		
900MC 12	009002120		
900MC 13	009002130		
900MC 14	009002140		
900E-HS/55	009004880	900HS/55	009004155
900/55K	009009870	900/55	009001155
910/R55Q	009100877		
910/55	009100882	910/55	009101155
910/55Q	009100885		
910A/C16Q	009100932	910A/C16	009100936
910B/C16Q	009100933	910B/C16	009100937
910E-HS/55	009104880	910HS/55	009104155
910/55K	009109882	910/55	009101155
920/50	009200871	920/50	009201150
920/R55Q	009200877	920/RN55Q	009201126
920/55	009200882	920/55	009201155
920/55Q	009200885	920/55Q	009201156
920/50F	009200889	920/50F	009201151
920/55X	009200895	920/55X	009201158
920/55LC	009200896	920/55LC	009201159
920A/C21X	009200983	920A/C21	009200952
920U/C17M	009201797		
920E-HS/55LC	009204860	920HS/55LC	009204159
920/55K	009209882	920/55	009201155
928/R55	009280859	928/RN55	009281115
928/55	009280862	928/55	009281155
955 20,8	009550021		
956L 17,8	009560217		
960 27	009600027		
960T/A	009600032		
960T/B	009600033		
960T/C	009600034		
960T/F	009600037		
960T/G	009600038		
960T/H	009600039		
960/22EP 300	009600052		
960YP 13	009600063		
960YP 14	009600064		
960YP 17	009600067		
960D/13	009600073		
960D/14	009600074		
960D/17	009600077		
960F	009600148		
960G	009600151		
960H/C4	009600152		
960L	009600153		
960M	009600154		



MEGSZÜNT TERMÉKEK – HELYETTESÍTŐ/AJÁNLOTT TERMÉKEK

	MEGSZÜNT TERMÉK
	HELYETTESÍTŐ TERMÉK
	JAVASOLT TERMÉK

1462AD/BSC	014620435		
1462AD/SMN	014620436		
1463/KIT	014630001		
1464T	014640050		
1464IC	014640350		
1464IC-RK	014640377		
1464AP	014640450	1464APD	014640100
1464AP T12X12	014640453		
1464AP T12X14	014640454		
1464AP T14X12-M1,0	014640455		
1464AP T16X12	014640456		
1464FG	014640470	1464APD	014640100
1464FG/CP4	014640475	1464APD	014640100
1464TDI	014640600	1464BP	014640200
1464ADB	014640620	1464BP	014640200
1464PF	014640650		
1464PB	014640700	1464BP	014640200
1466TLF	014660201		
1466L 11	014660211		
1467/RK2	014670502		
1470PF	014700200		
1471A	014710010		
1471M/W50	014710079		
1471M/P	014710080		
1471PN/B1	014710081		
1471PN/B2	014710082		
1471PN/B3	014710083		
1471PN/B4	014710084		
1471PN/B5	014710085		
1472H	014720000		
1472FCA	014720041		
1472TM	014720200		
1472MT/VV	014720500		
1473T	014730582		
1474/C4	014740100		
1474E/VV	014740120		
1474E/VV2	014740150		
1475U	014750010		
1476T	014760200		
1477K/7	014770051		
1477D 13	014770113		
1477D 15	014770115		
1477D 16	014770116		
1477D 17	014770117		
1477D 19	014770119		
1479ML/S3	014790603		
1479ML/B17	014790700		
1482A/1	014820005	1482A/1B	014820004
1482A/5	014820015		
1482D	014820026		
1483K/12	014830012		
1483K/22	014830022		
1484PSA	014840012		
1485BPM	014850002		
1485VAG/12,5	014850062		
1485VAG/21,5	014850071		
1485VAG/K2	014850080		
1485MJ	014850150		
1485PMTJ	014850190		
1485FCA/T	014850210		
1485FCA/TS	014850215		
1485FRD/T	014850310		
1485MRC/T	014850315		
1485VLV/T	014850320		
1487/K2	014870100		
1489/33P	014890015		
1489/31T	014890016		
1489/R	014890020		
1489/E	014890025		
1489/C14	014890100		
1493FT	014930085		
1493VV	014930086		
1493HK	014930087		
1493FF	014930127	1493FF/2	014930128
1493 74-L15	014930210		
1493 90-L15	014930234		
1493 92-L10	014930236		
1493 93-L15	014930238		
1493 96-L18	014930246		
1493AL 79-L15	014930325		
1493AL 87-L16	014930335		
1493AL/CF 36	014930436		
1493B/S5	014930599		
1493C/ADB	014930900		
1493U/ADB	014930910		
1497KB/S3	014970050		

1497/S3	014970400		
1498MN/12-U	014980009		
1498SM-C	014980021		
1498SM-CP	014980022		
1498SM-A	014980023		
1498/4A	014980104	1498H/4A	014980204
1498/8A	014980108	1498H/8A	014980208
1498/25A	014980125	1498H/25A	014980225
1498/16A	014980126	1498H/16A	014980216
1498/40A	014980140		
1498/120A	014980142		
1498TB/12-24	014980401	1498TB/12-24N	014980402
1498ST/TB	014980410		
1498/12	014980480		
1498/24	014980490		
1498B/12-R02	014980502		
1505/C5	015050300		
1529/PG	015290010		
1529/C7	015290100		
1530/C16	015300316		
1533PR/5A	015330016		
1549	015490001		
1555C	015550202		
1557 37	015570137		
1557 46	015570146		
1557 56	015570156		
1557V	015570299		
1563/C4	015630010		
1566N 45X190	015660008		
1566P	015660091		
1650FT/1	016500060		
1650FT/2	016500070		
1717A 200	017170020		
1717B 250	017170125		
1730M 150	017300215		
1730M 200	017300220		
1730M 250	017300225		
1730V 38	017300338		
1741B	017410000	1741	017410003
1741B/C5	017410025	1741/C5	017410035
1741BP	017410350	1741P	017410303
1750CG 400	017500140	1750PF 400	017500141
1750CG 600	017500160	1750PF 550	017500161
1756C	017560502	1756V	017560504
1756C-20R	017560503	1756V-20R	017560505
1758A	017580010		
1760/OHM	017600025	1760OHM/2	017600027
1760PT	017600150	1760PT/N	017600155
1765/C24	017650001		
1766L	017660015		
1766LI	017660016		
1770BM	017700050	1770A	017700025
1833 L/USB	018330054	1833 L	018330004
1833RB-L/USB	018330975		
1837F	018370050	1837F/USB	018370060
1837M	018370450		
1837M/RA	018370975		
1838P	018380005	1838PN	018380008
1838COB	018380010	1838COMPACT	018380011
1838UV	018380150		
1860BH/120A	018600121		
1860BH/160A	018600161		
1860BH/160A	018600179		
1860BH/200A	018600201		
1860SQ	018600210		
1860RG	018600255		
1860EI	018600290		
1860M	018600301		
1860DM 16	018600310		
1860DM 40	018600311		
1860PMIG	018600350		
1860BH R/CM	018600612		
1860BH R/CS	018600613		
1860BHT/7	018600615		
1860BHT R/CM	018600616		
1860BHT R/CS	018600617		
1878 3	018780003		
1884/C12	018840100		
1885/C1	018850110		
1885/C1-R3	018850113		
1885/C1-R4	018850114		
1885/C1-R5	018850115		
1885/C1-R7	018850117		
1885/C2	018850120		
1885/C2-R2	018850122		
1885/C2-R3	018850123		
1885/C2-R4	018850124		
1885/C2-R5	018850125		
1885/C3	018850130		
1885/C3-R1	018850131		
1885/C3-R2	018850132		
1895G	018950800	1895GSI	018950810

1897	018970066		
1897CRB	018970101		
1897MV	018970103		
1897G	018970104		
1915C/L 11X16	019150116		
1916P 6X14	019160256		
1916P 8X17	019160258		
1916P 10X19	019160260		
1916S 6X8	019160306		
1916S 8X10	019160308		
1916S 10X12	019160310		
1917ST 6X8	019170306		
1917ST 8X10	019170308		
1917ST 10X12	019170310		
1918 1/8X6	019180106		
1918 1/8X8	019180108		
1918 1/4X6	019180116		
1918N 3/8X3/8	019180310		
1918N 1/2X1/2	019180320		
1924CD	019240007		
1924B	019240021		
1927CD	019270007	1927C	019270006
1927B	019270022	1927E	019270005
1927CD/K3	019270107		
1927B/K5	019270122		
1928CD	019280007	1928P	019280006
1930CD	019300022	1930PA	019300032
1945C	019450200		
1945C/G 16	019450216		
1945C/G 19	019450219		
1945C/G 22	019450222		
1945C/G 25	019450225		
1945C/G 28	019450228		
1945C/G 32	019450232		
1945C/G 35	019450235		
1945C/G 38	019450238		
1945C/G 40	019450240		
1945C/GP 15	019450255		
1945C/GP 16	019450256		
1945C/GP 20	019450260		
1945C/GP 25	019450265		
1945C/GP 30	019450270		
1945C/GP 32	019450272		
1945C/GP 35	019450275		
1945C/GP 38	019450278		
1945C/GP 40	019450280		
1945C/GP 45	019450285		
1945C/GP 50	019450290		
1949GPN	019490011		
1995MQ/G1	019950010	1997MQ/GM9	019970109
1995MQ/G2	019950013	1997MQ/GM10	019970110
1996MQ/GM 9	019960109	1997MQ/GM9	019970109
1996MQ/GM 10	019960110	1997MQ/GM10	019970110
1996SVG	019960133	1996VPG	019960134
2080/D10	020800070		
C4	021040000		
2104VU/0	021041122		
TV280	024000478	TV271	024000475
T18	024240018	T28	024240028
T19	024240019	T29	024240029
T22	024240022	T24	024240024
T281	024240281	T271	024240271
M31	024500031	M32	024500032
M39	024500039		
M79	024500079		
M219	024500219		
M305	024500305		
M310	024500310		
MB38	024504238		
MB45	024504245		
MB56	024504256		
MV39	024510039		
MV79	024510079		
MV82	024510082	MV84	024510084
MV83	024510083	MV87	024510087
MV90	024510090	MV89	024510089
MV92	024510092	MV93	024510093
MV94	024510094	MV95	024510095
MV96	024510096	MV97	024510097
MV100	024510100	MV104	024510104
MV116	024510116	MV117	024510117
MV120	024510120	MV119	024510119
MV126	024510126	MV139	024510139
MV305	024510305		
MV310	024510310		
MV105	024510871	MV107	024510107
MBV35	024524235		
MBV36	024524236	MBV29	024524229
MBV40	024524240	MBV27	024524227
MBV45	024524245		
MBV47	024524247	MBV70	024524270
MBV56	024524256		



MEGSZÜNT TERMÉKEK – HELYETTESÍTŐ/AJÁNLOTT TERMÉKEK

	MEGSZÜNT TERMÉK
	HELYETTESÍTŐ TERMÉK
	JAVASOLT TERMÉK

MMV100	024590100	MMV104	024590104
MMV105	024590105	MMV107	024590107
MCV20	027510021	MCV24	027510024
3014SAR/2	030140362		
3027/PR	030270400	3027PR/N	030270410
3070BE/S	030700201		
3070BE/F	030700202		
3070BE/B	030700203		
3070BE/K	030700250		
3075A 28	030750028		
3075A 30	030750030		
3079/21	030790021		
3091/10	030910010		
3091/20	030910020		
3092/10	030920010		
3092/20	030920020		
3092/30	030920030		
3092/35	030920035		
3092/40	030920040		
3094PA-O	030940101		
3094PA-G	030940102		
3094PA-R	030940103		
3700-COVER C37	037000930		
C38-O	038000001		
C38-R	038000002		
C38-G	038000003		
C38LA O	038000071		
C38LA R	038000072		
C38LA G	038000073		
C38L-O	038000081		
C38L-R	038000082		
C38L-G	038000083		
C38T-O	038000091		
C38T-R	038000092		
C38T-G	038000093		
C38C-O	038000201		
C38C-R	038000202		
C38C-G	038000203		
MCV21	041510021	MCV17	041510017
C45PRO X	045000001	C45PRO 2.0 X	045002001
C45PRO W	045000002	C45PRO 2.0 W	045002002
C45PRO AX	045000003	C45PRO 2.0 AX	045002003
C45PRO AW	045000004	C45PRO 2.0 AW	045002004
C45PRO BX	045000021	C45PRO 2.0 BX	045002021
C45PRO BW	045000022	C45PRO 2.0 BW	045002022
C45PRO CX	045000023	C45PRO 2.0 CX	045002023
C45PRO CW	045000024	C45PRO 2.0 CW	045002024
C45PRO DX	045000031	C45PRO 2.0 DX	045002031
C45PRO DW	045000032	C45PRO 2.0 DW	045002032
C45PRO EX	045000033	C45PRO 2.0 EX	045002033
C45PRO EW	045000034	C45PRO 2.0 EW	045002034
C45PRO FX	045000035	C45PRO 2.0 FX	045002035
C45PRO GX	045000036	C45PRO 2.0 GX	045002036
C45PRO GW	045000037	C45PRO 2.0 GW	045002037
C45PRO HX	045000038	C45PRO 2.0 HX	045002038
C45PRO HW	045000039	C45PRO 2.0 HW	045002039
C45PRO BPX-1,3	045000041	C45PRO 2.0 BPX-1,3	045002041
C45PRO BPX-2,0	045000042	C45PRO 2.0 BPX-2,0	045002042
C45PRO FW	045000045	C45PRO 2.0 FW	045002045
C45PRO BPW-1,3	045000051	C45PRO 2.0 BPW-1,3	045002051
C45PRO BPW-2,0	045000052	C45PRO 2.0 BPW-2,0	045002052
C45PX1/1-0,7MT	045000101	C45PRO20PX1E1/0,7MT	045002131
C45PX1/2-1,3MT	045000103	C45PRO20PX1E2/1,3MT	045002133
C45PX3/2-0,MT	045000110	C45PRO20PX3E2/0,MT	045002140
C45PW1/1-0,7MT	045000111	C45PRO 2.0 PW1E1/0,7MT	045002141
C45PW2/1-3MT	045000113	C45PRO 2.0 PW1E2/1,3MT	045002143
C45PW3/2,0MT	045000120	C45PRO 2.0 PW1E3/2,0MT	045002150
C45PRO M7A/X	045000161	C45PRO 2.0 M7A/X	045002161
C45PRO M7A/W	045000171	C45PRO 2.0 M7A/W	045002171
C45PRO C5	045000225	C45PRO 2.0 C5	045002226
C45PRO C7	045000227	C45PRO 2.0 C7	045002228
C45PRO ML	045000233	C45PRO 2.0 ML	045002233
C45PRO RD/W	045000240	C45PRO 2.0 RD/W	045002240
C45PRO RD/X	045000241	C45PRO 2.0 RD/X	045002241
C45PRO CORNER/X	045000401	C45PRO20CORNERX	045002401
C45PRO CAI/W	045000402	C45PRO 2.0 CAI/W	045002402
C45PRO CORNER/W	045000411	C45PRO20CORNERW	045002411
C45PRO CAI/X	045000412	C45PRO 2.0 CAI/X	045002412
RSC50	050001000	RSC50 2.0	050001001
RSC50 A	050001005	RSC50 2.0 A	050001006
RSC50 B	050001010	RSC50 2.0 B	050001011
RSC50 C	050001015	RSC50 2.0 C	050001016
RSC50 D	050001020	RSC50 2.0 D	050001021
RSC50 E	050001025	RSC50 2.0 E	050001026
RSC50 F	050001030	RSC50 2.0 F	050001031
RSC50 G	050001035	RSC50 2.0 G	050001036

RSC50 H	050001040	RSC50 2.0 H	050001041
RSC50 I	050001045	RSC50 2.0 I	050001046
RSC50 L	050001050	RSC50 2.0 L	050001051
RSC50 PG1/0,7MT	050001107	RSC50 2.0 NPG1/0,7MT	050001118
RSC50 PA1/1-0,7MT	050001108	RSC50 2.0 NPA1/0,7MT	050001117
RSC50 PG2/1-5,MT	050001114	RSC50 2.0 NPG2/1-5,MT	050001125
RSC50 PA2/1-5,MT	050001115	RSC50 2.0 NPA2/1-5,MT	050001124
RSC50 PG3/2-2,MT	050001122	RSC50 2.0 NPG3/2-2,MT	050001133
RSC50 PA3/2-2,MT	050001123	RSC50 2.0 NPA3/2-2,MT	050001132
RSC50 MA	050001222	RSC50 2.0 MA	050001262
RSC50 M4	050001224	RSC50 2.0 M4	050001264
RSC50 M5	050001225	RSC50 2.0 M5	050001265
RSC50 M7	050001227	RSC50 2.0 M7	050001267
RSC50 M8	050001228	RSC50 2.0 M8	050001268
RSC50 M10	050001230	RSC50 2.0 M10	050001231
RSC50 MS-AVV	050001241	RSC50 2.0 MS-AVV	050001281
RSC50 MS-2AVV	050001242	RSC50 2.0 MS-2AVV	050001282
RSC50 MS-2C	050001243	RSC50 2.0 MS-2C	050001283
RSC50 ML	050001244	RSC50 2.0 ML	050001284
RSC50 CS	050001245	RSC50 2.0 CS	050001285
RSC50 MDO	050001250	RSC50 2.0 MDO	050001290
RSC50 AC-A	050001329	RSC50 2.0 NAC-A	050001339
RSC50 AC-G	050001330	RSC50 2.0 NAC-G	050001340
RSC50 KAI-G	050001335	RSC50 2.0 KNAI-G	050001346
RSC50 KAI-A	050001336	RSC50 2.0 KNAI-A	050001345
5000 RSC50/PLED	050001714	5000 RSC50 2.0/PLEDC	050001712
C55BO/1	055000090		
C55BG/1	055000091		
C55KAS	0550000370		
C55STR-W/9016	0550000907		
C55STR-GO/1035	0550000909		
C56M O	0560000050		
C56M G	0560000053		
C56M R	0560000054		
C56B-O	0560000401	C58BC-W2,1	0580000621
C56B-G	0560000402	C58BC-W2,1	0580000621
C56B-R	0560000403	C58BC-W2,1	0580000621
C58M-O	0580000300		
C58M-G	0580000302		
C58M-R	0580000303		
C58B-O	0580000401	C58BC-W1,6	0580000601
C58B-G	0580000402	C58BC-W1,6	0580000601
C58B-R	0580000403	C58BC-W1,6	0580000601
5938U/2T	059381062		
5990V1	059900001		
5990V3	059900003		
6600 M/62	066000062		
6600 M/175	066000175	6600 M/174	066000174
6600 M/222	066000222		
6600 M/311	066000311		
6600 M/423	066000423		
6600 M/424	066000424		
6600 M/583	066000583		
6600 M/852	066000852		
6600 M/856	066000856		
6600 M/857	066000857		
6600 M/871	066000871		
6600 M/878	066000878		
6600 M/881	066000881		
6888B1/4	068880900		
6888B3/8	068880910		
6888B1/2	068880920		
7236BK 35	072360335	7243NC 35	072431635
7236BK 36	072360336	7243NC 36	072431636
7236BK 37	072360337	7243NC 37	072431637
7236BK 38	072360338	7243NC 38	072431638
7236BK 39	072360339	7243NC 39	072431639
7236BK 40	072360340	7243NC 40	072431640
7236BK 41	072360341	7243NC 41	072431641
7236BK 42	072360342	7243NC 42	072431642
7236BK 43	072360343	7243NC 43	072431643
7236BK 44	072360344	7243NC 44	072431644
7236BK 45	072360345	7243NC 45	072431645
7236BK 46	072360346	7243NC 46	072431646
7236BK 47	072360347	7243NC 47	072431647
7236BK 48	072360348	7243NC 48	072431648
7238WR 35	072380235		
7238WR 36	072380236		
7238WR 37	072380237		
7238WR 38	072380238		
7238WR 39	072380239		
7238WR 40	072380240		
7238WR 41	072380241		
7238WR 42	072380242		
7238WR 43	072380243		
7238WR 44	072380244		
7238WR 45	072380245		
7238WR 46	072380246		
7238WR 47	072380247		
7238WR 48	072380248		
7241BK 35	072411235	7246NB 35	072461635
7241BK 36	072411236	7246NB 36	072461636

7241BK 37	072411237	7246NB 37	072461637
7241BK 38	072411238	7246NB 38	072461638
7241BK 39	072411239	7246NB 39	072461639
7241BK 40	072411240	7246NB 40	072461640
7241BK 41	072411241	7246NB 41	072461641
7241BK 42	072411242	7246NB 42	072461642
7241BK 43	072411243	7246NB 43	072461643
7241BK 44	072411244	7246NB 44	072461644
7241BK 45	072411245	7246NB 45	072461645
7241BK 46	072411246	7246NB 46	072461646
7241BK 47	072411247	7246NB 47	072461647
7241BK 48	072411248	7246NB 48	072461648
7241CK 35	072411535	7241NC 35	072411635
7241CK 36	072411536	7241NC 36	072411636
7241CK 37	072411537	7241NC 37	072411637
7241CK 38	072411538	7241NC 38	072411638
7241CK 39	072411539	7241NC 39	072411639
7241CK 40	072411540	7241NC 40	072411640
7241CK 41	072411541	7241NC 41	072411641
7241CK 42	072411542	7241NC 42	072411642
7241CK 43	072411543	7241NC 43	072411643
7241CK 44	072411544	7241NC 44	072411644
7241CK 45	072411545	7241NC 45	072411645
7241CK 46	072411546	7241NC 46	072411646
7241CK 47	072411547	7241NC 47	072411647
7241CK 48	072411548	7241NC 48	072411648
7243FT 35	072430635	7243NFT 35	072430535
7243FT 36	072430636	7243NFT 36	072430536
7243FT 37	072430637	7243NFT 37	072430537
7243FT 38	072430638	7243NFT 38	072430538
7243FT 39	072430639	7243NFT 39	072430539
7243FT 40	072430640	7243NFT 40	072430540
7243FT 41	072430641	7243NFT 41	072430541
7243FT 42	072430642	7243NFT 42	072430542
7243FT 43	072430643	7243NFT 43	072430543
7243FT 44	072430644	7243NFT 44	072430544
7243FT 45	072430645	7243NFT 45	072430545
7243FT 46	072430646	7243NFT 46	072430546
7243FT 47	072430647	7243NFT 47	072430547
7243FT 48	072430648	7243NFT 48	072430548
7243CR 35	072430735		
7243CR 36	072430736		
7243CR 37	072430737		
7243CR 38	072430738		
7243CR 39	072430739		
7243CR 40	072430740		
7243CR 41	072430741		
7243CR 42	072430742		
7243CR 43	072430743		
7243CR 44	072430744		
7243CR 45	072430745		
7243CR 46	072430746		
7243CR 47	072430747		
7243CR 48	072430748		
7243BK 35	072431235	7248NB 35	072481635
7243BK 36	072431236	7248NB 36	072481636
7243BK 37	072431237	7248NB 37	072481637
7243BK 38	072431238	7248	



MEGSZÜNT TERMÉKEK – HELYETTESÍTŐ/AJÁNLOTT TERMÉKEK

	MEGSZÜNT TERMÉK
	HELYETTESÍTŐ TERMÉK
	JAVASOLT TERMÉK

7245BK 45	072451245	7245NB 45	072451645
7245BK 46	072451246	7245NB 46	072451646
7245BK 47	072451247	7245NB 47	072451647
7245BK 48	072451248	7245NB 48	072451648
7246BK 35	072461235	7246NB 35	072461635
7246BK 36	072461236	7246NB 36	072461636
7246BK 37	072461237	7246NB 37	072461637
7246BK 38	072461238	7246NB 38	072461638
7246BK 39	072461239	7246NB 39	072461639
7246BK 40	072461240	7246NB 40	072461640
7246BK 41	072461241	7246NB 41	072461641
7246BK 42	072461242	7246NB 42	072461642
7246BK 43	072461243	7246NB 43	072461643
7246BK 44	072461244	7246NB 44	072461644
7246BK 45	072461245	7246NB 45	072461645
7246BK 46	072461246	7246NB 46	072461646
7246BK 47	072461247	7246NB 47	072461647
7246BK 48	072461248	7246NB 48	072461648
7247BK 35	072471235	7247NB 35	072470635
7247BK 36	072471236	7247NB 36	072470636
7247BK 37	072471237	7247NB 37	072470637
7247BK 38	072471238	7247NB 38	072470638
7247BK 39	072471239	7247NB 39	072470639
7247BK 40	072471240	7247NB 40	072470640
7247BK 41	072471241	7247NB 41	072470641
7247BK 42	072471242	7247NB 42	072470642
7247BK 43	072471243	7247NB 43	072470643
7247BK 44	072471244	7247NB 44	072470644
7247BK 45	072471245	7247NB 45	072470645
7247BK 46	072471246	7247NB 46	072470646
7247BK 47	072471247	7247NB 47	072470647
7247BK 48	072471248	7247NB 48	072470648
7249GK 35	072490235	7248NB 35	072481635
7249GK 36	072490236	7248NB 36	072481636
7249GK 37	072490237	7248NB 37	072481637
7249GK 38	072490238	7248NB 38	072481638
7249GK 39	072490239	7248NB 39	072481639
7249GK 40	072490240	7248NB 40	072481640
7249GK 41	072490241	7248NB 41	072481641
7249GK 42	072490242	7248NB 42	072481642
7249GK 43	072490243	7248NB 43	072481643
7249GK 44	072490244	7248NB 44	072481644
7249GK 45	072490245	7248NB 45	072481645
7249GK 46	072490246	7248NB 46	072481646
7249GK 47	072490247	7248NB 47	072481647
7249GK 48	072490248	7248NB 48	072481648
7314AF 35	073140235	7316NG 35	073160635
7314AF 36	073140236	7316NG 36	073160636
7314AF 37	073140237	7316NG 37	073160637
7314AF 38	073140238	7316NG 38	073160638
7314AF 39	073140239	7316NG 39	073160639
7314AF 40	073140240	7316NG 40	073160640
7314AF 41	073140241	7316NG 41	073160641
7314AF 42	073140242	7316NG 42	073160642
7314AF 43	073140243	7316NG 43	073160643
7314AF 44	073140244	7316NG 44	073160644
7314AF 45	073140245	7316NG 45	073160645
7314AF 46	073140246	7316NG 46	073160646
7314AF 47	073140247	7316NG 47	073160647
7314AF 48	073140248	7316NG 48	073160648
7315AN 35	073150535	7320NA 35	073200535
7315AN 36	073150536	7320NA 36	073200536
7315AN 37	073150537	7320NA 37	073200537
7315AN 38	073150538	7320NA 38	073200538
7315AN 39	073150539	7320NA 39	073200539
7315AN 40	073150540	7320NA 40	073200540
7315AN 41	073150541	7320NA 41	073200541
7315AN 42	073150542	7320NA 42	073200542
7315AN 43	073150543	7320NA 43	073200543
7315AN 44	073150544	7320NA 44	073200544
7315AN 45	073150545	7320NA 45	073200545
7315AN 46	073150546	7320NA 46	073200546
7315AN 47	073150547	7320NA 47	073200547
7315AN 48	073150548	7320NA 48	073200548
7318AN 35	073180535	7321NA 35	073210535
7318AN 36	073180536	7321NA 36	073210536
7318AN 37	073180537	7321NA 37	073210537
7318AN 38	073180538	7321NA 38	073210538
7318AN 39	073180539	7321NA 39	073210539
7318AN 40	073180540	7321NA 40	073210540
7318AN 41	073180541	7321NA 41	073210541
7318AN 42	073180542	7321NA 42	073210542
7318AN 43	073180543	7321NA 43	073210543
7318AN 44	073180544	7321NA 44	073210544
7318AN 45	073180545	7321NA 45	073210545
7318AN 46	073180546	7321NA 46	073210546

7318AN 47	073180547	7321NA 47	073210547
7318AN 48	073180548	7321NA 48	073210548
7320NA 35	073200435	7320NA 35	073200535
7320NA 36	073200436	7320NA 36	073200536
7320NA 37	073200437	7320NA 37	073200537
7320NA 38	073200438	7320NA 38	073200538
7320NA 39	073200439	7320NA 39	073200539
7320NA 40	073200440	7320NA 40	073200540
7320NA 41	073200441	7320NA 41	073200541
7320NA 42	073200442	7320NA 42	073200542
7320NA 43	073200443	7320NA 43	073200543
7320NA 44	073200444	7320NA 44	073200544
7320NA 45	073200445	7320NA 45	073200545
7320NA 46	073200446	7320NA 46	073200546
7320NA 47	073200447	7320NA 47	073200547
7320NA 48	073200448	7320NA 48	073200548
7321NA 35	073210435	7321NA 35	073210535
7321NA 36	073210436	7321NA 36	073210536
7321NA 37	073210437	7321NA 37	073210537
7321NA 38	073210438	7321NA 38	073210538
7321NA 39	073210439	7321NA 39	073210539
7321NA 40	073210440	7321NA 40	073210540
7321NA 41	073210441	7321NA 41	073210541
7321NA 42	073210442	7321NA 42	073210542
7321NA 43	073210443	7321NA 43	073210543
7321NA 44	073210444	7321NA 44	073210544
7321NA 45	073210445	7321NA 45	073210545
7321NA 46	073210446	7321NA 46	073210546
7321NA 47	073210447	7321NA 47	073210547
7321NA 48	073210448	7321NA 48	073210548
7352A 38	073520038	7352B 38	073520138
7352A 39	073520039	7352B 39	073520139
7352A 40	073520040	7352B 40	073520140
7352A 41	073520041	7352B 41	073520141
7352A 42	073520042	7352B 42	073520142
7352A 43	073520043	7352B 43	073520143
7352A 44	073520044	7352B 44	073520144
7352A 45	073520045	7352B 45	073520145
7352A 46	073520046	7352B 46	073520146
7352A 47	073520047	7352B 47	073520147
7352A 48	073520048	7352B 48	073520148
7353Y 38	073530038	7352B 38	073520138
7353Y 39	073530039	7352B 39	073520139
7353Y 40	073530040	7352B 40	073520140
7353Y 41	073530041	7352B 41	073520141
7353Y 42	073530042	7352B 42	073520142
7353Y 43	073530043	7352B 43	073520143
7353Y 44	073530044	7352B 44	073520144
7353Y 45	073530045	7352B 45	073520145
7353Y 46	073530046	7352B 46	073520146
7353Y 47	073530047	7352B 47	073520147
7353Y 48	073530048	7352B 48	073520148
7355V 38	073550038	7357V 38	073570138
7355V 39	073550039	7357V 39	073570139
7355V 40	073550040	7357V 40	073570140
7355V 41	073550041	7357V 41	073570141
7355V 42	073550042	7357V 42	073570142
7355V 43	073550043	7357V 43	073570143
7355V 44	073550044	7357V 44	073570144
7355V 45	073550045	7357V 45	073570145
7355V 46	073550046	7357V 46	073570146
7355V 47	073550047	7357V 47	073570147
7355V 48	073550048	7357V 48	073570148
7376A 38	073760038		
7398T 35	073981335		
7398T 36	073981336		
7398T 37	073981337		
7398T 38	073981338		
7398T 39	073981339		
7398T 40	073981340		
7398T 41	073981341		
7398T 42	073981342		
7398T 43	073981343		
7398T 44	073981344		
7398T 45	073981345		
7398T 46	073981346		
7398T 47	073981347		
7398T 48	073981348		
7547BL XS	075470200	7552BL XS	075520300
7547BL S	075470201	7552BL S	075520301
7547BL M	075470202	7552BL M	075520302
7547BL L	075470203	7552BL L	075520303
7547BL XL	075470204	7552BL XL	075520304
7547BL XXL	075470205	7552BL XXL	075520305
7547BL XXXL	075470206	7552BL XXXL	075520306
7547G XS	075470300	7552G XS	075520400
7547G S	075470301	7552G S	075520401
7547G M	075470302	7552G M	075520402
7547G L	075470303	7552G L	075520403
7547G XL	075470304	7552G XL	075520404
7547G XXL	075470305	7552G XXL	075520405
7547G XXXL	075470306	7552G XXXL	075520406

7547N XS	075470400	7552N XS	075520500
7547N S	075470401	7552N S	075520501
7547N M	075470402	7552N M	075520502
7547N L	075470403	7552N L	075520503
7547N XL	075470404	7552N XL	075520504
7547N XXL	075470405	7552N XXL	075520505
7547N XXXL	075470406	7552N XXXL	075520506
7547AZ XS	075470500		
7547AZ S	075470501		
7547AZ M	075470502		
7547AZ L	075470503		
7547AZ XL	075470504		
7547AZ XXL	075470505		
7547AZ XXXL	075470506		
7547R XS	075470600		
7547R S	075470601		
7547R M	075470602		
7547R L	075470603		
7547R XL	075470604		
7547R XXL	075470605		
7547R XXXL	075470606		
7549BL XS	075490200	7553BL XS	075530300
7549BL S	075490201	7553BL S	075530301
7549BL M	075490202	7553BL M	075530302
7549BL L	075490203	7553BL L	075530303
7549BL XL	075490204	7553BL XL	075530304
7549BL XXL	075490205	7553BL XXL	075530305
7549BL XXXL	075490206	7553BL XXXL	075530306
7549G XS	075490300	7553G XS	075530400
7549G S	075490301	7553G S	075530401
7549G M	075490302	7553G M	075530402
7549G L	075490303	7553G L	075530403
7549G XL	075490304	7553G XL	075530404
7549G XXL	075490305	7553G XXL	075530405
7549G XXXL	075490306	7553G XXXL	075530406
7549N XS	075490400	7553N XS	075530500
7549N S	075490401	7553N S	075530501
7549N M	075490402	7553N M	0



MEGSZÜNT TERMÉKEK – HELYETTESÍTŐ/AJÁNLOTT TERMÉKEK

	MEGSZÜNT TERMÉK
	HELYETTESÍTŐ TERMÉK
	JAVASOLT TERMÉK

7673NG L	076730003	7647GG L	076470013
7673NG XL	076730004	7647GG XL	076470014
7673NG XXL	076730005	7647GG XXL	076470015
7673NG XXXL	076730006	7647GG XXXL	076470016
7674NG S	076740001	7679GG S	076790011
7674NG M	076740002	7679GG M	076790012
7674NG L	076740003	7679GG L	076790013
7674NG XL	076740004	7679GG XL	076790014
7674NG XXL	076740005	7679GG XXL	076790015
7674NG XXXL	076740006	7679GG XXXL	076790016
7830ST XS	078300000	7820SG XS	078200100
7830ST S	078300001	7820SG S	078200101
7830ST M	078300002	7820SG M	078200102
7830ST L	078300003	7820SG L	078200103
7830ST XL	078300004	7820SG XL	078200104
7830ST XXL	078300005	7820SG XXL	078200105
7830ST XXXL	078300006	7820SG XXXL	078200106
7831ST XS	078310000	7821SG XS	078210100
7831ST S	078310001	7821SG S	078210101
7831ST M	078310002	7821SG M	078210102
7831ST L	078310003	7821SG L	078210103
7831ST XL	078310004	7821SG XL	078210104
7831ST XXL	078310005	7821SG XXL	078210105
7831ST XXXL	078310006	7821SG XXXL	078210106
7880SC XS	078800000		
7880SC S	078800001		
7880SC M	078800002		
7880SC L	078800003		
7880SC XL	078800004		
7880SC XXL	078800005		
7880SC XXXL	078800006		
7900V XS	079000500	7900G XS	079000800
7900V S	079000501	7900G S	079000801
7900V M	079000502	7900G M	079000802
7900V L	079000503	7900G L	079000803
7900V XL	079000504	7900G XL	079000804
7900V XXL	079000505	7900G XXL	079000805
7900V XXXL	079000506	7900G XXXL	079000806
7900V XXXXL	079000507	7900G XXXXL	079000807
7900P XS	079000600	7900G XS	079000800
7900P S	079000601	7900G S	079000801
7900P M	079000602	7900G M	079000802
7900P L	079000603	7900G L	079000803
7900P XL	079000604	7900G XL	079000804
7900P XXL	079000605	7900G XXL	079000805
7900P XXXL	079000606	7900G XXXL	079000806
7900P XXXXL	079000607	7900G XXXXL	079000807
7900B XS	079000700	7900G XS	079000800
7900B S	079000701	7900G S	079000801
7900B M	079000702	7900G M	079000802
7900B L	079000703	7900G L	079000803
7900B XL	079000704	7900G XL	079000804
7900B XXL	079000705	7900G XXL	079000805
7900B XXXL	079000706	7900G XXXL	079000806
7900B XXXXL	079000707	7900G XXXXL	079000807
7901G XS	079010800	7861G XS	078610800
7901G S	079010801	7861G S	078610801
7901G M	079010802	7861G M	078610802
7901G L	079010803	7861G L	078610803
7901G XL	079010804	7861G XL	078610804
7901G XXL	079010805	7861G XXL	078610805
7901G XXXL	079010806	7861G XXXL	078610806
7901G XXXXL	079010807	7861G XXXXL	078610807
7903P XS	079030600	7903G XS	079030800
7903P S	079030601	7903G S	079030801
7903P M	079030602	7903G M	079030802
7903P L	079030603	7903G L	079030803
7903P XL	079030604	7903G XL	079030804
7903P XXL	079030605	7903G XXL	079030805
7903P XXXL	079030606	7903G XXXL	079030806
7903P XXXXL	079030607	7903G XXXXL	079030807
7909V XS	079090500	7909G XS	079090800
7909V S	079090501	7909G S	079090801
7909V M	079090502	7909G M	079090802
7909V L	079090503	7909G L	079090803
7909V XL	079090504	7909G XL	079090804
7909V XXL	079090505	7909G XXL	079090805
7909V XXXL	079090506	7909G XXXL	079090806
7909V XXXXL	079090507	7909G XXXXL	079090807
7909P XS	079090600	7909G XS	079090800
7909P S	079090601	7909G S	079090801
7909P M	079090602	7909G M	079090802
7909P L	079090603	7909G L	079090803
7909P XL	079090604	7909G XL	079090804
7909P XXL	079090605	7909G XXL	079090805
7909P XXXL	079090606	7909G XXXL	079090806

7909P XXXXL	079090607	7909G XXXXL	079090807
7909B XS	079090700	7909G XS	079090800
7909B S	079090701	7909G S	079090801
7909B M	079090702	7909G M	079090802
7909B L	079090703	7909G L	079090803
7909B XL	079090704	7909G XL	079090804
7909B XXL	079090705	7909G XXL	079090805
7909B XXXL	079090706	7909G XXXL	079090806
7909B XXXXL	079090707	7909G XXXXL	079090807
7940 XXXL	079400006		
7940 XXXXL	079400007		
7970 XS	079700000	7971B XS	079710200
7970 S	079700001	7971B S	079710201
7970 M	079700002	7971B M	079710202
7970 L	079700003	7971B L	079710203
7970 XL	079700004	7971B XL	079710204
7970 XXL	079700005	7971B XXL	079710205
7970 XXXL	079700006	7971B XXXL	079710206
7971L XS	079710100	7971B XS	079710200
7971L S	079710101	7971B S	079710201
7971L M	079710102	7971B M	079710202
7971L L	079710103	7971B L	079710203
7971L XL	079710104	7971B XL	079710204
7971L XXL	079710105	7971B XXL	079710205
7971L XXXL	079710106	7971B XXXL	079710206
7978L XS	079780100	7978B XS	079780200
7978L S	079780101	7978B S	079780201
7978L M	079780102	7978B M	079780202
7978L L	079780103	7978B L	079780203
7978L XL	079780104	7978B XL	079780204
7978L XXL	079780105	7978B XXL	079780205
7978L XXXL	079780106	7978B XXXL	079780206
7979 S	079790001	7978B S	079780201
7979 M	079790002	7978B M	079780202
7979 L	079790003	7978B L	079780203
7979 XL	079790004	7978B XL	079780204
7979 XXL	079790005	7978B XXL	079780205
7979 XXXL	079790006	7978B XXXL	079780206
7984EG	079840520	7984G	079840525
8080FM 4	080800204		
8080FM 5	080800205	8581 5	085810005
8080FM 6	080800206	8581 6	085810006
8080FM 7	080800207		
8080FM 8	080800208		
8082 4	080820004		
8082 5	080820005		
8082 6	080820006		
8082 7	080820007		
8082 8	080820008		
8083 3	080830003	8583GS 3	085830003
8083 4	080830004	8583GS 4	085830004
8083 5	080830005	8583GS 5	085830005
8083 6	080830006	8583GS 6	085830006
8083 8	080830008	8583GS 8	085830008
8114 8	081140008	8514M 8	085140008
8114 10	081140010	8514M 10	085140010
8114 12	081140012	8514M 12	085140012
8114 14	081140014	8514M 14	085140014
8114 16	081140016	8514M 16	085140016
8114 18	081140018	8514M 18	085140018
8114 20	081140020	8514M 20	085140020
8114 22	081140022	8514M 22	085140022
8116 6	081160006	8514S 6	085140106
8116 8	081160008	8514S 8	085140108
8116 10	081160010	8514S 10	085140110
8116 12	081160012	8514S 12	085140112
8116 14	081160014	8514S 14	085140114
8116 16	081160016	8514S 16	085140116
8116 18	081160018	8514S 18	085140118
8116 20	081160020	8514S 20	085140120
8116 22	081160022	8514S 22	085140122
8181 6/S4	081810906	8181 6/B4	081810916
8182 8,5/S2	081821985	8182 8,5/B2	081821985
VP-LD	088880358		
8889PD/7	088890427		
8889CD/7	088890437		
9500TL S	095000051		
9500TL M	095000052		
9500TL L	095000053		
9500TL XL	095000054		
9500TL XXL	095000055		
9501TL S	095010051		
9501TL M	095010052		
9501TL L	095010053		
9501TL XL	095010054		
9501TL XXL	095010055		
9502TL S	095020051		
9502TL M	095020052		
9502TL L	095020053		
9502TL XL	095020054		
9502TL XXL	095020055		
9505TL S	095050051		

9505TL M	095050052		
9505TL L	095050053		
9505TL XL	095050054		
9505TL XXL	095050055		
9526P	095260010	9526MC	095260020
9537TL S	095370051		
9537TL M	095370052		
9537TL L	095370053		
9537TL XL	095370054		
9537TL XXL	095370055		
9542G XXXL	095420017		
9542AT S	095420072		
9542AT M	095420073		
9542AT L	095420074		
9542AT XL	095420075		
9542AT XXL	095420076		
9542AT XXXL	095420077		
9561V 2,5	095610200		
9590B	095900000		
9592MB	095920060		
9592M/50	095920100		
9593 S	095930200		
9741 (3)	097412040		
9743 (1)	097430050		
9743 (2)	097431050		
9743 (3)	097432050		
9745 (3)	097452040		
9746 (3)	097462040		
9749 (2)	097491040		
9749 (3)	097492040		
9755 (3)	097552040		
9765 (3)	097652040		
9775 (2)	097751040		
9775 (3)	097752040		
9841R P200 (3)	098412020		
9841N P200 (3)	098412120		
9851 T5 (3)	098512500		
9899 920C-17	098990137	9899 920C17	098990147
C99V1	099000250		
C99PC	099000491		
C99C-V3	099000496		
C99P12-V0	099000499		
11001H 230X3,2	110010733	11001 230X3,2	110010233
11003 115X2,5	110030117	11001 115X3,2	110010118
11003 125X2,5	110030127	11001 125X3,2	110010128
11003 180X2,5	110030182		
11003 230X2,5	110030232	11001 230X3,2	110010233
11011 180X6,5	110110180		
11011H 115X6,5	110110615	11011 115X6,5	110110115
11011H 125X6,5	110110625	11011 125X6,5	110110125
11011H 180X6,5	110110680		
11011H 230X6,5	110110730	11011 230X6,5	110110230
11018 300X2,5	110180030		
11018 350X3,0	110180035		
11018 400X3,2	110180040		
11019 300X3,8	110190030		
11019 350X4,2	110190035		
11019 400X4,5	110190040		
11021 180X3,2	110210183		
11024 230X2,0	110240230	11038 2,0-22,23	110380022
11031 1,0-6	110310006		
11031 1,0-10	110310010		
11031 1,6-10	110310020	</	



MEGSZÜNT TERMÉKEK – HELYETTESÍTŐ/AJÁNLOTT TERMÉKEK

MEGSZÜNT TERMÉK
HELYETTESÍTŐ TERMÉK
JAVASOLT TERMÉK

11101 30X10	111010034	11101 30X30	111010035
11101 32X20	111010037		
11101 40X25	111010043	11101 40X20	111010042
11101 50X15	111010051	11101 50X25	111010052
11102 8X20	111020008		
11102 10X15	111020010	11101 10X15	111010011
11102 10X30	111020020	11101 10X32	111010014
11102 12X15	111020022		
11102 15X15	111020035	11101 15X15	111010019
11102 15X30	111020040	11101 16X32	111010022
11102 20X30	111020060	11101 20X30	111010027
11105 20X65	111050020		
11106 6X10	111060006		
11110 10X15	111100010		
11115 10X20	111150010		
11116 22X70	111160022	11116 20X50	111160020
11120 6X13	111200006		
11121 6X25	111210007		
11121 12X20	111210012		
11121 20X25	111210020		
11121 25X25	111210025		
11121 30X30	111210030		
11125 6X20	111250006		
11125 25X25	111250025		
11125 30X50	111250030		
11125 40X40	111250040		
11130 6X6	111300006		
11130 8X8	111300008		
11130 10X10	111300010		
11132 10X10	111320010		
11132 15X15	111320015		
11132 20X20	111320020		
11135 30X6	111350030		
11135 40X10	111350040		
11140 20X30	111400020		
11140 25X25	111400025		
11140 30X30	111400030		
11140 50X10	111400050		
11141 20X40	111410020		
11141 30X40	111410030		
11141 40X40	111410040		
11145 20X30	111450020		
11145 25X50	111450025		
11200A 40	112000004	11202A 40	112020004
11200A 60	112000006	11202A 60	112020006
11200A 80	112000008	11202A 80	112020008
11200A 120	112000012	11202A 120	112020012
11200B 40	112000104	11202B 40	112020104
11200B 60	112000106	11202B 60	112020106
11200B 80	112000108	11202B 80	112020108
11202C 40	112020204		
11202C 60	112020206		
11208A 40	112080004	11204A 40	112040004
11208A 60	112080006	11204A 60	112040006
11208B 40	112080104	11204B 40	112040104
11208B 60	112080106	11204B 60	112040106
11212A 40	112120004	11214A 40	112140004
11212A 60	112120006	11214A 60	112140006
11212A 80	112120008	11214A 80	112140008
11212A 120	112120012	11214A 120	112140012
11212B 40	112120104		
11212B 60	112120106		
11212B 80	112120108		
11214B 40	112140104	11216B 40	112160104
11214B 60	112140106	11216B 60	112160106
11214B 80	112140108	11216B 80	112160108
11214C 40	112140204		
11214C 60	112140206		
11218A 40	112180004	11216A 40	112160004
11218A 60	112180006	11216A 60	112160006
11218B 40	112180104	11216B 40	112160104
11218B 60	112180106	11216B 60	112160106
11220A 40	112200004		
11220A 60	112200006		
11220A 80	112200008		
11220A 120	112200012		
11220B 40	112200104		
11220B 60	112200106		
11220B 80	112200108		
11222B 40	112220104		
11222B 60	112220106		
11222B 80	112220108		
11230A 40	112300004	11234A 40	112340004
11230A 60	112300006	11234A 60	112340006
11230A 80	112300008	11234A 80	112340008
11230A 120	112300012	11234A 120	112340012

11230B 40	112300104		
11230B 60	112300106		
11232A 40	112320004	11234A 40	112340004
11232A 60	112320006	11234A 60	112340006
11232A 80	112320008	11234A 80	112340008
11232A 120	112320012	11234A 120	112340012
11240A 40	112400004	11246A 40	112460004
11240A 60	112400006	11246A 60	112460006
11240B 40	112400104		
11240B 60	112400106		
11242A 40	112420004	11248A 40	112480004
11242A 60	112420006	11248A 60	112480006
11242B 40	112420104		
11242B 60	112420106		
11248B 40	112480104		
11248B 60	112480106		
11259 125	112590125		
11266 20-40	112660004	11266 20-60	112660006
11266 40-80	112660028	11266 40-60	112660026
11271A C	112710001		
11271A M	112710002		
11271A F	112710003		
11271A VF	112710004		
11271B C	112710011		
11271B M	112710012		
11271B F	112710013		
11271B VF	112710014		
11271C C	112710021		
11271C M	112710022		
11271C F	112710023		
11271C VF	112710024		
11276A 60	112760006		
11276A 80	112760008		
11276A 120	112760012		
11276B 60	112760016		
11276B 80	112760018		
11276B 120	112760022		
11276C 60	112760036		
11276C 80	112760038		
11276C 120	112760042		
11300A 40	113000004		
11300A 60	113000006		
11300A 80	113000008		
11300A 120	113000012		
11300A 180	113000018		
11300A 220	113000022		
11300B 40	113000104		
11300B 60	113000106		
11300B 80	113000108		
11300B 120	113000112		
11300B 180	113000118		
11300B 220	113000122		
11300C 40	113000204		
11300C 60	113000206		
11300C 80	113000208		
11300C 120	113000212		
11300C 180	113000218		
11300D 40	113000304		
11300D 60	113000306		
11300D 80	113000308		
11300D 120	113000312		
11300D 180	113000318		
11300D 220	113000322		
11300E 40	113000404		
11300E 60	113000406		
11300E 80	113000408		
11300E 120	113000412		
11300F 40	113000504		
11300F 60	113000506		
11300F 80	113000508		
11300F 120	113000512		
11300F 180	113000518		
11300F 220	113000522		
11300G 40	113000604		
11300G 60	113000606		
11300G 80	113000608		
11320 C	113200006		
11320 M	113200008		
11320 F	113200012		
11320 VF	113200024		
11411 40	114110004		
11411 60	114110006		
11411 80	114110008		
11411 120	114110012		
11411 240	114110024		
11415B C	114150106		
11415B M	114150108		
11415B F	114150112		
11415B VF	114150124		
11420B C	114200106		
11420B M	114200108		
11420B F	114200112		

11420B VF	114200124
11431 C	114310006
11431 M	114310008
11431 F	114310012
11431 VF	114310024
11440A 24	114400024
11440A 36	114400036
11440A 60	114400060
11440A 120	114400120
11440B 24	114400224
11440B 36	114400236
11440B 60	114400260
11440B 120	114400320
11440C 24	114400424
11440C 36	114400436
11440C 60	114400460
11440C 120	114400520
11450A 24	114500024
11450A 36	114500036
11450A 60	114500060
11450A 120	114500120
11450B 24	114500224
11450B 36	114500236
11450B 60	114500260
11450B 120	114500320
11450C 24	114500424
11450C 36	114500436
11450C 60	114500460
11450C 120	114500520
11488PF 115	114880115
11488PF 125	114880125
11488PF 180	114880180
11491 40	114910004
11491 60	114910006
11491 80	114910008
11491 100	114910010
11491 120	114910012
11491 150	114910015
11491 180	114910018
11491 220	114910022
11491 240	114910024
11491 320	114910032
11491 400	114910040
11493 40	114930004
11493 60	114930006
11493 80	114930008
11493 100	114930010
11493 120	114930012
11493 150	114930015
11493 180	114930018
11493 220	114930022
11493 240	114930024
11493 320	114930032
11493 400	114930040
11495 40	114950004
11495 60	114950006
11495 80	114950008
11495 100	114950010
11495 120	114950012
11495 180	114950018
11495 240	114950024
11495 400	114950040
11498 M	114980008
11498 F	114980012
11498 VF	114980015
11498 UF	114980018

1000V-ig szigetelt szerszámok	278÷284
Acéllemez megfogók	692
Ácsceruza	209
Akkumulátor töltő készülék	188÷193
Akkumulátoros és elektromos termékek	306÷319
Akkumulátoros gépek	306÷314
Állítható hajtóvas menettűrókhoz	46÷51
Állítható villáskulcsok, skálával	24÷25; 286; 294; 300
Állványozó csillagkulcs, speciális fejkiképzés	17; 286; 299
Alumínium fellépő küszöb	233
Ár	214
Ásólapát, szikramentes	305
Asztali csősatuk	35
Autójavítás	118÷124; 130÷131; 158÷164; 169÷202; 220÷233; 247÷252; 257÷266
Automata kábeldob szerelőlámpával	242÷244
Automata rugós tömlődob, levegőhöz és vízhez	339
Bádogos olló	134
Bemutatóállványok	610÷623
Beta Combo moduláris szerszámdobozok és kiegészítők	356÷358
Beta Csiszolóanyagok	579÷584
Beta Kollekción	715÷726
Beta Vegyiárúk	572÷578
BetaEVOX csavarhúzó	143÷145
BetaGrip csavarhúzó	150÷153
BetamaX csavarhúzó	155÷157
Biztonsági szelepszáró kulcs, szikramentes	302
Blisteres termékek	595÷609
BM termékek	588÷594
Bőrlyukasztó fogó	232
"Caddy" szállító kocsi	360
Cink spray	578
Csákány, szikramentes	305
Csapáglehúzó hidraulikus rásegítéssel	203
Csapos köszőrűkorongok	581÷582
Csapózsínór	213
Csapszegvágók	132; 303
Csavaranyavágó	213
Csavarhúzóbetétek és betéttartók	79÷83; 153; 280
Csavarhúzóbetétek, 4mm	148
Csavartartó csavarhúzó	147
Cserélhető csavarhúzószár	153÷154
Csigafúró, hengerelt	36÷40
Csillag-villáskulcsok	11÷13; 25÷27; 285; 287; 293; 298
Csipeszek	124÷125; 282
Csiszolókorongok	580÷581
Csőfogók	33÷34; 287; 294; 300
Csőhajlítók	35
Csőhegesztő	28
Csőperemezők	32
Csősorjázók	31
Csővágók	29÷30
Dekorkések	233÷236; 290
Derékszög	207÷208
Digitális nyomatékszögmérők	61
Digitális olajátfolyószámláló	249
Digitális-fordulatszám mérő műszer	230
Dőlésszögmérő	208



Drótkötélvágó	133
Drótsodró fogók	231
Dugókulcs-csavarhúzó	114; 281
Dugókulcsok	62; 66÷68
Dugókulcsok, tartozékok és készletek 1"	110
Dugókulcsok, tartozékok és készletek 1/2"	99÷108; 281; 301
Dugókulcsok, tartozékok és készletek 1/4"	86÷93
Dugókulcsok, tartozékok és készletek 3/4"	108÷110; 301
Dugókulcsok, tartozékok és készletek 3/8"	93÷99; 280÷281; 300
Egyenes élű műszerész ollók	135÷136; 282; 288
Egyenes extra hosszú laposfogó	125; 138÷140; 282÷283; 289; 302
Egyoldalas villáskulcsok	13÷15; 63÷64; 275; 279; 286; 298
Ékszíjtárcsalehúzó	194÷203; 232; 272; 276
Elektromos gépek	315÷318
Elektromos platós kézikocsi	388
Elektronikai laposfogó	140÷141
Elektronikai oldalcsipőfogók	141÷142
Elektronikus nyomatémérőkészülék digitális kijelzővel, Dynatester	69
Elektronikus videószkóp	121
Emelőhevederek és kötelek	706÷709
Emelőkengyelek	679÷681
Emelőpárna	237
Erősített laposvágók	10; 124; 212; 285; 293; 297; 305
Erősített tizenkétszögű csőkulcsok	112÷113
EVOX-E elektromos csavarhúzó	146
Fafűrész	219
Fejsze, szikramentes	305
Festékszórók	339
Festhető fehér akril tömítőanyag	575
Feszítőcsavarok	671÷676
Feszítővasak	121÷122; 213; 302
Feszültségvizsgáló műszer	185
Figyelmeztető és tiltó jelzések	667
Flakontartó	370
Flexibilis csavarkiszedők	214
Flexibilis mágneses csavarkiszedő	213
Folyadékelszívó	248
Folyékony tömítés	574
Forrasztópáka	245÷246
Fűrész és fűrészlapok	219
Gépi dugókulcsok, tartozékok és készletek	69÷78
Gyorsindítók és akkumulátortöltők	186÷188
Hajlított csillagkulcsok	15÷17; 25÷28; 64÷65; 171; 177; 181; 279; 286; 298÷299
Hajlított imbuszkulcsok és imbuszkulcsok Torx®-csavarokhoz	18÷21; 293; 299÷300
Hajlított imbuszkulcsok XZN® csavarokhoz	23
Háromkörmös csapágylehúzó	196÷197; 203
Hegesztőmaszk	246
Hézagmérő	213; 290
Hidraulikus prés	203
Hidraulikus pumpa	161
Hőformált tálcák	544÷569
Hőkamera	231
Hőlégfúvópisztoly	318
Hosszú ráverőkalapácsok	166; 304
Húzható szerszámláda	353
Impregnáló spray	578
Ipari szerszámszekrények	376
Jégoldó spray	578



Jelölő körzők	208
Kábelcsupaszoló	136
Kábelkötegelő fogó	594
Kábelkötegelő szalag, nylon	590÷593
Kábelvágók	136; 282; 288
Kalapácsok	160; 164÷166; 289; 295; 303÷304
Kalibráló szerszám többretegű csövekhez	31
Karos zsírzókészülék	223
Karoszírók	222; 290
Kerékagy és kerékdob lehúzó	197÷198
Kerekes szerszámtáskák	347÷348; 351; 353; 385÷386
Kerekes ülőke	254÷255
Kerékpáremelő	274÷275
Kerékpárszerelő szerszámok	273÷277
Keresztvágók	10
Kések	235÷236; 284; 291; 305
Kétkörmös csapáglehúzó	194÷195; 197; 203
Kéttappancsos vákuumos üvegfogó	232
Kettős állítású önzáró fogó	129÷131; 185; 288
Kettős csuklós dugókulcsok	15
Kétutas digitális hőmérők	230÷231
Kezelőszekrény speciális kulcsok	204
Kézi csőrők és tartozékok	694; 698
Kézi emelők és emelőláncok	692÷693
Kézi menetfúrók és készletek	44÷47
Kinyomópisztoly	222; 336
Kiütő	10; 297
Kiütők	9
Kombinált fogók	137÷138; 282; 289
Körmöskulcsok	23÷24; 64; 300
Környezeti mérőműszerek	231
Koronafúró	51÷52
Kötélszívek	679÷701
Kúpos lemezfúrók	41
Lamellás csiszolótárcsák	582÷584
Lamellás/nem-szött csiszoló kerekek	584
Laposvágó karosszériaműhelyeknek	159
Laposvésők	40; 212
LED lámpák	240÷241
LED lámpák	238÷242
Leesésvédett szerszámok	285÷291
Lézeres távolságmérők	210
Lyukasztófogó	130
Mágneses tartó levegős géphez	326
Mágnesező/mágnesmentesítő	142
Menetfúrók és menetmetszők	47
Menetjavító készlet	46÷47
Menetmetszők és készletek	46÷51
Menetrögzítő	573
Menetsablon	213
Menettömítő	573
Mérőórák	205÷207
Mérőszalagok és colstokok	210; 290
Mikrométer	206
Mobil munkapad	375
Morse-kúpos kiütők	43
Motorkerékpár-szerelő szerszámok	267÷272
Műanyag kalapácsok cserélhető végekkel	167; 289÷290; 304



Műanyag terelőoszlop és zárólánc	667
Műanyagjavító készlet	163
Műanyagtálca kis tárgyak elhelyezésére, mágneses	233
Műhelyberendezések	416÷491
Műhelyszekrények	438÷440; 461÷462; 485÷486
Multiméter lakatfogó	229
Multiméterek	228÷229; 290
Munkapadok	392÷414; 421÷423
Munkaruházat	650÷669
Munkaszőnyeg	269; 725÷726
Munkavédelmi cipők	624÷649
Műszerész csavarhúzó	146; 148÷149
Nyitható racsnis hollander kulcs	17; 25÷28; 287; 299
Nyitott hollander-kulcs	17
Nyomatékcsvavarhúzó	60; 122
Nyomatékkulcsok	57÷69; 287;
Nyomatéksokszorozók	54÷56
Olajbefecskendező	224
Olajozó kannák	223÷224
Olajozó pisztoly	249
Oldalcsipőfogók	131; 282; 288; 294
Ollók	135÷136; 236÷237; 305
Ónszippantó	246
Önzáró csipesz	214÷215; 234
Összecsukható szerszámkocsi	389; 358
Övtáska övvel	346
Papirtekercstartó	370
Párhuzamsatuk	204
Párhuzamszorító	203÷204
Penészálló ecetes tömítőanyag	575÷576
Peremezőfogó	130
Pillanatragasztó	576
Platnis kézi csőhegesztő műanyag csövekhez	28
Pneumatikus szerszámok és tartozékok	320÷342
Poliuretán tömítő hab	575
Ponthegeztés lefűró	41
Pontozók	9
Popszegecshúzó és szegecsek	221÷222; 232; 335
Próbalámpák	148
Pumpa	248
Rabitz-fogók	132
Racsnis csővágóolló PVC-csövekhez	30÷31
Rádiusz-sablon	213
Ragasztók	575
Ragasztópisztoly	318
Rajztű	209
Ráverő kalapácsok, fanyéllal	166; 304
Reszelők	159; 215÷219
Reszelőtisztító kefe	220
Robur-rögzítéstechnikai szerelvények	670÷714
Rögzítő emelőhevederek	685÷689
Rögzítőanyag	574
Rögzítőhevederek	710÷712
Rozsdamentes acél szerelvények	699÷705
Rozsdamentes szerszámok	292÷296
Rugóbeakasztó	219
Sarokcsavarhúzó	147
Saruzó fogó szigetelt kábelsarukhoz	290; 305; 585÷587

Seeger-fogók	127÷128; 170; 288; 302
Sörtésecset	220
Spaklik	220; 295; 305
Száraz és nedves porszívók	318÷319
Szemescsavarok	681÷684
Szerszámkészletek	492÷543
Szerszámkészletek hőformált tálcákban	544÷569
Szerszámkocsi takarók	383
Szerszámkocsik	372÷374; 387÷391
Szerszámkocsik	296; 362÷372; 378÷382; 427÷428; 450÷452; 475÷476;
Szerszámkocsik	359÷360; 382
Szerszámos hátizsák	350÷351
Szerszámszekrények	393
Szerszámszekrény-tartozékok, fiókok és falak	569÷571
Szerszámtartó falak	396
Szerszámtáskák	346; 350÷353
Szerszámtáskák	295; 352÷355
Szerszámtáskák	344÷348
Szigetelő aláfekvő	284
Szigetelő borítások	594
Szigetelő szalag	587
Szigetelőszalag	594
Szigetelt csatlakozók	589
Szikramentes szerszámok	297÷305
Szilikon spray	577
Szöghajtómű	85
Szögmérők	208
Szorítókegyelek	677÷678
Tépőzáras kábelkötegelő szalagok	593
Térdeplő	256
Tisztító spray	577
Tisztítószerek	577÷578
Tizenkétszögű pipakulcsok	112÷113; 287; 302
Többcélú kenőanyag	576
Tolómérők	205÷206
Tömítéskivágók	133÷134
Törtcsavarkiszedők	169
T-szárú dugókulcsok és dugókulcsok Torx®-csavarokhoz	114÷115
T-szárú imbuszkulcsok és imbuszkulcsok Torx®-csavarokhoz	115÷116; 281; 302
T-szárú imbuszkulcsok és imbuszkulcsok Torx®-csavarokhoz	21÷22; 286; 294
Ultrahangos mosóberendezések	252÷253
Univerzális párhuzamszorítók	203
Univerzális párhuzamszorítók	590
Üthető acélfejű csavarhúzó	147
Útvecsavarhúzó	156÷157
Védőkesztyűk	284
Védőszemüvegek	668
Villamossági termékek	588÷594
Villás dugókulcs, 3/8"-os	96
Villáskulcsok	14÷15; 298÷299
Vízmérték csapok beállításához	28÷35
Vízmértékek és szintezőlécek	211÷212
Vízpumpafogók	128÷131; 282; 288; 303
Vizsgálótűk	214
Vonalzók	209
Zseblámpák	238
Zsírzspray	576÷577

Automotive

	
Ablaktömítés kisedő	232
Abronsperem illesztő	338
Akkumulátor töltő készülék	188÷193
Akkumulátorsav feltöltő kanna	225
Akkusaru és pólus tisztítókefe	220
Aláfekvő ágy	257
Aláfekvő ágy	256÷257
Alkatrészmosó berendezés	253÷254
Állítható kipufogócsővágó fogó	176
Állítható kulcs az üzemanyagtartály szereléséhez	179
Áttételes kárpitpatent kisedő fogó	177
Autó külső/belső tisztítóeszközök	247, 254, 339
Autókárpitos fogó	232
Automata sebességváltó karbantartó berendezés	250÷251
Autóvédők	255
Benzincső lehúzó fogó	179
Biztosítógyűrű fogó	170
Célszerszám a rugóösszehúzó kar leszereléséhez	202
Digitális gumiprofil-mélységmérő	213
Digitális hordozható feszültségvizsgáló műszer	193
Digitális nyomás és kompresszió mérő	171
Dízel porlasztócsúcs kisedő szerszámkészlet Common-Rail rendszerhez	119
Dízel porlasztócsúcs vizsgáló készülék	121
Dízel porlasztócsúcskisedő dugókulcs	119
Dízelolaj leeresztő dugókulcs-betét	182
Dobfékrugó fogó	173÷174
Dugattyúgyűrű szorító szalag	170
Dugókulcs lambdaszondához	119
Fagyállóvizsgáló üvegtest	226
Fáradtolaj gyűjtő	247÷248
Fékdugattyú szerelő készlet	174
Fékfolyadékleszívó	173
Féltengelycsukló lehúzó	202
Feszültség stabilizátor	194
Feszültségvizsgáló műszer	185
Fogó a kerékanya műanyag kupakhoz	123
Folyadékgyűjtő tartály	248
Gázolajszűrő feltöltő szerszám	178
Gépi kerékanyadugókulcs Isuzu	76
Gömbfejlehúzó	201
Gumiabroncs szerelővas	121÷122, 276



Gumiabroncs tároló zsákok	123
Gumigyűrű kiszedő szerszám	168
Gurulós kerékemelő	258
Gyertyakiszedő fogó	176
Gyorsindítók és akkumulátortöltők	186÷188
Hajtómű/sebességváltó szerelő kocsi	391
Hidraulikus daru	260
Hidraulikus emelő	258
Hidraulikus emelő kerékkel	263÷264
Hidraulikus hajtómű emelő	260
Hidraulikus prések	261÷263
Hidropneumatikus emelő	265÷266
Horpadáskihúzó	160÷161
Hűtőrendszer tömítettségét ellenőrző műszer	227
Injektor fészekmaró készlet	120
Jelkereső	230
Kanálvas	159
Karosszéria kalapács	160
Karosszéria reszelő	159
Kerékgagszerelő dugókulcs	122
Kerékanya-dugókulcs	71÷73
Kerekes karosszéria spotter	162
Keréksúlyszerelő fogó	124
Kerékszelepszereelő szerszámok	122÷123
Kerékszerelő vezetőcsap	123
Keresztkulcs kerékanyához	123
Kézi raklapemelő	266
Kivágók tolatóradar érzékelőkhöz	163
Kompressziómérő közvetlen benzin befecskendezős motorokhoz	121
Konvex egyengető idom	158÷159
Kulcsok az üzemanyagcsatlakozókhoz	171
Kulcsok hőmérséklet-érzékelőkhöz	119
Kuplungtárcsa központosító	169
Kúpos csapágy és olajvédő ütve beillesztő	202
Láncszem- és szegecseltávolító, összeszerelő készülék	271
Légkondicionáló feltöltő berendezés	251
Lengőkar gömbfej lehúzó kulcs	202
Levegős rugóösszehúzó	199÷200
Mobil munkaállomás diagnosztikai eszközökhöz	387
Modellezhető lemez alumíniumból	226
Motoralkatrész tisztítók	254
Motorkerékpár tartó állvány	268
Motortartó kengyel	259
Műanyag tölcser	224÷225, 305
Olajleeresztő kulcs	183÷184



Olajszűrőleszedő dugókulcs	180÷183
Pneumatikus horpadás kihúzó	161
Pneumatikus szelepcsizoló	170
Racsnis heveder	232
Relé fogók	184÷185
Rövid csuklós T-gyertyakulcs	118
Savsűrűségmérő	226
Spakli acélbóll	159
Speciális célszerszám DSG váltóhoz	169
Szeleprugó feszítő fogó	170
Szeleptömítés kiszedő	170
Szerelőbak	258÷259
Szerszámkészlet a törött és sérült gyújtógyertyákhoz	120
Szerszámkészlet az elektromos dugasz szerelésére	185
Szilentblokk lehúzó szerszám	202
Sztetoszkóp	194
Teherautókerék emelő	258
Teleszkópos támasztórúd	233
Tolómérő féktárcsához	205
Tömítésleszedő szerszám	198
Tömlőbilincsfogó	175
Tömlőfúvató	338
Tömlőzáró fogó	179
Torziós rúd kerékanyához	77





TARTALOMJEGYZÉK CIKKSZÁM SZERINT

1		1010BM	126	1067	131	1120ARL - ARG	134	1150K	602
		1010MQ	282	1068	161	1122	134	1150MQ	282
100	24	1031/S4	127	1077	131	1122 - 1125MOL	134	1153	138
100/KIT	24	1032	127	1078	131	1122K	601	1153INOX	295
110BA	300	1032BA	302	1080D	131	1122L	134	1162	138
110MQ	279	1032HS	288	1081	131	1123	134	1162BA	303
111CM	25	1032K	600	1082	131	1123K	601	1162BM	139
111E	24	1033	127	1082BA	303	1124	134	1162BMK	603
111E/D3	24	1033K	600	1082BM	131	1124K	601	1162G	139
111E-HS	286	1034	127	1082BM-HS	288	1125	134	1162GBM	139
111EN	24	1034HS	288	1082BMK	601	1126	134	1162GBMK	603
111ER	24	1034K	600	1082G	131	1127	135	1162GK	602
111INOX	294	1034L	127	1082GBM	131	1128BAX	135	1162K	602
120	25	1036	127	1082GBMK	601	1128BAX-HS	288	1162MQ	282
120/B6N	25	1036BA	302	1082GK	601	1128BM	136	1164	139
123/K4	25	1036HS	288	1082INOX	294	1128BMX	135	1164BM	139
123E1/4	25	1036K	600	1082K	601	1128BMX/F	135	1164BMK	603
123Q1/2	25	1037	127	1082MQ	282	1128BSX	135	1164K	603
123Q1/4	25	1037K	600	1084	131	1128FX	135	1164MQ	282
123Q3/8	25	1038	127	1084BM	132	1128FXS	136	1166	139
141	25	1038HS	288	1084BMK	601	1128MQ	282	1166BA	303
141/B	25	1038K	600	1084G	131	1130BMX	136	1166BM	139
141/S	25	1039	128	1084GBM	132	1131CK	136	1166BM-HS	289
142	26	1044N	128	1084GBMK	601	1132	136	1166BMK	603
142/B	26	1044NK	600	1084GK	601	1132BM	136	1166G	139
142/S	26	1046BA	303	1084K	601	1132BM-HS	288	1166GBM	139
142/SC9I-E	12	1047	128	1084MQ	282	1132BMK	602	1166GBMK	603
142AS	26	1048BM	128	1088	132	1132K	602	1166GK	603
142AS/S	26	1048BM-HS	288	1088BM	132	1132MQ	282	1166K	603
142C	27	1048INOX	294	1088BM-HS	288	1133	136	1166MQ	282
142C/A	27	1048MQ	282	1088BMK	601	1133RL	136	1168	139
142HS	287	1048N	128	1088K	601	1135	136	1168BM	140
142K	597	1048N/D3	128	1088MQ	282	1137BA	303	1168BM-HS	289
142MC	26	1048NK	600	1092V	132	1137BA/RC	303	1168BMK	603
142MC/SC9I-E	26	1048VN	128	1094V	132	1142BM	136	1168G	139
142SN	27	1048VNK	600	1095N	132	1142BMK	602	1168GBM	140
142SN/S	27	1050	129	1096	132	1142MQ	282	1168GBMK	603
142SN/SC9	27	1051	129	1096K	601	1143	136	1168GK	603
186	27	1051GM	129	1098	132	1143R	136	1168K	603
187	27	1051L	129	1098K	601	1144D	136	1168MQ	283
187/B5	27	1051XL	129	1098PL	132	1144D/RG	136	1169/D3	140
192	27	1052	129	1098PLK	601	1144D/RL	136	1169BM/D3	140
192/S2	27	1052BA	303	1100BA	303	1144G	137	1169G/D3	140
194	27	1052HS	288	1101	132	1144G/RL	137	1169GBM/D3	140
195	28	1052K	601	1101R	132	1144L	137	1169MQ/D2	283
195/B5	28	1053	129	1102	133	1144T	137	1169N/D4	140
195AS	28	1054	129	1103	133	1148A	137	1171BM	140
195AS/B	28	1055	129	1103R	133	1148A/R	137	1172BM	140
195FTX/B4	28	1055D	129	1104	133	1148B	137	1172BM/P	141
195K	597	1056	129	1104R	133	1148B/R	137	1173BM	141
195P	28	1057A	129	1105	133	1148P	137	1175BM	141
195P/B5	28	1058	130	1105/C10T	133	1149F	137	1177BM	141
1002	125	1059	130	1105/C16T	133	1150	137	1177BM/Z	141
1008	126	1060	130	1105/C32T	134	1150BA	303	1178BM	141
1008BM	126	1061	130	1105AD-50	133	1150BM	138	1178BM/P	141
1009	126	1062	130	1105T20	133	1150BM-HS	289	1182BM	141
1009L/A	126	1062AL	130	1105T30	133	1150BMK	602	1183BM	142
1009L/B	126	1062GM	130	1105T50	133	1150G	137	1184BM	142
1009L/C	126	1063	130	1112	134	1150GBM	138	1185BM	142
1009L/D	126	1064	130	1112K	601	1150GBMK	602	1186BM	142
1009L/DP	126	1065F	130	1114	134	1150GK	602	1188BM	142
1009L/DP-S2	126	1065P	130	1118	134	1150HPC	138	1190BM	142
1010	126	1066	131	1120A	134	1150INOX	295	1191BM	142



TARTALOMJEGYZÉK CIKKSZÁM SZERINT

1191BM/L	142	1256PZ	148	1272BA	303	1294K	605	1366B	161
1191R/5-M	142	1256RTX	148	1272MQ	283	1294L	156	1366KF	161
1200MS	142	1256TX	148	1272MQ/S	283	1295	156	1366S/R1	162
1201E	143	1257BE	149	1272MQF	283	1295/C14	157	1366S/R10	162
1201E/DZ	143	1257ES	149	1273BG-MQ/DV4	614	1297TX	157	1366S/R11	162
1201E/K	603	1257ESB/S8	149	1273MQ/D6	283	1297TX/D6	157	1366S/R12	162
1201E/S6	143	1257LP	149	1273MQ/E1	614	1297TX/L	157	1366S/R13	163
1201EN	143	1257LP/S	149	1273MQ/E4	614	1297TX/L-S5	157	1366S/R14	163
1201EN/K	603	1257LPH/S8	149	1273MQF/D...	283	1297TX/S12	157	1366S/R2	162
1202E	144	1257PH	149	1273MQF/D4	283	1298RTX	157	1366S/R21	163
1202E/K	603	1257TX	149	1274MQ	283	1298RTX/S8	157	1366S/R22	163
1202E/S4	144	1257TX/S	149	1274MQ/S	283	1298RTXK	605	1366S/R24	163
1202EL	144	1260	150	1274MQF	283	1299HS	289	1366S/R25	163
1202EN	144	1260/S6	150	1275MQ/C	283	1299N/PZ	157	1366S/R26	163
1202EN/K	603	1260E	151	1276MQ/C	284	1299N/PZK	605	1366S/R3	162
1203/E4P	612	1260EK	604	1277BA	303	1299PZ	157	1366S/R4	162
1203E/D	144	1260K	604	1279MQ	284	1299PZ/S6	157	1366S/R5	162
1203E/E10P	612	1260MC	151	1279MQ/F	284	1299PZK	605	1366S/R6	162
1203E/E1P	612	1260N	150	1279MQ/S	284	1302	158	1366S/R7	162
1203E/E5P	612	1260NK	604	1281BG	153	1303	158	1366S/R8	162
1203E/S	144	1262	151	1281BG/A9	154	1304	158	1366S/R9	162
1204E	144	1262/S4	151	1281BG/B28NA	154	1305	158	1366SH	162
1204E/K	603	1262E	151	1281BG-TX/A8	154	1305Z	158	1366SH/C	162
1204E/S5	144	1262EK	604	1281LP	153	1306	158	1366SL	162
1204EL	145	1262K	604	1281LPH	154	1307	158	1367/K10	163
1205E/ES	145	1262L	151	1281PB	153	1308	158	1367/K4	163
1205E/ES-S8	145	1262MC	151	1281PE	154	1310	158	1368	163
1206E/BP	145	1262N	151	1281PH	154	1312	158	1368G/C2U	163
1206E/BP-S7	145	1262NK	604	1281PM	153	1314	159	1368G/CV	163
1207E TX/K	604	1263/D...	151	1281PZ	154	1326	159	1368G/K400	163
1207E/TX	145	1263/E39	613	1281RTX	154	1327	159	1368G/OD	163
1207E/TX-D	145	1263/E40	613	1281TX	154	1328	159	1368G/SD	163
1208E RTX/K	604	1263/E50	613	1290	155	1329	159	1369/C11	164
1208E/RTX	145	1263/E62	613	1290/S	155	1330	159	1370	164
1208E/RTX-D	145	1263/E70	613	1290HS	289	1331	159	1370/MR...	164
1209E PZ/K	604	1263/E74	612	1290INOX	295	1335BM	159	1370BA	303
1209E/PZ	145	1263/E78	612	1290K	605	1337/S5	159	1370BA/MR	304
1209E/PZ-S4	145	1263/E85	613	1290K/INOX	605	1338	159	1370BA/PL	304
1209EN/PZ	145	1263/S12	152	1290N	155	1338A - 1338B	159	1370F	164
1209EN-PZ/K	604	1263MC/D8	152	1290NK	605	1338R9 - 1338R12	159	1370F/MR...	165
1210E/GE	146	1264	152	1292	155	1342	159	1370FT	165
1211E/GE	146	1264/S5	152	1292/S4	155	1342PM	159	1370FT-HS	289
1229LP/A6	146	1264K	604	1292HS	289	1342PMR	159	1370INOX	295
1229LPH/A6	146	1264L	152	1292INOX	295	1343	159	1370T	164
1236B	147	1265ES	152	1292K	605	1344A/VW	160	1370T-HS	289
1238B	147	1265ES/S8	152	1292K/INOX	605	1345	160	1374F	165
1241	147	1266BP	152	1292L	155	1351	160	1374F/MR...	165
1242	147	1266BP/S8	152	1292N	155	1353	160	1375	165
1243/D7	147	1267MCTX	153	1292NK	605	1357Z/45	160	1375/MR	165
1243/S11	147	1267MCTX-D7	153	1293/D...	156	1359T	160	1375A	165
1243LP/D6	147	1267TX	152	1293/S...	156	1360/K6	160	1375B	165
1250	147	1267TX/D7	153	1293BP	156	1360/KP3	160	1375BA/PL	304
1251	147	1267TX/S13	153	1293BP/S7	156	1361/C12	160	1376X	165
1252/S5	147	1267TXK	604	1293BX/DA	614	1361/K9	160	1376X/MR	165
1253	148	1268RTX	153	1293BX/DD	614	1364SCP	161	1376XT	165
1253A	148	1268RTX/S8	153	1293BX/DE	614	1364SE	160	1376XT/MR	165
1254	148	1268RTXK	605	1293BX/DF	614	1364SP	161	1377	165
1256/20	148	1269N/PZ	153	1293ES	156	1364SR	161	1377/MR...	165
1256/30	148	1269N/PZK	605	1293ES/S7	156	1364SV	160	1377BA	304
1256/C36-2	148	1269PZ	153	1293INOX/D8	295	1365/K13	161	1377BA/PL	304
1256LP	148	1269PZ/S4	153	1294	156	1365P10	161	1377INOX	295
1256PE	148	1269PZK	605	1294/S7	156	1366/K5	161	1377T	166
1256PH	148	1270BA	303	1294HS	289	1366A	161	1378	166



TARTALOMJEGYZÉK CIKKSZÁM SZERINT

1378/MR...	166	1457/B4	170	1476A/RC	176	1493/C7	182	1498/SC441	191
1379BA	304	1458	170	1476C/1	176	1493/PF	182	1498/SC540	191
1379F	166	1460F	170	1476GT	176	1493/S-U	183	1498/SC640	192
1379F/MR...	166	1462/EI	171	1476PSA	176	1493AL	182	1498/SP150	190
1380	166	1462/KEP	171	1477/C10	177	1493AL 4S	182	1498/SP250	191
1380/MR...	166	1462/KI	171	1477/C38	177	1493AL CF	182	1498BC/12	186
1380BA	304	1462/MB	171	1477D/S5	177	1493B	181	1498EL/12	187
1380BA/MR	304	1462CF	171	1478	177	1493DSG	182	1498EL/12-24	187
1380BA/PL	304	1462CF/C6	171	1478/K3	177	1493FF/2	182	1498EL/12-R01	188
1380S	166	1464APB	172	1478NSS	177	1493H	183	1498H/16A	189
1380S/MR...	166	1464APD	172	1478SP	177	1493J	182	1498H/25A	189
1380T	166	1464BP	172	1478T	177	1493X	183	1498H/4A	189
1381	166	1464CBD	171	1479	177	1493Y	183	1498H/8A	189
1381/MR...	166	1464FAP	172	1479/B27	177	1494	183	1498LT/12	187
1381BA	304	1464PO	172	1479L/K4	178	1494/C14A	184	1498LT/12-24	187
1381BA/MR	304	1464PT	172	1479L/S2	178	1494BMW	183	1498LT/12-R7	187
1381BA/PL	304	1464T/N	171	1479LB/C5	177	1494E	183	1498LT/12-SF	187
1381T	166	1464T/SP80	171	1479LV/S3	178	1494FPC	183	1498MN/12-C	186
1385	167	1464VD	172	1479N/S5	178	1494M	184	1498MN/12-P	187
1385/MR	167	1465	173	1479RB/1	178	1494MAN	183	1498MN/12-R	186
1390	167	1466/C5	173	1479RB/2	178	1494MRC	183	1498PC	194
1390/MR...	167	1467	173	1479RB/3	178	1494Q	184	1498PRO/12	188
1390BA	304	1467/RK1	173	1479U/13	178	1494T	184	1498PRO/12-24	188
1390BA/R	304	1467LF/2	173	1479U/32	178	1494T/C5	183	1498PRO/12-24 R01	188
1390HS	289	1467LF/RC	173	1480	178	1494VW	183	1498PRO/12-R01	188
1390N	167	1467T/C6	173	1481/C12	179	1494VW/K	184	1498SA/2A-4A	188
1390NR	167	1467TU	173	1481K/S4	179	1494VW/KT	184	1498SM	193
1390R	167	1470	173	1481PL/A	179	1494XZN	184	1498ST/TB ROT	193
1391	167	1470FT	174	1481PL/S3	179	1495/C6	184	1498TB/12-24N	193
1391A	167	1471	174	1481T/C12	179	1495M	184	1498TB/6-12	193
1392	167	1471C	174	1482	179	1495T	184	1499	194
1392HS	290	1471CF	174	1482/8 - 1482/10	179	1496/C	184	1500/...	194
1392R	167	1471CM	174	1482A/1B	179	1497/C23	185	1500/SP	194
1393	167	1471CM/E11	174	1482A/3	179	1497/C94	185	1500G/...	194
1410/M	168	1471D2	174	1482B	179	1497BS	185	1500N/...	194
1428	168	1471GF	174	1482C	180	1497D	184	1500N/G...	194
1428/SB11	168	1471M/50	174	1482SN	179	1497P	185	1500N/SP	194
1428/SB5	168	1471M/C22	174	1483KV-PT/S7	180	1497RC	185	1501/1 - 2 - 3	194
1428L/B3	168	1471PT/C5	174	1484	180	1497SS	185	1501G/1 - 2 - 3	195
1429	168	1471T/C5	174	1485/KIT	180	1497TE	185	1501Z/S - P - R	195
1429/SB7	168	1472	175	1485BP	180	1498	185	1502/...	195
1430/...	168	1472AU	175	1485FCA/K2	180	1498/12-24 R20	188	1505V	195
1430/S	168	1472AU/P	175	1485R	180	1498/2A	188	1506	195
1431/...	169	1472AU/RP	175	1485R/P10	180	1498/2A-8A-PR	188	1508/1 - 1508/2	195
1431/C5	169	1472B/RNLT	175	1485R/P17	180	1498/4A-8A CO	188	1511/1 - 2 - 3	195
1433	169	1472FC	175	1485TC	180	1498/4A-8A CP	188	1515/1 - 2 - 3	195
1433/C11	169	1472FC/GE	175	1488 - 1488L	180	1498/AM30	190	1516/1 - 2 - 3	196
1435	169	1472FC/L	175	1488/1	180	1498/AT1001	192	1517	196
1435/1	169	1472FCL/RP	175	1488R...	180	1498/AT1300	192	1517C/...	196
1435/1R	169	1472PU	175	1489/33	181	1498/AT2000	193	1518/...	196
1435R	169	1472PU/P	175	1489/Y	181	1498/AT300	192	1518U/...	197
1438	169	1472R/AU	175	1490	181	1498/AT500	192	1519/...	197
1438DSG	169	1472VW	175	1490/R1 - 1490/R2	181	1498/AT701	192	1520/1 - 1520/2	197
1438EVO	169	1473	176	1490F	181	1498/DG1100E	193	1521/1 - 1521/2	197
1438R	169	1473A	176	1491	181	1498/DG540E	193	1528	197
1439/K7	170	1473FN	176	1491A	181	1498/PR14	189	1529	197
1440/...	170	1473P	176	1491R	181	1498/PR17	190	1529PI	197
1445/1 - 1445/2	170	1474DL	176	1491T	181	1498/PR20	190	1530/C5	197
1452K	170	1474G	176	1492/1 - 1492/2	181	1498/PR25	190	1531/C7	198
1452PN/K	170	1474L	176	1492T	181	1498/PR35B	190	1532	198
1454P	170	1476	176	1493	181	1498/RP380	191	1533/...	198
1455SVP	170	1476/RC	176	1493/C19	182	1498/RP480	191	1533PR/1 - 2 - 3	198
1455SVP/R...	170	1476A	176	1493/C30	182	1498/SC341	191	1534/...	198



TARTALOMJEGYZÉK CIKKSZÁM SZERINT

1535/C...	198	1599T	204	1662SP0	207	1701PMR	212	1719BM/RP	218
1539	198	1600Q 10	204	1662SP2	207	1702N	212	1719BM/RR	218
1540	198	1600Q 8	204	1666	207	1702N/PM	212	1719BMA...B5	217
1542/1 - 1542/2	198	1601/PC	585	1666A	207	1702PMR	212	1719BMA...M	217
1544/...	199	1602	585	1668	207	1703BA/A	305	1719BMA...P	217
1545/C5M	199	1602/C9	585	1668A	207	1703BA/P	305	1719BMA...Q	216
1547/C6	199	1602A	586	1670	207	1703BA/PL	305	1719BMA...R	217
1547KP	199	1602A-HS	290	1670A	207	1704	213	1719BMA...S5	217
1547P	199	1602BA	305	1672	208	1704A	213	1719BMA...T	216
1547PC/2	199	1603	586	1672A	208	1704C	213	1719BMB/P	218
1547PL/2	199	1603A	586	1674A	208	1705	213	1719BMC	218
1550U	199	1603B	586	1674C	208	1705PT	213	1719BMD...B5	217
1550U/CGS-R	200	1603BK	606	1676	208	1706DGT	213	1719BMD...M	217
1550U/M	200	1603K	606	1678/C3	208	1707	213	1719BMD...P	217
1550U/MRC-ABE	200	1606/2	586	1679	208	1707A/1 - 2 - 3	213	1719BMD...Q	216
1550U/MRC-C	200	1606A	586	1679/PR	208	1708/8 - 13 - 20	213	1719BMD...R	217
1550U/S...	200	1606A/C9	586	1680	208	1708HS/20	290	1719BMD...S5	217
1550U/SS187	200	1606T	586	1680A	208	1709/10 - 1709/18	213	1719BMD...T	216
1551/C20	200	1607	586	1680B	208	1710	213	1719BMR	218
1552/C9	200	1608	586	1680C	208	1712E/1 - 2 - 3	213	1719BMR/B3	218
1555/Q	200	1608/C9	587	1682	209	1712TF	213	1719BMX...M	217
1555/QS	200	1608A	587	1682HS	290	1712TFS	214	1719BMX...P	217
1555S/BMW-RNT	200	1609	587	1683	209	1713M	214	1719BMX...Q	216
1556/1A	201	1609A	587	1685/C7	209	1713M/K7	214	1719BMX...R	217
1556/2A	201	1609B	587	1687/S4	209	1714	214	1719BMX...S5	217
1557/S3	201	1609C/C5	587	1687A	209	1715	214	1719BMX...T	216
1558/C13	201	1609M	587	1687AC	209	1715B/R5L	214	1720/...	218
1558/C4	128	1610-B	589	1687D	209	1715FL/A	214	1720/B	218
1558P	201	1614-P	589	1687U	209	1715FL/B	214	1720/S	218
1559	201	1616-SM	589	1688	209	1715I	214	1720D/...	218
1559V/8T	201	1618-SF	589	1688A	209	1715L	214	1720D/B	219
1560/2	201	1620-M	589	1688M	209	1715R/FL	214	1721/B6	219
1560A	201	1622-F	589	1688PC	209	1716A	214	1723	219
1561/...	201	1624-FI	589	1688PC/R	209	1716P	214	1725	219
1562D	201	1628-C	589	1690F	209	1716R	214	1725CR	219
1565/1 - 2 - 3	202	1630-CR	589	1690L	209	1716U	214	1725MQ	284
1566/GO1	202	1632-TS	589	1691BM	210	1717A	215	1726	219
1566/VAG	202	1634-TD	589	1691MG	210	1717B	215	1726BM	219
1566N	202	1635-D	590	1692	210	1717BA	305	1727	219
1566R	202	1635-S	590	1692HS	290	1717BA/1	305	1727BA	305
1567	202	1638M	594	1693	210	1717C	215	1727BM	219
1568	202	1639EAB	594	1693L	210	1717D	215	1727HS	290
1569/F	202	1639ESB	594	1693M	210	1717T	215	1728...	219
1569/SB	202	1639ESC	594	1694/L	210	1717T RS	215	1728BA	305
1569CP	202	1639ETA	594	1694A/L	211	1717T RT	215	1729CG	219
1570/3	203	1639S	587	1694B/L	211	1717V	215	1729DM 450	219
1580/8I	203	1650	205	1695XS	211	1717V R	215	1729J	219
1580GL	203	1650FD	205	1696	211	1718A...M	216	1729MF	219
1585/5I - 6I - 7I	203	1651DGTB	205	1696A	211	1718A...P	216	1729MF/CG	219
1585GI/5 - 6 - 7	203	1651DGTB/IP	205	1696B	211	1718A...Q	215	1729MF/J	219
1589PI/50 - 100 - 150	203	1652	205	1696D	211	1718A...R	216	1729MF/M	220
1589VI	203	1654	205	1696S	211	1718A...S5	216	1730	220
1590	203	1654DGT	206	1696T	211	1718A...T	216	1730INOX	295
1591	203	1656	206	1697	212	1718D...M	216	1736A	220
1593	203	1657DGT/2	206	1699L	212	1718D...P	216	1737	220
1594	203	1658/...	206	1699L/1	212	1718D...Q	215	1737AC	220
1595	204	1658/C4	206	1699Q	212	1718D...R	216	1737B	220
1599B	204	1658DGTB	206	1700N	212	1718D...S5	216	1737BA	305
1599F	204	1658SP/1	206	1700N/PM	212	1718D...T	215	1737NX	220
1599G	204	1659	206	1701BA	305	1719BA12	305	1738	220
1599GI	204	1662/1 - 1662/2	206	1701N	212	1719BA8	305	1739C	220
1599GR	204	1662AN	207	1701N/PM	212	1719BM/RG	218	1740AN	220
1599P	204	1662DGT/A	206	1701NE/...	212	1719BM/RL	218	1740B	220



TARTALOMJEGYZÉK CIKKSZÁM SZERINT

1741	221	1755C	224	1763G/S500	232	1812 150	245	1851VK	318
1741/C5	221	1755P	224	1764/K5	232	1814M	245	1851VK-12C	318
1741P	221	1756	224	1764/K5-R	232	1820	245	1851VK-12V	318
1741RV...K	221	1756B	224	1766	232	1822	245	1852 S-PIATTE	244
1741TR	221	1756D	224	1766/8	232	1823 60	245	1852R1750	244
1741U	221	1756D-20R	225	1766A	232	1823R/60	245	1852S-CC	244
1742AN	222	1756E	224	1766ER	232	1824R	245	1852S-CNT	244
1742AN/C	222	1756G	224	1766ER/VW	232	1825B	245	1852S-F	244
1742AN/KR	222	1756V	224	1766G	233	1827	245	1852S-FLESS	244
1742N	221	1756V-20R	225	1766I	233	1827/K	246	1852S-KR/CNT	244
1742N/C4	222	1757	225	1766T	233	1827F	246	1852S-L	244
1742N/KR	221	1757A	225	1767A	233	1827PC	245	1870	318
1742R-A/M...	222	1758	225	1767B	233	1827PCL	245	1870-20/5S	319
1742R-AL/M...	221	1758ADB-45°	225	1767PMC	233	1827PFL	246	1870-72 /FC	319
1743	593	1758ADB-D	225	1767PMR	233	1830T	246	1870-72/FL	319
1743HS	290	1758B	225	1768	233	1833L	238	1870I	318
1743T	593	1758B/K5	225	1770	233	1833M	238	1872L	319
1748-BA1	592	1758B-1,6	225	1770A	233	1833MW	238	1872L 35/5S	319
1748-BA2	593	1758BA	305	1770RL	233	1833S	238	1872L 35/FC	319
1748-BH	592	1758B-RNT	225	1771	233	1833XL	238	1873	319
1748-BL	591	1758LG	226	1771BM	234	1833XS/1	238	1873-30/5S	319
1748-BP	592	1758M	226	1771HD	234	1833XS/2	238	1874	319
1748-BR	592	1758R	226	1771RL	234	1833XSW	238	1874-50/5S	319
1748-BT	592	1758RD	226	1772H	234	1836AW	238	1874-50/FC	319
1748-BT2	592	1758S	226	1772H-HS	290	1836B	239	1875LT	247
1748-BT3	592	1758VT	226	1772M	234	1837C	241	1875SP/K3	247
1748-BV	593	1758VT/L	226	1772R	234	1837F/USB	239	1877	247
1748-BV0	591	1759	226	1772RL/2	234	1837RB-F/USB	239	1877A	247
1748-BV2	590	1759A	226	1773A	234	1837S	241	1877F	247
1748-BX	591	1759B	226	1773RL	234	1838/11LED	239	1877P	248
1748N	590	1759HD/3	227	1773S	234	1838AM	240	1878 11	248
1748-N	594	1759HD/RR	227	1773S/RL	234	1838COMPACT	240	1878 2	248
1748-N2D	591	1759HD/TRUCK	227	1773U	234	1838E	241	1878 30	248
1748-NA1	592	1759LR	227	1773U/R	234	1838E-BT	241	1878 4	248
1748-NA2	593	1759TT	227	1774	234	1838FLASH	240	1878 8	248
1748-NL	591	1760/IR1000	231	1774A	234	1838PN	240	1879	248
1748-NV	593	1760/IR1600	231	1774A/RL	235	1838POCKET	240	1879 6	248
1748-S	593	1760/IR500	230	1774S	235	1838RA/10-11LED	239	1879/FUEL	248
1748-SC	593	1760/RMS	229	1776BA	305	1838RB/10LED	239	1879R/K4	248
1748-ST	594	1760/RSE	230	1777BM	235	1838RB/FLASH	240	1880	248
1748-UL	591	1760/TC2	230	1777BMT	235	1838RR/11LED	239	1880ADB	249
1748V	590	1760B	228	1777MQ/C	284	1838RV/11LED	239	1881	249
1749	222	1760BHS	290	1777MQ/U	284	1838SLIM	240	1882N	249
1749A	222	1760DGT	228	1777RL/U	284	1838SW	239	1883N	249
1749A/RB	222	1760DGT/2	228	1777T	235	1839/R1	241	1883NC	249
1749A/RT	222	1760DGT-R3	230	1778AN	235	1839/R2	241	1884	249
1749AC	222	1760K	230	1778AX	235	1839/R4	241	1884N/C8	249
1750	222	1760LX	231	1778BS	235	1839/R5	241	1885	250
1750HS	290	1760OHM/2	228	1778CM	235	1839/R6	241	1885/C1-R1	250
1750KG10	223	1760PA/80	229	1778M7	235	1839BRW	241	1885/C1-R2	250
1750M	223	1760PA/AC	229	1778MT	236	1842	243	1885/C1-R6	250
1750M3	223	1760PA/AC-DC	229	1778P	235	1842LED/ABM	242	1885/C1-R8	250
1750PF	223	1760PA/AC-DC2000	229	1778SCL	235	1842LED/BM	242	1885/C2-R1	250
1750R/1 - 1750R/2	223	1760PT/N	230	1778SOS	235	1843	243	1885/C2-R6	250
1750RC	223	1760R/TC2	230	1778SOS-HS	291	1844	243	1885/C2-R7	250
1750RP/1 - 1750RP/2	223	1760S	229	1778V18	236	1844SCK	243	1885/C3-R10	251
1750RT	223	1760TMC	231	1778X	236	1845	243	1885/C3-R3	250
1750TA	223	1760WM	231	1781	236	1846	243	1885/C3-R4	250
1750TLA	223	1761	231	1783	236	1846R-LED/BM	243	1885/C3-R5	250
1751CR	223	1761RS/1	231	1784	237	1847	244	1885/C3-R6	250
1751N	224	1762	232	1784BA	305	1848	244	1885/C3-R7	251
1752	224	1762K	607	1800/100	237	1850D	318	1885/C3-R8	251
1754	224	1763	232	1808	245	1850E	318	1885/C3-R9	251



TARTALOMJEGYZÉK CIKKSZÁM SZERINT

1885/XC60	251	1921N3	323	1938R/L	333	1972/20V-13BMC	309	2001/BZV	344
1889CF	249	1922P1	323	1938R/S5	333	1972/K12V-10	307	2002/BV42	346
1889N	249	1922P2	323	1940	333	1972/K12V-COMBO	307	2002/BV6	9
1893/1234YF	251	1922P3	323	1940/C6	333	1972/K20V-13BMC	309	2002/BV7-ZIP	154
1893/134A	251	1924F	323	1940/S5	333	1982/12V	308	2002/BVL6	25
1893TR/1234YF	251	1924XM	324	1,94E+13	333	1982/K12V	307	2005MPU	346
1893TR/134A	251	1927AN	326	1940E10/MT	334	1984 20V/1200BMC	311	2005MPU/E	346
1893TR/CI	252	1927C	325	1940E10/S...	334	1984 20V/600BMC	310	2005PA/D	346
1895 13	252	1927E	325	1940E10/S5	334	1984/K1200	311	2005PA/E	346
1895 157	253	1927G	326	1940MT	333	1984/K600	310	2005PA/ET	346
1895 27	252	1927OLS	324	1940S...	333	1986/20V-125BMC	312	2005PA/S	346
1895 6	252	1927P	325	1942A	334	1986/K20V-125	312	2005PA/U	347
1895/RC	253	1927P/K3	325	1942LR	334	1989RCB	314	2009N/BV	346
1895/S	252	1927SP-AM	326	1944A	334	1994B 20V-2AH	313	2028/VV	347
1895GSI	252	1927XM	325	1944AR	334	1994B 20V-4AH	313	2028E	347
1898/B	253	1927XM/K5	325	1944N	334	1994B 20V-6AH	313	2029/VV	347
1898/C	253	1928DA	326	1944PA	334	1994BL 12V-2AH	308	2029E	347
1898/D	253	1928DAL	326	1945P	335	1994C 20V	313	2029EM	347
1898/K40	253	1928K4	326	1945P/S...	335	1994CB 12V	308	2032/TE	348
1898/M	254	1928P	327	1945S	334	1995MQ/T	284	2032/TV	347
1898/S	254	1928XM	326	1945S/G...	334	1996MQ/T	284	2033L	348
1899A	254	1930A	327	1946	335	1996VPG	284	2033L/VV	348
1899SI	254	1930HLA	328	1946C/T...	335	1997MQ/GM	284	2036/TV	348
1900M	339	1930LA	327	1946C4,8	335	11001	580	2036E	348
1900S	339	1930LH	327	1946C7,8	335	11011	580	2037/TV	348
1914	340	1930PA	327	1946KF	335	11021	580	2038/TV	348
1915B	340	1930ZL	328	1946KF/M...	336	11023	580	2041UC	349
1915C	340	1931AN10	328	1947	336	11034	580	2051N	349
1915C/L	340	1931CD10	328	1947G	336	11035	580	2055HB	349
1915D	340	1931CD13	328	1947G2	336	11038	580	2080/DL	349
1915E	340	1931CD6	328	1947H	336	11045	581	2080/DS	349
1915E/XL	340	1932B10	329	1948	336	11046	581	2080/V12	350
1916G	340	1932B13	329	1948PR	336	11049	581	2080/V12-...	350
1916GF	340	1932RS13	329	1949BC	337	11101	581	2080/V17	349
1916GFE	340	1933	329	1949BC/RUL	337	11107	581	2080/V6	350
1916I	340	1933AN90	330	1949DGT/2	338	11111	582	2080/V6-U	350
1916JF	340	1933AN90-H	329	1949F2	338	11116	582	2080/VG	254
1916JM	340	1933I	330	1949GPA	338	11131	582	2109MT ID/1	352
1917F	341	1933IH	329	1949M	338	11202A	582	2115P L-MQ32	354
1917JF	341	1933IL	330	1949P	337	11202B	582	2115PI/BIKE-HOME	354
1917JM	341	1933ILH	329	1949R	338	11204A	582	2250-O	254
1917M	341	1933L	330	1949T	337	11204B	582	2251N	254
1917RG	341	1934BV	330	1949U5	337	11210A	583	2252	255
1917SP	341	1934MAV	330	1949U5/A	337	11210B	583	2252KR4	255
1918	341	1934MAV70	330	1949U5/B	337	11214A	583	2254A	255
1918N	341	1935F	331	1949U5/C	337	11216A	583	2254C	255
1918R	341	1936/4A	331	1949U5/D	337	11216B	583	2254F	255
1919F1/2	342	1936/5A	331	1949U5/E	337	11234A	583	2254K	255
1919F1/4	342	1936/7A	331	1949U5/F	337	11246A	584	2254SM	255
1919F3/8	342	1937	331	1949U5/G	337	11248A	584	2254T	256
1919FE1/4	341	1937C...	332	1949XS	336	11259	584	2258N-O	255
1919L	342	1937K...	332	1950BZK	338	11260	584	2258RR	255
1919ML	342	1937KC	331	1950BZK/T	338	11263	584	2300ST/KIT	361
1919RB-F	342	1937KL	332	1950GPP	339	11264	584	2400 RSC24/MP	370
1919RB-FE1/4	341	1937KL-D	332	1951	339	11265	584	2400 RSC24/PC	369
1919RF-F	342	1937M	332	1951A	339	11266	584	2400 RSC24/PD	369
1919RF-FE1/4	341	1937M-01÷11	332	1952	339	11268	584	2400 RSC24/PF	369
1919RM-F	342	1937N10	332	1956 115-750W	315			2400 RSC24/PF-	369
1919RM-FE1/4	342	1937N10-GR	332	1956 125-1400W	316			2400 RSC24/PL	369
1919SC	342	1937N20	332	1956 230-2400W	316	2001/B26	344	2400 RSC24/SPC	370
1921B1	323	1937N20-GR	333	1966/910W	317	2001/BV	344	2400 RSC24AXLP/CPR	368
1921M1	323	1937R/P	331	1967/800W	317	2001/BZ24 MQ	345	2400 RSC24AXLP/PF	367
1921M2	323	1938	333	1972/12V-10	308	2001/BZ27 VU	345	2400 RSC24AXLP/VL	369
								2400 RSC24AXXL/PF	368



TARTALOMJEGYZÉK CIKKSZÁM SZERINT

2400-COVER RSC24	383	340RL	30	386A/RC	35	3026/S	261	3065/40-20T	265
2400-COVER RSC24AXL	383	341	30	386BA	300	3026/SA	261	3067/60-15T	266
2499PC	370	341B	30	387	35	3026/SAM	261	3067/70-13T	266
2499PF	370	341B/RL	31	387R	35	3026/SP	261	3068	266
2499PF/M	370	341B/RM	30	388	35	3027N 10	261	3069	266
3		341RL	30	388A	35	3027N 100	262	3070B	270
		342	31	388C/C8	35	3027N 20	261	3070B/...	270
30	9	342A	31	389/K4	35	3027N 30	261	3071A	270
30BA	297	342A/MOL	31	392C	35	3027N 50	261	3071B	270
31	9	342A/RL	31	392RG/C	35	3027N/KP	262	3071RS	270
31/B6N	9	342MOL	31	393	35	3027N/KPP	262	3072N	270
31/B6N-LSE	9	342P	31	395	35	3027PR/N	262	3073	270
31/SP6	9	342P/RL	31	395T	35	3028 15	262	3074O	271
31BA	297	342RL	31	398	35	3028 20	262	3074O/2	271
31BA/C	297	345	31	399	35	3028 30	262	3074O/M	271
31BM	9	345C	31	399R/...	35	3028 50	263	3074O/S	271
31BM/D6	9	345SB	31	3000L	256	3028/KP	263	3075/CM	271
31L	9	345SB/R	31	3000L/RLS	256	3028SP/15	262	3075/K10	271
31SE	9	345SB2	31	3000M/PLM	375	3028SP/20	262	3075B	271
32	9	345SC	32	3002	256	3028SP/30	263	3075MV	271
32AU	9	345SI	32	3002/RLS	256	3028SP/50	263	3080/C15	271
32AUR	10	345SI/R	32	3003	256	3029/2T	263	3080R/CS3	271
32BA	297	345U	31	3003/RLS	256	3029/2T-L/R5	263	3081	271
33LT	10	345U/A	31	3003C	256	3029/2T-L/R6	263	3085	271
33NR	10	349	32	3003C/RLS	256	3029/2T-L/RP	263	3091	272
34	10	349/SMAS	32	3003PRO	256	3029AL/1,5T-R1	263	3092	272
34BA	297	349/SMM	32	3003PRO/PM	256	3029AL/1,5T-R2	264	3093/E	272
34INOX	293	350	32	3003PRO/RRC	256	3029AL/1,5T-RP	264	3093/U	272
35	10	351C	32	3003PRO/RRG	257	3029AL/1.5T	263	3095	272
35HS	285	351P	32	3003PRO/RT	257	3029L/2T	263	3099E	272
35PM	10	352C/U	32	3003PRO/SP	256	3030/2T	264	3099T	272
35PMR	10	352U	32	3004	257	3030/2T-R5	264	3500/P-M	377
36	10	355	32	3006	257	3030/2T-R6	264	3700/PC	380
37	10	357F3	32	3006 R/RG	257	3030/2TRP	264	3700/PF	380
37PM	10	357R/F3	33	3006 R/RGF	257	3030H/2T	264	3700/PFL	380
37PMR	10	358	33	3007	257	3033/3T	264	3700/PLA	380
38/B6N	10	358RL	33	3007 R/RG	258	3033E/3T	264	3700/PLL	380
38/DS1	611	359	33	3007 R/RGF	258	3033S 3T/R2	264	3910	274
38/DS2	611	359CH	33	3008M	258	3035	265	3912PP	274
38/S	10	360	33	3008N	258	3036	265	3912TP	274
39BA	298	360HS	287	3009	258	3040C	268	3912TP/A	274
39INOX	293	360R/...	33	3009R/GR4	258	3040C/S1	268	3912TP/C	274
310	28	361N	33	3010/T...	258	3040C/S2	268	3912TP/FOX	274
310/C8	28	362	33	3010H	259	3041C	268	3912TP/QRE	274
310B	28	362INOX	294	3010V	259	3041C/12	268	3912TP/ROAD	274
311	28	362R/...	33	3011/T	258	3041C/16	268	3912TP/RS	274
330	29	363	33	3012	259	3042C	268	3912TP/ST	274
330BA	300	363BA	300	3012C	259	3043C	268	3916MMP	275
330BA/2R	300	363R/...	33	3012I	259	3043C/ 41÷47	268	3918MML	275
330R/A	29	365	34	3014	259	3047C	268	3921	275
330R/I	29	365R/...	34	3014 SAR	259	3048C	268	3923	275
331C	29	366	34	3014R/GR5	259	3050/600	269	3927	275
332	29	374	34	3014SAR/1	259	3050/CC	268	3932U	275
334	29	374K	597	3014SAR/RR	259	3050/KA	269	3935	275
334R	29	374R/...	34	3023	259	3050/LA	269	3937	275
334R/I	29	375	34	3024 0,6	260	3050/MS	269	3948	275
336	30	376	34	3025N	260	3050/MV	269	3952	275
338	30	378	34	3025N/PF	260	3054	269	3952/S7	275
338R	30	378BA	300	3026 0,3	260	3055M	269	3953	275
338R/I	30	383	34	3026 0,5	260	3057	269	3955	275
338RP	30	383R	34	3026 1,0	260	3061/2T	265	3961 3,2	276
340	30	384	34	3026/R 1,0	260	3061/2T-P100	265	3961 3,3	276
340C	30	384RC	34	3026/R0,3	260	3061/2T-P50	265	3961 3,5	276
340C/KRL	30	386A	34	3026/R0,5	260	3065/20-10T	265	3961U	276



TARTALOMJEGYZÉK CIKKSZÁM SZERINT

3962MV	276	412/SP91	37	430	44	451PA	53	5902MT/AS	530
3962SH	276	412A	37	430/SP	44	451PR	53	5902VI	494
3963P	276	412K	598	430ASC	45	452	53	5904VG/2M	531
3964	276	412L	38	430ASW	45	452GA	53	5904VG/2T	532
3965	276	412XL	38	431	45	460	53	5904VG/3	533
3965C	276	414	38	431/SP	45	460G	53	5904VG/5T	535
3967	276	414/C116	38	433	45	460PP	53	5904VI/1T	494
3969	276	414/SP	38	433ASF	45	4900-COVER C49	387	5904VI/2T	497
3969K3	276	415	38	433ASG	45	5		5904VI/3T	495
3971	276	415/C116	39	434	45				5904VU/1M
3972	276	415/SP	39	435	46	52	13	5904VU/2M	504
3973/1	276	415/SP91	39	435G	46	52MQ	279	5904VU/2T	505
3973/2	277	415CO	39	436	46	53	14	5904VU/3T	506
3973/3	277	415CO/SP	39	436L	46	55	14	5904VU/4T	507
3973/4	277	415CO-A	39	436R	46	55/B12N	14	5905VG/1	536
3973PF	276	415K	598	437C	46	55/B8N	14	5905VG/2	537
3975	277	415L	39	437C/...	46	55/S	14	5908VG/2T	538
3984/1	277	416	39	437C/RM14	46	55/SP	14	5908VI/2T	496
3984/2	277	416/SP19	39	437K/12	46	55/SP7	14	5908VU/2T	508
3984/3	277	416P/SP19	40	437K/33	47	55AS	14	5910VI/3	498
3984/4	277	417	40	437K/9	46	55AS/S	14	5910VI/3T	499
3984/5	277	417/SP	40	437P	46	55BA	298	5914VU/M	509
3984/6	277	418/K3	40	437U/09	47	55BA-AS	298	5915VU/0	511
3991	277	419	40	437U/E-M...	47	55HS	286	5915VU/1	511
3992	277	419/SP	40	437U/PM	47	55K	596	5915VU/2	512
4		419T	40	438...	47	58	14	5915VU/3	512
		420D/SP8	40	438A	47	58BA	298	5915VU/4	513
		421	41	440	47	58BA-AS	298	5915VU/5	513
42	11	421	41	440A	47	560/C12	55	5915VU/AS	514
42/B9N	11	421/SP6	41	440ASC	48	560/C2	55	5927VU/M	514
42/S	12	422	41	440ASF	48	560/C3	55	5935ET/1MB	522
42/SC9I-E	12	423A-CO	41	440ASG	48	560/C3PLUS	55	5935VG/1MB	539
42/SP	12	423CO	41	440ASW	48	560/C4+	55	5935VI/2MB	500
42/SP15	12	424	41	440B	47	560/C6	55	5940SBK	539
42/SP25	12	424/SP	41	441	48	561/1	55	5941VU/M	540
42AS	12	425	41	441A	48	562-1/VA - 562-2/VA	56	5945VUM	541
42AS/B9N	11	425/SP	41	441B	48	562VV-A	56	5954VG	542
42AS/S	12	426	41	442	49	564-3R/V - 564-4R/V	56	5954VI	502
42BA	298	426/SP	41	443	49	565-1R/VA - 565-2R/VA -	56	5957U-P	515
42BA-AS	298	426A/SP6	42	444	49	565-3R/VA		5957VG	543
42HS	285	426MD/CP	43	444G	49	565-4R/VB	56	5957VI	501
42INOX	293	426MD/CT	43	446/C110	50	565-5R/VB	56	5958U	516
42INOX/S	293	426MD/F	43	446/C30	49	565VV-B	56	5980EL/A	525
42INOX/SC9	293	426MD/FA	43	446/C48	49	567-4R/VB	56	5980EL/B	526
42INOX-AS	293	426MD/OG	43	446ASC/C37	50	567-5R/VB	56	5980ET/A	523
42INOX-AS/S9	293	426MD/OV	43	446ASF/C29	50	581	60	5980ET/B	524
42K	596	426MD/S	43	446ASG/C23	50	583	60	5980ID/1	527
42LMP	13	426MD/SP10	43	446ASW/C36	50	583/C31	60	5980MQ	524
42LMP/S	13	426MD/T	43	447/C37	51	590 - 592	60	5980U/BIKE	517
42MP	13	426MD/TA	43	447/C53	51	594	60	5980U/BIKE-M	518
42MP/B	13	426MD-3	42	447/C70	51	596	60	5988 VHB-MQ	525
42MP/S	13	426MD-3/A9	43	450	51	599DGT	61	5988H/7M	519
42SLIM	13	426SB	42	450/C13	52	599DGT-AW	61	5988L/4M	520
42SLIM/B8NI-E	13	426SB/SP	42	450/C15	52	5000 RSC50 2.0/ASL	488	5988U/7M	510
42SLIM/S11	13	426T	42	450/C21	52	5000 RSC50 2.0/CAL	463	5988U6/M	521
45	13	426T/SP	42	450/C9	52	5000 RSC50 2.0/CLL	463	5989 VEM	528
410	36	427	43	450AD	51	5000 RSC50 2.0/CTR	489	6	
410/SEL	37	428FC	44	450AL	51	5000 RSC50 2.0/KFC	463		
410/SP	36	428FC/C7	44	450PA/1	52	5000 RSC50 2.0/MP	463	600	61
410A	37	428FP	43	450PA/2	52	5000 RSC50 2.0/MPA140	463	601C	61
410K	598	428FP/C7	44	450PR	52	5000 RSC50 2.0/PLEDC	488	601CA	61
410MIX/SEL19	37	429FC	44	451	52	5000 RSC50 2.0/PLED-ST	488	603	62
412	37	429FC/C7	44	451/C	53	5700LAMP	396	604B	62
412/C150	37	429FP	44	451GA	53	5902MT	529	605BC/15	62
412/SP	37	429FP/C7	44						



TARTALOMJEGYZÉK CIKKSZÁM SZERINT

605DGT/2	62	6600 M/253	619	6800RP/100	616	727/C16	75	7109D	667
605E	62	6600 M/27	616	6800RS	669	727/ES16	74	7212B	634
606MQ/50	280	6600 M/29	616	6888	616	727/ES16TX	74	7212G	635
610/5	62	6600 M/315	619	6888GS	669	727/ES16XZN	74	7213G	635
610L/5	62	6600 M/320	619	6888GW	669	727/ES22	75	7214FN	635
610L/5L	62	6600 M/326	619	7		727/ES22TX	75	7214G	636
611	62	6600 M/327	619			727/ES32	75	7215FN	636
612 ÷ 614	63	6600 M/33	616	73	15	727PI/16	74	7218FN	636
614/50	63	6600 M/330	619	73/B13N	15	727PI/16 1/2	74	7218G	636
615	63	6600 M/371	619	73/S	15	727PI/22	75	7220PEK	633
616 - 617 - 619	63	6600 M/380	619	78	15	727PI/32	75	7221PEK	633
621	63	6600 M/40	617	78AS	15	728	75	7222PEK	633
622	63	6600 M/406	619	78BA	298	728/15	76	7223PEK	634
641	63	6600 M/40K	622	78BA-AS	299	728/16	76	7241EN	629
642	63	6600 M/417	619	710	70	728/21	76	7241NC	630
643	64	6600 M/42	617	710/16	70	728/22	76	7241NFT	630
644	64	6600 M/427	619	710/20	70	728/22L	76	7243EN	629
650A	64	6600 M/430	620	710/21	70	728/25	77	7243NC	630
650H	64	6600 M/44	617	710/22	70	728/C10	75	7243NFT	631
652	64	6600 M/440	620	710/25	70	728/OR - 728/SP	77	7245NB	631
653	64	6600 M/456	620	710/C10	70	728AS	76	7246E	629
654	65	6600 M/465	620	710/OR... - 710/SP...	70	728B	75	7246NB	631
659/15	65	6600 M/47	617	720	70	728B/C10	75	7247NB	631
659/16	65	6600 M/480	620	720/15	74	728FTX	76	7248NB	632
666	66	6600 M/485	620	720/16	74	728L	76	7270Y	643
666 LBF.FT	66	6600 M/51	617	720/20	74	728L/S	76	7271V	643
666HS-ZR	287	6600 M/510	620	720/21	74	728LQ	76	7272V	644
667	66	6600 M/52	617	720/22	74	728LS	76	7273G	644
668N	66	6600 M/532	620	720/25	74	728ME	76	7274G	644
668RG	67	6600 M/534	620	720/C12	70	728ME/C6	76	7275N	644
668RGC	67	6600 M/542	620	720/C24	71	729	77	7276N	645
669N	67	6600 M/548	620	720/C6	70	729/15	77	7293HM	647
671B/C10	67	6600 M/555	620	720/OR... - 720/SP...	74	729/16	77	7294HM	647
671B/C5	67	6600 M/561	621	720/SN	73	729/21	77	7294HMC	647
671N/C10	67	6600 M/565	621	720AS	71	729/21L	77	7316NB	637
671N/C20	68	6600 M/566	621	720B	71	729/22	77	7316NG	637
671N/C30	68	6600 M/567	621	720B/C12	71	729/25	77	7317NA	637
674/C	68	6600 M/58	617	720FRD	72	729/OR... - 729/SP...	77	7320NA	638
677	68	6600 M/589	621	720FTX	73	729L	77	7321NA	638
677/C	68	6600 M/59	617	720FTX/SB	73	729LS	77	7322SA	638
677/CP2000	68	6600 M/592	621	720IC	72	729T	77	7323SA	638
677/CV - 678/CV	69	6600 M/61	617	720L	71	730	78	7328A	632
678/C	69	6600 M/63	617	720L/S3	71	730/15	78	7328N	632
680	69	6600 M/643	621	720LC	72	730/21	78	7340G	645
682	69	6600 M/650	621	720LC/C3	72	730/25	78	7340VA	645
6200AP/S10	669	6600 M/657	621	720LC/PM5	72	730L	78	7341V	646
6600 M/112	617	6600 M/658	621	720LC/S3K	598	733/15	78	7341Y	646
6600 M/116	618	6600 M/716	621	720LC/S5	72	7041LCD/4S	246	7342N	646
6600 M/120	618	6600 M/73	617	720LCL	72	7041LCD/4S-VE	246	7343N	646
6600 M/125	618	6600 M/811	622	720LCL/C3	72	7041LCD/4S-VI	246	7352B	639
6600 M/126	618	6600 M/812	622	720LS	72	7042LCD	246	7352G	639
6600 M/131	618	6600 M/813	622	720MC	71	7042LCD/RV	246	7352LG	639
6600 M/14	616	6600 M/842	622	720MC/C13	71	7042LCD/RV-INT	246	7354N	640
6600 M/14K	622	6800 CB/100	616	720ME	73	7043	246	7356G	640
6600 M/174	618	6800 FB/100	616	720ME/C8	73	7061TC	668	7356LN	640
6600 M/217	618	6800 GR/37	616	720MRC	72	7076BC	668	7356V	640
6600 M/217K	622	6800 VE	616	720RNG	72	7076BD	668	7357G	641
6600 M/218	618	6800AD/P	616	720S	71	7076BP	668	7357V	641
6600 M/22	616	6800AE	616	720S/SB6	71	7076BU	668	7362B	641
6600 M/223	618	6800AI	616	720TC/S5	73	7093BC	668	7363N	641
6600 M/230	618	6800BA	669	720TX	73	7093BD	668	7371V	642
6600 M/236	618	6800FO/100	616	720TX/C6	73	7104 90	667	7372B	642
6600 M/241	618	6800PL	616	720XZN	73	7105 6	667	7376A	642
6600 M/242	619	6800PM	616	720XZN/C6	73	7109A	667	7381N	642



TARTALOMJEGYZÉK CIKKSZÁM SZERINT

7382N	643	7669N	662	850MQ	280	867XZN/L	84	8031R	680
7397H	648	7670G	662	851	78	882	85	8031R-K	680
7397M	648	7679GG	662	851SR	78	882AN	85	8032	680
7397S	648	7750N	662	852	79	882M	85	8032-K	680
7398 0/G	648	7780QN	662	855P	79	882M1	85	8040EN	683
7398EF	649	7800G	667	860/55	79	882MSR	85	8040EN-K	683
7398ESD	648	7815CM	657	860/58	79	882P	85	8040EZ	683
7398GEL	648	7818BL	654	860/58K	598	892	85	8040EZ-K	683
7398U	648	7818CM	654	860/C27	79	895	85	8041	682
7398UP	648	7818G	654	860/C38P	80	897	85	8041-K	682
7399 A/N...	649	7818LN	654	860LP	79	897L	85	8042EN	684
7421	649	7819G	654	860PE	79	8001TZ	674	8042EN-K	684
7422P	649	7820SG	655	860PH	79	8001TZ-K	674	8042EZ	684
7425	649	7821SG	657	860PZ	79	8001Z	674	8042EZ-K	684
7426P	649	7830SN	655	860RTX	79	8001Z-K	674	8043	683
7427	649	7831SN	657	860TX	79	8002ZD	675	8043-K	683
7430T	649	7840BL	655	861/C61P	82	8003ZD	675	8044	684
7431P	649	7849BL	659	861LP	80	8004ND	675	8048	676
7527	652	7850G	655	861MIX/A10	81	8005TZ	672	8049	681
7528	652	7860B	655	861MIX/A31	81	8005TZ-K	672	8049A	682
7529	656	7860G	655	861PE	80	8005WZ	672	8049V	682
7530	652	7861B	658	861PE/A10	81	8005Z	672	8050 D1÷D45	696
7545F	664	7861G	657	861PH	80	8005Z-K	672	8050 D46÷D48	696
7548C	664	7863G	658	861PH/C	80	8006Z	672	8050 D49÷D53	696
7548M	664	7865B	658	861PHZ/A10	81	8006Z-K	672	8051S	691
7550G	664	7865G	659	861PZ	80	8007Z	673	8051S-K	691
7550N	664	7867B	660	861PZ/C	80	8007Z-K	673	8052 - 8055S	690
7552BL	665	7867G	661	861RTX	80	8008N	673	8057R	690
7552G	665	7869G	660	861SP	81	8008N-K	673	8058R	690
7552N	665	7900G	656	861TQS	81	8008TZN	673	8058R/PS	696
7553BL	665	7903G	658	861TRW	81	8009FD	676	8060R	690
7553G	665	7905G	659	861TX	80	8009TZ	673	8060R/PS	696
7553N	665	7907G	661	861TX/A10	81	8009TZ-K	673	8061R	690
7553V	665	7909G	660	861TX/C	80	8009Z	673	8062	691
7579QN	660	7930MG	656	862F	83	8009Z-K	673	8063	690
7600G	652	7931MG	658	862F/A7	83	8010TZ	674	8063SL	691
7600N	652	7935MG	659	862LP	82	8010Z	674	8064S	691
7610G	653	7937MG	661	862PE	82	8010Z-K	674	8065SC	691
7610N	653	7940	656	862PH	82	8011TZ	674	8068S	682
7611G	656	7949	660	862PH/L	82	8011Z	674	8074	695
7636N	662	7971B	665	862PH-XL	82	8015	677	8074A	696
7637B	663	7978B	666	862PZ	82	8016	677	8074G	696
7637G	663	7980L	667	862TX	82	8016FR	678	8080	696
7640GG	653	7980NC	667	862TX/L	82	8016-K	677	8085R	689
7642G	663	7980RN	667	862TX-XL	82	8016U2	678	8086	689
7643G	663	7981N	667	862XP/A16	83	8016UGK	678	8090F	709
7644GG	663	7982N	667	866LP	83	8016U-K	678	8090R	689
7647GG	660	7984G	667	866PE	83	8018E	678	8091	685
7648GG	661	7985N	667	866PH	83	8018T	678	8091SL	685
7650	653	7996N	666	866PZ	83	8020	679	8092	686
7650B	653	7997GN	666	866TX	83	8020A	679	8092SL	686
7653G	659	7998GN	666	867/...	84	8021	679	8094	686
7654B	663	8		867/C20	84	8021A	679	8094SL	687
7654N	663			867/C38	84	8025	680	8096	687
7657B	663	80	15	867/C52	85	8025-K	680	8096SL	687
7657N	664	80/S	15	867PE	83	8026A	681	8097	688
7658CM	661	83	15	867PE/L	83	8026A-K	681	8097SL	688
7659N	661	83/S	15	867RIBE	84	8026R	679	8098	688
7660B	653	83AS	16	867RIBE/L	84	8026R-K	679	8098SL	689
7660G	654	83AS/S	16	867RTX	84	8028	681	8100	689
7661B	657	88	16	867RTX/L	84	8028-K	681	8105	671
7661G	657	88/S7	16	867TX	84	8029R	679	8105-K	671
7664N	664	89BA	299	867TX/L	84	8029R-K	680	8109	671
7665N	664	89MQ	279	867XZN	83	8029RS	680	8109-K	671



TARTALOMJEGYZÉK CIKKSZÁM SZERINT

8110	671	8181S	710	8285	704	93K	596	96TBP/S	22
8120	695	8182	710	8286	704	94	17	96TBP-HS	286
8120B	695	8182 8,5/B2	711	8287	704	94/S	17	96THS	286
8120D	695	8182A	711	8290	705	94K	596	96THS-AS	286
8120DZC	695	8182E	710	8293	705	95	17	96TINOX	294
8121MZC	695	8182GD	711	8297C	705	95/S	17	96TINOX/S5	294
8129	695	8182H	711	8297F	705	95BA	299	96TINOX/S8	294
8130	695	8182H/2	711	8302Z	676	95FTX	17	96TINOX-AS	294
8134	691	8182S	711	8303Z	676	95FTX/S	17	96TINOX-AS/S7	294
8135	692	8182T	710	8381SX	705	96	18	96TK	597
8135/KLA1	697	8182TS	710	8600 R/11	623	96/B	18	97BRTXL/SC8	23
8135/KMO	697	8183	712	8600 R/113	623	96/BG7	18	97BTX	22
8135H	692	8184	711	8600 R/114	623	96/BGS7	18	97BTX/B	22
8143	692	8185	712	8600 R/12	623	96/SC12	18	97BTX/SC8	22
8143/RKCI	697	8186	712	8600 R/13	623	96/SC9	18	97BTX-C/SC8	22
8143/RKL	697	8187	712	8600 R/225	623	96/ST	18	97BTXL	22
8143/RPC	697	8188/K8	713	8600 R/412	623	96/ST6K	596	97BTXL/SC8	22
8143/RPF	697	8188C	712	8600 R/511	623	96AS	19	97RTX	23
8143SL	692	8188CG/25	713	8600 R/601	623	96AS/B	19	97RTX/B	23
8146	693	8188CU/25	713	8600 R/602	623	96AS/BG7	19	97RTX/SC8	23
8146/RK	697	8188F	713	8600 R/611	623	96AS/SC9	19	97TTX	23
8146/RKCI	697	8188F35	713	8702N - 8702Z - 8702ZC	676	96AS/T	19	97TTX/S	23
8146/RKFC	697	8188VFG2	713	8709N - 8709Z - 8709ZC	677	96BA	299	97TTX/SP	23
8146/RKL	697	8189	713	8871	291	96BA/BP	299	97TTXHHS	286
8146/RPC	697	8189A	713	8872A	291	96BAF-AS	300	97TX	22
8146C	693	8189PA	713	8872AS	291	96BP	20	97TX/B	22
8146SL	693	8190	712	8873	291	96BP/AS	21	97TX/BG8	22
8147C	694	8190B	712	8877	291	96BP/ASB	21	97TX/G	22
8147C/RKR	698	8201T	700	8877M	291	96BP/AS-SC9	21	97TX/SC8	22
8147P	694	8205	699	8879	291	96BP/SC9	20	97TX/ST	22
8147S	694	8206	699	8880	291	96BPA	21	98XZN	23
8147S/RKR	697	8207	699	8883	291	96BPA/SC9	21	98XZN/B	23
8148	694	8209	699	8889C1	569	96BPC	20	99	23
8148/RA	698	8210	699	8889C2	569	96BPC/SC9	20	99 VN/...	24
8148/RKCL	698	8210F	700	8889C3	570	96BP-CL	20	99BA	300
8148/RKCM	698	8210FTP	700	8889C6	570	96BP-CL/SC9	20	99SQ	23
8148/RKG	698	8216	700	8889CS	570	96BP-HO/SC9	20	99ST	24
8148/RKS	698	8216-K	700	8889I4	570	96BPINOX	293	900	86
8148/RP	698	8220	701	8889P1	569	96BPINOX/B	293	900/...	89
8148F	694	8225	701	8889P2	569	96BPINOX-AS	293	900/16	89
8149	698	8227	701	8889P3	569	96BPINOX-AS/B8	293	900/20LK	599
8149 CMC	698	8228	701	8889P4	570	96C-AS/SC9	19	900/25	89
8149CM	698	8240	701	8889PS	570	96L	20	900/25K	599
8149CM/RA	698	8240F	701	9		96L/SC12	20	900/32	89
8150	706	8242	702	9		96L/SP8	20	900/35A	89
8153	706	8242F	702	90	16	96LBP	20	900/40	90
8156	706	8248	700	90/B8N	16	96LBP/SC9	20	900/42	90
8157	706	8249	700	90/S	16	96LC	19	900/55	90
8158	707	8249G	700	90/SP	16	96LC/SC12	19	900/55Z	90
8159	707	8250	703	90AS	16	96LC/SC8	19	900/55ZK	599
8160	707	8264	703	90AS/S	16	96N	18	900/58	90
8161	707	8267	703	90BA	299	96N/B	19	900/58K	599
8166	709	8272	704	90K	596	96N/G	19	900/C11	91
8170	707	8273	704	91	17	96N/SC12	19	900/C11HR	93
8173	707	8274	702	91BA	299	96N/SC9	19	900/C11Z	91
8176	708	8274A	702	91HS	286	96N/ST	19	900/C12MR	91
8177	708	8274G	702	91HS-C	286	96N/ST6K	596	900/C12MZ	91
8178	708	8276	702	92	17	96T	21	900/C13-5	91
8179A	709	8276G	703	92BA	299	96T/AS	21	900/C13-8	91
8179B	708	8278	703	92HS	286	96T/S	21	900/C24	92
8179M	708	8279	705	93	17	96T/SP	21	900/C39N	90
8180	710	8280	703	93BA	299	96T/SPV	21	900/C39U	90
8181	710	8282S	704	93C	17	96TAS/S	21	900/R55	111
8181 6/B4	710	8284	704	93HS	286	96TBP	22	900/R55-Z	111



TARTALOMJEGYZÉK CIKKSZÁM SZERINT

900/RN55	111	910/R55	111	910XZN	96	920AS/MBM-C21	108	921BA/21 - 921BA/22	301
900/SB	86	910/R55X	111	911BA	300	920AS/SB11	100	921BA/25	301
900AN	89	910/RN55	111	911BA/16	300	920ASL/SB11	100	921BA/42	301
900AS	87	910A	93	911BA/20	300	920B	99	921BA/50	301
900AS/C10 - /MB-C17	93	910A/AS	94	911BA/55	300	920B/C30Q	106	921BA/R50	301
900AS/C17-MBM	93	910A/C16...	98	914MQ/A	281	920B/SB13	99	921BA-AS	301
900AS/L	87	910A/C16HR	99	914MQ-A/S4	281	920B/SB8	100	926BA	301
900AS/MB	87	910A/C17	98	920.../C11	105	920BL	100	926BA/15	301
900AS/MBL	87	910A/SB	93	920.../C12...	105	920BL/SB11	100	926BA/22	301
900AS/SB11	87	910A-AS/SB13	94	920.../C20...	106	920BP	102	926BA/42	301
900BG/30	89	910AK	599	920.../C21...	106	920BP/SB	102	926BA/50	302
900BG/30C	89	910AL	94	920.../C33	107	920ES	103	926BA/R50	302
900BG/30K	599	910AL/SB14	94	920/15	103	920ES/SB	103	928.../C12	110
900FL	89	910AN	97	920/16	103	920ES/XL-SB	103	928/15	109
900FTX	88	910AS	94	920/20+920/23	103	920FTX	101	928/16	109
900FTX/SB9	88	910AS/C13...	99	920/21K	599	920FTX/C	101	928/20 - 928/21 - 928/22	109
900HS/55	287	910AS/L	95	920/25	103	920FTX/L	101	928/25	109
900K	599	910AS/MBM-C18	99	920/25K	600	920FTX/LSB	101	928/36A	109
900L	87	910AS/SB13	94	920/35A	103	920FTX/SB	101	928/42	109
900L/SB	87	910AS/SN	95	920/36A	104	920HS/55LC	287	928/55	109
900LP	88	910ASL/SB12	95	920/38	104	920INOX-A	294	928/R55X	112
900M/35	89	910B	94	920/40	104	920LH/SB7	101	928/RN55	112
900M/55	90	910B/C16...	98	920/42	104	920LP	101	928A	108
900M/R55	111	910B/SB	94	920/44	104	920M/35	104	928AS	109
900MB	86	910B/SN	94	920/46	104	920M/35L	104	928AS/C12	110
900MB/C19	92	910BL	94	920/50	104	920M/55	105	928B	108
900MB/C28	92	910BL/SB	94	920/50F	104	920M/56	105	928B/C12	110
900MB/L	87	910BP	96	920/55	104	920M/R55	112	928ME	109
900MB/SB	86	910BP/SB6L	96	920/55INOX	294	920MC	99	929	110
900MC/C24	92	910CF	96	920/55LC	105	920MC/C14	106	929/15	110
900MC/C32	92	910CF/SB	96	920/55Q	104	920ME	102	929/21 - 929/22	110
900MC/LP	88	910FTX	95	920/55X	104	920ME/C7	102	929/42	110
900MC/PH	88	910FTX/L	95	920/56A	105	920ME/SB	102	929/55	110
900MC/TX	89	910FTX/LSB	95	920/58	105	920MQ/21	281	929/55PR	110
900ME	88	910FTX/SB	95	920/58K	600	920MQ/22	281	929/C8	110
900ME/SB8	88	910FTX/XL	95	920/C37	107	920MQ/55A	281	929/R55	112
900PE/AS	88	910FTX-XL/C10	95	920/R50	111	920MQ/A	281	930	112
900PH	88	910HS/55	287	920/R55	111	920MQ/C16	281	930/C	112
900PH/SB4	88	910LP	95	920/R55INOX	294	920MQ/PE	281	930/S	112
900PT	88	910M/35	97	920/R55LC	112	920MQ/T	281	932	112
900PZ	88	910M/55	97	920/R55X	112	920PE	101	932/S	113
900T/44	90	910M/56	97	920/RN50	111	920PE/AS	102	932HS	287
900TX	89	910M/R55	111	920/RN50F	111	920PE/C	101	933	113
900TX/SB	89	910ME	96	920/RN55	112	920PE/SB	101	933/S	113
900U	87	910ME/SB	96	920/RN55LC	112	920PE-AS/SB6	102	935	113
900U/C12M	92	910MQ/21	280	920/RN55Q	112	920PH	101	935/S	113
900U/SB	87	910MQ/22	280	920/RN55X	112	920PH/SB4	101	935K	600
902A/C22	93	910MQ/55	280	920A	99	920RTX	102	937	113
902R/C6	93	910MQ/B	280	920A/AS	100	920RTX/SB	102	937/S	113
910.../C10	98	910MQ/C16	280	920A/C17HR	108	920TX	102	937BA	302
910.../C29	98	910MQ/PE	280	920A/C17M	107	920TX/C	102	937K	600
910/15	96	910MQ/PT	280	920A/C17MR	107	920TX/C17	108	940	113
910/16	97	910MQ/T	280	920A/SB13	99	920TX/L-SB10	102	941	113
910/20 - 910/21 - 910/22	97	910MQ/TX	280	920A/SB8	99	920TX/SB	102	941/S	113
910/21K	599	910MQ/XZN	280	920A-AS/SB11	100	920U	100	942BX	114
910/25	97	910PE	96	920AK	599	920U/SB13	100	942BX/DG	611
910/25K	599	910PE/AS	96	920AL	100	920U/SB4	101	942BX/S	114
910/36A	97	910PE/SB	96	920AL/SB11	100	920XZN	103	943BX	114
910/40	97	910PH	95	920AN	103	920XZN/LS	103	943BX/D	114
910/42	97	910PH/SB4	95	920AS	100	920XZN/SB12	103	943BX/DG	611
910/46	97	910PT	96	920AS/C10	107	920XZN/SB7	103	943BX/S	114
910/55	97	910PT/SB	96	920AS/C15	107	921BA	301	943BXK	600
910/58	98	910TX	96	920AS/C17X	108	921BA/15	301	943FL	114
910/58K	599	910TX/SB	96	920AS/L	100	921BA/16	301	943FL/S	114



TARTALOMJEGYZÉK CIKKSZÁM SZERINT

943MQ	281	961P6/S	121	9503TL	715	9565K	725	9812M	573
943MQ/BG	611	962	121	9504TL	715	9565S	669	9813H	573
943MQ/S	281	962C	270	9510W	716	9565T	725	9821L	574
944BX	114	962M	121	9520P	721	9566K	725	9822M	574
944BX/D	114	962P	121	9521	721	9566S/3	725	9823H	574
944BX/DG	611	963	121	9521OB	721	9569MS	724	9831L	574
944BX/S	114	963BA	302	9522A	721	9569MS-2	724	9832M	574
949	114	964	121	9523A	722	9569P	724	9833H	574
949/S6	115	964BA	302	9523T	722	9569S	724	9840BF - Beta Fix	575
950	115	964BA/L	302	9524SC	721	9572LB	716	9841N	575
950/S	115	965	121	9525CM	716	9574B	717	9841R	576
951	115	965/S	122	9525TR	716	9574O	717	9842W - Acryl Seal	575
951/S	115	965BA	302	9525WB	716	9577R	716	9843T - Multi Sil	575
951/SP	115	966/C3	122	9526F	722	9579C	716	9844T - Neutral Sil	575
951AS	116	966BA	302	9526MC	722	9580S	717	9851	576
951AS/S	116	966BA/V	302	9526RMN	721	9586K	722	9860 - Multi Foam	575
951BA	302	969/C5	122	9527 6T	722	9587 13x21	723	9881U	578
951GP	116	969B	122	9527T	722	9587 9x14	723	9882R	578
951GP/S6	116	970B	122	9528B	722	9588/10PI	723	9899 CV/A	111
951K	600	970IVECO	122	9528C	721	9588M	723	9899 CV/B	111
951MQ	281	971/C8	122	9534BO	716	9588S/10...	724	9899 CV/C	111
951TX	116	972/C10	122	9534WO	716	9589A/36	724	C	
951TX/S	116	972/C4BMW	122	9539CB	718	9589B/36	724		
952	117	973	123	9541BIKE	717	9592AC	723	C3	350
952/D7	117	978 - 979	123	9541F	717	9592B/C50	723	C5 - 2105	350
952/S	117	982	123	9541PC	718	9592B/P	723	C5S	350
952AS	117	983 PM/R-DA	123	9541S	718	9592MG/3	723	C6T - 2106	351
952FTX	117	983PM	123	9542AL	718	9593A	717	C7 - 2107	351
952FTX/S	117	984	123	9542C	718	9593M	717	C7AT	351
952L	117	985/B7	123	9542G	718	9593SB	717	C8 - 2108	351
953	117	985F	123	9542GW	719	9593W	717	C8B	351
953/S	117	985M	123	9542M	719	9594	724	C9 - 2109	351
953TX	117	986 48	123	9542S	719	9595C	724	C9/RT	352
953TX/S	117	986 78	123	9543C	717	9595T	724	C9DA	352
955	118	986PT	124	9544C	718	9596	724	C9MT	352
956C	118	987	124	9547	723	9597P	720	C9PT	314
956E	118	987AR	124	9547T	721	9597TRIOWAY	719	C04TSS-7	296
956F	118	987P	124	9547WSK	721	9598WHP-N	720	C10 - 2110	352
956L	118	988/K4	124	9548G	721	9598W-N	719	C10S - 2110S	353
957	118	989	124	9548KB	720	9599CB-N2	720	C11 - 2111	353
959	119	989A	124	9548KB 20	720	9599CB-WN	720	C12 - 2112	353
959R	119	989B	124	9548KB 24	720	9710 - LUBRIBETA universal	576	C13	353
960/C6	119	990	124	9549ABW	722	9712 - Ultra Sblock	576	C14	353
960A	119	991	124	9549BP	722	9720 - Multi Grease	576	C16 - 2116	354
960AVE	119	992	124	9549BRW	722	9722 - Lithium Grease	576	C18 - 2118	354
960EPC/L	119	993	124	9549C	722	9724 - PTFE Grease	576	C19 - 2119 - C19L - 2119L	355
960E-PI/P	120	993G	125	9549CR	723	9726 - Copper Grease	577	C20 - C20L - 2120	355
960ER	119	993MQ	282	9549MPC	723	9729 - Silic Spray	577	C20TSS	295
960KC-M8/M9/M10	120	993PL	124	9549SBW	723	9738 - Cutting Oil	577	C22B	355
960KPC	120	994	125	9557J 2.0	718	9740 - Brake Cleaner	577	C22P	355
960P	120	994MQ	282	9559	726	9741 - Multi Cleaner	577	C22W	355
960PI	120	994PL	125	9559/S	726	9742 - Contact Cleaner	577	C25	372
960PI/C19	120	994TF	125	9561V	726	9745 - Carb Cleaner	577	C27S	373
960PI/K36	120	996	125	9561VV	726	9746 - Clima Cleaner	577	C30M	375
960PI/S	120	998	125	9561VV 2,5	726	9749 - Air Spray	578	C35/6GM	376
960PMC	121	999	125	9562	726	9752 - Zinc 98%	578	C35/7GM	377
960RPI	121	999/B6N	125	9562P12	725	9755 - Welding Spray	578	C35/8GM	377
960SL	119	999A	125	9562P2	725	9765 - Deicer Spray	578	C35/9GM	377
960SN	119	999B	125	9562T1	269	9775 - Water Stop	578	C37/6	379
960T/C11	119	999C	125	9562T2	726	9801L	573	C37/7	378
960UC	120	999D	125	9562T3	269	9802M	573	C37/8	379
960VTC	121	999E	125	9562TB	669	9803H	573		
961BA	302	999G	125	9563G	725	9811L	573		
961N	121	9501TLD	715	9563U	725				



TARTALOMJEGYZÉK CIKKSZÁM SZERINT

C37A/7	379	C45PRO 2.0 MWS/W	473	C55M4	429	C58CSH 5C	408
C39/6	382	C45PRO 2.0 MWS/X	473	C55M7	429	C58CSH 6C	408
C39/7	381	C45PRO 2.0 PAS	482	C55M8	430	C58GF	405
C39/8	382	C45PRO 2.0 PF	482	C55MA	431	C58GRF	405
C39MD	384	C45PRO 2.0 PFE	482	C55MDO	431	C58GRGM	405
C39SM	384	C45PRO 2.0 PM	484	C55MP	437	C58GT	405
C39T	382	C45PRO 2.0 PML	485	C55MS	432	C58K/2PF-1,6M	408
C41H	385	C45PRO 2.0 PWE/1-0,7MT	474	C55P/2MDX-SX	433	C58K/2PF-2,1M	409
C41H/CE	385	C45PRO 2.0 PWE/2-1,3MT	474	C55P/MCD	433	C58K/4PF-1,6M	409
C41S	385	C45PRO 2.0 PWE/3-2,0MT	475	C55PB/3	419	C58K/4PF-2,1M	409
C42H	386	C45PRO 2.0 PXE/1-0,7MT	474	C55PB-PRO/7	420	C58MA	407
C45PRO 2.0 A1/R600	485	C45PRO 2.0 PXE/2-1,3MT	474	C55PB-PRO/8	420	C58MP-0,8M	411
C45PRO 2.0 A1/RB600	485	C45PRO 2.0 PXE/3-2,0MT	475	C55PFA-0,8	435	C58MP-1M	411
C45PRO 2.0 ACT	480	C45PRO 2.0 RD/W	478	C55PFA-1,0	433	C58P	396
C45PRO 2.0 AS1	485	C45PRO 2.0 RD/X	478	C55PM	433	C58PFL	410
C45PRO 2.0 AS2	486	C45PRO 2.0 SL	481	C55PM/M0,8	435	C58PLED-150	411
C45PRO 2.0 AS2/3C	486	C45PRO 2.0 SS	481	C55PRO B/2	421	C58PLED-90	412
C45PRO 2.0 AW	468	C45PRO 2.0 T3	481	C55PRO B/2,8	422	C58PLT-W 1,6	404
C45PRO 2.0 AX	468	C45PRO 2.0 TC	481	C55PRO B-D4	423	C58PLT-W 2,1	404
C45PRO 2.0 BLW	472	C45PRO 2.0 W	467	C55PS	436	C58PLT-X 1,6	404
C45PRO 2.0 BLX	472	C45PRO 2.0 X	466	C55PSE	436	C58PLT-X 2,1	405
C45PRO 2.0 BPW-1,3	471	C45PRO A2/R915	486	C55PT0,8X0,6	435	C58SP 1,6	410
C45PRO 2.0 BPW-2,0	471	C45STR	487	C55PT1,0X0,6	434	C58SP 2,1	410
C45PRO 2.0 BPX-1,3	471	C48M	388	C55PTE-0,8	435	C59A	413
C45PRO 2.0 BPX-2,0	470	C48P	389	C55PTE-1,0	434	C59B	413
C45PRO 2.0 BW	469	C51	389	C55RB	426	C59C	414
C45PRO 2.0 BX	468	C54S	393	C55STR	440	C62M/WW	668
C45PRO 2.0 C5	475	C55	418	C55T3	432	C64	668
C45PRO 2.0 C7	476	C55 A1/RB42	438	C56	412	C64CW	669
C45PRO 2.0 CAI/W	484	C55/1PF	435	C56P O	392	C64G	669
C45PRO 2.0 CAI/X	484	C55/2PM	434	C56PL O	392	C68	615
C45PRO 2.0 CORNER/W	483	C55/PF	433	C56W	412	C68 G	615
C45PRO 2.0 CORNER/X	483	C55/PL-1,024	426	C57SA	394	C68N	615
C45PRO 2.0 CPF	474	C55A1	438	C57SB	395	C88 R/1	615
C45PRO 2.0 CW	470	C55A1/R42	438	C57SC	395	C88/R601	623
C45PRO 2.0 CX	470	C55A2	439	C57SD	394	C88/R611	623
C45PRO 2.0 DW	465	C55A2/R70	439	C57SP	396	C88SE	615
C45PRO 2.0 DX	464	C55AB	419	C58BAC 1,6	410	C88VE	615
C45PRO 2.0 EW	469	C55AC	437	C58BAC 2,1	410	C99	356
C45PRO 2.0 EX	469	C55AE	436	C58BC-W1,6	397	C99P	358
C45PRO 2.0 FW	465	C55AT1	440	C58BC-W1,6 2C	398	C99PP	358
C45PRO 2.0 FX	465	C55AT2	440	C58BC-W1,6 4C	399	C99V0	356
C45PRO 2.0 GW	466	C55B PT/2	426	C58BC-W2,1	399	C99V0-P12	357
C45PRO 2.0 GX	466	C55B PT/2,8	426	C58BC-W2,1 2C	400	C99V2	357
C45PRO 2.0 HW	467	C55B/2	421	C58BC-W2,1 4C	401	C99V3/2C	358
C45PRO 2.0 HX	467	C55B/2,8	422	C58BC-W2,1 4CA	401	CA49-G	387
C45PRO 2.0 M3A	479	C55B/G	424	C58BC-W2,1 6CA	402	CB52	391
C45PRO 2.0 M4	476	C55B/GAA	424	C58BC-W2,1 8CA	402	CB/2	571
C45PRO 2.0 M5	476	C55B/GAE	425	C58BC-X1,6	398	CD23S	360
C45PRO 2.0 M7	477	C55B/GDP	424	C58BC-X2,1	400	CP15 - 2115	353
C45PRO 2.0 M7A/W	473	C55B/GDS	424	C58BC-X2,1 4C	403	CP15L - 2115	354
C45PRO 2.0 M7A/X	472	C55B/GE	425	C58BC-X2,1 4CA	403	CP17 - CP17L - 2117	354
C45PRO 2.0 M8	477	C55B/VS	426	C58BC-X2,1 8CA	404	CP51	391
C45PRO 2.0 MA	478	C55B-D4	423	C58BLP-1,6M	411	CPMB/3C	489
C45PRO 2.0 MAL	479	C55C7	427	C58BLP-1M	411	CPMB/5C	490
C45PRO 2.0 MAT	479	C55C8	428	C58CS 1C	406	CP	490
C45PRO 2.0 ML	480	C55CS	430	C58CS 2C	406	CX49-G	387
C45PRO 2.0 MP	482	C55KAI	437	C58CS 3C	406		
C45PRO 2.0 MRE	480	C55M2	428	C58CSH 3C	407		
C45PRO 2.0 MS	477			C58CSH 4C	407		

G,K	
GM	570
KIT 10VC/5C	490
KIT 6VC/3C	489
KIT/GPS	570
M	
M3CA	491
M01	544
M01K	609
M02	544
M05	544
M06	544
M13	544
M25	544
M30	544
M31	545
M32	545
M33	545
M38	545
M40	545
M44	545
M45	545
M46	545
M49	545
M50	545
M52	546
M53	546
M55	546
M60	546
M62	546
M63	546
M63K	609
M65	546
M67	546
M69	546
M75	547
M78	547
M82	547
M83	547
M85	547
M86	547
M91	547
M92	547
M94	547
M96	547
M100	548
M105	548
M108	548
M110	548
M112	548
M115	548
M118	549
M120	549
M121	549
M125	549
M126	549
M127	549
M128	549
M129	549
M129K	609
M133	549



TARTALOMJEGYZÉK CIKKSZÁM SZERINT

M134	550	MM105	558	RSC50 2.0 M10	454	T34	560	T183	566
M135	550	MM129	558	RSC50 2.0 M4	452	T40	560	T198	566
M136	550	MM210	558	RSC50 2.0 M5	452	T41	560	T199	566
M137	550	MM230	558	RSC50 2.0 M6	453	T45	561	T201	566
M145	550	MM400	558	RSC50 2.0 M7	453	T46	561	T202	566
M153	550	MM401	559	RSC50 2.0 M8	453	T48	561	T204	566
M161	550	P		RSC50 2.0 MA	455	T50	561	T205	566
M162	550		RSC50 2.0 MDO	456	T52	561	T206	566	
M166	550	PM 1/2-Q5	72	RSC50 2.0 ML	456	T55	561	T207	566
M170	550	PM/5C	490	RSC50 2.0 MS-2AVV	455	T59	561	T208	566
M172	551	PM/6C	490	RSC50 2.0 MS-2C	454	T63	561	T209	567
M174	551	PV	396	RSC50 2.0 MS-AVV	454	T64	561	T211	567
M180	551	R		RSC50 2.0 MTP	458	T65	561	T213	567
M195	551		RSC50 2.0 NAC	459	T68	561	T216	567	
M201	551	RSC22	359	RSC50 2.0 NAC-W	460	T73	561	T221	567
M204	551	RSC23	360	RSC50 2.0 NAC-X	460	T75	562	T226	567
M208	551	RSC23C	360	RSC50 2.0 NP/1-0,7MT	448	T76	562	T227	567
M209	551	RSC23T	361	RSC50 2.0 NP/2-1,5MT	448	T77	562	T228	567
M213	551	RSC24/5	363	RSC50 2.0 NP/3-2,2MT	449	T80	562	T231	567
M213K	609	RSC24/6	363	RSC50 2.0 P/2MDX-SX	458	T81	562	T233	567
M214	552	RSC24/7	362	RSC50 2.0 PFI	457	T82	562	T234	567
M216	552	RSC24/8	363	RSC50 2.0 PFS	457	T83	562	T236	567
M217	552	RSC24A/6	364	RSC50 2.0 PM	458	T85	562	T239	568
M218	552	RSC24A/7	364	RSC50 2.0 PS	459	T91	562	T241	568
M222	552	RSC24A/8	364	RSC50 2.0 PW/1-0,7MT	449	T92	562	T259	568
M223	552	RSC24AXL/7	365	RSC50 2.0 PW/2-1,5MT	449	T99	563	T264	568
M226	552	RSC24AXL/8	366	RSC50 2.0 PW/3-2,2MT	450	T100	563	T270	568
M227	552	RSC24AXL/9	366	RSC50 2.0 PX/1-0,7MT	449	T101	563	T271	568
M230	552	RSC24AXLP/7	367	RSC50 2.0 PX/2-1,5MT	449	T102	563	T273	568
M231	552	RSC24AXXL	368	RSC50 2.0 PX/3-2,2MT	450	T103	563	T279	568
M234	553	RSC24L/7	371	RSC50 2.0 RB	450	T105	563	T284	568
M236	553	RSC24L-CAB	371	RSC50 2.0 T3	456	T106	563	T285	568
M237	553	RSC28	374	RSC51	390	T111	563	T291	568
M240	553	RSC50 2.0	444	S		T112	563	T294	569
M264	553	RSC50 2.0 A	448		T113	563	T297	569	
M284	553	RSC50 2.0 A1	461	S4CA	487	T122	563	TSPP	571
M292	553	RSC50 2.0 A1/R59	461	S4CB	487	T123	563	V	
M294	553	RSC50 2.0 A1/RB59	462	S42/17	571	T124	564		
M295	553	RSC50 2.0 A2	462	S55/12	570	T135	563	VE1	570
M400	554	RSC50 2.0 A2/3C	462	S55/8	570	T136	564	VP1 - VP2	569
M401	554	RSC50 2.0 A2/R91	462	S96T/8	571	T137	564	VP3 - VP4	569
MB12	555	RSC50 2.0 B	447	S951/6	571	T138	564	VP5	569
MB37	555	RSC50 2.0 C	447	S952/10	571	T140	564	VP6	569
MB39	555	RSC50 2.0 C5	450	S1719BM	571	T144	564	VP7-C	569
MB44	555	RSC50 2.0 C6	451	SB	570	T145	564	VP-3SC	569
MB46	555	RSC50 2.0 C7	451	SCG	415	T146	564	VP-LS	569
MB47	555	RSC50 2.0 C8	452	SGN	571	T151	564	VPM0	559
MB58	556	RSC50 2.0 CS	455	SP5S	491	T153	564	VPM3	559
MB59	556	RSC50 2.0 D	446	SPC	491	T156	564	VPM7	559
MB63	556	RSC50 2.0 DW	447	SPG11 - S1203/8	571	T157	565	VPM7-C	559
MB64	556	RSC50 2.0 DX	446	SSPE	484	T160	565	VPM8	559
MB65	556	RSC50 2.0 E	446	ST2P	570	T161	565	VPM9	559
MB	570	RSC50 2.0 F	445	T		T164	565		
MC10	554	RSC50 2.0 FW	445		T167	565			
MC12	554	RSC50 2.0 FX	445	T01	560	T168	565		
MC20	554	RSC50 2.0 G	444	T05	560	T170	565		
MC21	554	RSC50 2.0 H	444	T06	560	T171	565		
MM11	557	RSC50 2.0 I	443	T23	560	T172	565		
MM26	557	RSC50 2.0 KNAI	460	T24	560	T173	565		
MM30	557	RSC50 2.0 KNAI-W	461	T28	560	T175	565		
MM60	557	RSC50 2.0 KNAI-X	461	T29	560	T176	565		
MM63	557	RSC50 2.0 KPF	457	T31	560	T177	566		
MM100	557	RSC50 2.0 L	443	T33	560	T180	566		



**10 termelési egység
OLASZORSZÁGBAN**



**Mintegy 1000
alkalmazott**

**Világszerte 12
leányvállalat**

**Több mint 250 importőr
a világ több mint 100
országában**



BETA UTENSILI S.p.A. - 20845 Sovico (MB)
Via A.Volta, 18 - Tel. 039.2077.1 - Fax 039.2010742
www.beta-tools.com

Robur Wire rope accessories:
67039 Sulmona (AQ) Zona industriale - C.da S. Nicola
Tel. 0864.2504.1 - Fax 0864.253132
www.roburitaly.com - info@roburitaly.com



AZ OLASZ SZERSZÁMKÉSZÍTÉS TÖRTÉNETE

1923 ● Alessandro Ciceri megalapítja a vas- és acélöntvények gyártására az „Alessandro Ciceri & Figli” vállalatot.

1939 ● A Beta védjegy bejegyzésre kerül és a vállalat elsősorban professzionális kéziszerszámok gyártásában lesz érdekelt. A vállalat székhelye Sovico.

1960 ● A Beta Utensili már 200 főt foglalkoztat, külföldre is szállítja termékeit és professzionális kéziszerszámok feltörekvő gyártójaként tűnik ki.

1969 ● Kifejlesztésre kerül a forradalmian új, narancssárga, fém „Tank” szerszámkocsi. Ettől kezdve a narancssárga szín a Beta egyedi stílusának védjegyévé válik.

1971 ● A Beta Utensili belép a motorsportok világába – először a Formula 1-ben, ezt követően a rally versenyekben, majd valamennyi motorsport területén megjelenik.

1973 ● Megkezdí működését az új gyár Castiglione d’Addában, ezzel kiegészül a Sovico-i gyártóhely.

1975 ● Az első alkalom, hogy a vállalat komoly sikert ér el a Formula 1-ben. Vittorio Brambilla szakadó esőben megnyeri az Osztrák Nagydíjat Zeltwegben a narancssárga March-Beta Utensili-vel.

1984 ● A vállalat megnyitja harmadik gyárát Sulmona-ban és megkezdí az 42-es cikkszámú ikonikus csillag-villáskulcsok gyártását. Emellett Robur márkanév alatt elindul az emelőtechnikai szerelvények gyártása és tesztelése.

1990 ● A Beta Utensili fokozatosan tovább terjeszkedik a főbb európai piacokon és kereskedelmi kirendeltségeket alapít Franciaországban, Angliában, Hollandiában, Spanyolországban, Lengyelországban és Magyarországon.

2000 ● Nowy katalog Bety świadczył o jej trwającym wzroście; liczba dostępnych produktów podwoiła się, a ponad 10.000 pozycji katalogowych zostało podzielonych na 22 rodziny produktowe.

2002 ● Asortyment Bety dalej się poszerzał – został uzupełniony o obuwie robocze i kolekcję odzieży roboczej „Beta Work”.

2009 ● Beta dalej rozszerzała swoją działalność, tworząc oddział Beta China, a trzy lata później Beta do Brasil.

2016 ● Beta wprowadziła nowy modułowy system mebli warsztatowych RSC55.

2018 ● A krimpelhető kábelcsatlakozók és az elektromos csatlakozók gyártásában és értékesítésében piacvezető BM S.p.A., az egyedi műhelyberendezés összeállítások tervezésére és gyártására specializálódott 3D Beta S.r.l., valamint a fém bútorok porfestésére szakosodott VGF S.r.l. a Beta Csoport tagjává válik.

2019 ● A merev és rugalmas csiszolótermékeket gyártó Abra Beta S.p.A. és Elpa Abrasivi S.r.l. szintén a Beta Csoport tagja lett.

2020 ● A Beta a Beta USA megalapításával belépett az észak-amerikai piacra.

2023 ● Az alapítás 100. évfordulójának megünneplése évében a Beta Csoport a hegesztőiparban vezető Helvi S.p.A. felvásárlásával tovább növekedett. A Beta Kutató és Fejlesztő részlege két olasz gyártmányú termékkel jelentkezett: az RSC50 moduláris műhelyberendezés rendszer és a Zero-Reset technológiával ellátott 666 cikkszámú nyomtatókulcs.

2024 ● A Beta Csoportnak ma már világszerte több mint 1.000 munkavállalója van. Termékinálatában 40 termékcsalád és több mint 30.000 egyedi termék található, amelyeket a legigényesebb szakemberek igényeinek megfelelően, a kiváló minőséget és hosszú élettartamot szem előtt tartva terveztek és gyártottak. Mindezen termékek a „Beta Well Done” alapelveinek megfelelően készültek. Mi, a Beta-nál ezen az alapon végzünk a munkánkat, hogy bármit is teszünk, a dolgokat csak egyféleképpen csinálhatjuk: jól.



1923 Alessandro Ciceri & Figli



1939 Vas és acél süllyesztéses kovácslás



1955 Vágástechnika

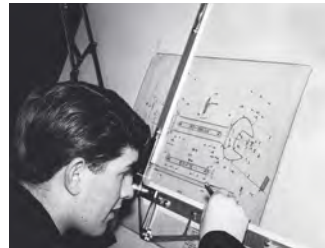

1960 Tervezés



1969 Tank szerszámkocsi



1974 Szerszámkészlet reklám



1975 Vittorio Brambilla



2002 „BetaWork”

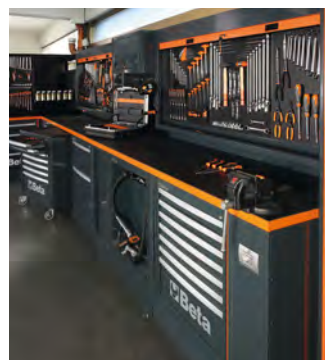

2016 RSC55 műhelyberendezés összeállítás

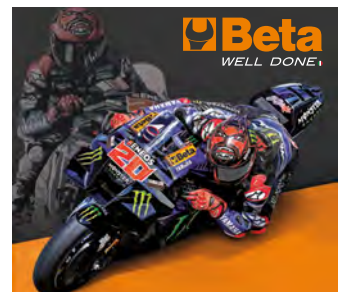

2023 Fabio Quartararo, a Beta nagykövete



TANÚSÍTOTT MINŐSÉG

A Beta már 1995-ben rendelkezett az ISO 9001 szabványnak megfelelő minőségirányítási tanúsítvánnyal, 2018-ban pedig megszerezte a szigorú EK5/TA5 protokoll vizsgálatának való megfelelést bizonyító TÜV tanúsítványt.

Az EK5/TA5 protokoll 31 jól körülhatárolt gyártási jellemzőt, szigorú statikai tesztek és dinamikai viselkedési tesztek irányoz elő. További tesztek határozzák meg a magas és az alacsony hőmérsékletekkel szembeni ellenállást, a jelölések időtállóságát és a korrózióállóságot.

Ennek a célnak az elérése azt a tapasztalt tervezést, a gondos megvalósítást és a szigorú ellenőrzést értékeli, amit a Beta a szerszámkocsik gyártása során alkalmaz, és ami a mai napig biztosítja a végfelhasználók elismerését.

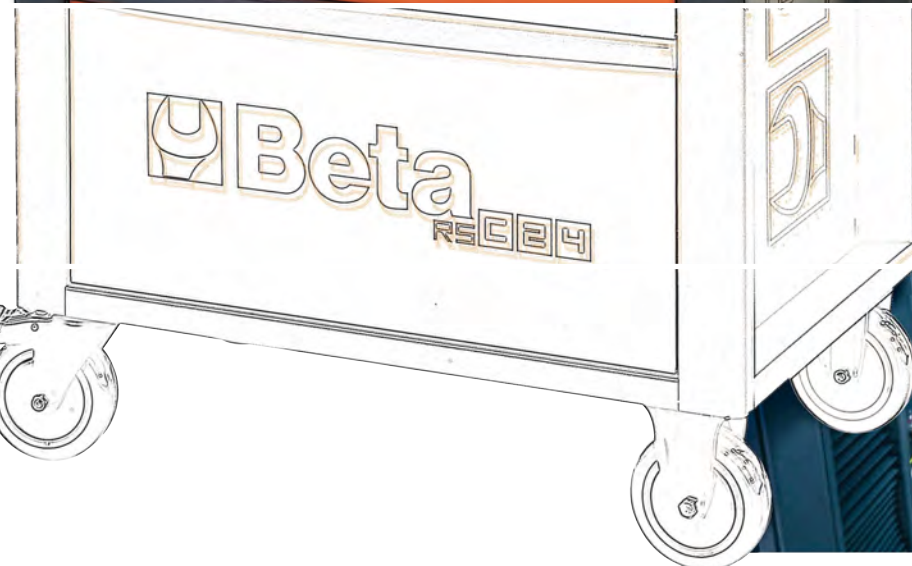



KONTROLL ÉS MINŐSÉG

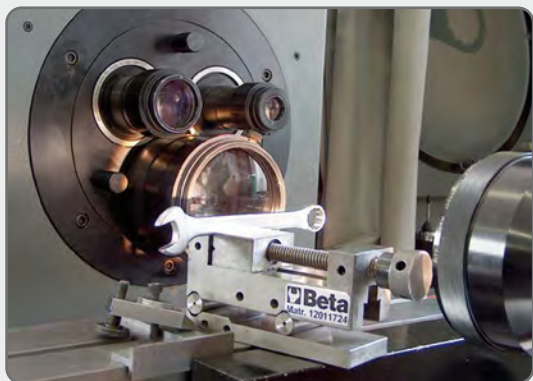

A Beta-nál a minőségnek egyszerű és egyértelmű definíciója van: "az, ami teljes mértékben kielégíti a professzionális felhasználók igényeit és elvárásait, akik pótolhatatlan munkaeszközként tekintenek termékeinkre". Szerszámainkat nem csak egy egyszerű igény kielégítésére tervezzük és gyártjuk, de az idő előrehaladtával következetesen garantálniuk kell az állandó teljesítményt.

A Beta-nál a minőség a gyártási folyamatra és az értékesítési politikára jellemző pusztá figyelmességen túlmutatóan minden részleget áthat és mindannyiunkat arra buzdít, hogy egyre ambiciózusabb célokat érjünk el az ügyfelek elégedettségének terén. A Beta erre a koncepcióra építette fel történetét.

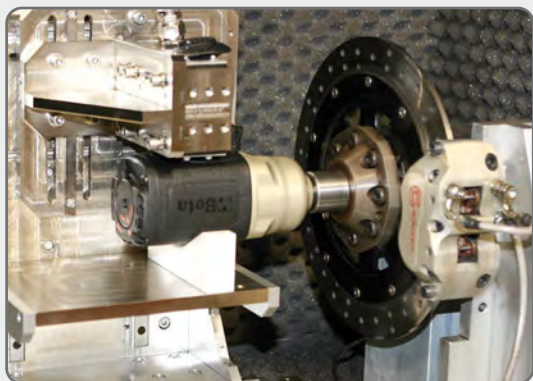

A Beta minőség a legkézzelfoghatóbb eredményünk.



A Beta szerszámok minősége a régi, jól bevált technikák és az új technológiák szinergiája.



Gyártásunk 1995 óta az ISO 9001 minőségirányítási rendszer szabványai szerint működik.





**32,000 m²
terület**



45.000
cikkszám több mint
35.000
jednostek składowania

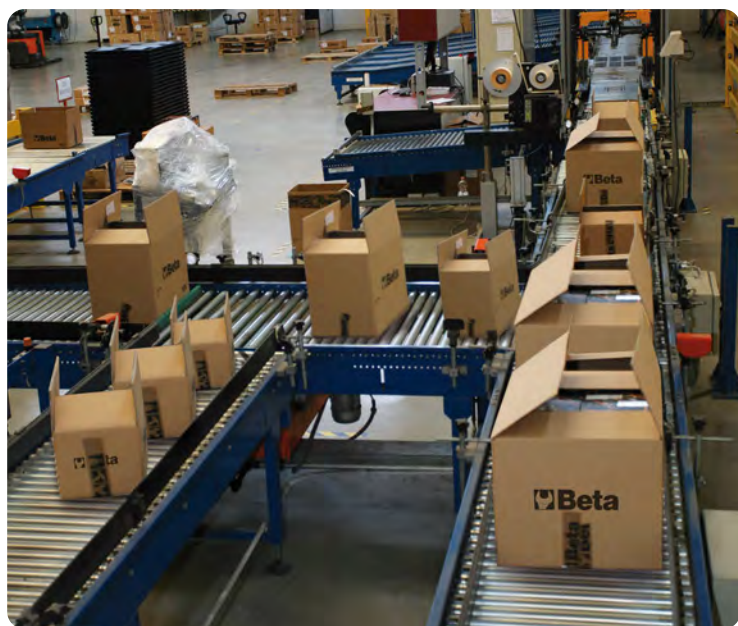

**Gyors, pontos
és hiánytalan
szállítások**





MUNKASZERVEZÉS

Az 5S egy japán eredetű munkahelyi rendszerezési módszer. A név öt japán szó (seiri, seiton, seiso, seiketsu és shitsuke) angolos átírásából származik.

A szavakból létrehozott öt lépés egy rendezett, megismételhető módszert eredményez, melynek célja a munkafolyamatok optimalizálása és a működési teljesítmény fejlesztése.



SEIRI

SZELEKTÁLÁS

A munkahelyen levő szükségtelen dolgok eltávolítása, csak a szükséges dolgok megtartása.



SEITON

ELRENDEZÉS

Minden kerüljön a megfelelő helyére: mindennek legyen helye, és minden legyen a helyén.



SEISO

TISZTASÁG

Legyen a munkahely tiszta és rendezett.



SEIKETSU

STANDARDIZÁLÁS

Következetes munkagyakorlatok létrehozása az erőforrások és a hely racionalizálása, egy megvalósítandó szabvány meghatározása céljából.



SHITSUKE

FENNTARTÁS

A fenti szemlélet és magatartás támogatása és elterjesztése az egész szervezetben.



KORZYSCI



Kevesebb idővesztés és jobb költséghatékonyság



Jobb minőség és fokozott termelékenység



Kevesebb munkabaleset



Nagyobb hatékonyság



PRZED

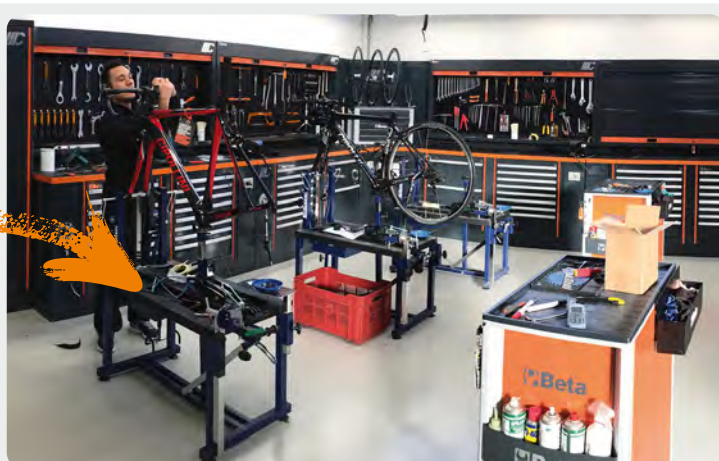

PO



JELENLÉT ÉS MŰSZAKI SZAKÉRTELEM



A Beta értékesítési tanácsadói szoros együttműködésben dolgoznak viszonteladóinkkal és disztribútorainkkal, hogy átadják szakmai tudásukat és tapasztalataikat.

Műszaki szakembereink a Beta felszerelt bemutatójárműveivel járók az országot, ahol tesztelik a termékeket és berendezéseket, valamint értékelik azok jellemzőit, minőségét és működését.





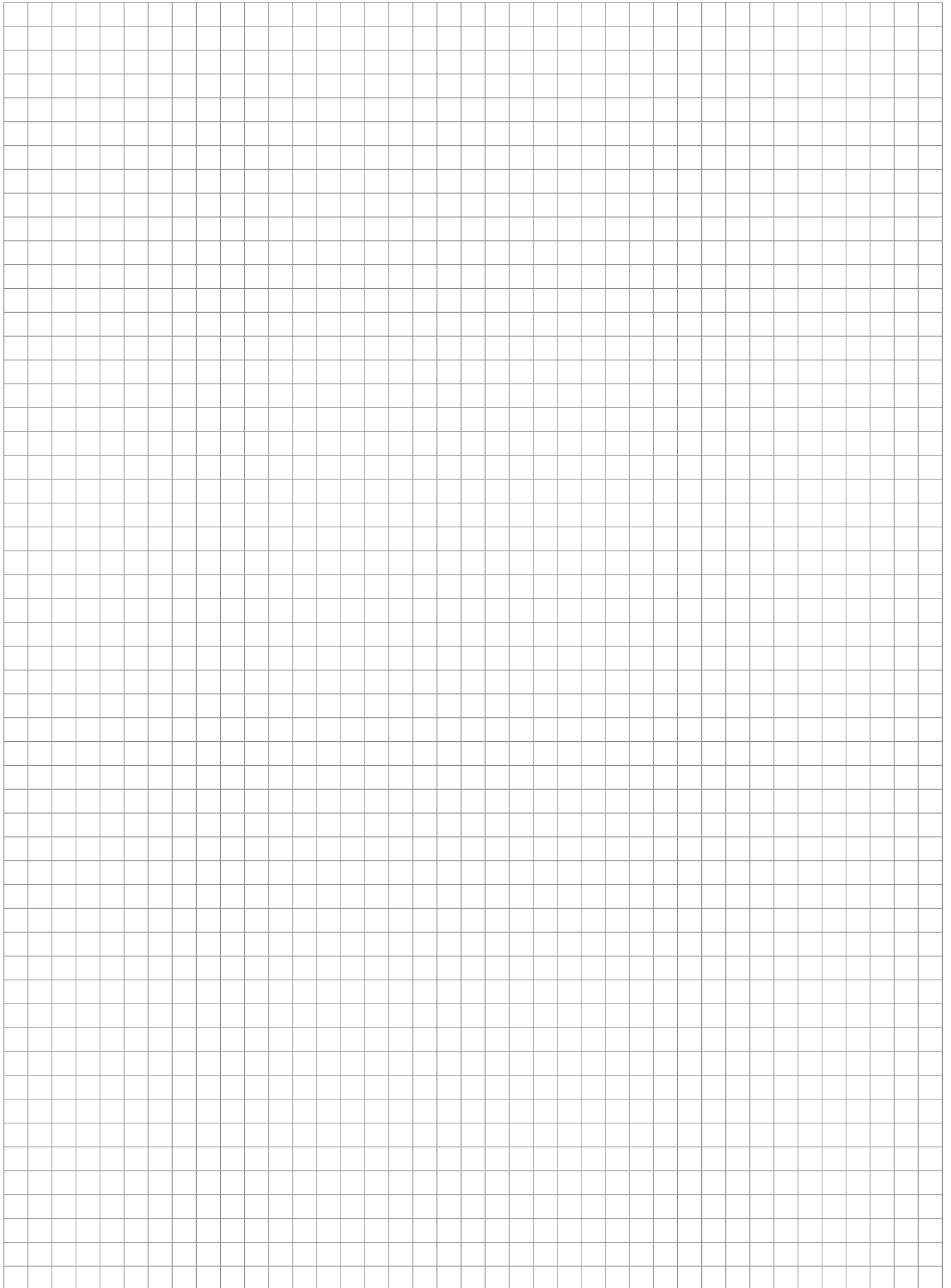





2024 MotoGP
World Championship



Fabio
Quartararo

 **Beta**

50 Years in Motorsports

PARTNERSHIP

20
24

ALONSO LÓPEZ

FERMÍN ALDEGUER



2024 MOTO2
WORLD CHAMPIONSHIP



Technical Partner



Official partner of
aprilia RACING



LEOPARD RACING



Ecosantagata Althea
Racing Team

