

Truck/CV Special 2019



Das Werkzeug



TecDoc
DATA SUPPLIER

There is no faster way!

Targeted troubleshooting with pump and the associated covers quickly localises escaping cooling fluids. This puts an end, once and for all, to constantly having to replenish liquids escaping at the vehicle.

Our quality guarantee:

Made in Germany!

Development and production in Germany guarantee that the cover is a perfect fit for the expansion tank.

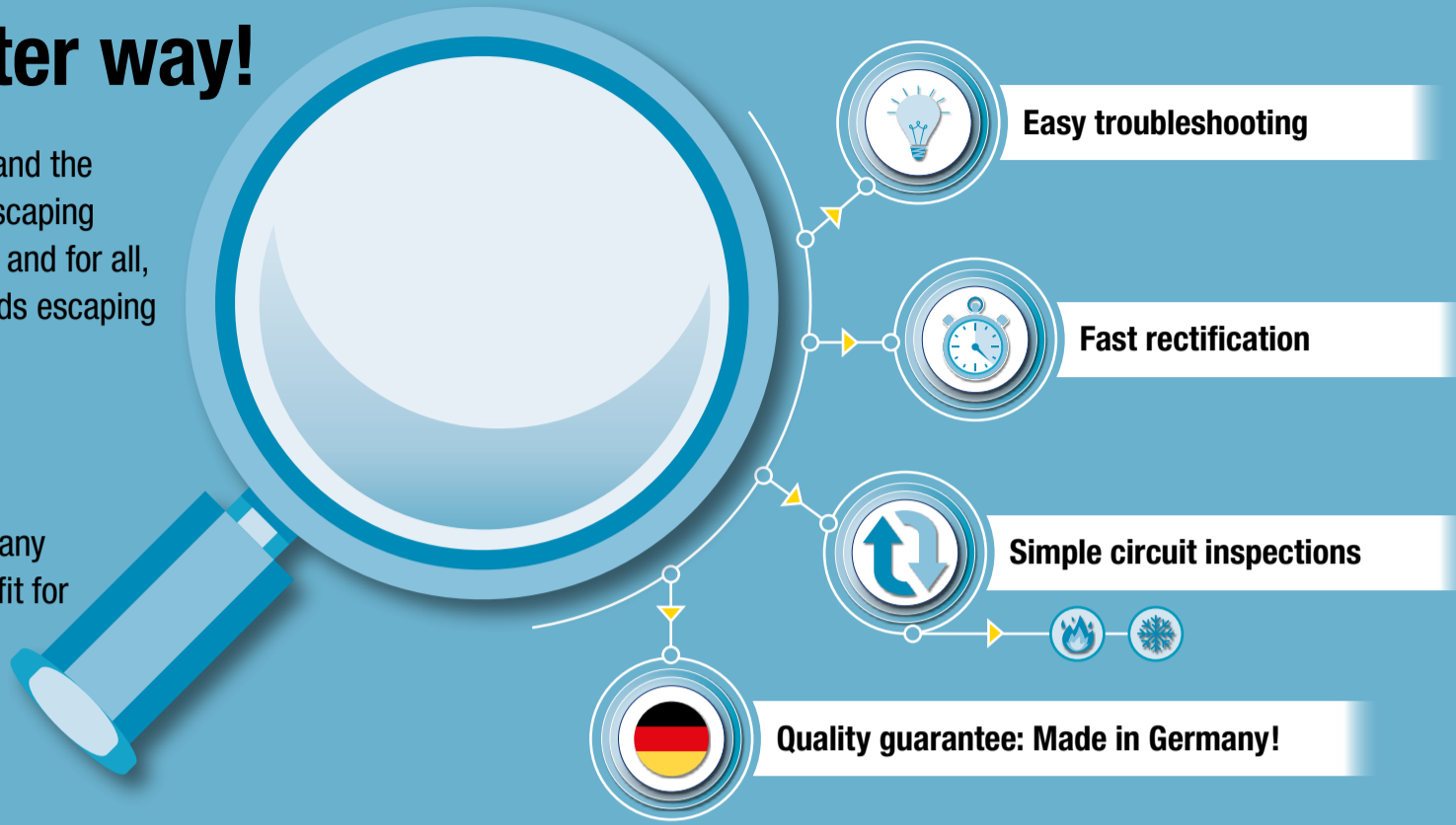

4800 Cooling pump and adapter

Components
 Made in Germany

HAZET No.	EAN-No.
<ul style="list-style-type: none"> Cooling pump Up to 2.5 bar 4800-1	4000896+
<ul style="list-style-type: none"> Intermediary piece, flexible hose 4800-2	022243
<ul style="list-style-type: none"> Amazone Pantera CLAAS Jaguar, Lexion, Scorpion, Ares, Atlas, Ceres DAF 45 model year 05/1991 → 12/2000 DOOSAN Wheel excavator S · Caterpillar excavator DX FENDT KAESER Mobilair LIEBHERR A308-316 MASSEY FERGUSON with tank no. 180224M92 and 4296015M1 MERCEDES-BENZ Vito · Viano · Solaris NISSAN Forklifts PUTZMEISTER BSA 1409 SCANIA Vabis Case Quadtrac, Magnum 4800-3	022274
<ul style="list-style-type: none"> DEUTZ Engines 3.6 PowerPack · BF6M1013FC · TCD2013L6 2V and 4V Genset 250kV HATZ 4H50tic IVECO Eco Daily with blue lock Case Puma, SBS, LBS, Optum, Maxxum, CVX New Holland TVT, T7, T7 Elite Pack, T6 FENDT Vario model year 2000 → Combine harvesters L series CLAAS Arion, Axion 4800-4 A	022281
<ul style="list-style-type: none"> COMPAIR Mobile compressor with VW expansion tank FENDT Farmer 300 model year 1988 → Type 500 · Type 700 · Vario model year 1988 → 2000 LINDE forklifts PUTZMEISTER BSA 1407D · BSA 2110 HP-D RENAULT Midium model year 01/2000 → 12/2013 Volvo FE model year 05/2006 → FL model year 03/2000 → 4800-5 A	156504
<ul style="list-style-type: none"> DEUTZ Engines KHD1015 · D2008 · D2009 · TD2.9 L4 · TCD3.6 · BFM1013 · BFM2012 · TCD2013 2V · BFM1015 · TCD2015 V8 · V6 · M · TCD 12.0 and 16.0 MERCEDES-BENZ Sprinter model year 1999 → Type 170 · 208 · 611 4800-16	161843
<ul style="list-style-type: none"> MERCEDES-BENZ Sprinter from 2006, Viano from 2003 4800-18	098507
<ul style="list-style-type: none"> IVECO Euro-Star · Euro-Tech · Euro-Truck · Daily with black lock MAN F90 · F2000 · TGA model year 03/2000 → TGL model year 04/2005 → TGM model year 10/2005 → TGS model year 10/2007 → 01.2012 · TGX model year 10/2007 → 01.2012 MERCEDES-BENZ Commercial vehicles Actros · Atego 1217 model year → 1999 · Eco 8401 · SK1728 Antos · Arocs · Atego model year 1998 → 2013 · Axor model year 09/2001 → 10/2004 · Econic · Zentros CLAAS Xerion, Tucano 4800-20	128815
<ul style="list-style-type: none"> Volvo Commercial vehicles Scraper tractor dumpers 4800-21 A	144242
<ul style="list-style-type: none"> ISUZU Trucks MITSUBISHI Commercial vehicles Fuso Canter NISSAN Forklifts YALE GDP/GLP 16-30 4800-23	144273
<ul style="list-style-type: none"> MAN Buses such as Lions Coach · Lions Star · Lions Comfort · Lions City MERCEDES-BENZ Citaro model year 01/1998 4800-25	203857
<ul style="list-style-type: none"> DAF CF and XF Euro 6 from 2013 4800-26	214495
<ul style="list-style-type: none"> MERCEDES-BENZ Atego from model year 2014 4800-27	214501
<ul style="list-style-type: none"> MERCEDES-BENZ Actros EURO 6 with HEYCO expansion tank since 2014 4800-28	214518
<ul style="list-style-type: none"> SCANIA 143, G-/P- and R series 4800-29	222780

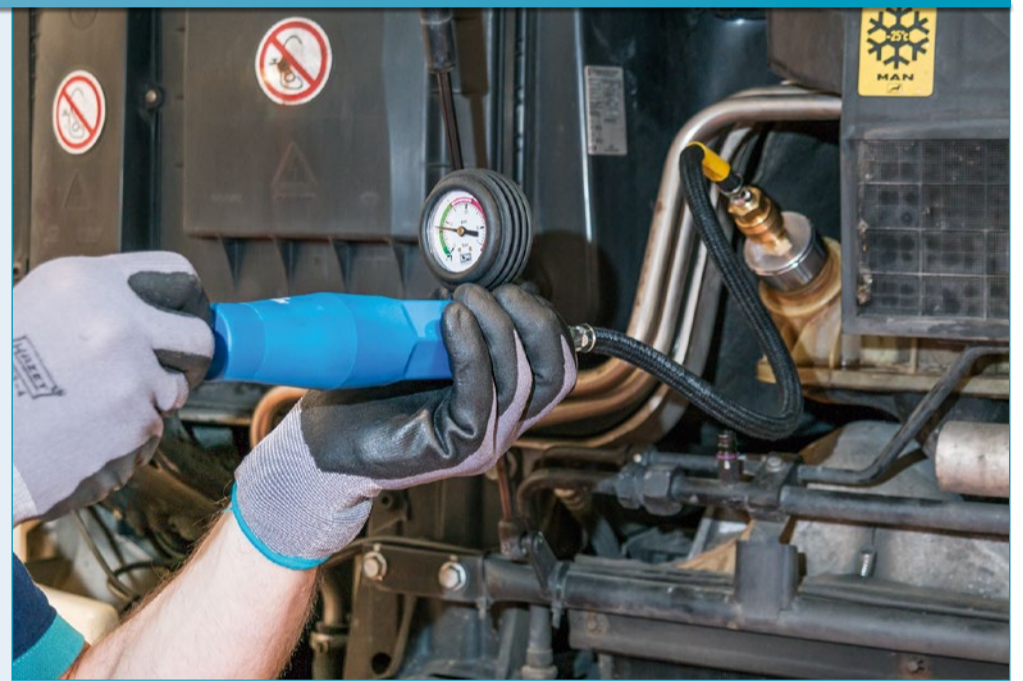

NEW!

NEW!

4800/3, EAN-No. 4000896200047

3

Commercial vehicle radiator tester

- To test for leakage in radiators and heating circuits with pressure build-up, e.g. on **MAN** trucks and buses, **NEOPLAN**, **MERCEDES-BENZ** trucks and buses, as well as agricultural machinery and construction vehicles
- Incl. cover 4800-20

Made in Germany



4802-1, EAN-No. 4000896200030

Commercial vehicle vacuum radiator filler

- New design of the vacuum radiator filler allows the desired vacuum to be reached faster, which allows the cooling system to be filled more quickly
- **Fast cooling fluid flow rate: approx. 80 l in 20 minutes**
- No cooling fluid is lost through the cooling system overflowing
- Separate control through the diagnostic testing device is no longer necessary
- Vacuum leakage test before refilling the cooling system
- **Bubble-free filling of the cooling and heating circuit in trucks, buses, agricultural machinery and construction vehicles**
- Can be used together with single or universal adapters

80 litres in 20 minutes!



Made in Germany



YouTube clip



Title image – A work of art!

The illustration on the title page was created by the Brazilian artist and comic book author **Nik Neves**, who currently lives in Berlin.

Inspired by much of his time spent travelling, he has developed a unique style that can often be found in or on illustrated maps, book covers, comics or calendars, for example.

His work has appeared in "Illustration now! 5" and "Mind the Map" published by "Taschen GmbH, Cologne" and "Die Gestalten Verlag GmbH & Co.KG, Berlin", amongst other publications.

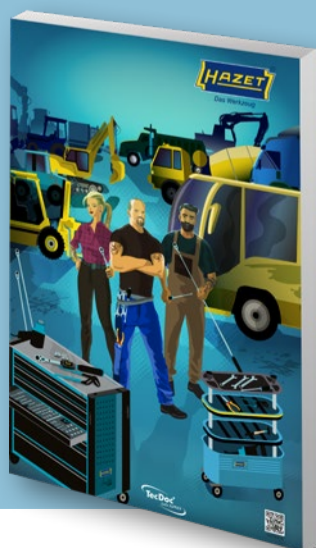

Tool finder

Made in Germany

4800/8, EAN-No. 4000896216499

8

Radiator adapter case for commercial vehicles

- Checking for leakage in cooling systems and heating circuits
- 4800-1 Cooling pump to 2.5 bar
- 4800-2 Intermediary piece, flexible hose
- 4800-3 Radiator adapter for **DAF** 45 model year 05/1991 → 12/2000, **DOOSAN** Wheel excavator S, Caterpillar excavator DX, **KAESER** Mobilair, **LIEBHERR** A308-316, **MERCEDES-BENZ** Vito, Viano, Solaris, **NISSAN** forklifts, **PUTZMEISTER** BSA 1409, **SCANIA** Vabis
- 4800-5 A Radiator adapter for **COMPAIR** mobile compressor with **VW** expansion tank, **LINDE** forklifts, **PUTZMEISTER** BSA 1407D · BSA 2110 HP-D, **RENAULT** Midlum model year 01/2000 → 12/2013, **Volvo** FE model year 05/2006 → · FL model year 03/2000 →
- 4800-25 Radiator adapter for **MAN** buses such as Lions Coach, Lions Star, Lions Comfort, Lions City, **MERCEDES-BENZ** Citaro model year 01/1998, **IVECO** Euro-Star, Euro-Tech, Euro-Truck, Stralis, Daily with black lock, **MAN** F90, F2000, TGA model year 03/2000 →, TGL model year 04/2005 →, TGM model year 10/2005 →, TGS model year 10/2007 → 01/2012, TGX model year 10/2007 → 01/2012, **MERCEDES-BENZ** commercial vehicles Actros, Atego 1217 model year → 1999, Eco 8401, SK1728 Antos, Arocs, Atego model year 1998 → 2013, Axor model year 09/2001 → 10/2004, Eonic, Zentros
- 4800-26 Radiator adapter for **DAF** CF, XF Euro 6 model year 2013 →
- 4800-27 Radiator adapter for **MERCEDES-BENZ** Atego model year 2014 →
- 4800-28 Radiator adapter for **MERCEDES-BENZ** Actros EURO 6 with HEYCO expansion tank model year 2014 → **MAN** TGX, TGS EURO 6 with HEYCO expansion tank model year 2012 →
- Classification to vehicles: www.hazet.de → The Tool Finder → Radiator adapters 4800

Especially for agricultural machinery



Made in Germany



Tool finder

4800/6, EAN-No. 4000896216482

6

Radiator tester for agricultural machinery

- Checking for leakage in cooling systems and heating circuits
- 4800-1 Cooling pump to 2.5 bar
- 4800-2 Intermediary piece, flexible hose
- 4800-3 Radiator adapter for **AMAZONE** Pantera, **CLAAS** Jaguar · Lexion · Scorpion · Ares · Atlas · Ceres, **FENDT**, **MASSEY FERGUSON** with tank no. 180224M92 and 4296015M1, **CASE** Quadtrac · Magnum
- 4800-4 A Radiator adapter for **CASE** Puma · SBS · LBS · Optum · Maxxum · CVX, **NEW HOLLAND** TVT · T7, T7 Elite Pack · T6, **FENDT** Vario model year 2000 → · Combine harvester L series, **CLAAS** Arion · Axion, **DEUTZ** engines 3.6 PowerPack · BF6M1013FC · TCD2013L6 2V and 4V genset 250kV
- 4800-5 A Radiator adapter for **FENDT** Farmer 300 model year 1988 → · Type 500 · Type 700 · Vario model year 1988 → 2000
- 4800-20 Radiator adapter for **CLAAS** Xerion · Tucano as well as all new **CLAAS** machines with **MERCEDES-BENZ** expansion tank
- Classification to vehicles: www.hazet.de → The Tool Finder → Radiator adapters 4800

Top speed repairs

The high dimensional accuracy of our products guarantees strong power transmission to highly stressed components, such as brake calliper fittings.

The striking faces on the wrench mean you can loosen the fitting with just the hammer, no further tools necessary.

Our quality guarantee: Made in Germany!
Thanks to our very high quality standard, the tool withstands even the harshest conditions in any commercial vehicle workshop.

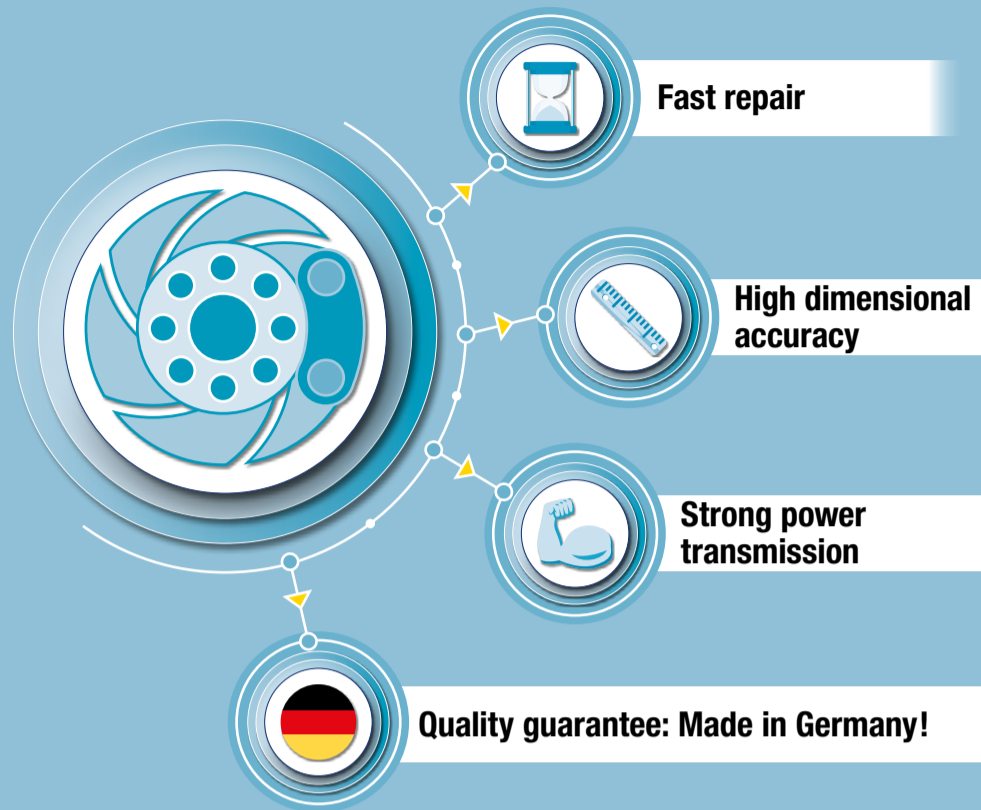

2872 SZ

20 3/4 Commercial vehicle box end wrench (12-point) with 2 striking faces

- 12-point profile facilitates application even on hard-to-reach fittings
- Wrench with 20 3/4 4-point insertion hole for the correct tightening of screws with HAZET torque wrench in accordance with the manufacturer's specifications
- Wrench flat with laser-engraved formula for calculating the correct effective length



Made in Germany

HAZET No.	For the operation of the brake calliper fitting on, e.g.	mm	l mm	EAN-No. 4000896+
2872 SZ-24	SAF-brake calliper, MERCEDES-BENZ Atego and Actros	s 24	219.0	204175
2872 SZ-26	DAF XF95/XF105/XF	s 26	219.0	203727
2872 SZ-27	MERCEDES-BENZ Atego, Actros, KÄSSBOHRER buses	s 27	220.5	207183



2872 E

TORX® slogging wrench with 2 striking faces

- Application: For loosening and tightening TORX® screws on brake calliper fittings on the front axle and trailing axles of trucks
- Use of the wrench for assembly and disassembly of the brake calliper fittings renders disassembly of the steering tie lever unnecessary
- Correct tightening of screws with torque wrench using a 20 3/4 drive in accordance with the manufacturer's specifications
- For e.g. MAN TGL TGM wrench sizes: E18, E20, E24
- 2872-E20 e.g. on Schmitz Cargobull Trailer axles

Wrench flat with laser-engraved formula for calculating the correct effective length

20 3/4 drive for torque wrenches

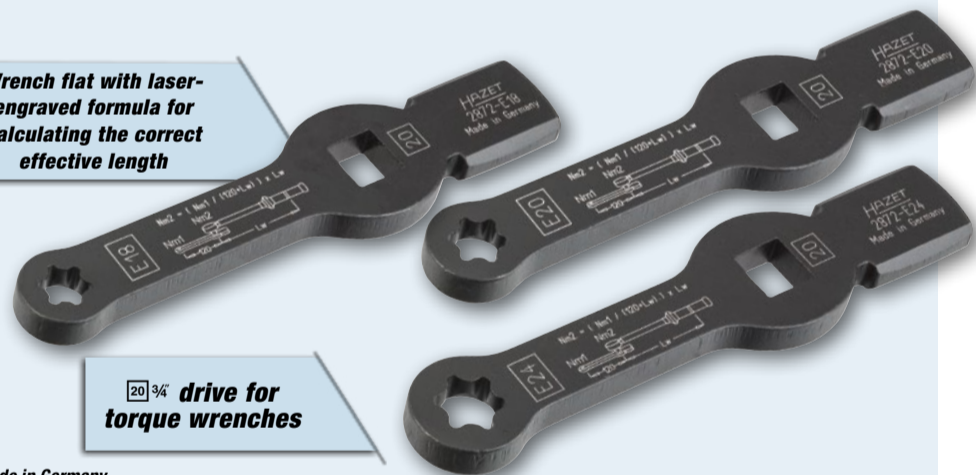

Made in Germany

HAZET No.	mm	l mm	g	Effective length mm	Head width mm	Head thickness mm	EAN-No. 4000896+
2872-E18	E 18	215	573	120	30	12	201235
2872-E20	E 20	216	577	120	32	12	201242
2872-E24	E 24	219	588	120	38	12	201259



4937

Commercial vehicle cardan shaft striking face wrench

- Especially suitable for all repairs on the go, where no working pit is available
- Enables the usually very tight cardan shaft bolt connection to be removed, even when the space available is limited
- Including laser engraved formula for rapid conversion of the tightening torque specified by the manufacturer
- 2 impact areas enable the force to be applied using a hammer
- Highly stable and extremely resilient
- Length: 215 mm



s 19 mm

s 21 mm

Made in Germany

HAZET No.	Application	mm	EAN-No. 4000896+
4937-19	MERCEDES-BENZ cardan shaft fittings	s 19	215645
4937-21	MAN cardan shaft fittings	s 21	215638



360° clip

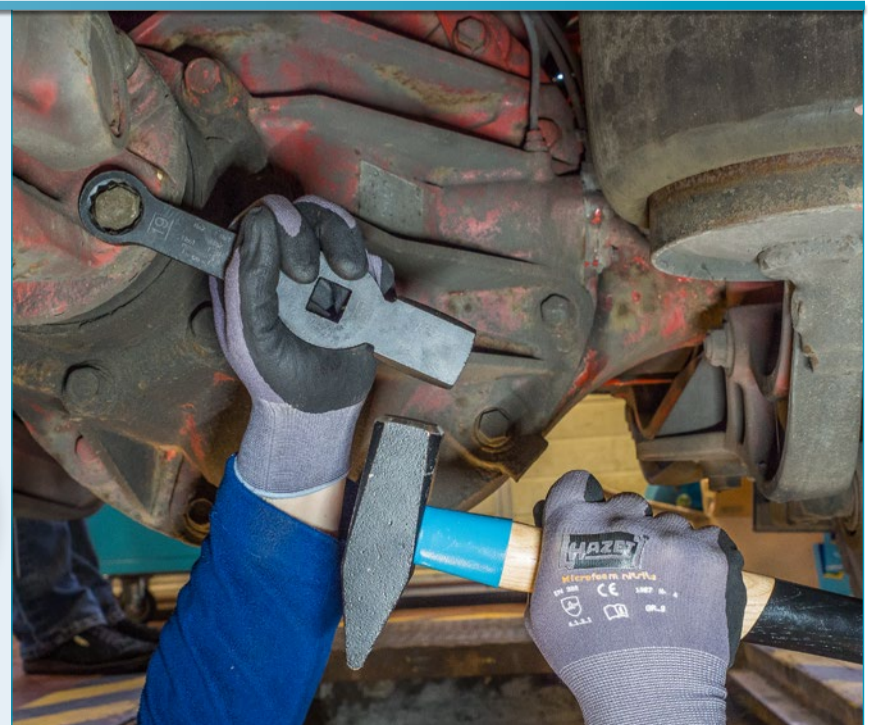

2872 FS-24, EAN-No. 4000896209989

12 1/2

Commercial vehicle box end wrench (12-point) with 2 striking faces

- For loosening or tightening brake cylinder fittings
- Use in trucks, buses, trailers and trailer axles without removing the wheel
- No need to remove the wheel, even if brake cylinder fittings protrude far into the rim
- Laser-engraved formula for rapid conversion of the tightening torque specified by the manufacturer
- 2 impact areas enable the force to be applied using a hammer
- Time saving (approx.): 20 min.
- Highly stable and extremely resilient
- Drive 12 1/2
- Output \varnothing s 24 mm

\varnothing s 24 mm



Brake cylinder disassembly without removing the wheel



YouTube clip

Made in Germany

4969-612, EAN-No. 4000896204281

13

Compressed air quick-connector releasing tool

- Easy loosening of quick-connectors with \varnothing 6, 8, 10, 12 mm
- For operation with open-end \leq 13 mm (HAZET 600 N-13), no further tools necessary
- For plug connectors DIN 74324 6 x 1.0, 8 x 1.0, 10 x 1.0, 12 x 1.5, 12 x 2.0 mm
- Enables separating contaminated tubes and plug connectors
- To be used by one person
- Prevention of injuries
- Time-saving and therefore also cost-saving

No further tools necessary!

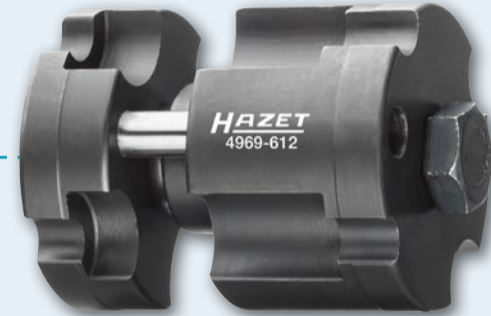

\leq 13 mm



YouTube clip

Made in Germany

2784-14, EAN-No. 4000896155583

20 3/4

Brake calliper screwdriver socket

- For the operation of the brake calliper screws (KNORR-BREMSE) on MERCEDES-BENZ trucks e.g. Actros

\varnothing s 14 mm



Made in Germany



4971-11, EAN-No. 4000896218257

Brake calliper readjusting tool KNORR-BREMSE

- For operation of the readjusting tool on disc brakes KNORR-BREMSE
- For readjusting the brake calliper KNORR-BREMSE via nut-driver
- Special 11 tooth profile
- Suitable for brake callipers KNORR-BREMSE on trucks, buses, trailers and trailer axles of all brands
- Length: 18 mm



s 12 mm

Made in Germany

2784 S Impact socket (special profile) MERCEDES-BENZ

- Optimised special profile for damage-free attachment of the flat-head lightweight nuts
- For the operation of the lightweight nuts on the frame, fifth-wheel coupling, front carrier and vibration damper with special profile MERCEDES-BENZ on the Actros, Antos, Arocs model year 2016 \rightarrow
- Surface: phosphatised
- Output: groove profile



short



long

Made in Germany

HAZET No.	Type	l mm	d mm	EAN-No. 4000896+
2784 S-1	MERCEDES-BENZ special profile, short	46	138	213252
2784 SLg-1	MERCEDES-BENZ special profile, long	75	39	218240

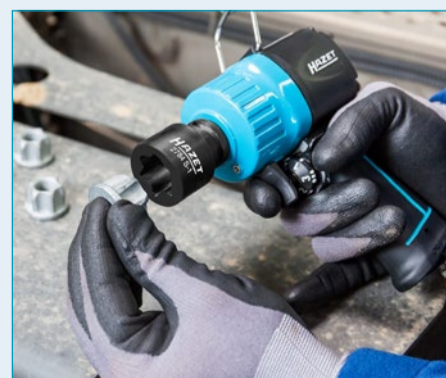

4968-1618, EAN-No. 4000896177684

16

Commercial vehicle ABS reamer

- For cleaning the ABS sensor receptacle e.g. on all MAN trucks
- Blades \varnothing 16 mm on 18 mm
- Functional length: 85 mm



Made in Germany

2784-T60/4, EAN-No. 4000896188611

20 3/4 4

Brake disc screwdriver socket set

- For impact operation
- For the operation of the brake disc screws on MERCEDES-BENZ Actros 2nd generation since model year 2011
- Total length: 120 mm



Made in Germany

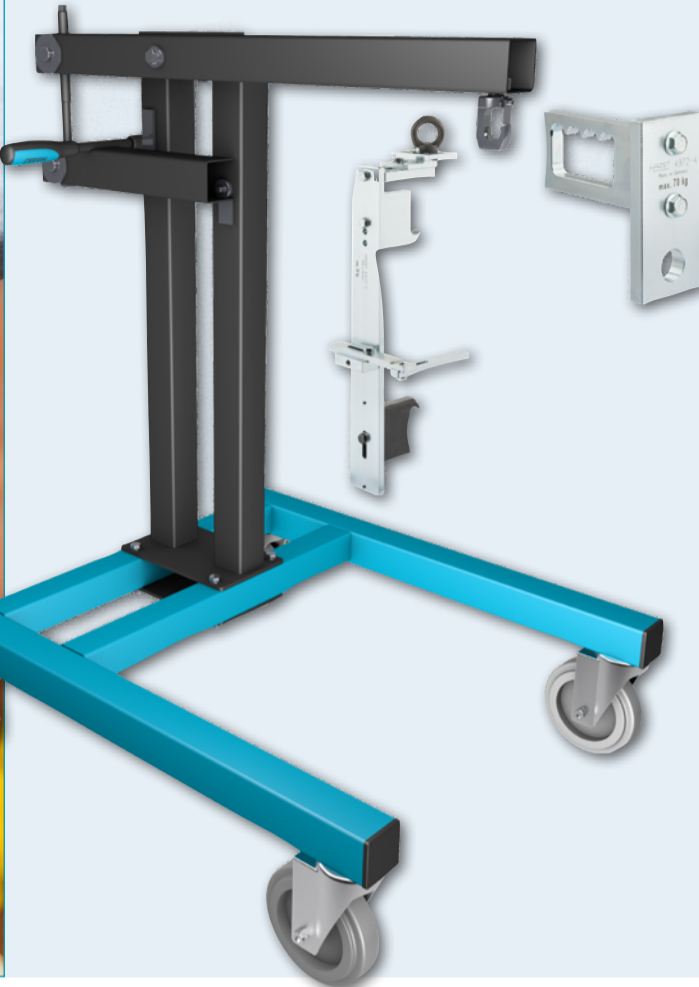

4972-1/3, EAN-No. 4000896215799

Commercial vehicle lifting aid

- Allows you to work safely, without straining your back, in tight spaces in the wheel arch on trucks, buses, trailers and trailer axles
- Significantly easier work when assembling and disassembling brake callipers and wheel hubs thanks to lifting aid
- No strain on the back
- Second person not required
- Makes screw tightening easier
- Secure hold for heavy components
- Easy handling possible
- Takes the various installation situations of the brake calliper into consideration
- Secure hole of the brake calliper/wheel hub in or on the socket
- Secure movement with suspended components
- One-hand operation possible via spindle
- **Contents:**
 - Lifting aid
 - Brake calliper holder
 - Wheel hub retaining tool



YouTube clip

 Made in Germany

4972-2, EAN-No. 4000896215393

Swivel bearing

- For disassembly and assembly of brake callipers in trucks, buses, trailers and trailer axles that are installed in a diagonal "clockwise position between 8 o'clock and 5 o'clock"
- Connect swivel bearing to brake calliper holder and position with e.g. jacking carriage below brake calliper. This enables easy insertion of the screws even in awkward positions
- Together with brake calliper holder HAZET-No. 4972-1



 Made in Germany

With your health in mind!

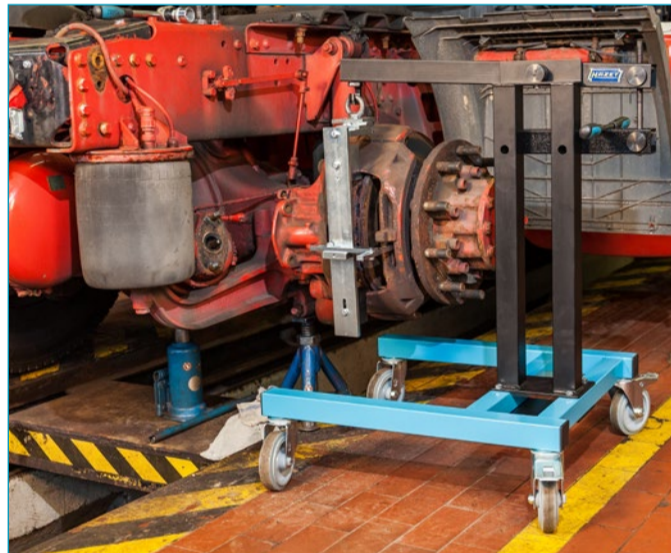

Application example complete with brake calliper holder

4972-1, EAN-No. 4000896215423

Commercial vehicle brake calliper holder

- Secure retention and movement of heavy components e.g. when disassembling and assembling brake callipers and wheel hubs on commercial vehicles
- Allows you to work safely, without straining your back, in tight spaces in the wheel arch on trucks, buses, trailers and trailer axles
- Makes screw tightening easier
- Takes the various installation situations of the brake callipers into consideration
- Easy to use
- Second person not required

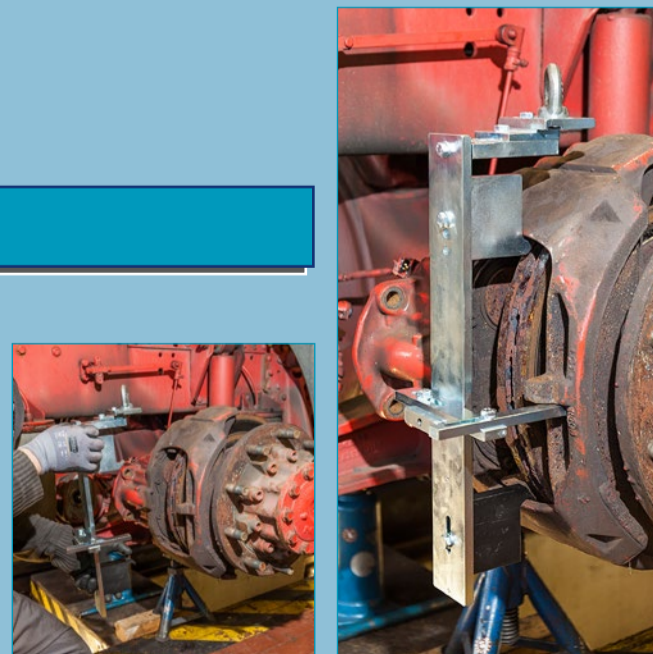

NEW!



YouTube clip

 Made in Germany

Pitstop in record time for your thread repair

- Smooth and effortless maintenance of a defective thread
- Chipless thread restoration
- No replacement of expensive vehicle components through new professional repair option
- Maintenance of components often possible in the installed state
- Extremely practical tool also facilitates work in areas with restricted access (especially with large diameters)
- Strength of the component is retained
- Even the beginning of the thread is shown again without any problems
- Easy manual operation without much physical effort



Your route to repaired axles!

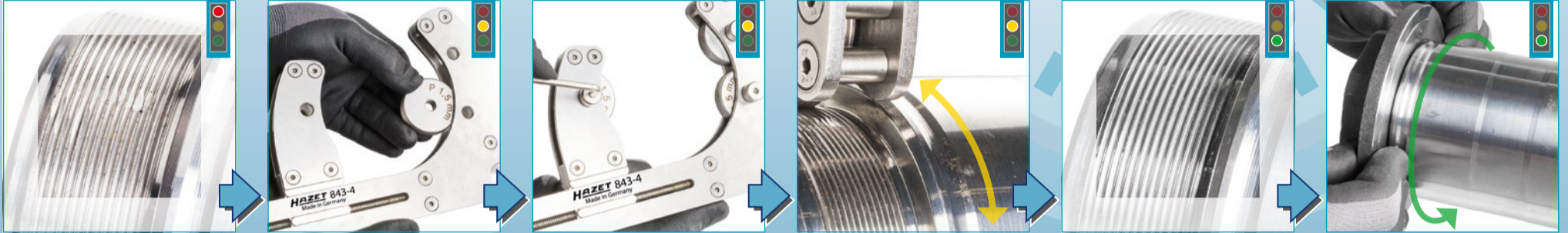

843 Thread-roll sets

843-1/8, EAN-No. 4000896200566

- 1 roller set, 1.25 mm pitch – right-hand thread
- 1 roller set, 1.5 mm pitch – right-hand thread

For threads:
Ø 5–16 mm

Made in Germany



843-4/9, EAN-No. 4000896200535

- 1 roller set, 1.5 mm pitch – right-hand thread
- 1 roller set, 1.5 mm pitch – left-hand thread

For threads:
Ø 50–110 mm

For threads:
Ø 10–36 mm

Made in Germany



YouTube clip

Made in Germany



843-3/9, EAN-No. 4000896200542

- 1 roller set, 1.5 mm pitch – right-hand thread
- 1 roller set, 2.0 mm pitch – right-hand thread

For threads:
Ø 10–60 mm

Made in Germany

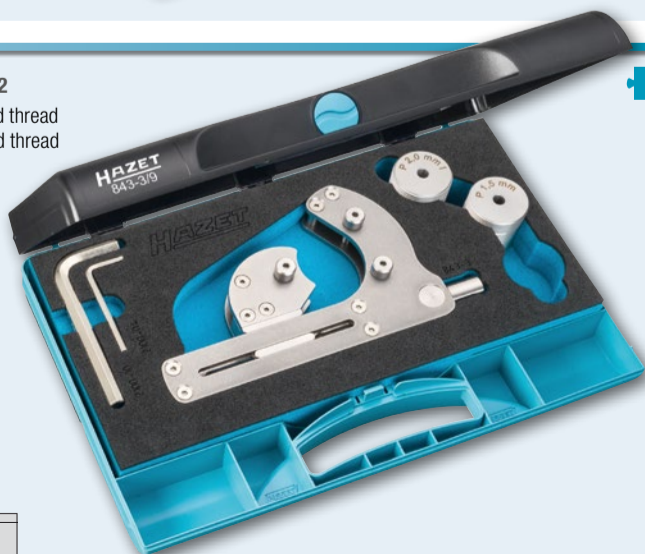

843-420/3, EAN-No. 4000896203970

- Thread-roll set 2 mm pitch, e.g. for BPW bearing journal



Made in Germany

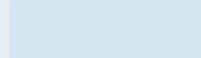



Set tool



Pull out defective bush



Defective bush

NEW!



Set new bush and tool



Push in new bush



Installed bush

4937-2/32, EAN-No. 4000896222957

Tool set for silent blocks

- For reliably pressing slotted silent blocks in and out
- Significant time saving, as no axle parts need to be removed
- **MERCEDES-BENZ** Actros 1, 2, 3 since model year 2002 – Stabiliser bearings
- \varnothing 70 mm: **MAN** TGA, TGS, TGX – Shock absorber bearings
- \varnothing 68 mm: **MAN** (front spring) ROR, **SAF** – Shock absorber bearings
- \varnothing 66 mm: **IVECO** Eurostar – Cab
- \varnothing 65 mm: **MERCEDES-BENZ** Actros 1; Atego 1; Axor 1, 2, 3; Econic 1 – Stabiliser bearings
- \varnothing 63 mm: **DAF**
- \varnothing 60 mm: **MAN** TAG, TGS, TGX – Leaf spring bearings front axle, rear axle; **MERCEDES-BENZ** Actros, Axor – Leaf spring lug; **IVECO** Eurostar – Leaf spring lug; **RENAULT** Kerax, Magnum, Premium – Leaf spring lug
- \varnothing 58 mm: **MERCEDES-BENZ** 3229 B, 652, 650; **Volvo**
- \varnothing 56 mm: **IVECO** Eurostar – Cab
- Pulling in the slotted silent block using the spindle
- Optional use of hydraulic cylinder (e.g. HAZET 4932-17) possible
- Centring the bush during installation ensures safe operations, no more canting when pressing in
- One-man operation

32



YouTube clip

4932-17, EAN-No. 4000896159741

Hollow piston cylinder

- Compact hydraulic cylinder with a capacity of 17 tons
- Working pressure (max.): 700 bar
- **Convenient spring reset**
- For threaded spindle 4932-TR20 and nut 4930-2
- Thread traction side: M27 x 2, alternatively M42 x 2, using the optional adapter
- Pressure side thread: 2 1/4" – 14 UNS
- Inside thread: TR20 alternatively M20 with an optional adapter
- Stroke: 45 mm
- Outside \varnothing : 80 mm
- Cylinder height - retracted: 206 mm / extended: 251 mm
- **Including clutch, protection cap and adapter 4932-M 20**
- Weight: 5.5 kg



Including clutch

**Pushing or pulling
17 tons!**

Made in Germany

4932 N-100, EAN-No. 4000896187195

Hydraulic foot pump, mechanical, two-stage

- Two-stage pressurisation
- With manometer and 1.8 metre hydraulic hose with coupling
- Working pressure (max.): 700 bar
- Overload protection
- Basic steel frame for highest stability
- Pump head and tank made of aluminium
- Transport interlock
- Foot-controlled drain valve, precisely adjustable
- Big pedal
- Piston stroke: 23 mm
- Dimensions (L x W x H): 462 x 160 x 161 mm

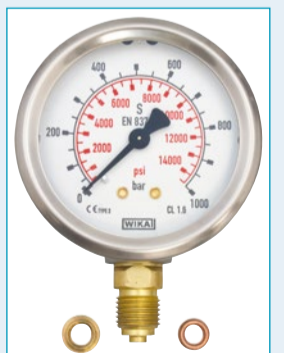

Made in Germany

Your work, your decision!

You decide whether to work by machine or manually!
Our pin and axle nut sockets make both possible.

Our products have extremely high dimensional accuracy, thereby permitted high power transmission.

Multiple applications with special wrenches.

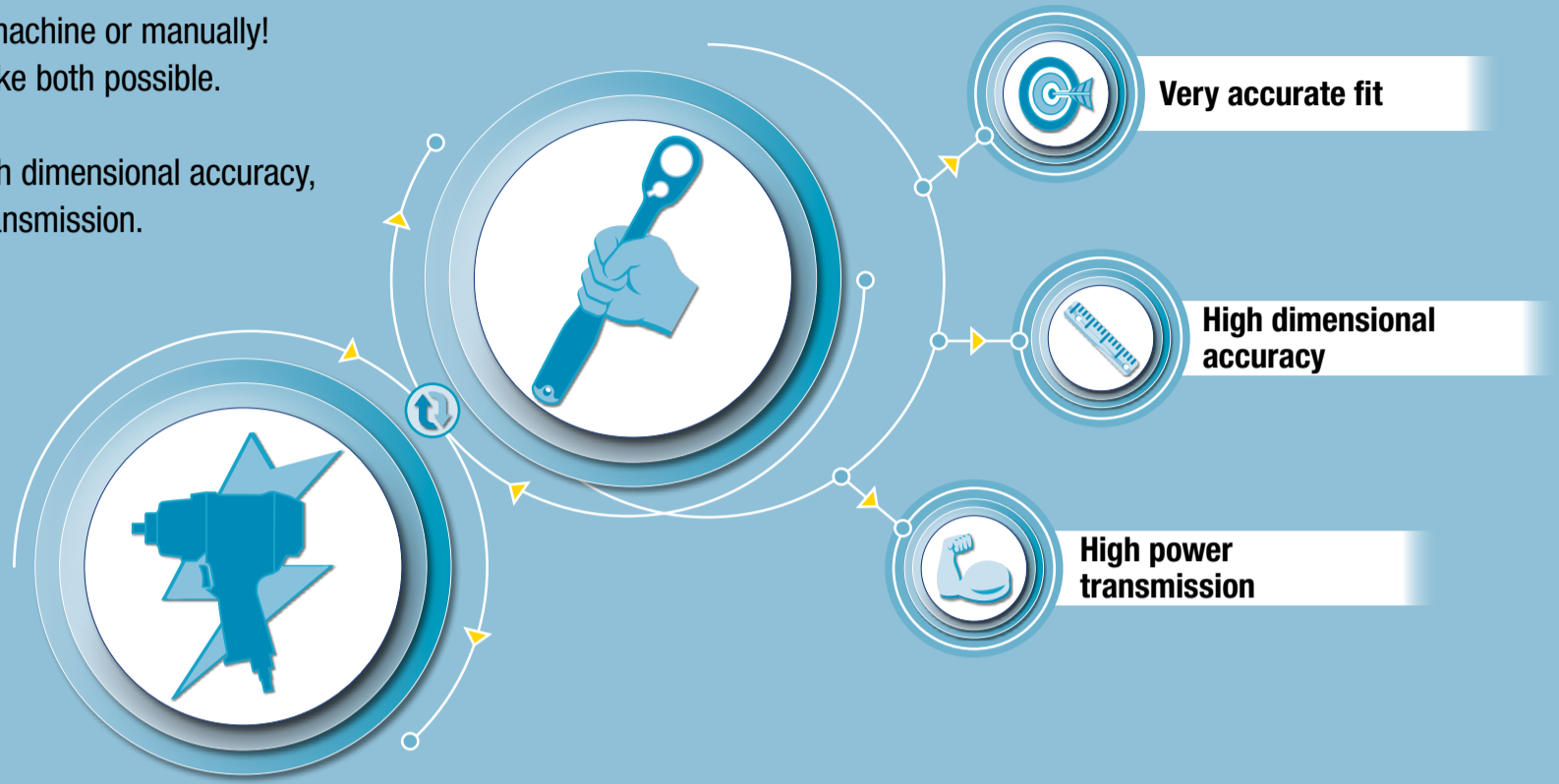

4937-101/4, EAN-No. 4000896199266

Commercial vehicle pin wrench set for rear axle MERCEDES-BENZ

- For dismantling / assembly work on the rear axle as well as repair and maintenance work on the wheel hub, wheel bearing or brake disc
- **MERCEDES-BENZ** hub-reduction axle, such as trailing axle NR7/4
- **MERCEDES-BENZ** hub-reduction rear axles (Euro-axles) 10 t and 13 t
- **MERCEDES-BENZ** hub-reduction axle 7 t AL7/1
- Inside \varnothing : 101.5 mm
- Length including guide tube (total): 140 mm
- 12 pins, width of pins: 11.4 mm
- With 3 replaceable guide tubes
- Outside \varnothing : 50, 51, 53 mm
- Length (total): 85 mm



20 3/4 4

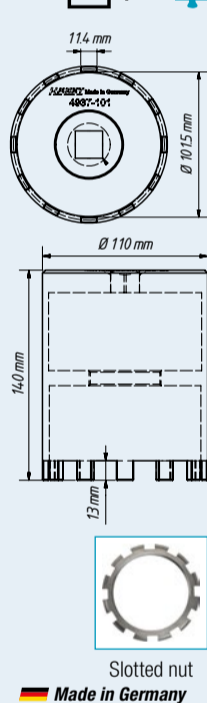

Slotted nut
Made in Germany

4937-62, EAN-No. 4000896199020

Commercial vehicle pin wrench for rear axle MERCEDES-BENZ

- Pin wrench for rear axle nuts
- **MERCEDES-BENZ** Actros, Atego (heavy design): LN2, SK rear axle
- With outside guide collar
- Inside \varnothing : 62.8/70 mm
- 6 inside pins, width of pins: 7.5 mm
- Length (total): 85 mm



Made in Germany

Slotted nut

4937-80, EAN-No. 4000896199006

Commercial vehicle axle nut socket, 8-point, s 80 mm

- For dismantling/assembling the front axle nut with 8-point in front of the brake disc
- **SCANIA** series R, series 4, series 124 I – 144 I – etc.
- Suitable for impact wrench, e.g. HAZET 9013 M
- Precise fit
- Parallel surfaces for perfect force fit on axle nuts
- Solid design: high (shape) stability even with very high loosening or tightening torques



Made in Germany

Axle nut

4937-103/3, EAN-No. 4000896199259

Commercial vehicle pin wrench set for rear axle MAN and MERCEDES-BENZ

- For repair and maintenance works on the wheel hub, wheel bearing or brake disc
- For **MAN** and **MERCEDES-BENZ** 10 t and 13 t AP Hypoid and trailing axle N7/4, Omnibus 0305G, 0405G
- **MAN** hub-reduction rear axle F series H7, HD7
- Hypoid rear axle F series HY-1175, HDY-1175
- Inside \varnothing : 103 mm
- Length including guide tube (total): 140 mm
- 6 pins, width of pins: 11.5 mm
- With 2 replaceable guide tubes
- Outside \varnothing : 51.5 mm, 66.5 mm
- Length (total): 135 mm



20 3/4 3

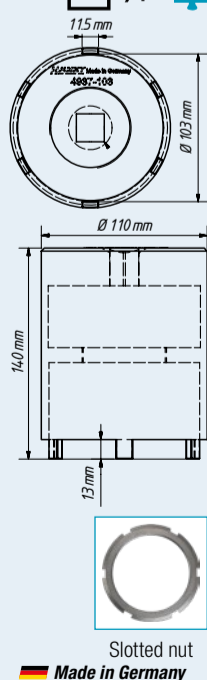

Slotted nut
Made in Germany

4937-117/2, EAN-No. 4000896199242

Commercial vehicle pin wrench set for rear axle MERCEDES-BENZ

- For repair and maintenance works in the rear axle area
- For **MERCEDES-BENZ** Actros, Hypoid rear axle HL, HL 8
- Inside \varnothing : 117 mm
- Length including guide tube (total): 200 mm
- 6 pins, width of pins: 9.8 mm
- With guide tube
- Outside \varnothing : 60 mm
- Length (total): 185 mm



Slotted nut
Made in Germany

4937-7588, EAN-No. 4000896202003

Commercial vehicle mounting sleeve SAF – thread M75 x 1.5 right/left

- The sleeve has both a left-hand and a right-hand thread M75 x 1.5
- For **SAF** axles with disc and drum brakes with \varnothing 88 mm bearing seat
- Only lift the approx. 40 kg bearing unit (bearing + brake disc + wheel hub) onto the mounting sleeve once, then push up to the bearing seat with \varnothing 88 mm
- Outside \varnothing : 88 mm
- Drive via lateral rod or without additional tools is possible (handle surface)

Made in Germany



4937-100, EAN-No. 4000896201983

MAN commercial vehicle mounting sleeve – thread M100 x 1.5

- Mounting sleeve to protect the thread on the axle during bearing disassembly and assembly
- Use with **MAN** TGX, TGA, TGS e.g. for **MAN** HY 1350 axle (13 t)
- Only lift the approx. 40 kg bearing unit (bearing + brake disc + wheel hub) onto the mounting sleeve once, then push up to the bearing seat with \varnothing 105 mm
- Thread: M100 x 1.5
- Outside \varnothing : 105 mm
- Drive via lateral rod or without additional tools (chequered handle surface) is possible

Made in Germany



4937-7582, EAN-No. 4000896201969

MAN commercial vehicle mounting sleeve – thread M75 x 1.5

- Mounting sleeve to protect the thread on the axle during bearing disassembly and assembly
- Use with **MAN** TGL, TGM, L series, HL 2
- Only lift the approx. 40 kg bearing unit (bearing + brake disc + wheel hub) onto the mounting sleeve once, then push up to the bearing seat with \varnothing 82 mm
- Thread: M75 x 1.5
- Outside \varnothing : 82 mm
- Drive via lateral rod or without additional tools is possible (chequered handle surface)

Made in Germany



4937-111/2, EAN-No. 4000896201945

MAN commercial vehicle pin wrench set for rear axle

- For **MAN** TGX, TGA, TGS e.g. rear axle: HY 1350
- 4-point drive: 25 mm = 1" as well as outside 6-point: s 60 mm
- 6 pins, width: 11 mm
- Inside \varnothing : 134.5 mm
- Inside \varnothing (pin-pin): 118 mm
- Outside \varnothing : 148.5 mm

Made in Germany

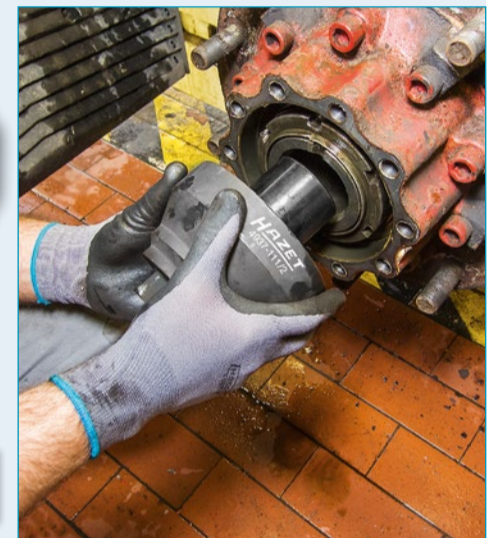
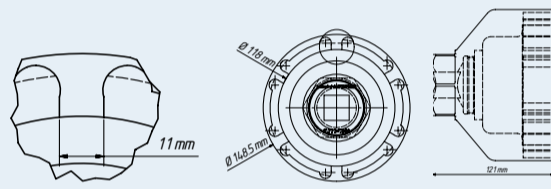

25 1" 60 2

4937-7578, EAN-No. 4000896201990

MERCEDES-BENZ commercial vehicle mounting sleeve – thread M75 x 1.5

- Mounting sleeve to protect the thread on the axle during bearing disassembly and assembly
- Use in **MERCEDES-BENZ** Atego, Atego 2, Tourino
- Only lift the approx. 40 kg bearing unit (bearing + brake disc + wheel hub) onto the mounting sleeve once, then push up to the bearing seat with \varnothing 78 mm
- Thread: M75 x 1.5
- Outside \varnothing : 78 mm
- Drive via lateral rod or without additional tools is possible (chequered handle surface)

Made in Germany



4937-110/4937-120

Commercial vehicle hub cap socket, \varnothing 110 mm and 120 mm for flat oval BPW hub cap

- For **BPW** Eco and Eco Plus axles
- Perfect fit for **BPW** contour \varnothing 110 mm, or \varnothing 120 mm

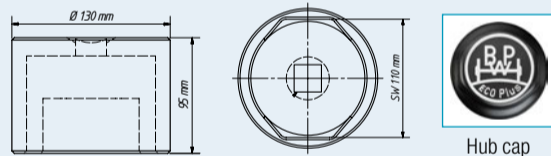

Made in Germany

HAZET No.	Drive	l mm	EAN-No. 4000896+
4937-110	25 1"	110	199273
4937-120	25 3/4"	141	210459



25 1" 20 3/4"

4937

Commercial vehicle axle nut sockets

20 3/4" 36



Made in Germany

HAZET No.	Drive	Output s mm	Application	EAN-No. 4000896+
4937-S80	s 36	80	DAF CF and XF series	206889
4937-85	● s 36	85	SAF trailer axles	204267
4937-90	s 36	90	IVECO Daily 6.5 t; 7.0 t	199280
4937-95	20 3/4"	95	IVECO Stralis and Eurofire, MERCEDES-BENZ Discos-Trailer, BPW Eco plus	199457

4937-92, EAN-No. 4000896201952

Commercial vehicle pin wrench for front axle MAN

- Pin wrench for: **MAN** trucks: E 2000 (ÖAF), F 2000, M 2000 L, M 2000 M
- **MAN** TGA, TGM, TGS, TGX
- **MAN** buses: Lions City, Lions Classic, Lions Coach, Lions Regio, Lions Star as well as older constructions (models), chassis cabs
- **NEOPLAN** Cityliner, Starliner, Tourliner, Trendliner
- **TEMSA** Diamond, **VISEON** high-decker
- Drive: 20 3/4"
- Diameter: 114 mm

Made in Germany



20 3/4"

4937-105/2, EAN-No. 4000896201938

Commercial vehicle axle nut socket set DAF, RENAULT, Volvo

- 6-point output: s 105 mm
- Drive: 25 mm = 1" and outside 6-point s 60 mm
- Screw-in guide tube allows for flexible application
- **DAF** with guide tube
- **RENAULT, Volvo** without guide tube
- With outside guide collar

3 applications – 1 wrench!

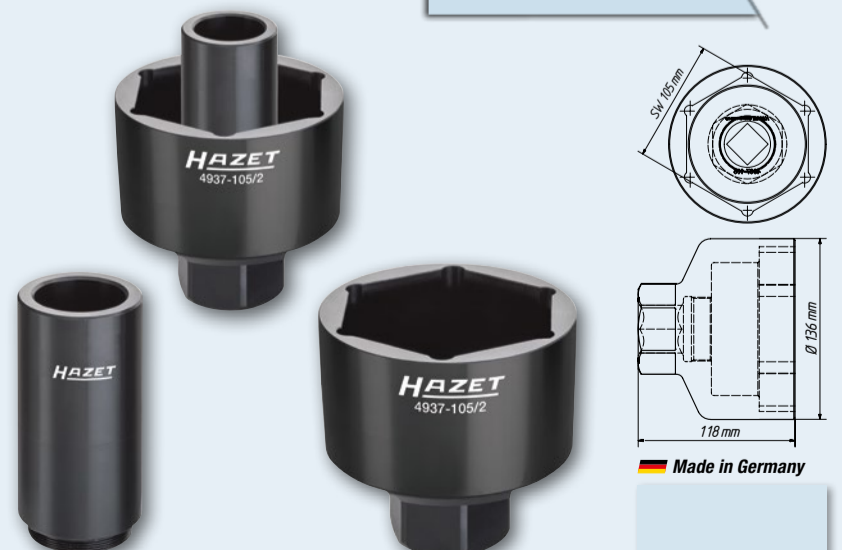

25 1" 60 2

4937-87/3, EAN-No. 4000896199235

20 3/4" 3

Commercial vehicle pin wrench set for MAN, MERCEDES-BENZ

- For repair and maintenance works on the wheel hub, wheel bearing or brake disc
- For e.g. **MAN** TGL front axle since 2000 and L 2000 **MERCEDES-BENZ** Atego rear axle HL2, 814 Vitaro
- Pin wrench for rear axle, inside \varnothing : 87 mm
- Length (total): 65 mm
- 6 pins, width of pins: 10 mm
- With 2 replaceable guide tubes
- Outside \varnothing : 49 mm, 57 mm
- Length including guide tube (total): 140 mm

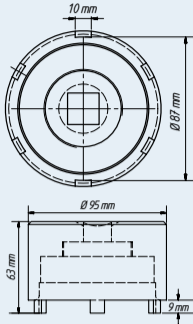

Slotted nut

Made in Germany



772-2/16, EAN-No. 4000896161041

20 3/4" 16

Universal axle and slotted nut wrench set

- For removal and precise installation, e.g. with 6-point and 8-point nuts, slotted nuts, face nuts, round nuts with drilled holes, round nuts with pin holes, etc.
- Clamping range: 35–170 mm
- Torque (max.): 700 Nm
- \square drive 20 = 3/4"
- 16-pieces in HAZET Safety-Insert-System soft foam insert

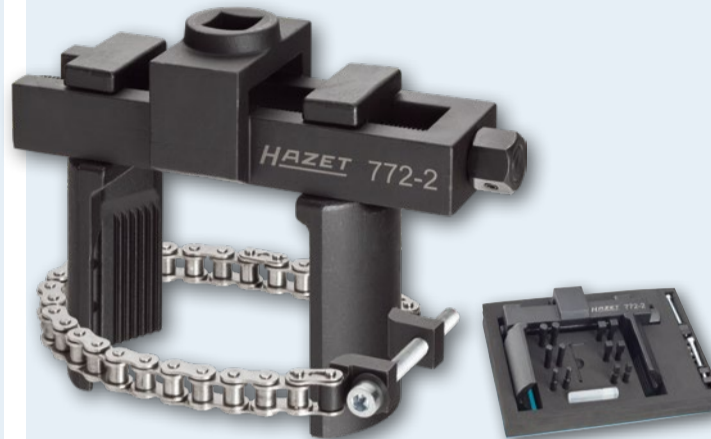
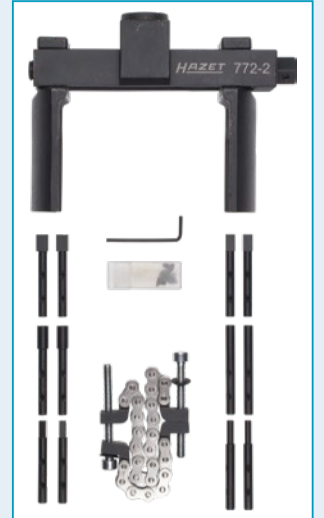

4937-1/4, EAN-No. 4000896219056

4

Twin tyres, separating tool

- Easy separation of hard-to-access outside twin tyres
- Suitable for axles with disk and drum brakes
- Hand operated tool, low use of force
- Suitable for tractors, buses, trailers and trailer axles
- Operating principle:
 - Insert thrust blocks through rim holes with a spindle
 - Spindle applies required force and disconnects outside twin tyres from the hub
- Contents (4-piece set):
 - 1 rim flange support with spindle mount (ball), \varnothing 44 mm
 - 1 spindle M24 x 2.0 with 6-point drive s 17 mm
 - 1 thrust block size 1 \varnothing 48 x 40 mm
 - 1 thrust block size 2 \varnothing 50 mm



NEW!



Place the rim flange support on the socket at the end of the spindle



Select one of the two thrust blocks (abutment) depending on the rim's construction type and screw it onto the spindle

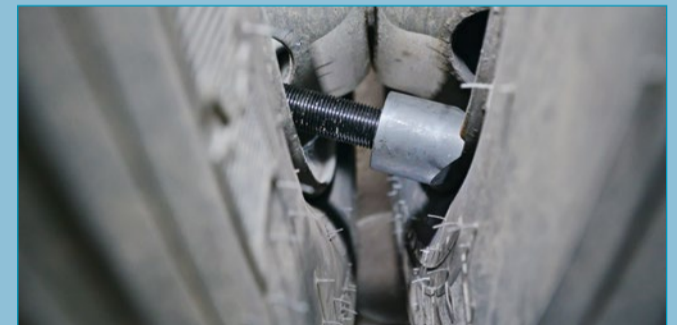

Place the unit in a rim hole. Attention: The rim flange support groove must fit perfectly onto the rim flange of the rear rim

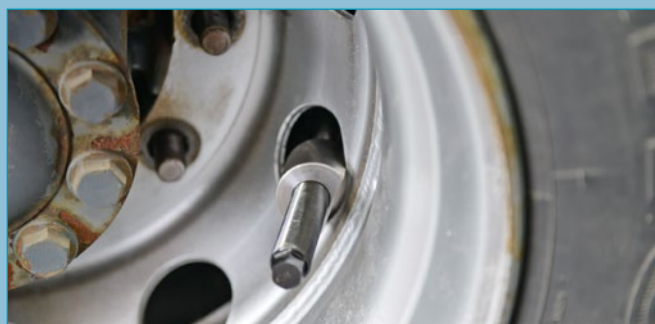

Now operate the spindle until the thrust block (abutment) lies against the inside of the rim hole



Rotate the spindle drive size 17 until the outside rim disengages from the inner rim

Further information can be found at www.hazet.de or in our application video on YouTube



YouTube clip

1790 Ball joint puller

- For trucks, busses and building machinery
- For the easy extraction of ball joint pivots and safe removal of ball joints
- Supported by hydraulic system
- Load (max.): 12 t



Made in Germany

HAZET No.	a mm	sb mm	EAN-No. 4000896+
1790-5	30-34	70	145461
1790-6	36-40	85	145478

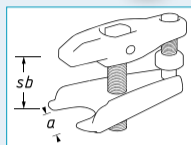

4961 N-23/12, EAN-No. 4000896186754 Wheel hub grinder

- For optimal cleaning of wheel hubs and brake discs
- Hook and loop fastener for quick changing of grinding wheels
- With 6-point socket for firm hold at the device
- **8-point profile** for safe and firm fixation
- Inside Ø (max.): 23 mm
- Grinding wheels Ø: 56 mm

For stud bolts! No wheel hub chippings!



720 S, EAN-No. 4000896029532 Four-way rim wrench

- Forged central piece

Tested up to 2000 Nm!

Made in Germany

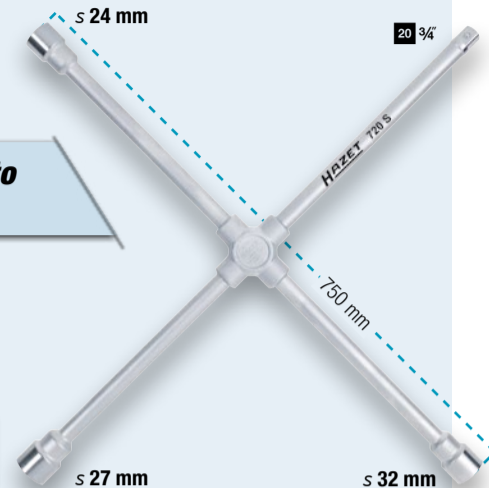

1779-3, EAN-No. 4000896135998 Universal ball joint puller

- Universal application e.g. for trucks, lightweight design
- Jaw opening a: 32 mm
- Clamping range sb: 85 mm

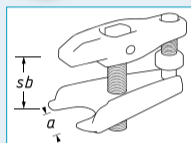

Made in Germany

652/653 Tyre lever

- Heavy design

Made in Germany

HAZET No.	l mm	EAN-No. 4000896+
652	600	028702
653	456	028719



4937-26/3, 4937-27/3 Commercial vehicle centring sleeve set

- For fast assembly of centred truck drop centre rim wheels for rim hole Ø 26 mm
- No damage of the thread as well as exact centring of the rims through conically cranked sleeves



Made in Germany

HAZET No.	For rim hole Ø 26 mm	EAN-No. 4000896+
4937-26/3	M22 x 1.5 e.g.: DAF, FORD, MAN, MERCEDES-BENZ, RENAULT, Volvo	199013
4937-27/3	7/8"-11G e.g. SCANIA	202010

668-2, EAN-No. 4000896204830 Commercial vehicle sensor assembly tool for Conti Pressure Check (CPC)

- Very easy application, very fast assembly, just a few seconds per sensor
- For quick, precise and above all damage-free work on trucks, buses, construction and agricultural machinery
- Exact positioning of the sensor in the rubber container
- If a tyre has to be replaced due to damage or wear, only a new, cheap rubber container is glued in the new tyres. The valuable available sensor is now simply inserted again with the HAZET No. 668-2 sensor tool

Sensor assembly in 5 seconds!



Not included

Made in Germany

1790-3, EAN-No. 4000896145454 Ball joint puller

- For extracting the ball joint pivots of steering arms, steering tie rods, stabilisers
- Jaw opening a: 40 mm
- Clamping range sb: 85 mm

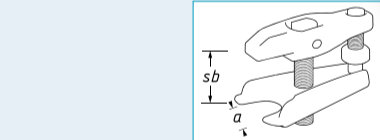

Made in Germany

1779-55, EAN-No. 4000896136407 Ball joint puller

- For removing the ball joint pivots of steering tie rods, stabilisers, etc.
- Jaw opening a: 55 mm
- Clamping depth sf: 80 mm
- Width b: 77 mm
- For e.g. commercial vehicles MAN, MERCEDES-BENZ, etc.

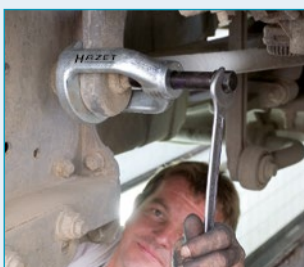

Made in Germany

Special steel, galvanised

1004 S Impact socket (6-point)

- DIN 3129, ISO 2725-1
- Wrench size: 32 mm

1004 S-32 20 3/4"

- Especially long 6-point nut-driver design e.g. for deep wheel nuts and bolts on commercial vehicles
- For impact operation
- Surface: phosphatised

1004 S-33 20 3/4"

- Extra long design
- E.g. for deeply located wheel nuts and bolts on commercial vehicles
- With borehole for locking pin or safety spring and groove for o-ring
- DIN 3129, ISO 2725-2

1104 S-32 25 1"

- For impact operation
- With bolt for locking pin retaining
- Surface: phosphatised



Made in Germany

HAZET No.	Wrench size	l mm	d ₁ mm	d ₂ mm	f mm	EAN-No. 4000896+
1004 S-32	20 3/4"	400	48.0	44.0	32.0	055784
1004 S-33	20 3/4"	400	48.0	44.0	32.0	055791
1104 S-32	25 1"	270	48.5	54.0	30.5	002665

Your fast and innovative problem solver!

Thanks to our in-house engineering and development facility in plant 1 in Remscheid, our products are not just innovative, they feature HAZET-like dimensional accuracy and extreme precision.

This guarantees very high power transmission, which in turn permits a fast repair.

In addition, our products are matched specifically to the application concerned, generally making operations much easier.

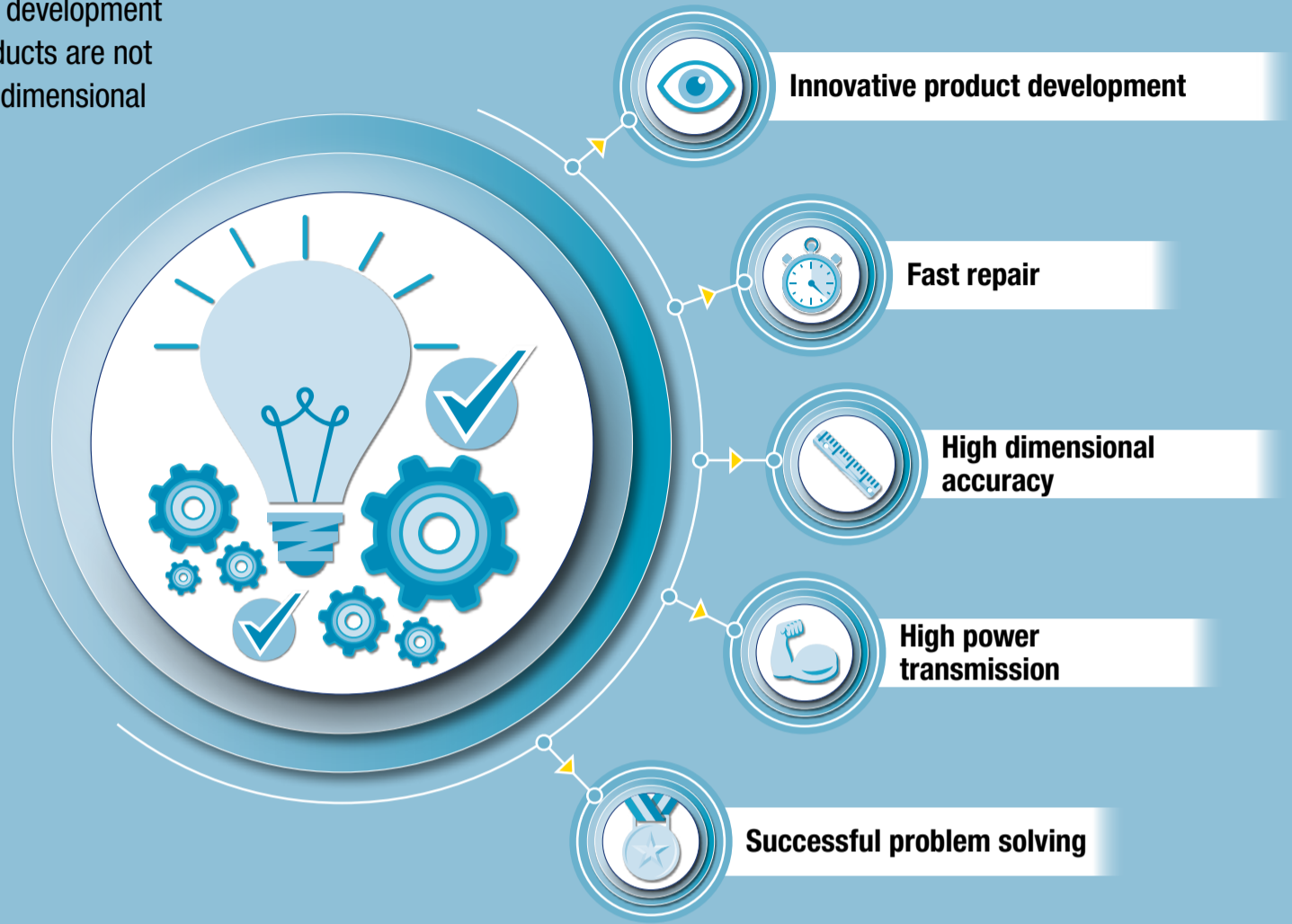

4550-21, EAN-No. 4000896204137 12⁵ 1/2 Injection line wrench DAF

- The special design of the socket ensures proper seat of the injection line fitting
- **Application:**
For the operation of the union nut on the high-pressure line on the injection valve-common rail injection system
- Open 12-point socket for the operation of screwed connections on injection lines
- The tightening torque required by the manufacturer is achieved by using a HAZET torque wrench (observe manufacturer specifications)
- **DAF** Euro 6 engines MX11/MX13 e.g. XF, CF
- Surface: burnished

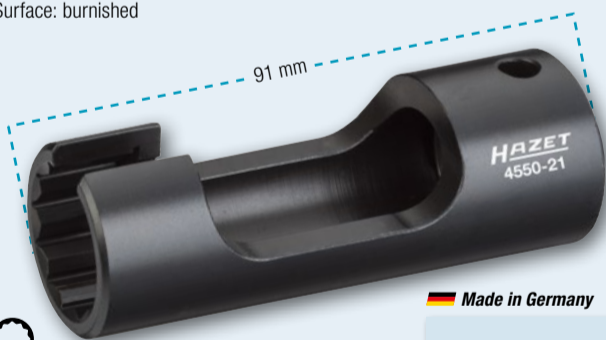

21 mm

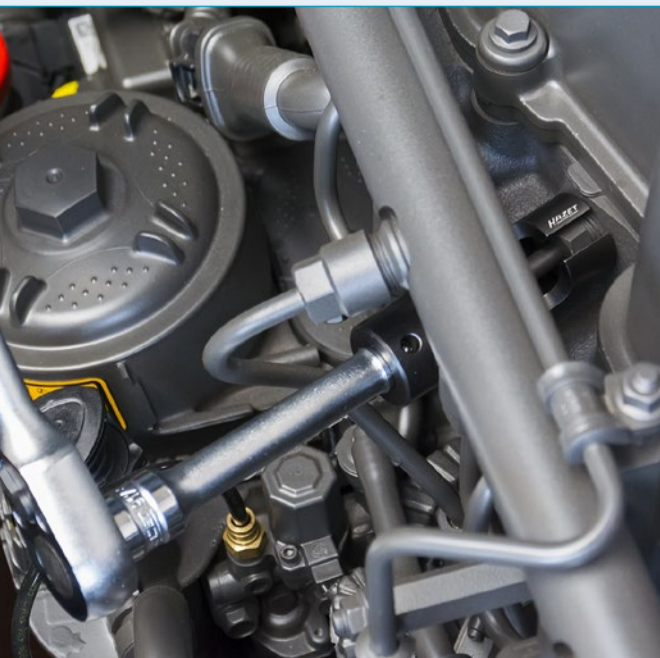

4550-3, EAN-No. 4000896104307 10 3/8 Injection line wrench

- Open 12-point socket for the operation of screwed connections on injection lines
- For the operation of screwed connections on injection lines of **MAN** trucks with D 20 engines – Common Rail injection systems



Made in Germany

2849-15, EAN-No. 4000896159284 2K System Turbo charger wrench

- Loosen and tighten turbocharger nuts on **MAN** trucks
- Bent form of the box-end wrench is especially adapted to the confined spaces

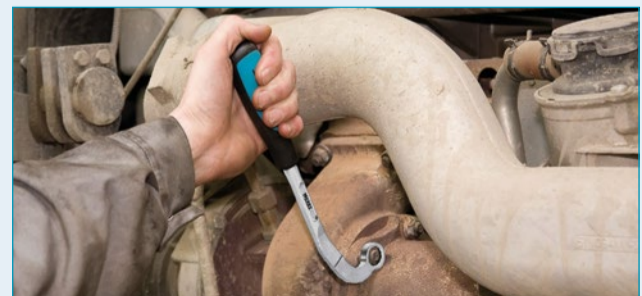

Made in Germany

2871 E-12, EAN-No. 4000896201730 17 Turbocharger/manifold TORX® socket

- For operating the turbocharger and manifold screws on **MAN** TGL, TGM with E08 engines
- Operation e.g. with ratcheting combination wrench 606-17 or insert box-end wrench 6630 d-17 and tool holder 6397 (screw loosening) with torque wrench 6292-1 CT (screw tightening)



Made in Germany

4558, 4558-1, 4558-2 12⁵ 1/2 32 Pressure nut pin wrench

- For the operation of the compression nut at the nozzle holder



Made in Germany

HAZET No.	l mm	EAN-No. 4000896+
4558	72	021888
4558-1	120	050529
4558-2	68	057344

4501-2, EAN-No. 4000896203499

Fuel line pliers

- Simple operation of quick-release catches
- For e.g. **Volvo** D13, D16; **Scania**, **MAN** D3876 LF, D1556 LF, D2676 LF; etc.
- Ergonomically shaped HAZET 2-component plastic handle covers (blue/black)
- Straight design
- Length: 235 mm

NEW!



Made in Germany

4798-8/8, EAN-No. 4000896210749

Injector removal tool

- The 12 t hydraulic cylinder enables simplified loosening of very tight injectors
- Huge time saving since the engine does not have to be removed to disassemble the injectors
- For **MERCEDES-BENZ** Vito, CLK, Sprinter, Viano, Vario, 2.1 l · 2.2 l · 3.0 l V6 (CDI 2.1 l · 2.2 l Delphi, CDI 3.0 l V6 Bosch)
- In SmartCase (1/3) 165-L



798-13, EAN-No. 4000896155248

Hose clamp pliers

- For use in areas with restricted access where the clamp cannot be reached straight forwardly
- Application: For the operation of spring band hose clamps whose three ends fit tightly on the hose, e.g. on tank aeration lines and fuel lines
- Length: 192 mm
- Clamping range: 27 mm

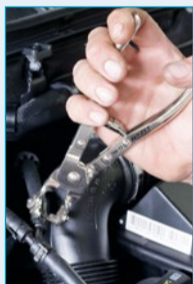

Made in Germany

798-5, EAN-No. 4000896031955

Hose clamp pliers

- Application: For spring band hose clamps
- Rotating jaws – for areas with restricted access
- Length: 210 mm
- Clamping range: 6–40 mm



Made in Germany

1788 T-1, EAN-No. 4000896134304

Sliding hammer

- With coupler thread M10 (sliding weight 200 g)
- Together with injector extractor 4797-5

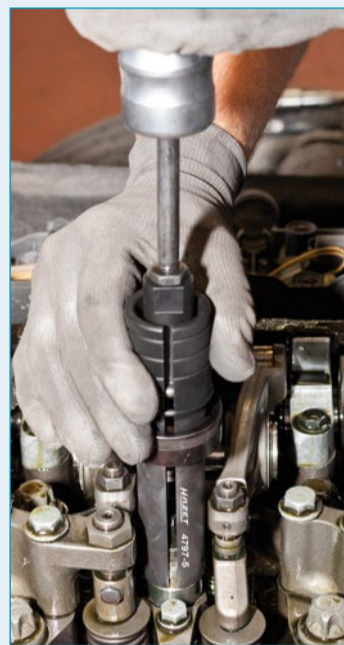

Made in Germany

4797-5, EAN-No. 4000896176137

Injector extractor

- For disassembly of tight common rail injectors without removing the cylinder head
- For the simple removal of injectors together with sliding hammers, e.g. HAZET 1788 T-1, on **MAN** engines D08, D20, D26 and D28
- Especially suited to the very limited space in the cylinder head
- Due to the tool's special claw, the injector may be seized with caution, damage-free removal with the aid of the impact extractor
- Injector claw with inside thread M10 x 1.5 mm for easy insertion of the impact extractor



Made in Germany

Can only be used in combination with 1788 T-1!

Taper key ejector

- For the safe and simple stripping of taper keys on agricultural machinery
- Suitable for quick stripping of taper keys out of the sprocket
- For the manual operation of input shafts on agricultural attachments

4685-1, EAN-No. 4000896222889



Made in Germany

4685-2, EAN-No. 4000896222896



Made in Germany

NEW!



2168-1, EAN-No. 4000896223251

12⁵ 1/2"

Fuel filter wrench

- For simple loosening and tightening with fitted 12.5 mm = 1/2" 4-point
- For e.g.: **CLAAS** Torion, **LIEBHERR** wheel loaders and wheel loaders with Euro 6 emission standard and **LIEBHERR** engines



Made in Germany



NEW!



2169-36, EAN-No. 4000896086566

10 3/8"

Oil filter wrench

- □ drive 10 = 3/8"
- Forged design
- Surface: chrome-plated
- For **MERCEDES-BENZ** van, Actros MP 1, MP 2
- For fuel filters **MAN** e.g. TGA



≤ 36 mm, 6-point

10 3/8"

Made in Germany



YouTube clip



2169-9, EAN-No. 4000896116690

12⁵ 1/2" 

Commercial vehicle oil filter wrench

- For the operation of oil filters e.g. from **MANN** and **MAHLE/KNECHT**
- For e.g.: **Volvo**, **SCANIA**, **RENAULT**, **MAN**, **IVECO**, **FIAT**, **FODEN**, **IRISBUS**, **ASTRA**, **CATERPILLAR**, **LIEBHERR**, **JOHN DEERE**, **KOMATSU**, **FAUN**, **MITSUBISHI**
- The torque value recommended by the vehicle manufacturer can be reliably achieved, e.g. with a HAZET torque wrench (Attention: observe the manufacturer's tightening torque values)

≤ 105 mm, 15-point



12⁵ 1/2" 

≤ 24 mm

For over 1600 applications, the all-rounder among oil filter wrenches!

Made in Germany

2195, EAN-No. 4000896014101

12⁵ 1/2"

Cartridge wrench

- For loosening the granulates cartridges
- Forged design
- **MAN** No. 8099606-0307



90 – 140 mm

Made in Germany



2168-46, EAN-No. 4000896156252

10 3/8"

AdBlue® filter wrench MERCEDES-BENZ

- For the operation of the filter housing cap when replacing the **AdBlue®** filter (urea solution filter) on **MERCEDES-BENZ** commercial vehicles with **BlueTec®** engines e.g. Actros, Atego, Axor, Econic
- The tightening torque recommended by the vehicle manufacturer (please follow the instructions of the manufacturer) is reached e.g. with the torque wrench HAZET 6110-1 CT
- Forged design

≤ 59 mm, 6-point



10 3/8"

Made in Germany

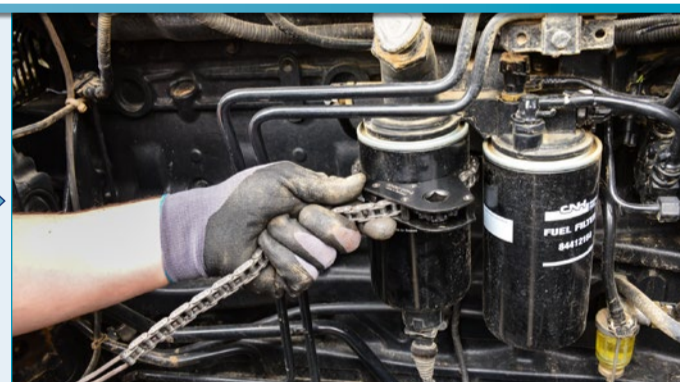
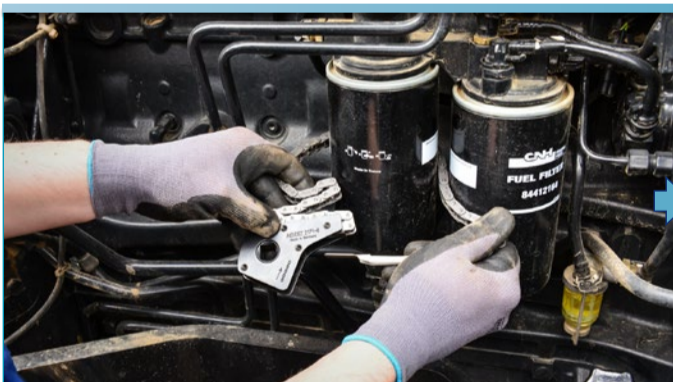

2171-8 LG, EAN-No. 4000896203703

12⁵ 1/2"

Commercial vehicle oil filter chain, open

- Clamping range 50–150 mm
- For removing oil filters and the operation of air dryer cartridges
- Especially suited to limited space
- The opening in the oil filter chain wrench facilitates application even in places which cannot be reached from above with an operating tool due to the construction

open



closed

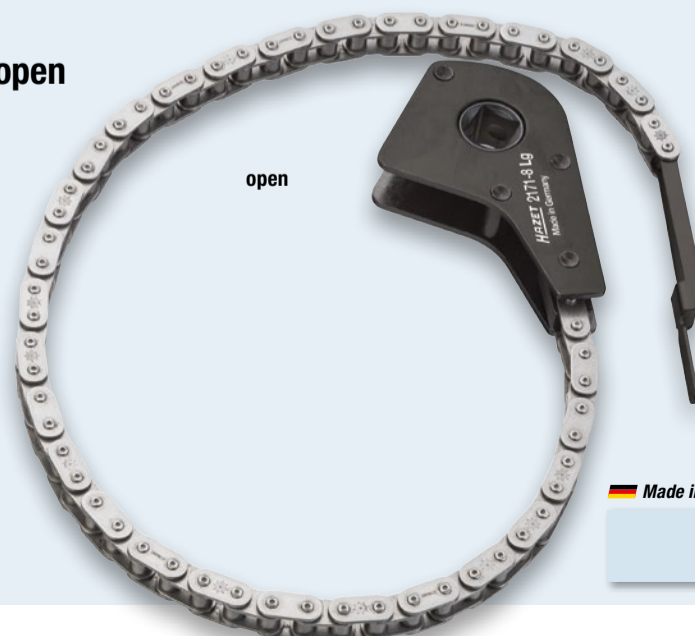

Made in Germany

2169-32, EAN-No. 4000896082346

10 3/8"

MAN AdBlue® filter wrench

- □ drive 10 = 3/8"
- For installing and removing oil filters and oil filter housing caps when changing the oil filter element
- Forged design
- For urea solution filter Ad-Blue® **MAN** e.g. TGX

≤ 32 mm, 6-point



10 3/8"

Made in Germany

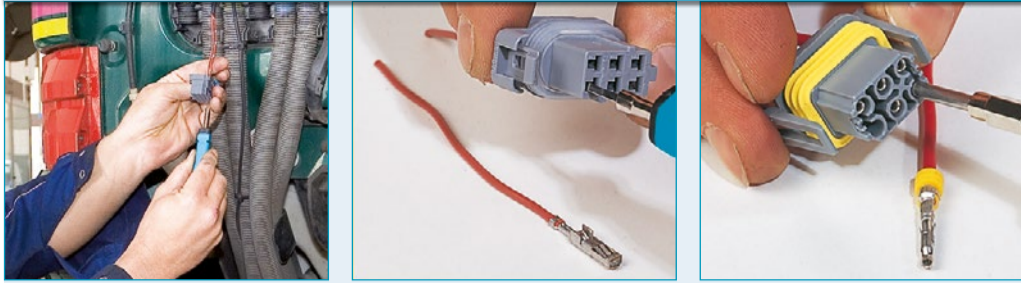

4670-9/5, EAN-No. 4000896205042

5

Commercial vehicle system cable release tool assortment

- Guarantees damage-free release of the most common commercial vehicle contacts
- For damage-free release of flat plug contacts
- Malfunctions due to loose contacts can be remedied easily, quickly and professionally
- With sliding caps protecting the blades from damage and avoiding the risk of injury
- OEM quality – "Made in Germany"



Made in Germany

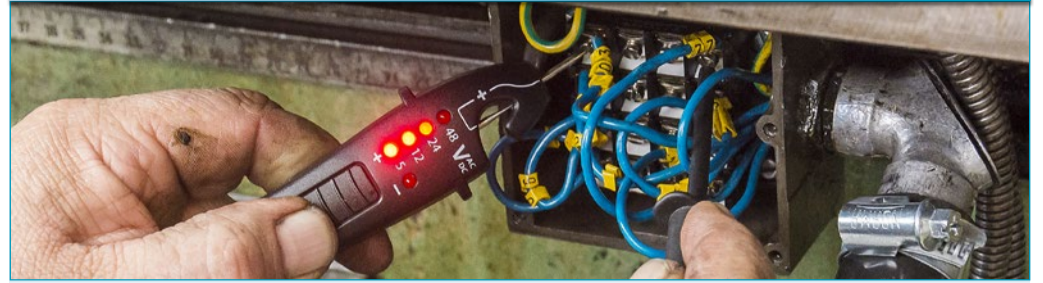

2152N/3, EAN-No. 4000896204151

3

Electronic set

- For troubleshooting on electronic components
- Measuring range 3–48 V
- Voltage display LED: 5, 12, 24, 48 V
- Polarity display: LED for positive or negative, AC voltage with illuminated LED
- Additional crocodile clip and probe tip for attaching
- Cable length: 1300 mm
- Probe tip, needle with sliding mechanism



1862, EAN-No. 4000896007301

Automatic wire stripper

- For PVC-insulated solid and flexible cables, conductor cross-section 0.5 up to 4 mm²
- Automatic adjustment to the conductor's cross-section, easy application
- Integrated diagonal cutter for wire cutting
- Length: 180 mm



Made in Germany

4650-4, EAN-No. 4000896022038

Battery pole and terminal brush

- Application: Cleaning the terminals and clamps



Made in Germany

4650-3, EAN-No. 4000896102051

Special tool for battery plugs

- Special length allows universal application in areas with restricted access
- Application: For inserting and removing battery plugs
- Profile is especially suitable for battery plugs
- Plastic T-handle
- Surface: chrome-plated
- Screwdriver width: 14.5 mm
- Screwdriver height: 1.7 mm



Made in Germany

810/6 VDE, EAN-No. 4000896179329

VDE screwdriver set

- Ergonomically shaped HAZET 2-component handle (red/yellow)
- Voltmeter, 220–250 V as per VDE 0680



810 VDE - \ominus
0.4 x 2.5 · 0.6 x 3.5 ·
0.8 x 4

810 VDE - \oplus
PH1 · PH2

839 · \ominus
0.5 x 2.8

1850 VDE VDE combination pliers

- Induction-hardened cutting edges with grind
- Cutting edge hardness: 60 HRC
- EN/IEC 60900, DIN ISO 5746
- Surface: bright chrome-plated, with protective insulation

Made in Germany

HAZET No.	l mm	EAN-No. 4000896+
1850 VDE-22	160	007202
1850 VDE-33	180	007219
1850 VDE-44	200	007226

1803 VDE VDE diagonal cutter

- Easy motion joint free of clearance
- Lap joint
- Induction-hardened cutting edges with grind
- Cutting edge hardness: 60 HRC
- EN/IEC 60900, DIN ISO 5749
- Surface: bright chrome-plated, with protective insulation

Made in Germany

HAZET No.	l mm	Rm N/mm ² \bigcirc 800	Rm N/mm ² \bullet 1600	EAN-No. 4000896+
1803 VDE-22	160	2.8	2.0	006137
1803 VDE-33	180	3.0	2.5	006144

1841 b VDE-33

EAN-No. 4000896006441

VDE snipe nose pliers

- Flat round shape, induction-hardened cutting edges
- Curved design (45°)
- Cutting edge hardness: 60 HRC
- Length: 200 mm
- EN/IEC 60900, DIN ISO 5745
- Surface: bright chrome-plated, with protective insulation

Made in Germany





1979 N-81, EAN-No. 4000896218783

LED folding light

- Small design for use in areas with restricted access
- 5 pieces 0.65 W SMD LED, total power 3.25 W
- High-quality 2-component plastic housing with rubberised surface
- Flexible, 340° rotatable handle on the housing, lockable in 12 positions
- Fold-out and 360° rotatable hook (rear side)
- Incredibly powerful holding magnet with additional rubber lining on the underside of the housing
- Additional eyelet for attaching a retaining strap
- Practical belt clip (back)
- 3-setting switch function 100 %/50 %/Off
- Including 150 cm USB/Micro-USB charging cable
- Possible to charge the battery via a standard USB adapter 5 Volt (max. 1 A)

13 % brighter than predecessor model!



 4 h	5x SMD-LED 250 Lumen
Lithium battery 3.7 V 1550 mAh	 100% 4 h 50% 11 h
 IP 54	 IK 07

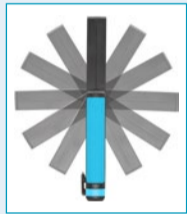

1979-9.0, EAN-No. 4000896210275

LED Slim Light hand lamp

- Display brightness on the back of the lamp enables optimal light adjustment
- Additional top lamp for surface illumination
- Operating time top lamp (100 %) approx. 10 hours
- Power supply via Micro USB port
- Incl. micro USB cable

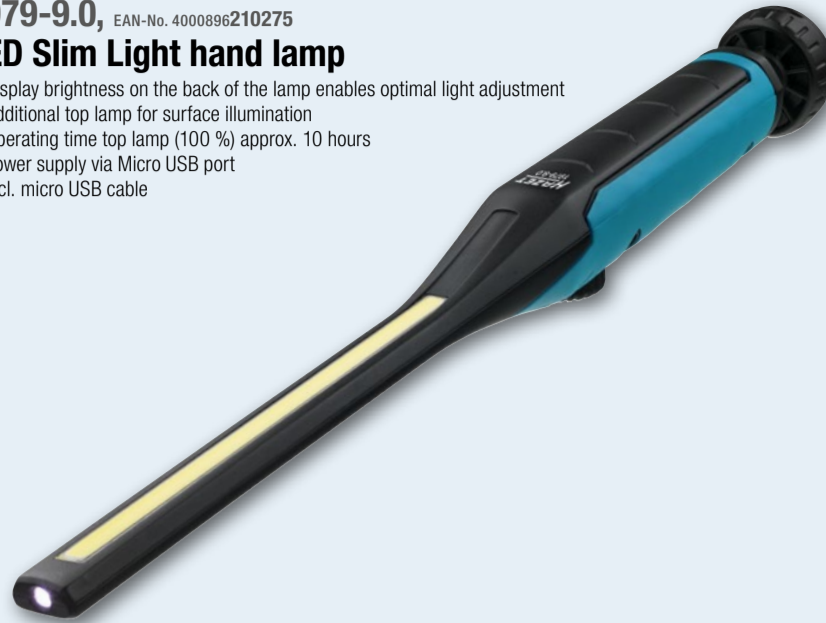

Top light







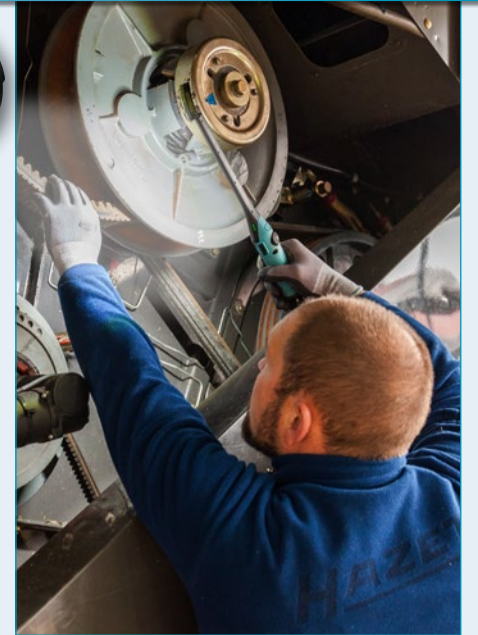

Infinite light control



With magnet and hook.
Freely adjustable via ball joint



 Lithium battery 3.7 V 2600 mAh	 4 h	 IK 07	 IP 54
Top-LED  10 h	 2 h 10 h	Top-LED 120 Lumen 3 W	COB-LED 560 Lumen

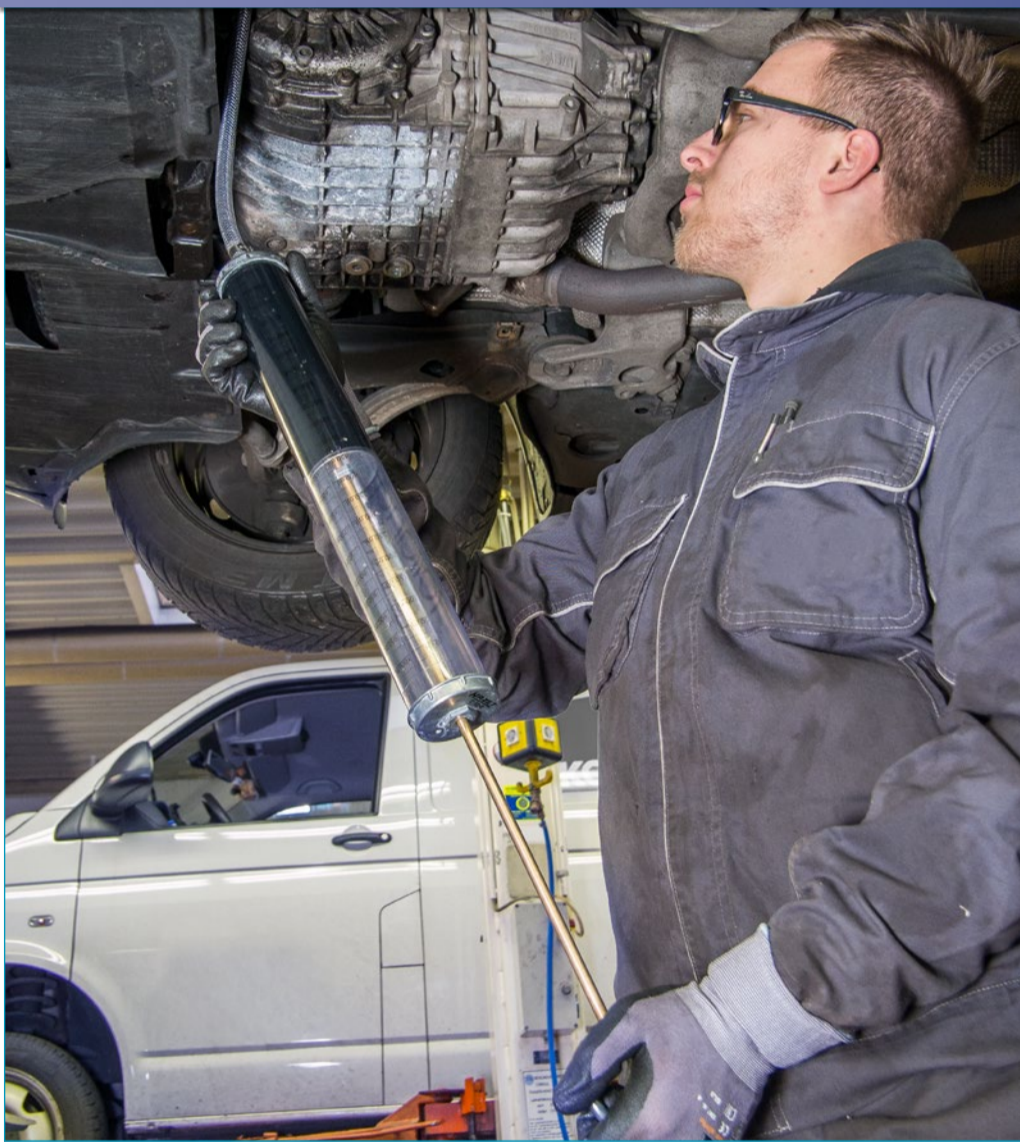

2162-8, EAN-No. 4000896213337

Hand-operated dosing pump

- The double scale enables precise dosing of various liquids
- For hydraulic oils 50 mm²/s, synthetic oils 500 mm²/s, heating and diesel oils, water and emulsions or contaminated used oil
- Coupler thread (hose/pipe) on the pump bottom: M15 x 1.5
- Housing material: PVC
- Hose inside Ø: 10 mm
- Hose outside Ø: 16 mm
- NBR seals
- Suitable for diesel, water, oil and used oil

NEW!



Filling capacity: 700 ml

Including curved 120° aluminium application pipe Ø 10 mm

600 mm plus application tube

Weight: 0.97 kg

Incl. flexible, transparent plastic hose fibre-reinforced



Hose clamp pliers 798-15 B

- Operating self-gripping spring band and space-saving hose clamps on the cooling and heating system
- Particularly suitable for areas with severely restricted access where the direct application of usual pliers is not possible
- **Plastic-coated, semi-flexible Bowden cable**
- The Bowden cable enables working without a guiding hand
- Sliding guide device with integrated tension spring and adjustable reversible plate
- **One-hand operation thanks to automatic toothed fixing device**
- Handles with dip coating

HAZET No.	sb mm	l mm	EAN-No. 4000896+
798-15 B	7-60	875	117727
Flexible hose for 798-15 B			
798-0150 B	-	-	142439
Bowden cable for 798-15 A and 798-15 B			
798-0152 A	-	-	097760
Sliding guide device for 798-15 A and 798-15 B			
798-0153 A	-	-	097784



Made in Germany



4812N-10/3AF, EAN-No. 4000896219131

Video borescope with new swivelling probe

- Full 180° swivel enables e.g. a real reverse view onto valves in the cylinder
- Swivelling range: 1 x 180°
- Camera head only 11 mm long (-50 % compared to conventional designs), hence swivelling in the tightest space
- Bending radius only approx. 35 mm (-30 % compared to conventional designs)
- With light boost and integrated reflection reduction
- Luminous source: 4 dimming LEDs for optimum lighting
- 4 x 90° image rotation at the press of a button (no need to turn the probe)
- Micro-lens: 4.5 mm Ø – Front view with a resolution of 640 x 480 px
- Depth of field: 10 to 100 mm
- Casing made from steel mesh
- Metal connector between probe and housing
- Probe tip: IP 67
- Automatic power off to save energy
- Weight (net): 2.84 kg

Contents:

- 1 m probe cable with 4.5 mm Ø micro-lens and LED luminous source
- 1 operating panel
- 1 SD card 4 GB
- 4 AA batteries



3

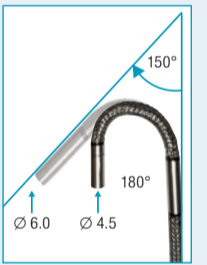

4812 N-1AS, EAN-No. 4000896187072

Flexible probe for video borescope Ø 6 mm

- Depth of field: 10 to 60 mm
- Ambient conditions: 0° to +55 °C
- Bending range: 2 x 150°, Bending radius (approx.): 48 mm
- Probe tip may be fixed in position
- Viewing direction of the camera: 90° (Side-View) no margins in view
- Luminous source: 1 LED in 90° direction

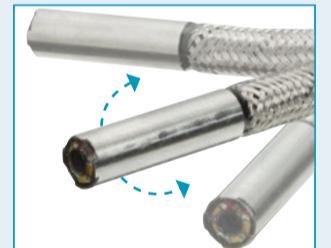
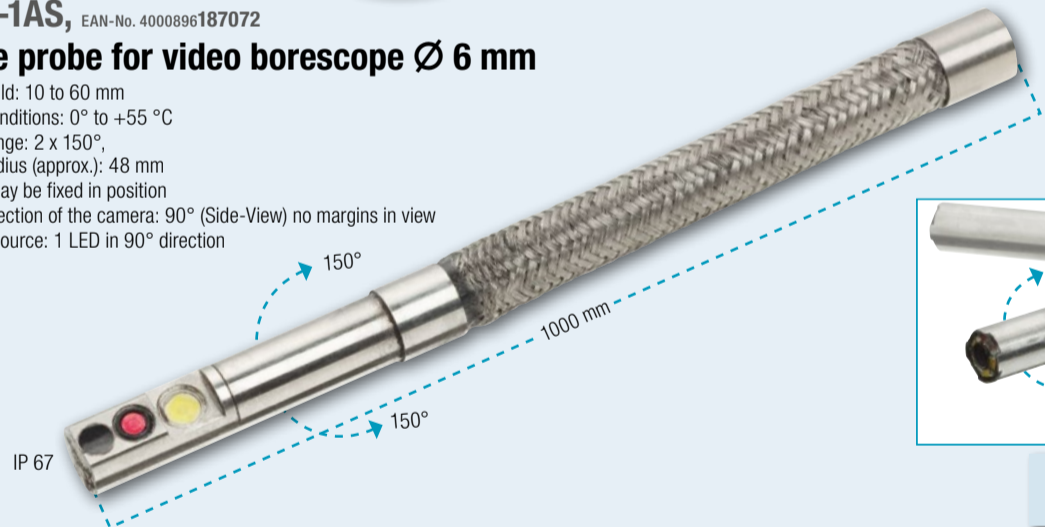

2151, EAN-No. 4000896013043

Borescope

- For the localisation of damaged parts e.g. axles, bearings and gearboxes
- Diaphragm with efficient transmission rate
- Steel tip: 180 mm
- Total length: 1080 mm
- Net weight: 0.13 kg

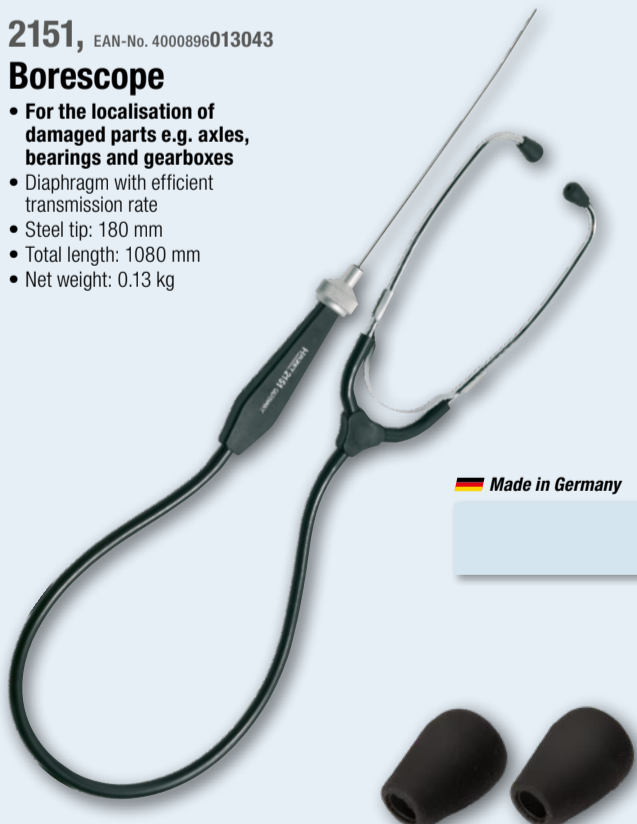

Made in Germany

2151-02/2, EAN-No. 4000896062287

Ear tips

- For HAZET borescope 2151

Made in Germany

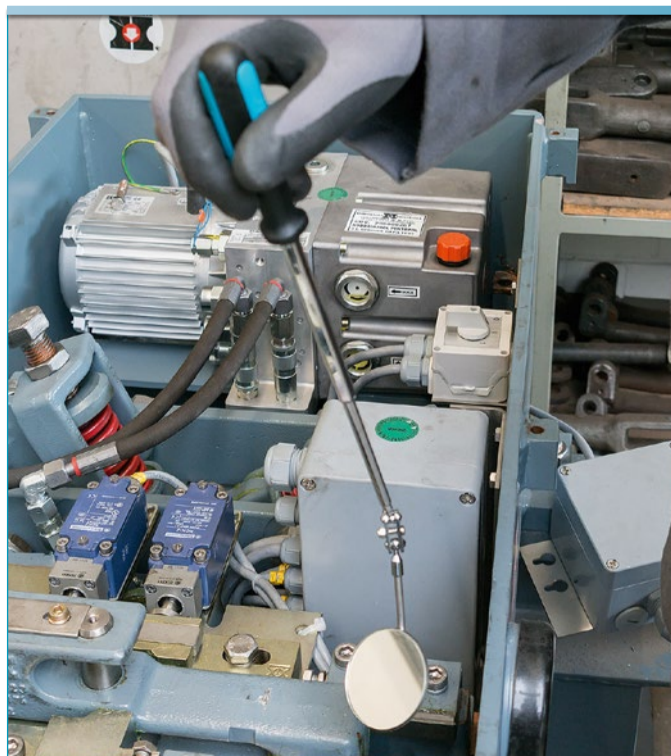

1977-2/4, EAN-No. 4000896150144

Telescopic inspection mirror set

- Double hinge with tension spring

The mirror does not become opaque

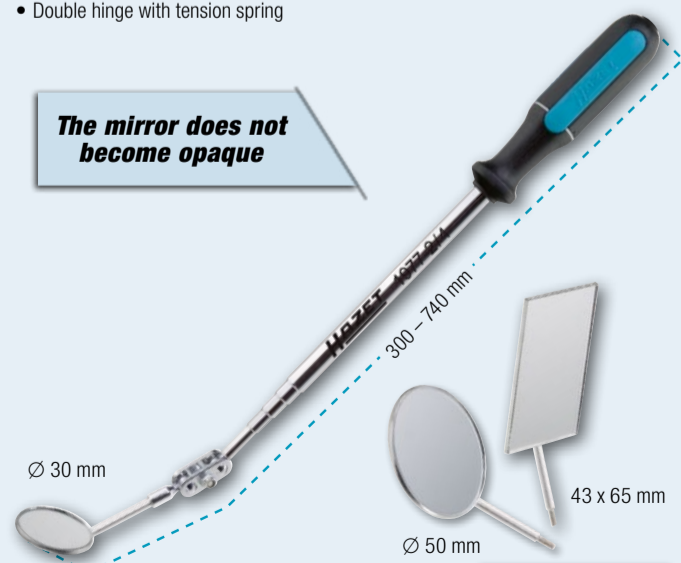

Ø 30 mm

Ø 50 mm

43 x 65 mm



195-4, EAN-No. 4000896148707

Pneumatic chair

- Provides a comfortable seat at the work area
- Loading capacity up to 150 kg
- Tilt-resistant

Adjustable in height from 380 to 510 mm

Cushioned seat base Ø 320 mm

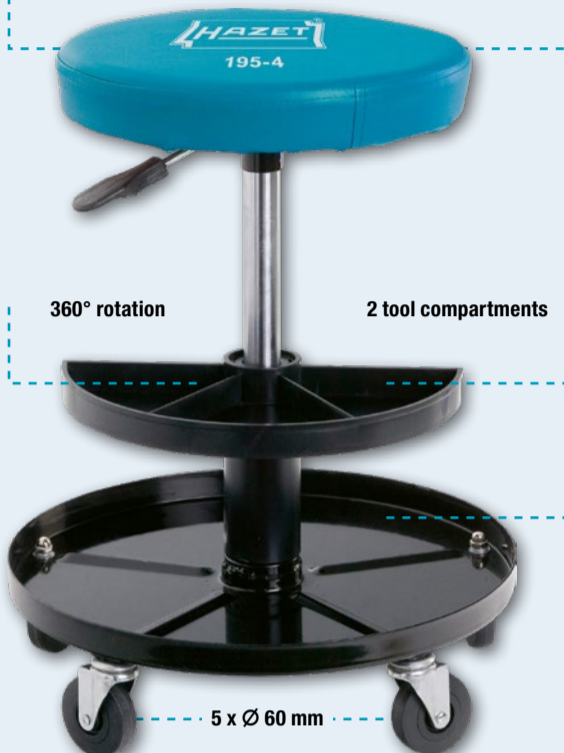

195-2, EAN-No. 4000896125982

Mechanic's creeper

- For convenient working underneath a vehicle
- 6 castors (Ø 70 mm)
- Especially deep for maximum freedom of movement under the vehicle
- Rigid, one-piece construction made of high-strength, black plastic
- Ergonomically shaped: cut out arm areas for optimal elbow room
- Practical storage compartments for tools and small parts on the right and the left
- Highly resilient (up to): 130 kg
- Smooth-running swivel castors with rubber running surface, oil resistant and low-noise
- Practical carrying handle in the foot area
- Dimensions (H x L x D): 115 x 1030 x 480 mm



195-3, EAN-No. 4000896148691

Creeper/pneumatic chair

- For convenient working on and underneath a vehicle
- Lying position (H x W x L): 130 x 450 x 1198 mm
- Seat height: 420 mm, seat base: 300 x 310 mm
- Highly resilient (up to): 150 kg
- Combines creeper and seat
- Quick and easy conversion from creeper to seat and vice versa
- Cushioned lying area, lead part coloured HAZET-Blue
- Sturdy steel tube frame

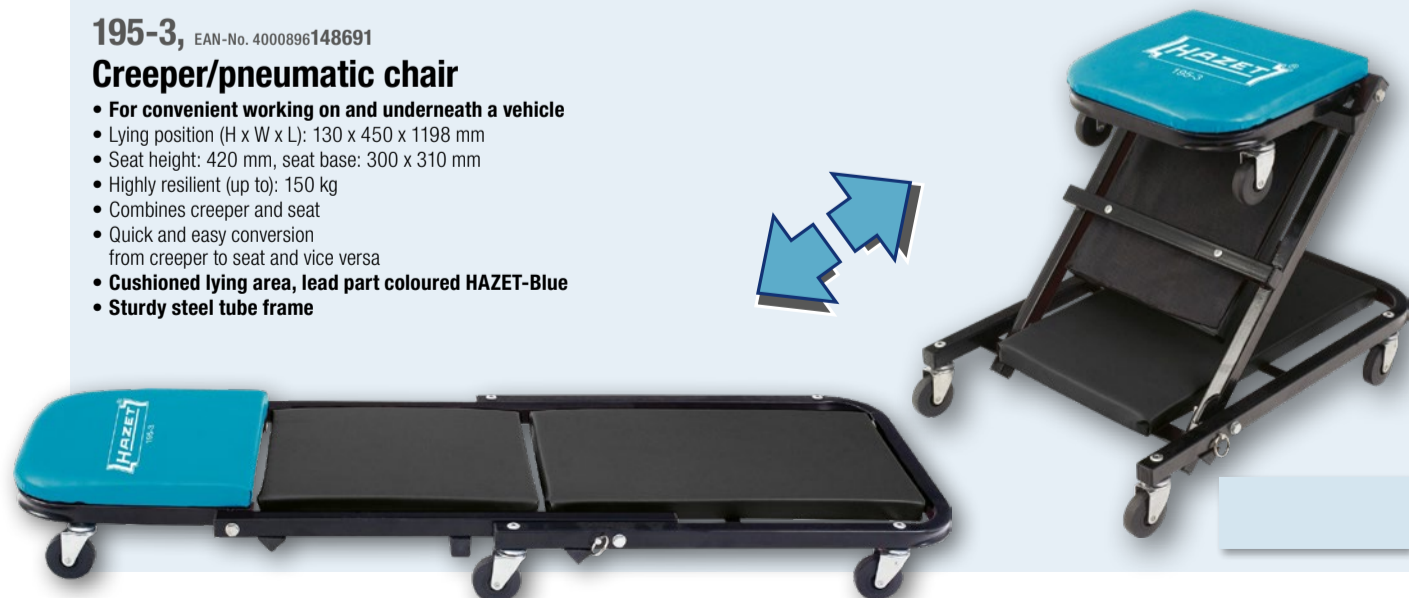

1987 N-4, EAN-No. 4000896203840

Gloves

- With micro-foam coating
- Breathable coating
- Maximum flexibility and freedom of movement together with excellent mechanic protection
- Water repellent
- Material: 60 % cotton, 40 % polyester



196-2, EAN-No. 4000896149469

Fender cover

- Made of specially coated anti-slip material
- Waterproof, oil and grease repellent
- Cover adheres almost completely vertically to all car body surfaces
- Fire safety complies with British and US Fed 302 standards
- Washable at 40°



Impact wrench

- Loosening torque (max.): 3400 Nm
- Extremely powerful tools
- Easy to use
- Output designed with hole for pinning, as well as a nut-driver holder ring
- Lightweight and handy tool for attaining the highest torque values in commercial vehicle and industrial applications
- One-hand reversing switch

- Operation optimised on both sides for left and right handed users
- Optimised feel
- Air inlet possible on the handle at the bottom and rear
- Exhaust air is guided downwards through the handle

- Reduced vibrations
- Coupler plug: nominal size 10 mm (included)
- Forward/reverse: three-stage

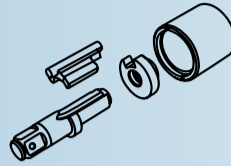

Direct hammer striking mechanism:
Fewer vibrations and higher output

NEW!

9014 P-1

25 1"

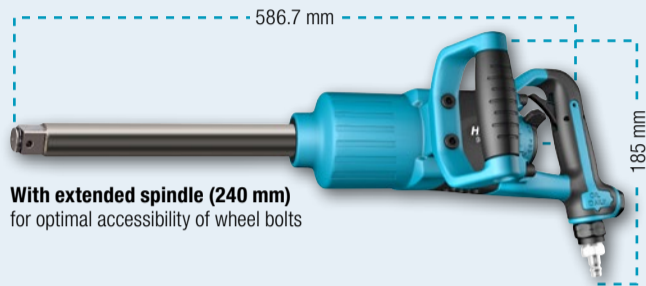

With extended spindle (240 mm) for optimal accessibility of wheel bolts

9014 PS-1

25 1"



HAZET No.	■	max. Nm	max. Nm	Bar	rpm	l/min	dB(A) Lp A	m/s ²	Ø mm	kg	20.67 9000-010	EAN-No. 4000896 +
9014 P-1	25 1"	3400	2712	6.3	5500	283	103.5	15.94	19	8.5	20.67 9000-010	218332
9014 PS-1	25 1"	3400	2712	6.3	5500	283	103.5	15.94	19	7.8	20.67 9000-010	222490



YouTube clip 9014 P-1

9013 MG, EAN-No. 4000896109210

20 3/4"

Impact wrench

- Loosening torque (max.): 1800 Nm
- Exhaust air is guided downwards through the handle
- Forward/reverse: three-stage (forward), single-stage (reverse)
- Magnesium housing
- Tightening torque (max.): 1627 Nm
- Recommended torque: 1084 Nm
- Air requirement: 198 l/min (3.3 l/sec)
- Sound pressure level (at working pressure): 96.8 dB(A) Lp A
- Vibration acceleration: 12.18 m/s²
- Weight (net): 5.1 kg



Max. loosening torque 1800 Nm

9013 M, EAN-No. 4000896212347

Impact wrench

- Loosening torque (max.): 1890 Nm
- Exhaust air is guided downwards through the handle
- Reduced vibrations
- Forward/reverse: three-stage (forward), single-stage (reverse)
- Rotation speed :7300 rpm
- Weight (net): 2.1 kg
- Air requirement: 153 l/min (2.5 l/sec)
- Sound power level (at working pressure): 93 db(A) Lp W
- Vibration acceleration: 7.47 m/s²

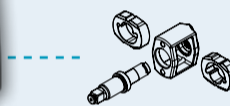

Comparison 9013 M to the previous 9013 MG



YouTube clip

3/4" impact wrench in 1/2" size! Only 2.1 kg!



9000-062, EAN-No. 4000896218936

Safety coupling for 20.95 mm (1/2")

- No risk of injury from hose impact
- Safe disconnection of the connection (unwanted disconnection is excluded)
- Safety coupling depressurises the connection before decoupling
- One-hand operation
- Little effort during coupling and decoupling
- Omission of loud popping during coupling process
- Air inlet thread (IG): 20.95 mm (1/2")

NEW!



9012 M, EAN-No. 4000896188987

12.5 1/2"

Impact wrench

- Loosening torque (max.): 1100 Nm
- Rotation speed: 10.000 rpm
- Weight (net): 1.2 kg
- Air requirement: 127 l/min
- Sound pressure level (at working pressure): 97.1 dB(A) Lp A
- Vibration acceleration: 9.57 m/s²



Compare conventional impact wrenches to extra small 9012 M

Extra short - only 92 mm!

9012 SPC, EAN-No. 4000896119639

12.5 1/2"

Impact wrench

- Loosening torque (max.): 850 Nm
- Rotation speed: 7000 rpm
- Weight (net): 2.6 kg
- Air requirement: 127.4 l/min (2.1 l/sec)
- Sound pressure level (at working pressure): 92.1 dB(A) Lp A
- Vibration acceleration: 7.42 m/s²



9000-080, EAN-No. 4000896214709

12.91 (v) 9000-010 7.2

Compressed air reducer

- Device for the reduction of working pressure to protect pneumatic equipment
- Can be ground into the compressed air line or connected directly to the pneumatic device
- For connecting motor-powered pneumatic devices with a working pressure of 6.3 bar
- Max. inlet pressure: 10 bar
- Outlet pressure: 6.3 bar
- Incl. air connection nipple for connection to compressed air coupling
- Incl. adapter 1/4" (AG) for 1/4" (AG) for connection to the device

NEW!



YouTube clip

1007 S-7/4, 1003 S-07
Impact adapter

12⁵ 1/2 20 3/4 4

- With replaceable 12⁵ 1/2 plug-in blades
- For impact operation
- With borehole for locking pin or safety spring and groove for o-ring
- Proven with 990 S/11 and 985 S/11
- Can now be combined with 900 SZ/4 and all other 12⁵ 1/2 impact sockets too

The enormous force of the 20 3/4 drive results in high load on and increased wear of the 12⁵ 1/2 output. The 6-point adaption means the 12⁵ 1/2 output is replaceable, thereby making the adapter more versatile!



Made in Germany

HAZET No.	Designation	EAN-No. 4000896+
1007 S-7/4	Impact adapter	215416
1003 S-07	Replaceable plug-in blades 12 ⁵ 1/2	215409

985 S/11, EAN-No. 4000896211951
Impact screwdriver socket set

12⁵ 1/2 20 3/4 24 24 11

- 20 3/4 Drive allows transmission of high separation forces
- For screw connections on commercial vehicles e.g. on chassis, brake system (brake carriers), engines and shock absorbers
- Drive optionally with 12⁵ 1/2, 24 mm or with adapter HAZET 1003 S-1
- With borehole for locking pin or safety spring and groove for o-ring
- Sizes 14, 17 and 19 in short and long design



Made in Germany

990 S/11, EAN-No. 4000896162406
Impact screwdriver socket set

12⁵ 1/2 20 3/4 24 24 11

- For chassis and engine fittings in commercial vehicles
- Drive optionally with 12⁵ 1/2, 24 mm or with adapter HAZET 1003 S-1
- With borehole for locking pin or safety spring and groove for o-ring
- Sizes 14, 16 and 18 in short and long design



Made in Germany

9040 Lg-3/2, EAN-No. 4000896206339
Air blow gun

- With 90° side nozzle 1 and Venturi nozzle 2
- Application: For cleaning areas with restricted access on vehicles, machinery and agricultural machinery
- Especially suitable for cleaning cooling fins
- Grip area with insulated lance to protect it from cold
- Increased efficiency due to Venturi nozzle (54 mm)
- 90° side nozzle (32 mm) enables cleaning of cooling fins
- Pressure (max.): 12 bar
- Ergonomic handle

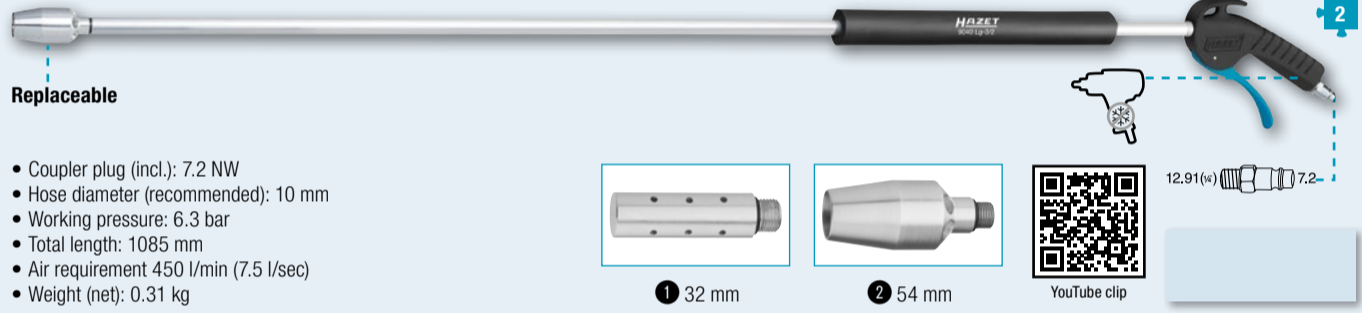

Replaceable

- Coupler plug (incl.): 7.2 NW
- Hose diameter (recommended): 10 mm
- Working pressure: 6.3 bar
- Total length: 1085 mm
- Air requirement 450 l/min (7.5 l/sec)
- Weight (net): 0.31 kg

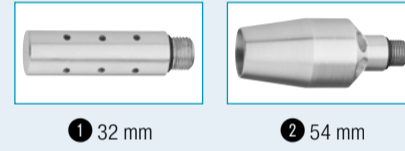

9035-5, EAN-No. 4000896132355
Needle scaler

- Adjustable needle cover
- Removes precise, small and large emerging patches of rust
- 19 needles (Ø 3 mm)
- 3200 impacts/min.
- Weight (net): 2.6 kg
- Air requirement: 170 l/min. (2.8 l/sec)
- Sound pressure level (at working pressure): 97 dB(A) Lp A
- Total length: 330 mm
- Vibration acceleration: 8.7 m/s²

Including 19 needles, Ø 3 mm

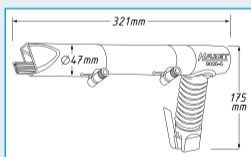
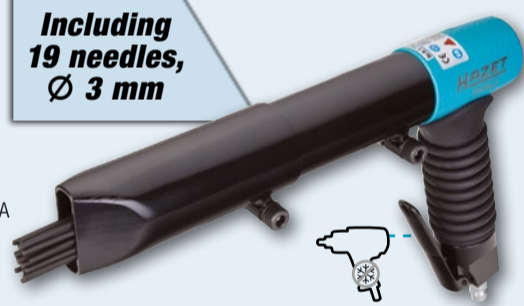

12.91 (€) 9000-010 7.2



9035-050, EAN-No. 4000896139385
Spare needles

- Suitable for needle scaler 9035-5
- 19 needles (Ø 3 mm)

9033 N-4, EAN-No. 4000896210183
Belt sander

- Continuous speed regulation via speed regulator on back of handle
- For narrow surfaces (belt width 10 mm)
- Including three abrasive belts 330 x 10 mm (grain size 80, 100, 120)
- Locking device for quick belt changing
- Automatic belt adjustment
- 360° rotatable belt run
- Belt speed (max.): 1370 m/min
- Including hex-head wrench for fine adjustment of the belt and angle setting in the handle

Speed regulation



Power: 420 Watts

HAZET No.	l/min.	rpm	db (A) LpA	kg	EAN-No. 4000896+
9033 N-4	94	19000	83.8	0.81	210183
Abrasive belts 330 x 10 mm. Packing unit 10 pieces.					
9033-480/10	-	-	-	39	139101
Grain size 80					
9033-4100/10	-	-	-	35	139118
Grain size 100					
9033-4120/10	-	-	-	32	139125
Grain size 120					

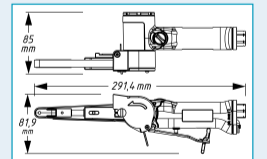

Achieving goals together!



9033 N-6, EAN-No. 4000896209743

Multi sander

- **Contents:**
- Multi sander for use with brush belts, strip wheels and foil erasers
- For removal of underbody protection, sealing compound, rust, corrosion, paint, plastic film, labels as well as for paint stripping
- Continuous speed regulation via speed regulator on back of handle
- Spindle size: 9 mm (hex)
- Delivery without accessories
- Power: 370 Watts
- Rotation speed: 4000 rpm
- Working pressure: 6.3 bar
- Air requirement: 102 l/min (1.7 l/sec)
- Sound pressure level (at working pressure): 79 dB(A) Lp A
- Vibration acceleration: 0.80 m/s²
- Weight (net): 1.2 kg



Foil eraser accessory
Not included!

Accessories for multi-sander

HAZET No.	Designation	EA	EAN-No. 4000896+
9033-6-010	Adapter for brush belts 23 mm and foil erasers	-	213672
9033-6-01/5	Foil erasers (lighter version)	5	160167
9033-6-01A/5	Foil erasers (darker version) for water-based paints	5	160228
9033-6-02/5	Brush belt 23 mm wide, coarse and bent tips. For removing underbody protection, sealing putty, as well as paint stripping with rough sand-blasting effect	5	160174
9033-6-06/5	Brush belt 23 mm wide, fine and straight tips. For the removal of paint and rust, without sand-blasting effect	5	160211
9033-6-011	Adapter for brush belts 11 mm	-	213665
9033-6-03/5	Brush belt 11 mm wide, coarse and bent tips. For removing underbody protection, sealing compound as well as paint stripping with rough sand-blasting effect	5	160181
9033-6-05/5	Brush belt 11 mm wide, fine and straight tips. For removing paint and rust, without sand-blasting effect	5	160204
9033-6-041	Adapter for single strip wheels	-	213658
9033-6-040	Adapter for double strip wheels	-	213641
9033-6-04/5	Strip wheels	5	160198

9040 N-13, EAN-No. 4000896214648

Hose reel

- **Hose stop function possible at any point with "Stop at any point"**
- Neat winding of the hose thanks to automatic guidance
- Braked winding to prevent risk of accidents
- Suitable for compressed air or water
- Black hybrid polymer hose
- Temperature range: -40 to +80 °C
- Air inlet intake (from compressor/to machine): Outside thread 20.96 mm (1/2")
- Operating pressure (max.): 20 bar
- Weight (net): 9.5 kg



9040D-2.5, EAN-No. 4000896214631

Cable reel

- **Line stop function possible at any point with "Stop at any point"**
- Braked winding to prevent risk of accidents
- Including line circuit breaker
- For 230 V AC
- Only suitable for indoor use
- Temperature range: -20 to +45 °C
- Resilient when wound up: 1600 W
- Resilient when unwound: 3200 W
- Weight (net): 9.2 kg



9042 N-1, EAN-No. 4000896176472

Grease gun, pneumatic

- Continuous pumping of grease
- Gun-filling with grease cartridge, loose grease or via dispenser
- 360° adjustable handle
- Air requirement: 230 l/min.
- Nylon tube: 230 mm
- Metal tube: 172 mm
- Weight (net): 2.0 kg

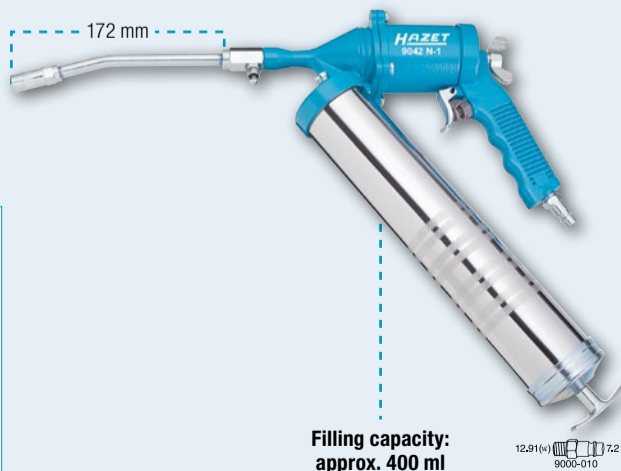

9043 N-10, EAN-No. 4000896198382

Switchable air blow and suction gun

- **For sucking up dirt into the dust collection bag as well as for blowing surfaces clean**
- With speedy one-hand switching of the function direction
- Well suited to cleaning truck cabs
- Vacuum level: 7.5 mm
- Air requirement: 96 l/min (1.6 l/sec)
- Working pressure: 6.3 bar
- Sound pressure level (at working pressure): 92 dB(A) Lp A
- Vibration acceleration: 0.40 m/s²
- Weight (net): 0.4 kg

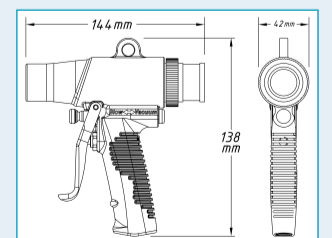



9233-010, EAN-No. 4000896218943
Cordless right-angle grinder 18 V

- High efficiency thanks to brushless motor
- Compatible with HAZET rechargeable batteries 9212-02 and 9212-05
- Device stops if the speed drops sharply due to canting
- Motor stop 2 seconds after switch-off
- Constant speed even during difficult work
- With safety lever
- Including 1 protective hood for cut-off wheels and grinding wheels
- Quick adjustment (without tools) of protective hood
- Spindle thread: M14
- Weight (with battery): 2.28 kg
- Weight (without battery): 1.53 kg
- **Contents:**
Cordless right-angle grinder, plastic case



9230-010, EAN-No. 4000896218974
Cordless drilling machine 18 V

- High efficiency thanks to brushless motor
- Compatible with HAZET rechargeable batteries 9212-02 and 9212-05
- Tool-free metal quick-clamping drill chuck 1–13 mm
- Selectable torque settings 15 + 1 drilling
- stage 1: 0–560 rpm
- stage 2: 0–1900 rpm
- Robust machine housing
- Suitable for continuous operation
- Weight (with battery): 1.68 kg
- Weight (without battery): 1.27 kg
- **Contents:**
Cordless drilling machine, bag



More power
 20 3/4"

NEW!

9213-1000, EAN-No. 4000896222698
Cordless impact wrench 18 V, 5 Ah

- High efficiency thanks to brushless motor
- Compatible with HAZET rechargeable batteries 9212-02 and 9212-05
- Max. loosening torque: 1400 Nm
- Max. tightening torque: 1000 Nm
- Three selectable performance levels for the torque screw tightening:
- 1st level: approx. 180 Nm at 0–400 rpm
- 2nd level: approx. 400 Nm at 0–800 rpm
- 3rd level: approx. 1.000 Nm at 0–1800 rpm
- Forward/reverse: multistage
- Lithium-Ion rechargeable battery
- Brushless DC motor (BLDC)
- Screw size: M24
- **Contents:**
Cordless impact wrench, plastic case



3-piece

1 or 2 batteries: The choice is yours!

4-piece



9233-7, EAN-No. 4000896218325
Cordless right-angle grinder set, 3 pieces

- **Contents** (3-piece set):
1 cordless right-angle grinder
1 quick charger
1 Li-Ion rechargeable battery 18 V, 5.0 Ah
- In plastic case

9230-2, EAN-No. 4000896218370
Cordless drilling machine set, 3 pieces

- **Contents** (3-piece set):
1 cordless drilling machine
1 quick charger
1 Li-Ion rechargeable battery 18 V, 2.0 Ah
- Supplied in bag

9213-1000/3, EAN-No. 4000896222704
Cordless impact wrench set, 3 pieces

- **Contents** (3-piece set):
1 cordless impact wrench
1 quick charger
1 Li-Ion rechargeable battery 18 V, 5.0 Ah
- In plastic case

9233-7/4, EAN-No. 4000896218950
Cordless right-angle grinder set, 4 pieces

- **Contents** (4-piece set):
1 cordless right-angle grinder
1 quick charger
2 Li-Ion rechargeable batteries 18 V, 5.0 Ah
- In plastic case

9230-2/4, EAN-No. 4000896218967
Cordless drilling machine set, 4 pieces

- **Contents** (4-piece set):
1 cordless drilling machine
1 quick charger
2 Li-Ion rechargeable batteries 18 V, 2.0 Ah
- Supplied in bag

9213-1000/4, EAN-No. 4000896222797
Cordless impact wrench set, 4 pieces

- **Contents** (4-piece set):
1 cordless impact wrench
1 quick charger
2 Li-Ion rechargeable batteries 18 V, 5.0 Ah
- In plastic case

Accessories

9212-02, EAN-No. 4000896213788
Replacement battery 2.0 Ah



9212-05, EAN-No. 4000896210367
Replacement battery 5.0 Ah



9212-03, EAN-No. 4000896204823
Quick charger for rechargeable batteries



9233-010/5, EAN-No. 4000896219063
Cut-off wheel set



9233-011/10, EAN-No. 4000896219087
Cut-off wheel set



9233-010/25, EAN-No. 4000896219070
Cut-off wheel set



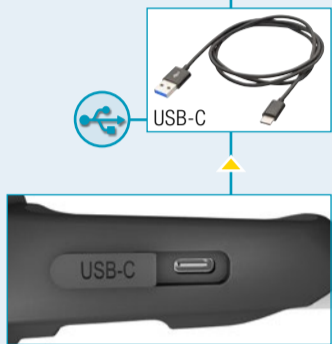
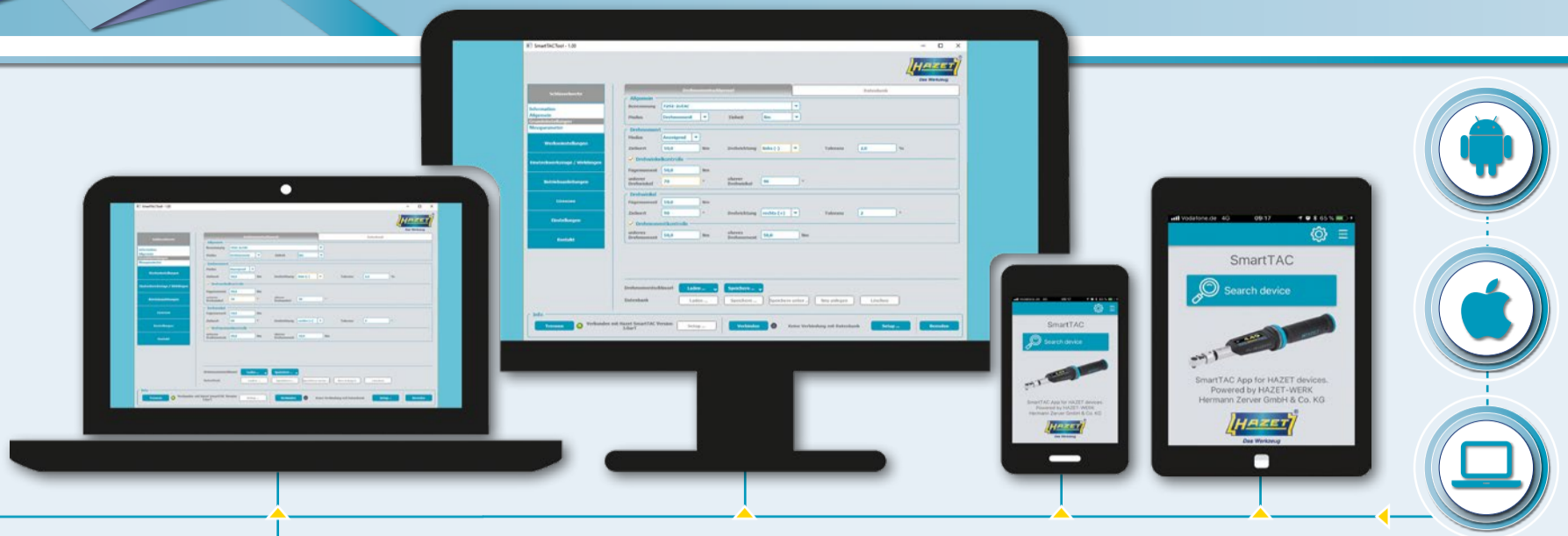

Bluetooth®



SmartTAC System 7000 sTAC

Electronic torque wrench with built-in angle gauge

- Unique ergonomic, user-oriented HAZET design of the entire tool for professional use
- The reduction in size, owing to the 42 % smaller size of the PCB as well as partial integration of the PCB into the main pipe, results in dimensions that allow the small torque wrench with built-in angle gauge from 1 to 10 Nm for the first time
- Display deviation in right and left torque: from $\pm 1\%$ / ± 1 digit, 7280/7281-2sTAc $\pm 2\%$ / ± 1 Digit
- Display deviation in right and left rotation angle: $\pm 1\%$ / $\pm 1^\circ$
- Spray-water-proof through membrane keyboard – Protection rating IP 40
- Tested in accordance with DIN EN ISO 6789:2017
- **4-fold signalling for optimum screwing progress monitoring**
 - 2 x optical, with travelling digital display and all-round 360° LED display, visible from any position, with known traffic light function (yellow = pre-warning/green = OK/red = NOK)
 - Audible via buzzer
 - Palpable via vibration
- USB-C interface for programming torque wrenches with built-in angle gauge and for documentation of the storage data via laptop and PC
- Incl. standard replaceable Li ion rechargeable battery, type 14650/3.7 V, can be charged directly on the tool via USB-C connector
- With 1 m USB 3.1/A - C cable

6.3 1/4" 10 3/8" 12.5 1/2" 20 3/4"

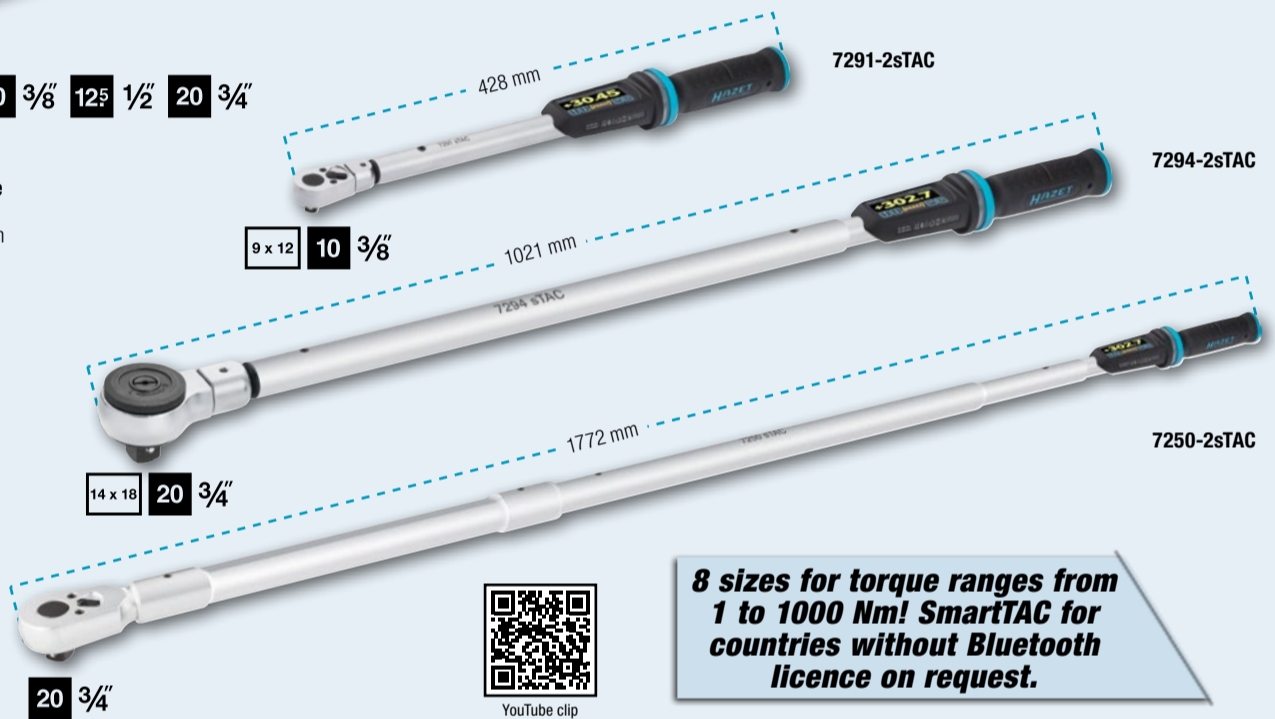

8 sizes for torque ranges from 1 to 1000 Nm! SmartTAC for countries without Bluetooth licence on request.

Made in Germany

HAZET No.	Bluetooth	Torque measuring range Nm	Torque display range Nm	Scale graduation/ Torque setting steps	Insert square holder	HAZET insert reversible ratchet (included in delivery)	Length approx. mm without/with insert tool	approx. kg	Actuating force approx. kg	EAN-No. 4000896+	
7280-2sTAC	✓	1-10	± 2	0.5-10	9 x 12	6401-1 - 6.3 1/4"	260/290.5	0.4	0.5-4.6	215294	
7281-2sTAC	✓	2.5-25	± 2	1.25-25	9 x 12	6401-1 - 10 3/8"	260/290.5	0.4	1. -11.4	215317	
7290-2sTAC	✓	5-60	± 1	2.5-60	9 x 12	6402-1 - 12.5 1/2"	302/347	0.8	1.8-22.2	215324	
7291-2sTAC	✓	10-100	± 1	5-100	9 x 12	6402-1 - 20 3/4"	383/428	0.9	2.9-28.7	215430	
7292-2sTAC	✓	20-200	± 1	10-200	14 x 18	6404-1 - 12.5 1/2"	520/578.5	1.3	4.1-40.7	215447	
7294-2sTAC	✓	40-400	± 1	20-400	14 x 18	6406 - 20 3/4"	945/1021	3.2	4.4-43.8	215454	
7295-2sTAC	✓	65-650	± 1	32.5-650	14 x 18	6406 - 20 3/4"	1141/1217	5.9	5.9-58.7	215461	
7250-2sTAC	✓	200-1000	± 1	100-1000	-	20 3/4" Permanently mounted reversible ratchet	1772 (Overall length)	9.0	12.2-60.8	215478	
7910-sTAC		SmartTAC-Tool, programming and analysis software								221875	NEW!

Torque + Rotation angle = 1 operation!

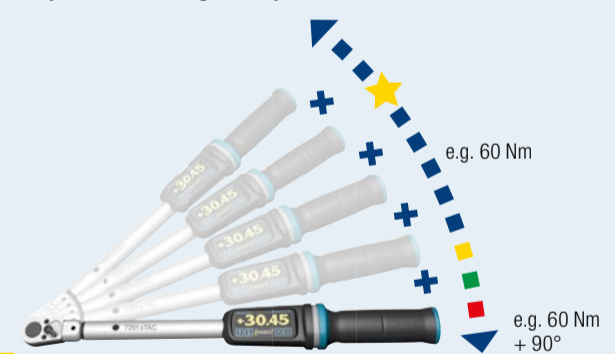

6145-1CT

Torque wrench 300 to 800 Nm

- Less clearance and higher precision through new screw fitting for shell tools
- With serial number and certificate

300-800 Nm

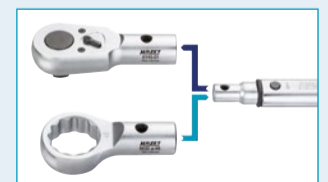

For ring shell tools 6630 A-s 32-46 mm

6150-1CT

Torque wrench 400 to 1000 Nm

- Incl. bag for safe storage
- With serial number and certificate

400-1000 Nm



Made in Germany

HAZET No.	Torque range Nm	Graduation Nm	Release accuracy tolerance	l mm	Min.	Max.	EAN-No. 4000896+
6145-1CT	300-800	2.5	$\pm 2\%$	1280	25.9	70.2	025565
6150-1CT	400-1000	5	$\pm 3\%$	1788	24.7	61.0	141067

5120-3 CT, EAN-No. 4000896218905

12⁵ 1/2"

Torque wrench 10–60 Nm

- Especially suitable for commercial vehicles due to small torque with 1/2" sockets
- With serial number and certificate

NEW!

±3 %
release accuracy
tolerance

1772 mm



12⁵ 1/2"

Made in Germany

HAZET No.	Release accuracy tolerance of the scale value	Torque range Nm	l mm	Graduation Nm
5120-3 CT	±3 %	10–60	320	0.5



NEW!

5122-3 CT/5123-3 CT

12⁵ 1/2"

Torque wrench up to 320 Nm

- For applying small torque values with 1/2" sockets
- Tested in accordance with DIN EN ISO 6789-2:2017
- With serial number and certificate

Made in Germany

HAZET No.	Release accuracy tolerance of the scale value	Torque range Nm	l mm	Graduation Nm	EAN-No. 4000896+
5122-3 CT	±3 %	40–200	513	1	219001
5123-3 CT	±3 %	60–320	632	2	218998

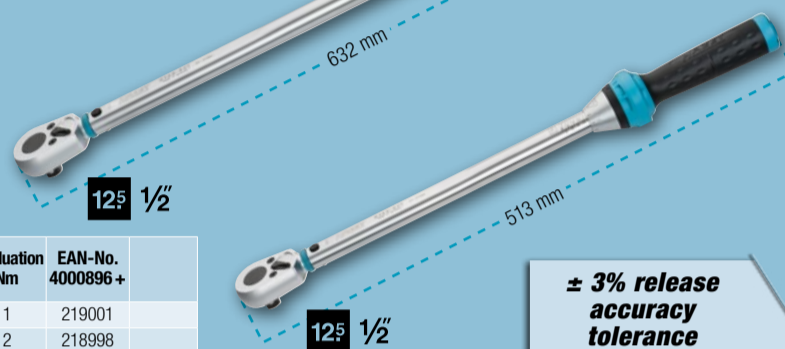

± 3% release accuracy tolerance

6800 ALU-700, EAN-No. 4000896143467

12⁵ 1/2" 20 3/4"

Torque multiplier

- Improved, light design made of aluminium
- Up to 30% less weight than comparable steel version!
- For tight screwed connections
- Avoids the application of long levers, slogging wrenches, etc. – prevents fittings from being damaged
- With return stop
- Output torque: 700 Nm
- Release accuracy tolerance: ±5 %
- Drive: 1/2"
- Output: 3/4"
- Transmission ratio: (approx.): 1:3.5

Loosen and tighten!

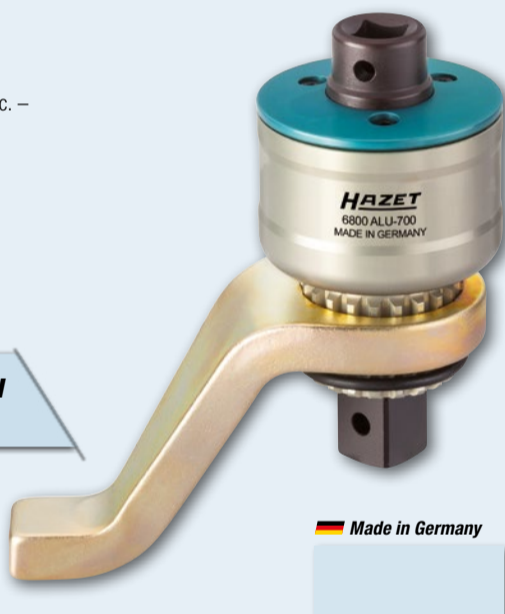

Made in Germany

810 U-1/5, EAN-No. 4000896179572

Screwdriver set

- With 6-point bolster (for use with a wrench) and impact cap
- Surface: blade matt chrome-plated, tip burnished



810U - 0
0.8 x 4.5 · 1 x 5.5 · 1.2 x 7 mm

810U - 1
PH1 · PH2

Impact cap

6-point bolster

803 LG-T

Screwdriver trinamic®

- Application e.g. at the dashboard, car body, engine compartment as well as industry applications
- Long design

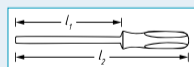

HAZET No.	l ₁ mm	l ₂ mm	Ø mm	EAN-No. 4000896+
803 LG-T 15	250	330	3.27	087785
803 LG-T 20	250	343	3.86	087792
803 LG-T 25	250	345	4.43	087808
803 LG-T 30	250	360	5.25	087815

810 T/6, EAN-No. 4000896204304

Screwdriver set

- With hanging hole in handle
- Surface: blade matt chrome-plated, tip burnished



810T - 0
T 10 · T 15 · T 20 · T 25 · T 27 · T 30

YouTube clip

428 LG
Nut-driver

- Ergonomically shaped HAZET 2-component T-handle
- Long design
- Surface: chrome-plated

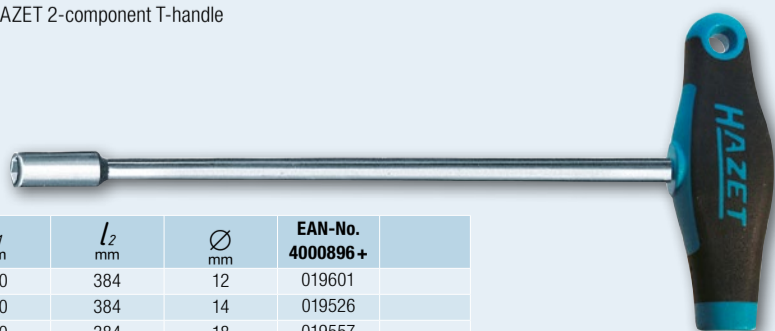
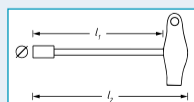

HAZET No.	l ₁ mm	l ₂ mm	Ø mm	EAN-No. 4000896+
428 LG- 8	350	384	12	019601
428 LG-10	350	384	14	019526
428 LG-13	350	384	18	019557

810/6, EAN-No. 4000896058808

Screwdriver set

- With hanging hole in handle
- Surface: blade matt chrome-plated, tip burnished



810 - 0
0.5 x 3 · 0.8 x 4 · 1 x 5.5 · 1.2 x 6.5 mm

810 - 1
PH1 · PH2

YouTube clip



600 LG

Combination wrench, extra long, slim design

Made in Germany

HAZET No.	S mm	a ₁ mm	a ₂ mm	l mm	EAN-No. 4000896+
600 Lg-10	10	8.5	5.5	210	197644
600 Lg-11	11	9.0	5.5	220	199518
600 Lg-12	12	9.5	6.0	230	199501
600 Lg-13	13	10.0	6.0	245	198238
600 Lg-14	14	11.0	6.5	255	197651
600 Lg-15	15	11.6	7.0	270	209958
600 Lg-16	16	12.0	7.0	290	209200
600 Lg-17	17	12.5	7.5	305	197668
600 Lg-18	18	13.8	8	320	209194
600 Lg-19	19	15.0	8.5	335	198245
600 Lg-21	21	15.8	8.5	365	209965
600 Lg-22	22	16.0	9.0	380	199525
600 Lg-24	24	18.0	10.0	430	198252
600 Lg-27	27	20.0	11.0	480	198269
600 Lg-30	30	21.0	12.0	510	199723
600 Lg-32	32	21.5	12.0	530	197675
600 Lg-36	36	24.0	13.0	580	205745
600 Lg-41	41	26.0	14.0	600	205738



Made in Germany

HAZET No.	Contents	EAN-No. 4000896+
600 Lg/10	10 x s 10 · 11 · 12 · 13 · 14 · 15 · 16 · 17 · 18 · 19 mm	218424
600 Lg/13	13 x s 10 · 11 · 12 · 13 · 14 · 15 · 16 · 17 · 18 · 19 · 21 · 22 · 24 mm	218417

600 SPC
Combination wrench sets



Made in Germany

HAZET No.	Contents	EAN-No. 4000896+
600 SPC/10	10 x s 8-19 mm	118465
600 SPC/16	16 x s 7-24 mm	186235

450 N
Double open-end wrench sets



Made in Germany

HAZET No.	Contents	EAN-No. 4000896+
450 N/10	10 x s 6 x 7 · 8 x 9 · 10 x 11 · 12 x 13 · 14 x 15 · 16 x 17 · 18 x 19 · 21 x 22 · 24 x 26 · 27 x 32 mm	020751
450 N/12	12 x s 6 x 7 · 8 x 9 · 10 x 11 · 12 x 13 · 14 x 15 · 16 x 17 · 18 x 19 · 20 x 22 · 21 x 23 · 24 x 26 · 25 x 28 · 27 x 32 mm	020775

600 N
Combination wrench

- Slim heads
- Head set at 15°

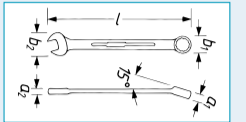
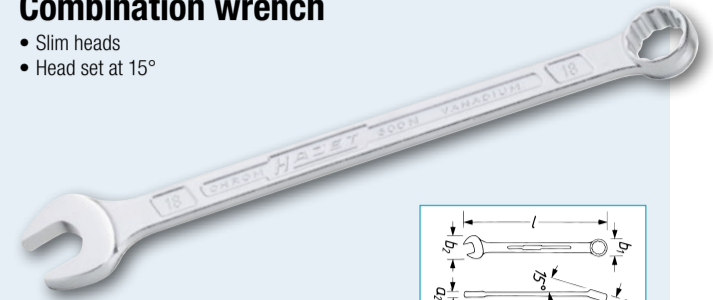

Made in Germany

HAZET No.	a ₁ mm	a ₂ mm	b ₁ mm	b ₂ mm	l mm	EAN-No. 4000896+
600 N-21	13.7	8.5	30.0	45.0	292.0	023141
600 N-22	14.0	8.5	31.5	47.0	304.5	023158
600 N-23	14.3	9.5	33.0	49.0	328.0	023165
600 N-24	14.7	9.5	34.5	51.0	328.0	023172
600 N-25	15.0	10.0	36.0	53.5	354.0	023189
600 N-26	15.5	10.0	37.5	55.0	354.0	023196
600 N-27	16.0	10.5	39.0	57.0	380.0	023202
600 N-28	16.5	11.0	40.5	59.0	380.0	023219
600 N-29	17.0	11.5	41.5	60.0	380.0	023226
600 N-30	17.5	12.2	43.0	63.0	405.5	023233
600 N-32	18.0	12.0	45.5	66.5	420.0	023240
600 N-34	19.0	13.0	48.5	67.0	432.0	023257
600 N-36	20.0	13.0	51.8	75.0	460.0	023264
600 N-41	20.6	14.0	58.8	85.0	500.0	023271

450 N
Double open-end wrench

- Slim heads
- Head set at 15°

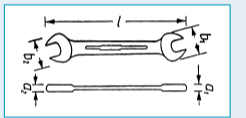
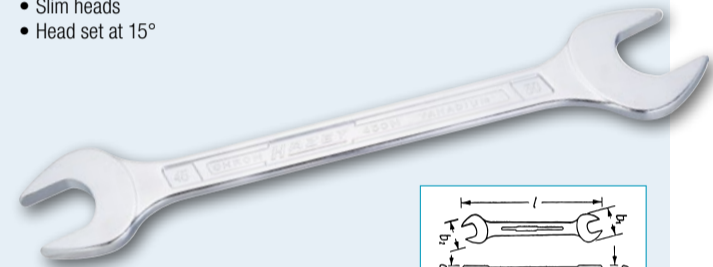

Made in Germany

HAZET No.	a mm	b ₁ mm	b ₂ mm	l mm	EAN-No. 4000896+
450 N-17 x 19	6.7	37.4	40.6	220.9	020478
450 N-18 x 19	6.7	38.6	40.6	221.2	020485
450 N-20 x 22	7.0	43.9	47.8	238.9	020515
450 N-21 x 22	7.0	44.8	46.8	238.0	020522
450 N-21 x 23	7.1	44.8	48.8	246.0	020539
450 N-22 x 24	7.1	47.8	51.9	254.6	020553
450 N-24 x 26	7.8	50.9	54.9	269.4	020560
450 N-24 x 27	7.8	50.9	57.0	269.0	020577
450 N-25 x 28	8.4	53.4	59.0	284.2	020584
450 N-27 x 32	9.1	58.0	67.3	303.8	020607
450 N-30 x 32	9.0	63.4	67.3	303.4	020614
450 N-32 x 36	10.1	66.9	75.2	343.2	020638
450 N-34 x 36	10.1	67.9	74.5	343.2	020645
450 N-36 x 41	10.5	74.6	81.1	396.7	020652
450 N-41 x 46	11.4	85.5	94.4	439.5	020669
450 N-46 x 50	12.3	94.3	102.2	498.0	020676

606
Ratcheting combination wrench

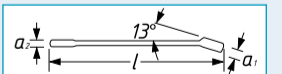
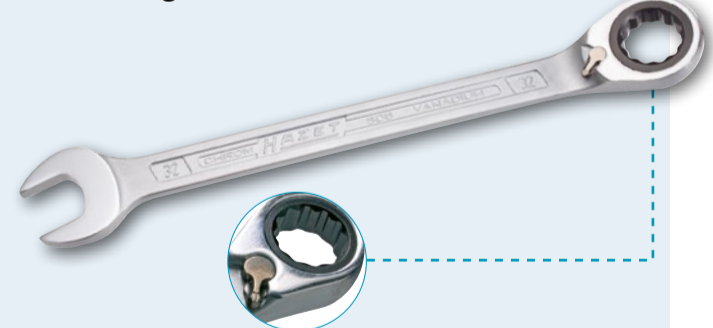

HAZET No.	S mm	a ₁ mm	a ₂ mm	l mm	EAN-No. 4000896+
606-13	13	8.9	6.7	193.2	100996
606-14	14	9.3	7.1	204.6	101009
606-15	15	9.7	7.4	218.0	101016
606-16	16	10.2	7.7	230.2	101023
606-17	17	10.6	8.1	242.2	101030
606-18	18	11.0	8.5	255.0	101047
606-19	19	11.5	9.1	268.3	101054
606-21	21	13.3	12.0	291.5	151233
606-22	22	13.3	12.0	291.5	151028
606-24	24	14.8	12.5	333.1	151011
606-27	27	15.8	14.7	359.2	151004
606-30	30	17.3	15.2	402.5	150991
606-32	32	17.8	15.7	425.8	150984

606
Ratcheting combination wrench sets

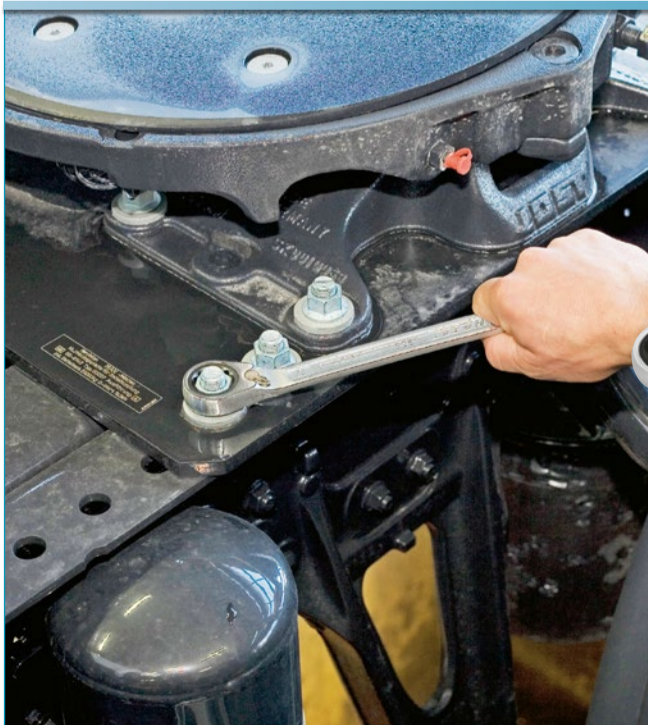

HAZET No.	Contents	EAN-No. 4000896+
606/5	5 x s 8 · 10 · 13 · 17 · 19 mm	177998
606/6-1	6 x s 21 · 22 · 24 · 27 · 30 · 32 mm	175178

986/9N, 992/9 Screwdriver socket set

12 1/2 9

- With TIN-coated blades
- Short design
- With knurling
- SmartCase (1/9) 165-S
- Surface: TIN coated
- Dimensions (L x W x H): 185 x 153 x 52 mm



HAZET No.	Output	Contents	EAN-No. 4000896+
986/9N	⊖	5 · 6 · 7 · 8 · 9 · 10 · 12 · 14 · 17 mm	193530
992/9	⊕	T20 · T25 · T27 · T30 · T40 · T45 · T50 · T55 · T60	051540

2272/23 N, EAN-No. 4000896192687 Impact bit screwdriver set

⊕ ⊖ ⊕ ⊖ 8 5/16 23

- For impact loosening and tightening tight screw connections
- Switchable (right- and left-hand threads)
- Pretension impact screwdriver by rotating the handle left (loosening or right-hand thread) or right (tightening or left-hand thread) before every impact. Hit the head section of the impact screwdriver with a 300 g hammer
- No electricity, compressed air or other resources needed
- Dimensions (L x W x H): 185 x 153 x 52 mm



- 2206 · ⊕^{1/4} · ⊖
5 · 6 · 8 · 10 mm
- 2217 · ⊕^{1/4} · ⊕
PH2 · PH3 · PH4
- 2224 · ⊕^{1/4} · ⊕
T30 · T40 · T45 · T50
- 2210 · ⊕^{1/4} · ⊖
0.8 x 5.5 · 1 x 5.5 · 1.2 x 6.5
1.6 x 8 · 2 x 12 mm
- 2272 · ⊕^{1/4}

2100/10 P

EAN-No. 4000896011506

Offset screwdriver set

Metric dimensions 2100 · ⊖
2 · 3 · 4 · 5 · 6 · 7 · 8 · 9 · 10 · 12 mm



Made in Germany

2115-T/13 P

EAN-No. 4000896012107

Offset screwdriver set

2115 · ⊕
T7 · T8 · T9 · T10 · T15 · T25 · T27 · T30 · T40 · T45 · T50 · T55 · T60



Made in Germany

1000, EAN-No. 4000896000616 Socket set

⊖ 20 3/4 20 3/4 15

- Sheet metal box (HAZET-blue)
- Soft foam insert
- Dimensions (L x W x H): 578 x 235 x 88 mm

- 1017-8 · 20 3/4 · 20 3/4
- 1018 · 20 3/4 · 20 3/4
- 1000 · 20 3/4 · ⊖
22 · 24 · 27 · 30 · 32
36 · 38 · 41 · 46 · 50 mm
- 1015-1 · 20 3/4
- 1014
- 1016 · 20 3/4



Made in Germany

1100 Z, EAN-No. 4000896002504 Socket set

⊖ 25 1" 25 1" 17

- With 12-point sockets
- Sheet metal box (HAZET-blue)
- Dimensions (L x W x H): 759 x 305 x 115 mm

- 1117 · 25 1" · 25 1"
1117-8 · 1117-16
- 1121 · 25 1" · 25 1"
- 1100Z · 25 1" · ⊖
32 · 36 · 41 · 46 · 50 · 55
60 · 65 · 70 · 75 · 80 mm
- 1115-1 · 25 1"
- 1114
- 1116 · 25 1"



Made in Germany

Screwdriver bit set

⊕ 6.3 1/4 ⊕ ⊖ ⊕ ⊖ 51

- Long-lasting screwdriver bits clamp for firm and secure hold and quick access
- Clear labelling of the individual screwdriver bit designs and sizes
- Optimal utilisation of the available storage space with small dimensions
- Specially developed hinge design enables the BitE-Box to be set up at right angle (90°) and in a fully open position (180°). Hence better overview and faster access for the user
- Staggered arrangement of the screwdriver bits (interleaved) ensures tremendous space saving in the top and bottom of the BitE-Box
- Dimensions (L x W x H): 125 x 85 x 40 mm



Made in Germany

2240 N/51, EAN-No. 4000896187607

- 2204 · ⊕^{1/4} · ⊖
2 · 2.5 · 3 · 4 · 5 · 6 mm
- 2216 · ⊕^{1/4} · ⊕
PZ1 · PZ2 · PZ3
- 2223 · ⊕^{1/4} · ⊕
T10H · T15H · T20H
T25H · T27H · T30H
- 2208 · ⊕^{1/4} · ⊖
0.5 x 4 · 0.6 x 4.5
0.8 x 5.5 · 1 x 6 mm
- 2223 · ⊕^{1/4} · ⊕
T6 · T7 · T8 · T9
T10 · T15 · T20 · T25
T27 · T30 · T40
- 2215 · ⊕^{1/4} · ⊕
PH1 · PH2 · PH3
- 2239-6 · ⊕^{1/4} · ⊕^{1/4}

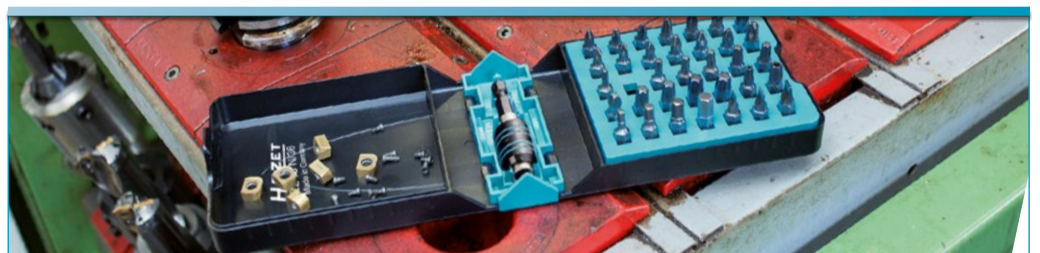

2240 N/36, EAN-No. 4000896187614

Screwdriver bit set

- Dimensions (L x W x H): 125 x 85 x 40 mm

- 2204 · ⊕^{1/4} · ⊖
3 · 4 · 5 · 6 mm
- 2223 · ⊕^{1/4} · ⊕
T10 · T15 · T20 · T25
T27 · T30 · T40
- 2208 · ⊕^{1/4} · ⊖
0.6 x 4.5 · 0.8 x 5.5 ·
1 x 6 mm
- 2223 · ⊕^{1/4} · ⊕
T20H · T30H
- 2215 · ⊕^{1/4} · ⊕
PH1 · PH2 · PH3
- 2216 · ⊕^{1/4} · ⊕
PZ1 · PZ2 · PZ3
- 2239-6 · ⊕^{1/4} · ⊕^{1/4}

Made in Germany

Want even more power!

NEW!

Then loosen your 1/2" screwed connection now with our new 3/4" power innovation.

How it works: Take, for example, our 3/4" impact wrench 9013 M and connect our adapter 1003 S-1 to the square. At the other end, connect our new sockets s 17/s 19 mm with new 6-point socket and away you go!

Our quality guarantee:
Made in Germany!

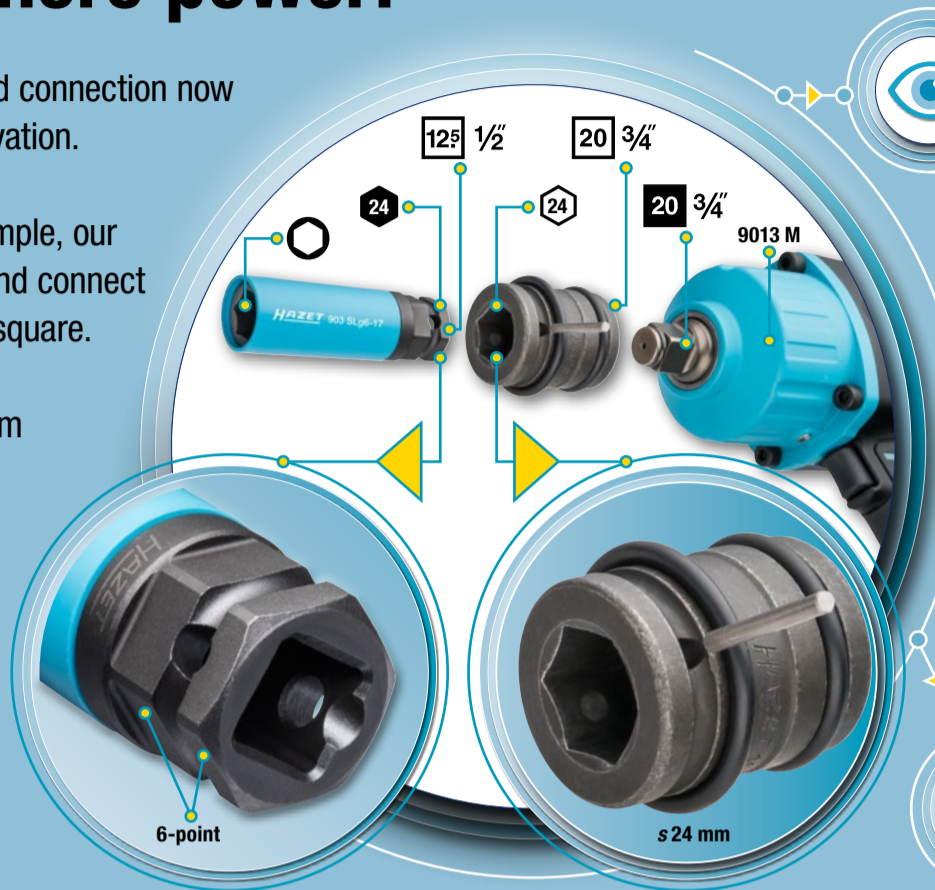

Innovative product development

Very close to the world's first

Even faster operations

Through new problem solving

High power transmission

3/4" Through 1/2"-Power

Quality guarantee: Made in Germany!

Impact socket (6-point)

- Operation via impact adapter e.g. HAZET 1003S-1 or nut-driver s 24 mm enables high force transmission
- Especially stiff wheel bolts can be loosened more easily via an optional 3/4" impact wrench
- Especially suitable for vans and light trucks, e.g. FIAT Ducato, MERCEDES-BENZ Sprinter
- Outside 6-point mounted on the socket enables adaptation to 3/4" drive
- Plastic casing protects rims against scratches

903 SLg6-19, EAN-No. 4000896223589



12⁵ 1/2" 24

Made in Germany

s 19 mm

903 SLg6-17, EAN-No. 4000896223596

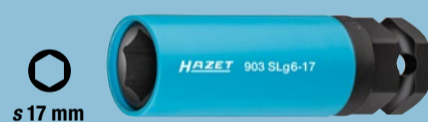

12⁵ 1/2" 24

Made in Germany

s 17 mm

903 SLg6/5, EAN-No. 4000896223602

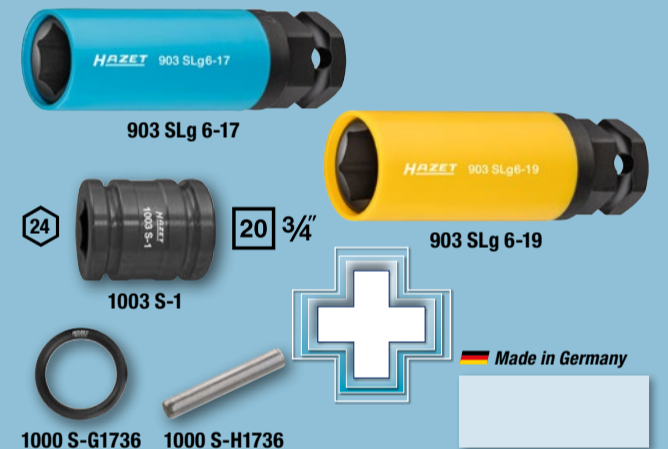

12⁵ 1/2" 20 3/4" 24 24 5

Made in Germany

916 HP, EAN-No. 4000896213894

Fine-tooth reversible ratchet

- Small operating angle (4°) enables even better use in the tightest of spaces
- 90 teeth, 4° fine teeth for confined spaces
- Locking function of the lever prevents unwanted switch
- A lot more performance with the same dimensions
- Increased service life thanks to the use of state-of-the-art lubricants in the ratchet mechanism
- Strict production tolerances ensure protection against penetration by dirt.
- HAZET internal quality standards guarantee loading capacity way beyond what you would normally expect
- Chrome-plated surface: high-quality, easy to clean, corrosion resistant
- Length: 275 mm
- Weight: 595 g



HiPer
HIGH PERFORMANCE

1000 Nm!
Power and precision in perfect symbiosis!

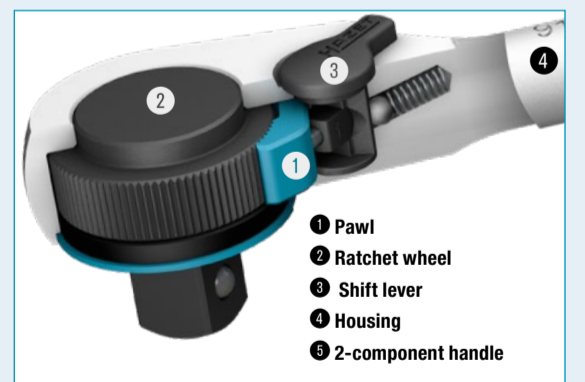

12⁵ 1/2"

90

4°

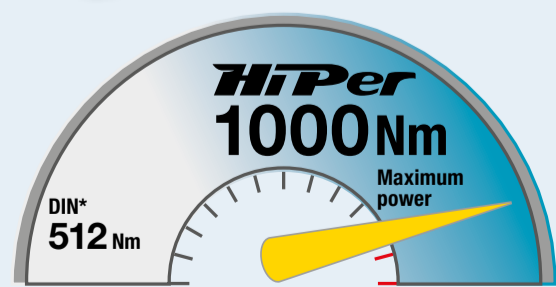

Max. torque

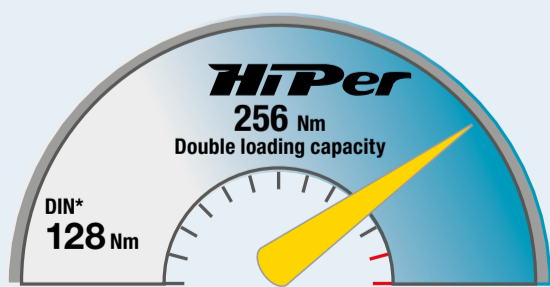

Loading capacity



Operations



YouTube clip

Made in Germany

*DIN 3122:2017-04



167 XXL, EAN-No. 4000896210565 Assembly trolley XXL *Assistent*

- Flexible and stable for all purposes
- With an intermediary tray as standard
- Intermediary tray: Adjustable in 12 height positions in 38 mm steps in order to easily set aside spare parts and workpieces, for example
- More intermediary trays are optionally available
- Worktop: wood multiplex birch, replaceable
- Face-side perforated tool panels for attaching accessories
- Robust sheet-steel design
- Loading capacity working top 300 kg, intermediate tray 50 kg, ground compartment 80 kg
- Large ball-bearing wheels (Ø 125 mm)
- 2 swivel castors Ø 125 mm (2 x with dual brake), 2 fixed castors
- With thread guard – protects the bearings against dirt and threads
- Easy manoeuvrability, even with high dynamic load
- Grey non-marking elastic tyres enable smooth movement
- Sturdy handle, firmly attached to the trolley
- Maximum loading capacity (dynamic): 500 kg

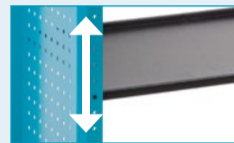
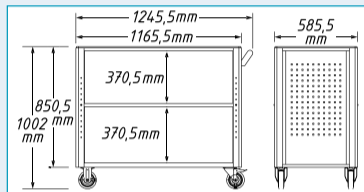

Intermediary tray adjustable in 12 positions (steps: 38 mm)



- 500 kg
- h x w x d: 1002 x 1245 x 585.5 mm
- 63.9 kg



YouTube clip

Made in Germany



167-3, EAN-No. 4000896205332 Service trolley *Assistent*

- Flexible and stable for all purposes
- Centre layer adjustable in 15 heights creates space for e.g. canisters
- More layers and anti-slipping mats (2 x 180-38) are optionally available
- Robust sheet-steel design, loading capacity per layer: 50 kg
- Large ball-bearing wheels (Ø 100 mm), 2 swivel castors (1 x with dual brake), 2 fixed castors
- With thread guard – protects the bearings against dirt and threads
- Easy manoeuvrability, even with high dynamic load
- Grey non-marking elastic tyres enable smooth movement
- Sturdy handle, firmly attached to the trolley
- Suitable for HAZET Safety-Insert-System, 2-component soft foam insert
- Loading capacity (per layer): 50 kg

Suitable for two 3/3+ tool inlays per layer

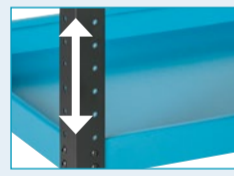
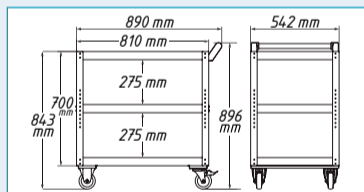

Adjustable in 15 heights



- 3 x 50 kg
- h x w x d: 843 x 890 x 542 mm
- 2 x 3/3+/layer



YouTube clip

Made in Germany



167 T, EAN-No. 4000896210503 Multi table *Assistent*

- With sturdy impact protection on all important struts for protecting important areas, e.g. body and high quality rims
- Table can be collapsed downwards by 90°
- Adjustable in 15 height positions (steps: 25 mm)
- Robust welded design
- Ball-bearing-mounted wheels (Ø 50 mm)
- 4 swivel castors, 2 castors with brake
- Easy manoeuvrability, even with high dynamic load
- Grey non-marking elastic tyres enable smooth movement
- Fits under vehicles with a ground clearance greater than 130 mm
- Loading capacity of table: 35 kg
- Maximum loading capacity (dynamic): 150 kg
- Delivery, flatly packed (H x W x D approx.): 110 x 930 x 780 mm

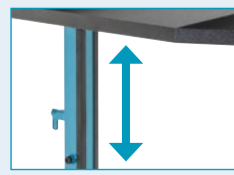
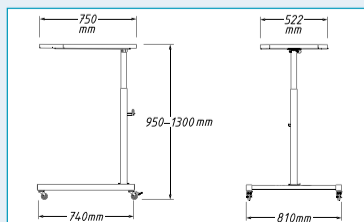

Adjustable in 15 height positions (steps: 25 mm)



Can be collapsed downwards by 90°

- 35 kg
- h x w x d: 950-1300 x 750 x 522 mm
- 17.9 kg



YouTube clip

Made in Germany

Here is your personal assistant



166C, EAN-No. 4000896072286

h x w x d:
1102 x 725 x 398 mm

27.6 kg

Made in Germany



178N-7, EAN-No. 4000896202782

h x w x d:
1037 x 781 x 498 mm

74.1 kg

Made in Germany



179NW-7, EAN-No. 4000896219629

h x w x d:
965 x 1150 x 600 mm

120 kg

Made in Germany

Design your trolley how you like!

Your perfect organisation system for your tool trolley. Snugly embedding for all your tools.

Endless combination options mean you can arrange your trolley according to your needs.

You can find more inserts at:
www.hazet.de

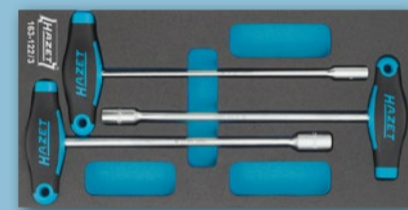

163-122/3, EAN-No. 4000896153534
T-handle 6-point socket set
• 3-piece, s 8, 10, 13 mm

1/3			
-----	--	--	--



163-224/57, EAN-No. 4000896176311
Socket/ screwdriver set
• 57-piece

2/3			
-----	--	--	--

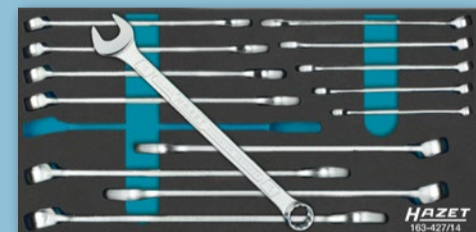

163-427/14, EAN-No. 4000896202553
Combination wrench set
• 600 N, 6 - 19

1/3			
-----	--	--	--

Made in Germany



163-191/18, EAN-No. 4000896162307
Socket set
• 900, 10-27; 916 SP, 917-5, 918-10, 920

1/3			
-----	--	--	--

Made in Germany



163-406/20, EAN-No. 4000896200054
Socket set
• 1000, 1014, 1015-1, 1016, 1017-8, 1018

3/3			
-----	--	--	--

Made in Germany



163-210/19, EAN-No. 4000896164714
Combination wrench set
• 19-piece, s 8 - 34 mm

3/3			
-----	--	--	--

Made in Germany



Our quality guarantee: Made in Germany!

179NX-7, EAN-No. 4000896215577

h x w x d:
1020 x 786 x 518 mm

7x

90 kg

Made in Germany

179NX-8, EAN-No. 4000896215584

h x w x d:
1020 x 786 x 518 mm

7x

90 kg

Made in Germany

179NXL-7, EAN-No. 4000896215164

h x w x d:
1020 x 518 x 959 mm

7x

125 kg

Made in Germany

179NXL-8, EAN-No. 4000896215218

h x w x d:
1020 x 518 x 959 mm

8x

125 kg

Made in Germany

179NXXL-7, EAN-No. 4000896214624

h x w x d:
1020 x 959 x 518 mm

7x

145 kg

Made in Germany

179NXXL-8, EAN-No. 4000896214778

h x w x d:
1020 x 959 x 518 mm

8x

145 kg

Made in Germany

Optionally with stainless steel or plastic worktop



179N

179NX

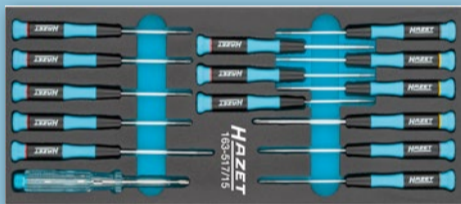

163-517/15, EAN-No. 4000896218745

Electronic screwdriver set

- 15-piece, ⌀ 839-1; ⌀ 808 T5, T6, T7, T8, T9, T10, T15; ⌀ 805-015, -020, -025, -030; ⌀ 805 PH-00, -PH-0, -PH-1

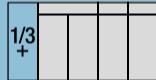

163-385/12, EAN-No. 4000896196944

Ratcheting combination wrench set

- 12-piece ⌀ s 8 – 19 mm



163-297/26, EAN-No. 4000896186242

Screwdriver set

- 26-piece ⌀ ⚙ ⚙ ⚙

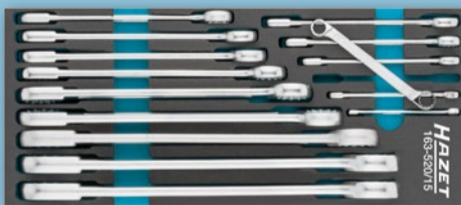

163-520/15, EAN-No. 4000896218677

Double box-end wrench set

- 15-piece ⌀ s 6 x 7 · 8 x 9 · 10 x 11 · 12 x 13 · 14 x 15 · 16 x 17 · 18 x 19 · 20 x 22 · 21 x 22 · 21 x 23 · 24 x 26 · 25 x 28 · 27 x 32 · 30 x 32 · 30 x 34 mm



Made in Germany



163-211/20, EAN-No. 4000896164707

Wrench / socket set

- 20-piece ⌀ s 8 x 9 – 34 x 36 mm; ⌀ T60, T80, T100; ⌀ s 14, 17, 19, 22 mm



Made in Germany



163-257/4, EAN-No. 4000896179220

Pliers set

- 4-piece



Made in Germany



163-518/9, EAN-No. 4000896218707

Double box-end wrench set

- 9-piece ⌀ s 6 x 7 · 8 x 9 · 10 x 11 · 12 x 13 · 14 x 15 · 16 x 17 · 18 x 19 · 20 x 22 · 21 x 23 mm



Made in Germany



163-266/6, EAN-No. 4000896180615

TORX® screwdriver set

- ⌀ T10–T30

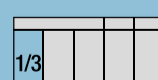

Made in Germany



163-299/8, EAN-No. 4000896186723

Drift pin set

- ⌀ s 3–6 mm; ⌀ s 3–8 mm; ⌀ 320 mm, 500 g



Made in Germany

Tool trolley or workbench: Your decision!

179 NW-8/244, EAN-No. 4000896223046

**Work bench *Assistent*
with assortment**

h x w x d:
964 x 1150 x 600 mm

**244 expert tools!
8 drawers filled!**

179 NX-8/244, EAN-No. 4000896223039

**Tool trolley *Assistent*
with assortment**

h x w x d:
1020 x 786 x 518 mm

or



Made in Germany



Made in Germany



3/3+

244

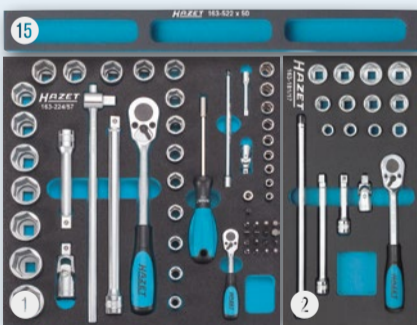

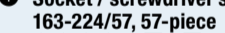
1 **Socket / screwdriver set 163-224/57, 57-piece**

 1/4 s 5.5–13 mm 1/2 s 10–32 mm

2 **Socket set 163-181/17, 17-piece**

 3/8 s 10–22 mm

3 **Combination wrench set 163-210/19, 19-piece**

 s 8–34 mm

4 **Tool set 163-211/20, 20-piece**

 s 8 x 9–34 x 36 mm

5 **Double box-end wrench set 163-296/7, 7-piece**

 s 6 x 7–21 x 22 mm

6 **Screwdriver set 163-297/26, 26-piece**



7 **Ratcheting combination wrench set 163-385/12, 12-piece**

 s 8–19 mm

8 **Screwdriver socket set 163-407/35, 35-piece**

 1/2 s 5–22 mm · M5–18 mm · T20–60

9 **Pliers set 163-257/4, 4-piece**

10 **TORX® Screwdriver set 163-380/4, 4-piece**

 T15–T30

11 **Socket set 163-382/3, 3-piece**

 s 8, 10, 13 mm

12 **TORX® Screwdriver set 163-182/9, 9-piece**

 T6–T30

13 **Universal set 163-372/25, 25-piece**

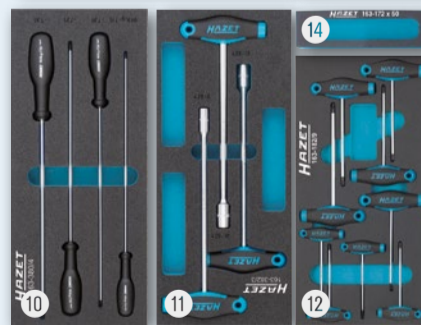
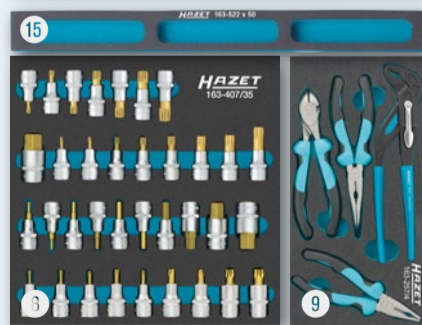
14 **Soft foam insert with compartment for small pieces 163-172 x 50**

15 **Soft foam insert with compartments for small pieces 163-522 x 50 (5 x)**



Your HAZET specialist dealer

0-179/244, EAN-No. 4000896204236

Tool assortment, individual

• 244 expert tools

