

Beta



2023

NAGYKERESKEDELMI ÁRJEGYZÉK

KIZÁRÓLAG NEM TERMÉSZETES SZEMÉLYNEK MINŐSÜLŐ VÁSÁRLÓK RÉSZÉRE.
AZ ÁRAK A 27%-OS ÁFA-T NEM TARTALMAZZÁK.
ÉRVÉNYES: 2024. JANUÁR 31-IG.
A NYOMDAI HIBÁKÉRT FELELŐSSÉGET NEM VÁLLALUNK.

**A BETA ÉRTÉKEI
ELSZÁNTSÁG. ELKÖTELEZETTSÉG. HARMÓNIA. TEHETSÉG.**



A Beta-nál a dolgokat csak egyféleképpen csinálhatjuk: jól.

Ez a Beta világa, és ez az elv vezérli mindennapi munkánkat világszerte.
Ennek során pedig négy alapértékünkre támaszkodunk:

ELSZÁNTSÁG hogy egy olasz mesterember által 1923-ban létrehozott, azóta az egész világon ismertté vált és négy generáció óta folyamatosan növekvő vállalkozásba fektessünk és azt folyamatosan megújítsuk.

ELKÖTELEZETTSÉG a termékeink minősége iránt, mert minden viszonteladó partnerünk tudja, hogy hatékony kiszolgálásra számíthat, ahogy minden felhasználó tudja, hogy számíthat a precíziós, megbízható és robusztus Beta termékekre.

HARMÓNIA a vonalvezetésben a tökéletes konstrukcióért, mert ha valamit jól csinálunk, az a funkció és design tökéletes egyensúlyát eredményezi.

TEHETSÉG a legnagyobb kincsünk, mert ez jellemez minden munkatársunkat és szakembert, aki a Beta-t választja. Hogy semmit sem bíz a véletlenre ötleteinek és álmainak elkötelezett és szenvedélyes megvalósításában.



TARTALOM



Tartalomjegyzék.....	4
Olvasási útmutatás	8
Nyomatékulcsok húzási nyomatéktartománya	58-59
Táblázat szerszámokhoz és készletekhez	341, 441-442
Megszűnt cikkek - Ajánlott cikkek	684÷686
Tartalomjegyzék betűrendben	687÷692
Autószerelő szerszámok	693÷694
Tartalomjegyzék cikkszám szerint	695÷709
Beta csoport	710
Az olasz szerszámkészítés története	711
Tanúsított minőség	712
Kontroll és minőség	713
Logisztika.....	714
Munkaszervezés.....	715
Hatékony jelenlét.....	716

INDEX

RSC55 MŰHELYBERENDEZÉS



RSC55

398÷422

DUGÓKULCSOK ÉS TARTOZÉKOK



70÷78

85÷111

C45PRO MŰHELYBERENDEZÉS



Beta
C45PRO

423÷440

NYOMATÉKKULCSOK ÉS NYOMATÉKSOKSZOROZÓK



54÷56

57÷70

MŰHELYBERENDEZÉSEK ÉS KÉSZLETEK



341÷359

Beta
RSC



360÷370



371÷397



441÷520

CSAVARHÚZÓK, IMBUSZCSAVARHÚZÓK ÉS CSAVARHÚZÓBETÉTEK



18÷24

78÷85

115÷117

146÷159

FOGÓK

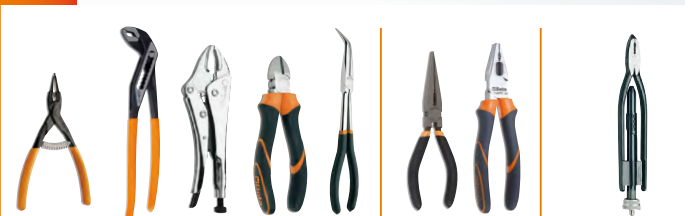

128÷132

140÷143

238

KULCSOK



11÷17

24÷27

111÷117

KALAPÁCSOK ÉS BEÜTŐSZERSZÁMOK



9-10

166÷170

220

FÚRÓ- ÉS MENETVÁGÓSZERSZÁMOK



36÷41

41÷44

44÷51

51÷53

LÁMPÁK



243÷248

LEHÚZÓK

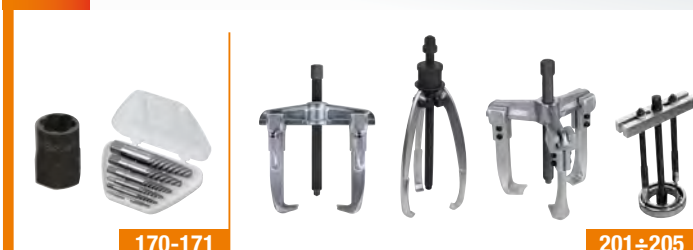

170-171

201÷205

KÁBELDOBOK



248÷250; 337

MÉRŐ- ÉS JELÖLŐESZKÖZÖK



213÷220

VÍZ- ÉS GÁZSZERELŐ SZERSZÁMOK

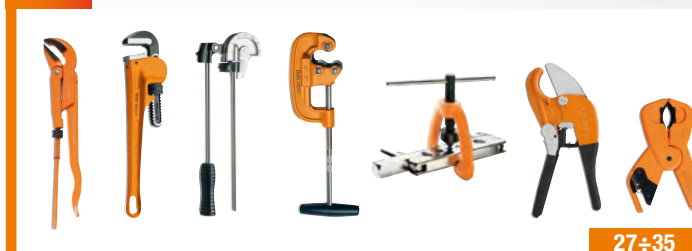

27÷35

VÁGÓSZERSZÁMOK ÉS ÁLTALÁNOS KARBANTARTÓ SZERSZÁMOK



123

133÷137

158-159

186

ELEKTRONIKAI ÉS MIKROMECHNIKAI SZERSZÁMOK



126-127

143÷145

149÷151

ELEKTROTECHNIKAI SZERSZÁMOK

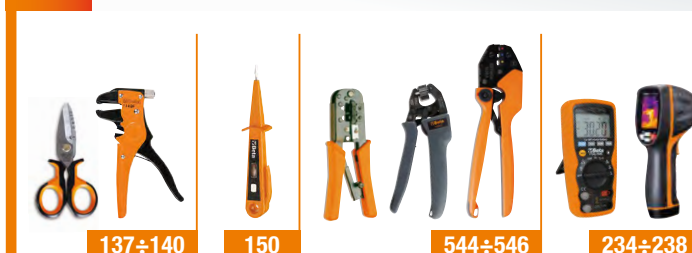

137÷140

150

544÷546

234÷238

212

221÷230

HEGESZTÉSTECHNIKAI



252÷256

239÷242

250÷251

1000V-IG SZIGETELT SZERSZÁMOK



287÷293

ROZSDAMENTES SZERSZÁMOK



301÷305

SZIKRAMENTES SZERSZÁMOK



306÷314

AUTÓJAVÍTÓ SZERSZÁMOK



117÷126

160÷166



170÷201, 231÷233

234÷239

MŰHELYBERENDEZÉS



256÷275

MOTORKERÉKPÁR-SZERELŐ SZERSZÁMOK



276÷281

KERÉKPÁRSZERELŐ SZERSZÁMOK



282÷286

AKKUMULÁTOROS GÉPEK



315÷317

PNEUMATIKUS SZERSZÁMOK ÉS TARTOZÉKOK



318÷340

LEESÉSVÉDETT SZERSZÁMOK



294÷300

BETA VEGYIÁRUK



521÷526

MUNKAVÉDELMI CIPŐK ÉS ZOKNIK



583÷611

BETA CSISZOLÓANYAGOK



527÷543

MUNKARUHÁZAT



612÷630

BM MÁRKANÉVEN KAPHATÓ TERMÉKEINK



547÷553

BLISTER



554÷568

ROBUR-RÖGZÍTÉSTECHNIKAI SZERELVÉNYEK



631÷671

ÁLLVÁNYOK ÁRUHÁZAKBA, BEMUTATÓTERMÉKBE



569÷582

BETA-KOLLEKCIÓ



672÷683

OLVASÁSI ÚTMUTATÁS

Katalógusszám

1048N

vízpumpafogó,
csúszásmentes PVC bevonatú nyéllel

Szerszám profil



Egységár

★ Ajánlatkérésre szállítható cikk

• Fő méret

○ Hatszögű

ISO 8976

Méret

Egységcsomag

L mm	A max mm	L1 mm	S mm	Ft	csomag	csomag
175	36	31	11	11.500	3	010480910
250	46	38	13	12.450	5	010480915
300	60	44	14.8	18.400	2	010480920

Blister-áruházi
polccsomagolás



Motorkerékpár-szerelő
szerszámok



Kerékpárszerelő
szerszámok



Cikkszám

1048N/D3

vízpumpafogó készlet
foszfátzott fej

Darab

Csomagolásmód jelölése

Szerszámok mennyisége
a készletben

1048N/D3	Ft	csomag	csomag
-175-250-300 mm	42.350	1	010480923

Új termék – 2023

A leggyakrabban használt jelölések jelentése

Például

készleteknél		Például
B	= műanyag táskában	42/B9N
BV	= üres tasak/táska	2002/BV9
C	= fémdobozban	900/C11
D	= felfüggeszthető csomagolás	1293/D6
S	= kartondobozban	42/S17
SP	= tartó állvánnyal	42/SP25
SPV	= üres tartó állvány	42/SPV7
SC	= tartó állvány	96/SC9
SCV	= üres tartó	96/SCV

készleteknél		Például
AS	= coll méretű szerszámok	5915VU/AS
E	= elektronika/elektrotechnika	5980ET/A
I	= vízvezeték-szereléshez	5980ID
MT	= földmunkagépekhez	5902MT
U	= általános szereléshez	5915VU/3
SBK	= motorkerékpár javítás	5940SBK
VG	= autószereléshez	5904VG/5T
VI	= ipari szereléshez	5902VI

dugókulcsbetéteknél		Például
A	= hatszögprofilú	910A
B	= tizenkétszögprofilú	910B
ES	= hornyolt profilú	920ES
FTX	= TORX® profilú	910FTX

A leggyakrabban használt jelölések jelentése

Például

PT	= 5-lapú csavar	910PT
X	= irányváltós racsní (fémdobozban)	920A/C12X

Csavarhúzóknál és csavarhúzóbetéteknél

LP	= egyenes hornyú csavarokhoz	920LP
PE	= hatszöghornyú csavarokhoz	920PE
PH	= PHILLIPS®-csavarokhoz	920PH
PZ	= POZIDRIV®- és SUPADRIV®-csavarokhoz	1299PZ
RTX	= TAMPER-RESISTANT-TORX®-csavarokhoz	1298RTX
SP	= SPANNER csavarhúzóbetétek	861SP
TRW	= TRI-WING®-csavarokhoz	861TRW
TQS	= TORQ-SET®-csavarokhoz	861TQS
TX	= TORX®-csavarokhoz	920TX
XZN	= XZN®-csavarokhoz	920XZN

általánosságban

AS	= coll-méret	42AS
BA	= szikramentes szerszámok	42BA
BM	= bimateriális nyél	1150BM
C	= üres kocsi	C25
HS	= Leesésvédett szerszámok	42HS
INOX	= Szerszámok nemesacélból	42 INOX
L	= hosszú kivitel	952L
MQ	= 1000V szigetelésű szerszámok	1150MQ
MP	= fényes krómozott	42MP
R	= szár három anyagból	338R

A nyomtatott képek tájékoztató jellegűek.

Beta Utensili cég fenntartja magának azt a jogot, hogy áruválasztékán előzetes bejelentés nélkül változtatást hajtson végre.



Beta FELHÍVJA a figyelmet a szerszámok rendeltetészerű használatára és a személyi biztonság érdekében a vonatkozó előírások betartására.



KIÜTŐK

A Beta ütőszerszámait arra tervezték, hogy optimális teljesítményt nyújtsanak és biztosítsák a felhasználók biztonságát.

Gyártásukhoz speciális típusú acélt használnak amely krómot, molibdént és vanádiumot (65CrMoV2-2) tartalmaz, és így rendkívül kemény és ellenálló szerszámok jönnek létre. A termékek – ha geometriai formájuk lehetővé teszi – húzott rudakból készülnek; egyéb esetekben a salakképződés elkerülése érdekében ellenőrzött légkör mellett forró kovácsolással alakítják ki a szerszámokat.

- 1** A hatszögprofil megakadályozza, hogy a szerszám elgördüljön a tartófelületen
- 2** A kiütők rendkívül hosszú, és mégis tökéletesen egyenes szárral rendelkeznek, hogy szűk helyekhez is hozzá lehessen fénni velük
- 3** Annak érdekében, hogy a kiütők méretezése megfelelő legyen, a nagyobb hatékonyság érdekében minden egyes darab ütőfelülete úgy van kialakítva, hogy van egy egységes hengeres része és egy tökéletesen lapos vége.
- 4** Az összes ütőfelületet indukciós temperálásnak vetik alá, hogy megakadályozzák a szilánkos törést; az ütőpont deformálódása természetes következmény, így biztosítani lehet a szerszám használójának biztonságát.



A pontozókat és a kiütőket krómozás után élezik, hogy jobb véső és vágó teljesítményt nyújtsanak, és eltávolítsák a hegyekről a galvanikus lerakódásokat. A főleg lerakódásokat el kell távolítani, hogy megakadályozzuk a sarkok „lekerekedését” és ridegségét a galvanizálás során keletkező hidrogén mennyisége miatt. A megmunkált területeket rozsdamentes réteg védi.



30 Kiütő



Ø mm	L mm	Ft	☞	☞
2	125	2.860	10	000300020
3	125	2.860	10	000300030
4	150	3.790	10	000300040
5	150	3.790	10	000300050
6	150	3.980	10	000300060

31 Hosszú kiütő

Hosszú kiütő



Ø mm	L mm	L1 mm	Ft	☞	☞
2	110	22	2.920	10	000310002
3	128	35	2.980	10	000310003
4	146	45	3.660	10	000310004
5	164	55	3.800	10	000310005
6	182	65	4.790	5	000310006
8	200	80	5.040	5	000310008
10	220	95	6.370	5	000310010



31/B6N	Ft	☞	☞
31/B6N 2-3-4-5-6-8 mm	26.750	1	000310024
2002/BV6	3.580	1	020020000
31/SP6 2-3-4-5-6-8 mm	27.300	1	000310030
31/SPV	5.970	1	000310031

31BM Kiütő nyéllel

Kiütő nyéllel



Ø mm	L mm	L1 mm	Ft	☞	☞
2	168	42	5.720	2	000310402
3	180	52	5.970	2	000310403
4	191	62	6.480	2	000310404
5	200	72	6.710	2	000310405
6	221	82	7.900	2	000310406
8	235	94	8.220	2	000310408



31BM/D6	Ft	☞	☞
31BM/D6 2-3-4-5-6-8 mm	41.000	1	000310420

31L

Extra hosszú kiütő



Ø mm	L mm	L1 mm	Ft	csomagolás	alkotórész
4	175	80	4.230	5	000310104
5	175	80	4.500	5	000310105
6	175	80	5.410	5	000310106

31SE

Vezetőcsapos kiütő



Ø mm	D mm	L mm	L1 mm	Ft	csomagolás	alkotórész
4	2,4	175	80	4.230	5	000310204
5	3,0	175	80	4.510	5	000310205
6	3,6	175	80	5.370	5	000310206



alkotórész	Ft	csomagolás	alkotórész
31/B6N-LSE	31.850	1	000310324
31L: 4-5-6 mm			
31SE: 4-5-6 mm			
2002/BV6	3.580	1	020020000

32

Pontozó, krómozott



Ø mm	L mm	L1 mm	Ft	csomagolás	alkotórész
3	100	44	2.600	10	000320100
4	125	52	3.220	10	000320125
5	150	62	4.000	10	000320150

32AU

Automata pontozó, barnított, krómozott

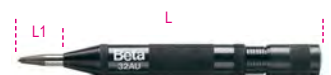

Ø mm	L mm	L1 mm	Ft	csomagolás	alkotórész
3	150	23	22.000	2	000320160

32AUR

Tartalékhegy a 32AU-hoz



Ø mm	Ft	csomagolás	alkotórész
3	3.700	5	000320170

34

Laposvágó, standard kivitel, krómozott



L mm	A mm	L1 mm	Ft	csomagolás	alkotórész
125	14,5	45	4.050	5	000340001
150	17,0	58	5.430	5	000340002
175	21,5	68	7.730	5	000340003

35

Erősített laposvágó, krómozott



L mm	A mm	Ft	csomagolás	alkotórész
100	14,5	4.760	5	000350001
125	17,0	5.360	5	000350002
150	20,5	6.660	5	000350003
200	23,0	10.050	5	000350004
250	28,5	14.300	2	000350005
300	34,0	19.750	2	000350006

35PM

Erősített laposvágó, kézvédővel



L mm	A mm	Ft	csomagolás	alkotórész
200	23,0	15.100	2	000350014
250	28,5	19.350	2	000350015
300	34,0	25.450	2	000350016

35PMR

Tartalék kézvédő a 35PM-hez



L mm	Ft	csomagolás	alkotórész
200	5.040	1	000350024
250	5.040	1	000350025
300	5.680	1	000350026

36

Keresztvágó, standard kivitel, krómozott



L mm	A mm	L1 mm	Ft	csomagolás	alkotórész
125	4	44	4.160	5	000360001
150	6	53	4.910	5	000360002

37

Erősített keresztvágó, krómozott



L mm	A mm	L1 mm	Ft	csomagolás	alkotórész
150	6	45	7.610	5	000370001
200	8	55	11.000	3	000370002

37PM

Erősített keresztvágó, kézvédővel

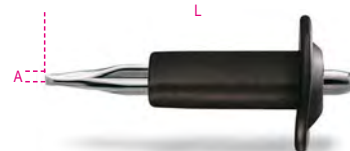

L mm	A mm	Ft	csomagolás	alkotórész
200	8	16.700	2	000370012

37PMR

Tartalék kézvédő a 37PM-hez



L mm	Ft	csomagolás	alkotórész
200	5.680	1	000370022



38/B6N



38/SP6

alkotórész	Ft	csomagolás	alkotórész
38/B6N	26.900	1	000380016
30: 2-3 mm			
32: 4 mm			
34: 125-150 mm			
36: 150 mm			
2002/BV6	3.580	1	020020000
38/SP6	28.050	1	000380009
30: 2-3 mm			
32: 4 mm			
34: 125-150 mm			
36: 150 mm			
38/SPV	7.520	1	000380019

ÚJ 42-ES CSILLAG-VILLÁSKULCSOK

A klasszikus 42-es csillag-villáskulcs formája megújult.

A karcsú profilnak köszönhetően a forma stílusos, vékony és kézreálló. A Beta csillag-villáskulcs robusztus, ellenálló és ergonomikus, a lehető legjobb szerszám. A kulcs a legmodernebb automatizációs technológiával és kitűnően képzett szakemberek felügyeletével Sovicóban és Sulmonában készül.

GYORSAN HASZNÁLHATÓ

A tengelyhez képest 15°-os szögnek köszönhetően kisebb a felvételi szög.

ELLENÁLLÓ

Erőssége figyelemreméltó: nem rendeltetésszerű használat esetén a kulcs deformálódik, de nem törik el hirtelen és veszélyes módon.

HOMOGEN

A félkész termék préselése során a száleloszlás egyenletessége megelőzi a veszélyes belső feszültségek kialakulását.

SZŰK HELYEN HASZNÁLHATÓ

A vékonyabb kialakításnak köszönhetően a szűk helyek is elérhetőek.

VÉDELEMEL ELLÁTOTT

A nikkel-króm bevonat sokáig ellenáll a külső behatásoknak és megfelel az ISO 2819 szabvány tapadóképeségi vizsgálatokra előírt szigorú követelményeinek.

ERŐS

A hosszabb erőkarnek köszönhetően az ISO 1711 szabványban előírt nyomaték kétszerese érhető el.

OPTIMALIZÁLT

A kulcs – amely hosszabb, mint a legtöbb versenytárs termékei – lehetővé teszi, hogy kisebb erőfeszítéssel nagyobb nyomatékot érjen el.



ERGONOMIKUS

A 15°-ban hajlított fej védi a kezét. A forma kialakítása öntéssel történik; nem később hajlítják meg.



42

csillag-villáskulcsok

Az elérhető nyomaték több mint a duplája az ISO 1711 szabványban elfogadottakhoz képest



DIN 3113 UNI-ISO 7738

mm	L mm	S1 mm	Ft	🔧	📄
5,5x5,5	95	3,4	2.570	5	000421005
6x6	95	3,4	2.580	5	000421006
7x7	105	3,6	2.600	5	000421007
8x8	116	3,9	2.650	5	000421008
9x9	127	4,2	2.730	5	000421009
10x10	137	4,5	3.030	5	000421010
11x11	148	4,8	3.200	5	000421011
12x12	158	5,1	3.290	5	000421012
13x13	169	5,6	3.330	5	000421013
14x14	180	5,7	3.590	5	000421014
15x15	190	6,0	3.930	5	000421015
16x16	201	6,3	4.150	5	000421016
17x17	212	6,8	4.460	5	000421017
18x18	222	7,0	4.730	5	000421018
19x19	233	7,5	4.930	5	000421019
20x20	243	7,7	5.300	3	000421020
21x21	254	7,9	5.750	3	000421021
22x22	264	8,3	5.950	3	000421022
23x23	275	8,5	6.420	3	000421023
24x24	285	8,7	7.020	3	000421024
25x25	296	8,7	7.160	2	000421025
26x26	307	8,9	7.600	2	000421026
27x27	317	9,1	8.350	2	000421027
28x28	328	9,3	8.480	2	000421028
29x29	338	9,5	9.250	2	000421029
30x30	349	9,7	9.720	2	000421030
32x32	370	10,1	11.000	2	000421032
34x34	391	10,5	21.450	1	000421034
35x35	412	10,7	22.500	1	000421035
36x36	412	10,7	23.650	1	000421036
38x38	433	11,3	25.650	1	000421038
41x41	465	12,0	29.150	1	000421041



	Ft	🔧	📄
42/B9N 6-7-8-10-11-13-14-17-19 mm	34.950	1	000421074
2002/BV9	4.590	1	020020030



	Ft	🔧	📄
42/S14 6-7-8-10-11-12-13-14 -15-16-17-19-22-24 mm	54.700	1	000421067
42/S17 6-7-8-9-10-11-12-13-14-15 16-17-18-19-20-21-22 mm	66.200	1	000421065
42/S15 6-7-8-10-11-12-13-14 17-19-22-24-27-30-32 mm	75.700	1	000421066
42/S17X 6-7-8-10-11-12-13-14 15-16-17-19-21-22- 24-27-30 mm	78.550	1	000421068
42/S26 6-7-8-9-10-11-12-13-14 15-16-17-18-19-20-21 22-23-24-25-26-27-28 29-30-32 mm	141.200	1	000421070



FIGYELEM!

A 42-es csillag-villáskulcs új formája tökéletesen illeszkedik a klasszikus 42-es csillag-villáskulcs tartóiba és szerszámtálcáiba

9 darabos csillag-villáskulcs készlet kompakt tartóval

Az elérhető nyomaték több mint a duplája az ISO 1711 szabványban elfogadottakhoz képest



	Ft		
42/SC9I 8-10-11-12-13-14-15-17-19 mm	35.150	1	000421087
142/SCV9I	3.380	1	001420103
42/SC9E 8-10-11-12-13-16-17-18-19 mm	36.500	1	000421088
142/SCV9E	3.380	1	001420104



	Ft		
42/SP25 6-7-8-9-10-11-12-13-14-15-16-17-18-19-20-21-22-23-24-25-26-27-28-30-32 mm	150.600	1	000421085
42/SPV2	18.600	1	000420090



42/SP15

42/SPV...

	Ft		
42/SP15 6-7-8-9-10-11-12-13-14-15-16-17-19-22-24 mm	62.050	1	000421078
42/SPV7 42: 8-10-11-13-14-17-19 mm 55: 6x7-8x9-10x11-12x13-14x15-16x17-18x19 mm	2.260	1	000420097
42/SPV11 42MP: 8-9-10-11-12-13-14-15-16-17-19 mm 142-142SN: 8-9-10-11-12-13-14-15-16-17-19 mm	3.290	1	000420100
42/SPV15 42: 6-7-8-9-10-11-12-13-14-15-16-17-19-22-24 mm	4.610	1	000420102

42AS

Csillag-villáskulcs, krómozott



	L mm	Ft		
1/4x1/4	95	3.290	2	000420106
9/32x9/32	106	3.370	2	000420107
5/16x5/16	116	3.310	2	000420108
3/8x3/8	137	3.610	2	000420110
7/16x7/16	148	3.900	2	000420111
1/2x1/2	169	4.000	2	000420113
9/16x9/16	180	4.400	2	000420114
19/32x19/32	191	4.920	2	000420115
5/8x5/8	201	5.250	2	000420116
11/16x11/16	212	5.480	2	000420117
3/4x3/4	233	5.920	2	000420119
13/16x13/16	254	6.950	2	000420121
7/8x7/8	264	7.180	2	000420122
15/16x15/16	285	8.380	2	000420124
1x1	296	8.650	2	000420125
1.1/16x1.1/16	317	9.630	2	000420127
1.1/8x1.1/8	338	10.400	2	000420129
1.1/4x1.1/4	370	13.050	2	000420132
1.5/16x1.5/16	391	21.400	1	000420133
1.3/8x1.3/8	412	25.000	1	000420135
1.7/16x1.7/16	412	26.250	1	000420136
1.1/2x1.1/2	433	27.800	1	000420138



	Ft		
42AS/B9N 1/4-5/16-3/8-7/16-1/2-9/16-5/8-11/16-3/4-13/16-7/8-15/16-1	43.750	1	000420159
2002/BV9	4.590	1	020020030



	Ft		
42AS/13 1/4-5/16-3/8-7/16-1/2-9/16-5/8-11/16-3/4-13/16-7/8-15/16-1	70.300	1	000420163
42AS/16 1/4-5/16-3/8-7/16-1/2-9/16-5/8-11/16-3/4-13/16-7/8-15/16-1-1.1/16-1.1/8-1.1/4	103.400	1	000420166
42AS/17 1/4-9/32-5/16-3/8-7/16-1/2-9/16-19/32-5/8-11/16-3/4-13/16-7/8-15/16-1-1.1/16-1.1/8	98.650	1	000420168



42MP

Csillag-villáskulcs, fényes krómozott



DIN 3113 UNI-ISO 7738

	L mm	Ft		
6x6	95	4.180	5	000420606
7x7	105	4.190	5	000420607
8x8	116	4.210	5	000420608
9x9	127	4.280	5	000420609
10x10	137	4.350	5	000420610
11x11	148	4.380	5	000420611
12x12	158	4.470	5	000420612
13x13	169	4.600	5	000420613
14x14	180	4.770	5	000420614
15x15	190	5.170	5	000420615
16x16	201	5.610	5	000420616
17x17	212	6.180	5	000420617
18x18	222	6.590	5	000420618
19x19	233	6.850	5	000420619
20x20	243	7.480	3	000420620
21x21	254	7.960	3	000420621
22x22	264	8.130	3	000420622
24x24	285	9.600	3	000420624
27x27	317	10.950	3	000420627
30x30	349	13.100	3	000420630
32x32	370	14.800	3	000420632



	Ft		
42MP/B9N 6-7-8-10-11-13-14-17-19 mm	48.300	1	000420661
2002/BV9	4.590	1	020020030



	Ft		
42MP/S17 6-7-8-9-10-11-12-13-14-15-16-17-18-19-20-21-22 mm	93.400	1	000420652
42MP/S21 6-7-8-9-10-11-12-13-14-15-16-17-18-19-20-21-22-24-27-30-32 mm	141.900	1	000420653

42LMP

Hosszú csillag-villáskulcs,
fényes krómozott



mm	L mm	Ft		
8x8	148	4.160	2	000420508
9x9	167	4.270	2	000420509
10x10	172	4.440	2	000420510
11x11	186	4.640	2	000420511
12x12	197	4.790	2	000420512
13x13	207	4.880	2	000420513
14x14	223	5.170	2	000420514
15x15	233	5.680	2	000420515
16x16	243	6.130	2	000420516
17x17	261	6.530	2	000420517
18x18	270	6.950	2	000420518
19x19	280	7.140	2	000420519
21x21	301	8.470	2	000420521
22x22	318	8.650	2	000420522
24x24	338	9.970	2	000420524
27x27	376	11.800	2	000420527
30x30	409	14.550	2	000420530
32x32	435	15.900	2	000420532



	Ft		
42LMP/S14 8-9-10-11-12-13-14 15-16-17-18-19-21-22 mm	81.900	1	000420551
42LMP/S18 8-9-10-11-12-13-14 15-16-17-18-19-21-22 24-27-30-32 mm	134.100	1	000420552

42SLIM

vékonyított végű csillag-villáskulcsok



DIN 3113 UNI-ISO 7738

mm	L mm	S1 mm	Ft		
8x8	116	3,4	3.090	5	000420408
10x10	137	3,8	3.310	5	000420410
11x11	148	3,8	3.590	5	000420411
12x12	158	4,2	3.690	5	000420412
13x13	169	4,4	3.690	5	000420413
14x14	180	4,6	4.030	5	000420414
15x15	190	4,7	4.260	5	000420415
16x16	201	4,7	4.570	5	000420416
17x17	212	5,1	4.830	5	000420417
18x18	222	5,1	5.100	5	000420418
19x19	233	5,6	5.330	5	000420419



	Ft		
42SLIM/B8NI 10-11-12-13-14-15-17-19 mm	37.300	1	000420478
42SLIM/B8NE 10-11-12-13-16-17-18-19 mm	38.700	1	000420479
2002/BV8	4.590	1	020020020



	Ft		
42SLIM/S11 8-10-11-12-13-14-15- 16-17-18-19 mm	45.500	1	000420471

45

Erősített csillag-villáskulcs,
krómozott



DIN 3113 UNI-ISO 7738

mm	L mm	Ft		
46x46	500	36.200	1	000450046
50x50	540	42.750	1	000450050
55x55	560	59.950	1	000450055
60x60	600	72.350	1	000450060
65x65	675	139.900	1	000450065
70x70	675	147.200	1	000450070
75x75	720	168.800	1	000450075
80x80	720	174.900	1	000450080

52

Egyoldalú villáskulcs, krómozott



UNI 6733 DIN 3114

mm	L mm	Ft		
10	119	3.660	5	000520010
11	119	3.670	5	000520011
12	119	3.730	5	000520012
13	145	4.400	5	000520013
14	145	4.400	5	000520014
15	145	4.420	5	000520015
16	159	4.930	5	000520016
17	159	4.960	5	000520017
18	159	4.980	5	000520018
19	175	5.860	5	000520019
20	175	5.740	5	000520020
21	175	5.850	5	000520021
22	196	7.060	2	000520022
23	196	7.110	2	000520023
24	196	7.200	2	000520024
25	215	7.880	2	000520025
26	215	7.960	2	000520026
27	215	8.030	2	000520027
28	240	10.150	2	000520028
30	240	10.350	2	000520030
32	270	12.400	2	000520032
34	270	13.000	1	000520034
35	295	16.000	1	000520035
36	295	15.600	1	000520036
38	295	15.800	1	000520038
40	335	21.900	1	000520040
41	335	21.900	1	000520041
42	335	23.000	1	000520042
45	370	27.400	1	000520045
46	370	27.400	1	000520046
48	370	27.750	1	000520048
50	415	33.150	1	000520050
52	415	36.800	1	000520052
55	415	37.050	1	000520055
60	490	54.700	1	000520060
65	490	56.250	1	000520065
70	490	60.500	1	000520070

53

Egyoldalú villáskulcs, foszfátózott



mm	L mm	Ft		
36	317	11.050	1	000530036
38	320	12.100	1	000530038
41	342	14.250	1	000530041
46	396	17.250	1	000530046
50	412	27.950	1	000530050
55	457	32.650	1	000530055
60	492	37.350	1	000530060
65	528	43.950	1	000530065
70	572	52.950	1	000530070
75	608	65.050	1	000530075
80	645	81.300	1	000530080
85	690	101.400	1	000530085
90	690	112.100	1	000530090
95	847	167.900	1	000530095
100	847	172.800	1	000530100
105	1000	222.600	1	000530105
110	1000	239.800	1	000530110
115	1000	268.500	1	000530115
120	1000	301.700	1	000530120
125	1000	359.800	1	000530125
130	1000	372.700	1	000530130
135	1000	415.900	1	000530135

55

Villáskulcs, krómozott



UNI-ISO 10102 DIN 3110

mm	L mm	Ft		
4x5	101	1.930	5	000550003
5x5,5	101	2.150	5	000550006
5,5x7	120	2.210	5	000550009
• 6x7	120	1.670	5	000550012
7x8	140	2.130	5	000550018
• 8x9	140	1.770	5	000550021
8x10	140	2.120	5	000550024
• 10x11	155	1.880	5	000550030
10x12	155	2.460	5	000550033
10x13	170	2.650	5	000550035
• 12x13	170	2.120	5	000550042
12x14	170	2.780	5	000550045
13x14	185	3.140	5	000550047
13x17	189	3.320	5	000550051
• 14x15	185	2.660	5	000550054
14x17	189	3.580	5	000550057
• 16x17	202	3.040	5	000550060
17x19	220	3.970	2	000550063
• 18x19	220	3.590	2	000550066
19x22	236	4.580	2	000550069
• 20x22	236	4.070	2	000550075
• 21x23	245	4.460	2	000550078
22x24	245	4.930	2	000550081
• 24x26	262	5.110	2	000550087
24x27	262	5.530	2	000550090
• 25x28	272	5.810	2	000550096
• 27x29	284	6.660	2	000550099
27x30	284	7.500	2	000550102
27x32	297	8.170	2	000550105
• 30x32	297	7.320	2	000550108
32x36	325	20.850	1	000550114
34x36	325	20.850	1	000550117
35x38	375	23.200	1	000550120
36x41	375	24.150	1	000550123
41x46	425	26.700	1	000550129
46x50	475	33.600	1	000550132
50x55	500	42.450	1	000550135
55x60	500	45.900	1	000550138



	Ft	🔧	📦
55/B8N	25.400	1	000550160
6x7-8x9-10x11-12x13 14x15-16x17-18x19 20x22 mm			
2002/BV8	4.590	1	020020020
55/B12N	51.150	1	000550164
6x7-8x9-10x11-12x13 14x15-16x17-18x19 20x22-21x23-24x26 25x28-30x32 mm			
2002/BV12	7.660	1	020020040



	Ft	🔧	📦
55/S8	20.800	1	000550174
6x7-8x9-10x11-12x13 14x15-16x17-18x19 20x22 mm			
55/S12	43.500	1	000550178
6x7-8x9-10x11-12x13 14x15-16x17-18x19 20x22-21x23-24x26 25x28-30x32 mm			
55/S12X	43.900	1	000550179
6x7-8x9-10x11-12x13 14x15-16x17-18x19 20x22-21x23-24x27 25x28-30x32 mm			
55/S13	50.150	1	000550182
6x7-8x9-10x11-12x13 14x15-16x17-18x19 20x22-21x23-24x26 25x28-27x29-30x32 mm			



55/SP7

55/SP13

	Ft	🔧	📦
55/SP7	19.000	1	000550167
6x7-8x9-10x11-12x13 14x15-16x17-18x19 mm			
42/SPV7	2.260	1	000420097
42: 8-10-11-13-14-17-19 mm 55: 6x7-8x9-10x11-12x13 14x15-16x17-18x19 mm			
55/SP13	61.300	1	000550186
6x7-8x9-10x11-12x13 14x15-16x17-18x19 20x22-21x23-24x26 25x28-27x29-30x32 mm			
55/SPV	11.150	1	000550190

55AS

Villáskulcs, krómozott



🔧	L mm	Ft	🔧	📦
1/4x9/32	120	2.300	2	000550203
1/4x5/16	120	2.300	2	000550206
5/16x11/32	140	2.460	2	000550209
5/16x3/8	140	2.440	2	000550212
3/8x7/16	155	2.640	2	000550215
7/16x1/2	170	2.950	2	000550218
1/2x9/16	170	3.140	2	000550221
9/16x5/8	185	3.520	2	000550224
19/32x11/16	189	4.220	2	000550227
5/8x11/16	202	4.250	2	000550230
5/8x3/4	202	4.730	2	000550233
11/16x13/16	220	5.000	2	000550242
3/4x7/8	236	5.450	2	000550245
25/32x13/16	236	5.450	2	000550244
7/8x15/16	245	5.820	2	000550251
15/16x1	262	7.320	1	000550257
1x1.1/8	272	7.740	1	000550259
1.1/16x1.1/4	284	10.100	1	000550267
1.1/8x1.5/16	297	10.100	1	000550266
1.5/16x1.1/2	325	26.700	1	000550269
1.3/8x1.1/2	375	29.300	1	000550272
1.7/16x1.5/8	375	29.300	1	000550275



	Ft	🔧	📦
55AS/5	17.950	1	000550290
5/16x11/32-3/8x7/16 1/2x9/16-5/8x11/16 3/4x7/8			
55AS/8	28.750	1	000550296
1/4x9/32-5/16x11/32-3/8x7/16- 1/2x9/16-9/16x5/8-5/8x11/16- 11/16x13/16-3/4x7/8			
55AS/12	59.350	1	000550298
1/4x9/32-5/16x11/32-3/8x7/16-1 1/2x9/16-9/16x5/8-5/8x11/16- 11/16x13/16-25/32x13/16-3/4x7/8- 15/16x1-1x1.1/8-1.1/16x1.1/4			

55MP

Villáskulcs, fényes krómozott



UNI-ISO 10102 DIN 3110

🔧	L mm	Ft	🔧	📦
6x7	120	2.260	2	000550603
8x9	140	2.480	2	000550606
10x11	155	2.640	2	000550609
12x13	170	2.960	2	000550612
14x15	185	3.480	2	000550615
16x17	202	4.120	2	000550618
18x19	220	4.790	2	000550621
20x22	236	5.510	2	000550624
21x23	245	5.940	2	000550627
24x26	262	7.060	1	000550630
25x28	272	7.510	1	000550633
27x29	284	8.780	1	000550636
30x32	297	9.570	1	000550639



	Ft	🔧	📦
55MP/S8	28.250	1	000550650
6x7-8x9-10x11-12x13 14x15-16x17-18x19 20x22 mm			
55MP/S13	67.100	1	000550651
6x7-8x9-10x11-12x13 14x15-16x17-18x19 20x22-21x23-24x26 25x28-27x29-30x32 mm			
55MP/S12	58.300	1	000550653
6x7-8x9-10x11-12x13-14x15- 16x17-18x19-20x22-21x23-24x26- 25x28-30x32 mm			

58

Ütővilláskulcs, horganyzott



DIN 133

🔧	L mm	Ft	🔧	📦
24	177	11.950	1	000580024
27	180	12.400	1	000580027
30	190	13.800	1	000580030
32	190	14.300	1	000580032
34	200	18.500	1	000580034
36	215	19.050	1	000580036
41	235	22.850	1	000580041
46	255	30.350	1	000580046
50	275	33.550	1	000580050
55	300	40.350	1	000580055
60	320	44.450	1	000580060
65	342	57.800	1	000580065
70	375	75.100	1	000580070
75	375	82.550	1	000580075
80	408	119.200	1	000580080
85	408	133.400	1	000580085
90	445	157.400	1	000580090
95	445	159.500	1	000580095
100	485	223.400	1	000580100
105	485	251.800	1	000580105
110	510	273.800	1	000580110
115	510	314.100	1	000580115
120	545	321.400	1	000580120
125	545	368.200	1	000580125
130	575	504.100	1	000580130
135	575	522.200	1	000580135
*140	575	565.500	1	000580140
*145	640	788.700	1	000580145
*150	640	812.600	1	000580150
*155	640	858.700	1	000580155
*160	640	957.500	1	000580160
*165	715	1.029.600	1	000580165
*170	715	1.392.300	1	000580170
*175	715	1.475.500	1	000580175
*180	715	1.600.100	1	000580180
*185	715	1.636.800	1	000580185
*190	800	1.797.300	1	000580190
*195	800	1.906.800	1	000580195
*200	800	1.977.600	1	000580200
*210	800	2.481.500	1	000580210
*220	800	3.221.000	1	000580220
*230	800	3.944.800	1	000580230



UNI 6737

mm	L mm	Ft	🔧	📦
4x4	78	3.610	5	000730040
4,5x4,5	78	3.610	5	000730045
5x5	78	3.610	5	000730050
5,5x5,5	86	3.670	5	000730055
6x6	86	3.670	5	000730060
7x7	86	3.670	5	000730070
8x8	97	3.810	5	000730080
9x9	97	3.810	5	000730090
10x10	108	4.480	5	000730100
11x11	108	4.480	5	000730110
12x12	124	4.820	5	000730120
13x13	124	4.820	5	000730130
14x14	124	4.820	5	000730140



	Ft	🔧	📦
73/B13N	57.450	1	000730202
4-4,5-5-5,5-6-7-8-9			
10-11-12-13-14 mm			
2002/BV13	4.590	1	020020050



	Ft	🔧	📦
73/S13	52.900	1	000730210
4-4,5-5-5,5-6-7-8-9			
10-11-12-13-14 mm			



Beta



DIN 7444

mm	L mm	Ft	🔧	📦
24	162	12.150	1	000780024
27	180	14.800	1	000780027
30	190	17.300	1	000780030
32	190	17.650	1	000780032
34	200	18.750	1	000780034
36	205	22.600	1	000780036
41	225	29.050	1	000780041
46	235	32.650	1	000780046
50	250	38.950	1	000780050
55	265	43.950	1	000780055
60	275	53.700	1	000780060
65	295	67.750	1	000780065
70	325	69.550	1	000780070
75	325	82.000	1	000780075
80	350	124.200	1	000780080
85	350	135.000	1	000780085
90	390	166.000	1	000780090
95	390	191.000	1	000780095
100	420	215.700	1	000780100
105	420	255.200	1	000780105
110	450	280.900	1	000780110
115	450	312.100	1	000780115
120	490	423.300	1	000780120
125	480	567.600	1	000780125
130	520	675.500	1	000780130
135	520	721.500	1	000780135
*140	520	825.600	1	000780140
*145	580	1.079.300	1	000780145
*150	580	1.105.100	1	000780150
*155	580	1.222.400	1	000780155
*160	650	1.262.600	1	000780160
*165	650	1.347.400	1	000780165
*170	650	1.631.900	1	000780170
*175	650	1.765.600	1	000780175
*180	650	1.921.700	1	000780180
*185	695	1.991.300	1	000780185
*190	695	2.167.100	1	000780190
*195	695	2.192.100	1	000780195
*200	695	2.222.800	1	000780200
*210	740	2.334.700	1	000780210
*215	740	2.645.400	1	000780215
*220	740	2.927.600	1	000780220
*230	740	3.643.200	1	000780230

78AS

Ütőcsillagkulcs



mm	L mm	Ft	🔧	📦
*1.1/16	180	17.050	1	000780327
*1.1/8	190	17.050	1	000780329
*1.3/16	190	17.050	1	000780330
*1.1/4	197	18.900	1	000780332
*1.5/16	197	18.850	1	000780333
*1.3/8	223	21.150	1	000780335
*1.7/16	223	25.050	1	000780336
*1.1/2	223	25.200	1	000780338
*1.5/8	223	29.700	1	000780341
*1.11/16	225	31.050	1	000780343
*1.13/16	240	33.500	1	000780346
*1.7/8	250	33.500	1	000780348
*2	250	39.150	1	000780350
*2.1/16	250	40.500	1	000780352
*2.3/16	275	42.650	1	000780355
*2.3/8	270	56.800	1	000780360
*2.9/16	302	63.350	1	000780365
*2.3/4	350	68.350	1	000780370
*2.15/16	350	78.100	1	000780375
*3.1/8	354	128.600	1	000780380



mm	L mm	Ft	🔧	📦
6x7	170	14.000	3	000800006
8x9	176	13.950	3	000800008
8x10	179	13.950	3	000800009
10x11	182	14.750	3	000800010
12x13	228	16.850	3	000800012
14x15	232	17.050	3	000800014
13x17	231	17.950	3	000800015
16x17	234	17.950	2	000800016
18x19	285	22.200	2	000800018
19x22	287	23.150	2	000800019
20x22	289	23.150	2	000800020
21x23	289	23.650	2	000800021
24x27	405	36.650	2	000800024
30x32	413	39.000	2	000800030

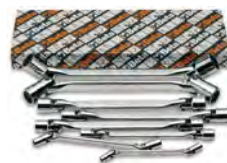

	Ft	🔧	📦
80/S8	139.900	1	000800051
6x7-8x9-10x11-12x13-14x15			
16x17-18x19-20x22 mm			
80/S11	239.200	1	000800056
6x7-8x9-10x11-12x13			
14x15-16x17-18x19-20x22			
21x23-24x27-30x32 mm			

83

Önindító kulcs, krómózott, az önindító csavarjainál használható



ISO 3318

mm	L mm	Ft	🔧	📦
8x10	126	6.800	3	000830008
10x12	137	7.190	3	000830010
11x13	138	7.380	3	000830011
14x17	183	9.340	3	000830014
15x17	184	10.650	2	000830015
16x18	196	11.400	2	000830016
19x22	231	15.150	2	000830019



	Ft	🔧	📦
83/S3	31.850	1	000830081
11x13-14x17-19x22 mm			
83/S5	51.750	1	000830085
10x12-11x13-15x17			
16x18-19x22 mm			

83AS

Önindító kulcs, méretek inch-ben



mm	L mm	Ft	csomagolás	azonosító
7/16x1/2	138	8.780	2	000830111
9/16x5/8	183	10.300	2	000830114
3/4x7/8	230	16.650	2	000830119



csomagolás	Ft	azonosító
83AS/3	35.750	1 000830181

7/16x1/2-9/16x5/8
3/4x7/8

88

kettős egyenes extrahosszú sokszögkulcs



mm	L mm	Ft	csomagolás	azonosító
8x10	235	7.630	2	000880008
12x14	330	9.110	2	000880012
13x15	330	9.110	2	000880013
16x18	405	12.700	2	000880016
17x19	405	12.700	2	000880017
21x23	435	14.450	2	000880021
22x24	435	14.450	2	000880022



csomagolás	Ft	azonosító
88/S7	80.150	1 000880107

8x10-12x14-13x15-16x18-
17x19-21x23-22x24 mm

90

Hajlított csillagkulcs, krómozott



DIN 838 ISO 10104

mm	L mm	Ft	csomagolás	azonosító
6x7	165	2.780	5	000900006
8x9	180	3.070	5	000900012
8x10	180	3.180	5	000900015
10x11	195	3.480	5	000900018
10x12	195	3.640	5	000900021
11x13	215	3.950	5	000900024
12x13	215	3.850	5	000900027
12x14	215	3.940	5	000900030
14x15	230	4.740	5	000900033
14x17	250	5.580	5	000900036
16x17	250	5.290	5	000900039
17x19	265	6.310	5	000900042
18x19	265	6.260	5	000900045
19x22	285	7.120	3	000900048
20x22	285	7.250	3	000900051
21x23	305	8.300	2	000900057
22x24	305	8.370	2	000900060
24x26	325	10.000	2	000900063
24x27	325	10.050	2	000900067
25x28	340	13.000	2	000900070
27x29	355	14.250	2	000900073
27x30	355	14.250	2	000900076
27x32	375	15.250	2	000900078
30x32	375	15.250	2	000900080
32x36	395	20.150	1	000900088
34x36	415	27.250	1	000900089
35x38	415	28.050	1	000900091
36x41	435	31.150	1	000900094
41x46	460	40.300	1	000900097
46x50	500	52.350	1	000900100



csomagolás	Ft	azonosító
90/B8N	41.300	1 000900156

6x7-8x9-10x11-12x13
14x15-16x17-18x19
20x22 mm
2002/BV8 4.590 1 020020020



csomagolás	Ft	azonosító
90/S8	36.700	1 000900162

6x7-8x9-10x11-12x13
14x15-16x17-18x19
20x22 mm
20x22 mm
90/S12 83.250 1 000900166
6x7-8x9-10x11-12x13
14x15-16x17-18x19
20x22-21x23-24x26
25x28-30x32 mm
90/S12X 83.300 1 000900167
6x7-8x9-10x11-12x13
14x15-16x17-18x19
20x22-21x23-24x27
25x28-30x32 mm
90/S13 97.500 1 000900170
6x7-8x9-10x11-12x13
14x15-16x17-18x19
20x22-21x23-24x26
25x28-27x29-30x32 mm



csomagolás	Ft	azonosító
90/SP13	108.700	1 000900174

6x7-8x9-10x11-12x13
14x15-16x17-18x19
20x22-21x23-24x26
25x28-27x29-30x32 mm
55/SPV 11.150 1 000550190

90AS

Hajlított csillagkulcs, krómozott



mm	L mm	Ft	csomagolás	azonosító
1/4x5/16	165	3.210	2	000900203
5/16x11/32	180	3.400	2	000900206
5/16x3/8	180	3.540	2	000900209
3/8x7/16	195	3.720	2	000900212
7/16x1/2	215	4.030	2	000900215
1/2x9/16	230	4.880	2	000900218
9/16x5/8	230	4.880	2	000900221
19/32x11/16	250	5.300	2	000900222
5/8x11/16	250	5.590	2	000900224
5/8x3/4	265	6.690	2	000900227
11/16x3/4	265	6.690	1	000900230
11/16x13/16	265	6.690	1	000900233
3/4x25/32	265	7.380	1	000900235
3/4x7/8	285	7.380	1	000900237
13/16x7/8	285	7.560	1	000900240
7/8x15/16	305	7.560	1	000900243
15/16x1	325	10.200	1	000900252
1.1/16x1.1/4	375	16.200	1	000900258
1.1/8x1.5/16	375	16.150	1	000900261



csomagolás	Ft	azonosító
90AS/8	45.250	1 000900298

1/4x5/16-5/16x11/32
3/8x7/16-1/2x9/16
5/8x11/16-11/16x3/4
13/16x7/8-15/16x1
90AS/10 77.600 1 000900300
1/4x5/16-5/16x11/32
3/8x7/16-1/2x9/16
5/8x11/16-11/16x3/4
13/16x7/8-15/16x1
1.1/16x1.1/4-1.1/8x1.5/16

91

Feltűző csillagkulcs, krómozott



mm	Ø mm	Ft	csomagolás	darab	azonosító
24	38	22.400	1	000910024	
27	41	23.050	1	000910027	
30	48	24.500	1	000910030	
32	49	26.450	1	000910032	
36	54	30.200	1	000910036	
41	62	36.150	1	000910041	
46	69	41.850	1	000910046	
50	76	47.900	1	000910050	
55	81	52.950	1	000910055	
60	90	66.250	1	000910060	
65	98	74.550	1	000910065	
70	105	84.150	1	000910070	
75	110	97.550	1	000910075	
80	125	110.200	1	000910080	
85	125	114.200	1	000910085	
90	140	185.800	1	000910090	
95	140	198.600	1	000910095	
100	143	211.000	1	000910100	
105	146	265.500	1	000910105	

92

Csőtoldatok a 91. típusú kulcsokhoz, krómozott



	L mm	91 mm	Ø mm	Ft	csomagolás	darab	azonosító
92/1	460	24÷30	19	13.150	1	000920010	
92/2	610	32÷41	22	20.300	1	000920020	
92/3	760	46÷55	25	28.850	1	000920030	
92/4	860	60÷105	30	38.200	1	000920040	

93

Állványozó csillagkulcs állványcsavarokhoz, krómozott



mm	L mm	Ft	csomagolás	darab	azonosító
21x22	310	15.600	3	000930021	

93C

Állványozó csillagkulcs, lapos, speciális fejkiképzés



mm	L mm	Ft	csomagolás	darab	azonosító
17x19	310	17.850	1	000930117	
19x22	310	19.200	1	000930119	
19x24	310	23.650	1	000930120	
21x22	365	21.500	1	000930121	
36x38	445	36.150	1	000930136	

94

Nyitott hollandier kulcs, krómozott



DIN 3118

mm	L mm	Ft	csomagolás	darab	azonosító
8x10	140	6.680	2	000940008	
9x11	153	6.890	2	000940009	
10x11	153	7.180	2	000940010	
11x13	175	7.390	2	000940011	
12x14	175	7.960	2	000940012	
13x15	175	7.960	2	000940013	
14x15	175	9.410	2	000940014	
14x17	195	9.720	2	000940015	
17x19	212	9.940	2	000940017	
19x22	228	10.650	2	000940019	
22x24	242	13.150	2	000940022	
24x27	260	14.000	2	000940024	
30x32	300	18.000	2	000940030	
36x41	320	30.150	1	000940036	



	Ft	csomagolás	darab	azonosító
94/S6	49.800	1	000940050	
8x10-10x11-11x13-12x14 17x19-19x22 mm				
94/S10	101.800	1	000940052	
8x10-9x11-10x11-11x13 12x14-17x19-19x22 22x24-24x27-30x32 mm				

95

Egyenes csillagkulcs, krómozott



DIN 837 ISO 10103

mm	L mm	Ft	csomagolás	darab	azonosító
6x7	120	4.300	3	000950161	
8x9	135	4.600	3	000950162	
10x11	150	5.190	3	000950163	
12x13	165	5.670	3	000950164	
14x15	185	5.930	3	000950165	
16x17	210	6.410	3	000950166	
17x19	225	7.310	3	000950167	
18x19	225	7.620	2	000950168	
20x22	240	8.390	2	000950169	
21x23	255	8.890	2	000950170	
24x26	270	9.410	2	000950171	
25x28	285	11.300	2	000950172	
27x29	315	11.500	2	000950173	
30x32	335	13.150	2	000950174	



	Ft	csomagolás	darab	azonosító
95/S8	48.100	1	000950177	
6x7-8x9-10x11-12x13 14x15-16x17-18x19 20x22 mm				
95/S13	102.400	1	000950179	
6x7-8x9-10x11-12x13 14x15-16x17-18x19 20x22-21x23-24x26 25x28-27x29-30x32 mm				

95FTX

Egyenes Torx® csillagkulcs, krómozott



	L mm	Ft	csomagolás	darab	azonosító
E6xE8	115	4.450	2	000950306	
E10xE12	143	4.690	2	000950310	
E14xE18	177	5.200	2	000950314	
E20xE24	224	7.040	2	000950320	



	Ft	csomagolás	darab	azonosító
95FTX/S4	21.400	1	000950325	
E6xE8-E10xE12 E14xE18-E20xE24				



Beta

HAJLÍTOTT IMBUSZKULCSOK

A Beta imbuszkulcsait hosszú élettartamra és pontos működésre tervezték. A széles választék minden felhasználási követelményt lefed: extra rövid, rövid, hosszú, extra hosszú, gömbfejű és T-kulcsok, valamint nagy forgatónyomatékok biztosító markolattal ellátott kulcsok. Mindezek a Beta legfontosabb termékei közé tartoznak, valamint egyedülállóak a piacon.

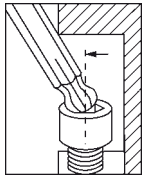

A gömbfejnek köszönhetően a hajlított imbuszkulcs a csavar tengelyéhez képest 30°-ban is használható.

A kulcsok a szükséges méret gyors azonosítása érdekében kihajtható tartóba vannak csomagolva. Bezárt állapotban megakadályozza, hogy a kulcsok, beleértve a kisebbeket is, véletlenül kiessenek.

A színes változat a standard kulcsok kiemelkedő tulajdonságait ötvözi azzal, hogy a szükséges méret azonnal felismerhető, és így a napi munka felgyorsítható.



	Ft		
96/B8 2-2,5-3-4-5-6-8-10 mm	6.790	5	000960386
96/B10 1,5-2-2,5-3-4-5-6-8-10-12 mm	9.580	5	000960380
96N/BV	745	1	000960651



	Ft		
96/SC9 1,5-2-2,5-3-4-5-6-8-10 mm	8.190	1	000960374
96/SCV	1.770	1	000960985



	Ft		
96/SC12 2-2,5-3-3,5-4-4,5-5 6-7-8-9-10 mm	11.450	1	000960395
96/SCV12	1.970	1	000960975

96

Hajlított imbuszkulcs, krómozott



ISO 2936

mm	L mm	L1 mm	Ft		
0,9	35	8	460	20	000960013
1,3	39	10	370	20	000960014
1,5	45	15	370	20	000960015
2	50	17	395	20	000960020
2,5	57	20	395	20	000960025
3	64	22	475	20	000960030
3,5	68	25	535	20	000960035
4	72	28	570	20	000960040
4,5	78	30	590	20	000960045
5	83	32	655	20	000960050
5,5	88	35	780	20	000960055
6	94	37	775	20	000960060
7	99	40	970	10	000960070
8	105	43	1.140	10	000960080
9	111	46	1.360	10	000960090
10	119	49	1.640	10	000960100
11	126	52	2.020	10	000960110
12	134	56	2.420	10	000960120
13	142	62	3.180	10	000960130
14	151	69	3.650	10	000960140
16	165	75	5.230	5	000960160
17	174	79	5.750	5	000960170
19	196	88	8.030	5	000960190
22	216	100	12.500	3	000960220
24	242	112	16.350	1	000960240
27	271	125	22.350	1	000960270
30	309	140	30.200	1	000960300
32	341	155	39.950	1	000960312
36	385	174	57.250	1	000960316



	Ft		
96/ST6 2,5-3-4-5-6-8 mm	5.170	3	000960370



	Ft		
96/BGS7 1,5-2-2,5-3-4-5-6 mm	12.400	1	000960367



	Ft		
96/BG7 2,5-3-4-5-6-8-10 mm	13.400	1	000960368

96N

Hajlított imbuszkulcs, barnított



ISO 2936

mm	L mm	L1 mm	Ft		
0,9	32	10	185	20	000960409
1,3	44	12	185	20	000960413
1,5	46	15	195	20	000960415
2	51	17	200	20	000960420
2,5	57	20	210	20	000960425
3	64	22	235	20	000960430
3,5	68	25	275	20	000960435
4	72	28	315	20	000960440
4,5	78	30	345	20	000960445
5	83	32	375	20	000960450
6	94	37	480	20	000960460
7	99	40	655	10	000960470
8	105	43	740	10	000960480
9	111	46	1.000	10	000960490
10	119	49	1.170	10	000960500
11	126	52	1.440	10	000960510
12	134	56	1.740	10	000960520
13	142	62	2.380	10	000960530
14	151	69	2.670	10	000960540
16	165	72	4.100	5	000960560
17	174	79	4.380	5	000960570
19	194	88	6.000	5	000960590
22	216	99	10.950	1	000960592
24	242	111	14.350	1	000960594



96N/ST6
2,5-3-4-5-6-8 mm

Ft 3.520 3 000960640



96N/G7
2,5-3-4-5-6-8-10 mm

Ft 9.980 3 000960645

96N/G7A
1,5-2-2,5-3-4-5-6 mm

Ft 6.920 3 000960643



96N/B10
1,5-2-2,5-3-4-5-6
8-10-12 mm

Ft 6.410 5 000960650

96N/BV
745 1 000960651



96N/SC9
1,5-2-2,5-3-4-5-6-8-10 mm

Ft 5.690 1 000960644

96N/SCV
1.770 1 000960986



96N/SC12
2-2,5-3-3,5-4-4,5-5
6-7-8-9-10 mm

Ft 7.970 1 000960661

96N/SCV12
1.970 1 000960976

96C/AS

hatlapfejű hajlított belső kulcs
krómozott



"	L mm	L1 mm	g	Ft		
1/16	46	16	1,01	695	20	000961702
3/32	53	19	2,70	965	20	000961706
1/8	60	22	5,33	1.020	20	000961710
5/32	67	25	9,33	1.190	20	000961714
3/16	74	28	14,87	1.350	20	000961716
7/32	81	32	22,00	1.510	20	000961718
1/4	89	35	31,40	1.680	20	000961720
5/16	103	40	56,16	1.880	10	000961724
3/8	117	45	91,31	2.250	10	000961728



96C-AS/SC9
1/16-3/32-1/8-5/32-3/16-
7/32-1/4-5/16-3/8

Ft 14.300 1 000961753

96AS

Hajlított imbuszkulcs, barnított

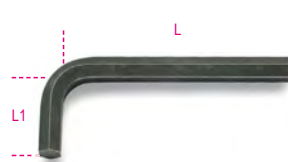

"	L mm	L1 mm	Ft		
1/30 (0,035")	44	14	355	20	000960698
1/20 (0,050")	44	15	355	20	000960701
1/16	46	16	370	20	000960702
5/64	50	18	445	20	000960704
3/32	53	19	530	20	000960706
7/64	57	21	545	20	000960708
1/8	60	22	545	20	000960710
9/64	64	24	675	20	000960712
5/32	68	25	675	20	000960714
3/16	75	29	745	20	000960716
7/32	82	32	845	20	000960718
1/4	89	35	970	20	000960720
5/16	103	40	1.210	10	000960724
3/8	117	44	1.470	10	000960728
7/16	132	49	2.110	10	000960730
1/2	149	54	2.770	10	000960732
9/16	151	69	4.520	2	000960734
5/8	165	72	5.440	1	000960736
3/4	194	88	8.890	1	000960738



96AS/SC9
1/16-3/32-1/8-5/32-3/16
7/32-1/4-5/16-3/8

Ft 9.130 1 000960743

96AS/SCV
1.770 1 000960744



96AS/T7
3/32-1/8-5/32
3/16-7/32-1/4-5/16

Ft 7.000 3 000960740



96AS/BG7
3/32-1/8-5/32-3/16
1/4-5/16-3/8

Ft 12.950 1 000960747



96AS/B11
1/20-1/16-5/64-3/32
1/8-5/32-3/16-7/32
1/4-5/16-3/8

Ft 8.910 1 000960749

96N/BV
745 1 000960651



96LC

Hajlított hosszú imbuszkulcs,
krómozott



ISO 2936

mm	L mm	L1 mm	Ft		
2	101	17	715	20	000960320
2,5	113	20	745	20	000960321
3	127	22	820	20	000960322
3,5	138	25	845	20	000960323
4	142	28	920	20	000960324
4,5	154	28	1.090	20	000960325
5	163	32	1.180	20	000960326
6	184	37	1.280	20	000960327
7	194	40	1.450	10	000960328
8	205	43	1.770	10	000960329
9	216	46	1.980	10	000960330
10	231	49	2.590	10	000960331
12	259	56	3.240	10	000960332

Beta



96LC/SC8	Ft		
2-2,5-3-4-5-6-8-10 mm	11.800	1	000960334
96LC/SCV	1.770	1	000960983



96LC/SC12	Ft		
2-2,5-3-3,5-4-4,5-5-6-7-8-9-10 mm	17.350	1	000960337
96LC/SCV12	1.970	1	000960977

96L

Hajlított hosszú imbuszkulcs, barnított



ISO 2936

mm	L mm	L1 mm	Ft		
2	99	15	505	20	000960820
2,5	110	17	535	20	000960825
3	124	19	585	20	000960830
3,5	135	21	650	20	000960835
4	138	24	695	20	000960840
4,5	150	25	825	20	000960845
5	158	27	875	20	000960850
6	178	31	1.000	20	000960860
7	187	33	1.280	10	000960870
8	197	35	1.600	10	000960880
9	207	37	1.800	10	000960890
10	221	39	2.380	10	000960900
12	247	44	2.980	10	000960920



96L/SC8	Ft		
2-2,5-3-4-5-6-8-10 mm	9.950	1	000960924
96L/SCV	1.770	1	000960987



96L/SC12	Ft		
2-2,5-3-3,5-4-4,5-5-6-7-8-9-10 mm	14.700	1	000960929
96L/SCV12	1.970	1	000960978

96BP-CL

gömbfejű hajlított imbuszkulcskészlet, krómozott, színezett



mm	L mm	L1 mm	Ft		
1,5	91	16	1.260	5	000961600
2	102	17	1.300	5	000961601
2,5	113	21	1.570	5	000961602
3	128	23	1.740	5	000961603
4	143	28	1.960	5	000961604
5	163	33	2.020	5	000961605
6	185	37	2.440	5	000961606
8	206	43	3.570	2	000961608
10	231	50	4.660	2	000961610



96BP-CL/SC9	Ft		
1,5-2-2,5-3-4-5-6-8-10 mm	22.300	1	000961619
96BP-CL/SCV	1.770	1	000961629

96BPC

Hajlított gömbfejű imbuszkulcs, krómozott

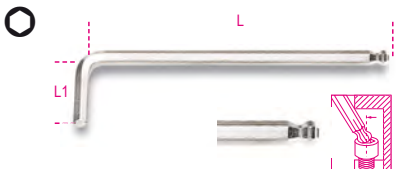

mm	L mm	L1 mm	Ft		
1,5	79	13	875	10	000960340
2	84	15	925	10	000960341
2,5	89	17	960	10	000960342
3	99	19	1.050	10	000960343
4	108	24	1.190	10	000960344
5	126	27	1.430	10	000960345
6	148	31	2.090	10	000960346
7	157	33	2.730	5	000960353
8	168	35	2.770	5	000960347
10	187	39	4.490	5	000960348
12	220	55	5.550	5	000960352



96BPC/SC9	Ft		
1,5-2-2,5-3-4-5-6-8-10 mm	17.550	1	000960354
96BPC/SCV	1.770	1	000960984

96BP

Hajlított gömbfejű imbuszkulcs, barnított

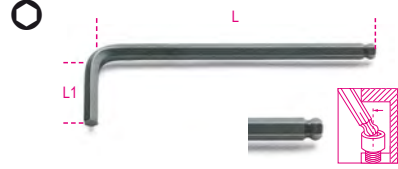

mm	L mm	L1 mm	Ft		
1,5	79	13	645	10	000960960
2	84	15	690	10	000960961
2,5	89	17	715	10	000960962
3	99	19	740	10	000960963
4	108	24	875	10	000960965
5	126	27	1.170	10	000960967
6	148	31	1.690	10	000960968
8	168	35	2.370	5	000960970
10	187	39	4.150	5	000960972
12	220	55	6.010	5	000960973



96BP/SC9	Ft		
1,5-2-2,5-3-4-5-6-8-10 mm	14.800	1	000960974
96BP/SCV	1.770	1	000960988

96LBP

Hajlított gömbfejű imbuszkulcs extra hosszú kivitel

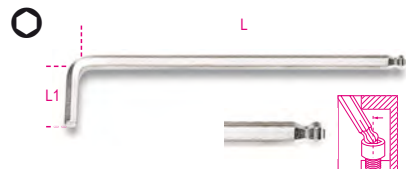

mm	L mm	L1 mm	Ft		
1,5	90	15	1.000	5	000961340
2	100	17	1.040	5	000961341
2,5	112	20	1.090	5	000961342
3	127	22	1.150	5	000961343
4	144	27	1.430	5	000961344
5	163	32	1.740	5	000961345
6	184	37	2.350	5	000961346
8	204	44	3.240	2	000961348
10	230	49	5.290	2	000961350



96LBP/SC9	Ft		
1,5-2-2,5-3-4-5-6-8-10 mm	20.100	1	000961354
96LBP/SCV	1.770	1	000961984

96BP/AS

Hajlított gömbfejű imbuszkulcs, barnított

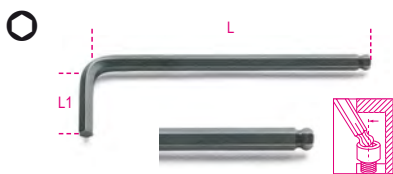

"	L mm	L1 mm	Ft	🔧	📄
3/32	89	17	795	10	000960989
1/8	98	18	840	10	000960990
5/32	108	24	1.030	10	000960991
3/16	126	26	1.170	10	000960992
7/32	139	28	1.680	10	000960993
1/4	152	31	1.850	10	000960994
5/16	168	34	2.380	5	000960995
3/8	190	39	4.060	5	000960996



96BP-AS/SC9	Ft	🔧	📄
1/16-3/32-1/8-5/32-3/16 7/32-1/4-5/16-3/8	15.950	1	000961000
96BP-AS/SCV	1.770	1	000961001



96BP-AS/8	Ft	🔧	📄
3/32-1/8-5/32-3/16-7/32 1/4-5/16-3/8	14.550	1	000960997
96BP-AS/BV	745	1	000960998

96BPA

110°-ban hajlított gömbfejű imbuszkulcs, extra rövid kivitel



mm	L mm	L1 mm	Ft	🔧	📄
1,5	71	9	940	5	000961960
2	86	11	1.000	5	000961961
2,5	96	13	1.040	5	000961962
3	104	15	1.150	5	000961963
4	116	17	1.380	5	000961964
5	132	19	1.640	5	000961965
6	155	21	2.320	5	000961966
8	176	24	3.110	2	000961968
10	200	27	4.850	2	000961970



96BPA/SC9	Ft	🔧	📄
1,5-2-2,5-3-4-5-6-8-10 mm	19.200	1	000961974
96BPA/SCV	1.770	1	000961988

96T

HAJLÍTOTT IMBUSZKULCSOK NAGY FORGATÓNYOMATÉKOT BIZTOSÍTÓ MARKOLATTAL

Gyorsan és könnyen kezelhető

A tökéletesen kiegyensúlyozott, kis méretű markolat könnyedén forog a tenyérben.

Az ergonomikus forma rendkívül nagy forgatónyomatéket biztosít.

A hatszög alakú végeket úgy tervezték, hogy a lehető legnagyobb nyomatéket továbbítsák a csavarra.

A kerek test a hatszögűhöz képest homogénebb vázzal rendelkezik, és fokozott szilárdságot biztosít.



A test áthalad a markolaton

96T

T-szárú imbuszkulcs, műanyag markolattal

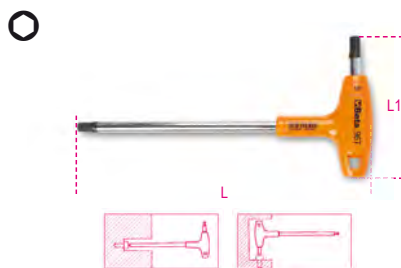

mm	L mm	L1 mm	Ft	🔧	📄
2	139	52	4.590	5	000960934
2,5	153	55	4.590	5	000960935
3	153	55	4.690	5	000960936
3,5	179	70	4.850	5	000960937
4	179	70	4.850	5	000960938
4,5	200	84	4.940	5	000960939
5	200	84	4.940	5	000960940
6	221	103	5.710	5	000960941
7	236	106	6.170	3	000960942
8	255	117	7.170	3	000960943
10	285	132	8.140	3	000960945



96T/S6	Ft	🔧	📄
2-2,5-3-4-5-6 mm	29.350	1	000960952
96T/S8	44.700	1	000960933
2-2,5-3-4-5-6-8-10 mm			
96T/S11	60.650	1	000960951
2-2,5-3-3,5-4-4,5-5-6-7-8-10 mm			



96T/SP11	Ft	🔧	📄
2-2,5-3-3,5-4-4,5-5 6-7-8-10 mm	70.250	1	000960957
96T/SPV	11.350	1	000960958
96T/S11 97TTX/S11			

96T/AS

T-szárú imbuszkulcs

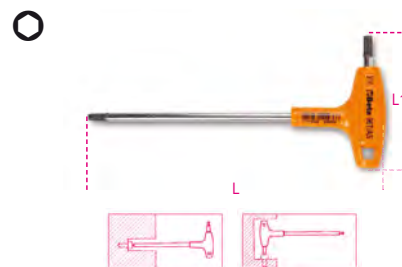

"	L mm	L1 mm	Ft	🔧	📄
3/32	153	55	5.610	2	000960669
7/64	153	55	5.610	2	000960670
1/8	179	70	5.760	2	000960671
9/64	179	70	5.930	2	000960672
5/32	200	84	5.930	2	000960673
3/16	200	84	5.930	2	000960674
7/32	221	103	6.680	2	000960675
1/4	236	106	7.420	2	000960676
5/16	255	117	8.380	2	000960678
3/8	285	132	9.980	2	000960680



96T/AS8	Ft	🔧	📄
3/32-7/64-1/8-5/32-3/16- 1/4-5/16-3/8	54.600	1	000960682
96T/AS10	67.250	1	000960683
3/32-7/64-1/8-9/64-5/32 3/16-7/32-1/4-5/16-3/8			

96TBP

T-szárú imbuszkulcs műanyag markolattal



mm	L mm	L1 mm	Ft	🔧	📦
2,5	153	55	4.760	3	000960685
3	153	55	5.030	3	000960686
4	179	70	5.190	3	000960687
5	200	84	5.440	3	000960688
6	221	103	5.940	3	000960689
8	255	117	7.930	2	000960690
10	285	132	8.390	2	



96TBP/S6	Ft	🔧	📦
2,5-3-4-5-6-8 mm	34.300	1	000960694

97TX

Hajlított Torx®-imbuszkulcs, barnított



mm	L mm	L1 mm	Ft	🔧	📦
T6	42	16	2.530	5	000970006
T7	48	16	2.530	5	000970007
T8	48	16	2.530	5	000970008
T9	48	16	2.770	5	000970009
T10	51	17	2.840	5	000970010
T15	54	18	2.840	5	000970015
T20	57	19	3.030	5	000970020
T25	60	20	3.090	5	000970025
T27	64	21	3.400	5	000970027
T30	70	24	3.400	5	000970030
T40	76	26	3.800	5	000970040
T45	83	29	4.520	5	000970045
T50	95	32	5.130	5	000970050
T55	108	35	6.630	5	000970055
T60	120	38	8.750	5	000970060



97TX/ST8	Ft	🔧	📦
T9-T10-T15-T20-T25-T27-T30-T40	26.900	1	000970640



97TX/G8	Ft	🔧	📦
T9-T10-T15-T20-T25-T27-T30-T40	21.150	1	000970645



97TX/BG8	Ft	🔧	📦
T9-T10-T15-T20-T25-T27-T30-T40	16.250	1	000970368



97TX/SC8	Ft	🔧	📦
T9-T10-T15-T20-T25-T27-T30-T40	26.950	1	000970064
97TX/SCV	1.770	1	000970985



97TX/B13	Ft	🔧	📦
T6-T7-T8-T9-T10-T15-T20-T25-T27-T30-T40-T45-T50	43.150	1	000970650
96N/BV	745	1	000960651

97BTX

Hajlított gömbfejű Torx®-imbuszkulcs, barnított

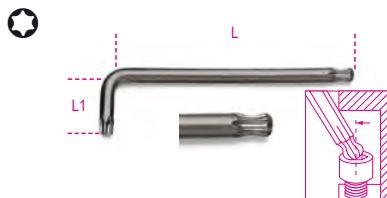

mm	L mm	L1 mm	Ft	🔧	📦
T9	62	16	3.180	5	000970109
T10	71	17	3.180	5	000970110
T15	81	18	3.180	5	000970115
T20	92	19	3.410	5	000970120
T25	94	20	3.630	5	000970125
T27	105	21	3.860	5	000970127
T30	114	24	3.920	5	000970130
T40	129	26	4.430	5	000970140
T45	133	28	5.390	5	000970145
T50	152	32	5.950	3	000970150
T55	164	35	8.420	3	000970155



97BTX/SC8	Ft	🔧	📦
T9-T10-T15-T20-T25-T27-T30-T40	30.550	1	000970164
97BTX/SCV	1.770	1	000970983



97BTX/B8	Ft	🔧	📦
T9-T10-T15-T20-T25-T27-T30-T40	29.550	1	000970159
96N/BV	745	1	000960651

97BTX-C

gömbfejű hajlított imbuszkulcskészlet, Torx® csavarokhoz, színezett



mm	L mm	L1 mm	Ft	🔧	📦
T9	80	16	3.740	5	000971609
T10	86	17	3.740	5	000971610
T15	90	18	3.740	5	000971615
T20	95	19	3.760	5	000971620
T25	100	20	3.970	5	000971625
T27	105	21	4.100	5	000971627
T30	114	24	4.520	5	000971630
T40	124	26	4.810	5	000971640



97BTX-C/SC8	Ft	🔧	📦
T9-T10-T15-T20-T25-T27-T30-T40	34.150	1	000971658
97BTX-C/SCV	1.770	1	000971659



97BTLX

hajlított bitkulcs egyik vége gömbölyű, hosszú kivitel
Torx® csavarokhoz



	L mm	L1 mm	Ft	🔧	📄
T9	80	15	3.350	3	000970309
T10	86	17	3.350	3	000970310
T15	100	18	3.350	3	000970315
T20	110	19	3.780	3	000970320
T25	126	20	4.140	3	000970325
T27	140	24	4.620	3	000970327
T30	160	28	4.840	3	000970330
T40	176	32	5.780	3	000970340



	Ft	🔧	📄
97BTLX/SC8	35.000	1	000970364
T9-T10-T15-T20-T25-T27-T30-T40			
97BTLX/SCV	1.770	1	000970982

97RTX

Hajlított Tamper Resistant Torx®
imbuszkulcs



	L mm	L1 mm	Ft	🔧	📄
T6	40	15	2.630	5	000970206
T7	45	15	2.630	5	000970207
T8	50	16	2.630	5	000970208
T9	56	16	2.980	5	000970209
T10	62	17	2.980	5	000970210
T15	72	17	3.050	5	000970215
T20	83	18	3.160	5	000970220
T25	90	18	3.230	5	000970225
T27	100	20	3.650	5	000970227
T30	105	24	3.660	5	000970230
T40	112	26	4.100	5	000970240
T45	118	26	4.060	5	000970245
T50	122	28	5.270	3	000970250
T55	128	30	6.050	3	000970255



	Ft	🔧	📄
97RTX/SC8	28.600	1	000970263
T9-T10-T15-T20-T25-T27-T30-T40			
97RTX/SCV	1.770	1	000970984



	Ft	🔧	📄
97RTX/B8	27.550	1	000970260
T9-T10-T15-T20-T25-T27-T30-T40			
96N/BV	745	1	000960651

97TTX

T-szárú Torx®-imbuszkulcs,
műanyag markolattal, krómozott,
fekete hegyek



	L mm	L1 mm	Ft	🔧	📄
T6	130	52	4.600	3	000970706
T7	130	52	4.600	3	000970707
T8	139	52	4.600	3	000970708
T9	139	52	4.600	3	000970709
T10	179	70	4.750	3	000970710
T15	179	70	5.150	3	000970715
T20	179	70	5.350	3	000970720
T25	179	70	5.620	3	000970725
T27	200	84	6.180	3	000970727
T30	200	84	6.450	3	000970730
T40	221	103	7.760	3	000970740
T45	236	106	8.970	2	000970745
T50	255	117	11.450	2	000970750



	Ft	🔧	📄
97TTX/S6	35.100	1	000970791
T10-T15-T20-T25-T30-T40			
97TTX/S8	45.850	1	000970808
T8-T10-T15-T20-T25-T27-T30-T40			
97TTX/S11	70.900	1	000970800
T8-T9-T10-T15-T20-T25-T27-T30-T40-T45-T50			
97TTX/S13	80.100	1	000970813
T6-T7-T8-T9-T10-T15-T20-T25-T27-T30-T40-T45-T50			



	Ft	🔧	📄
97TTX/SP11	80.500	1	000970840
T8-T9-T10-T15-T20-T25-T27-T30-T40-T45-T50			
96T/SPV	11.350	1	000960958
96T/S11			
97TTX/S11			

98XZN

XZN®-profilú imbuszkulcs,
nikkelezett



DIN 65253

	L mm	L1 mm	Ft	🔧	📄
M5	83	25	2.240	5	000980005
M6	89	30	2.580	5	000980006
M8	97	32	3.250	5	000980008
M10	106	35	4.230	5	000980010
M12	116	37	5.360	5	000980012
M14	118	45	6.780	5	000980014
M16	125	45	10.100	5	000980016



	Ft	🔧	📄
98XZN/B5	18.400	1	000980650
M5-M6-M8-M10-M12			
96N/BV	745	1	000960651

99

Körmoskulcs az UNI/ISO 2982, 2983 szerinti
hornyos anyához, krómozott



UNI 6752

	A mm	Ft	🔧	📄
12-14	1,5	4.110	3	000990012
16-18-20	1,8	4.110	3	000990016
22-25-28	1,8	5.430	3	000990022
30-32	2,1	5.430	3	000990030
34-36-38	2,4	6.450	3	000990034
40-42	2,4	6.450	3	000990040
45-50	2,5	8.390	3	000990045
52-55-58	2,5	8.390	3	000990052
62-65	3,1	10.800	3	000990062
68-70-75	3,1	10.800	3	000990068
80-85-90	3,8	14.200	2	000990080
92-95	4,3	14.200	2	000990092
98-100	4,3	14.200	2	000990098
105-110-115	4,4	22.850	1	000990105
120-125-130	4,9	22.850	1	000990120
135-145	6,0	31.000	1	000990135
155-165	6,0	31.000	1	000990155

99SQ

Állítható körmoskulcs,
krómozott



	B mm	Ft	🔧	📄
15-35	2,7	11.300	2	000990215
35-50	3,5	12.950	2	000990235
50-80	4,7	16.900	2	000990250
80-120	6,2	23.000	2	000990280
120-180	7,8	31.050	2	000990290

99ST

Állítható csapos körmőskulcs, krómozott



Ø mm	Ø mm	B mm	Ft		
15-35	3,0	2,5	11.500	2	000990315
35-50	4,0	4,5	13.800	2	000990335
50-80	5,0	5,0	18.300	2	000990350
80-120	6,0	7,0	24.600	2	000990380
120-180	8,0	9,0	32.400	2	000990390

99 VN/...

Tartalék csapok a 99ST-hez

	Ø mm	Ft		
99ST VN/15	15-35	3.250	1	000990295
99ST VN/35	35-50	3.770	1	000990296
99ST VN/50	50-80	4.550	1	000990297
99ST VN/80	80-120	5.320	1	000990298
99ST VN/120	120-180	6.750	1	000990299

100

Állítható homlokoldali csapos körmőskulcs, krómozott, barnított csapok

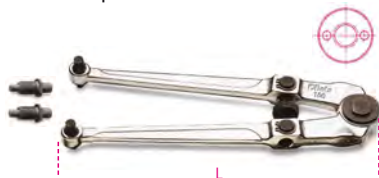

Ø mm	L mm	Ø min-max mm	Ft	
4,9-5,9	250	18÷100	59.750	1
6,9-7,9				

100/KIT

Tartalék csapok, barnított

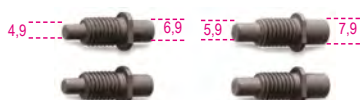

	Ft	
100/KIT	18.250	1

111E

ÁLLÍTHATÓ VILLÁSKULCS SKÁLÁVAL

A Beta 111E új, állítható, mérőskálával ellátott villáskulcsa fokozatmentesen állítható, így a befogó pofák különböző méretű csavarokhoz méretezhetők. A 15°-ban elforgatott fejnek köszönhetően a nehezen hozzáférhető helyeket is elérhetjük, mint az ikonikus "42" csillag-villáskulcsunkkal



Szélesre nyitható befogó pofák

Kompakt fej teljesen nyitott pófával

Kettős lézeres skála: mm/coll

Az új ergonomikus kivitel 20%-kal könnyebb.

A nagy szilárdságú ötvöztött acél fokozott csavaroszilárdságot biztosít.

A speciális hőkezelés kiemelkedő kopásállóságot biztosít.

A markolaton kialakított lyuknál felakasztható.

111E

állítható villáskulcs skálával, krómozott

- Jobbmenetes orsó
- Mm/coll skála



DIN 3117 ISO 6787

L mm	L "	A max mm	Ft		
100	4	15	9.210	3	001110110
150	6	24	9.570	3	001110115
200	8	29	11.700	3	001110120
250	10	34	14.150	3	001110125
300	12	40	18.800	3	001110130
380	15	45	36.850	3	001110138
450	18	54	61.300	2	001110145
600	24	62	84.850	1	001110160

111EN

állítható villáskulcs skálával, foszfátózott

- Balmenetes orsó
- Mm/coll skála



DIN 3117 ISO 6787

L mm	L "	A max mm	Ft		
100	4	15	8.430	3	001110410
150	6	24	8.820	3	001110415
200	8	29	10.300	3	001110420
250	10	34	12.750	3	001110425
300	12	40	17.200	3	001110430
380	15	45	34.000	3	001110438
450	18	54	57.950	2	001110445

111ER

állítható villáskulcs megfordítható pófával, skálával, krómozott

- Megfordítható pófa
- Jobbmenetes orsó
- Mm/coll skála



L mm	L "	A max mm	Ø max mm	Ft	
200	8	29	3/4	15.300	3
250	10	34	1	18.800	3
300	12	40	1.1/4	30.100	2

111CM

széles nyílású állítható villáskulcs, krómozott, rövid sorozat

- Széles nyílás
- Jobbmenetes állítás
- Mm/coll skála



L mm	L "	A max mm	Ft		
170	6	32	17.500	2	001110770
220	8	38	21.250	3	001110722
270	10	46	28.150	3	001110727

120

Nyitható racsnis hollandier kulcs,
krómzott, barnított fejjel

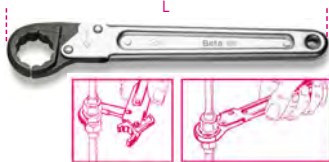

Ø mm	L mm	Ft	🔧	📦
10	135	18.900	1	001200010
11	135	18.900	1	001200011
12	135	18.900	1	001200012
13	135	18.900	1	001200013
14	135	21.150	1	001200014
17	185	22.650	1	001200017
19	185	24.200	1	001200019
22	230	33.200	1	001200022
24	230	35.950	1	001200024
27	230	45.550	1	001200027
30	320	51.900	1	001200030
32	320	54.350	1	001200032



	Ft	🔧	📦
120/B6N 10-11-13 17-19-22 mm	141.300	1	001200060
2002/BVL6	4.590	1	020020010

123E1/4

Adapter 1/4" 10 mm-es racsnikulcshoz



Ø mm	L mm	Ft	🔧	📦
10	20,6	2.480	1	001230010

123Q1/4

Adapter gyorscsatlakozóval 1/4" 10 mm-es
racsnikulcshoz



Ø mm	L mm	Ft	🔧	📦
10	17,5	3.360	1	001230310

123Q3/8

Adapter gyorscsatlakozóval 3/8" 13 mm-es
racsnikulcshoz

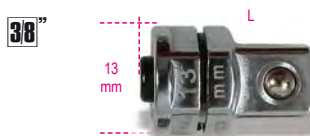

Ø mm	L mm	Ft	🔧	📦
13	22,5	3.360	1	001230313

123Q1/2

Adapter gyorscsatlakozóval 1/2" 19 mm-es
racsnikulcshoz



Ø mm	L mm	Ft	🔧	📦
19	30,5	3.620	1	001230319

123/K4

adapterkészlet racsnis csillagkulcshoz, 4
darabos:
1 bit adapter
3 adapter gyorscsatlakozóval



	Ft	🔧	📦
123/K4	12.800	1	001230504

141

egyenes, rövid csillag-villáskulcs racsnival



ISO 21982:2020

Ø mm	L mm	Ft	🔧	📦
8x8	136	5.930	3	001410008
9x9	143	6.370	3	001410009
10x10	160	6.510	3	001410010
11x11	168	6.690	3	001410011
12x12	174	6.930	3	001410012
13x13	180	7.500	3	001410013
14x14	193	7.810	2	001410014
15x15	200	8.140	2	001410015
16x16	216	8.970	2	001410016
17x17	233	9.370	2	001410017
18x18	239	10.400	2	001410018
19x19	250	10.600	2	001410019



	Ft	🔧	📦
141/B6 8-10-13-14-17-19 mm	51.350	1	001410066
141/B9 8-10-11-12-13-14-15-17-19 mm	73.800	1	001410069



	Ft	🔧	📦
141/S12 8-9-10-11-12-13- 14-15-16-17-18-19 mm	95.200	1	001410072

142-ES TÍPUSÚ RACSNIS KULCSOK

A 72-fogas racsnis legfeljebb 5°-os
felvételi szöget biztosít, ezáltal
biztosítja a csavarok gyors,
pontos meghúzását.

1 A hosszú száron
elhelyezett fix befogó lehetővé
teszi a csavarok erős
meghúzását.

2 A beépített irányváltó pöcök
segít elkerülni a véletlen
irányváltást.



3 A tizenkétszögű gyűrű vége
15°-os szöget zár be a kéz
védelme és a könnyebb
hozzáférés érdekében.

4 A fix fej 15°-os szöget zár
be a tengellyel, így kisebb
a felvételi szög.



142

Csillag-villáskulcs irányváltós
racsnival



ISO 21982:2020

Ø mm	L mm	Ft	🔧	📦
6x6	136	6.800	3	001420006
7x7	136	6.800	3	001420007
8x8	136	6.920	3	001420008
9x9	143	7.370	3	001420009
10x10	159	7.690	3	001420010
11x11	168	7.780	3	001420011
12x12	174	8.030	3	001420012
13x13	180	8.740	3	001420013
14x14	190	9.030	2	001420014
15x15	200	9.590	2	001420015
16x16	216	10.350	2	001420016
17x17	233	10.550	2	001420017
18x18	239	11.400	2	001420018
19x19	248	11.700	2	001420019
21x21	285	15.300	1	001420021
22x22	285	15.750	1	001420022
24x24	325	18.450	1	001420024
27x27	355	26.350	1	001420027
30x30	420	31.000	1	001420030
32x32	420	31.950	1	001420032
34x34	482	40.400	1	001420034
36x36	482	40.750	1	001420036
38x38	482	41.550	1	001420038



	Ft	U	PC
142/B6 8-10-13-14-17-19 mm	58.250	1	001420066
142/BV6	3.610	1	001420076
142/B9 8-10-11-12-13-14-15-17-19 mm	84.350	1	001420069
142/BV9	4.300	1	001420079



	Ft	U	PC
142/S15 6-7-8-9-10-11-12-13 14-15-16-17-18-19-22 mm	138.500	1	001420074
142/S17 6-7-8-10-11-12-13-14-15- 16-17-18-19-21-22-24-27 mm	191.200	1	001420068
142/S19 6-7-8-9-10-11-12 13-14-15-16-17-18 19-22-24-27-30-32 mm	246.300	1	001420075

142/SC9I-E

9 darabos csillag-villáskulcs-készlet, racsnival, kompakt tartóval



	Ft	U	PC
142/SC9I 8-10-11-12-13-14-15-17-19 mm	82.800	1	001420087
142/SCV9I	3.380	1	001420103
142/SC9E 8-10-11-12-13-16-17-18-19 mm	85.900	1	001420088
142/SCV9E	3.380	1	001420104

142MC

csillag-villáskulcs irányváltós racsnival, színezett



ISO 21982:2020

Ø mm	L mm	Ft	U	PC
8x8	136	7.270	3	001422008
10x10	159	7.780	3	001422010
11x11	168	8.260	3	001422011
12x12	174	8.590	3	001422012
13x13	180	9.410	3	001422013
14x14	190	9.870	2	001422014
15x15	200	10.300	2	001422015
16x16	216	11.050	2	001422016
17x17	233	11.250	2	001422017
18x18	239	11.900	2	001422018
19x19	248	12.300	2	001422019



	Ft	U	PC
142MC/SC9I 8-10-11-12-13-14-15-17-19 mm	87.800	1	001422087
142MC/SC9E 8-10-11-12-13-16-17-18-19 mm	90.550	1	001422088

142AS

Csillag-villáskulcs irányváltós racsnival



Ø mm	L mm	Ft	U	PC
5/16x5/16	136	8.160	2	001420308
3/8x3/8	159	8.380	2	001420310
7/16x7/16	168	8.910	2	001420311
1/2x1/2	180	9.940	2	001420313
9/16x9/16	190	10.200	2	001420314
5/8x5/8	216	11.100	2	001420316
11/16x11/16	233	11.300	2	001420317
3/4x3/4	248	12.550	2	001420319



	Ft	U	PC
142AS/8 5/16-3/8-7/16-1/2 9/16-5/8-11/16-3/4	80.550	1	001420330

142C

Egyenes, rövid csillag-villáskulcs racsnival



ISO 21982:2020

Ø mm	L mm	Ft	U	PC
8x8	88	4.990	2	001420108
9x9	96	4.990	2	001420109
10x10	96	5.110	2	001420110
11x11	100	5.460	2	001420111
12x12	104	5.840	2	001420112
13x13	108	6.110	2	001420113
14x14	114	6.390	2	001420114
15x15	118	6.620	2	001420115
16x16	122	6.860	2	001420116
17x17	128	7.410	2	001420117
18x18	132	7.920	2	001420118
19x19	138	8.160	2	001420119



	Ft	U	PC
142C/A12 8-9-10-11-12-13-14 15-16-17-18-19 mm	86.150	1	001420175

142SN

Csuklós racsnis csillag-villáskulcs



ISO 21982:2020

Ø mm	L mm	Ft	U	PC
7x7	136	8.090	2	001420207
8x8	136	8.470	2	001420208
9x9	143	8.740	2	001420209
10x10	160	9.370	2	001420210
11x11	168	9.560	2	001420211
12x12	174	9.880	2	001420212
13x13	180	10.550	2	001420213
14x14	193	10.850	2	001420214
15x15	200	11.550	2	001420215
16x16	216	12.250	2	001420216
17x17	233	12.600	2	001420217
18x18	239	13.400	2	001420218
19x19	250	13.650	2	001420219
22x22	285	16.100	1	001420222
24x24	325	18.200	1	001420224



	Ft	U	PC
142SN/S13 7-8-9-10-11-12-13-14 15-16-17-18-19 mm	139.000	1	001420263



	Ft	U	PC
142SN/SC9 8-10-11-12-13-14-15-17-19 mm	99.250	1	001420259

186

önzáró kulcs automatikus visszaállítással
8 és 32 mm közötti hatszögű csavarokhoz

a következő profilú csavarfejekhez ideális: hatszög, Spline, négyyszög, Torx(R); sérült is.



L mm	Ft	🔧	📄
260	19.000	1	001860008

187

Csuklós csillagkulcs, nyitható



🔧 mm	L mm	Ft	🔧	📄
8x9	125	13.050	1	001870008
10x11	155	14.050	1	001870010
12x13	175	14.650	1	001870012
14x15	205	16.250	1	001870014
16x17	235	18.150	1	001870016



187/B5	Ft	🔧	📄
8x9-10x11-12x13 14x15-16x17 mm	80.500	1	001870050

188

Egyenes racsnis csillagkulcs,
váltó áramú generátor ékszíjtárcsához



🔧 mm	L mm	Ft	🔧	📄
10	240	8.660	2	001880010
15	322	11.550	2	001880015

192

Egyenes racsnis csillagkulcs 4 az 1-ben



🔧 mm	L mm	Ft	🔧	📄
8x10/12x13 16x17/18x19	160 230	11.100 14.300	1 1	001920008 001920016

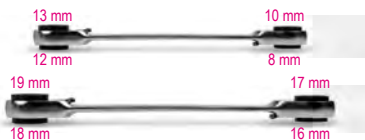

192/S2	Ft	🔧	📄
8x10/12x13 mm 16x17/18x19 mm	25.400	1	001920070

194

Betéttartókulcs átváltós racsnival



1/4x5/16	L mm	Ft	🔧	📄
	128	14.450	2	001940006

195

Egyenes racsnis csillagkulcs



ISO 21982:2020

🔧 mm	L mm	Ft	🔧	📄
8x10	128	7.690	2	001950010
12x13	170	8.900	2	001950013
14x15	190	9.370	2	001950015
16x18	230	10.850	2	001950018
17x19	230	11.100	2	001950019



195/B5	Ft	🔧	📄
8x10-12x13-14x15 16x18-17x19 mm	52.250	1	001950066
195/BV5	4.350	1	001950070

195AS

Egyenes racsnis csillagkulcs



🔧	L mm	Ft	🔧	📄
5/16x3/8	128	7.920	2	001950606
7/16x1/2	170	8.910	2	001950611
9/16x5/8	190	10.200	2	001950614
11/16x3/4	230	11.100	2	001950617



195AS/B4	Ft	🔧	📄
5/16x3/8 - 7/16x1/2 - 9/16x5/8 - 11/16x3/4	42.500	1	001950654
195FTX/BV4	4.350	1	001950520

195P

Racsnis csillagkulcs 15°-ban hajlított



ISO 21982:2020

🔧 mm	L mm	Ft	🔧	📄
8x10	128	11.550	2	001950210
12x13	170	12.600	2	001950213
14x15	190	13.000	2	001950215
16x18	230	14.450	2	001950218
17x19	230	15.350	2	001950219



195P/B5	Ft	🔧	📄
8x10-12x13-14x15 16x18-17x19 mm	71.300	1	001950266
195/BV5	4.350	1	001950070

310

Csőhegesztő PE, PP, PVC
műanyagokhoz, PVDF csövekhez
és szerelvényekhez

CE



230V-650 Watt
50 Hz±60Hz
Schuko (CEE 7/7)

	∅ mm	Ft	🔧	📄
310/1	16÷50	110.800	1	003100001
310/2	16÷63	151.700	1	003100002

310B

Idomok a 310 csőhegesztőhöz



∅ mm	Ft	🔧	📄
16	25.750	1	003100016
20	28.350	1	003100020
25	29.300	1	003100025
32	33.450	1	003100032
40	39.100	1	003100040
50	50.250	1	003100050
63	58.050	1	003100063



Beta

310/C4

Csőhegesztő 3 idommal, fémdobozban



310/C4 Ft 219.900 1 003100104
 310/1+310B: Ø 20-25-32
 410x260x82 mm - 4,8 kg

310/C8

Csőhegesztő 7 idommal, fémdobozban



310/C8 Ft 338.000 1 003100108
 310/2+310B: Ø 16-20-25
 32-40-50-63
 440x270x120 mm - 7,7 kg

311

Platinis kézi csőhegesztő PE csövekhez



Ø mm Watt Ft 1 003110001 1 003110002
 311/1 120 300 130.600
 311/2 190 900 148.400

A BETA CSŐVÁGÓK ALKALMAZÁSI TERÜLETEI

A Beta csővágók széles körben alkalmazhatók. Pontos, sima görgői és csavaros vagy teleszkópos előtolói miatt bármilyen csőanyagon pontos és tiszta vágások végezhetők.

Az alábbi táblázatban láthatók az egyes anyagokhoz alkalmas csővágó/vágókerék kombinációk.

	ACÉL GÁZCSÖVEK		
	10 mm	60 mm	115 mm
	1/8"	2"	4"
330/2			
330/4			

	ROZSDAMENTES ACÉL GÁZCSÖVEK		
	10 mm	60 mm	115 mm
	1/8"	2"	4"
330/2+330R/12			
330/4+330R/14			

	RÉZ ÉS KÖNNYŰ ÖTVÖZET CSÖVEK							
	3 mm	6 mm	8 mm	16 mm	28 mm	30 mm	38 mm	67 mm
	1/8"	1/4"	5/16"	5/8"	1 1/8"		1 1/2"	2 5/8"
332								
334								
336								
338								

	VÉKONY FALÚ ROZSDAMENTES ACÉL CSÖVEK							
	3 mm	6 mm	8 mm	16 mm	28 mm	30 mm	38 mm	67 mm
	1/8"	1/4"	5/16"	5/8"	1 1/8"		1 1/2"	2 5/8"
332 + 334R/I								
334 + 334R/I								
336 + 338R/I								
338 + 338R/I								

	MŰANYAG CSÖVEK							
	6 mm	8 mm	16 mm	30 mm	38 mm	50 mm	67 mm	127 mm
	1/4"	5/16"	5/8"	1 1/8"	1 1/2"	2"	2 5/8"	5"
336 + 338RP								
338 + 338RP								
339A								

330

Csővágó, acél gázcsövekhez



	Ø mm -"	L mm	Ft	1	003300002
330/2	10÷60 1/8"÷ 2"	380	64.200	1	003300002
330/4	60÷115 2"÷ 4"	585	144.500	1	003300004

330R/A

Tartalék vágókerék a 330 típusú csővágóhoz, acélcsövekhez

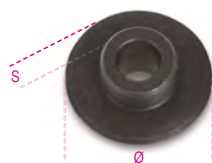

	Ø mm	S mm	Ft	1	003300012
330R/A2	32	7	6.040	1	003300012
330R/A4	42	9	15.550	1	003300014

330R/I

Tartalék vágókerék a 330 típusú csővágóhoz, rozsdamentes acélcsövekhez



	Ø mm	S mm	Ft	1	003300024
330R/I2	32	7	13.550	1	003300024
330R/I4	32	9	37.950	1	003300034

331C

hordozható C-formájú csővágó réz- és könnyűfém csövekhez



	Ø mm	L mm	Ft	1	003310050
15÷22	15÷22	78	25.250	1	003310050

332

mini csővágó réz-
és könnyűfém csövekhez



Ø mm - "	L mm	Ft		
3÷16 1/8"±5/8"	59	9.110	2	003320001
3÷28 1/8"±1"1/8"	63	10.300	2	003320003

334

Csővágó, réz és könnyűfém
csövekhez



Ø mm - "	L mm	Ft		
3÷30 1/8"±1"1/8"	150	12.550	1	003340001

334R

Tartalék vágókerék a 332 és 334
típusú csővágókhoz,
réz és könnyűfém csövekhez

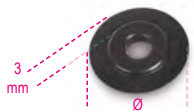

Ø mm	Ft		
334R 18	2.560	1	003340021

334R/I

Tartalék vágókerék a 332 és 334
típusú csővágókhoz,
rozsdamentes acélcsövekhez



Ø mm	Ft		
334R/I 18	7.420	1	003340023

336

Teleszkópos csővágó
réz és könnyűfém csövekhez



Ø mm - "	L mm	Ft		
6÷38 1/4"±1"1/2"	160	21.050	1	003360001

338

Teleszkópos csővágó gyors
előtolással, réz, könnyűfém
és műanyag csövekhez



Ø mm - "	L mm	Ft		
6÷67 1/4"±2"5/8"	290	51.800	1	003380001

338R

Tartalék vágókerék a 331L, 336 és 338
típusú csővágókhoz,
réz és könnyűfém csövekhez



Ø mm	Ft		
338R 18,5	2.820	1	003380022

338R/I

Tartalék vágókerék a 336 és 338
típusú csővágókhoz, rozsdamentes
acélcsövekhez

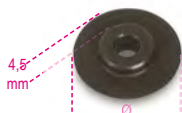

Ø mm	Ft		
338R/I 21,8	8.500	1	003380023

338RP

Tartalék vágókerék a 336 és 338
típusú csővágókhoz



Ø mm	Ft		
338RP 21,9	3.080	1	003380025

339A

Teleszkópos csővágó gyors
előtolással, műanyag csövekhez



Ø mm - "	L mm	Ft		
50÷127 2"±5"	345	111.300	1	003390011

339A/R

Tartalék vágókerék a 339A-hoz

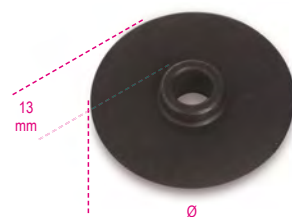

Ø mm	Ft		
339A/R 42	7.520	1	003390061

340

csővágó fogó többretegű csövekhez
legnagyobb Ø 26 mm
PTFE burkolatú penge
4 támasztógörgő a cső forgatásának megkönnyítésére vágás
közben
nyélbe épített flexibilis cső vágó rendszer
könnyű magnézium test



Ø max mm	Ft		
340 26	50.750	1	003400001

340RL

pótpenge a 340 fogóhoz



Ø max mm	Ft		
340RL 26	13.400	1	003400010

340C

csővágó fogó bordás csövekhez

alumínium-magnézium ötvözet
kompakt, könnyű, zsebben elfér
kiegészítő vágólap hosszanti vágáshoz



Ø mm	L mm	Ft		
14-45	134	23.100	1	003400050

340C/KRL

3 darabos vágólap készlet a 340C fogóhoz



Ft			
13.650	1	003400055	

341

Csővágó fogó műanyag csövekhez



Ø mm	L mm	Ft		
0÷25	190	14.850	1	003410001

341RL

Tartalék vágókés a 341 típusú csővágó fogóhoz



Ft			
6.730	1	003410010	

341B

Racsnis csővágóolló műanyagcsövekhez



Ø mm	L mm	Ft		
0÷35	195	29.000	1	003410051

341B/RM

Tartalék rugó a 341B típusú csővágóollóhoz

Ft			
1.080	1	003410061	

341B/RL

Tartalék vágókés a 341B típusú csővágó ollóhoz



Ft			
10.150	1	003410060	

342

Racsnis csővágóolló műanyag csövekhez



Ø mm - "	L mm	Ft		
0÷42 1"5/8	200	20.500	1	003420030

342MOL

Tartalék rugó a 342-es modellhez

Ft			
1.550	1	003420033	

342RL

Tartalék vágókés a 342-es modellhez



Ft			
9.340	1	003420032	

342A

Racsnis csővágóolló műanyag csövekhez



Ø mm - "	L mm	Ft		
0÷50 2"	270	41.250	1	003420101

342A/MOL

Tartalék rugó a 342A-hoz

Ft			
880	1	003420111	

342A/RL

Tartalék vágókés a 342A típusú ollóhoz



Ft			
22.050	1	003420110	

342P

Racsnis csővágó olló műanyag csövekhez, magnézium ötvözet



Ø mm - "	L mm	Ft		
0÷50 2"	260	45.550	1	003420121

342P/RL

Tartalék vágókés 342P-hez



Ft			
19.350	1	003420130	

Beta

345

Csőorjázó, műanyaggal bevont fémtest



Ø mm - "	L mm	Ft		
3÷42 1/8"÷1"5/8	58	11.400	5	003450001

345U

Belső-külső-sorjázó, acél, réz és könnyűfém csövekhez



Ø mm - "	L mm	Ft		
4÷36 5/32÷1"7/16	60	29.750	1	003450050

345U/A

adapter a 345U csőorjázóhoz, 1/4" hatlapfejű csatlakozó fúrókhoz

1/4"



L mm	Ft		
90	8.130	3	003450055

345C

kálibráló eszköz többretegű csövekhez



Ø mm	Ft		
16-20-26-32	17.950	1	003450032

345SB

Sorjázó forgó cserélhető késsel, gyorsacél, réz, könnyűfém és PVC csövekhez



L mm	Ft		
150	9.270	5	003450010

345SB/R

Tartalék vágókés a 345SB sorjázóhoz



345SB/R	Ft		
	3.230	3	003450015

345SB2

sorjázó rögzített késsel



L mm	Ft		
140	4.700	5	003450022

345SC

4 az 1-ben külső-belső sorjázó, 1/2" és 3/4" átmérőhöz



L mm	L1 mm	L2 mm	Ft		
195	28	32	5.500	2	
					003450060

345SI

belső sorjázó, forgó cserélhető késsel



L mm	Ø mm	Ft		
168	16,5	17.900	1	003450040

345SI/R

tartalék kés a 345SI sorjázóhoz



345SI/R	Ft		
	12.300	1	003450045

349

Csőperemező réz és könnyűfém csövekhez

3/8"



Ø mm - "	Ft		
6-8-10-12-14-15-16-18 (1/8-3/16-1/4-5/16 3/8-1/2-5/8-3/4)	108.800	1	003490001
270x200x50 mm - 2,7 kg			

349/SMM

Peremező szán, metrikus a 349-hez



Ø mm	Ft		
6-8-10-12-14-15-16-18	33.250	1	003490011

349/SMAS

Peremező szán, col-os a 349-hez



Ø "	Ft		
1/8-3/16-1/4-5/16 3/8-1/2-5/8-3/4	31.100	1	003490012

350

Csőperemező réz és könnyűfém csövekhez



Ø mm	L mm	A mm	Ft	1	003500001
4-4,75-6-8-10-12-14	175	104	32.700	1	003500001

351C

Csővágó és peremező készlet, műanyag dobozban



351C	Ft	1	003510010
	58.900	1	003510010

334 Ø 3+30 mm (1/8"+1"1/8)

350 Ø 4+14 mm

351P Ø 4-4,75-6-8-10-12-14 mm

225x150x45 mm - 1,6 kg

351P

Peremező betétek a 350 típusú csőperemezőhöz



351P	Ø mm	Ft	3	003510101
4	4	2.620	3	003510101
4,75	4,75	2.620	3	003510102
6	6	2.620	3	003510103
8	8	2.620	3	003510104
10	10	2.720	3	003510105
12	12	2.720	3	003510106
14	14	2.720	3	003510107

352U

Csőperemező réz és könnyűfém csövekhez



Ø mm - "	A mm	Ft	1	003520101
5=16 3/16÷5/8	130	37.700	1	003520101

352C/U

Csővágó, sorjázó és peremező készlet



352C/U	Ft	1	003520110
	73.900	1	003520110

334 Ø 3+30 mm (1/8"+1"1/8)

345SB

352U Ø 5+16 mm (3/16"+5/8")

335x145x60 mm - 2120 g

353N

Csőtágító fogó



L mm	Ft	1	003530201
380	147.600	1	003530201

353NM

353N csőtágító fogóhoz formázó szerszám



Ø mm	A mm	Ft	1	003530210
10	7	50.200	1	003530210
12	10	50.200	1	003530212
14	10	50.200	1	003530214
16	12	50.200	1	003530216
18	12	50.200	1	003530218
22	13	50.200	1	003530222

353N/C6

353N csőtágító fogó 353NM formázó szerszámokkal



353N/C6	Ft	1	003530300
	467.100	1	003530300

353N

353NM Ø 10-12-14-16-18-22 mm

420x185x60 mm - 2,2 kg

355

Ötlépcsős szerelőkulcs



Ø "	L mm	Ft	2	003550001
3/8"-1/2" 3/4"-1"	90	15.350	2	003550001

357F3

Vízmérték 3 libellával csapok beállításához

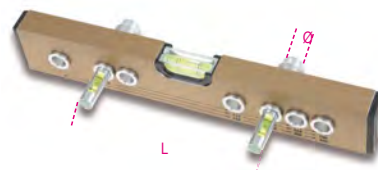

Ø "	L mm	Ft	1	003570100
3/8" / 1/2"	90÷220	48.250	1	003570100

357R/F3

cserefiola a 357F3 cikkhez



357R/F3	Ft	1	003570101
	7.620	1	003570101

Beta

358

Sorjázó készülék műanyag csövekhez, lakkozott



	Ø mm	Ft		
358/1	16÷110	67.800	1	003580001
358/2	40÷250	67.800	1	003580002

358RL

Tartalék sorjázó kés a 358/1 és a 358/2 típusú sorjázó készülékhez



	Ft		
358RL	12.350	1	003580011

359

Univerzális lefolyókulcs



Ø"	L mm	A mm	Ft		
1"÷1 1/4"	160	140	32.450	1	003590001

359CH

Lefolyóadapter, keresztalakú, alumínium



Ø"	L mm	Ft		
1 1/2"	74	18.200	1	003590005

360

„Stillson” csőfogó kovácsolt acélból



L mm	Ø max"	Ø max mm	Ft		
250	1" gas	34	13.950	1	003600025
350	1 1/2" gas	49	18.650	1	003600035
450	2" gas	60	25.700	1	003600045
600	2 1/2" gas	76	39.100	1	003600060
900	3 1/2" gas	102	109.600	1	003600090

360R/...

Alkatrészkit a 360 modellhez
Tartalma: pofa és állítógyűrű

	Ft		
360R250	5.140	1	003600225
360R350	6.830	1	003600235
360R450	10.150	1	003600245
360R600	15.250	1	003600260
360R900	26.200	1	003600290

361N

állítható csőkulcs



L mm	Ø max"	Ø max mm	Ft		
350	1" 1/2"	49	31.650	1	003610014

362

Amerikai csőfogó



L mm	Ø max"	Ø max mm	Ft		
200	1" gas	34	12.050	1	003620020
250	1 1/2" gas	49	15.000	1	003620025
300	2" gas	60	18.150	1	003620030
350	2" gas	60	21.750	1	003620035
450	2 1/2" gas	76	31.650	1	003620045
600	3" gas	90	48.000	1	003620060
900	5" gas	140	58.750	1	003620090

362R/...

Alkatrészkit a 362 modellhez
Tartalma: fix pofa; mozgó pofa; állítógyűrű, rögzítő stift

	Ft		
362R 200	2.450	1	003620220
362R 250	3.530	1	003620225
362R 300	4.150	1	003620230
362R 350	4.900	1	003620235
362R 450	6.610	1	003620245
362R 600	9.060	1	003620260
362R 900	23.050	1	003620290

363

Amerikai csőfogó



L mm	Ø max"	Ø max mm	Ft		
350	2" gas	60	26.700	1	003630035
450	2 1/2" gas	76	35.550	1	003630045
600	3" gas	90	60.450	1	003630060
900	5" gas	140	112.400	1	003630090
1200	6" gas	165	118.500	1	003630120

363R/...

Alkatrészkit a 363 modellhez
Tartalma: fix pofa; mozgó pofa; állítógyűrű, rögzítő stift

	Ft		
363R 350	5.410	1	003630235
363R 450	7.440	1	003630245
363R 600	9.870	1	003630260
363R 900	21.500	1	003630290
363R 1200	32.850	1	003630320

365

Amerikai csőfogó, eltolt tengelyű modell

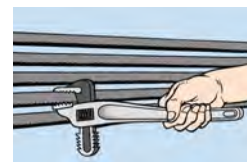

L mm	Ø max"	Ø max mm	Ft		
350	2" gas	60	33.500	1	003650035
450	2 1/2" gas	76	45.500	1	003650045

365R/...

Alkatrészkit a 365 modellhez
Tartalma: fix pofa; mozgó pofa; állítógyűrű, rögzítő stift

	Ft		
365R 350	24.850	1	003650235
365R 450	36.800	1	003650245

366

Csőfogó, könnyített kivitel, szénacélból



L mm	Ø max"	Ø max mm	Ft		
175	1" gas	34	12.000	1	003660017
225	1 1/2" gas	49	14.650	1	003660022
275	2" gas	60	17.400	1	003660027
300	2 1/2" gas	76	18.750	1	003660030
350	3" gas	90	21.100	1	003660035

374

Svéd csőfogó, 45°-os keskeny pofa



DIN 5234

L mm	Ø max" gas	Ø max mm	Ft	🔧	📄
240	1/2" gas	21	14.500	1	003740024
320	1" gas	34	19.300	1	003740032
410	1 1/2" gas	49	25.450	1	003740041
550	2" gas	60	40.150	1	003740055
630	3" gas	90	71.950	1	003740063

375

Svéd csőfogó
45° -os keskeny pofa



DIN 5234

L mm	Ø max" gas	Ø max mm	Ft	🔧	📄
320	1" gas	34	19.300	1	003750032
410	1 1/2" gas	49	25.450	1	003750041
550	2" gas	60	40.150	1	003750055

376

Svéd csőfogó, 90°-os lapos pofa



DIN 5234

L mm	Ø max" gas	Ø max mm	Ft	🔧	📄
320	1" gas	34	19.300	1	003760032
410	1 1/2" gas	49	25.450	1	003760041
550	2" gas	60	40.150	1	003760055
630	3" gas	90	71.350	1	003760063

378

Svéd csőfogó, 45°-os keskeny pofa



DIN 5234

L mm	Ø max" gas	Ø max mm	Ft	🔧	📄
250	1/2" gas	21	15.200	1	003780025
320	1" gas	34	20.400	1	003780032
410	1 1/2" gas	49	26.600	1	003780041
550	2" gas	60	43.200	1	003780055
650	3" gas	90	73.350	1	003780065

374R/...

Komplett alkatrészek a 374 - 375 - 376 - 378
modellhez
hornyos anya és állítógyűrű

	Ft	🔧	📄
374R 240 x 374/240-378/250	885	1	003740724
374R 320 x 374/320-376/320-378/320	985	1	003740732
374R 410 x 374/410-375/410-376/410-378/410	1.210	1	003740741
374R 550 x 374/550-376/550-378/550	1.420	1	003740755
374R 630 x 374/630-378/650	1.960	1	003740763

383

Kettős működésű szijas csőfogó,
kovácsolt acél fogantyú



	Ø max" gas	Ø max mm	L mm	Ft	🔧	📄
383/1	3" gas	90	300	20.800	1	003830001
383/2	8" gas	220	300	21.750	1	003830002

383R

Tartalék szijak a 383 típusú
csőfogóhoz



	S mm	Ft	🔧	📄
383R/1	27	8.350	1	003830010
383R/2	27	9.070	1	003830015

384

Kettős működésű láncos csőfogó



	Ø max" gas	Ø max mm	L mm	Ft	🔧	📄
384	4" gas	115	300	27.850	1	003840032

384RC

Tartalék lánc a 384 típusú
csőfogóhoz



	Ft	🔧	📄
384RC	17.200	1	003840033

386A/RC

Tartalék lánc a 386A-hoz



	Ft	🔧	📄
386A3/RC	29.800	1	003860013
386A4/RC	42.750	1	003860014
386A5/RC	57.000	1	003860015
386A6/RC	99.300	1	003860016

387

csőhajlító réz- és színesfémcsövekhez,
cserélhető kengyelekkel
3/16"-1/4"-5/16"-3/8"



L mm	Ø mm	Ft	🔧	📄
255	3/16"-1/4"-5/16"-3/8"	21.100	1	003870001

387R

tartalék kengyel a 387 termékhez



Ø "	Ft	🔧	📄
3/16"-1/4"	4.400	1	003870010
5/16"-3/8"	4.640	1	003870015

388

Csőhajlító, vékonyfalú réz, könnyűfém és
lágycél csövekhez

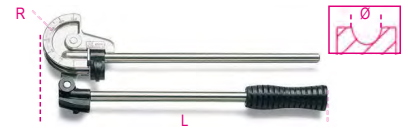

Ø mm	L mm	R mm	Ft	🔧	📄
6	305	18,0	23.250	1	003880006
8	315	23,5	25.300	1	003880008
10	350	31,0	29.050	1	003880010
12	360	31,0	30.900	1	003880012
14	455	46,5	39.800	1	003880014
15	465	46,5	42.350	1	003880015
16	465	46,5	45.900	1	003880016

388A

Csőhajlító vékonyfalú réz és könnyűfém
csövekhez



	Ø mm	L mm	Ft	🔧	📄
388A/1	6-8-10 mm	220	25.600	1	003880051
388A/2	1/4"-5/16"-3/8"	220	25.700	1	003880055

388C/C8

Csőhajlító 7 kengyelrel
réz és könnyűfém csövekhez



	Ø mm	Ft	🔧	📄
388C/C8	10-12-14-16 18-20-22	188.100	1	003880200

📦 400x330x110 mm - 📖 3,6 kg

389/K4

csőhajlító rugó készlet
rézcsövekhez
külső



\emptyset	L	Ft	🔧	📄
1/4-3/8-1/2-5/8	mm 290	8.580	1	003890001

386A

Erősített láncos csőfogó



	\emptyset	L	Ft	🔧	📄
386A/3	max 4" gas 115 mm	900	93.100	1	003860003
386A/4	6" gas 168 mm	900	178.600	1	003860004
386A/5	8" gas 220 mm	1100	226.300	1	003860005
386A/6	12" gas 324 mm	1300	391.900	1	003860006

392C

"Connector"-Szifonfogó



\emptyset	L	Ft	🔧	📄
mm 25÷65	mm 260	17.600	1	003920100

392RG/C

Tartalék pófavédő a 392C modellhez, 1 pár



	Ft	🔧	📄
392RG/C	2.360	1	003920101

393

Hollander fogó PVC-bevonatú
szárak, krómozott



L	Ft	🔧	📄
mm 270	25.750	1	003930001

395

Univerzális önzáró hollander kulcs,
lakkozott



\emptyset	L	Ft	🔧	📄
15÷32 mm 5/8"±1"1/4	mm 240	16.600	1	003950001

395T

Teleszkópos hollander kulcs,
krómozott test, lakkozott pófák



\emptyset	L	Ft	🔧	📄
10÷32 mm 3/8"±1"1/4	mm 250÷430	22.750	1	003950100

398

munkapadra szerelhető láncos csőszatu



\emptyset	L	Ft	🔧	📄
1/2÷8"	mm 250	117.500	1	003980008

399

Asztali csőszatu, lakkozott

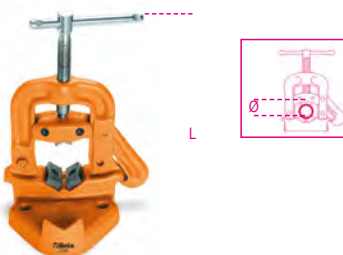

\emptyset	L min	Ft	🔧	📄
10÷60 mm	mm 220	72.000	1	003990005
1/8÷2"				
10÷89 mm	290	130.600	1	003990010
1/8÷3"				

399R/...

tartalék készlet a 399 modellhez,
két alsó pófa és egy felső pófa



	Ft	🔧	📄
399RG1/8-2"	10.400	1	003990105
399RG1/8-3"	17.450	1	003990110

Beta

TÁBLÁZAT FÚRÓSZERSZÁMOKHOZ

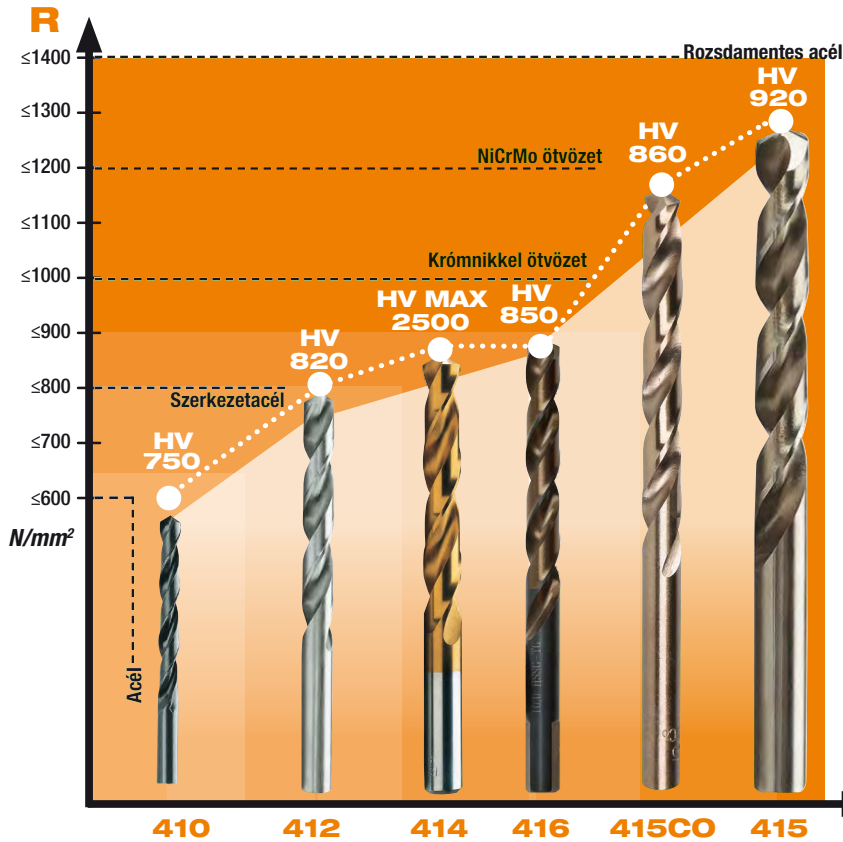

R N/mm² - A fűrés kivánt anyag mechanikai ellenállása.

HV - A csigafűrés Vickers skála szerinti keménysége: minél magasabb az érték, annál keményebb az anyag.

ÚTMUTATÓ: CSIGAFÚRÓ HENGERES SZÁRRAL

Hengerelt csigafűrés - Meleg hengereléssel előállított csigafűrés. Jó minőségű csiga- és csavarfűrés könnyű munkákhoz, általában például vas, lágyacél, könnyűfém ötvözetek és színesfémek fűrésására.

Köszörűlt csigafűrés - Teljes mértékben hőkezelt acélrud közzörülésével készült csigafűrés. Nagy teljesítményű csigafűrés acél és könnyűfém ötvözetek fűrésására: állandó hatékonyság, kiváló forgácseltávolítás és fűrésési pontosság.

HSS - Gyorsacél, rendkívül kemény és ellenáll a magas hőmérsékletnek; a leginkább megfelelő anyag szerszámok vágásához, csapolásához és menetvágásához.

Kobalt (Co) - Alapötvözet, amely javítja az acél hőállóságát, és például magas hőmérsékleten csökkenti a csigafűrés kopását. Minél magasabb a kobalttartalom, a szerszám annál jobb teljesítményt nyújt. A leggyakrabban használt ötvözetek kobalttartalma 5% vagy 8%.

HSS-Co - 5% vagy 8% kobalttartalmú gyorsacél.

TiN - Ultravékony titán-nitrid bevonat; nagy keménységének és alacsony súrlódási tényezőjének köszönhetően fokozottan ellenáll a kopásnak és az oxidációnak, valamint jobban eltávolítja a keletkező forgácsot.

Krómacél - A krómacélból készült szerszámok kézi használatra alkalmasak vas, könnyűfém ötvözetek, kezeletlen acél és alacsony keménységű hőkezelt acélok menetvágásához. Minden szakipari területen, de különösen az autópárházban széles körben használják sérült menetek tisztítására és javítására.

Keményfém - Nagy kopásállóságú anyag kőfűrés fejekhez.

118°-os élszög - A fémhez használt csigafűrés szokásos élszöge, amely lehetővé teszi a fémek gyors fűrésését, a könnyebb közepén tartást és a kiváló hőelvezetést.

130°-os élszög - Széles élszög, nagyobb pontosságot biztosít a kezdeti fűrés műveletek során, és kevesebb fűrésőrt igényel.

Kettős 115°/135°-os élszög - A két szög minden közös előnye, továbbá forgácsstörő funkció; a legjobb választás hosszú forgácsokat produkáló anyagokhoz.

SDS-Plus - Gyors, biztonságos befogórész ütvefűrészekhez.

410

Rövid csigafűrés, HSS hengerelt, barnított

R ≤ 650 N/mm²
HV ~ 750÷820



DIN 338 ISO 235

Ø mm	L mm	L1 mm	Ft	☞	☞
0,50	22	6	625	10	004100030
1,00	34	12	350	10	004100040
1,25	38	16	290	10	004100043
1,50	40	18	250	10	004100046
1,75	46	22	250	10	004100049
2,00	49	24	260	10	004100052
2,25	53	27	285	10	004100055
2,50	57	30	250	10	004100058
2,75	61	33	285	10	004100061
3,00	61	33	255	10	004100064
3,20	65	36	345	10	004100066
3,25	65	36	345	10	004100067
3,50	70	39	340	10	004100070
3,75	70	39	395	10	004100073
4,00	75	43	360	10	004100076
4,20	75	43	450	10	004100078
4,25	75	43	450	10	004100079
4,50	80	47	420	10	004100082
4,75	80	47	505	10	004100085
5,00	86	52	450	10	004100088
5,25	86	52	670	10	004100091
5,50	93	57	585	10	004100094
5,75	93	57	670	10	004100097
6,00	93	57	590	10	004100100
6,25	101	63	780	10	004100103
6,50	101	63	725	10	004100106
6,75	109	69	950	10	004100109
7,00	109	69	860	10	004100112
7,50	109	69	935	10	004100118
8,00	117	75	1.070	10	004100124
8,50	117	75	1.110	10	004100130
9,00	125	81	1.380	5	004100136
9,50	125	81	1.520	5	004100142
10,00	133	87	1.620	5	004100148
10,50	133	87	1.980	5	004100172
11,00	142	94	2.320	5	004100184
11,50	142	94	2.430	5	004100196
12,00	151	101	2.740	5	004100210
12,50	151	101	2.910	5	004100222
13,00	151	101	3.080	5	004100234
14,00	160	108	4.130	5	004100242
15,00	169	114	4.790	5	004100250
16,00	178	120	6.000	5	004100258
17,00	184	125	6.670	3	004100262
18,00	191	130	7.960	3	004100266
19,00	198	135	8.980	3	004100270
20,00	205	140	10.500	3	004100274



	Ft	☞	☞
410/SP19 Ø 1÷10 x 0,5 mm	17.800	1	004100419
410/SPVP1	9.780	1	004100421
410/SP25 Ø 1÷13 x 0,5 mm	37.700	1	004100425
410/SPVP2	13.550	1	004100427



410/SEL19 Ft 13.550 1 004100418
 Ø 1=10 x 0,5 mm

410MIX/SEL19

13 darab 410 típusú csigafúróból és 6 darab keményfémlapkás fúróból álló készlet műanyag dobozban



410MIX/SEL19 Ft 14.050 1 004100417



Ø 1 - 1,5 - 2 - 2,5 - 3 - 3,5 - 4
 4,5 - 5 - 5,5 - 6 - 8 - 10 mm

Ø 4 - 5 - 6 - 8 - 9 - 10 mm

410A

rövid nagyméretű csigafúró
 keskeny hengeres szárral,
 HSS, hengerelt
 R ≤ 650 N/mm²

HV ~ 750+820



DIN 338 ISO 235

Ø mm	L mm	L1 mm	Ft	📦	📄
13,50	160	108	4.990	5	004100281
14,00	160	108	4.990	5	004100283
14,50	169	114	5.760	5	004100285
15,00	169	114	5.760	5	004100287
15,50	178	120	7.060	5	004100289
16,00	178	120	7.060	5	004100291
16,50	184	125	7.500	3	004100292
17,00	184	125	7.500	3	004100293
17,50	191	130	8.950	3	004100294
18,00	191	130	8.950	3	004100295
18,50	198	135	9.830	3	004100296
19,00	198	135	9.830	3	004100297
19,50	205	140	11.450	3	004100298
20,00	205	140	11.450	3	004100299

410AS

rövid csigafúró hengeres szárral,
 HSS,
 hengerelt,
 inch-méretű
 R ≤ 650 N/mm²

HV ~ 750+820



ANSI B94

Ø "	L mm	L1 mm	Ft	📦	📄
1/16	48	22	210	10	004100371
5/64	51	25	255	10	004100372
3/32	57	32	270	10	004100373
7/64	67	38	325	10	004100374
1/8	70	41	365	10	004100375
9/64	73	44	390	10	004100376
5/32	79	51	420	10	004100377
11/64	83	54	485	10	004100378
3/16	89	59	530	10	004100379
13/64	92	62	555	10	004100380
7/32	95	64	620	10	004100381
15/64	98	67	695	10	004100382
1/4	102	70	775	10	004100383
17/64	105	73	955	10	004100384
9/32	108	75	1.050	10	004100385
19/64	111	78	1.150	10	004100386
5/16	114	81	1.390	10	004100387
21/64	117	84	1.500	10	004100388
11/32	121	87	1.730	5	004100389
23/64	124	89	1.770	5	004100390
3/8	127	92	1.870	5	004100391



410AS/SP21 Ft 26.450 1 004100429

Ø 1/16-5/64-3/32-7/64
 1/8-9/64-5/32-11/64-3/16
 13/64-7/32-15/64-1/4
 17/64-9/32-19/64-5/16
 21/64-11/32-23/64-3/8

410AS/SPV1 9.970 1 004100430



410AS/SEL21 Ft 21.350 1 004100433

Ø 1/16-5/64-3/32-7/64
 1/8-9/64-5/32-11/64-3/16
 13/64-7/32-15/64-1/4
 17/64-9/32-19/64-5/16
 21/64-11/32-23/64-3/8

412

Rövid csigafúró, HSS, köszörült,
 polírozott kivitel

R ≤ 800 N/mm²
 HV ~ 750+820



DIN 338 ISO 235

Ø mm	L mm	L1 mm	Ft	📦	📄
0,50	22	6	1.110	10	004120030
1,00	34	12	700	10	004120040
1,25	38	16	755	10	004120043
1,50	40	18	630	10	004120046
1,75	46	22	635	10	004120049
2,00	49	24	545	10	004120052
2,25	53	27	680	10	004120055
2,50	57	30	575	10	004120058
2,75	61	33	680	10	004120061
3,00	61	33	605	10	004120064
3,25	65	36	810	10	004120067
3,50	70	39	735	10	004120070
3,75	70	39	885	10	004120073
4,00	75	43	815	10	004120076
4,25	75	43	1.020	10	004120079
4,50	80	47	935	10	004120082
4,75	80	47	1.100	10	004120085
5,00	86	52	1.020	10	004120088
5,25	86	52	1.460	10	004120091
5,50	93	57	1.340	10	004120094
5,75	93	57	1.630	10	004120097
6,00	93	57	1.400	10	004120100
6,25	101	63	2.030	10	004120103
6,50	101	63	1.770	10	004120106
6,75	109	69	2.310	10	004120109
7,00	109	69	2.120	10	004120112
7,25	109	69	2.590	5	004120115
7,50	109	69	2.220	5	004120118
7,75	117	75	2.900	5	004120121
8,00	117	75	2.680	5	004120124
8,25	117	75	3.220	5	004120127
8,50	117	75	3.270	5	004120130
8,75	125	81	3.620	5	004120133
9,00	125	81	3.430	5	004120136
9,25	125	81	3.970	5	004120139
9,50	125	81	3.560	5	004120142
9,75	133	87	4.420	5	004120145
10,00	133	87	3.930	5	004120148
10,25	133	87	6.020	5	004120149
10,50	133	87	5.300	5	004120150
10,75	142	94	7.190	5	004120151
11,00	142	94	6.360	5	004120152
11,25	142	94	7.650	5	004120153
11,50	142	94	6.710	5	004120154
11,75	142	94	8.310	5	004120155
12,00	151	101	7.280	5	004120156
12,25	151	101	9.070	5	004120157
12,50	151	101	7.840	5	004120158
12,75	151	101	10.350	5	004120159
13,00	151	101	8.310	5	004120160



412/SP19 Ft 36.700 1 004120419
 Ø 1÷10 x 0,5 mm

410/SPVP1 9.780 1 004100421

412/SP25 75.600 1 004120425
 Ø 1÷13 x 0,5 mm

410/SPVP2 13.550 1 004100427

412/SP49 181.400 1 004120449
 Ø 1÷13 x 0,25 mm

412/SPV4 43.800 1 004120451



412/C150



412/C150 Ft 213.900 1 004120450

412	Ø 3 mm	n.
	Ø 1 - 1,5 - 2 - 2,5 - 3 - 3,5 - 4 - 4,5 - 5 mm	20
	Ø 5,5 - 6 - 6,5 - 7 - 7,5 - 8 - 8,5 - 9 - 9,5 - 10 mm	5

365x230x47 mm - 3,3 kg



412/SP91 Ft 236.900 1 004120452

Ø 1=10 x 0,10 mm

412A

rövid nagyméretű csigafúró
keskeny hengeres szárral,
HSS,
köszörült, barnított

R ≤ 800 N/mm²

HV ~ 750÷820



DIN 338 ISO 235

Ø mm	L mm	L1 mm	Ft	n.
13,50	160	108	12.700	3
14,00	160	108	13.200	3
14,50	169	114	14.200	3
15,00	169	114	14.900	3
15,50	178	120	16.900	3
16,00	178	120	17.650	3
16,50	184	125	18.400	1
17,00	184	125	19.500	1
17,50	191	130	21.000	1
18,00	191	130	22.100	1
18,50	198	135	23.750	1
19,00	198	135	24.500	1
19,50	205	140	27.750	1
20,00	205	140	28.150	1

412C

csigafúró hengeres szárral,
extra rövid, HSS,
köszörült, barnított

R ≤ 800 N/mm²

HV ~ 750÷820



DIN 1897 ISO 235

Ø mm	L mm	L1 mm	Ft	n.
3,00	46	16	650	10
3,25	49	18	690	10
3,50	52	20	735	10
4,00	55	22	775	10
4,50	58	24	885	10
5,00	62	26	930	10
5,50	66	28	1.240	10
6,00	66	28	1.350	10
6,5	70	31	1.610	10
7,00	74	34	1.880	10
7,5	74	34	2.010	5
8,00	79	37	2.380	5

412L

Hosszú csigafúró, HSS,
köszörült, barnított

R ≤ 800 N/mm²

HV ~ 750÷820



DIN 340

Ø mm	L mm	L1 mm	Ft	n.
2,00	85	56	1.400	10
2,50	95	62	1.510	10
3,00	100	66	1.590	10
3,50	112	73	1.850	10
4,00	119	78	1.980	10
4,50	126	82	2.360	10
5,00	132	87	2.450	10
5,50	139	91	3.160	10
6,00	139	91	3.400	10
6,50	148	97	3.990	5
7,00	156	102	4.670	5
8,00	165	109	6.230	5
9,00	175	115	7.340	5
10,00	184	121	8.140	5

412XL

csigafúró hengeres szárral,
extra hosszú, HSS,
köszörült

R ≤ 800 N/mm²

HV ~ 750÷820



DIN 1869/1

Ø mm	L mm	L1 mm	Ft	n.
3,00	150	100	5.380	1
3,50	165	115	5.830	1
4,00	175	120	5.830	1
4,50	185	125	6.120	1
5,00	195	135	6.120	1
5,50	205	140	7.680	1
6,00	205	140	7.680	1

Ø mm	L mm	L1 mm	Ft	n.
6,50	215	150	9.200	1
7,00	225	155	10.750	1
7,50	225	155	12.000	1
8,00	240	165	13.100	1
8,50	240	165	13.850	1
9,00	250	175	17.300	1
9,50	250	175	18.750	1
10,00	265	185	18.750	1
10,50	265	185	18.750	1
11,00	280	195	18.750	1
12,00	295	205	23.800	1
13,00	295	205	25.250	1

414

Rövid csigafúró, HSS-TiN,
köszörült

R ≤ 900 N/mm²

HV 0,05 ~ 2500



DIN 338 ISO 235

Ø mm	L mm	L1 mm	Ft	n.
1,00	34	12	935	10
1,25	38	16	1.120	10
1,50	40	18	865	10
1,75	46	22	1.120	10
2,00	49	24	870	10
2,25	53	27	1.110	10
2,50	57	30	935	10
2,75	61	33	1.310	10
3,00	61	33	1.060	10
3,25	65	36	1.370	10
3,50	70	39	1.210	10
3,75	70	39	1.390	10
4,00	75	43	1.280	10
4,25	75	43	1.630	10
4,50	80	47	1.360	10
4,75	80	47	1.810	10
5,00	86	52	1.660	10
5,25	86	52	2.360	10
5,50	93	57	2.000	10
5,75	93	57	2.420	10
6,00	93	57	2.180	10
6,25	101	63	2.910	10
6,50	101	63	2.430	10
6,75	109	69	3.490	10
7,00	109	69	2.790	10
7,25	109	69	3.770	5
7,50	109	69	3.360	5
7,75	117	75	4.380	5
8,00	117	75	3.830	5
8,25	117	75	4.590	5
8,50	117	75	3.980	5
8,75	125	81	5.680	5
9,00	125	81	4.970	5
9,25	125	81	6.420	5
9,50	125	81	5.480	5
9,75	133	87	6.820	5
10,00	133	87	5.940	5
10,50	133	87	6.930	5
11,00	142	94	7.750	5
11,50	142	94	8.340	5
12,00	151	101	8.960	5
12,50	151	101	10.450	5
13,00	151	101	10.850	5





	Ft		
414/SP19 Ø 1÷10 x 0,5 mm	52.200	1	004140419
410/SPVP1	9.780	1	004100421
414/SP25 Ø 1÷13 x 0,5 mm	106.500	1	004140425
410/SPVP2	13.550	1	004100427
414/SP49 Ø 1÷13 x 0,25 mm	230.000	1	004140429
414/SPV4	43.800	1	004140430

414/C116



	Ft		
414/C116	205.900	1	004140450

414	Ø 1 - 1,5 - 2 - 2,5 - 3 - 3,5 - 4 - 4,5 - 5 mm	n.
	Ø 5,5 - 6 - 6,5 - 7 - 7,5 - 8 mm	3
	Ø 8,5 - 9 - 9,5 - 10 mm	2

365x230x47 mm - 2,7 Kg

415

Rövid csigafúró, HSS-CO 8%,
köszörült

R ≤ 1400 N/mm²
HV ~ 850+920

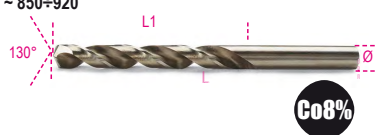

DIN 338 ISO 235

Ø mm	L mm	L1 mm	Ft		
0,50	22	6	2.600	10	004150029
1,00	34	12	1.290	10	004150040
1,25	38	16	1.430	10	004150043
1,50	40	18	1.300	10	004150046
1,75	46	22	1.380	10	004150049
2,00	49	24	1.260	10	004150052
2,25	53	27	1.490	10	004150055
2,50	57	30	1.390	10	004150058
2,75	61	33	1.490	10	004150061
3,00	61	33	1.390	10	004150064
3,25	65	36	1.960	10	004150067
3,50	70	39	1.760	10	004150070
3,75	70	39	2.230	10	004150073
4,00	75	43	1.960	10	004150076
4,25	75	43	2.480	10	004150079
4,50	80	47	2.280	10	004150082
4,75	80	47	2.590	10	004150085
5,00	86	52	2.380	10	004150088

Ø mm	L mm	L1 mm	Ft		
5,25	86	52	3.400	10	004150091
5,50	93	57	3.150	10	004150094
5,75	93	57	3.600	10	004150097
6,00	93	57	3.280	10	004150100
6,25	101	63	4.620	10	004150103
6,50	101	63	4.030	10	004150106
6,75	109	69	5.440	10	004150109
7,00	109	69	4.790	10	004150112
7,25	109	69	5.830	5	004150115
7,50	109	69	5.270	5	004150118
7,75	117	75	6.660	5	004150121
8,00	117	75	6.070	5	004150124
8,25	117	75	7.460	5	004150127
8,50	117	75	6.860	5	004150130
8,75	125	81	9.160	5	004150133
9,00	125	81	8.140	5	004150136
9,25	125	81	9.440	5	004150139
9,50	125	81	8.750	5	004150142
9,75	133	87	10.450	5	004150145
10,00	133	87	9.320	5	004150148
10,25	133	87	12.500	5	004150149
10,50	133	87	10.400	5	004150150
10,75	142	94	13.850	5	004150151
11,00	142	94	12.150	5	004150152
11,25	142	94	15.400	5	004150153
11,50	142	94	13.800	5	004150154
11,75	142	94	15.900	5	004150155
12,00	151	101	14.450	5	004150156
12,25	151	101	18.450	5	004150157
12,50	151	101	15.650	5	004150158
12,75	151	101	20.700	5	004150159
13,00	151	101	17.200	5	004150160
14,00	160	108	30.150	3	004150164
15,00	169	114	35.900	3	004150168
16,00	178	120	44.050	3	004150172
17,00	186	125	49.650	1	004150174
18,00	194	130	55.150	1	004150176
19,00	202	135	63.800	1	004150178
20,00	210	140	71.250	1	004150180



Co8%

	Ft		
415/SP19 Ø 1÷10 x 0,5 mm	74.300	1	004150419
410/SPVP1	9.780	1	004100421
415/SP25 Ø 1÷13 x 0,5 mm	154.000	1	004150425
410/SPVP2	13.550	1	004100427
415/SP49 Ø 1÷13 x 0,25 mm	381.900	1	004150431
415/SPV4	43.800	1	004150432

415/C116



	Ft		
415/C116	309.700	1	004150450

415	Ø 1 - 1,5 - 2 - 2,5 - 3 - 3,5 - 4 - 4,5 - 5 mm	n.
	Ø 5,5 - 6 - 6,5 - 7 - 7,5 - 8 mm	3
	Ø 8,5 - 9 - 9,5 - 10 mm	2

365x230x47 mm - 2,7 kg



	Ft		
415/SP91 Ø 1÷10 x 0,10 mm	443.900	1	004150460

415CO

csigafúró hengeres szárral,
rövid, HSS-CO 5%,
köszörült

R ≤ 1200 N/mm²

HV ~ 800+860



DIN 338 ISO 235

Ø mm	L mm	L1 mm	Ft		
1,00	34	12	650	10	004150310
1,50	40	18	650	10	004150312
2,00	49	24	650	10	004150314
2,50	57	30	690	10	004150316
3,00	61	33	690	10	004150320
3,50	70	39	815	10	004150322
4,00	75	43	960	10	004150324
4,50	80	47	1.090	10	004150326
5,00	86	52	1.150	10	004150328
5,50	93	57	1.450	10	004150330
6,00	93	57	1.620	10	004150332
6,50	101	63	1.920	10	004150334
7,00	109	69	2.380	10	004150336
7,50	109	69	2.620	5	004150338
8,00	117	75	3.050	5	004150340
8,50	117	75	3.230	5	004150342
9,00	125	81	3.950	5	004150344
9,50	125	81	4.140	5	004150346
10,00	133	87	4.850	5	004150348
10,50	133	87	5.760	5	004150350
11,00	142	94	6.440	5	004150352
11,50	142	94	7.060	5	004150354
12,00	151	101	7.700	5	004150356
12,50	151	101	8.450	5	004150358
13,00	151	101	9.170	5	004150360

415CO-A

csigafúró hengeres szárral,
rövid, HSS-CO 5%,
köszörült

R ≤ 1200 N/mm²

HV ~ 800+860



DIN 338

Ø mm	L mm	L1 mm	Ft		
14,00	160	108	17.950	3	004150364
15,00	169	114	20.850	3	004150366
16,00	178	120	25.100	3	004150368
17,00	184	125	25.600	1	004150370
18,00	191	130	32.900	1	004150372
19,00	198	135	37.850	1	004150374
20,00	205	140	43.700	1	004150376



Co5%

DIN 338

415CO/SP19	Ft 36.800	10	004150421
Ø 1÷10 x 0,5 mm			
410/SPVP1	Ft 9.780	1	004100421

415C

csigafúró hengeres szárral,
extra rövid, HSS-CO 5%,
köszörült

R ≤ 1200 N/mm²

HV ~ 800÷860



Co5%

DIN 1897 ISO 235

Ø mm	L mm	L1 mm	Ft	10	004150288
3,00	46	16	885	10	004150288
3,25	49	18	1.150	10	004150289
3,50	52	20	1.150	10	004150290
4,00	55	22	1.270	10	004150292
4,50	58	24	1.450	10	004150294
5,00	62	26	1.550	10	004150296
5,50	66	28	2.060	10	004150298
6,00	66	28	2.200	10	004150300
6,50	70	31	2.270	10	004150301
7,00	74	34	2.730	10	004150302
7,50	74	34	3.150	5	004150303
8,00	79	37	3.870	5	004150304

415L

csigafúró hengeres szárral,
hosszú, HSS-CO 5%,
köszörült

R ≤ 1200 N/mm²

HV ~ 800÷860



Co5%

DIN 340

Ø mm	L mm	L1 mm	Ft	10 <th>004150236</th>	004150236
3,00	100	66	1.740	10	004150236
3,50	112	73	1.930	10	004150238
4,00	119	78	2.390	10	004150240
4,50	126	82	2.900	10	004150242
5,00	132	87	3.020	10	004150244
5,50	139	91	3.800	10	004150246
6,00	139	91	4.140	10	004150248
6,50	148	97	4.900	5	004150250
7,00	156	102	5.760	5	004150252
8,00	165	109	7.360	5	004150256
9,00	175	115	9.140	5	004150260
10,00	184	121	11.850	5	004150264

416

Csigafúrókészlet különleges csiszolással
dupla kúpos fejél

R ≤ 900 N/mm²
HV ~ 820÷850



MAGASABB
VÁGÓSEBESSÉG



DIN 338

Ø mm	L mm	L1 mm	Ft	10 <th>004160010</th>	004160010
1,00	34	12	1.010	10	004160010
1,50	40	18	1.010	10	004160015
2,00	49	24	1.010	10	004160020
2,50	57	30	1.010	10	004160025
3,00	61	33	1.100	10	004160030
3,50	70	39	1.250	10	004160035
4,00	75	43	1.380	10	004160040
4,50	80	47	1.550	10	004160045
5,00	86	52	1.740	10	004160050
5,50	93	57	2.270	10	004160055
6,00	93	57	2.450	10	004160060
6,50	101	63	2.880	10	004160065
7,00	109	69	3.380	10	004160070
7,50	109	69	3.630	5	004160075
8,00	117	75	4.290	5	004160080
8,50	117	75	4.670	5	004160085
9,00	125	81	5.510	5	004160090
9,50	125	81	5.820	5	004160095
10,00	133	87	6.650	5	004160100

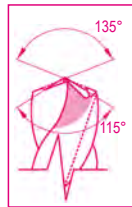

Ft 51.100

416/SP19	Ft 51.100	10	004160419
Ø 1÷10 x 0,5 mm			
410/SPVP1	Ft 9.780	1	004100421

417

Rövid vídiás fúró, lágyacélból
készült szár, keményfém vágóélel



DIN 8039

Ø mm	L mm	Ft	10 <th>004170003</th>	004170003
3	70	1.380	10	004170003
4	75	1.400	10	004170004
5	85	1.460	10	004170005
5L	150	3.270	5	004170105
6	100	1.490	10	004170007
6L	150	3.270	5	004170106
7	120	1.680	10	004170009
8	120	1.880	10	004170010
8L	200	3.510	5	004170113
9	120	2.120	10	004170011
10	120	2.500	10	004170012
10L	200	4.220	5	004170120
12	150	3.270	10	004170014
12L	200	4.660	5	004170125
14	150	4.510	5	004170016
16	150	5.560	5	004170018



417/SP8	Ft 20.850	10	004170100
Ø 3-4-5-6-8-9-10-12 mm			

419

ütvefúró fúrószár,
marással kialakítva,
keményfém vágóélel
HVA~ 1650

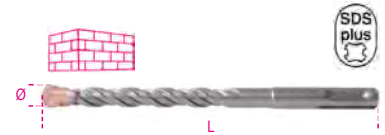

SDS plus

DIN 8039

Ø mm	L mm	Ft	10 <th>004190002</th>	004190002
4	110	2.870	10	004190002
5	110	2.900	10	004190004
5	160	3.150	10	004190006
6	110	2.870	10	004190012
6	160	3.050	10	004190014
6	210	4.150	10	004190016
7	160	3.380	10	004190028
8	110	3.040	10	004190030
8	160	3.250	10	004190032
8	210	3.920	10	004190034
8	260	5.390	10	004190036
8	310	6.190	10	004190038
8	460	12.000	10	004190042
9	160	4.010	5	004190044
10	160	4.000	5	004190050
10	210	4.740	5	004190052
10	260	5.910	5	004190054
10	310	8.450	5	004190056
10	460	12.950	5	004190060
12	160	4.630	5	004190064
12	210	6.050	5	004190066
12	260	6.520	5	004190068
12	460	13.350	5	004190074
14	160	6.370	3	004190086
14	260	7.550	3	004190090
14	310	10.900	3	004190092
14	460	13.850	3	004190096
16	210	9.180	3	004190112
16	250	9.690	3	004190114
16	300	11.750	3	004190116
16	450	15.900	3	004190120
18	250	12.900	1	004190124
20	310	13.150	1	004190128



419T

ütvefűró fűrószár,
marással kialakítva, 4 spirális horonnyal és 4
vágóéllel
HVA~ 1650

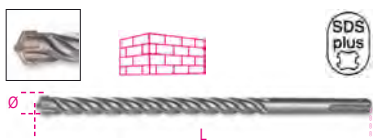

Ø mm	L mm	Ft		
5	110	1.860	5	004190604
5	160	2.100	5	004190606
6	110	1.940	5	004190612
6	160	2.270	5	004190614
6	210	3.050	5	004190616
7	160	2.310	5	004190628
8	110	2.100	5	004190630
8	160	2.410	5	004190632
8	210	3.190	5	004190634
8	260	3.640	5	004190636
8	310	4.380	5	004190638
9	160	2.540	3	004190644
10	160	2.590	3	004190650
10	210	3.400	3	004190652
10	260	3.670	3	004190654
10	310	5.280	3	004190656
10	460	7.150	3	004190660
12	160	2.850	3	004190664
12	210	3.760	3	004190666
12	260	3.990	3	004190668
12	460	7.360	3	004190674
14	160	3.870	2	004190686
14	260	4.470	2	004190690
14	310	6.410	2	004190692
14	460	7.150	2	004190696
16	210	5.240	2	004190712
16	260	6.790	2	004190714
16	310	7.360	2	004190716
16	460	7.610	2	004190720
18	260	8.300	1	004190724
20	310	10.100	1	004190728

420A

HSS sülylesztő maró 90°,
átmenő csavarokhoz,
független spirálokkal

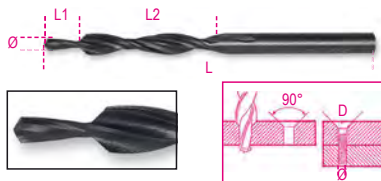

DIN 8374

M	Ø mm	D mm	L1 mm	L2 mm	L mm	Ft		
3	3,2	6	9,00	57,00	93,00	19.300	1	004200003
4	4,3	8	11,00	75,00	117,00	22.400	1	004200004
5	5,3	10	13,00	87,00	133,00	28.200	1	004200005
6	6,4	11,5	15,00	94,00	142,00	32.550	1	004200006
8	8,4	15	19,00	114,00	169,00	54.950	1	004200008
10	10,5	19	23,00	135,00	198,00	84.850	1	004200010

420B

HSS sülylesztő maró 180°,
átmenő csavarokhoz,
független spirálokkal



DIN 8376

M	Ø mm	D mm	L1 mm	L2 mm	L mm	Ft		
3	3,4	6	9,00	57,00	93,00	16.950	1	004200053
4	4,5	8	11,00	75,00	117,00	19.150	1	004200054
5	5,5	10	13,00	87,00	133,00	23.400	1	004200055
6	6,6	11	15,00	94,00	142,00	27.550	1	004200056
8	9	15	19,00	114,00	169,00	34.550	1	004200058
10	11	18	23,00	130,00	191,00	51.850	1	004200060

421

vezetőcsapos kúpos tágitó
finom fokozat
HSS acélból

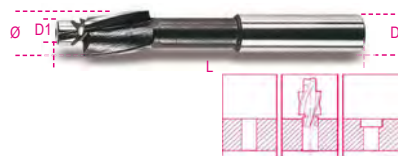

DIN 373

M	L mm	Ø mm	D1 mm	D mm	Ft		
3	71	6	3,2	5	10.850	1	004210003
4	71	8	4,3	5	10.850	1	004210004
5	80	10	5,3	8	10.850	1	004210005
6	80	11	6,4	8	11.050	1	004210006
8	100	15	8,4	12,5	17.750	1	004210008
10	100	18	10,5	12,5	21.300	1	004210010
12	100	20	13,0	12,5	23.200	1	004210012



	Ft		
421/SP6 M 3-4-5-6-8-10	88.600	1	004210019
421/SPV	6.860	1	004210020

422

rektifikált központosító fűróhegyek
tágitási szög 60°
HSS acélból

• A központosító furatok gyors és biztonságos kialakításához



DIN 333/A

Ø mm	D mm	L mm	Ft		
1,60	4,0	35,5	2.920	1	004220116
2,50	6,3	45,0	3.300	1	004220125
3,15	8,0	50,0	3.850	1	004220131

423

Ponthegeztés lefűró,
HSS, köszőrűlt



Ø mm	L mm	Ft		
6	66	6.630	5	004230006
7	74	8.240	5	004230007
8	79	8.930	5	004230008
10	89	10.350	5	004230010

423A

Rövid ponthegeztés lefűró,
HSS, köszőrűlt



DIN 1412/E

Ø mm	L mm	Ft		
6,5	40	9.590	1	004230015
8,0	40	10.350	1	004230020

424

Kúpos lemezfűró, HSS

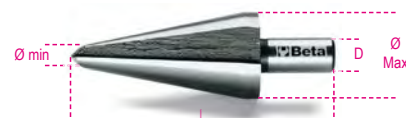

	L mm	Ø mm	D mm	Ft		
424/1	58	3÷14	6	11.750	2	004240001
424/2	63	6÷20	8	20.150	2	004240002
424/3	60	16÷30	10	34.000	2	004240003
424/4	80	3÷22	8	40.800	1	004240004
424/5	102	3÷31	10	55.150	1	004240005
424/6	86	26÷40	13	71.250	1	004240006
424/7	89	36÷50	13	107.100	1	004240007
424/8	90	40÷61	13	177.800	1	004240008



	Ft		
424/SP3 424/1+424/2+424/3 Ø 3÷30 mm	68.800	1	004240019
424/SPV	9.600	1	004240020

425

Lépcsős lemezfúró, HSS

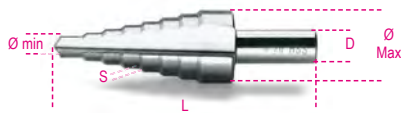

L	Ø	S	D	Ft		
mm	mm	mm	mm			
425/1	70	4+12	1 6	19.750	2	004250010
425/2	55	4+12	2 6	20.900	2	004250012
425/3	85	4+20	2 10	29.650	2	004250015
425/4	85	12+20	1 10	39.450	1	004250016
425/5	97	20+30	1 10	93.150	1	004250017
425/6	75	4+30	2 10	65.200	1	004250020
425/7	97	30+40	1 13	127.200	1	004250025
425/8	100	40+50	1 13	181.900	1	004250029



	Ft		
425/SP3	116.900	1	004250030
425/1+425/3+425/6			
Ø 4×30 mm			
425/SPV	9.600	1	004250035

426

süllyesztő maró
három vágóéllel,
HSS



DIN 335-C

GR	Ø	L	Ø1	Ft		
	mm	mm	mm			
1	4,3	44	4	6.620	3	004260001
2	5,3	44	4	6.620	3	004260002
3	6,3	44	5	6.960	3	004260003
4	7,3	44	6	8.140	3	004260004
5	8,3	50	6	8.140	3	004260005
6	9,4	50	6	9.390	3	004260006
7	10,4	54	6	10.150	3	004260007
8	12,4	54	8	11.000	3	004260008
9	15,0	56	10	12.450	3	004260009
10	16,5	60	10	13.150	3	004260010
11	20,5	63	10	18.400	3	004260011
12	25,0	66	10	28.950	3	004260012
13	28,0	71	12	38.700	3	004260013
14	31,0	71	12	40.850	3	004260014



DIN 335-C

	Ft		
426/SP6	72.550	1	004260030
GR 3-5-7-8-10-11			
Ø 6,3×20,5 mm			
426/SPV	9.600	1	004260035

426T

süllyesztő maró
három vágóéllel,
HSS + TiN

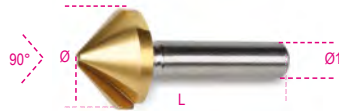

DIN 335-C

GR	Ø	L	Ø1	Ft		
	mm	mm	mm			
1	4,3	44	4	8.340	3	004260061
2	5,3	44	4	8.340	3	004260062
3	6,3	44	5	8.570	3	004260063
4	7,3	44	6	9.730	3	004260064
5	8,3	50	6	9.730	3	004260065
6	9,4	50	6	10.400	3	004260066
7	10,4	54	6	11.900	3	004260067
8	12,4	54	8	12.550	3	004260068
9	15,0	56	10	14.150	3	004260069
10	16,5	60	10	15.800	3	004260070
11	20,5	63	10	20.550	3	004260071
12	25,0	66	10	30.950	3	004260072
13	28,0	71	12	39.000	3	004260073
14	31,0	71	12	41.450	3	004260074



DIN 335-C

	Ft		
426T/SP6	78.750	1	004260080
GR 3-5-7-8-10-11			
Ø 6,3×20,5 mm			
426/SPV	9.600	1	004260035

426SB

Süllyesztő maró, HSS



GR	Ø	D	L	Ft		
	mm	mm	mm			
426/SB1	1	2+5	6 45	9.130	1	004260101
426/SB2	2	5+10	8 48	11.150	1	004260102
426/SB3	3	10+15	10 65	20.550	1	004260103
426/SB4	4	15+20	12 85	38.750	1	004260104
426/SB5	5	20+25	15 102	65.950	1	004260105
426/SB6	6	25+30	15 115	109.000	1	004260106



Beta



	Ft		
426SB/SP4	91.000	1	004260130
426/SB1-426/SB2			
426/SB3-426/SB4			
Ø 2×20 mm			
426SB/SPV1	9.600	1	004260135

426MD-3/CP3

mini forgómaró, keményfém

• Lágy típusú keresztvágás forgácszörrel



L	Ø	Ft		
mm	mm			
38,1	3	4.640	1	004260332

426MD-3/CT3

mini forgómaró, keményfém

• Lágy típusú keresztvágás forgácszörrel



L	Ø	Ft		
mm	mm			
37,8	3	4.640	1	004260333

426MD-3/F3

mini forgómaró, keményfém

• Lágy típusú keresztvágás forgácszörrel

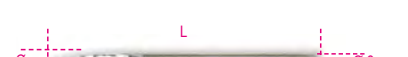

L	Ø	Ft		
mm	mm			
38,3	3	4.640	1	004260334

426MD-3/FA3

mini forgómaró, keményfém

• Lágy típusú keresztvágás forgácszörrel



L	Ø	Ft		
mm	mm			
38,2	3	4.640	1	004260339

426MD-3/OG3

mini forgómaró, keményfém

• Lágy típusú keresztvágás forgácszörrel



L	Ø	Ft		
mm	mm			
38,1	3	4.640	1	004260337

426MD-3/OV3

mini forgómaró, keményfém

• Lágú típusú keresztvágás forgácstörővel



L mm	Ø mm	Ft		
38,2	3	4.640	1	004260331

426MD-3/S3

mini forgómaró, keményfém

• Lágú típusú keresztvágás forgácstörővel



L mm	Ø mm	Ft		
38,0	3	4.640	1	004260338

426MD-3/T3

mini forgómaró, keményfém

• Lágú típusú keresztvágás forgácstörővel



L mm	Ø mm	Ft		
38,3	3	4.640	1	004260336

426MD-3/TA3

mini forgómaró, keményfém

• Lágú típusú keresztvágás forgácstörővel



L mm	Ø mm	Ft		
38,3	3	4.640	1	004260335



426MD-3/A9

Ft 41.750 1 004260349

426MD-3/OV3 - 426MD-3/CP3
 426MD-3/CT3 - 426MD-3/F3
 426MD-3/TA3 - 426MD-3/T3
 426MD-3/OG3 - 426MD-3/S3
 426MD-3/FA3

426MD/CP

Sülyesztő maró, keményfém

HM6



L mm	Ø mm	Ft		
50	6	12.500	1	004260532
63	8	15.750	1	004260512
63	9,5	16.400	1	004260542
69	12	24.650	1	004260522
69	16	35.850	1	004260552

426MD/CT

Sülyesztő maró, keményfém

HM6



L mm	Ø mm	Ft		
50	6	12.500	1	004260533
63	8	15.750	1	004260513
63	9,5	16.400	1	004260543
69	12	24.650	1	004260523
69	16	35.650	1	004260553

426MD/F

Sülyesztő maró, keményfém

HM6



L mm	Ø mm	Ft		
50	6	12.500	1	004260534
63	8	15.750	1	004260514
63	9,5	16.400	1	004260544
69	12	24.650	1	004260524
69	16	26.950	1	004260554

426MD/FA

Sülyesztő maró, keményfém

HM6



L mm	Ø mm	Ft		
50	6	12.500	1	004260539
63	8	15.750	1	004260519
63	9,5	16.400	1	004260549
69	12	24.650	1	004260529
69	16	31.550	1	004260559

426MD/OG

Sülyesztő maró, keményfém

HM6



L mm	Ø mm	Ft		
50	6	12.500	1	004260537
63	8	15.750	1	004260517
70	10	16.400	1	004260547
76	12	24.650	1	004260527
81	16	36.650	1	004260557

426MD/OV

Sülyesztő maró, keményfém

HM6



L mm	Ø mm	Ft		
50	6	12.500	1	004260531
61	9,5	16.400	1	004260541
67	12	24.650	1	004260521
69	16	31.550	1	004260551

426MD/S

Sülyesztő maró, keményfém

HM6



L mm	Ø mm	Ft		
50	6	12.500	1	004260538
51	8	15.750	1	004260518
53	9,5	16.400	1	004260548
56	12	24.650	1	004260528
59	16	26.950	1	004260558

426MD/T

Sülyesztő maró, keményfém

HM6

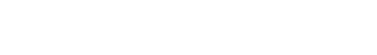

L mm	Ø mm	Ft		
50	6	12.500	1	004260536
63	8	15.750	1	004260516
63	9,5	16.400	1	004260546
69	12	24.650	1	004260526
70	16	26.950	1	004260556

426MD/TA

Sülyesztő maró, keményfém

HM6



L mm	Ø mm	Ft		
50	6	12.500	1	004260535
67	8	15.750	1	004260515
72	9,5	16.400	1	004260545
73	12	24.650	1	004260525
78	16	35.850	1	004260555



	Ft		
426MD/SP10	115.500	1	004260510
426MD/CP-426MD/CT-426MD/F			
426MD/T-426MD/S			
Ø 8-12 mm			

427

Morse-kúpos kiütő, nemesített acélból készült, horganyzott



DIN 317

GR	L mm	A mm	Ft	☒	☒
0	92	13	5.050	3	004270000
1-2	140	19	7.210	3	004270002
3	190	25	8.210	3	004270003
4	225	30	14.600	3	004270004
5-6	260	35	25.350	3	004270006

428FP

Egyenes hornyú gépi menetfúró, HSS



ISO 529

M	■ mm	L mm	L1 mm	Ft	☒	☒
3x0,5	2,7	56	11	6.820	10	004280003
4x0,7	3,4	63	13	6.820	10	004280004
5x0,8	4,9	70	16	6.820	10	004280005
6x1	4,9	80	19	7.270	10	004280006
8x1,25	6,2	90	22	8.540	10	004280008
10x1,5	8,0	100	24	10.100	10	004280010
12x1,75	7,0	110	29	13.200	5	004280012
14x2	9,0	110	30	16.450	5	004280014
16x2	9,0	110	30	19.800	5	004280016
18x2,5	11,0	125	34	25.650	3	004280018
20x2,5	12,0	140	34	28.650	3	004280020
22x2,5	14,5	140	34	33.850	3	004280022
24x3	14,5	160	38	37.750	3	004280024

428FC

Csavart hornyú gépi menetfúró, HSS



ISO 529

M	■ mm	L mm	L1 mm	Ft	☒	☒
3x0,5	2,7	56	11	7.970	10	004280103
4x0,7	3,4	63	13	7.970	10	004280104
5x0,8	4,9	70	16	7.970	10	004280105
6x1	4,9	80	19	8.310	10	004280106
8x1,25	6,2	90	22	9.060	10	004280108
10x1,5	8,0	100	24	10.850	10	004280110
12x1,75	7,0	110	29	13.900	5	004280112
14x2	9,0	110	30	18.300	5	004280114
16x2	9,0	110	30	21.550	5	004280116
18x2,5	11,0	125	34	29.200	3	004280118
20x2,5	12,0	140	34	30.800	3	004280120
22x2,5	14,5	140	34	37.750	3	004280122
24x3	14,5	160	38	40.450	3	004280124

428/C14

14 részes gépi menetfúró készlet, fémdobozban



428/C14	Ft	☒	☒
428FP M3÷12	149.200	1	004280201
428FC M3÷12	7.810	1	004280202

429FP

Egyenes hornyú gépi menetfúró, HSS-CO 5%



ISO 529

M	■ mm	L mm	L1 mm	Ft	☒	☒
3x0,5	2,7	56	11	8.830	5	004290003
4x0,7	3,4	63	13	8.830	5	004290004
5x0,8	4,9	70	16	8.830	5	004290005
6x1	4,9	80	19	9.480	5	004290006
8x1,25	6,2	90	22	10.600	5	004290008
10x1,5	8,0	100	24	12.450	5	004290010
12x1,75	7,0	110	29	15.750	5	004290012
14x2	9,0	110	30	20.850	5	004290014

429FC

Csavart hornyú gépi menetfúró, HSS-CO 5%



ISO 529

M	■ mm	L mm	L1 mm	Ft	☒	☒
3x0,5	2,7	56	11	10.850	5	004290103
4x0,7	3,4	63	13	10.850	5	004290104
5x0,8	4,9	70	16	10.850	5	004290105
6x1	4,9	80	19	11.300	5	004290106
8x1,25	6,2	90	22	12.650	5	004290108
10x1,5	8,0	100	24	15.750	5	004290110
12x1,75	7,0	110	29	18.850	5	004290112
14x2	9,0	110	30	24.450	5	004290114

429/C14

14 részes gépi menetfúró készlet, fémdobozban



429/C14	Ft	☒	☒
429FP M3÷12	146.700	1	004290201
429FC M3÷12	7.810	1	004280202

430

Kézi menetfúró, metrikus normál menet, króm-acélból



DIN 352 UNI 4535

M	■ mm	L mm	L1 mm	Ft	☒	☒
2x0,4	2,5	36	11	5.650	5	004300002
3x0,5	2,5	40	12	4.010	5	004300003
4x0,7	3,0	45	14	4.010	5	004300004
5x0,8	4,0	48	16	4.160	5	004300005
6x1	5,0	50	18	4.150	5	004300006
7x1	4,5	50	18	5.490	5	004300007
8x1,25	5,0	56	22	5.450	3	004300008
9x1,25	5,5	63	22	7.240	3	004300009
10x1,5	6,0	70	25	7.010	3	004300010
11x1,5	7,0	70	25	9.130	3	004300011
12x1,75	7,0	75	30	8.770	3	004300012
14x2	8,0	80	32	11.400	3	004300014
16x2	10,0	80	32	13.600	3	004300016
18x2,5	11,0	95	40	18.400	1	004300018
20x2,5	12,0	95	40	21.550	1	004300020
22x2,5	14,5	100	40	26.250	1	004300022
24x3	14,5	110	50	30.000	1	004300024



430/SP21	Ft	☒	☒
M 3-4-5-6-8-10-12	49.850	1	004300201
430/SPV	10.900	1	004300202

430ASW

Kézi menetfúró, Whitworth menet, króm-acélból DIN 352



DIN 352

BSW	mm	L	L1	Ft		
1/8x40	2,7	40	12	3.950	5	004300031
5/32x32	3,4	45	14	3.950	5	004300032
3/16x24	4,3	48	18	3.990	5	004300033
1/4x20	4,9	50	22	4.540	5	004300034
5/16x18	4,9	56	25	5.530	3	004300035
3/8x16	5,5	70	28	7.370	3	004300036
7/16x14	6,2	70	30	8.380	3	004300037
1/2x12	7,0	75	32	9.180	3	004300038
9/16x12	9,0	80	32	11.550	1	004300039
5/8x11	9,0	80	38	14.200	1	004300040
3/4x10	11,0	95	40	19.950	1	004300041
7/8x9	14,5	100	40	25.250	1	004300042
1"x8	16,0	110	50	32.700	1	004300043

430ASC

Kézi menetfúró, UNC menet, króm-acélból

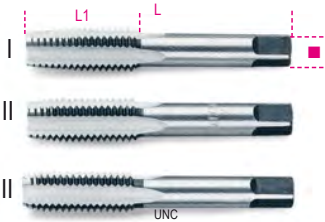

ANSI B1.1

UNC	mm	L	L1	Ft		
1/4x20	4,9	70	30	5.850	5	004300051
5/16x18	4,9	70	30	7.820	5	004300052
3/8x16	5,5	75	35	8.730	3	004300053
7/16x14	6,2	80	40	10.800	3	004300054
1/2x13	7,0	85	45	14.550	3	004300055
9/16x12	9,0	90	45	16.600	3	004300056
5/8x11	9,0	100	47	19.750	3	004300057
3/4x10	11,0	110	50	26.950	3	004300058
7/8x9	14,5	120	60	31.000	1	004300059
1"x8	16,0	130	60	34.450	1	004300060

431

Kézi menetfúró, metrikus normál menet, HSS



DIN 352 UNI 4535

M	mm	L	L1	Ft		
3x0,5	2,5	40	12	7.950	5	004310003
4x0,7	3,0	45	14	7.950	5	004310004
5x0,8	4,0	48	16	8.240	5	004310005
6x1	5,0	50	18	8.240	5	004310006

M	mm	L	L1	Ft		
7x1	5,0	50	18	11.050	5	004310007
8x1,25	5,0	56	22	9.750	3	004310008
10x1,5	6,0	70	25	12.000	3	004310010
12x1,75	7,0	75	30	17.600	3	004310012
14x2	9,0	80	32	24.200	1	004310014
16x2	9,0	80	32	28.050	1	004310016
18x2,5	11,0	95	40	41.250	1	004310018
20x2,5	12,0	95	40	44.500	1	004310020
22x2,5	12,0	100	40	62.900	1	004310022
24x3	14,5	110	50	70.400	1	004310024



431/SP21	Ft		
M 3-4-5-6-8-10-12	75.450	1	004310201
431/SPV	10.900	1	004310202

433

Kézi menetfúró, metrikus finom menet, króm-acélból készült



DIN 2181 UNI 4535

M	mm	L	L1	Ft		
6x0,75	4,5	48	16	3.510	5	004330201
7x0,75	4,5	56	18	4.270	5	004330202
8x0,75	5,0	50	16	4.270	5	004330203
8x1	5,0	56	16	4.270	5	004330204
9x0,75	6,0	63	22	5.530	5	004330205
9x1	6,0	63	22	5.530	5	004330206
10x0,75	6,5	63	18	5.530	5	004330207
10x1	6,5	63	18	5.530	5	004330208
10x1,25	6,5	63	18	5.530	5	004330209
11x0,75	7,0	70	25	7.680	3	004330210
11x1	7,0	70	25	7.680	3	004330211
11x1,25	7,0	70	25	7.680	3	004330212
12x0,75	7,0	70	20	7.370	3	004330213
12x1	7,0	70	20	7.370	3	004330214
12x1,25	7,0	70	20	7.370	3	004330215
12x1,5	7,0	70	20	7.370	3	004330216
14x1	8,0	80	32	9.730	1	004330217
14x1,25	8,0	80	32	9.730	1	004330218
14x1,5	8,0	80	32	9.730	1	004330219
16x1	10,0	80	32	11.100	1	004330220
16x1,5	10,0	80	32	11.100	1	004330221
18x1,5	11,0	95	40	13.600	1	004330222
18x2	11,0	80	25	17.700	1	004330223
20x1,5	14,5	80	22	20.000	1	004330224
22x1,5	14,5	80	22	23.200	1	004330225
24x1,5	14,5	80	22	27.750	1	004330226
24x2	14,5	80	22	27.750	1	004330227

433ASF

Kézi menetfúró, UNF menet, króm-acélból



ANSI B1.1

UNF	mm	L	L1	Ft		
1/4x28	4,9	70	30	4.310	5	004330301
5/16x24	4,9	70	30	5.140	5	004330302
3/8x24	5,5	75	35	5.660	3	004330303
7/16x20	6,2	80	40	7.540	3	004330304
1/2x20	7,0	85	45	9.500	3	004330305
9/16x18	9,0	90	45	11.950	3	004330306
5/8x18	9,0	100	47	13.350	3	004330307
3/4x16	11,0	110	50	18.300	3	004330308
7/8x14	14,5	120	60	23.750	1	004330309
1"x12	16,0	130	60	32.250	1	004330310

433ASG

Kézi menetfúró, hengeres gázmenet, króm-acélból



DIN 5157

GAS	mm	L	L1	Ft		
1/8x28	5,5	65	18	6.390	1	004330401
1/4x19	9,0	70	24	7.800	1	004330402
3/8x19	9,0	75	25	9.610	1	004330403
1/2x14	12,0	80	31	13.850	1	004330405
3/4x14	16,0	90	33	23.150	1	004330408
1"x11	20,0	100	39	36.350	1	004330410

434

Kézi menetfúró, metrikus finom menet, HSS

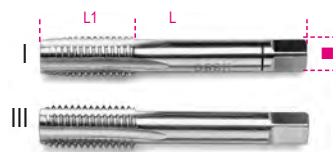

DIN 2181 UNI 4535

M	mm	L	L1	Ft		
6x0,75	4,5	48	16	10.600	5	004340001
8x0,75	5,0	56	16	11.450	5	004340003
8x1	5,0	56	16	11.450	5	004340004
10x0,75	6,5	63	18	14.850	5	004340007
10x1	6,5	63	18	14.850	5	004340008
10x1,25	6,5	63	18	14.850	5	004340009
12x1	7,0	70	20	15.900	3	004340014
12x1,25	7,0	70	20	15.900	3	004340015
12x1,5	7,0	70	20	15.900	3	004340016
13x1,5	9,0	70	20	35.300	1	004340017
14x1	9,0	70	20	19.750	1	004340018
14x1,25	9,0	70	20	19.750	1	004340019
14x1,5	9,0	70	20	16.650	1	004340020
15x1,5	9,0	70	20	35.300	1	004340021
16x1	9,0	70	20	21.550	1	004340022
16x1,5	9,0	70	20	18.300	1	004340023
18x1,5	11,0	80	22	23.250	1	004340024
18x2	11,0	90	25	29.200	1	004340025
20x1,25	12,0	80	22	43.350	1	004340026
20x1,5	12,0	80	22	25.100	1	004340027
20x2	12,0	90	25	31.250	1	004340028
22x1,5	14,5	80	22	35.350	1	004340029
24x1	14,5	80	22	48.800	1	004340030
24x1,5	14,5	80	22	40.800	1	004340031
24x2	14,5	80	22	42.400	1	004340032



435

Állítható hajtóvas menetfúrókhoz



DIN 1814

	□ mm	L mm	Ft	🔧	📦
435/0	2÷5 M1÷M8	170	6.900	3	004350007
435/1	2÷6 M1÷M10	200	8.400	2	004350009
435/1,5	2,5÷6 M1÷M12	200	9.090	2	004350011
435/2	3÷7 M4÷M12	260	12.400	2	004350013
435/3	4÷12 M5÷M20	345	20.750	1	004350020
435/4	5,5÷16 M9÷M27	430	32.800	1	004350027
435/5	7÷18 M13÷M32	770	73.000	1	004350032

435G

Állítható hajtóvas menetfúrókhoz



DIN 1814

	□ mm	L mm	Ft	🔧	📦
435G/0	2÷5 M1÷M8	130	4.890	5	004350108
435G/1	2÷6 M1÷M10	190	5.960	5	004350110
435G/1,5	2÷7 M2÷M12	175	6.300	5	004350112
435G/2	3,4÷7 M4÷M12	280	10.300	5	004350114
435G/3	4,9÷12 M5÷M20	380	16.800	2	004350121
435G/4	7÷16 M11÷M27	500	26.600	2	004350127
435G/5	7÷18 M13÷M32	700	41.950	1	004350132
435G/6	11÷24 M18÷M42	800	68.700	1	004350142

436

Írányváltós racsnis hajtóvas, krómzott

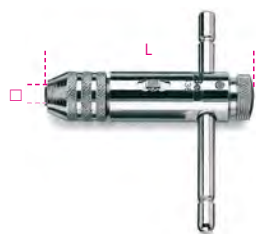

	□ mm	L mm	Ft	🔧	📦
436/1	2÷5 M3÷M8	85	11.250	5	004360002
436/2	4,6÷8 M5÷M12	110	14.300	5	004360004

436L

Írányváltós racsnis hajtóvas, hosszú kivitel, krómzott



	□ mm	L mm	Ft	🔧	📦
436L/1	2÷5 M3÷M8	245	17.550	2	004360012
436L/2	4,6÷8 M5÷M12	295	21.500	2	004360014

436R

Hajtóvasbetét a 436-hoz és a 436L-hez

	Ft	🔧	📦
436R/1	2.110	1	004360022
436R/2	2.320	1	004360024

437P

menetjavító
külső és belső, balos és jobbos menetek
javítására

P 0.80÷3.00 mm



L mm	Ft	🔧	📦
230	16.700	1	004370003

437C

Menetjavító készlet gyújtógyertyához
M14x1,25 mm

• Csavarfelület nagysága : 8,40 - 12,40 - 16,40 mm (5 darab méretenként)



	Ft	🔧	📦
437C	47.750	1	004370100

437C/...

Menetjavító rozsdamentes acélból a 437C-hez



H mm	Ft	🔧	📦
8.4	11.900	1	004370108
12.4	11.900	1	004370112
16.4	11.900	1	004370116

A megadott árak 10 darabra vonatkoznak.

437C/RM14

Menetfúró M14x1,25 gyújtógyertya
menetjavító betéthez



	Ft	🔧	📦
437C/RM14	39.650	1	004370124

437K/8

készlet féltengely
bordázat helyreállításához

• lehetővé teszi az eredeti bordázat feljavítását és frissítését
A készlet a következőket tartalmazza:
• metrikus méret:
20x1,25 - 20x1,5 - 22x1,00 - 22x1,5 - 24x1,5 - 24x2,00
• hüvelyk méret
3/4x20 - 13/16x20



○ 32 mm

	Ft	🔧	📦
437K/8	31.400	1	004370020

≡ 200x110x30 mm

437K/9

Kerékcsavar és anya sérült menetének
helyreállítására való javító készlet
Lehetővé teszi az eredeti menet javítását és
helyreállítását.

lehetővé teszi az eredeti menet javítását és utánköszörülését

A készlet tartalma:
• Menetfúrók:
M12x1,25 - M12x1,5 - M12x1,75 - M14x1,5
• Menetmetszők:
M12x1,25 - M12x1,5 - M14x1,5



○ 12 - 24 mm

	Ft	🔧	📦
437K/9	33.350	1	004370029

≡ 161x123x50 mm

Beta
Quality Tools



437K/10

Oxigénérzékelő sérült menetének helyreállítására való javítókészlet M18x1,5

Készlet tartalma:

- 1 nagyoló dörzsár M18
- 1 menetfúró M18x1,5
- 1 menetfúró M20x1,5
- 5 menetes persely M18x1,5
- 1 perselyező szerszám



∅ 13 - 27 mm

437K/10	Ft 50.800	1	004370030
∅ 190x105x40 mm			

437K/12

Féltengely sérült menetének helyreállítására való javítókészlet
Lehetővé teszi az eredeti menet javítását és helyreállítását.

Lehetővé teszi az eredeti menet javítását és utánköszörülését

A készlet tartalma:

- Metrikus méret:
M16x1,0 - M16x1,5 - M20x1,0 - M20x1,5 - M22x1,5 - M24x1,5 - M24x2,0 - M27x2,0
- Hüvelyk méret:
3/4x16 - 3/4x20 - 13/16x20 - 27/32x20



∅ 32 - 35 mm

437K/12	Ft 38.850	1	004370032
∅ 220x118x52 mm			

437K/16

Féknagyregtartó sérült menetének helyreállítására való javítókészlet M9x1,25



437K/16	Ft 44.650	1	004370016
∅ 210x150x50 mm			

437K/33

izzítógyertya sérült menet javítókészlet

Perselyek:

M8x1,0 - M10x1,0 - M10x1,25 - M12x1,25

Tüskék:

M8x1,0 - M10x1,0 - M10x1,25 - M12x1,0 - M12x1,25 - M14x1,25



437K/33	Ft 109.100	1	004370133
∅ 210x150x50 mm			

437U/09

Menetjavító készlet M5-M6-M8-M10-M12



25 x M5, M6, M8, M10
10 x M12

437U/09	Ft 134.700	1	004370550
M5X0,8			
M6X1,0			
M8X1,25			
M10X1,5			
M12X1,75			
∅ 370x230x55 mm - 2 Kg			

437U/E-M...

Menetjavító rozsdamentes acélból



	H mm	Ft		
M5	7.5	7.260	1	004370555
M6	9	7.260	1	004370556
M8	12	9.910	1	004370558
M10	15	13.200	1	004370560
M12	18	8.270	1	004370562

A megadott árak 25 darabra vonatkoznak (10 darabos az M12-es)

437U/PM

Fúró és menetmetsző a 437U/09-hez



	Ft		
M5	13.900	1	004370565
M6	14.600	1	004370566
M8	19.400	1	004370568
M10	24.800	1	004370570
M12	31.050	1	004370572

438A

fúró, menetvágó és süllyesztő készlet, HSS

- M3 - M4 - M5 - M6 - M8 - M10
- Mágneses csavartartó

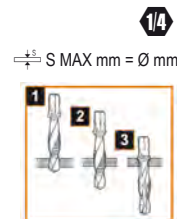

438A	Ft 46.400	1	004380010
------	--------------	---	-----------

438...

Fúró, menetvágó és süllyesztő készlet

HSS 1/4"

1/4"



	S max mm	Ft		
M3	3	8.910	2	004380103
M4	4	8.910	2	004380104
M5	5	8.910	2	004380105
M6	6	8.910	2	004380106
M8	8	9.810	2	004380108
M10	10	9.810	2	004380110

440

Menetmetsző, metrikus normál menet, krómaccélból

R ≤ 600 N/mm²
HRC | 60+61

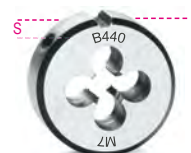

UNI 4535
DIN 223

M	∅ x S mm	Ft		
2x0,4	25,4 x 9	6.900	5	004400002
3x0,5	25,4 x 9	5.060	5	004400003
4x0,7	25,4 x 9	5.060	5	004400004
5x0,8	25,4 x 9	4.300	5	004400005
6x1	25,4 x 9	4.300	5	004400006
7x1	25,4 x 9	4.300	5	004400007
8x1,25	25,4 x 9	4.300	5	004400008
9x1,25	25,4 x 9	4.300	5	004400009
10x1,5	25,4 x 9	4.300	5	004400010
12x1,75	25,4 x 9	4.300	5	004400012

440A

Menetmetsző, metrikus normál menet, krómaccélból

R ≤ 600 N/mm²
HRC ▯ 60÷61



UNI 4535
DIN 223

M	Ø x S mm	Ft	🔧	📄
10x1,5	38,1 x 14	6.170	3	004400110
11x1,5	38,1 x 14	6.170	3	004400111
12x1,75	38,1 x 14	6.170	3	004400112
14x2	38,1 x 14	6.170	3	004400114
16x2	38,1 x 14	6.170	3	004400116
18x2,5	38,1 x 14	7.000	3	004400118
20x2,5	38,1 x 14	7.790	3	004400120

440B

Menetmetsző, metrikus normál menet, krómaccélból

R ≤ 600 N/mm²
HRC ▯ 60÷61



UNI 4535
DIN 223

M	Ø x S mm	Ft	🔧	📄
18x2,5	50,8 x 16	10.950	3	004400122
20x2,5	50,8 x 16	11.400	3	004400124
22x2,5	50,8 x 16	12.350	3	004400126
24x3	50,8 x 16	12.600	3	004400128

440ASW

Menetmetsző, Whitworth menet, krómaccélból

R ≤ 600 N/mm²



UNI EN 22568
DIN 223

BSW	Ø x S mm	Ft	🔧	📄
1/8x40	25,4 x 9	5.830	5	004400201
5/32x32	25,4 x 9	5.830	5	004400202
3/16x24	25,4 x 9	5.240	5	004400203
1/4x20	25,4 x 9	5.240	5	004400204
5/16x18	25,4 x 9	5.020	5	004400205
3/8x16	38,1 x 14	7.470	3	004400206
7/16x14	38,1 x 14	7.470	3	004400207
1/2x12	38,1 x 14	7.390	3	004400208
9/16x12	38,1 x 14	7.390	3	004400209
5/8x11	50,8 x 16	13.550	3	004400210
3/4x10	50,8 x 16	13.550	3	004400211
7/8x9	50,8 x 16	15.550	3	004400212
1"x8	50,8 x 16	15.550	3	004400213

440ASC

Menetmetsző, UNC menet, krómaccélból

R ≤ 600 N/mm²

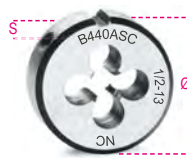

UNI EN 22568
DIN 223

UNC	Ø x S mm	Ft	🔧	📄
1/4x20	25,4 x 9	5.210	5	004400221
5/16x18	25,4 x 9	5.210	5	004400222
3/8x16	38,1 x 14	7.260	3	004400223
7/16x14	38,1 x 14	7.260	3	004400224
1/2x13	38,1 x 14	7.260	3	004400225
9/16x12	38,1 x 14	7.260	3	004400226
5/8x11	50,8 x 16	15.200	3	004400227
3/4x10	50,8 x 16	15.200	3	004400228
7/8x9	50,8 x 16	15.200	3	004400229
1"x8	50,8 x 16	15.200	3	004400230

440ASF

Menetmetsző, UNF menet, krómaccélból



UNI EN 22568
DIN 223

UNF	Ø x S mm	Ft	🔧	📄
1/4x28	25,4 x 9	5.480	5	004400241
5/16x24	25,4 x 9	5.480	5	004400242
3/8x24	38,1 x 14	7.950	3	004400243
7/16x20	38,1 x 14	7.950	3	004400244
1/2x20	38,1 x 14	7.950	3	004400245
9/16x18	38,1 x 14	7.950	3	004400246
5/8x18	50,8 x 16	16.050	3	004400247
3/4x16	50,8 x 16	16.050	3	004400248
7/8x14	50,8 x 16	16.050	3	004400249
1"x12	50,8 x 16	16.050	3	004400250

440ASG

Menetmetsző, hengeres gáz-menet, krómaccélból

R ≤ 600 N/mm²



UNI EN 24231
DIN 223

GAS	Ø x S mm	Ft	🔧	📄
1/8x28	38,1 x 14	6.190	3	004400255
1/4x19	38,1 x 14	6.190	3	004400256
3/8x19	38,1 x 14	6.190	3	004400257
1/2x14	50,8 x 16	12.750	3	004400259
3/4x14	50,8 x 16	12.750	3	004400260
1"x11	63,5 x 19	25.500	3	004400261

441

Menetmetsző, metrikus finom menet, krómaccélból

R ≤ 600 N/mm²
HRC ▯ 60÷61



UNI 4535
DIN 223

M	Ø x S mm	Ft	🔧	📄
6x0,75	25,4 x 9	5.050	5	004410004
7x0,75	25,4 x 9	5.050	5	004410005
8x0,75	25,4 x 9	5.050	5	004410006
8x1	25,4 x 9	5.050	5	004410007
9x0,75	25,4 x 9	5.050	5	004410008
9x1	25,4 x 9	5.050	5	004410009

441A

Menetmetsző, metrikus finom menet, krómaccélból

R ≤ 600 N/mm²
HRC ▯ 60÷61

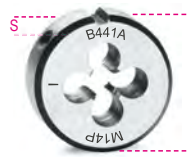

UNI 4535
DIN 223

M	Ø x S mm	Ft	🔧	📄
10x0,75	38,1 x 14	7.800	3	004410100
10x1	38,1 x 14	7.800	3	004410101
10x1,25	38,1 x 14	7.800	3	004410102
11x0,75	38,1 x 14	7.800	3	004410103
11x1	38,1 x 14	7.800	3	004410104
11x1,25	38,1 x 14	7.800	3	004410105
12x0,75	38,1 x 14	7.800	3	004410106
12x1	38,1 x 14	7.800	3	004410107
12x1,25	38,1 x 14	7.800	3	004410108
12x1,5	38,1 x 14	7.800	3	004410109
14x1	38,1 x 14	7.800	3	004410110
14x1,25	38,1 x 14	7.800	3	004410111
14x1,5	38,1 x 14	7.800	3	004410112
16x1	38,1 x 14	7.800	3	004410113
16x1,5	38,1 x 14	7.800	3	004410114
18x1,5	38,1 x 14	7.800	3	004410115



441B

Menetmetsző, metrikus finom menet, krómaccéliből

R ≤ 600 N/mm²
HRC || 60+61



UNI 4535
DIN 223

M	Ø x S mm	Ft		
18x1,5	50,8 x 16	14.350	3	004410117
18x2	50,8 x 16	14.400	3	004410118
20x1,5	50,8 x 16	15.400	3	004410119
22x1,5	50,8 x 16	15.450	3	004410120
24x1,5	50,8 x 16	15.550	3	004410121
24x2	50,8 x 16	15.550	3	004410122

442

Menetmetsző, metrikus normál menet, HSS

HRC || 62+63
AISI M2



UNI EN 22568
DIN 223

M	Ø x S mm	Ft		
3x0,5	20x5	6.150	3	004420003
4x0,7	20x5	6.150	3	004420004
5x0,8	20x7	6.140	3	004420005
6x1	20x7	6.140	3	004420006
7x1	25x9	6.800	3	004420007
8x1,25	25x9	6.800	3	004420008
10x1,5	30x11	8.090	3	004420010
12x1,75	38x14	13.300	3	004420012
14x2	38x14	16.750	1	004420014
16x2	45x18	21.950	1	004420016
18x2,5	45x18	22.950	1	004420018
20x2,5	45x18	23.450	1	004420020

443

Menetmetsző, metrikus finom menet, HSS

HRC || 62+63
AISI M2



UNI EN 22568
DIN 223

M	Ø x S mm	Ft		
6x0,75	20x7	10.950	1	004430107
8x0,75	25x9	11.900	1	004430110
8x1	25x9	11.300	1	004430111
10x0,75	30x11	14.300	1	004430113
10x1	30x11	12.850	1	004430114
10x1,25	30x11	12.850	1	004430115
12x1	38x10	20.900	1	004430116
12x1,25	38x10	20.900	1	004430117
12x1,5	38x10	20.900	1	004430118
13x1,5	38x10	25.150	1	004430119
14x1	38x10	20.700	1	004430120

M	Ø x S mm	Ft		
14x1,25	38x10	20.700	1	004430121
14x1,5	38x10	20.700	1	004430122
15x1,5	38x10	28.100	1	004430123
16x1	45x14	31.100	1	004430124
16x1,5	45x14	31.100	1	004430125
18x1,5	45x14	31.100	1	004430127
20x1,25	45x14	32.050	1	004430129
20x1,5	45x14	32.050	1	004430130
20x2	45x14	33.000	1	004430131
22x1,5	55x16	38.700	1	004430132
24x1	55x16	39.800	1	004430133
24x1,5	55x16	39.800	1	004430135
24x2	55x16	41.300	1	004430136

444

Metsző hajtóvas



EN 22568
DIN 225

	Ø mm	L mm	Ft		
444	20x5	190	8.660	5	004440005
444/0	20x7	190	8.660	5	004440007
444/1	25,4x9,5	210	8.970	5	004440025
444/1A	25x9	215	9.100	5	004440027
444/1B	30x11	250	10.350	5	004440030
444/C	38x10	310	12.850	3	004440033
444/1C	38x14	310	12.850	3	004440035
444/2	38,1x12,7	300	13.300	3	004440038
444/1D	45x14	445	18.100	1	004440045
444/2D	45x18	445	18.100	1	004440046
444/3	50,8x15,9	520	26.600	1	004440050
444/4	55x16	495	26.600	1	004440055
444/5A	63,5x19	520	45.150	1	004440057

444G

Metsző hajtóvas



UNI EN 22568
DIN 225

	Ø mm	L mm	Ft		
444G/A	16x5	160	4.020	5	004440103
444G	20x5	185	4.500	5	004440105
444G/0	20x7	185	4.500	5	004440107
444G/1	25,4x9,5	215	5.470	5	004440125
444G/1A	25x9	215	5.470	5	004440127
444G/1B	30x11	265	6.860	5	004440130
444G/C	38x10	315	10.000	3	004440133
444G/1C	38x14	315	10.000	3	004440135
444G/2	38,1x12,6	310	10.000	3	004440138
444G/1D	45x14	450	13.450	1	004440145
444G/2D	45x18	450	14.050	1	004440146
444G/3	50,8x16	485	14.250	1	004440150
444G/4	55x16	560	17.400	1	004440155
444G/5A	63,5x19	630	30.600	1	004440163
444G/6	65x18	630	31.700	1	004440165

446/C30

Krómaccél menetfúró és menetmetsző készlet, metrikus normál menet és tartozékok



	Ft		
446/C30	127.500	1	004460055

≡ 325x220x35 mm - 3,2 Kg

430 M mm	440 M mm		
3x0,5	3x0,5	435/1,5	444/1
4x0,7	4x0,7		
5x0,8	5x0,8		
6x1	6x1		
8x1,25	8x1,25		
10x1,5	10x1,5		
12x1,75	12x1,75		

446/C48

Krómaccél menetfúró és menetmetsző készlet, metrikus normál menet és tartozékok



	Ft		
446/C48	240.000	1	004460057

≡ 580x300x50 mm - 5 Kg

430 M mm	440 M mm	440A M mm		
3x0,5	3x0,5	10x1,5	435/1	444/1
4x0,7	4x0,7	12x1,75	435/3	444/2
5x0,8	5x0,8	14x2		
6x1	6x1	16x2		
8x1,25	8x1,25	18x2,5		
10x1,5		20x2,5		
12x1,75				
14x2				
16x2				
18x2,5				
20x2,5				



446/C110

Krómacél menetfúró és menetmetsző készlet, metrikus normál és finom menet és tartozékok



446/C110 Ft 350.400 1 004460060

500x337x60 mm - 8,1 Kg

430 M mm	433 M mm	440/440A M mm	441/441A M mm
2x0,4	6x0,75	2x0,4	6x0,75
3x0,5	7x0,75	3x0,5	7x0,75
4x0,7	8x0,75	4x0,7	8x0,75
5x0,8	8x1	5x0,8	8x1
6x1	9x0,75	6x1	9x0,75
7x1	9x1	7x1	9x1
8x1,25	10x0,75	8x1,25	10x0,75
9x1,25	10x1	9x1,25	10x1
10x1,5	10x1,25	10x1,5	10x1,25
11x1,5	11x0,75	11x1,5	11x0,75
12x1,75	11x1	12x1,75	11x1
14x2	11x1,25	14x2	11x1,25
16x2	12x0,75	16x2	12x0,75
	12x1		12x1
	12x1,25		12x1,25
	12x1,5		12x1,5
	14x1		14x1
	14x1,25		14x1,25
	14x1,5		14x1,5
	16x1		16x1
	16x1,5		16x1,5
	18x1,5		18x1,5

435/0	444/1	436/1
435/3	444/2	

446ASF/C29

Krómacél menetfúró és menetmetsző készlet, UNF menet



446ASF/C29 Ft 271.500 1 004460070

660x410x50 mm - 6 Kg

433ASF	440ASF		
1/4	1/4	435/1,5	444/1
5/16	5/16	435/3	444/2
3/8	3/8		444/3
7/16	7/16		
1/2	1/2		
9/16	9/16		
5/8	5/8		
3/4	3/4		

446ASW/C36

Krómacél menetfúró és menetmetsző készlet, Whitworth menet



446ASW/C36 Ft 205.800 1 004460075

525x310x50 mm - 3,4 Kg

430ASW	440ASW		
1/8	1/8	435/1,5	444/1
5/32	5/32	435/2	444/2
3/16	3/16		
1/4	1/4		
5/16	5/16		
3/8	3/8		
7/16	7/16		
1/2	1/2		

446ASC/C37

Krómacél menetfúró és menetmetsző készlet, UNC menet



446ASC/C37 Ft 292.800 1 004460080

660x410x50 mm - 6,7 Kg

430ASC	440ASC		
1/4	1/4	435/1,5	444/1
5/16	5/16	435/3	444/2
3/8	3/8		444/3
7/16	7/16		
1/2	1/2		
9/16	9/16		
5/8	5/8		
3/4	3/4		

446ASG/C23

Krómacél menetfúró és menetmetsző készlet, hengeres gázméret



446ASG/C23 Ft 428.600 1 004460085

700x430x70 mm - 9,8 Kg

433ASG	440ASG		
1/8	1/8	435/3	444/2
1/4	1/4	435/5	444/3
3/8	3/8		444/5A
1/2	1/2		
3/4	3/4		
1"	1"		



Beta

447/C37

HSS menetfúró és menetmetsző készlet, metrikus normál menet



447/C37 Ft 229.800 1 004470055

≡ 380x185x35 mm - 3,9 Kg

431 M mm	442 M mm		
3x0,5	3x0,5	435/0	444
4x0,7	4x0,7	435/2	444/0
5x0,8	5x0,8		444/1A
6x1	6x1		444/1B
8x1,25	8x1,25		444/1C
10x1,5	10x1,5		
12x1,75	12x1,75		

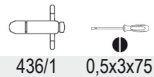

436/1 0,5x3x75

447/C53

HSS menetfúró és menetmetsző készlet, metrikus normál menet



447/C53 Ft 537.300 1 004470060

≡ 500x235x50 mm - 9 Kg

431 M mm	442 M mm			
3x0,5	3x0,5	435/1,5	444	436/1
4x0,7	4x0,7	435/3	444/0	436/2
5x0,8	5x0,8		444/1A	
6x1	6x1		444/1B	
8x1,25	8x1,25		444/1C	
10x1,5	10x1,5		444/2D	
12x1,75	12x1,75			
14x2	14x2			
16x2	16x2			
18x2,5	18x2,5			
20x2,5	20x2,5			

447/C70

HSS menetfúró és menetmetsző készlet, metrikus normál és finom menet



447/C70 Ft 665.300 1 004470065

≡ 510x340x70 mm - 7,5 Kg

431 M mm	434 M mm	442 M mm	443 M mm
3x0,5	8x1	3x0,5	8x1
4x0,7	10x1,25	4x0,7	10x1,25
5x0,8	12x1,25	5x0,8	12x1,25
6x1	12x1,5	6x1	12x1,5
7x1	14x1,25	7x1	14x1,25
8x1,25	14x1,5	8x1,25	14x1,5
10x1,5	16x1,5	10x1,5	16x1,5
12x1,75		12x1,75	
14x2		14x2	
16x2		16x2	



435/0	444	436/1
435/3	444/0	
	444/1A	
	444/1B	
	444/C	
	444/1C	
	444/1D	
	444/2D	

450

Koronafúró HSS, bimetál



HSS-Co 8%

Ø mm	Ø	A mm	Ft		
16	(5/8)	57	6.960	1	004500016
17	(11/16)	57	6.960	1	004500017
19	(3/4)	51	6.960	1	004500019
20	-	51	6.960	1	004500020
21	(13/16)	51	6.960	1	004500021
22	(7/8)	51	6.960	1	004500022
24	(15/16)	51	6.960	1	004500024
25	(1")	51	7.310	1	004500025
27	(1 1/16)	51	7.300	1	004500027
29	(1 1/8)	51	7.300	1	004500029
30	(1 3/16)	51	7.300	1	004500030
32	(1 1/4)	51	7.300	1	004500032
33	(1 5/16)	51	7.290	1	004500033
35	(1 3/8)	51	8.810	1	004500035

Ø mm	Ø	A mm	Ft		
37	(1 7/16)	51	8.810	1	004500037
38	(1 1/2)	44	8.790	1	004500038
40	(1 9/16)	44	9.080	1	004500040
41	(1 5/8)	44	9.070	1	004500041
43	(1 11/16)	44	9.070	1	004500043
44	(1 3/4)	44	10.100	1	004500044
46	(1 13/16)	44	10.100	1	004500046
48	(1 7/8)	44	10.100	1	004500048
51	(2")	44	10.050	1	004500051
52	(2 1/16)	44	11.800	1	004500052
54	(2 1/8)	44	11.800	1	004500054
57	(2 1/4)	44	11.800	1	004500057
59	(2 5/16)	44	11.950	1	004500059
60	(2 3/8)	44	11.950	1	004500060
64	(2 1/2)	44	12.950	1	004500064
65	(2 9/16)	44	12.950	1	004500065
67	(2 5/8)	44	12.950	1	004500067
68	-	44	12.950	1	004500068
70	(2 3/4)	44	12.850	1	004500070
73	(2 7/8)	44	12.850	1	004500073
76	(3")	44	13.350	1	004500076
79	(3 1/8)	44	13.600	1	004500079
83	(3 1/4)	44	14.000	1	004500083
86	(3 3/8)	44	14.500	1	004500086
89	(3 1/2)	44	15.250	1	004500089
92	(3 5/8)	44	15.700	1	004500092
95	(3 3/4)	44	17.150	1	004500095
98	(3 7/8)	44	17.600	1	004500098
102	(4")	44	18.050	1	004500102
105	(4 1/8)	44	19.750	1	004500105
108	(4 1/4)	44	25.900	1	004500108
111	(4 3/8)	44	29.950	1	004500111
114	(4 1/2)	44	35.300	1	004500114
121	(4 3/4)	44	39.050	1	004500121
127	(5")	44	43.150	1	004500127
140	(5 1/2)	44	52.050	1	004500140
152	(6")	44	60.500	1	004500152

450AL

Fellevőszár, központfúróval

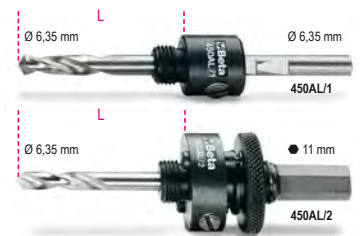

	Ø mm	L mm	Ft		
450AL/1	16÷30	54	7.800	1	004500210
450AL/2	32÷152	70	19.800	1	004500215

450AD

Koronafúró adapter



	Ø mm	Ft		
450AD	32÷51	3.040	1	004500230



450PA/1

Központfúró a 450AL/1 típusú felvevőszárhoz, HSS

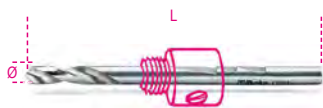

ØxL
mm
6,35x105 Ft 4.860 1 004500252

450PA/2

Központfúró a 450AL/2 típusú felvevőszárhoz, HSS

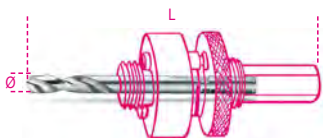

ØxL
mm
6,35x80 Ft 4.860 1 004500253

450PR

Felvevőszár hosszabbító



L
mm
305 Ft 14.300 1 004500255

450/C9

Koronafúró készlet villanszerelőknek, ütésálló műanyag dobozban



HSS-Co 8%

450/C9 Ft 100.700 1 004500305

450 Ø 22 - 29 - 35 - 44 - 51 - 64 mm

450AL /1 - /2

450AD

220x160x60 mm - 1,6 Kg

450/C13

Koronafúró készlet gáz- és vízvezeték szerelőknek, ütésálló műanyag dobozban



HSS-Co 8%

450/C13 Ft 126.600 1 004500310

450 Ø 19 - 22 - 29 - 35 - 38

44 - 51 - 57 - 64 mm

450AL /1 - /2

450PA/1

450AD

215x180x65 mm - 1,8 Kg

450/C15

koronafúró és tartozék készlet villanszerelőknek



450/C15 Ft 158.300 1 004500313

450 Ø 16 - 20 - 25 - 32 - 40

51 - 60 - 65 - 70 mm

450AL /1 - /2

450PA /1 - /2

450PR

450AD

420x185x60 mm - 3,2 Kg

450/C21

Koronafúró készlet ipari használatra



HSS-Co 8%

450/C21 Ft 275.000 1 004500315

450 Ø 19 - 22 - 29 - 35 - 38

44 - 51 - 57 - 64 - 76

83 - 92 - 95 - 105 - 114 mm

450AL /1 - /2

450PA /1 - /2

450PR

450AD

420x280x60 mm - 7 Kg

451

Koronafúró HSS, köszörült

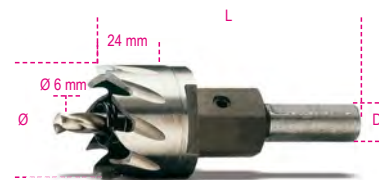

Ø mm	L mm	D mm	Ft		
12	85	8	10.100	1	004510012
13	85	8	10.100	1	004510013
14	85	8	10.200	1	004510014
15	85	10	10.200	1	004510015
16	85	10	10.200	1	004510016
17	85	10	10.200	1	004510017
18	85	10	10.200	1	004510018
19	85	10	10.450	1	004510019
20	85	10	10.900	1	004510020
21	85	10	11.400	1	004510021
22	85	10	12.150	1	004510022
23	85	10	12.850	1	004510023
24	85	10	13.300	1	004510024
25	85	10	13.800	1	004510025
26	90	10	14.350	1	004510026
27	90	10	14.300	1	004510027
28	90	10	15.000	1	004510028
29	90	10	15.450	1	004510029
30	90	10	15.800	1	004510030
31	90	10	16.400	1	004510031
32	90	10	16.950	1	004510032
33	90	10	17.650	1	004510033
34	90	10	18.250	1	004510034
35	90	10	18.650	1	004510035
36	85	10	18.950	1	004510036
37	85	10	19.600	1	004510037
38	85	10	20.200	1	004510038
39	85	10	21.200	1	004510039
40	85	10	21.450	1	004510040
41	85	10	22.250	1	004510041
42	85	10	23.150	1	004510042
43	85	10	23.600	1	004510043
44	85	10	23.950	1	004510044
45	85	10	24.750	1	004510045
46	85	10	24.950	1	004510046
47	85	10	25.500	1	004510047
48	85	10	26.550	1	004510048
49	85	10	27.600	1	004510049
50	85	10	27.600	1	004510050

451GA

Felvevőszár



M	Ø	L	D	Ft		
mm	mm	mm	mm			
10x1,25	12÷14	57	8	5.610	1	004510101
12x1,25	15÷34	57	10	5.610	1	004510102
14x1,5	35÷50	57	10	6.990	1	004510105

451PA

Központfúró a felvevőszárhoz,
HSS



Ø	L	Ft		
mm	mm			
6	53	3.190	1	004510103

451PR

Felvevőszár hosszabbító a 451 típusú
HSS-koronafúróhoz



M	Ø	L	Ø1	Ft		
mm	mm	mm	mm			
12x1,25	15÷34	400	13	25.500	1	004510104
14x1,5	35÷50	400	13	25.500	1	004510108



452

Keményfémlapkás koronafúró

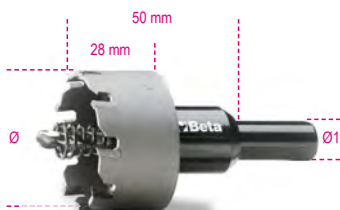

Ø	Ø1	Ft		
mm	mm			
15	10	41.450	1	004520015
16	10	41.450	1	004520016
17	10	41.450	1	004520017
18	10	41.450	1	004520018
19	10	41.450	1	004520019
20	10	41.450	1	004520020
21	10	41.450	1	004520021
22	10	41.450	1	004520022
23	10	41.450	1	004520023
24	10	41.450	1	004520024
25	10	41.450	1	004520025
26	10	46.850	1	004520026
27	10	46.850	1	004520027
28	10	46.850	1	004520028
29	10	46.850	1	004520029
30	10	46.850	1	004520030
31	10	55.750	1	004520031
32	10	55.750	1	004520032
33	10	55.750	1	004520033
34	10	55.750	1	004520034
35	10	55.750	1	004520035
36	10	64.850	1	004520036
37	10	64.850	1	004520037
38	10	64.850	1	004520038
39	13	64.850	1	004520039
40	13	64.850	1	004520040
41	13	73.050	1	004520041
42	13	73.050	1	004520042
43	13	73.050	1	004520043
44	13	73.050	1	004520044
45	13	73.050	1	004520045
46	13	82.500	1	004520046
47	13	82.500	1	004520047
48	13	82.500	1	004520048
49	13	82.500	1	004520049
50	13	82.500	1	004520050
55	13	92.950	1	004520055
60	13	123.000	1	004520060
65	13	123.000	1	004520065
70	13	144.100	1	004520070
75	13	154.800	1	004520075
80	13	168.800	1	004520080
85	13	193.500	1	004520085
90	13	205.300	1	004520090

452GA

Felvevőszár



	Ø	Ft		
	mm			
452GA/1	15÷21	5.100	1	004520125
452GA/2	22÷38	5.880	1	004520126
452GA/3	39÷100	6.850	1	004520127

460

koronafúró építőanyagokhoz

- Beton, cement, természetes és műkö fűrészekhez
- Maximum fűrészmélység: 60 mm



Ø	L	Z	Ft		
mm	mm				
50	75	6	19.850	1	004600050
60	75	6	23.550	1	004600060
65	75	6	24.750	1	004600065
80	75	6	36.250	1	004600080
90	75	6	38.500	1	004600090
100	75	8	46.800	1	004600100
112	75	8	53.950	1	004600112
125	80	10	66.500	1	004600125
150	80	12	90.700	1	004600150

460PP

előfúró az építőanyagokhoz ajánlott 460 típusú
koronafúróhoz



Ø	L	Ft		
mm	mm			
8	120	2.210	1	004600201

460G

szár a 460 típusú koronafúróhoz



L	Ft		
mm			
220	12.100	1	004600222
370	16.950	1	004600237
460	26.850	1	004600246



NYOMATÉKSOKSZOROZÓK

A nyomatéksokszorozók az anyák és csavarok meghúzásának elengedhetetlen eszközei, mivel szűk vagy nehezen hozzáférhető helyeken nagyobb forgatónyomaték létrehozását teszik lehetővé, mint amit használója egyébként alkalmazna. Nem igényelnek nagy méretű hosszabbításokat, és így teljes biztonságot nyújtanak. A Beta nyomatéksokszorozói különféle megoldásokat és teljesítményeket kínálnak 9500 Nm-ig, 125:1 nyomaték szorzó aránnyal. Sok modell – különösen a legnagyobb teljesítményűek – kétirányú visszaütésgátlóval vannak felszerelve, amely megakadályozza a veszélyes húzóerő visszajutását a szerszám használójához. A Beta nyomatéksokszorozóinak mindegyike rendelkezik azt igazoló tanúsítvánnyal, hogy a szerszámot optimális üzemi körülmények között, maximális értéken tesztelték.



Kezelési útmutató

A nyomatéksokszorozót **nyomatékkulccsal együtt kell használni** a kimeneti nyomaték szabályozásának biztosítása érdekében; továbbá mindig **dugókulcsokkal** kell használni.

Az egyes nyomatéksokszorozók arányai határozzák meg a bemeneti és a kimeneti nyomaték közötti szorzótényezőt. Példa: nyomaték szorzó aránya 5:1. A nyomatékkulcsra beállított 100 Nm bemeneti nyomaték alkalmazása 500 Nm kimeneti nyomatékot visz át az anyára vagy a csavarra.

Azonban meg kell győződni arról, hogy a meghúzással érintett minden alkatrész megfelelően illeszkedjen. Kerülje a **hosszabbítások** használatát, mivel ezek megcsavarodhatnak, és így olyan rugóhatás jöhet létre, ami módosíthatja a kívánt nyomaték értékét.

Mindig ellenőrizze, hogy a nyomatéksokszorozó reakciókarja olyan erős szerkezethez legyen rögzítve, vagy támaszkodjon, amely ellenáll a reakcióerőnek. Főszabályként a megmunkálni tervezett darab közelében található megfelelő merevségű falak vagy csavarok használhatók. A reakciókar mindig a meghúzás irányával **ellentétes** irányban forog.

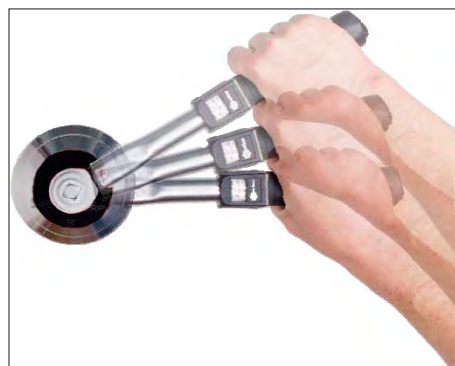

Zökkenőmentesen és megszakítás nélkül alkalmazza.

A meghúzási feszültség a nyomatéksokszorozó ellentétes irányba történő forgatásával oldható fel - mielőtt azt leválasztaná. Ha a nyomatéksokszorozót csavarodásgátló rendszerrel látták el, a meghúzási feszültséget az irányváltókaron keresztül kell feloldani.

A fenti utasítások a **kicsavazási** műveletekre is vonatkoznak.

560/C3

Nyomatéksokszorozó, jobb- és bal irányú meghúzáshoz, műanyag ládában, áttétel 3,8:1, visszaütésgátlóval

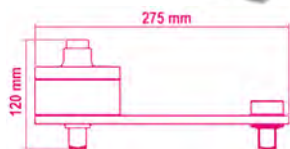

Nm	kgfm	lbf.ft	□	■	kg
1500	150	1110	1/2"	3/4"	3,9

Ft		☰	☒	☒
560/C3	343.400	1	005600030	

☰ 400x260x110 mm

560/C3PLUS

Nyomatéksokszorozó, jobb- és bal irányú meghúzáshoz, műanyag ládában, áttétel 3,8:1, visszaütésgátlóval

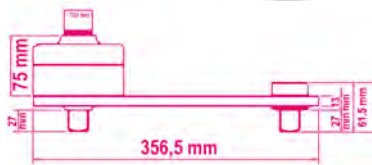

Nm	kgfm	lbf.ft	□	■	kg
2700	270	1991	3/4"	1"	7,5

Ft		☰	☒	☒
560/C3PLUS	402.300	1	005600038	

☰ 470x240x160 mm

560/C2

Nyomatéksokszorozó, jobb- és bal irányú meghúzáshoz, tartozékokkal, áttétel 5:1, műanyag kofferban

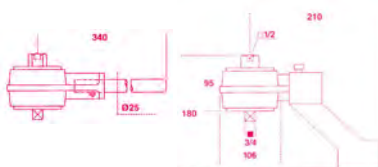

Nm	Kgfm	lbf.ft	□	■	kg
1300	130	960	1/2"	3/4"	3,8

Ft		☰	☒	☒
560/C2	608.700	1	005600020	
560/2	439.600	1	005600002	
560/18	14.650	1	005600018	
560/19	32.700	1	005600019	
560/22	114.700	1	005600022	

☰ 310x275x120 mm

560/C4+

Nyomatéksokszorozó, jobb- és bal irányú meghúzáshoz, tartozékokkal, áttétel 5:1, kitámasztó karral

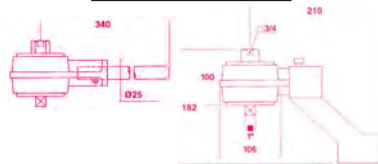

Nm	Kgfm	lbf.ft	□	■	kg
2700	270	2000	3/4"	1"	5

Ft		☰	☒	☒
560/C4PLUS	603.300	1	005600042	
560/4	466.900	1	005600004	
560/18	14.650	1	005600018	
560/22	114.700	1	005600022	

☰ 310x275x120 mm

560/C6

Nyomatéksokszorozó, jobb- és bal irányú meghúzáshoz, áttétel 6,5:1, műanyag kofferban



Nm	kgfm	lbf.ft	□	■	kg
1500	150	1106	1/2"	3/4"	6

Ft		☰	☒	☒
560/C6	289.300	1	005600160	

☰ 400x260x110 mm

560/C12

Nyomatéksokszorozó, jobb- és bal irányú meghúzáshoz, áttétel 12:1, műanyag kofferban



Nm	kgfm	lbf.ft	□	■	kg
2500	250	1844	1/2"	1"	7

Ft		☰	☒	☒
560/C12	418.100	1	005600210	

☰ 400x260x110 mm

561/1

Nyomatéksokszorozó, irányváltós racsnival, áttétel 5:1, két kitámasztó karral

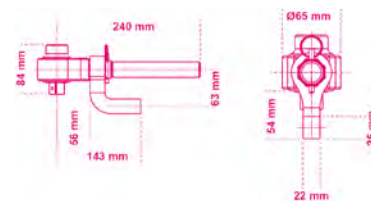

Nm	kgfm	lbf.ft	□	■	kg
1000	100	740	1/2"	3/4"	2,7

Ft		☰	☒	☒
561/1	469.500	1	005610010	

☰ 270x210x70 mm

562-1/VA - 562-2/VA

jobb és balos nyomatéksokszorozó
 áttétel 5,2:1
 562VV-A táskában



Nm	Kgfm	lbf.ft	□	■	D	A	L min	L max	♁
1700	170	1250	3/4	1"	mm	mm	mm	mm	kg
					108	95	85	220	8,8

562-1/VA **Ft** 973.300 1 005620601

Nm	Kgfm	lbf.ft	□	■	D	A	L min	L max	♁
3400	340	2500	3/4	1"	mm	mm	mm	mm	kg
					119	115	85	265	10,5

562-2/VA **Ft** 1.147.600 1 005620602

564-3R/V - 564-4R/V

nyomatéksokszorozó jobb- és bal irányú
 meghúzáshoz
 áttétel 25:1
 visszaütésgátlóval
 fémdobozban



Nm	Kgfm	lbf.ft	□	■	D	A	L	♁
4000	400	3000	1/2	1"	mm	mm	mm	kg
					92	185	205	7,6

564-3R/V **Ft** 2.116.700 1 005640613

☞ 390x310x145 mm

Nm	Kgfm	lbf.ft	□	■	D	A	L	♁
7000	700	5000	1/2	1 1/2"	mm	mm	mm	kg
					120	200	210	13,2

564-4R/V **Ft** 2.500.900 1 005640614

☞ 500x435x170 mm

565-1R/VA - 565-2R/VA - 565-3R/VA

jobb és balos nyomatéksokszorozó
 áttétel 27:1
 visszaütésgátlóval
 562VV-A táskában



Nm	Kgfm	lbf.ft	□	■	D	A	L min	L max	♁
1700	170	1250	1/2	1"	mm	mm	mm	mm	kg
					108	125	80	215	11,2

565-1R/VA **Ft** 1.528.400 1 005650611

Nm	Kgfm	lbf.ft	□	■	D	A	L min	L max	♁
3400	340	2500	1/2	1"	mm	mm	mm	mm	kg
					119	145	85	265	13,6

565-2R/VA **Ft** 2.024.800 1 005650612

Nm	Kgfm	lbf.ft	□	■	D	A	L min	L max	♁
3400	340	2500	1/2	1 1/2"	mm	mm	mm	mm	kg
					119	145	85	265	14,2

565-3R/VA **Ft** 2.156.300 1 005650613

565-4R/VB

jobb és balos nyomatéksokszorozó
 áttétel 27:1
 visszaütésgátlóval
 565VV-B táskában

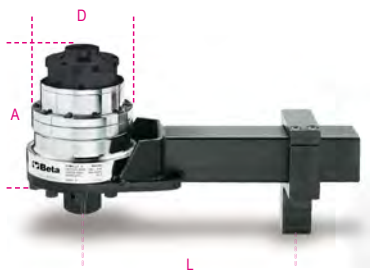

Nm	Kgfm	lbf.ft	□	■	D	A	L min	L max	♁
6000	600	4500	1/2	1 1/2"	mm	mm	mm	mm	kg
					144	180	125	335	22,4

565-4R/VB **Ft** 2.405.400 1 005650614

565-5R/VB

jobb és balos nyomatéksokszorozó
 áttétel 27:1
 visszaütésgátlóval
 565VV-B táskában

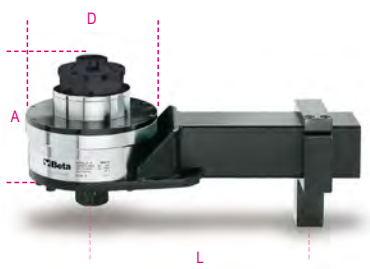

Nm	Kgfm	lbf.ft	□	■	D	A	L min	L max	♁
9500	950	7000	3/4	1 1/2"	mm	mm	mm	mm	kg
					184	180	155	355	30,4

565-5R/VB **Ft** 4.031.400 1 005650615

567-4R/VB

jobb és balos nyomatéksokszorozó
 áttétel 135:1
 visszaütésgátlóval
 565VV-B táskában

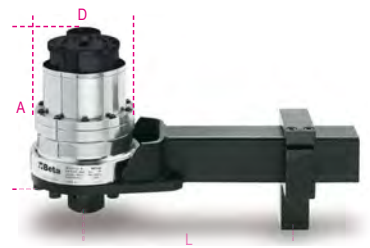

Nm	Kgfm	lbf.ft	□	■	D	A	L min	L max	♁
6000	600	4500	1/2	1 1/2"	mm	mm	mm	mm	kg
					144	210	125	335	24,4

567-4R/VB **Ft** 2.691.400 1 005670614

567-5R/VB

jobb és balos nyomatéksokszorozó
 áttétel 135:1
 visszaütésgátlóval
 565VV-B táskában

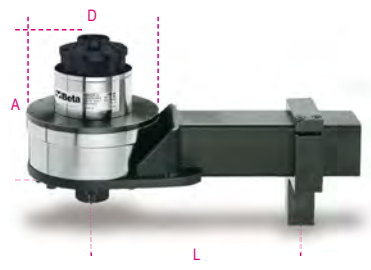

Nm	Kgfm	lbf.ft	□	■	D	A	L min	L max	♁
9500	950	7000	1/2	1 1/2"	mm	mm	mm	mm	kg
					184	210	155	350	32,4

567-5R/VB **Ft** 4.572.100 1 005670615

562VV-A

nyomatéksokszorozó hordozótáska,
 tartós polipropilén, szivacsbélés

Belső méret: 380x270x180 mm



562VV-A **Ft** 90.600 1 005620501

562/1-562/2-564/3R
 564/4R-565/1R-565/2R
 565/3R

☞ 410x340x205 mm - ♁ 3,5 kg

565VV-B

nyomatéksokszorozó hordozótáska,
 tartós polipropilén, szivacsbélés

Belső méret: 480x370x205 mm



565VV-B **Ft** 125.300 1 005650502

565/4R-565/5R
 567/4R-567/5R

☞ 520x435x230 mm - ♁ 5,4 kg



A nyomatékkulcsokat mindig a markolat közepén kell megfogni, hogy ne változhasson meg a erőkar nagysága. Zökkenőmentesen és megszakítás nélkül alkalmazza, kerülje a hirtelen rántásokat.



A beállító skálát használat után nullára kell állítani, hogy ne befolyásolja a következő meghúzás pontosságát.



A Beta a nyomatékkulcsok széles választékát kínálja, négy különböző alap modell segítségével.

MÉRŐTÁRCSÁS MODELLEK

Az alkalmazott meghúzási nyomaték összenyomja a tekercsrugót, és a mérőtárcsa közvetlenül kijelzi az értéket. Az alkalmazott nyomaték valós időben olvasható le a mutató segítségével. Egy második mutató a nyomaték célértékére állítható. Amikor eléri a nyomaték célértékét, a második mutatót a fő mutató megfogja, és rögzíti a csúcserőket. A mérőtárcsás nyomatékkulcsok hosszú időn át nyújtanak figyelemreméltó pontosságot és tartósságot.

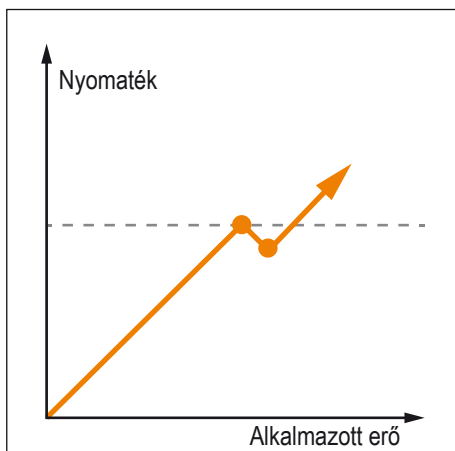

KIOLDÓ MODELLEK

A kioldó nyomatékkulcsok a legnépszerűbb modellek, mert könnyen használhatók. A rugós terhelésnek köszönhetően lehetővé teszik a nyomaték gyors előválasztását. A nyomatékérték az alkalmazott erő növelésével együtt növekszik. Amikor eléri a kívánt nyomatékértéket, hirtelen kioldás következik be, és a kulcs kb. 3-5°-ig nem alkalmaz meghúzási erőt. Ha az eszköz használója nem szakítja meg a mozgást, a nyomaték folyamatosan növekszik, és így túllépi a szükséges értékeket.

ÖNKIOLDÓ MODELLEK

Az önkieldó nyomatékkulcsok a kioldó modellekhez hasonlóan működnek, de a kívánt nyomatékérték elérésekor a kar hirtelen kiold (kb. 20°). Ezáltal a szerszám használója könnyebben abbahagyhatja az erő kifejtést. Ezeket a szerszámokat többnyire magas nyomatékértékekhez használják, rendkívül hosszú karokkal.

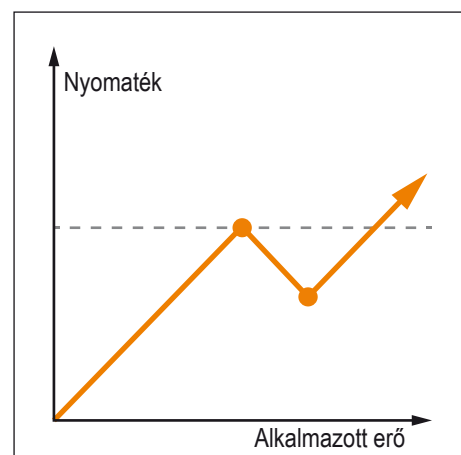
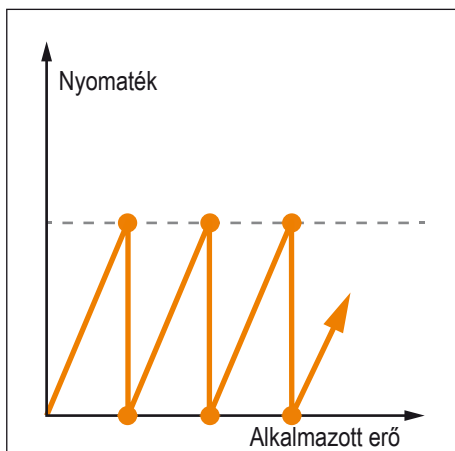

CSÚSZÓ MODELLEK

Az előre beállított nyomatékérték elérésekor a csúszó mechanizmus leállítja a nyomaték alkalmazását, és így a szerszám inaktív lesz. Megakadályozza a szükségesnél magasabb nyomatékértékekkel történő meghúzást. Erő további alkalmazása esetén a ciklus megismétlődik. Ideális eszközök alacsony nyomatékértékű sorrendben végzett műveletekhez (elektronikai és mikromechanikai ipar), ahol rendkívül fontos a törekeny vagy kisméretű alkatrészek törésének elkerülése.

NYOMATÉKULCSOK HÚZÁSI NYOMATÉK TARTOMÁNYA

1 Nm = 0,10197 Kgfm = 0,7375 lbf.ft



Size	Model	Image	Min (Nm)	Max (Nm)	Min (Kgfm)	Max (Kgfm)	Min (lbf.ft)	Max (lbf.ft)
1/4"	590		0,3	4				
	590/1		0,5	13,5				
	603/5		1	5				
	603/10		2	10				
	605E/5		1	5				
	605E/10		2	10				
	666N/2			5	25			
3/8"	592/3		1	27				
	592/4		3	40				
	599DGT/6			12	60			
	665/6			10	60			
	665/10			20	100			
	665LB/6			7 LBF.FT	45 LBF.FT			
	665LB/10			15 LBF.FT	75 LBF.FT			
	666N/2X		5	25				
	666N/5			10	50			
	666N/10			20	100			
	666N LBF.IN/5			90 LBF.IN	440 LBF.IN			
	666N LBF.IN/10			200 LBF.IN	800 LBF.IN			
	668RGC/6			12	60			
	668RGC/10			20	100			
	1/2"	594/8		6	80			
594/21				20	215			
599DGT/10X				20	100			
599DGT/20				40	200			
599DGT/30					68	340		
599DGT-AN/10				20	100			
599DGT-AN/20				40	200			
606MQ/50			5	50				
610/5							90	130
610L/5							90	130
610L/5L							120	200
665/10X				20	100			
665/20				40	200			
665/30				60	330			
665LB/10X				15 LBF.FT	75 LBF.FT			
665LB/20				30 LBF.FT	150 LBF.FT			
665LB/30				45 LBF.FT	240 LBF.FT			
666N/10X				20	100			
666N/20				40	200			
666N/30				60	300			
666N LBF.IN/10X				200 LBF.IN	800 LBF.IN			
666N LBF.IN/20				400 LBF.IN	1800 LBF.IN			
666N LBF.IN/30				500 LBF.IN	3000 LBF.IN			
667N/20				40	200			
667N/30			60	300				
668RGC/10X			20	100				
668RGC/20			40	200				

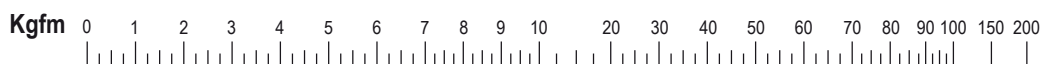

Beta

581

Önkioldó nyomatéksavarhúzó, mérőskála nélkül
Jobb
Pontosság: ±6%
(588 - 682 modellhez)



UNI EN ISO 6789

Nm	gfm	lbf.ft	mm	g
1,2÷6	120÷600	1/4"	275	

581	Ft	1	005810001
	104.600		

583

Önkioldó nyomatéksavarhúzó Jobb
Pontosság: ±6%



UNI EN ISO 6789

Nm	gfm	lbf.ft	mm	g
0,3÷1,5	30÷150	1/4"	240	

583/1,5	Ft	1	005830015
	99.550		

Nm	gfm	lbf.ft	mm	g
0,6÷3	60÷300	1/4"	240	

583/3	Ft	1	005830030
	100.300		

Nm	gfm	lbf.ft	mm	g
1,2÷6	120÷600	1/4"	350	

583/6	Ft	1	005830060
	101.100		

583/C31

1 nyomatéksavarhúzó, 8 hatlapú dugókulcs,
20 csavarhúzóbetét és 2 tartozék

1/4"



583/C31	Ft	1	005830931
	146.500		

583/6	1.2 - 6 Nm
900	4-5-5,5-6-7-8-9-10 mm
860LP	0,6x4,5 - 1x5,5 - 1,2x6,5 mm
860PH	PH1 - PH2 (x2) - PH3
860PE	2-2,5-3-4-5 mm
860TX	T9-T10-T15-T20-T25-T27-T30-T40
882P/80	80 mm
892/0	1/4" 1/4"

270x120x45 mm - 1,2 kg

590 - 592

Mérőtárcsás nyomatékkulcs
Jobbos és balos
Pontosság: ±4%

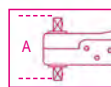

UNI EN ISO 6789

Nm	Kgfm	lbf.in	mm	A mm	L mm	kg
0,3÷4	0,03÷0,4	3÷35	1/4"	60	253	0,52

590	Ft	1	005900001
	266.100		

Nm	Kgfm	lbf.in	mm	A mm	L mm	kg
0,5÷13,5	0,05÷1,35	4÷120	1/4"	60	253	0,52

590/1	Ft	1	005900003
	266.100		

Nm	Kgfm	lbf.in	mm	A mm	L mm	kg
1÷27	0,1÷2,7	10÷240	3/8"	70	253	0,52

592/3	Ft	1	005920005
	264.700		

Nm	Kgfm	lbf.in	mm	A mm	L mm	kg
3÷40	0,3÷4	20÷360	3/8"	70	253	0,52

592/4	Ft	1	005920007
	264.700		

594

Mérőtárcsás nyomatékkulcs
Jobbos és balos
Pontosság: ±4%

12"

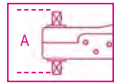

UNI EN ISO 6789

Nm	Kgfm	lbf.ft	mm	A mm	L mm	kg
6÷80	0,6÷8	5÷60	1/2"	85	455	1,35

594/8	Ft	1	005940011
	404.200		

Nm	Kgfm	lbf.ft	mm	A mm	L mm	kg
20÷215	2÷21,5	15÷160	1/2"	85	530	1,40

594/21	Ft	1	005940015
	404.200		

Nyomatékkulcs-kalibrálással kapcsolatos információk az árlista végén található!

596 - 598

Mérőtárcsás nyomatékkulcs
Jobbos és balos
Pontosság: ±4%

A meghatározott meghúzási nyomaték elérésekor fényjelzéssel kívül hangjelzést is ad.



UNI EN ISO 6789

Nm	Kgfm	lbf.ft	mm	A mm	L mm	kg
80÷400	8÷40	60÷300	3/4"	111	710	3,2

596/40SL	Ft	1	005960010
	708.500		

Nm	Kgfm	lbf.ft	mm	A mm	L mm	kg
160÷800	16÷80	120÷600	3/4"	115	1025	4,85

596/80SL	Ft	1	005960020
	851.300		

Nm	Kgfm	lbf.ft	mm	A mm	L mm	kg
200÷2000	20÷200	150÷1500	1"	135	1930	16,70

598/200SL	Ft	1	005980022
	1.764.700		

Beta

Quality Tools

Beta

599DGT

elektronikus nyomatékkulcs
irányváltós racsnival
meghúzási pontosság +/- 2% jobb irányban,
± 3% bal irányban

- Kettős mérési mód: csúcs és maradvány
- A beállított nyomaték elérését fényjelzések és egy szaggatott hangjelzés mutatja
- Tápfeszültség 2 db 1,5V elemmel (együtt szállítva)



UNI EN ISO 6789

Nm	Kgfm	lbf.ft	■	D	A	L	■
12÷60	1,2÷6	8÷44	3/8	30	33	413	0,9

Ft		■	■
599DGT/6	133.100	1	005990003

Nm	Kgfm	lbf.ft	■	D	A	L	■
20÷100	2÷10	15÷80	1/2	30	37	413	0,9

Ft		■	■
599DGT/10X	135.400	1	005990010

Nm	Kgfm	lbf.ft	■	D	A	L	■
40÷200	4÷20	30÷150	1/2	40	43	520	2

Ft		■	■
599DGT/20	138.900	1	005990020

Nm	Kgfm	lbf.ft	■	D	A	L	■
68÷340	6,8÷34	58÷280	1/2	40	43	640	2,35

Ft		■	■
599DGT/30	146.100	1	005990030

599DGT-AN

elektronikus nyomatékkulcs nyomaték és szög
leolvasással
irányváltós racsnival,
jobbírányú (+/- 2% pontosság)
és balírányú (+/- 3% pontosság) meghúzáshoz

- Meghúzási típusok: nyomaték, szög, nyomaték + szög
- Meghúzási stratégia: nyomaték és szög
- Kettős mérési mód: csúcs és maradvány
- A beállított nyomaték vagy szög elérését fényjelzések és egy szaggatott hangjelzés mutatja
- A meghúzási adatok memóriába rögzítése (legfeljebb 250 értékig)
- 9 előre beállítható nyomaték/szög érték
- Tűrőhatár érték beállítási lehetőség saját igény szerint; ennek meghaladása esetén a kulcs jelez a felhasználónak
- Biztonsági gombreteszelés
- A nyomatékkulcs felhasználói azonosító segítségével 16 felhasználóhoz társítható
- Követhető meghúzási adatok. A szoftver lehetővé teszi a dátum és az időpont, a szerszám sorozatszáma, a beállított meghúzási érték, az elért érték rögzítését, és a felhasználói azonosítóhoz társítását
- Csúszásgátló bimateriális nyél
- A következő tartozékokkal: 2 db AA elem - 1,5V, USB kábel és szoftver



UNI EN 26789
ISO 6789

Nm	Kgfm	lbf.ft	■	D	A	L	■
20÷100	2÷10	15÷80	1/2	30	33	413	0,9

Ft		■	■
599DGT-AN/10	270.900	1	005990610

Nm	Kgfm	lbf.ft	■	D	A	L	■
40÷200	4÷20	30÷150	1/2	40	43	520	1,3

Ft		■	■
599DGT-AN/20	284.000	1	005990620

Nyomatékkulcs-kalibrálással kapcsolatos információk az árlista végén található!



600

Nyomatékszögmérő



	□	■	Ft	■	■
600/1	1/2	1/2	57.500	1	006000001
600/2	3/4	3/4	62.750	1	006000002

601C

Digitális szögmérő szögértékes meghúzáshoz
Az előre beállított szögérték elérését fény- és szaggatott hangjelzés kíséri.
az előre beállított szögérték elérését fényjelzés és szaggatott hangjelzés mutatja



Ft		■	■
601C	69.400	1	006010100

85x80x87 mm - 70 g

601CA

digitális szögmérő nyomaték
és szögérték meghúzáshoz
az előre beállított nyomaték vagy szögérték elérését fényjelzés és egy szaggatott hangjelzés mutatja



	□	■	Nm	Ft	■	■
601CA	1/2"	1/2"	10÷200	138.300	1	006010120

120x90x120 mm - 240 g

603

Önkioldó nyomatékkulcs
Jobbos
Pontosság: ±6%



UNI EN ISO 6789

Nm	Kgfm	lbf.in	■	A mm	L mm	g
1÷5	0,1÷0,5	10÷45	1/4	35	195	235

603/5 Ft 230.900 1 006030005

Nm	Kgfm	lbf.in	■	A mm	L mm	g
2÷10	0,2÷1,0	18÷90	1/4	35	195	235

603/10 Ft 237.300 1 006030010

604B

Önkioldó nyomatékkulcs
jobb- és bal forgásirányú
pontosság: ± 6%



UNI EN ISO 6789

Nm	kgfm	lbf.in	∅ mm	L mm	g
1÷5	0,1÷0,5	10÷45	8	220	290

604B/5 Ft 158.600 1 006040015

Nm	Kgfm	lbf.in	∅ mm	L mm	g
2÷10	0,2÷1,0	18÷90	8	220	300

604B/10 Ft 158.600 1 006040020

605E

Kioldó nyomatékkulcs
Írányváltós racsnival
Jobb és bal oldali meghúzáshoz
Pontosság: ± 6%



UNI EN ISO 6789

Nm	Kgfm	lbf.in	■	A mm	L mm	g
1÷5	0,1÷0,5	10÷45	1/4	20	190	180

605E/5 Ft 72.700 1 006050105

Nm	Kgfm	lbf.in	■	A mm	L mm	g
2÷10	0,2÷1,0	18÷90	1/4	20	190	180

605E/10 Ft 75.450 1 006050110

610/5

kioldó nyomatékkulcs
írányváltós racsnival
jobb oldali meghúzáshoz,
5 beállított értékkel,
meghúzási pontosság: ± 4%

Választható nyomatékértékek:
90 - 100 - 110 - 120 - 130 Nm



UNI EN ISO 6789

Nm	■	D mm	A mm	L mm	g
90÷130	1/2	42	39	490	1330

610/5 Ft 63.900 1 006100025

610L/5

kioldó nyomatékkulcs
L-formájú karral
jobb oldali meghúzáshoz,
5 beállított értékkel,
meghúzási pontosság: ± 4%

Választható nyomatékértékek:
90 - 100 - 110 - 120 - 130 Nm



UNI EN ISO 6789

Nm	■	L mm	L1 mm	g
90÷130	1/2	470	80	1350

610L/5 Ft 56.750 1 006100125

610L/5L

kioldó nyomatékkulcs
L-formájú karral,
jobb oldali meghúzáshoz,
5 beállított értékkel,
meghúzási pontosság: ± 4%

Választható nyomatékértékek:
120 - 140 - 160 - 180 - 200 Nm



UNI EN ISO 6789

Nm	■	L mm	L1 mm	g
120÷200	1/2	470	80	1400

610L/5L Ft 60.700 1 006100150

611

Kettős működésű racsni
a 604B/5 és a 604B/10 modellhez
Külső négyszög: 8 mm



■ 1/4 L mm 42,5 Ft 56.150 1 006110001

Nyomatékkulcs-kalibrálással kapcsolatos információk az árlista végén található!

612 ÷ 614

Írányváltós racsni Ø 16 mm csatlakozóval
rendelkező nyomatékkulcshoz



612 és 612X nem használható 100 Nm feletti meghúzási nyomatéknál

	■	L mm	LA mm	Ft	■	■
612	3/8	66	32	21.900	2	006120000
612X	1/2	66	32	22.800	2	006120010
614	1/2	71	32	26.150	2	006140000
614X	3/4	71	32	27.150	2	006140004

614/50

Átnyomás racsni
Ø 16 mm csatlakozóval rendelkező
nyomatékkulcshoz



■ 1/2 L mm 71 LA mm 32 Ft 25.650 2 006140002

Nyomatékkulcs csatlakozási méretei,
lásd a táblázatot a 929/C8 cikkszám alatt!

615

kétirányú racsni nyomatékulcsokhoz szögletes csatlakozóval



mm	mm	L mm	LA mm	Ft		
9x12	3/8	53	28,8	18.650	1	006150010
9x12	1/2	53	28,8	18.650	1	006150020
14x18	1/2	70	39,8	18.650	1	006150120

616 - 617 - 619

Fix négyzet fej Ø 16 mm nyomatékulcsokhoz



mm	mm	L mm	LA mm	Ft		
616	1/4	61	32	18.800	1	006160000
617	3/8	61	32	18.800	1	006170000
619	1/2	63	32	18.800	1	006190000

621

betéttartó tartozék nyomatékulcsokhoz szögletes csatlakozóval



P	mm	mm	L mm	LA mm	Ft		
P 1/4	9x12	1/4	43	28,8	25.000	1	006210000
* P 5/16	14x18	5/16	52,5	32,5	38.400	1	006210110

"Figyelem! Számítsa ki újra a beállítandó nyomaték értékét az árlista alján található táblázat alapján"

622

megfordítható racsni nyomatékulcsokhoz, kerek fejű, Ø 22 mm



mm	mm	L mm	LA mm	Ft		
622 3/4	3/4	110	56	64.350	1	006220019
622 1	1	110	56	78.600	1	006220024

641

Villáskulcs fejek a 604B/5 és a 604B/10 modellhez Külső négyzet: 8 mm



mm	L mm	Ft		
4	37	30.950	1	006410003
5	37	30.950	1	006410004
5,5	37	30.950	1	006410005
6	37	30.950	1	006410006
7	37	30.950	1	006410007
8	42	30.950	1	006410008
9	42	30.950	1	006410009
10	42	30.950	1	006410010

642

Villáskulcsfejek



mm	L mm	LA mm	A mm	Ft		
8	54	32	22	20.900	1	006420008
10	57	32	26	20.900	1	006420010
12	58	32	30	20.900	1	006420012
13	58	32	30	20.900	1	006420013
14	59	32	32	20.900	1	006420014
15	59	32	35	20.900	1	006420015
16	59	32	38	20.900	1	006420016
17	60	32	39	20.900	1	006420017
18	61	32	42	20.900	1	006420018
19	61	32	43	20.900	1	006420019
20	61	32	50	37.750	1	006420020
21	62	32	53	37.750	1	006420021
22	62	32	53	39.550	1	006420022
23	65	32	53	39.550	1	006420023
24	63	32	53	39.550	1	006420024
26	64	32	59	49.250	1	006420026
27	65	32	59	49.250	1	006420027
28	66	32	64	49.250	1	006420028
30	66	32	66	49.250	1	006420030
32	67	32	66	49.250	1	006420032
* 36	76	42	80	70.200	1	006420036
* 40	77	52	95	70.200	1	006420040
* 41	78	52	95	70.200	1	006420041
* 46	90	52	95	84.250	1	006420046

"Figyelem! Számítsa ki újra a beállítandó nyomaték értékét az árlista alján található táblázat alapján"

643

villáskulcs nyomatékulcsokhoz szögletes csatlakozóval



mm	mm	L mm	LA mm	Ft		
7	9x12	37	28,8	8.190	1	006430007
8	9x12	37	28,8	8.190	1	006430008
10	9x12	39	28,8	8.190	1	006430010
12	9x12	39	28,8	8.190	1	006430012
13	9x12	39	28,8	8.190	1	006430013
14	9x12	43	28,8	8.460	1	006430014
15	9x12	43	28,8	8.460	1	006430015

"Figyelem! Számítsa ki újra a beállítandó nyomaték értékét az árlista alján található táblázat alapján"

mm	mm	L mm	LA mm	Ft		
16	9x12	43	28,8	8.460	1	006430016
17	9x12	43	28,8	8.460	1	006430017
* 18	9x12	47	36,3	8.460	1	006430018
* 19	9x12	51	36,3	8.460	1	006430019
* 21	9x12	52	36,3	13.350	1	006430021
* 22	9x12	52	36,3	13.350	1	006430022

"Figyelem! Számítsa ki újra a beállítandó nyomaték értékét az árlista alján található táblázat alapján"

mm	mm	L mm	LA mm	Ft		
13	14x18	60	39,8	8.880	1	006430113
14	14x18	58	39,8	8.880	1	006430114
15	14x18	60	39,8	8.880	1	006430115
16	14x18	60	39,8	9.230	1	006430116
17	14x18	60	39,8	9.230	1	006430117
18	14x18	61	39,8	9.230	1	006430118
19	14x18	61	39,8	9.230	1	006430119
21	14x18	61	39,8	14.500	1	006430121
22	14x18	62	39,8	14.500	1	006430122
24	14x18	64	39,8	14.500	1	006430124
* 27	14x18	68	44,8	16.250	1	006430127
* 30	14x18	77	49,8	17.300	1	006430130
* 32	14x18	77	49,8	17.300	1	006430132
* 34	14x18	80	54,8	26.450	1	006430134
* 36	14x18	83	54,8	26.450	1	006430136
* 38	14x18	83	54,8	26.450	1	006430138
* 41	14x18	91	64,8	26.450	1	006430141

"Figyelem! Számítsa ki újra a beállítandó nyomaték értékét az árlista alján található táblázat alapján"

644

villáskulcsfejek nyomatékulcsokhoz, kerek fejű, Ø 22 mm



mm	L mm	LA mm	A mm	Ft		
22	91	56	52	39.550	1	006440022
24	91	56	52	39.550	1	006440024
27	94	56	64	49.250	1	006440027
30	94	56	64	49.250	1	006440030
32	97	56	75,5	49.250	1	006440032
34	97	56	75,5	49.250	1	006440034
36	97	56	75,5	70.200	1	006440036
41	103,5	56	94	70.200	1	006440041
46	115,5	56	94	84.250	1	006440046

650A

állítható villáskulcs nyomatékulcsokhoz szögletes csatlakozóval



A min-max mm	mm	L mm	LA mm	Ft		
* 5-27	9x12	93	74,3	34.150	1	006500027
* 5-30	9x12	106	85,3	34.150	1	006500030
* 5-30	14x18	115	89	34.700	1	006500130
* 10-41	14x18	127	100	35.750	1	006500141

"Figyelem! Számítsa ki újra a beállítandó nyomaték értékét az árlista alján található táblázat alapján"

650H

körmöskulcs
nyomatékkulcshoz
szögletes csatlakozóval



mm	mm	L mm	LA mm	Ft		
* 28-36	14x18	122	92	17.800	1	006500928
* 40-45	14x18	129	92	17.800	1	006500940
* 50-55	14x18	129	92	17.800	1	006500950
* 58-62	14x18	135	92	19.050	1	006500958
* 68-75	14x18	139	92	20.950	1	006500968
* 80-90	14x18	145	92	20.950	1	006500980

"Figyelem! Számítsa ki újra a beállítandó nyomaték értékét az árlista alján található táblázat alapján"

652

Csillagkulcsfejek



mm	L mm	LA mm	Ft		
8	58	32	21.300	1	006520008
10	58	32	21.300	1	006520010
12	58	32	21.300	1	006520012
13	58	32	21.300	1	006520013
14	58	32	21.300	1	006520014
15	62	32	21.300	1	006520015
16	63	32	21.300	1	006520016
17	64	32	21.300	1	006520017
18	65	32	21.300	1	006520018
19	65	32	21.300	1	006520019
21	67	32	37.800	1	006520021
22	68	32	37.600	1	006520022
24	69	32	51.300	1	006520024
26	71	32	51.450	1	006520026
27	71	32	51.450	1	006520027
30	73	32	51.450	1	006520030
32	74	32	51.450	1	006520032

653

csillagkulcs
nyomatékkulcshoz
szögletes csatlakozóval



mm	mm	L mm	LA mm	Ft		
7	9x12	40	28,8	8.870	1	006530007
8	9x12	40	28,8	8.870	1	006530008
10	9x12	43	28,8	8.870	1	006530010
12	9x12	44	28,8	8.870	1	006530012
13	9x12	44	28,8	8.870	1	006530013
14	9x12	45	28,8	8.870	1	006530014
15	9x12	46	28,8	8.870	1	006530015
16	9x12	47	28,8	9.220	1	006530016
17	9x12	47	28,8	9.220	1	006530017
18	9x12	48	28,8	9.220	1	006530018
19	9x12	49	28,8	9.220	1	006530019
21	9x12	51	28,8	9.620	1	006530021
22	9x12	51	28,8	9.620	1	006530022

mm	mm	L mm	LA mm	Ft		
13	14x18	61	39,8	10.000	1	006530113
14	14x18	61	39,8	10.000	1	006530114
15	14x18	62	39,8	10.000	1	006530115
16	14x18	63	39,8	10.400	1	006530116

"Figyelem! Számítsa ki újra a beállítandó nyomaték értékét az árlista alján található táblázat alapján"

mm	mm	L mm	LA mm	Ft		
17	14x18	64	39,8	10.400	1	006530117
18	14x18	64	39,8	10.400	1	006530118
19	14x18	66	39,8	10.400	1	006530119
21	14x18	66	39,8	15.150	1	006530121
22	14x18	67	39,8	15.150	1	006530122
24	14x18	69	39,8	18.700	1	006530124
* 27	14x18	76	44,8	18.700	1	006530127
* 30	14x18	77	44,8	18.700	1	006530130
* 32	14x18	79	44,8	18.700	1	006530132
* 34	14x18	80	44,8	26.450	1	006530134
* 36	14x18	80	44,8	26.450	1	006530136
* 38	14x18	90	49,8	26.400	1	006530138
* 41	14x18	90	49,8	26.400	1	006530141

"Figyelem! Számítsa ki újra a beállítandó nyomaték értékét az árlista alján található táblázat alapján"

654

csillagkulcsfejek
nyomatékkulcshoz,
kerek fejű, Ø 22 mm



mm	L mm	LA mm	A mm	Ft		
22	98,5	56	38	37.600	1	006540022
24	98,5	56	38	51.300	1	006540024
27	102,8	56	46,5	51.450	1	006540027
30	102,8	56	46,5	51.450	1	006540030
32	106,5	56	55	51.450	1	006540032
34	106,5	56	55	51.450	1	006540034
36	106,5	56	55	66.800	1	006540036
41	115,5	56	72	66.800	1	006540041
46	115,5	56	72	72.200	1	006540046

659/15

szűkítő közbetét belső (14x18 mm) és külső (9x12 mm)



mm	mm	mm	LA mm	Ft		
* 56	14x18	9x12	39	27.450	1	006590815

"Figyelem! Számítsa ki újra a beállítandó nyomaték értékét az árlista alján található táblázat alapján"



Ügyeljünk a forgató nyomatékra, fokozatosan növeljük, hogy a törést, illetve az esetleges sérülést elkerüljük.

659/16

Bővítő közbetét belső (9x12 mm) és külső (14x18 mm)



mm	mm	mm	LA mm	Ft		
* 52	9x12	14x18	31	23.850	1	006590816

"Figyelem! Számítsa ki újra a beállítandó nyomaték értékét az árlista alján található táblázat alapján"

Beta

665 TÍPUSÚ MECHANIKUS NYOMATÉKKULCS DIGITÁLIS KIJELEZŐVEL

A 665-ös típusú nyomatékulcs a Beta kipróbált mechanizmusának és bevált racsniainak tartósságát és megbízhatóságát ötvözi a gyors és pontos digitális mérési rendszerrel.



MEGBÍZHATÓSÁG

A robusztus Beta racsni egyenletes mozgást biztosít, felvételi szöge kisebb, mint 5°.

PONTOSSÁG

A szabvány előírásaihoz képest ± 3%-kal nagyobb pontosság.

EGYENLETES MOZGÁS

A racsni mechanizmus könnyebb mozdulatokat és nagyobb pontosságot eredményez.

DIGITÁLIS KIJELEZŐ

Egyszerűbb a nyomatékérték beállítása és leolvasása.

**HOSSZÚ
ÉLETTARTAM**

KALIBRÁLÁS

A kalibrálás a csavarkulcs bontása nélkül több ponton történik, ezzel kiküszöbölhető a rugó nem lineáris viselkedése, amely mérése a Beta 682-es típusú nyomatékmérőjével történik.

GYORSASÁG

Gyors, hatékony nyomatékbeállítás.

**GYORS, PONTOS DIGITÁLIS
NYOMATÉKBEÁLLÍTÁS**

665

mechanikus nyomatékulcs digitális kijelzővel és megfordítható racsniával, jobbos, nyomaték pontosság: ± 3%

- Minimális nyomaték határérték alatt 10" után automatikusan lekapcsol
 - A kijelző a beállított nyomatékértékkel bekapcsolva marad
 - Nyomatékkijelzés 0.1%
- Tápellátás: 1 db 3V elem (a csomag tartalma)



UNI EN ISO 6789

Nm	■	D mm	A mm	L mm	g	
10÷60	3/8	30	33	335	655	
					Ft	
665/6					77.350	1 006650006
Nm	■	D mm	A mm	L mm	g	
20÷100	3/8	30	33	375	725	
					Ft	
665/10					77.950	1 006650010
Nm	■	D mm	A mm	L mm	g	
20÷100	1/2	30	37	375	725	
					Ft	
665/10X					78.600	1 006650011
Nm	■	D mm	A mm	L mm	g	
40÷200	1/2	40	43	470	995	
					Ft	
665/20					85.750	1 006650020
Nm	■	D mm	A mm	L mm	g	
60÷330	1/2	40	43	590	1260	
					Ft	
665/30					100.100	1 006650030



665LB

mechanikus nyomatékulcus digitális kijelzővel és irányváltó racsnival, jobbcs, nyomaték pontosság: $\pm 3\%$

- Mértékegység: lbf.ft
- Könnyen leolvasható értékek a kijelzőn
- A kijelző a beállított nyomatékértékkel bekapcsolva marad
- Nyomatékjelzés 0.1 mm
- 30 mp után a legkisebb határérték alatti nyomatékbeállítással automatikusan kikapcsol
- Tápellátás: 1 db 3V elem (a csomag tartalma)



UNI EN ISO 6789

lbf.ft	mm	D	A	L	g
7÷45	3/8	30	33	335	655

lbf.ft	mm	D	A	L	g
15÷75	3/8	30	33	375	725

lbf.ft	mm	D	A	L	g
15÷75	1/2	30	37	375	725

lbf.ft	mm	D	A	L	g
30÷150	1/2	40	43	470	995

lbf.ft	mm	D	A	L	g
45÷240	1/2	40	43	590	1260

lbf.ft	mm	D	A	L	g
60÷300	1/2	40	43	581	1380

lbf.ft	mm	D	A	L	g
60÷300	3/8	25	29	220	300

lbf.ft	mm	D	A	L	g
60÷300	3/8	25	29	220	300

lbf.ft	mm	D	A	L	g
60÷300	3/8	25	29	220	300

lbf.ft	mm	D	A	L	g
60÷300	3/8	25	29	220	300

665SW

Az eszköz lehetővé teszi a 665 nyomatékulcus kalibrálását a 680 és 682 nyomaték mérővel a csavarkulcus bontása nélkül.

- Az eszköz lehetővé teszi a 665 csavarkulcus kalibrálását a 680 és 682 nyomaték mérővel a csavarkulcus bontása nélkül.
- A kalibrálás több ponton történik, ezzel kiküszöbölhető a rugó nem lineáris viselkedése.
- Mikro USB csatlakozóval firmware frissítésekhez.



lbf.ft	mm	D	A	L	g
60÷300	3/8	25	29	220	300

666N TÍPUSÚ KIOLDÓ NYOMATÉKKULCSOK



A 17 összekapcsolódó fog kiváló erőelosztást tesz lehetővé



Nagyobb skála a még könnyebb láthatóság és a pontosabb beállítás érdekében.



A markolat és a lencse anyaga ellenáll az autópárhán, az iparban és a repülésben használt összes vegyi anyagnak.



Rendkívül gyors nyomatékbeállítás. Az o-gyűrű piros színe jelzi a kulcs kioldott állapotát, amikor a nyomaték beállítható.

666N

Kioldó nyomatékulcus
Irányváltós racsnival
Jobb oldali meghúzáshoz
Pontosság $\pm 3\%$



UNI EN ISO 6789

Nm	Kgfm	lbf.ft	mm	D	A	L	g
5÷25	0,5÷2,5	4÷18	1/4	25	29	220	300

Nm	Kgfm	lbf.ft	mm	D	A	L	g
5÷25	0,5÷2,5	4÷18	3/8	25	29	220	300

Nm	Kgfm	lbf.ft	mm	D	A	L	g
10÷50	1÷5	7÷37	3/8	30	33	325	660

Nm	Kgfm	lbf.ft	mm	D	A	L	g
20÷100	2÷10	15÷75	1/2	30	37	367	800

Nm	Kgfm	lbf.ft	mm	D	A	L	g
20÷100	2÷10	15÷75	1/2	30	37	367	800

Nm	Kgfm	lbf.ft	mm	D	A	L	g
40÷200	4÷20	30÷150	1/2	40	43	465	1010

Nm	Kgfm	lbf.ft	mm	D	A	L	g
60÷300	6÷30	50÷220	1/2	40	43	581	1380

Nm	Kgfm	lbf.ft	mm	D	A	L	g
60÷300	6÷30	50÷220	1/2	40	43	581	1380

Nm	Kgfm	lbf.ft	mm	D	A	L	g
60÷300	6÷30	50÷220	1/2	40	43	581	1380

Nm	Kgfm	lbf.ft	mm	D	A	L	g
60÷300	6÷30	50÷220	1/2	40	43	581	1380

Nm	Kgfm	lbf.ft	mm	D	A	L	g
60÷300	6÷30	50÷220	1/2	40	43	581	1380

Nm	Kgfm	lbf.ft	mm	D	A	L	g
60÷300	6÷30	50÷220	1/2	40	43	581	1380

Nm	Kgfm	lbf.ft	mm	D	A	L	g
60÷300	6÷30	50÷220	1/2	40	43	581	1380

Nm	Kgfm	lbf.ft	mm	D	A	L	g
60÷300	6÷30	50÷220	1/2	40	43	581	1380

Nm	Kgfm	lbf.ft	mm	D	A	L	g
60÷300	6÷30	50÷220	1/2	40	43	581	1380

Nm	Kgfm	lbf.ft	mm	D	A	L	g
60÷300	6÷30	50÷220	1/2	40	43	581	1380

Nm	Kgfm	lbf.ft	mm	D	A	L	g
60÷300	6÷30	50÷220	1/2	40	43	581	1380

Nm	Kgfm	lbf.ft	mm	D	A	L	g
60÷300	6÷30	50÷220	1/2	40	43	581	1380



666N LBF.IN

Kioldó nyomatékkulcs
Írányváltós racsnival
Jobb oldali meghúzáshoz
Pontosság $\pm 4\%$
• Font-erő per hüvelyk skála



UNI EN ISO 6789

lbf.in	mm	D	A	L	g
90÷440	3/8	30	33	325	660

Ft	g
78.350	1 006660055

lbf.in	mm	D	A	L	g
200÷900	3/8	30	33	367	730

Ft	g
79.000	1 006660070

lbf.in	mm	D	A	L	g
200÷900	1/2	30	37	367	800

Ft	g
79.650	1 006660071

lbf.in	mm	D	A	L	g
400÷1800	1/2	40	43	465	1010

Ft	g
86.700	1 006660072

lbf.in	mm	D	A	L	g
500÷3000	1/2	40	43	581	1380

Ft	g
100.900	1 006660073

667N

Kioldó nyomatékkulcs
Racsnival
Jobb és bal oldali meghúzáshoz
Pontosság $\pm 3\%$

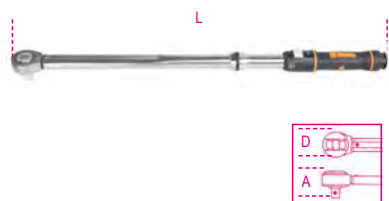

UNI EN ISO 6789

Nm	Kgfm	lbf.ft	mm	D	A	L	g
40÷200	4÷20	30÷150	1/2	40	43	465	1010

Ft	g
87.100	1 006670020

Nm	Kgfm	lbf.ft	mm	D	A	L	g
60÷300	6÷30	50÷220	1/2	40	43	581	1380

Ft	g
98.350	1 006670030

Nm	Kgfm	lbf.ft	mm	D	A	L	g
80÷400	8÷40	60÷295	3/4	50	50	687	2090

Ft	g
246.800	1 006670040

Nyomatékkulcs csatlakozási méretei,
lásd a táblázatot a 929/C8 cikkszám alatt!

668N

Kioldó hengeres nyomatékkulcs
Jobb és bal oldali meghúzáshoz
Pontosság $\pm 3\%$



UNI EN ISO 6789

Nm	Kgfm	lbf.ft	Ø	L	LB	LS	g
5÷25	0,5÷2,5	4÷18	16	220	148	32	300

Ft	g
87.800	1 006680002

Nm	Kgfm	lbf.ft	Ø	L	LB	LS	g
10÷50	1÷5	7÷37	16	307	229	32	590

Ft	g
84.900	1 006680005

Nm	Kgfm	lbf.ft	Ø	L	LB	LS	g
20÷100	2÷10	15÷75	16	376	269	32	670

Ft	g
85.600	1 006680010

Nm	Kgfm	lbf.ft	Ø	L	LB	LS	g
40÷200	4÷20	30÷150	16	450	352,6	32	795

Ft	g
90.550	1 006680020

Nm	Kgfm	lbf.ft	Ø	L	LB	LS	g
60÷300	6÷30	50÷220	16	588	475,9	32	1230

Ft	g
102.900	1 006680030

668RG

Nyomatékkulcs hangjelzéssel,
mérőskála nélkül
Jobb és bal oldali meghúzáshoz
Pontosság: $\pm 4\%$
(680 - 682 modellhez)



UNI EN ISO 6789

Nm	Kgfm	lbf.ft	Ø	L	g
8÷60	0,8÷6	6÷44	16	288	550

Ft	g
69.050	1 006680206

Nm	Kgfm	lbf.ft	Ø	L	g
20÷100	2÷10	15÷80	16	315	600

Ft	g
71.000	1 006680210

Nm	Kgfm	lbf.ft	Ø	L	g
40÷200	4÷20	30÷150	16	405	780

Ft	g
75.600	1 006680220

Nm	Kgfm	lbf.ft	Ø	L	g
60÷300	6÷30	50÷220	16	645	1130

Ft	g
84.350	1 006680230

668RGC

Kioldó nyomatékkulcs,
mérőskála nélkül,
Jobb oldali meghúzáshoz,
Pontosság: $\pm 4\%$
(a 680/40 - 682 modellekhez)



UNI EN ISO 6789

Nm	Kgfm	lbf.in	mm	D	A	L	g
12÷60	1,2÷6	5÷45	3/8	30	33	295	600

Ft	g
63.000	1 006680406

Nm	Kgfm	lbf.in	mm	D	A	L	g
20÷100	2÷10	15÷75	3/8	30	33	335	700

Ft	g
65.850	1 006680410

Nm	Kgfm	lbf.in	mm	D	A	L	g
20÷100	2÷10	15÷75	1/2	40	43	342	700

Ft	g
65.850	1 006680411

Nm	Kgfm	lbf.in	mm	D	A	L	g
40÷200	4÷20	30÷150	1/2	40	43	425	1000

Ft	g
67.100	1 006680420



Beta

669N

Kioldó hengeres nyomatékkulcs,
szögletes csatlakozó

Jobb és bal oldali meghúzáshoz

Pontosság $\pm 3\%$



UNI EN ISO 6789

Nm	Kgfm	lbf.ft	□ mm	L mm	LB mm	LS mm	g
5÷25	0,5÷2,5	4÷18	9x12	215	140	28,8	300

669N/2		Ft	1	006690202
		136.100		

Nm	Kgfm	lbf.ft	□ mm	L mm	LB mm	LS mm	g
10÷50	1÷5	7÷37	9x12	307	226,8	28,8	590

669N/5		Ft	1	006690205
		102.800		

Nm	Kgfm	lbf.ft	□ mm	L mm	LB mm	LS mm	g
20÷100	2÷10	15÷75	9x12	376	266,8	28,8	670

669N/10		Ft	1	006690210
		111.000		

Nm	Kgfm	lbf.ft	□ mm	L mm	LB mm	LS mm	g
40÷200	4÷20	30÷150	9x12	450	345,6	28,8	795

669N/20		Ft	1	006690220
		132.000		

Nm	Kgfm	lbf.ft	□ mm	L mm	LB mm	LS mm	g
40÷200	4÷20	30÷150	14x18	450	351	39,8	795

669N/20X		Ft	1	006690221
		138.900		

Nm	Kgfm	lbf.ft	□ mm	L mm	LB mm	LS mm	g
60÷300	6÷30	50÷220	14x18	588	468,5	39,8	1230

669N/30		Ft	1	006690230
		146.600		

Nm	Kgfm	lbf.ft	□ mm	L mm	LB mm	LS mm	g
80÷400	8÷40	60÷295	14x18	664	563	39,8	2100

669N/40		Ft	1	006690240
		166.200		

671B/C5

1 nyomatékkulcs 604B/5, 1 irányváltós racsní,
8 hatlapú dugókulcs és 4 villáskulcs

14" $\varnothing 8$



671B/C5		Ft	1	006710001
		359.400		

604B/5	1÷5 Nm
611	1/4
641	5-6-7-8 mm
900	4-5-5,5-6-7-8-9-10 mm

270x120x45 mm - 1,3 kg

671B/C10

1 nyomatékkulcs 604B/10, 1 irányváltós
racsní, 8 hatlapú-dugókulcs és 4 villáskulcs

14" $\varnothing 8$



671B/C10		Ft	1	006710002
		359.400		

604B/10	2÷10 Nm
611	1/4
641	6-7-8-10 mm
900	4-5-5,5-6-7-8-9-10 mm

270x120x45 mm - 1,4 kg

671N/C10

668N/10 hengeres nyomatékkulcs
és tartozékai

3/8" $\varnothing 16$



671N/C10		Ft	1	006710110
		378.700		

668N/10	100 Nm
612	■ 3/8
617	■ 3/8
642	10-13-14-17-19 mm
652	10-13-14-17-19 mm
910A	□ 3/8 8-10-11-13-14-17-19 mm
910/21	125 mm
910/22	250 mm

400x180x45 mm - 4,3 kg

671N/C20

668N/20 hengeres nyomatékkulcs
és tartozékai

12" $\varnothing 16$



671N/C20		Ft	1	006710120
		395.500		

668N/20	200 Nm
614	■ 1/2
619	■ 1/2
642	10-13-14-17-19 mm
652	10-13-14-17-19 mm
920A	□ 1/2 10-11-13-14-17-19-22 mm
920/20	75 mm
920/21	125 mm
920/22	255 mm

510x180x45 mm - 5,5 kg

671N/C30

668N/30 hengeres nyomatékkulcs
és tartozékai

12" $\varnothing 16$



671N/C30		Ft	1	006710130
		370.900		

668N/30	300 Nm
614	■ 1/2
619	■ 1/2
642	13-14-17-19 mm
652	13-14-17-19 mm
920A	□ 1/2 13-14-17-19-22-24-27 mm
920/20	75 mm
920/21	125 mm
920/22	255 mm

620x180x45 mm - 5,8 kg

Beta

Beta

674/C

Kioldó nyomatékulcs,
kerek fejű Ø 22 mm,
Jobb és bal oldali meghúzáshoz
Pontosság: ± 4%,
Tokban szállítva.



UNI EN ISO 6789

Nm	Kgfm	lbf.ft	Ø mm	L mm	LB mm	LS mm	kg
100÷500	10÷50	80÷400	22	786	725	56	3,4

Ft		1	
674/C50	227.800	1	006740005

Nm	Kgfm	lbf.ft	Ø mm	L mm	LB mm	LS mm	kg
160÷800	16÷80	120÷600	22	997	915	56	4,5

Ft		1	
674/C80	274.300	1	006740008

Nm	Kgfm	lbf.ft	Ø mm	L mm	LB mm	LS mm	kg
200÷1000	20÷100	150÷750	22	997	915	56	4,5

Ft		1	
674/C100	247.700	1	006740010

677

önkioldó nyomatékulcsok
átnyomás racsával
jobb- és bal irányú meghúzáshoz
pontosság: ± 4%

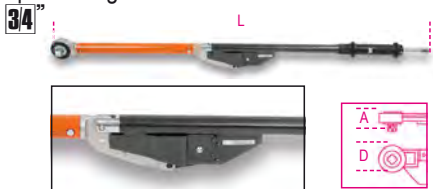

UNI EN ISO 6789

Nm	Kgfm	lbf.ft	D mm	A mm	L mm	kg
120÷600	12÷60	100÷450	69	55	1059	6,0

Ft		1	
677/600	302.800	1	006770006

Nm	Kgfm	lbf.ft	D mm	A mm	L mm	kg
200÷800	20÷80	150÷600	69	55	1319	6,7

Ft		1	
677/800	317.300	1	006770008

Nm	Kgfm	lbf.ft	D mm	A mm	L mm	kg
300÷1000	30÷100	200÷750	69	55	1554	7,4

Ft		1	
677/1000	332.300	1	006770010

677/C

Önkioldó nyomatékulcs,
egyszerű racsával
Jobb és bal oldali meghúzáshoz
Pontosság ± 4%
Hordozótáskában szállítva.



UNI EN ISO 6789

Nm	Kgfm	lbf.ft	D mm	A mm	L mm	kg
120÷600	12÷60	100÷450	69	55	1059	6,0

Ft		1	
677/C600	381.300	1	006770607

Nm	Kgfm	lbf.ft	D mm	A mm	L mm	kg
200÷800	20÷80	150÷600	69	55	1319	6,7

Ft		1	
677/C800	396.200	1	006770612

Nm	Kgfm	lbf.ft	D mm	A mm	L mm	kg
300÷1000	30÷100	200÷750	69	55	1554	7,4

Ft		1	
677/C1000	420.800	1	006770616

Nm	Kgfm	lbf.ft	D mm	A mm	L mm	kg
700÷1500	70÷150	500÷1000	69	55	1869	9,6

Ft		1	
677/C1500	538.500	1	006770621

677/CP2000

Önkioldó nyomatékulcs,
átnyomás racsával
Jobb és bal oldali meghúzáshoz,
Pontosság: ± 4%
Hordozótáskában szállítva.



UNI EN ISO 6789

Nm	Kgfm	lbf.ft	D mm	A mm	L mm	kg
900÷2000	90÷200	700÷1500	69	63	1940	12,75

Ft		1	
677/CP2000	987.000	1	006770721

678/C

Kioldó nyomatékulcs,
egyszerű racsával
Jobb és bal oldali meghúzáshoz
Pontosság ± 4%
Hordozótáskában szállítva.

• A 678/C100 és 678/C150 modelleket hosszabbítóval szállítjuk.

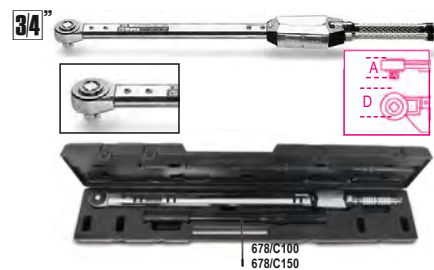

UNI EN ISO 6789

Nm	Kgfm	lbf.ft	D mm	A mm	L mm	kg
130÷650	13÷65	100÷480	63	55	885	3,9

Ft		1	
678/C65	585.700	1	006780607

Nm	Kgfm	lbf.ft	D mm	A mm	L mm	kg
300÷1000	30÷100	220÷750	75	60	1250	6,0

Ft		1	
678/C100	773.200	1	006780611

Nm	Kgfm	lbf.ft	D mm	A mm	L mm	kg
500÷1500	50÷150	370÷1100	75	60	1570	8,5

Ft		1	
678/C150	848.900	1	006780615

677/CV - 678/CV

Fémdobozok nyomatékulcsokhoz
677-hez és 678-hoz

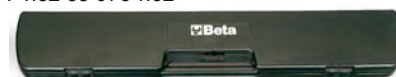

Ft		1	
677/CVN1	67.100	1	006770455

Ft		1	
677/CVN2	88.050	1	006770460

Ft		1	
678/CV1	59.800	1	006780455

Ft		1	
678/CV2	70.500	1	006780500

Ft		1	
678/CV3	116.400	1	006780415

680

digitális nyomaték mérő
Dynatester 680
kalibráció ellenőrzéséhez,
jobb- és bal irányú működés

- Pontosság: leolvasott érték ± 1%
- Színes LCD kijelző, 4 számjegy
- 3 mértékegység: Nm - lbf.ft. - lbf.in

CE



	Nm	kg	Ft		
680/3	0,1÷3	1,4	1.078.700	1	006800000
680/30	1,5÷30	1,4	1.063.900	1	006800003
680/350	10÷350	2,6	1.067.600	1	006800035
680/2100	200÷2100	3,5	1.588.500	1	006800210

682

Elektronikus nyomaték mérőkészülék
digitális kijelzővel Dynatester 682
Jobbos és balos
Nagy pontosságú elektronikus mérés.
A mérőkészülék adapter segítségével
személyi számítógéphez
csatlakoztatható az RS 232 kimeneti
ponton keresztül.

CE



Műszaki tulajdonságok:

Pontosság:
a leolvasott érték +/- 1 %
Választható mértékegység:
Nm-dNm-cNm-Lbf.ft-Lbf.in-Ozf.in-Kgf.m.-kgf.cmgf.cm
Hálózati feszültség:
90 - 264V AC 50/60 Hz
Mérőkészülék:
235x185x185 mm
Tűrésvizsgálat az ISO 6789 szerint
Bevizsgált nyomaték kulcsok
tűréshatárai.
Display
11 nyelven választható menü
Mellékletek
Kalibrációs táblázat /UKAS/

	Nm	kg	Ft		
682/60	1,2÷60	5,9	2.206.600	1	006820006
682/400	8÷400	6,1	2.265.000	1	006820040
682/1500	30÷1500	6,4	2.384.700	1	006820150

GÉPI DUGÓKULCSOK



A gépi dugókulcsok a kézi dugókulcsokhoz képest túlméretezettek, képesek elnyelni az ütvecsavarozók és nyomatéksokszorozók által létrehozott nagy nyomatékot. A hatszög profil még nagyobb tartósságot nyújt intenzív használat mellett is. Tömítőgyűrűvel és zárócsappal együtt kell használni, hogy elkerülhető legyen a meghajtóról való leválás.

A standard és hosszabbított kivitelben rendelkezésre álló klasszikus modellek mellett vékony sorozat is kapható, amely olyan helyeken történő használatra alkalmas, ahol a csavarok a standard modellel nem érhetők el. Jelentősen kisebb mértékű szilárdságuk miatt azonban óvatosságra van szükség használatuk során.



710

3/8"-os gépi dugókulcs, foszfátzott

3/8"



UNI/ISO 2725 DIN 3129

mm	Ø mm	L mm	Ø1 mm	Ft		
7	12,5	28	19	1.750	3	007100007
8	13,8	28	19	1.750	3	007100008
9	15,0	28	19	1.750	3	007100009
10	16,3	28	19	1.750	3	007100010
11	17,5	30	19	1.750	3	007100011
12	19,0	30	19	1.750	3	007100012
13	20,0	30	22	1.860	3	007100013
14	21,3	30	22	1.860	3	007100014
16	23,8	30	22	1.870	3	007100016
17	25,0	30	22	1.870	3	007100017
18	26,3	30	22	1.900	3	007100018
19	27,5	30	22	1.900	3	007100019
21	30,0	32	22	2.110	3	007100021
22	32,0	32	22	2.320	3	007100022

710/C10

10 db 3/8"-os gépi dugókulcs, fémdobozban

3/8"

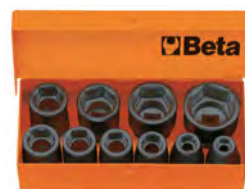

	Ft		
710/C10	28.300	1	007100910
7-8-10-11-12-13			
14-17-19-22 mm			

130x55x40 mm - 800 g

710/16

Bővítő közbetét 3/8" és 1/2"

3/8"



L mm	Ø mm	□	■	Ft		
32	22	3/8	1/2	4.960	3	007100810

710/20

3/8"-os toldó

3/8"



L mm	Ø mm	Ft		
75	22	5.150	2	007100821

710/21

3/8"-os toldó



L mm	Ø mm	Ft	🔧	📄
125	22	5.590	2	007100823

710/22

3/8"-os négyszögletes toldó



L mm	Ø mm	Ft	🔧	📄
150	22	6.760	2	007100825

710/25

3/8"-os csukló



L mm	Ø mm	Ft	🔧	📄
58	24	10.100	2	007100830

710/OR... - 710/SP...

O-gyűrű, biztosító csap



	710 mm	710/16 L mm	Ft	🔧	📄
710/OR1	7+12		165	10	007100921
710/OR2	13+22	32	165	10	007100922
710/SP1	7+12		290	10	007100911
710/SP2	13+22	32	290	10	007100912

720

1/2"-os gépi dugókulcs, foszfátzott



UNI/ISO 2725 DIN 3129

Ø mm	Ø mm	L mm	Ø1 mm	Ft	🔧	📄
8	15,0	38	25	2.150	5	007200008
9	16,0	38	25	2.150	5	007200009
10	17,0	38	25	2.150	5	007200010
11	18,5	38	25	2.150	5	007200011
12	20,0	38	25	2.150	5	007200012
13	21,0	38	25	2.150	5	007200013
14	22,5	38	25	2.150	5	007200014
15	23,0	38	30	2.390	5	007200015
16	25,0	38	30	2.390	5	007200016
17	26,0	38	30	2.390	5	007200017
18	27,5	38	30	2.390	5	007200018
19	28,5	38	30	2.390	5	007200019
20	30	38	30	2.680	5	007200020
21	31,0	38	30	2.650	5	007200021
22	32,5	38	30	2.740	5	007200022
23	34,0	38	30	2.930	5	007200023
24	35,0	38	30	2.930	5	007200024
27	38,5	45	30	3.430	3	007200027
29	41	47	30	3.850	3	007200029
30	42,0	50	30	3.720	3	007200030
32	44,0	50	30	4.210	3	007200032
36	50,0	50	30	6.030	3	007200036

720/C6

Gépi dugókulcs



720/C6	Ft	🔧	📄
13-14-17-19-22-24 mm	22.600	1	007200910

195x80x55 mm - 1100 g

720/C12

Gépi dugókulcs



720/C12	Ft	🔧	📄
10-11-12-13-14-17 19-22-24-27-30-32 mm	40.400	1	007200912

195x80x55 mm - 2000 g

720/C24

24 gépi dugókulcs



720/C24	Ft	🔧	📄
	93.550	1	007200904

	720	10 - 12 - 13 - 14 - 15 - 16 - 17 - 18 - 19 - 21 - 22 - 24 - 27 - 30 - 32 mm
	720L	13 - 17 - 19 - 21 - 22 - 24 mm
	720LC	17 - 19 - 21 mm

420x185x60 mm - 6,2 kg

720MC

gépi dugókulcs, standard sorozat, színezett



Ø mm	Ø mm	L mm	Ft	🔧	📄
10	17,0	38	2.210	3	007202010
11	18,5	38	2.210	3	007202011
12	20,0	38	2.300	3	007202012
13	21,0	38	2.300	3	007202013
14	22,5	38	2.300	3	007202014
15	23,0	38	2.560	3	007202015
16	25,0	38	2.560	3	007202016
17	26,0	38	2.560	3	007202017
18	27,5	38	2.560	3	007202018
19	28,5	38	2.560	3	007202019
21	31,0	38	2.840	2	007202021
22	32,5	38	2.840	2	007202022
24	35,0	38	3.140	2	007202024

720MC/C13

13 gépi dugókulcs, színezett



720MC/C13	Ft	🔧	📄
10-11-12-13-14-15 16-17-18-19-21-22 24 mm	47.350	1	007202913

335x145x60 mm - 2,4 kg

Beta

720B

tizenkétszögű gépi dugókulcs



UNI/ISO 2725 DIN 3129

mm	Ø mm	L mm	Ø1 mm	Ft	1	2
10	17	38	25	2.700	5	007201010
11	18	38	25	2.700	5	007201011
12	19	38	25	2.700	5	007201012
13	20	38	25	2.700	5	007201013
14	22	38	25	2.700	5	007201014
15	23	38	30	3.020	5	007201015
16	24	38	30	3.020	5	007201016
17	26	38	30	3.020	5	007201017
18	27	38	30	3.020	5	007201018
19	28	38	30	3.020	5	007201019
21	30	38	30	3.330	5	007201021
22	31,8	38	30	3.380	5	007201022
23	31,8	38	30	3.690	5	007201023
24	33,8	40	30	3.690	5	007201024
27	37,8	43	30	4.290	3	007201027
30	41,8	43	30	4.690	3	007201030
32	43,8	43	30	5.370	3	007201032
36	49,8	50	30	7.700	3	007201036

720AS

Gépi dugókulcs ütvecsavarozóhoz, Standard-kivitel



mm	Ø mm	L mm	Ø1 mm	Ft	1	2
3/8	17,0	38	25	3.510	2	007200210
7/16	18,2	38	25	3.510	2	007200211
1/2	20,7	38	25	3.510	2	007200213
9/16	22,0	38	25	3.510	2	007200214
5/8	24,5	38	30	3.740	2	007200216
11/16	25,7	38	30	3.740	2	007200217
3/4	28,2	38	30	3.740	2	007200219
13/16	30,7	38	30	3.990	2	007200221
7/8	32,0	38	30	3.990	2	007200222
15/16	34,5	38	30	4.260	2	007200224
1	35,7	38	30	4.480	2	007200225
1.1/16	38,2	40	30	5.060	1	007200227
1.1/8	40,7	42	30	5.690	1	007200229
1.1/4	44,5	42	30	6.180	1	007200232

720S

kompakt gépi dugókulcs



mm	Ø mm	L mm	Ø1 mm	Ft	1	2
13	20,0	28,0	23,8	1.540	3	007200113
15	23,0	28,0	23,8	1.540	3	007200115
17	25,8	28,0	25,8	1.570	3	007200117
19	27,8	28,0	27,8	1.710	3	007200119
22	31,8	28,0	30,0	1.900	3	007200122
24	33,8	28,0	30,0	2.070	3	007200124



mm	Ø mm	L mm	Ø1 mm	Ft	1	2
13-15-17-19-22-24				14.200	1	007200906

720L

1/2"-os hosszú gépi dugókulcs, foszfátzott



UNI/ISO 2725

mm	Ø mm	L mm	Ø1 mm	Ft	1	2
10	17,0	80	25	3.680	2	007200310
11	18,5	80	25	3.680	2	007200311
12	20,0	80	25	3.680	2	007200312
13	21,0	80	25	3.680	2	007200313
14	22,5	80	25	3.680	2	007200314
15	23,0	80	30	4.160	2	007200315
16	25,0	80	30	4.160	2	007200316
17	26,0	80	30	4.160	2	007200317
18	27,5	80	30	4.400	2	007200318
19	28,5	80	30	4.400	2	007200319
21	31,0	80	30	4.680	2	007200321
22	32,5	80	30	4.680	2	007200322
24	35,0	80	30	4.850	2	007200324
27	38,5	80	30	5.920	2	007200327
30	42,0	80	30	7.510	2	007200330
32	44,0	80	30	7.510	2	007200332
36	50,0	80	30	11.500	2	007200336

720L/S3

3 darab hosszú gépi dugókulcs, foszfátzott



mm	Ft	1	2
17-19-21	13.250	1	007200355

720LS

Gépi dugókulcs hosszú és keskeny kivitel



mm	Ø mm	L mm	Ø1 mm	Ft	1	2
10	15,5	78	24	3.970	2	007200360
11	16,7	78	24	3.970	2	007200361
12	18,0	78	24	3.970	2	007200362
13	19,2	78	24	3.970	2	007200363
14	20,5	78	24	3.970	2	007200364
15	21,7	78	24	4.430	2	007200365
16	23,0	78	24	4.430	2	007200366
17	24,2	78	29	4.600	2	007200367
18	25,5	78	29	4.920	2	007200368
19	26,7	78	29	4.920	2	007200369
21	29,2	78	29	5.160	2	007200371
22	30,5	78	29	5.160	2	007200372
24	33,0	78	29	5.300	2	007200374
27	36,7	78	29	6.400	2	007200377
30	40,5	78	29	8.240	2	007200380
32	43,0	78	29	8.230	2	007200382
36	48,0	78	29	12.300	2	007200386

720LC

gépi dugókulcs kerékanyákhoz színes polimer betétekkel



mm	Ø mm	Ft	1	2
17	26,5	2.830	2	007200637
19	28,5	2.830	2	007200639
21	30,3	2.960	2	007200641
22	32,4	3.070	2	007200642
24	34,6	3.430	2	007200644



mm	Ft	1	2
17-19-21 mm	8.620	1	007200653

148x132x44 mm - 860 g



mm	Ft	1	2
17-19-21-22-24 mm	15.100	1	007200645



mm	Ft	1	2
17-19-21-22-24 mm	32.000	1	007200646

PM 1/2-Q5

mágneses dugókulcs tartó



Ft	1	2
16.900	1	088880233

720IC

színes polimer cserebetét a 720LC-720LCL dugókulcshoz



	Ø mm		Ft		
720IC 17	17		1.330	1	007200687
720IC 19	19		1.330	1	007200689
720IC 21	21		1.330	1	007200691
720IC 22	22		1.330	1	007200692
720IC 24	24		1.330	1	007200694

Beta

Quality Tools

720LCL

gépi dugókulcs kerékanyákhoz
színes polimer betétekkel
hosszú kivitel



Ø mm	Ø mm		Ft		
17	26,5		5.150	1	007200737
19	28,5		5.150	1	007200739
21	30,3		5.150	1	007200741



	Ft		
720LCL/C3 17-19-21 mm	20.900	1	007200753

210x50x150 mm - 1,65 kg

720MRC

gépi dugókulcs
polimer betéttel Mercedes kerékanya profilhoz

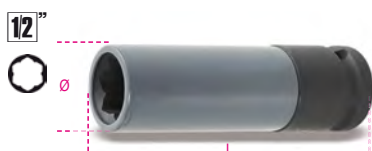

Ø mm	Ø mm	L mm		Ft		
17	27	85	1/2	4.950	1	007200631

720FRD

gépi dugókulcs sérült Ford
aluminium kerékanyákhoz

az ütvecsavarbehajtók miatt sérült csavarsapkákhoz ajánlott



Ø mm	L mm	Ft		
18,5=19,5	63	7.170	1	007200633

720TC

színes gépi torziós rúd
gépjármű kerékanyákhoz
1/2" külső és belső négyszög csatlakozóval



Nm	L mm		Ft		
90	200		4.800	1	007200769
100	200		4.800	1	007200770
110	200		4.800	1	007200771
120	200		4.800	1	007200772
135	200		4.800	1	007200773



	Ft		
720TC/S5 90-100-110-120-135 Nm	24.000	1	007200779

260x50x175 mm - 1,35 kg

720FTX

1/2"-os gépi Torx®-dugókulcs
ütvecsavarbehajtókhoz, foszfátzott



Ø mm	L mm	Ø1 mm		Ft		
E10	14,0	38	25	3.390	2	007200410
E12	15,9	38	25	3.390	2	007200412
E14	17,7	38	25	3.390	2	007200414
E16	20,0	38	25	3.390	2	007200416
E18	22,0	38	25	3.390	2	007200418
E20	25,0	40	25	3.520	2	007200420
E24	30,0	40	30	3.520	2	007200424



	Ft		
720FTX/SB6 E10-E12-E14 E16-E18-E20	24.350	1	007200450

720TX

Gépi Torx® dugókulcs



Ø mm	L mm	L1 mm	Ft		
T30	25	78	54	2.990	3 007200460
T40	25	78	54	2.990	3 007200470
T45	25	78	54	3.050	3 007200472
T50	25	78	54	3.050	3 007200474
T55	25	78	54	3.400	3 007200476
T60	25	78	54	3.650	3 007200478

720TX/C6

6-részes gépi Torx® dugókulcs készlet
fémdobozban



	Ft		
720TX/C6 T30-T40-T45 T50-T55-T60	28.500	1	007200483

275x120x65 mm - 5700 g

720ME

Gépi dugókulcs



Ø mm	L mm	L1 mm	Ft		
5	25	78	54	3.050	3 007200505
6	25	78	54	3.050	3 007200506
8	25	78	54	3.050	3 007200508
10	25	78	54	3.050	3 007200510
12	25	78	54	3.050	3 007200512
14	25	78	54	3.410	3 007200514
17	25	78	54	3.410	3 007200517
19	25	78	54	3.410	3 007200519

720ME/C8

8 gépi dugókulcs fémdobozban



	Ft		
720ME/C8 5-6-8-10-12 14-17-19 mm	38.000	1	007200525

270x120x45 mm - 1710 g

	Ft		
9899 720ME/C8 Hőformált tálcá, üres	5.310	1	098990130

720XZN

gépi dugókulcsok
XZN® fejű csavarokhoz



Ø	Ø mm	L mm	L1 mm	Ft	3	007201504
M4	25	77	53	4.110	3	007201504
M5	25	77	53	4.110	3	007201505
M6	25	77	53	4.110	3	007201506
M8	25	77	53	4.110	3	007201508
M10	25	77	53	4.210	3	007201510
M12	25	77	53	4.320	3	007201512
M14	25	77	53	4.320	3	007201514
M16	25	77	53	4.420	3	007201516
M18	25	77	53	4.640	3	007201518

720/15

Szűkítő közbetét 1/2" és 3/8"



L mm	Ø mm	1/2"	3/8"	Ft	3	007200810
37,5	25	1/2	3/8	2.210	3	007200810



Ügyeljünk a forgató nyomatékra, fokozatosan növeljük, hogy a törést, illetve az esetleges sérülést elkerüljük.

720/16

Bővítő közbetét 1/2" - 3/4"



L mm	Ø mm	1/2"	3/4"	Ft	3	007200814
44	30	1/2	3/4	3.260	3	007200814

720/20

1/2"-os toldó



L mm	Ø mm	Ft	3	007200818
75	25	3.290	3	007200818

720/21

1/2"-os toldó



L mm	Ø mm	Ft	3	007200822
125	25	3.770	3	007200822

720/22

1/2"-os toldó



L mm	Ø mm	Ft	3	007200824
250	25	4.410	3	007200824

720/25

1/2"-os csukló



L mm	Ø mm	Ft	2	007200831
64	28	7.570	2	007200831

720/OR... - 720/SP...

O-gyűrű, biztosító csap



	720	720TX	Ft	10	007200923
720/OR1	10÷14	T30÷T60	265	10	007200923
720/OR2	15÷36		265	10	007200924
720/SP1	10÷14	T30÷T60	405	10	007200913
720/SP2	15÷36		405	10	007200914

727PI/16 1/2

betéttartó
727/ES16, 727/ES16TX és 727/ES16XZN
modellhez



Ø mm	L mm	Ø mm	1/2"	Ft	2	007270015
28	42	16	1/2	8.700	2	007270015

727PI/16

Betéttartó 727/ES16
és 727/ES16TX modellhez



Ø mm	L mm	Ø mm	3/4"	Ft	2	007270016
44	52	16	3/4	11.150	2	007270016

727/ES16

Csavarhúzóbetét külső
méret 16 mm



mm	Ø mm	L mm	Ft	2	007270110
10	16	40	3.360	2	007270110
12	16	40	3.360	2	007270112
13	16	40	3.360	2	007270113
14	16	40	3.360	2	007270114
16	16	40	3.630	2	007270116
17	16	40	3.630	2	007270117
18	16	40	3.830	2	007270118
19	16	40	3.830	2	007270119
22	16	40	4.310	2	007270122

727/ES16TX

Torx® csavarhúzóbetét külső
méret 16 mm



Ø mm	Ø mm	L mm	Ft	2	007270355
T55	16	50	5.110	2	007270355
T60	16	50	5.110	2	007270360
T70	16	50	5.110	2	007270370



727PI/22

Betétartó 727/ES22
és 727/ES22TX modellhez

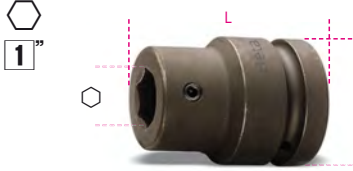

Ø mm	L mm	Ø mm	Ft	🔧	📄
54	70	22	17.350	2	007270022

727/ES22

Csavarhúzóbetét külső
méret 22 mm



mm	● mm	L mm	Ft	🔧	📄
19	22	50	4.310	2	007270219
22	22	50	4.310	2	007270222
24	22	50	4.720	2	007270224
27	22	50	5.280	2	007270227
30	22	50	6.300	2	007270230
32	22	50	6.950	2	007270232

727/ES22TX

Torx® csavarhúzóbetét külső
méret 22 mm



⊙	● mm	L mm	Ft	🔧	📄
T80	22	60	7.280	2	007270480
T90	22	60	7.280	2	007270490
T100	22	60	7.280	2	007270500

727/C16

12 csavarhúzóbetét és 4 tartozék



727/C16	Ft	🔧	📄
	107.400	1	007270900

- 727PI/16
- 727/ES16 14-17-19 mm
- 727/ES16TX T55-T60-T70
- 727PI/22
- 727/ES22 22-24-27 mm
- 727/ES22TX T80-T90-T100
- 96BPC 3-4 mm

📏 335x145x60 mm - 🏠 3,6 kg

727PI/32

Betétartó
727/ES32 modellhez

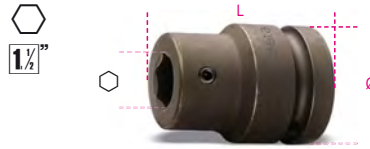

Ø mm	L mm	Ø mm	Ft	🔧	📄
86	66	32	43.100	1	007270032

727/ES32

Csavarhúzóbetét,
külső méret 32 mm



mm	● mm	L mm	Ft	🔧	📄
19	32	44	10.550	2	007270519
22	32	44	10.550	2	007270522
24	32	44	10.550	2	007270524
27	32	44	10.550	2	007270527
30	32	44	10.550	2	007270530
32	32	44	10.550	2	007270532
36	32	44	12.250	2	007270536

728

3/4"-os gépi dugókulcs, foszfátzott



UNI/ISO 2725 DIN 3129

⊙ mm	Ø mm	L mm	Ø1 mm	Ft	🔧	📄
17	30,0	51	44	5.310	2	007280017
18	31,0	51	44	5.310	2	007280018
19	32,5	51	44	5.310	2	007280019
21	35,0	51	44	5.310	2	007280021
22	36,0	51	44	5.310	2	007280022
23	37,5	51	44	5.440	2	007280023
24	38,5	51	44	5.440	2	007280024
27	42,5	53	44	5.440	2	007280027
28	44,0	53	44	5.640	2	007280028
30	46,0	53	44	5.640	2	007280030
32	48,5	57	44	5.890	2	007280032
33	50,0	57	44	6.360	2	007280033
34	51,0	57	44	6.360	2	007280034
35	52,5	57	44	6.630	2	007280035
36	53,5	57	44	6.860	2	007280036
38	56,0	57	44	7.580	1	007280038
40	58,5	58	44	8.120	1	007280040
41	60,0	58	44	8.240	1	007280041
44	64,0	62	44	9.050	1	007280044
45	65,0	62	44	9.410	1	007280045
46	66,0	62	44	9.580	1	007280046
50	71,0	68	54	11.200	1	007280050
55	77,5	71	54	11.900	1	007280055
60	83,0	73	54	15.300	1	007280060
65	88,0	78	54	16.150	1	007280065

728/C10

10 db 3/4"-os gépi dugókulcs,
fémdobozban



728/C10	Ft	🔧	📄
17-19-22-24-27-30 32-36-41-46 mm	73.050	1	007280910

📏 275x120x65 mm - 🏠 5,7 kg

728B

tizenkétszögű gépi dugókulcs



UNI/ISO 2725 DIN 3129

⊙ mm	Ø mm	L mm	Ø1 mm	Ft	🔧	📄
17	28,5	50	38	7.350	2	007280117
19	30	52	38	7.350	2	007280119
21	32	52	38	7.350	2	007280121
22	34	52	38	7.350	2	007280122
23	35	52	38	7.490	2	007280123
24	36	52	38	7.490	2	007280124
27	40	52	40	7.490	2	007280127
29	42	52	42	7.770	2	007280129
30	44	52	44	7.910	2	007280130
32	48	52	44	8.330	2	007280132
33	50	56	44	8.880	2	007280133
34	51	56	44	8.880	2	007280134
35	52	56	44	9.160	2	007280135
36	53,5	56	44	9.440	2	007280136
38	56	56	44	10.550	1	007280138
41	60	58	44	11.400	1	007280141
46	67	63	44	13.450	1	007280146

728AS

standard
dugókulcsfej



⊙ "	Ø mm	L mm	Ø1 mm	Ft	🔧	📄
3/4	32,0	51	41	5.130	1	007280219
13/16	35,0	51	41	5.130	1	007280221
7/8	36,0	51	41	5.370	1	007280222
15/16	38,5	51	41	5.370	1	007280224
1	40,0	53	41	5.640	1	007280225
1.1/16	42,5	53	44	5.870	1	007280227
1.1/8	44,0	53	44	6.110	1	007280230
1.1/4	48,5	57	44	6.350	1	007280232
1.5/16	50,0	57	44	6.620	1	007280233
1.7/16	53,5	57	44	7.480	1	007280236
1.1/2	56,0	57	44	7.690	1	007280238
1.5/8	60,0	58	44	8.420	1	007280241

Beta
Quality Tools

728FTX

Gépi dugókulcs Torx®-csavarokhoz

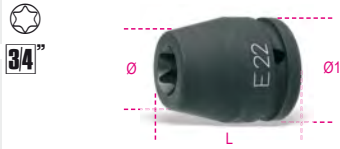

	Ø mm	L mm	Ø1 mm	Ft		
E20	28,5	50	44	7.200	2	007280420
E22	30,0	50	44	7.200	2	007280422
E24	32,5	50	44	7.200	2	007280424

728ME

gépi dugókulcsfej
hatlapfejű csavarokhoz



	Ø mm	L mm	L1 mm	Ft		
12	44	100	67	10.750	3	007280712
14	44	100	67	11.950	3	007280714
17	44	100	67	11.950	3	007280717
19	44	100	67	11.950	3	007280719
22	44	100	67	14.050	3	007280722
24	44	100	67	14.050	3	007280724

728L

Hosszú
dugókulcsfejek



	Ø mm	L mm	Ø1 mm	Ft		
17	30	90	44	8.510	2	007280317
19	32,5	90	44	8.500	2	007280319
21	35,0	90	44	8.500	2	007280321
22	36,0	90	44	8.500	2	007280322
24	38,5	90	44	8.500	2	007280324
26	41,0	90	44	8.500	2	007280326
27	42,5	90	44	8.500	2	007280327
30	46,0	90	44	8.880	2	007280330
32	48,5	90	44	9.540	2	007280332
33	50,0	90	44	10.000	1	007280333
34	51,0	90	44	10.450	1	007280334
36	53,5	90	44	10.750	1	007280336
38	56,0	90	44	12.700	1	007280338
41	60,0	90	44	12.950	1	007280341
44	64,0	90	44	14.700	1	007280344
46	66,0	90	44	14.950	1	007280346
50	71,0	90	44	18.000	1	007280350
55	77,5	100	54	24.850	1	007280355



	Ft		
728L/S3	29.150	1	007280393

Ø 30-32-36 mm

728LS

Hosszú, könnyített 3/4"-os gépi
dugókulcs, foszfátzott



	Ø mm	L mm	Ø1 mm	Ft		
17	28,0	100	43	9.740	2	007280517
19	30,5	100	43	9.740	2	007280519
22	34,3	100	43	9.810	2	007280522
24	36,8	100	43	9.810	2	007280524
27	40,5	100	43	9.810	2	007280527
30	44,3	100	43	9.810	2	007280530
32	46,8	100	43	10.600	2	007280532
33	48,0	100	43	10.950	2	007280533
36	51,8	100	43	12.950	1	007280536

728LQ

Hosszú gépi dugókulcs

(ISUZU kerékanyához)



	L mm	Ø mm	Ø1 mm	Ft		
19	90	35	43,5	9.520	1	007280619
21	90	42	43,5	9.520	1	007280621

728/15

Szűkítő közbetét 3/4"- 1/2",
foszfátzott



	L mm	Ø mm		Ft		
58	38	3/4	1/2	6.740	2	007280810



Ügyeljünk a forgató nyomatékra,
fokozatosan növeljük, hogy a törést,
illetve az esetleges sérülést elkerüljük.

728/16

Bővítő közbetét 3/4"-1",
foszfátzott



	L mm	Ø mm		Ft		
62	44	3/4	1	8.590	2	007280813

728/21

3/4"-os toldó



	L mm	Ø mm	Ft		
175	44		10.050	2	007280815

728/22

3/4"-os toldó



	L mm	Ø mm	Ft		
250	44		11.850	2	007280825

728/22L

Toldó
Belső- és külső négyszög 3/4"



	L mm	Ø mm	Ft		
330	44		15.000	1	007280826

728/25

3/4"-os csukló



	L mm	Ø mm	Ft		
107,5	44		19.700	1	007280830

728/OR - 728/SP

O-gyűrű, biztosító csap



	728 mm	728FTX mm	Ft		
728/OR	728/15		415	5	007280925
728/OR	17+46	E20+E24	435	10	007280926
728/SP	17+46	E20+E24	655	10	007280916

729

1"-os gépi dugókulcs, foszfátzott



UNI/ISO 2725 DIN 3129

	Ø mm	L mm	Ø1 mm	Ft		
24	41,5	58	54	8.450	1	007290024
27	45,0	60	54	8.450	1	007290027
30	49,0	62	54	8.450	1	007290030
32	51,5	63	54	9.050	1	007290032
33	52,5	63	54	9.050	1	007290033
34	54,0	63	54	9.050	1	007290034
36	56,5	66	54	9.050	1	007290036
38	59,0	66	54	10.500	1	007290038
41	62,5	68	54	10.550	1	007290041
46	69,0	72	54	10.950	1	007290046
50	74,0	76	54	13.000	1	007290050
55	80,0	84	54	14.000	1	007290055
60	86,5	88	54	18.100	1	007290060
65	92,5	92	54	21.450	1	007290065
70	99,0	96	54	28.650	1	007290070
75	105,0	102	63	33.500	1	007290075
80	111,5	102	63	37.950	1	007290080

729L

Hosszú 1"-os gépi dugókulcs, foszfátzott



Ø mm	Ø mm	L mm	Ø1 mm	Ft	1	1
24	41,5	108	54	15.550	1	007290324
27	45,0	108	54	15.550	1	007290327
30	49,0	108	54	15.550	1	007290330
32	51,5	108	54	15.550	1	007290332
33	52,2	108	54	15.700	1	007290333
34	54,0	108	54	15.700	1	007290334
36	56,5	108	54	15.700	1	007290336
41	62,5	108	54	18.000	1	007290341
46	69,0	108	54	19.900	1	007290346
50	74,0	108	54	20.900	1	007290350
55	80,0	108	54	25.350	1	007290355
60	86,5	108	54	27.900	1	007290360
65	92,5	108	54	32.550	1	007290365
70	99,0	108	54	37.650	1	007290370
75	105,0	108	63	44.700	1	007290375
80	111,5	108	63	50.100	1	007290380

729LS

Hosszú könnyített 1"-os gépi dugókulcs, foszfátzott



Ø mm	Ø mm	L mm	Ø1 mm	Ft	1	1
22	36,0	108	53	15.250	1	007290522
24	38,5	108	53	15.250	1	007290524
27	46,0	108	53	15.250	1	007290527
30	50,0	108	53	15.950	1	007290530
32	50,0	108	53	15.950	1	007290532
33	52,0	108	53	15.950	1	007290533
36	56,0	108	53	15.950	1	007290536

729T

Gépi torziós dugókulcs kerékanyához



Ø mm	Nm	L mm	Ft	1	1
24	350	300	37.000	1	007290724
27	450	300	37.300	1	007290757
30	500	300	38.100	1	007290730
32	450	300	38.500	1	007290732
32	600	300	38.650	1	007290762
33	600	300	40.100	1	007290763
36	600	300	42.450	1	007290736

729/15

Szűkítő közbetét, 1"-3/4", foszfátzott



L mm	Ø mm	Ø1 mm	Ft	1	1
66,5	54	1 3/4	10.550	1	007290810



Ügyeljünk a forgató nyomatékra, fokozatosan növeljük, hogy a törést, illetve az esetleges sérülést elkerüljük.

729/16

Bővítő közbetét 1" - 1.1/2", foszfátzott



L mm	Ø mm	Ø1 mm	Ft	1	1
88	54,0	1 1.1/2	20.900	1	007290813

729/21

1"-os toldó



L mm	Ø mm	Ft	1	1
175	54	16.650	1	007290815

729/21L

1"-os négyszögletes toldó



L mm	Ø mm	Ft	1	1
250	54	20.600	1	007290826

729/22

1"-os toldó



L mm	Ø mm	Ft	1	1
330	54	24.100	1	007290825

729/25

1"-os csukló



L mm	Ø mm	Ft	1	1
130	54	33.000	1	007290830

729/OR... - 729/SP...

O-gyűrű, biztosító csap



	728	729-730	Ft	1	1
729/OR1	50+60	24+70	495	5	007290927
729/OR2		75+125	970	5	007290928
729/SP1	50+60	24+70	485	5	007290917
729/SP2		75+125	980	5	007290918

730

1.1/2"-os gépi dugókulcs, foszfátzott



UNI/ISO 2725 DIN 3129

Ø mm	Ø mm	L mm	Ø1 mm	Ft	1	1
50	81	87	84	53.450	1	007300050
55	88	90	86	53.850	1	007300055
60	94	95	86	59.900	1	007300060
65	100	100	86	67.800	1	007300065
70	106	105	86	77.650	1	007300070
75	113	110	86	89.900	1	007300075
80	119	115	86	102.500	1	007300080
85	125	120	86	114.200	1	007300085
90	132	125	86	130.100	1	007300090
95	138	125	96	147.500	1	007300095
100	144	130	96	175.600	1	007300100
105	150	135	96	188.700	1	007300105
110	157	140	96	208.800	1	007300110
115	163	140	96	231.100	1	007300115
120	169	145	96	251.600	1	007300120
125	175	145	96	262.400	1	007300125

730L

hatszögű gépi dugókulcs, hosszú



Ø mm	Ø mm	L mm	Ø1 mm	Ft	1	1
50	81	135	86	96.150	1	007300350
55	87	140	86	98.600	1	007300355
60	93	150	86	109.200	1	007300360
65	97	150	86	119.600	1	007300365
70	105	160	86	141.300	1	007300370
75	110	170	86	164.000	1	007300375
80	116	170	86	187.600	1	007300380
85	125	170	86	207.500	1	007300385
90	130	170	86	236.100	1	007300390
95	137	180	95	275.100	1	007300395
100	144	190	95	319.500	1	007300400
105	150	190	95	355.400	1	007300405
110	156	200	95	386.700	1	007300410
115	160	200	95	416.700	1	007300415
120	168	210	95	465.700	1	007300420

730/15

Szűkítő közbetét



Ügyeljünk a forgató nyomatokra, fokozatosan növeljük, hogy a törést, illetve az esetleges sérülést elkerüljük.

730/21

1,1/2"-os négyzögletes toldó



730/25

1,1/2"-os csukló



733/15

Szűkítő közbetét, foszfátzott



CSAVARHÚZÓBETÉTEK

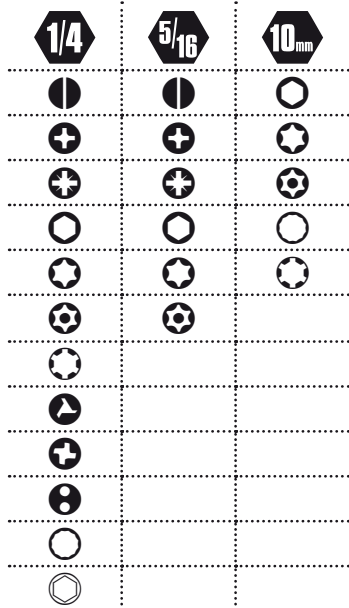

ISO 1173-C 6,3



rugós rögzítés

ISO 1173-E 6,3



golyós rögzítés

851

Mágneses betéttartó csavarhúzónyéllel

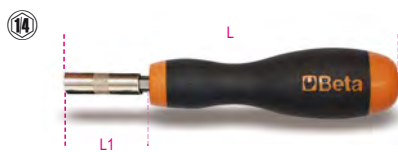

L1	L			Ft	
mm	mm			6.270	2 008510165
45	165			7.440	2 008510245

851SR

Mágneses betéttartó csavarhúzónyéllel



L	L1			Ft	
mm	mm			8.670	2 008510001
230	110				

852

csuklós T-szárú bitkulcs

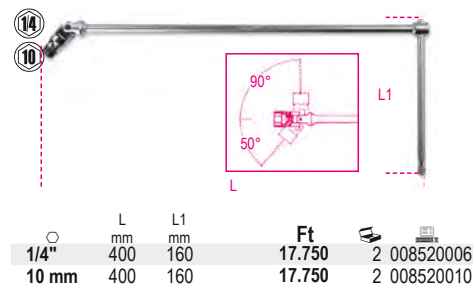

855P

Betéttartócsavarhúzó állítható nyéllel, irányváltós racsnival, 7 betéttel



L	L1			Ft	
mm	mm			29.350	1 008550010
240	100				

+	860PH	PH1 - PH2
+	860PZ	PZ1 - PZ2
●	860LP	LP 0,8x5,5 mm
○	860PE	4 - 5 mm

860LP

Színes csavarhúzóbetét hasítottfejú csavarokhoz



ISO 2351-1
ISO 1173 C 6,3

SxA	L			Ft	
mm	mm			770	5 008600005
0,5x3	25			770	5 008600010
0,6x4,5	25			770	5 008600015
0,8x5,5	25			770	5 008600020
1x5,5	25			770	5 008600025
1,2x6,5	25				

860PH

Színes csavarhúzóbetét Phillips®-csavarokhoz



ISO 2351-2
ISO 1173 C 6,3

PH	L			Ft	
	mm			770	5 008600220
0	25			770	5 008600225
1	25			770	5 008600230
2	25			770	5 008600245
3	25			1.110	5 008600250
4	25				

Beta

860PZ

Színes csavarhúzóbetét
Pozi driv®- és Supadriv®-csavarokhoz



ISO 2351-2
ISO 1173 C 6,3

PZ	L mm	Ft	csomagolás	partszám
1	25	770	5	008600320
2	25	770	5	008600325
3	25	770	5	008600330
4	25	1.110	5	008600335

860PE

Színes hatlapú csavarhúzóbetét



ISO 2351-3
ISO 1173 C 6,3

mm	L mm	Ft	csomagolás	partszám
2	25	825	5	008600101
2,5	25	825	5	008600102
3	25	825	5	008600103
4	25	825	5	008600104
5	25	825	5	008600105
6	25	825	5	008600106
8	25	1.030	5	008600108
10	25	1.030	5	008600110

860TX

Színes csavarhúzóbetét
Torx®-csavarokhoz



ISO 1173 C 6,3

T	L mm	Ft	csomagolás	partszám
T6	25	1.030	5	008600704
T7	25	1.030	5	008600705
T8	25	1.030	5	008600710
T9	25	1.030	5	008600715
T10	25	820	5	008600720
T15	25	820	5	008600725
T20	25	820	5	008600730
T25	25	820	5	008600735
T27	25	820	5	008600740
T30	25	820	5	008600745
T40	25	820	5	008600750

860RTX

Színes csavarhúzóbetét
Tampér Resistant Torx®-csavarokhoz



ISO 1173 C 6,3

T	L mm	Ft	csomagolás	partszám
T9	25	1.110	5	008600550
T10	25	1.110	5	008600555
T15	25	1.110	5	008600560
T20	25	1.110	5	008600565
T25	25	1.110	5	008600570
T27	25	1.110	5	008600575
T30	25	1.110	5	008600580
T40	25	1.110	5	008600585

860/55

Átváltós racsni



L mm 100
Ø 1/4
Ft 12.750
csomagolás 3
partszám 008600870

860/58

betéttartó racsni forgó markolattal

- A bit mindkét oldalon behelyezhető a be- vagy kicsavaráshoz
- Kettős anyagú markolat



L mm 126
Ø 1/4"
A mm 27
Ft 29.650
csomagolás 1
partszám 008600884

860/C27

25 csavarhúzóbetét, 1 betéttartó
és 1 irányváltós racsni, műanyag dobozban



860/C27 Ft 35.300
csomagolás 1
partszám 008600880

860/55	100 mm
860LP	0,5x3-1,0x5,5-1,2x6,5 mm
860PH	PH1-PH2(x2)-PH3
860PZ	PZ1-PZ2(x2)-PZ3
860PE	2-2,5-3-4-5-6 mm
860TX	T6-T8-T10-T15-T20-T25-T30-T40
892/0	● 1/4 ■ 1/4

860PHZ/A10

10 csavarhúzóbetét és mágneses betéttartó,
műanyag dobozban



860PHZ/A10 Ft 14.550
csomagolás 1
partszám 008600910

860PH	PH1 PH2 PH3	n. 1 3 1
860PZ	PZ1 PZ2 PZ3	1 3 1
882M1	○ 1/4 ● 1/4	

860PE/A10

10 csavarhúzóbetét és mágneses betéttartó,
műanyag dobozban



860PE/A10 Ft 15.300
csomagolás 1
partszám 008600920

860PE	2-2,5 mm	n. 1
882M1	○ 1/4 ● 1/4	2

860TX/A10

10 csavarhúzóbetét és mágneses betéttartó,
műanyag dobozban



860TX/A10 Ft 15.650
csomagolás 1
partszám 008600970

860TX	T7 - T8 - T9 - T10 - T15 - T20	n. 1
882M1	T25 - T27 - T30 - T40 ○ 1/4 ● 1/4	

860MIX/A10

10 csavarhúzóbetét és mágneses betéttartó,
műanyag dobozban



860MIX/A10 Ft 14.550
csomagolás 1
partszám 008600900

860LP	0,5x3 - 1x5,5 - 1,2x6,5 mm	n. 1
860PH	PH1 PH2 PH3	1 2 1
860PZ	PZ1 - PZ2 - PZ3	1 1
882M1	○ 1/4 ● 1/4	



860MIX/A31

30 csavarhúzóbetét és mágneses gyorslazítású betéttartó, műanyag dobozban



860MIX/A31 Ft 34.750 1 008600902

	860LP	0,5x3 - 0,6x4,5 - 0,8x5,5 1,0x5,5 - 1,2x6,5 mm
	860PE	2 - 2,5 - 3 - 4 - 5 - 6 8 - 10 mm
	860PH	PH0 - PH1 - PH2 - PH3 - PH4
	860PZ	PZ1 - PZ2 - PZ3 - PZ4
	860RTX	T9 - T10 - T15 - T20 T25 - T27 - T30 - T40
	882MSR 50	○ 1/4 ● 1/4

860/C38P

1 betéttartó irányváltós racsnival és csavarhúzónyéllel, 27 csavarhúzóbetét, 8 hatlapú dugókulcs és 2 tartozék szivacsbetétes fémdobozban

Betéttartó irányváltós racsnival
Betéttartófedél
Toldó gyorsoldással, levehető



860/C38P Ft 72.300 1 008600878

	860LP	0,6x4,5-0,8x5,5-1,0x5,5- 1,2x6,5 mm
	860PE	2-2,5-3-4(x2)-5(x2) mm
	860PH	PH1(x2)-PH2(x2)-PH3
	860PZ	PZ1(x2)-PZ2(x2)-PZ3
	860TX	T10-T15-T20-T25-T30-T40
	900	5-5,5-6-7-8-9-10-13 mm
	892/0	● 1/4 ■ 1/4
	892/3	● 1/4 ■ 1/4
	855P	240 mm

270x120x45 mm

861LP

Csavarhúzóbetétek hasítottfejú csavarokhoz



ISO 2351-1

ISO 1173 C 6,3

SxA mm	L mm	Ft		
0,5x3	25	490	10	008610005
0,6x4	25	490	10	008610007
0,6x4,5	25	490	10	008610010
0,8x5,5	25	490	10	008610015
1x5,5	25	490	10	008610020
1,2x6,5	25	490	10	008610025
1,2x8	25	945	10	008610028
1,6x8	25	945	10	008610030

861PH

Csavarhúzóbetétek Phillips®-csavarokhoz



ISO 2351-2

ISO 1173 C 6,3

PH	L mm	Ft		
0	25	490	10	008610200
1	25	490	10	008610205
2	25	490	10	008610210
2L	50	945	10	008610213
3	25	490	10	008610215
4	25	1.300	10	008610220

861PH/C

Csavarhúzóbetétek Phillips®-csavarokhoz



ISO 2351-2

ISO 1173 C 6,3

PH	L mm	Ft		
0	25	345	200	008610250
1	25	345	200	008610255
2	25	345	200	008610260
2L	50	690	100	008610263
3	25	345	200	008610265
4	25	940	100	008610270

861PZ

Csavarhúzóbetétek Pozidriv®-Supadriv® csavarokhoz



ISO 2351-2

ISO 1173 C 6,3

PZ	L mm	Ft		
1	25	490	10	008610300
2	25	490	10	008610305
2L	50	955	10	008610308
3	25	490	10	008610310
4	25	1.300	10	008610315

861PZ/C

Csavarhúzóbetétek Pozidriv®-Supadriv® csavarokhoz



ISO 2351-2

ISO 1173 C 6,3

PZ	L mm	Ft		
1	25	345	200	008610350
2	25	345	200	008610355
2L	50	690	100	008610358
3	25	345	200	008610360
4	25	935	100	008610365

861PE

Imbusz-csavarhúzóbetétek



ISO 2351-3

ISO 1173 C 6,3

mm	L mm	Ft		
2	25	510	10	008610100
2,5	25	510	10	008610105
3	25	510	10	008610110
4	25	510	10	008610115
5	25	510	10	008610120
6	25	510	10	008610125
8	25	790	10	008610130
10	25	1.020	10	008610135

861TX

Torx® csavarhúzóbetétek



ISO 1173 C 6,3

T	L mm	Ft		
T5	25	695	10	008610399
T6	25	695	10	008610400
T7	25	695	10	008610405
T8	25	695	10	008610410
T9	25	695	10	008610415
T10	25	555	10	008610420
T15	25	555	10	008610425
T20	25	555	10	008610430
T25	25	555	10	008610435
T27	25	555	10	008610440
T30	25	555	10	008610445
T40	25	555	10	008610450



861TX/C

Torx® csavarhúzóbetétek



ISO 1173 C 6,3

	L mm	Ft		
T10	25	395	200	008610470
T15	25	395	200	008610475
T20	25	395	200	008610480
T25	25	395	200	008610485
T27	25	395	200	008610490
T30	25	395	200	008610495
T40	25	395	200	008610499

861RTX

Tamper Resistant Torx(R) csavarhúzóbetétek



ISO 1173 C 6,3

	L mm	Ft		
T6	25	1.030	10	008610537
T7	25	1.030	10	008610538
T8	25	1.030	10	008610540
T9	25	1.030	10	008610500
T10	25	1.030	10	008610505
T15	25	1.030	10	008610510
T20	25	1.030	10	008610515
T25	25	1.030	10	008610520
T27	25	1.030	10	008610525
T30	25	1.030	10	008610530
T40	25	1.030	10	008610535
T45	25	1.970	10	008610539

861RIBE

csavarbehajtó bit RIBE(R) csavarokhoz



ISO 1173 C 6,3

	L mm	Ft		
M5	25	445	10	008610705
M6	25	445	10	008610706
M7	25	550	10	008610707
M8	25	550	10	008610708
M9	25	790	10	008610709

861TRW

1/4"-os Tri-Wing® csavarhúzó betét



ISO 1173 C 6,3

GR	L mm	Ft		
1	25	840	10	008610601
2	25	840	10	008610602
3	25	840	10	008610603
4	25	840	10	008610604
5	25	840	10	008610605
6	25	1.240	10	008610606

861TQS

1/4"-os Torq-Set® csavarhúzó betét



ISO 1173 C 6,3

GR	L mm	Ft		
0	25	840	10	008610620
1	25	840	10	008610621
2	25	840	10	008610622
3	25	840	10	008610623
4	25	840	10	008610624
5	25	840	10	008610625
6	25	840	10	008610626
8	25	840	10	008610628
10	25	840	10	008610630

861SP

Speciális csavarhúzóbetétek beállító csavarokhoz



ISO 1173 C 6,3

SP	D mm	L mm	Ft		
4	1,5	25	690	10	008610650
6	2,4	25	690	10	008610653
8	2,8	25	690	10	008610656
10	3,3	25	690	10	008610658
12	3,9	25	690	10	008610660

1483KV-PT/S7



1483KV PT/S7

188

861XZN

csavarbehajtó bit XZN® csavarokhoz



ISO 1173 C 6,3

	L mm	Ft		
M5	25	445	10	008610725
M6	25	445	10	008610726
M8	25	550	10	008610728

861/C61P

61 csavarhúzóbetét és 1 betéttartó, mágneses



861/C61P Ft 65.150 1 008610978

	861LP	0,5x3 - 0,6x4,5 - 0,8x5,5 - 1,0x5,5 1,2x6,5 - 1,2x8 - 1,6x8 mm
	861PE	2 - 2,5 - 3 - 4 - 5 - 6 - 8 - 10 mm
	861PH	PH0 - PH1 - PH2 - PH3
	861PZ	PZ1 - PZ2 - PZ3
	861TX	T6 - T7 - T8 - T9 - T10 - T15 T20 - T25 - T27 - T30 - T40
	861RTX	T9 - T10 - T15 - T20 - T25 T27 - T30 - T40
	861TRW	1 - 2 - 3 - 4 - 5 - 6
	861TQS	0 - 1 - 2 - 3 - 4 - 5 - 6 - 8 - 10
	861SP	4 - 6 - 8 - 10 - 12
	851SR	1/4"

270x120x45 mm - 975 g

862LP

Hosszú csavarhúzóbetétek hasított fejű csavarhoz



ISO 2351-1

ISO 1173 E 6,3

SxA mm	L mm	Ft		
0,5x3	50	1.420	5	008620005
0,6x4,5	50	1.420	5	008620010
0,8x5,5	50	1.420	5	008620015
1x5,5	50	1.420	5	008620020
1,2x6,5	50	1.420	5	008620025
1,2x8	50	1.770	5	008620030
1,6x8	50	1.770	5	008620035

862PH

Hosszú csavarhúzóbetétek Phillips®-csavarhoz



ISO 2351-2

ISO 1173 E 6,3

PH	L mm	Ft		
1	50	1.430	5	008620200
2	50	1.430	5	008620205
3	50	1.430	5	008620210



862PH/L

Csavarhúzóbetétek
Phillips®-csavarhoz



ISO 2351-2

ISO 1173 E 6,3

PH	L mm	Ft	5	10
1	70	2.660	5	008620230
2	70	2.660	5	008620232
3	70	2.660	5	008620234

862PH-XL

csavarbehajtó betét
Phillips® keresztornyos csavarokhoz



ISO 2351-2/ISO 1173 E 6,3

PH	L mm	Ft	5	10
1	100	1.810	5	008620250
2	100	1.810	5	008620252
3	100	1.810	5	008620254

862PZ

Hosszú csavarhúzóbetétek
Pozidriv®-Supadriv® csavarhoz



ISO 2351-2

ISO 1173 E 6,3

PZ	L mm	Ft	5	10
1	50	1.470	5	008620300
2	50	1.470	5	008620305
3	50	1.470	5	008620310

862PE

Hosszú imbusz-csavarhúzóbetétek



ISO 2351-3

ISO 1173 E 6,3

mm	L mm	Ft	5	10
3	50	1.470	5	008620103
4	50	1.470	5	008620104
5	50	1.470	5	008620105
6	50	1.470	5	008620106
8	50	1.980	5	008620108

862TX

Csavarhúzóbetét Torx®-csavarokhoz



ISO 1173 E 6,3

	L mm	Ft	5	10
T6	50	1.930	5	008620506
T7	50	1.930	5	008620507
T8	50	1.930	5	008620508
T9	50	1.930	5	008620509
T10	50	1.930	5	008620510
T15	50	1.930	5	008620515
T20	50	1.930	5	008620520
T25	50	1.930	5	008620525
T27	50	1.930	5	008620527
T30	50	1.930	5	008620530
T40	50	1.930	5	008620540

862TX/L

Csavarhúzóbetétek Torx®-csavarhoz



ISO 1173 E 6,3

	L mm	Ft	5	10
T6	70	2.120	5	008620556
T7	70	2.120	5	008620557
T8	70	2.120	5	008620558
T9	70	2.120	5	008620559
T10	70	2.120	5	008620560
T15	70	2.120	5	008620565
T20	70	2.120	5	008620570
T25	70	2.120	5	008620575
T27	70	2.120	5	008620577
T30	70	2.120	5	008620580
T40	70	2.120	5	008620590

862TX-XL

csavarbehajtó betét
Torx® csavarokhoz



ISO 1173 E 6,3

	L mm	Ft	5	10
T9	100	1.750	5	008620659
T10	100	1.750	5	008620660
T15	100	1.750	5	008620665
T20	100	1.750	5	008620670
T25	100	1.750	5	008620675
T27	100	1.750	5	008620677
T30	100	1.750	5	008620680
T40	100	1.750	5	008620690

862F

Mágneses hatszögű dugókulcsbetétek



ISO 1173 E 6,3

mm	L mm	Ø mm	Ft	5	10
5,5	65	11	2.690	5	008620405
6	65	11	2.690	5	008620406
7	65	11	2.690	5	008620407
8	65	13	2.690	5	008620408
10	65	15	2.960	5	008620410
12	65	18	3.220	5	008620412
13	65	18	3.470	5	008620413

862F/A7

7 hatlapú dugókulcsbetét, mágneses



862F/A7 Ft 20.400 1 008620950

862F 5,5-6-7-8-10-12-13 mm

866LP

Csavarhúzóbetétek hasítottfejú
csavarhoz



ISO 2351-1
ISO 1173 C 8

SxA mm	L mm	Ft	5	10
1x5,5	41	1.460	10	008660005
1,2x6,5	41	1.460	10	008660010
1,6x8	41	1.460	10	008660015
1,6x10	41	1.990	10	008660020
2x12	41	2.500	10	008660025

866PH

Csavarhúzóbetétek
Phillips®-csavarhoz



ISO 2351-2

ISO 1173 C 8

PH	L mm	Ft	5	10
1	32	1.170	10	008660200
2	32	1.170	10	008660205
3	32	1.170	10	008660210
4	38	1.780	10	008660215

866PZ

Csavarhúzóbetétek
Pozidriv®-Supadriv® csavarhoz



ISO 2351-2

ISO 1173 C 8

PZ	L mm	Ft	5	10
1	32	1.230	10	008660300
2	32	1.230	10	008660305
3	32	1.230	10	008660310
4	38	1.830	10	008660315

866PE

Imbusz-csavarhúzóbetétek



ISO 2351-3

ISO 1173 C 8

mm	L mm	Ft	5/16"	10mm
3	30	1.030	10	008660100
4	30	1.030	10	008660105
5	30	1.030	10	008660110
6	30	1.030	10	008660115
7	30	1.030	10	008660117
8	30	1.030	10	008660120
10	30	1.430	10	008660125
12	30	1.980	10	008660132
14	30	2.580	10	008660134

866TX

Torx®-csavarhúzóbetét



ISO 1173 C 8

	L mm	Ft	5/16"	10mm
T20	30	1.290	10	008660400
T25	30	1.290	10	008660405
T27	30	1.290	10	008660410
T30	30	1.290	10	008660415
T40	30	1.290	10	008660420
T45	30	1.290	10	008660425
T50	30	1.290	10	008660430
T55	30	1.840	10	008660435
T60	30	2.430	10	008660440
T70	30	2.760	10	008660445

866RTX

Tamper Resistant Torx(R)
csavarhúzóbetétek



ISO 1173 C 8

	L mm	Ft	5/16"	10mm
T40	30	1.480	10	008660520
T45	30	1.480	10	008660525
T50	30	1.480	10	008660530
T55	30	2.080	10	008660535
T60	30	2.680	10	008660540
T70	30	3.300	10	008660545

867PE

Hatszögű csavarhúzóbetétek



mm	L mm	Ft	5/16"	10mm
4	30	670	5	008670104
5	30	670	5	008670105
6	30	670	5	008670106
7	30	670	5	008670107
8	30	670	5	008670108
10	30	670	5	008670110
12	30	915	5	008670112

867PE/L

Hatszögű csavarhúzóbetétek



mm	L mm	Ft	5/16"	10mm
4	75	1.190	5	008670154
5	75	1.190	5	008670155
6	75	1.190	5	008670156
7	75	1.190	5	008670157
8	75	1.190	5	008670158
10	75	1.190	5	008670160
12	75	1.680	5	008670162

867XZN

Csavarhúzóbetétek XZN®-csavarhoz



	L mm	Ft	5/16"	10mm
M4	30	785	5	008670204
M5	30	785	5	008670205
M6	30	785	5	008670206
M8	30	785	5	008670208
M10	30	785	5	008670210
M12	30	1.170	5	008670212

867XZN/L

Csavarhúzóbetétek XZN®-csavarhoz



	L mm	Ft	5/16"	10mm
M5	75	1.320	5	008670255
M6	75	1.320	5	008670256
M8	75	1.320	5	008670258
M10	75	1.320	5	008670260
M12	75	1.830	5	008670262

867TX

Csavarhúzóbetétek Torx®-csavarhoz



	L mm	Ft	5/16"	10mm
T20	30	670	5	008670400
T25	30	670	5	008670405
T30	30	670	5	008670410
T40	30	670	5	008670415
T45	30	670	5	008670420
T50	30	670	5	008670425
T55	30	670	5	008670430

867TX/L

Csavarhúzóbetétek Torx®-csavarhoz



	L mm	Ft	5/16"	10mm
T20	75	1.060	5	008670450
T25	75	1.060	5	008670455
T30	75	1.060	5	008670460
T40	75	1.060	5	008670465
T45	75	1.060	5	008670470
T50	75	1.060	5	008670475
T55	75	1.060	5	008670480

867RTX

Csavarhúzóbetétek
Tamper Resistant Torx®-csavarhoz



	L mm	Ft	5/16"	10mm
T20	30	735	5	008670500
T25	30	735	5	008670505
T30	30	735	5	008670510
T40	30	735	5	008670515
T45	30	735	5	008670520
T50	30	735	5	008670525
T55	30	735	5	008670530

867RTX/L

Csavarhúzóbetétek
Tamper Resistant Torx®-csavarhoz



	L mm	Ft	5/16"	10mm
T20	75	1.230	5	008670550
T25	75	1.230	5	008670555
T30	75	1.230	5	008670560
T40	75	1.230	5	008670565
T45	75	1.230	5	008670570
T50	75	1.230	5	008670575
T55	75	1.230	5	008670580

867RIBE

csavarbehajtó betét
RIBE® csavarokhoz



	L mm	Ft	5/16"	10mm
M5	30	715	5	008670705
M6	30	715	5	008670706
M7	30	715	5	008670707
M8	30	715	5	008670708
M9	30	715	5	008670709
M10	30	715	5	008670710
M11	30	1.080	5	008670711
M12	30	1.080	5	008670712
M13	30	1.080	5	008670713

867RIBE/L

csavarbehajtó betét
RIBE® csavarokhoz



	L	Ft		
	mm			
M5	75	1.170	5	008670755
M6	75	1.170	5	008670756
M7	75	1.170	5	008670757
M8	75	1.170	5	008670758
M9	75	1.170	5	008670759
M10	75	1.170	5	008670760
M11	75	1.630	5	008670761
M12	75	1.630	5	008670762
M13	75	1.630	5	008670763

867/...

Betéttartó a 867-es betétekhez

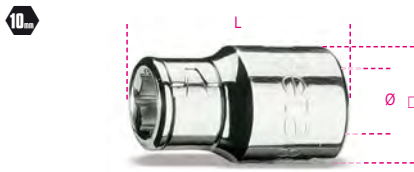

	mm	mm	L	Ø	Ft		
			mm	mm			
867/1	10	3/8"	38	17	2.350	5	008670600
867/2	10	1/2"	38	22	2.660	5	008670601

867/C20

18 RIBE® betét 10 mm hatlapfejű
csatlakozóval és 2 tartozékkal



	Ft		
867/C20	44.650	1	008670920

867RIBE	5-6-7-8-9-10-11-12-13 mm
867RIBE/L	5-6-7-8-9-10-11-12-13 mm
867/1	
867/2	
335x145x60 mm - 1,7 kg	

867/C38

38 betét 10 mm hatlapfejű csatlakozóval és 1
csuklós T betéttartóval



	Ft		
867/C38	84.150	1	008670938

852	10 mm
867PE	4-5-6-7-8-10-12mm
867PE/L	4-5-6-7-8-10-12mm
867XZN	M5-M6-M8-M10-M12
867XZN/L	M5-M6-M8-M10-M12
867TX	T20-T25-T30-T40-T45-T50-T55
867TX/L	T20-T25-T30-T40-T45-T50-T55
882	
420x185x60 mm - 3 kg	

867/C52

52 hatszögű csavarhúzóbetét,
10 mm és 2 tartozék



	Ft		
867/C52	53.950	1	008670901

867PE	4-5-6-7-8-10-12 mm
867PE/L	4-5-6-7-8-10-12 mm
867XZN	M5-M6-M8-M10-M12
867XZN/L	M5-M6-M8-M10-M12
867TX	T20-T25-T30-T40-T45-T50-T55
867TX/L	T20-T25-T30-T40-T45-T50-T55
867RTX	T20-T25-T30-T40-T45-T50-T55
867RTX/L	T20-T25-T30-T40-T45-T50-T55
867/1	Ø 10 mm - □ 3/8"
867/2	Ø 10 mm - □ 1/2"
250x170x70 mm - 2,1 kg	

852



852									78,116
-----	--	--	--	--	--	--	--	--	--------

882

1/4" külső és 1/4" belső mérettel
rendelkező betéttartó

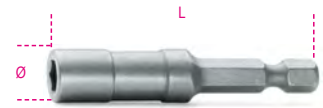

ISO 1173 E 6,3

L	Ø	Ft		
mm	mm			
57	1/4"	1/4"	6.570	5 008820001

882AN

kúpkeres hajtómű, 1/4" hatlapfejű
csatlakozó

- 10 mm és 13 mm orsójú elektromos fúrógéphez és 1/4" ütvecsavarozókhoz
- Max. fordulatszám: 3600 rpm
- Max. nyomaték: 30 Nm
- Gyors cserét biztosító betéttartóval
- Áttétel: 1:1
- A szerszámhoz 1/4" hatszögű D6.3 csatlakozóval



ISO 1173 E 6,3
ISO 1173 C 6,3

L	Ø	Ft		
mm	mm			
137	1/4"	1/4"	44.650	1 008820090

882M1

1/4" külső és 1/4" belső mérettel
rendelkező betéttartó



ISO 1173 E 6,3

L	Ø	Ft		
mm	mm			
50	1/4"	1/4"	6.840	5 008820006

882M

1/4" külső és 1/4" belső mérettel
rendelkező betéttartó



ISO 1173 E 6,3

L	Ø	Ft		
mm	mm			
75	1/4"	1/4"	8.330	5 008820005

Beta

882MSR

Mágneses betéttartó, gyorslazítással



ISO 1173 E 6,3

L mm	○ 1/4	● 1/4	Ø mm	Ft	🔧	📄
50	1/4	1/4	11	7.380	5	008820205
75	1/4	1/4	11	8.680	5	008820207

882P

Mágneses betéttartó



L mm	● 1/4	○ 1/4	Ø mm	Ft	🔧	📄
80	1/4	1/4	10	6.140	5	008820080

892

Adapter dugókulcshoz



■	●	L mm	Ft	🔧	📄
892/0	1/4	1/4	25	2.140	5 008920000
* 892/1	1/4	5,5	50	3.980	5 008920001
* 892/2	3/8	5,5	50	6.050	5 008920002
° 892/3	1/4	1/4	50	3.980	5 008920003
° 892/4	3/8	1/4	50	6.050	5 008920004
892/5	1/4	5/16	75	5.640	5 008920005
892/6	3/8	5/16	75	8.350	5 008920006
892/7	1/2	1/4	75	8.580	5 008920007

* ISO 1173 A 5,5
° ISO 1173 C 6,3



895

Betéttartók 861 - 862 - 866
betétekhez 1/4", 3/8" és 1/2"



DIN 7427

	○	□	L mm	Ø mm	Ft	🔧	📄
895/1	1/4	1/4	25,4	12	4.840	5	008950000
895/3	1/4	3/8	29	16,8	5.840	5	008950001
895/4	5/16	3/8	29	16,8	5.840	5	008950002
895/5	1/4	1/2	38	22	5.840	5	008950005
895/6	5/16	1/2	38	22	5.840	5	008950003

897

1/4"-os flexibilis betéttartó csavarhúzónyéllel



L mm	L1 mm	Ft	🔧	📄
280	154	11.350	2	008970010

897L

Flexibilis betéttartó, nyéllel, hosszított kivitel

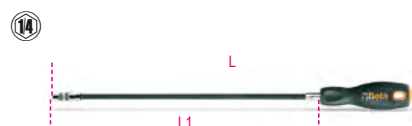

L mm	L1 mm	Ft	🔧	📄
500	380	13.500	2	008970015

9XX/55 TÍPUSÚ RACSNIK

Kompakt
fej



A 72-fogas gyűrűnek köszönhetően alkalmas szűk helyeken történő munkavégzéshez, legfeljebb 5°-os szögben



Megakadályozza a megcsúszást vagy a feszítettség alatt történő kioldást

- A racsnis fej kézzel történő nyomása nem okoz irányváltást, és a kar mindig szabadon visszatérhet
- Egykezes irányváltás
- Kiemelkedő mechanikai tulajdonságok



Csökkentett munkaterhelés esetén 17 fog mindig érintkezik a fogaskoszorúval

900

Hatlapú dugókulcs



UNI/ISO 2725 DIN 3124

Ø	mm	mm	L	mm	mm	Ø1	mm	Ft	csomagolás
3,2	6,6	25	11,8	1,040	10	009000032			
4	6,8	25	11,8	1,040	10	009000040			
4,5	7,4	25	11,8	1,040	10	009000045			
5	8,0	25	11,8	1,040	10	009000050			
5,5	8,7	25	11,8	1,040	10	009000055			
6	9,3	25	11,8	1,040	10	009000060			
7	10,4	25	11,8	1,040	10	009000070			
8	11,8	25	12,7	1,040	10	009000080			
9	12,7	25	11,8	1,040	10	009000090			
10	14,2	25	12,0	1,040	10	009000100			
11	15,8	25	12,5	1,040	10	009000110			
12	17,2	25	13,5	1,040	10	009000120			
13	18,0	25	13,5	1,050	10	009000130			
14	20,0	25	15,0	1,060	10	009000140			



900/SB13 Ft 20.250 1 009000150
4-4,5-5-5,5-6-7-8-9
10-11-12-13-14 mm

900MC

hatszögű dugókulcs, színezett

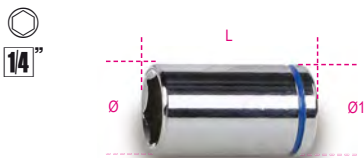

Ø	L	mm	mm	Ø1	mm	Ft	csomagolás
4	24,8	6,7	11,8	1,120	5	0090002040	
5	24,8	8,0	11,8	1,120	5	0090002050	
6	24,8	9,2	11,8	1,120	5	0090002060	
7	24,8	10,7	11,8	1,120	5	0090002070	
8	24,8	11,8	11,8	1,120	5	0090002080	
9	24,8	12,8	12,8	1,120	5	0090002090	
10	24,8	14,8	14,8	1,120	5	0090002100	
11	24,8	15,8	15,8	1,120	5	0090002110	
12	24,8	16,8	16,8	1,120	5	0090002120	
13	24,8	17,8	17,8	1,160	5	0090002130	
14	24,8	19,5	19,5	1,240	5	0090002140	

900MB

Tizenkétszögű dugókulcs



UNI/ISO 2725 DIN 3124

Ø	mm	mm	L	mm	mm	Ø1	mm	Ft	csomagolás
4	6,7	22	11,2	2,010	5	009000160			
5	7,7	25	11,2	2,010	5	009000161			
5,5	8,3	25	11,2	2,010	5	009000162			
6	9,0	25	11,2	2,010	5	009000163			
7	10,2	25	11,2	2,010	5	009000164			
8	11,3	25	12,0	2,010	5	009000165			
9	13,0	25	12,0	2,010	5	009000166			
10	14,3	25	12,9	2,010	5	009000167			
11	16,0	25	14,3	2,010	5	009000168			
12	17,4	25	16,0	2,010	5	009000169			
13	18,0	25	16,4	2,230	5	009000170			
14	19,3	25	17,9	2,370	5	009000171			



900MB/SB12 Ft 31.000 1 009000179
4-5-5,5-6-7-8-9-10
11-12-13-14 mm

900L

Hatlapú hosszú dugókulcs



UNI/ISO 2725 DIN 3124

Ø	mm	mm	L	mm	mm	Ø1	mm	Ft	csomagolás
4	6,5	50	12,0	2,410	5	009000181			
4,5	7,0	50	12,0	2,410	5	009000182			
5	7,5	50	12,0	2,410	5	009000183			
5,5	8,5	50	12,0	2,410	5	009000184			
6	9,5	50	12,0	2,410	5	009000185			
7	10,5	50	12,0	2,410	5	009000186			
8	12,0	50	12,0	2,410	5	009000187			
9	13,0	50	13,0	2,410	5	009000188			
10	14,0	50	14,0	2,550	5	009000189			
11	16,0	50	16,0	2,550	5	009000190			
12	17,5	50	17,5	2,550	5	009000191			
13	17,5	50	17,5	2,550	5	009000192			
14	20,0	50	20,0	2,550	5	009000193			



900L/SB13 Ft 38.700 1 009000203
4-4,5-5-5,5-6-7-8-9-10-11-12-13-14 mm

900MB/L

Tizenkétszögű hosszú dugókulcs



UNI/ISO 2725 DIN 3124

Ø	mm	mm	L	mm	mm	Ø1	mm	Ft	csomagolás
5	8,0	50	12,0	3,730	3	009000211			
6	9,3	50	12,0	3,730	3	009000212			
7	10,9	50	12,0	3,730	3	009000213			
8	11,6	50	12,0	3,730	3	009000214			
9	13,0	50	12,0	3,730	3	009000215			
10	14,3	50	12,8	3,960	3	009000216			
11	16,0	50	14,2	3,960	3	009000217			
12	17,4	50	15,5	3,960	3	009000218			
13	18,0	50	16,2	4,000	3	009000219			
14	19,0	50	17,1	4,040	3	009000220			

900AS

Hatlapú dugókulcs



Ø	mm	mm	L	mm	mm	Ø1	mm	Ft	csomagolás
5/32	8,8	25	11,9	1,130	5	009000349			
3/16	7,7	25	11,9	1,130	5	009000340			
7/32	8,8	25	11,9	1,130	5	009000345			
1/4	9,6	25	11,9	1,130	5	009000350			
9/32	10,2	25	11,9	1,130	5	009000355			
5/16	11,3	25	11,9	1,130	5	009000360			
11/32	12,7	25	11,6	1,130	5	009000365			
3/8	14,0	25	12,9	1,130	5	009000370			
7/16	15,3	25	14,5	1,130	5	009000375			
1/2	17,5	25	16,4	1,130	5	009000380			
9/16	19,0	25	17,9	1,190	5	009000385			



900AS/SB11 Ft 18.350 1 009000389
3/16-7/32-5/32-1/4-9/32-5/16-11/32-3/8-
7/16-1/2-9/16

900AS/MB

Tizenkétszögű dugókulcs



SAE AS 954E

Ø	mm	mm	L	mm	mm	Ø1	mm	Ft	csomagolás
3/16	7,7	22	10,9	2,070	2	009000390			
7/32	8,5	22	10,9	2,070	2	009000391			
1/4	9,4	22	10,9	2,070	2	009000392			
9/32	10,2	22	10,9	2,070	2	009000393			
5/16	11,3	22	11,7	2,070	2	009000394			
11/32	12,5	22	12,0	2,070	2	009000395			
3/8	13,7	22	12,9	2,230	2	009000396			
7/16	15,6	22	14,3	2,230	2	009000397			
1/2	17,2	22	16,4	2,420	2	009000398			
9/16	18,8	24	17,9	2,440	2	009000399			



900AS/L

Hatlapú hosszú dugókulcs



SAE AS 954E

"	Ø mm	L mm	Ø1 mm	Ft	🔧	📄
3/16	7,0	50	12,0	2.580	2	009000301
7/32	8,5	50	12,0	2.580	2	009000303
1/4	9,8	50	12,0	2.580	2	009000305
9/32	10,5	50	12,0	2.580	2	009000307
5/16	12,0	50	12,0	2.580	2	009000309
11/32	13,0	50	13,0	2.580	2	009000311
3/8	14,0	50	14,0	2.580	2	009000313
7/16	16,0	50	16,0	2.580	2	009000315
1/2	17,5	50	17,5	2.580	2	009000317
9/16	20,0	50	20,0	2.710	2	009000319

900AS/MBL

Tizenkétszögű hosszú dugókulcs



"	Ø mm	L mm	Ø1 mm	Ft	🔧	📄
5/32	6,8	50	12,0	3.990	2	009000325
3/16	8,0	50	12,0	3.990	2	009000326
7/32	8,5	50	12,0	3.990	2	009000327
1/4	9,8	50	12,0	3.990	2	009000328
9/32	10,9	50	12,0	3.990	2	009000329
5/16	11,6	50	12,0	3.990	2	009000330
11/32	13,0	50	12,0	3.990	2	009000331
3/8	14,3	50	12,8	4.250	2	009000332
7/16	16,0	50	14,2	4.250	2	009000333
1/2	18,0	50	16,2	4.240	2	009000334
9/16	19,0	50	17,1	4.240	2	009000335

900U

multifunkciós dugókulcsok

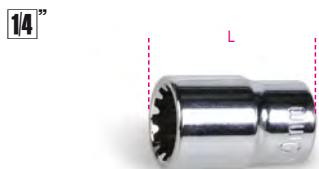

mm	"	🔧	📄	Ft	🔧	📄
4	5/32	E5	M5	1.050	5	009001702
4,5	3/16	E6		1.050	5	009001703
5	13/64		M6	1.050	5	009001704
5,5	7/32	E7		1.050	5	009001705
6	1/4	E8	M8	1.050	5	009001706
7	9/32			1.050	5	009001707
8	5/16	E10	M10	1.050	5	009001708
9	11/32			1.050	5	009001709
10	3/8	E12	M12	1.050	5	009001710
11	7/16	E14	M14	1.050	5	009001711
12	15/32	E16		1.050	5	009001712
13	1/2		M16	1.100	5	009001713
14	9/16		M18	1.160	5	009001714

1/4"



900U/SB13	Ft	🔧	📄
4-4,5-5-5,5-6-7-8-9 10-11-12-13-14 mm	20.500	1	009001750

900FTX

Dugókulcs Torx®-csavarokhoz

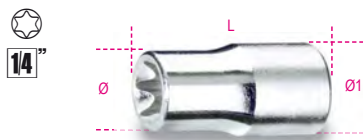

🔧	Ø mm	L mm	Ø1 mm	Ft	🔧	📄
E4	5,4	22	11,2	1.960	5	009000404
E5	6,7	22	11,2	1.960	5	009000405
E6	7,7	22	11,2	1.960	5	009000406
E7	8,3	22	11,2	1.960	5	009000407
E8	9,6	22	11,2	1.960	5	009000408
E10	11,3	22	12,0	1.960	5	009000410
E11	12,1	22	12,5	2.620	5	009000411
E12	12,9	23	12,9	2.620	5	009000412
E14	14,0	25	14,0	2.620	5	009000414

1/4"



900FTX/SB9	Ft	🔧	📄
E4-E5-E6-E7-E8 E10-E11-E12-E14	24.700	1	009000419

900LP

Csavarhúzó-dugókulcs hasítottfejú csavarokhoz, krómozott, barnított hegy

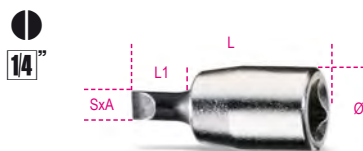

SxA mm	Ø mm	L mm	L1 mm	Ft	🔧	📄
0,8x4	12	28	9	2.350	5	009000605
1x5,5	12	28	9	2.350	5	009000610
1,2x6,5	12	28	9	2.350	5	009000615
1,2x8	13	28	8	2.350	5	009000620
1,6x10	14	28	8	2.350	5	009000625

900MC/LP

dugókulcs hasítottfejú csavarokhoz, színezett

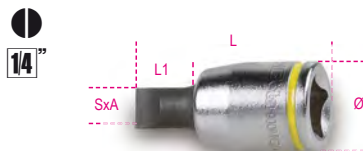

SxA mm	Ø mm	L mm	L1 mm	Ft	🔧	📄
0,8x4	12	28	9	5.200	3	009002605
1,2x6,5	12	28	9	5.200	3	009002615
1,2x8	13	28	8	5.200	3	009002620

900PH

Csavarhúzó-dugókulcs Phillips(R)-csavarokhoz, krómozott, barnított hegy



PH	Ø mm	L mm	L1 mm	Ft	🔧	📄
1	12	28	12	2.590	5	009000701
2	12	28	12	2.590	5	009000702
3	12	28	12	2.590	5	009000703
4	13	28	11	2.590	5	009000704

+



900PH/SB4	Ft	🔧	📄
PH1-PH2-PH3-PH4	13.450	1	009000708

900MC/PH

dugókulcs keresztfejú Phillips® csavarokhoz, színezett

+



PH	Ø mm	L mm	L1 mm	Ft	🔧	📄
1	12	28	12	5.410	3	009002701
2	12	28	12	5.410	3	009002702
3	12	28	12	5.410	3	009002703

900PZ

dugókulcs keresztfejú Pozidriv®-Supadriv® csavarokhoz

+



PZ	Ø mm	L mm	Ft	🔧	📄
1	12	28	3.150	3	009000711
2	12	28	4.190	3	009000712
3	12	28	3.990	3	009000713

900ME

1/4"-os imbusz-dugókulcs, krómozott, barnított hegy

1/4"



mm	Ø mm	L mm	L1 mm	Ft	csomagolás	anyag
2,5	12	25	4,5	2.230	5	009000502
3	12	25	5,0	2.230	5	009000503
4	12	25	5,6	2.230	5	009000504
5	12	25	6,3	2.230	5	009000505
6	12	25	7,6	2.230	5	009000506
7	13	25	7,2	2.230	5	009000507
8	13	25	8,0	2.230	5	009000508
10	13	25	8,7	2.750	5	009000510

1/4"



900ME/SB8 23.050 1 009000518
2,5-3-4-5-6-7-8-10 mm

900PE/AS

Imbusz dugókulcs készlet
1/4"-os
krómozott, barnított betétek

1/4"



"	Ø mm	L mm	Ft	csomagolás	anyag
1/8	11,9	25	6.050	5	009000521
5/32	11,9	25	6.050	5	009000522
3/16	11,9	25	6.050	5	009000523
7/32	11,9	25	6.050	5	009000524
1/4	11,9	25	6.050	5	009000525
9/32	13,1	25	6.050	5	009000526
5/16	13,1	25	6.050	5	009000527

900PT

Ötlapú csavarhúzó-dugókulcs

1/4"



csomagolás	Ø mm	L mm	L1 mm	Ft	anyag
5	12	28	12	7.160	009000750
5	12	28	12	7.160	009000755
5	12	28	12	7.160	009000760
5	12	28	12	7.160	009000765
5	12	28	12	7.160	009000767
5	12	28	12	7.160	009000770

900TX

1/4"-os Torx(R)-imbusz dugókulcs, krómozott, fekete hegyek

1/4"



csomagolás	Ø mm	L mm	L1 mm	Ft	anyag
5	12	28	12	3.450	009000717
5	12	28	12	3.450	009000718
5	12	28	12	3.480	009000719
5	12	28	12	3.480	009000720
5	12	28	12	3.480	009000721
5	12	28	12	3.480	009000722
5	12	28	12	3.480	009000723
5	12	28	12	3.480	009000724
5	12	28	12	3.480	009000725
5	12	28	12	3.480	009000726
5	12	28	12	3.480	009000727

1/4"



900TX/SB8 32.500 1 009000730
T9-T10-T15-T20
T25-T27-T30-T40

900MC/TX

dugókulcs
Torx® csavarokhoz, színezett

1/4"



csomagolás	Ø mm	L mm	L1 mm	Ft	anyag
3	12	28	12	5.490	009002721
3	12	28	12	5.490	009002722
3	12	28	12	5.490	009002723
3	12	28	12	5.490	009002724
3	12	28	12	5.490	009002725
3	12	28	12	5.490	009002726
3	12	28	12	5.490	009002727

900/16

Bővítő közbetét 1/4" - 3/8"

1/4"



UNI/ISO 3316 DIN 3123

L mm	Ø mm	csomagolás	Ft	anyag
28	13,0	5	2.630	009000814

900/...

Toldók

1/4"

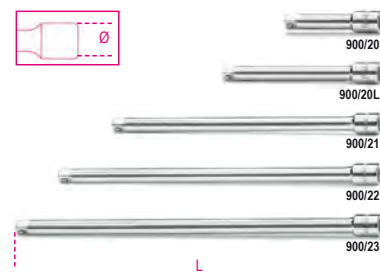

UNI/ISO 3316 DIN 3123

csomagolás	L mm	Ø mm	Ft	anyag
5	50	11,5	3.320	009000818
5	100	11,5	3.420	009000819
5	150	11,5	3.630	009000822
5	250	11,5	5.370	009000823
5	350	11,5	6.450	009000824

900AN

1/4"-os gömbvégű toldó

1/4"

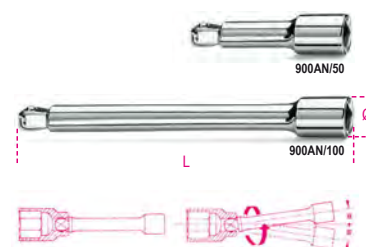

csomagolás	L mm	Ø mm	Ft	anyag
3	50	11,5	3.650	009000825
3	100	11,5	4.090	009000826

900FL

1/4"-os flexibilis toldó, krómozott

1/4"

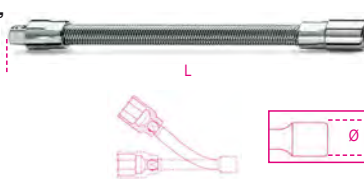

L mm	Ø mm	csomagolás	Ft	anyag
150	12	3	5.140	009000828

900/25

1/4"-os csukló

1/4"



UNI/ISO 3316 DIN 3123

L mm	Ø mm	csomagolás	Ft	anyag
41	12,5	5	6.720	009000830

900BG/30C

1/4"-os hajtószár



UNI/ISO 3315 DIN 3122

L	L1	Ft	☞	☞
mm 128	mm 20	3.110	5	009000833

900BG/30

1/4"-os hajtószár



UNI/ISO 3315 DIN 3122

L	L1	Ft	☞	☞
mm 176	mm 68	3.340	5	009000834

900/32

1/4"-os flexibilis hajtószár



L	L1	Ft	☞	☞
mm 280	mm 154	7.610	2	009000839

900/35A

1/4"-os csuklós hajtószár, krómozott



UNI/ISO 3315 DIN 3122

L	L1	Ft	☞	☞
mm 148	mm 84	10.900	5	009000840

900M/35

1/4"-os csuklós fém hajtószár



UNI/ISO 3315
DIN 3122

L	Ft	☞	☞
mm 130	14.300	3	009000845



900/40

1/4"-os csuklós T-hajtószár

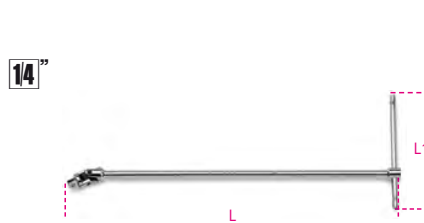

L	L1	Ft	☞	☞
mm 390	mm 145	15.000	3	009000843

900/42

1/4"-os csúszkás T-hajtószár

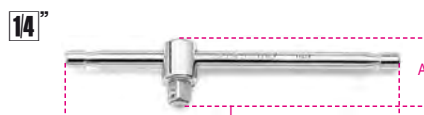

UNI/ISO 3315 DIN 3122

L	A	Ft	☞	☞
mm 115	mm 22	3.770	5	009000854

900T/44

hajlítót 1/4" hajtószár
működtető markolattal



L	L1	Ft	☞	☞
mm 238	mm 105	5.560	2	009000860

900/55

1/4"-os irányváltós racsni, krómozott



UNI/ISO 3315 DIN 3122

L	Ø	A	Ft	☞	☞
mm 125	mm 25	mm 29	18.150	5	009000870

900/55Z

72



A 990/55Z típusú racsni a Beta Műszaki osztálya fejlesztette ki; új 72 fogas mechanizmussal rendelkezik, ahol 15 fog folyamatosan érintkezik a fogaskoszorúval. Így a munkaterhelés sok fog között oszlik el, és csökken az egyes részek kopása, ami rendkívül hosszú élettartamot eredményez.



Mindezeket túl a 72 fog 5°-nál nem nagyobb felvételi szögét és rendkívül kompakt fejet biztosít, amivel szűk helyekhez is gyors hozzáférést biztosít.

A Beta ergonomikus kétkomponensű markolata lehetővé teszi a racsni gyors használatát és ugyanakkor nagyobb erő alkalmazását.

900/55Z

1/4" irányváltós racsni, 72 fogas mechanizmus



L	Ø	A	Ft	☞	☞
mm 126	mm 25	mm 23	18.150	3	009000882

900M/55

1/4"-os irányváltós fémracsni



UNI/ISO 3315
DIN 3122

L	Ø	A	Ft	1	009000905
mm	mm	mm			
110	22	18	23.050	3	009000905

Nyomatékkulcs csatlakozási méretei, lásd a táblázatot a 929/C8 cikkszám alatt!

900/58

Írányváltós racsn

1/4"

52 fogú

- Hajtószár
- Nyitó és rögzítő gomb
- Irányváltás a fejen lévő műanyag gyűrű jobbra és balra forgatásával
- Bimateriál-nyél



L	Ø	A	Ft	2	009000884
mm	mm	mm			
126	28	28,5	27.650	2	009000884

900/C39N

11 hatlapfejű dugókulcs, 21 csavarhúzóbetét és 7 tartozék



900/C39N	Ft	1	009000947
	73.800	1	009000947

861LP	0,6x4,5 - 1,2x6,5 - 1,2x8 mm
861PH	PH1-PH2-PH3
861PZ	PZ1-PZ2-PZ3
861PE	2,5-3-4-5-6 mm
861RTX	T10-T15-T20-T25-T27-T30-T40
900	5-5,5-6-7-8-9-10-11-12-13-14 mm
900/20	50 mm
900/20L	100 mm
900/25	
900BG/30C	128 mm
892/0	
895/1	
900/55Z	126 mm

900/C39U

11 multifunkciós dugókulcs, 21 csavarhúzóbetét és 7 tartozék



900/C39U	Ft	1	009001947
	74.050	1	009001947

861LP	0,6x4,5 - 1,2x6,5 - 1,2x8 mm
861PH	PH1-PH2-PH3
861PZ	PZ1-PZ2-PZ3
861PE	2,5-3-4-5-6 mm
861RTX	T10-T15-T20-T25-T27-T30-T40
900U	○ 5-5,5-6-7-8-9-10-11-12-13-14 mm □ 3/16-1/8-1/4-9/32-5/16-11/32-3/8-7/16-15/32-1/2-9/16 ◎ E6-E7-E8-E10-E12-E14-E16-E18 ○ M6-M8-M10-M12-M14-M16-M18
900/20	50 mm
900/20L	100 mm
900/25	
900BG/30C	128 mm
892/0	
895/1	
900/55Z	126 mm

900/C11

11 hatlapú dugókulcs, 20 csavarhúzóbetét és 8 betéttartó



900/C11	Ft	1	009000971
	81.150	1	009000971

861LP	0,5x3 - 0,8x5,5 1x5,5 - 1,2x6,5 mm
861PE	3 - 4 - 5 - 6 - 8 mm
861PH	0 - 1 - 2 - 3
861TX	T8 - T10 - T15 - T20 T25 - T30 - T40
895/1	
900	5 - 5,5 - 6 - 7 - 8 - 9 - 10 11 - 12 - 13 - 14 mm
900/16	□ 1/4 - ■ 3/8
900/20	50 mm
900/21	150 mm
900/25	
900BG/30	176 mm
900/42	
900/55	

270x120x45 mm - 1,2 kg

9899 900C11	Ft	1	098990132
	5.310	1	098990132

Hőformált tálcá, üres

900/C11Z

11 hatlapú dugókulcs, 20 csavarhúzóbetét és 8 tartozék



900/C11Z	Ft	1	009000984
	81.150	1	009000984

861LP	0,5x3 - 0,8x5,5 - 1x5,5 - 1,2x6,5 mm
861PE	3 - 4 - 5 - 6 - 8 mm
861PH	0 - 1 - 2 - 3
861TX	T8 - T10 - T15 - T20 T25 - T30 - T40
895/1	
900	5 - 5,5 - 6 - 7 - 8 - 9 - 10 11 - 12 - 13 - 14 mm
900/16	□ 1/4 - ■ 3/8
900/20	50 mm
900/21	150 mm
900/25	
900BG/30	176 mm
900/42	
900/55Z	

350x150x50 mm - 1,2 kg

9899 900C11	Ft	1	098990132
	5.310	1	098990132

Hőformált tálcá, üres

900/C12MR

12 hatlapú dugókulcs, 20 csavarhúzóbetét és 7 tartozék szivacsbetétes fémdobozban



900/C12MR	Ft	1	009000962
	90.950	1	009000962

900	4-5-5,5-6-7-8-9-10-11-12-13-14 mm
900/20	50 mm
900/21	150 mm
900/25	
900/42	115 mm
900BG/30	128 mm
900/58	
895/1	
861TX	T8-T10-T15-T20-T25-T30-T40
861PH	PH0-PH1-PH2-PH3
861LP	0,5-0,8-1-1,2 mm
861PE	3-4-5-6-8 mm

350x150x50 mm 1,3 kg

900/C12MZ

12 darab hatlapú dugókulcs,
20 darab csavarhúzóbetét és 7 tartozék
szivacsbetétes fémdobozban

1/4"

1/4"



900/C12MZ Ft 81.450 1 009000983

- 900 4-5-5,5-6-7-8-9-10-11-12-13-14 mm
- 900/20 50 mm
- 900/21 150 mm
- 900/25
- 900/42 115 mm
- 900BG/30 176 mm
- 900/55Z
- 895/1
- 861TX T8-T10-T15-T20-T25-T30-T40
- 861PH PH0-PH1-PH2-PH3
- 861LP 0,5x3 - 0,8x5,5 - 1x5,5 - 1,2x6,5 mm
- 861PE 3-4-5-6-8 mm

350x150x50 mm - 1,2 kg

900/C13-5

13 hatlapú dugókulcs és 5 tartozék,
fémdobozban

1/4"



900/C13-5 Ft 61.650 1 009000953

- 900 4-4,5-5-5,5-6-7-8-9
10-11-12-13-14 mm
- 900/21 150 mm
- 900/25
- 900BG/30
- 900/42
- 900/55

270x120x45 mm - 1 kg

9899 900/C13-5 Ft 6.070 1 098990131

Hőformált tálcá, üres

900/C13-8

13 hatlapú dugókulcs és 8 tartozék,
fémdobozban

1/4"



900/C13-8 Ft 78.500 1 009000954

- 900 4-4,5-5-5,5-6-7-8-9
10-11-12-13-14 mm
- 900/16 □ 1/4 - ■ 3/8
- 900/20 50 mm
- 900/21 150 mm
- 900/25
- 900BG/30
- 900/35A
- 900/42
- 900/55

270x120x45 mm - 1,1 kg

900MB/C19

11 tizenkétszögű dugókulcs
és 8 tartozék, fémdobozban

1/4"



900MB/C19 Ft 87.650 1 009000977

- 900MB 5-5,5-6-7-8-9-10-11
12-13-14 mm
- 900/16 □ 1/4 - ■ 3/8
- 900/20 50 mm
- 900/21 150 mm
- 900/25
- 900BG/30
- 900/35A
- 900/42
- 900/55

270x120x45 mm - 1,1 kg

900/C24

13 hatlapú dugókulcs,
11 csavarhúzó-dugókulcs
és 6 tartozék, fémdobozban

1/4"



900/C24 Ft 90.950 1 009000956

- 900 4-4,5-5-5,5-6-7-8-9
10-11-12-13-14 mm
- 900LP 0,8x4 - 1,2x6,5 - 1,2x8 mm
- 900PH PH1 - PH2 - PH3
- 900ME 3-4-5-6-8 mm
- 900/20 50 mm
- 900/21 150 mm
- 900/25
- 900BG/30
- 900/42
- 900/55

270x120x45 mm - 1,1 kg

900MB/C28

11 tizenkétszögű dugókulcs, 11 csavarhúzó-
dugókulcs és 6 tartozék fémdobozban

1/4"



900MB/C28 Ft 100.100 1 009000979

- 900MB 5-5,5-6-7-8-9-10-11
12-13-14 mm
- 900LP 0,8x4 - 1,2x6,5 - 1,2x8 mm
- 900PH PH1 - PH2 - PH3
- 900ME 3-4-5-6-8 mm
- 900/20 50 mm
- 900/21 150 mm
- 900/25
- 900BG/30
- 900/42
- 900/55

270x120x45 mm - 1,1 kg



900MC/C24

11 hatlapú dugókulcs,
13 színezett dugókulcs és 6 tartozék

1/4"



900MC/C24 Ft 134.200 1 009002960

	900MC	4 - 5 - 6 - 7 - 8 - 9 10 - 11 - 12 - 13 - 14 mm
	900MC/PH	PH1 - PH2 - PH3
	900MC/TX	T10 - T15 - T20 - T25 - T27 - T30 - T40
	900MC/LP	0,8x4 - 1,2x6,5 - 1,2x8 mm
	900/20	50 mm
	900/21	150 mm
	900/25	
	900BG/30	
	900/42	
	900/55	

270x120x45 mm - 1 kg

900MC/C32

11 színezett dugókulcs, 20 színezett bit és 7 tartozék

1/4"



900MC/C32 Ft 85.200 1 009002963

	900MC	4 - 5 - 6 - 7 - 8 - 9 - 10 - 11 - 12 - 13 - 14 mm
	860LP	0,5x3 - 0,8x5,5 - 1,0x5,5 - 1,2x6,5 mm
	860PH	0 - 1 - 2 - 3
	860PE	3 - 4 - 5 - 6 - 8 mm
	860TX	T8 - T10 - T15 - T20 - T25 - T30 - T40
	895/1	
	900/20	
	900/21	
	900/25	
	900BG/30	
	900/42	
	900/55	

270x120x45 mm - 1,2 kg

900U/C12M

12 multifunkciós dugókulcs,
20 csavarhúzóbetét és 7 tartozék,
puha habszivacs tálcában

1/4"

1/4"



900U/C12M Ft 81.700 1 009001792

	900U	○ 4-5-5-6-7-8-9-10-11-12-13-14 mm * 5/32-3/16-13/64-7/32-1/4-9/32-5/16 11/32-3/8-7/16-15/32-1/2-9/16 ○ E5-E6-E7-E8-E10-E12-E14-E16-E18 ○ M5-M6-M8-M10-M12-M14-M16-M18
	900/20	50 mm
	900/21	150 mm
	900/25	
	900/42	115 mm
	900BG/30	176 mm
	900/55	125 mm
	895/1	○ 1/4 - □ 1/4
	861LP	0,5x3 - 0,8x5,5 - 1,0x5,5 - 1,2x6,5 mm
	861PE	3-4-5-6-8 mm
	861PH	PH0-PH1-PH2-PH3
	861TX	T8-T10-T15-T20-T25-T30-T40

350x150x50 mm - 1,2 kg

900AS/C10 - /MB-C17

10 hatlapú dugókulcs
és 7 tartozék fémdobozban

1/4"



900AS/C10 Ft 73.700 1 009000961

	900AS	3/16 - 7/32 - 1/4 - 9/32 - 5/16 11/32 - 3/8 - 7/16 - 1/2 - 9/16
	900/20	50 mm
	900/21	150 mm
	900/25	
	900BG/30	
	900/35A	
	900/42	
	900/55	

270x120x45 mm - 1,1 kg

900AS/MB-C17 Ft 84.050 1 009000981

	900AS/MB	3/16 - 7/32 - 1/4 - 9/32 - 5/16 11/32 - 3/8 - 7/16 - 1/2 - 9/16
	900/20	50 mm
	900/21	150 mm
	900/25	
	900BG/30	
	900/35A	
	900/42	
	900/55	

270x120x45 mm - 1,1 kg

900AS/C17-MBM

10 tizenkétszögű dugókulcs
és 7 tartozék repülőgép karbantartásához

1/4"



900AS/C17-MBM Ft 92.350 1 009000982

	900AS/MB	3/16 - 7/32 - 1/4 - 9/32 - 5/16 11/32 - 3/8 - 7/16 - 1/2 - 9/16
	900/20	50 mm
	900/21	150 mm
	900/25	
	900BG/30	
	900M/35	
	900/42	
	900M/55	

270x120x45 mm - 1,2 kg



900/C11HR

11 hatlapfejű dugókulcs,
20 csavarbehajtó betét és 7 tartozék
kemény hőformázott tálcában,
lemezdobozban

• forgó markolatos racsni

1/4"



900/C11HR Ft 90.650 1 009000980

861LP	0,5x3-0,8x5,5-1x5,5-1,2x6,5 mm
861PH	PH0-PH1-PH2-PH3
861PE	3-4-5-6-8 mm
861TX	T8-T10-T15-T20-T25-T30-T40
895/1	
900	5-5,5-6-7-8-9-10-11-12-13-14 mm
900/16	□ 1/4 - ■ 3/8
900/20	50 mm
900/21	150 mm
900/25	
900/42	
900BG/30	
900/58	

350x150x50 mm - 1,3 kg

902R/C6

6 adapter a dugókulcshoz



902R/C6 Ft 34.150 1 009020814

900/16	□ 1/4 - ■ 3/8
910/15	□ 3/8 - ■ 1/4
910/16	□ 3/8 - ■ 1/2
920/15	□ 1/2 - ■ 3/8
920/16	□ 1/2 - ■ 3/4
928/15	□ 3/4 - ■ 1/2

170x100x35 mm - 600 g

902A/C22

22 hatlapú dugókulcs és 6 tartozék
fémdobozban

1/4"
1/2"



902A/C22 Ft 122.100 1 009020807

900	5-5,5-6-7-8-9-10-11-12-13 mm
900/20	50 mm
900/25	
1/4 900/55	
920A	10-13-14-15-17-18-19-22-24-27-30-32 mm
920/21	125 mm
920/25	
1/2 920/55	

420x185x60 mm - 3,5 kg

9899 902A/C22 Ft 5.310 1 098990133

Hőformált tálcá, üres

910A

Hatlapú dugókulcs

3/8"



UNI/ISO 2725 DIN 3124

mm	Ø mm	L mm	Ø1 mm	Ft	5	1
6	9,5	28	16,7	2.090	5	009100006
7	10,7	28	16,7	2.090	5	009100007
8	12,1	28	16,7	2.090	5	009100008
9	13,2	28	16,7	2.090	5	009100009
10	14,6	29	16,7	2.090	5	009100010
11	15,8	29	16,7	2.090	5	009100011
12	17,2	30	17,7	2.210	5	009100012
13	18,4	31	17,0	2.210	5	009100013
14	19,7	32	17,5	2.210	5	009100014
15	20,9	32	18,0	2.210	5	009100015
16	22,2	33	18,5	2.390	5	009100016
17	23,2	33	19,0	2.390	5	009100017
18	24,7	34	20,0	2.390	5	009100018
19	25,8	35	21,0	2.390	5	009100019
20	27,2	35	22,0	2.530	5	009100020
21	28,2	36	23,0	2.530	5	009100021
22	29,7	37	24,0	2.590	5	009100022

3/8"



910A/SB17 Ft 47.150 1 009100030

6-7-8-9-10-11-12
13-14-15-16-17
18-19-20-21-22 mm

910B

Tizenkétszögű dugókulcs

3/8"



UNI/ISO 2725 DIN 3124

mm	Ø mm	L mm	Ø1 mm	Ft	5	1
6	9,5	28	16,7	2.090	5	009100106
7	10,7	28	16,7	2.090	5	009100107
8	12,1	28	16,7	2.090	5	009100108
9	13,2	28	16,7	2.090	5	009100109
10	14,6	29	16,7	2.090	5	009100110
11	15,8	29	16,7	2.090	5	009100111
12	17,2	30	17,7	2.210	5	009100112
13	18,4	31	17,0	2.210	5	009100113
14	19,7	32	17,5	2.210	5	009100114
15	20,9	32	18,0	2.210	5	009100115
16	22,2	33	18,5	2.390	5	009100116
17	23,2	33	19,0	2.390	5	009100117
18	24,7	34	20,0	2.390	5	009100118
19	25,8	35	21,0	2.390	5	009100119
20	27,2	35	22,0	2.530	5	009100120
21	28,2	36	23,0	2.530	5	009100121
22	29,7	37	24,0	2.590	5	009100122

3/8"



910B/SB17 Ft 47.150 1 009100130

6-7-8-9-10-11-12
13-14-15-16-17
18-19-20-21-22 mm

910AL

Hatlapú dugókulcs,
hosszított kivitel

3/8"



UNI/ISO 2725 DIN 3124

mm	Ø mm	L mm	Ø1 mm	Ft	3	1
8	12,0	55	17	4.500	3	009100158
9	13,0	55	17	4.500	3	009100159
10	14,5	55	17	4.500	3	009100160
11	16,0	55	17	4.500	3	009100161
12	17,0	55	17	4.500	3	009100162
13	18,0	55	17	4.920	3	009100163
14	20,0	55	18	4.920	3	009100164
15	21,0	55	20	4.920	3	009100165
16	22,0	55	20	4.920	3	009100166
17	23,5	55	22	4.920	3	009100167
18	24,5	55	23	5.350	2	009100168
19	25,0	55	24	5.350	2	009100169
21	27,0	65	26	5.830	2	009100171
22	29,0	65	28	5.830	2	009100172

910AL/SB14 Ft 76.800 1 009100174

8-9-10-11-12-13-14
15-16-17-18-19-21-22 mm

910BL

Tizenkétszögű hosszú dugókulcs



UNI/ISO 2725 DIN 3124

mm	Ø	L	Ø1	Ft	csomagolás
8	12,0	55	17	4.500	3 009100308
9	13,0	55	17	4.500	3 009100309
10	14,5	55	17	4.500	3 009100310
11	16,0	55	17	4.500	3 009100311
12	17,0	55	17	4.500	3 009100312
13	18,0	55	17	4.920	3 009100313
14	20,0	55	18	4.920	3 009100314
15	21,0	55	20	4.920	3 009100315
16	22,0	55	20	4.920	3 009100316
17	23,5	55	22	4.920	3 009100317
18	24,5	55	23	5.350	2 009100318
19	25,0	55	24	5.350	2 009100319
21	27,0	65	26	5.830	2 009100321
22	29,0	65	28	5.830	2 009100322



		Ft	csomagolás
910BL/SB14	8-9-10-11-12-13 14-15-16-17-18 19-21-22 mm	76.800	1 009100340

910B/SN

Tizenkétszögű csuklós dugókulcs



mm	Ø	L	Ø1	Ft	csomagolás
10	14,5	48,5	19	11.600	2 009100230
11	15,8	49,5	19	11.600	2 009100231
12	17,0	50,0	19	11.600	2 009100232
13	18,3	51,0	19	11.600	2 009100233
14	19,5	51,0	19	13.050	2 009100234
15	20,8	53,5	19	13.050	2 009100235
16	22,0	53,5	19	13.050	2 009100236
17	23,3	54,5	19	13.050	2 009100237
18	24,5	54,5	19	13.050	2 009100238
19	25,8	56,5	19	13.050	2 009100239

910A/AS

Hatlapú dugókulcs



"	Ø	L	Ø1	Ft	csomagolás
1/4	10,3	26	17,3	2.540	5 009100276
5/16	11,9	26	17,3	2.540	5 009100278
11/32	13,3	26	17,3	2.540	5 009100279

"	Ø	L	Ø1	Ft	csomagolás
3/8	13,9	26	17,3	2.540	5 009100280
7/16	15,8	26	17,3	2.540	5 009100281
1/2	17,9	26	17,3	2.620	5 009100283
9/16	19,5	27	18,5	2.620	5 009100284
19/32	20,6	27	19,5	2.620	5 009100285
5/8	21,9	28	20,0	2.830	5 009100286
11/16	24,6	30	22,5	2.830	5 009100287
3/4	25,9	30	23,5	2.830	5 009100289
13/16	27,9	32	26,0	3.130	5 009100291
7/8	29,6	32	26,5	3.290	5 009100292



		Ft	csomagolás
910A-AS/SB13	1/4-5/16-11/32-3/8-7/16 1/2-9/16-19/32-5/8-11/16 3/4-13/16-7/8	42.400	1 009100295

910AS

Tizenkétszögű dugókulcs



"	Ø	L	Ø1	Ft	csomagolás
1/4	9,5	28	16,7	2.540	5 009100201
5/16	12,1	28	16,7	2.540	5 009100202
11/32	13,2	28	16,7	2.540	5 009100203
3/8	14,6	29	16,7	2.540	5 009100204
7/16	15,8	29	16,7	2.540	5 009100205
1/2	18,4	31	17,0	2.620	5 009100206
9/16	19,7	32	17,5	2.620	5 009100207
19/32	20,9	32	18,0	2.620	5 009100208
5/8	22,2	33	18,5	2.830	5 009100209
11/16	24,7	34	20,0	2.830	5 009100210
3/4	25,8	35	21,0	2.830	5 009100211
13/16	28,2	36	23,0	3.130	5 009100212
7/8	29,7	37	24,0	3.290	5 009100213



		Ft	csomagolás
910AS/SB13	1/4-5/16-11/32-3/8-7/16 1/2-9/16-19/32-5/8-11/16 3/4-13/16-7/8	42.400	1 009100215

910AS/L

Tizenkétszögű hosszú dugókulcs

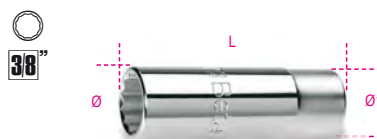

"	Ø	L	Ø1	Ft	csomagolás
1/4	10	55	17	5.620	3 009100350
5/16	12	55	17	5.620	3 009100351
3/8	14	55	17	5.620	3 009100352
7/16	16	55	17	5.620	3 009100353
1/2	18	55	17	6.260	3 009100354
9/16	20	55	18	6.260	3 009100355

"	Ø	L	Ø1	Ft	csomagolás
19/32	21	55	20	6.520	3 009100356
5/8	22	55	20	6.520	3 009100357
11/16	23	55	22	6.520	3 009100359
3/4	25	55	24	6.880	3 009100360
13/16	27	65	26	8.230	3 009100362
7/8	29	65	28	8.230	3 009100363



		Ft	csomagolás
910ASL/SB12	1/4-5/16-3/8-7/16 1/2-9/16-19/32-5/8-11/16 3/4-13/16-7/8	84.450	1 009100365

910AS/SN

Tizenkétszögű csuklós dugókulcs



* SAE AS 954E

"	Ø	L	Ø1	Ft	csomagolás
* 3/8	14,0	48,0	19	12.900	2 009100260
* 7/16	15,8	51,0	19	12.900	2 009100261
* 1/2	18,3	51,0	19	12.900	2 009100262
* 9/16	19,5	51,0	19	13.050	2 009100263
* 5/8	22,0	53,5	19	13.050	2 009100264
11/16	24,5	54,5	19	13.900	2 009100265
3/4	25,8	56,5	19	13.900	2 009100266

910FTX

Dugókulcs Torx®-csavarokhoz



"	Ø	L	Ø1	Ft	csomagolás
E4	6,2	26	17,3	3.060	5 009100404
E5	7,0	26	17,3	3.060	5 009100405
E6	8,3	26	17,3	3.060	5 009100406
E7	8,9	26	17,3	3.060	5 009100407
E8	9,9	26	17,3	3.060	5 009100408
E10	12,0	26	17,3	3.060	5 009100410
E11	13,3	26	17,3	3.060	5 009100411
E12	14,5	26	17,3	3.060	5 009100412
E14	15,8	26	17,3	3.060	5 009100414
E16	18,0	26	17,3	3.120	5 009100416
E18	19,5	26	18,5	3.580	3 009100418
E20	21,9	26	20,0	3.580	3 009100420



		Ft	csomagolás
910FTX/SB9	E4-E5-E6-E7-E8 E10-E12-14-E16	32.700	1 009100430

910FTX/L

Hosszú dugókulcs Torx®-csavarokhoz



	Ø mm	L mm	Ø1 mm	Ft		
E4	6,2	55	17,3	6.800	3	009100440
E5	7,0	55	17,3	6.800	3	009100441
E6	8,3	55	17,3	6.800	3	009100442
E7	8,9	55	17,3	6.800	3	009100443
E8	9,9	55	17,3	6.800	3	009100444
E10	12,0	55	17,3	6.800	3	009100445



	Ft		
910FTX-L/SB6 E4-E5-E6 E7-E8-E10	44.700	1	009100449

910FTX/XL

extra hosszú hatszögű dugókulcs Torx® csavarokhoz



	Ø mm	L mm	Ø1 mm	Ft		
E6	8,0	200	18	6.210	2	009100766
E7	8,0	200	18	6.210	2	009100767
E8	10,0	200	18	6.210	2	009100768
E10	14,0	200	18	6.210	2	009100770
E11	14,0	200	18	6.210	2	009100771
E12	14,0	200	18	6.210	2	009100772
E14	17,0	200	18	6.750	2	009100774
E16	18,6	200	18	6.750	2	009100776
E18	21,5	200	18	7.130	2	009100778
E20	21,5	200	18	7.130	2	009100780

910FTX-XL/C10

10 részes hosszú dugókulcs szerszám készlet Torx®-csavarokhoz műanyag dobozban



	Ft		
910FTX-XL/C10 E6-E7-E8-E10-E11- E12-E14-E16-E18-E20	65.000	1	009100976

255x195x62 mm - 2,3 kg

910LP

Csavarhúzó-dugókulcs hasítottfejű csavarokhoz, krómozott, barnított fej

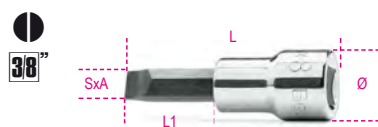

SxA mm	Ø mm	L mm	L1 mm	Ft		
1x5,5	18,5	54	24	5.350	2	009100452
1,2x6,5	18,5	54	24	5.350	2	009100453
1,2x8	18,5	54	24	5.350	2	009100454
1,6x9	18,5	54	24	5.350	2	009100456

910PH

Csavarhúzó-dugókulcs Phillips®-csavarokhoz, krómozott, barnított fej



PH	Ø mm	L mm	L1 mm	Ft		
1	18,5	48	18	4.950	2	009100471
2	18,5	48	18	4.950	2	009100472
3	18,5	48	18	4.950	2	009100473
4	18,5	48	18	4.950	2	009100474



	Ft		
910PH/SB4 PH1-PH2-PH3-PH4	22.900	1	009100478

910PE

3/8"-os imbusz-dugókulcs, krómozott, fekete hegygel



DIN 7422

mm	Ø mm	L mm	L1 mm	Ft		
3	18,5	50	20	4.330	5	009100490
4	18,5	50	20	4.330	5	009100492
5	18,5	50	20	4.330	5	009100494
6	18,5	50	20	4.330	5	009100496
7	18,5	50	20	4.330	5	009100497
8	18,5	50	20	4.330	5	009100498
9	18,5	50	20	4.330	5	009100499
10	18,5	50	20	4.330	5	009100500



	Ft		
910PE/SB7 3-4-5-6-7-8-10 mm	34.600	1	009100503

910BP

hatlapfejű külső dugókulcs gömbölyű véggel



mm	L mm	L1 mm	Ft		
4L	92	62	5.950	3	009100584
5L	92	62	5.950	3	009100585
6L	92	62	5.950	3	009100586
7L	92	62	5.950	3	009100587
8L	92	62	5.950	3	009100588
10L	132	102	6.460	3	009100590



	Ft		
910BP/SB6L 4L-5L-6L-7L-8L-10L mm	40.100	1	009100596

910ME

3/8"-os imbusz-dugókulcs, krómozott



mm	Ø mm	L mm	L1 mm	Ft		
4	18	62	15	5.220	5	009100504
5	18	62	15	5.220	5	009100505
6	18	62	15	5.220	5	009100506
7	18	62	15	5.270	5	009100507
8	19	62	15	5.270	5	009100508
10	20	62	15	5.270	5	009100510
12	20	62	15	5.270	5	009100512



	Ft		
910ME/SB5 4-5-6-8-10 mm	29.700	1	009100515

910PE/AS

imbusz dugókulcs



"	Ø mm	L mm	L1 mm	Ft		
1/8	18,5	50	20	10.450	2	009100531
5/32	18,5	50	20	10.450	2	009100532
3/16	18,5	50	20	10.450	2	009100533
7/32	18,5	50	20	10.450	2	009100534
1/4	18,5	50	20	10.450	2	009100535
5/16	18,5	50	20	10.450	2	009100536
3/8	18,5	50	20	11.600	2	009100537

910PT

Ötlapú imbusz dugókulcs



	Ø mm	L mm	L1 mm	Ft		
PT40	20	50	20	8.020	3	009100540
PT45	20	50	20	8.220	3	009100545
PT50	20	50	20	9.780	3	009100550



	Ft		
910PT/SB8	66.500	1	009100558
PT10-PT15-PT20-PT25			
PT30-PT40-PT45-PT50			

910TX

3/8"-os Torx® imbusz-dugókulcs, krómozott, fekete hegy



	Ø mm	L mm	L1 mm	Ft		
T15	18,5	50	20	5.770	5	009100519
T20	18,5	50	20	5.770	5	009100520
T25	18,5	50	20	5.770	5	009100521
T27	18,5	50	20	5.770	5	009100522
T30	18,5	50	20	5.770	5	009100523
T40	18,5	50	20	5.770	5	009100524
T45	18,5	50	20	5.770	3	009100525
T50	18,5	50	20	5.770	3	009100526



	Ft		
910TX/SB6	38.500	1	009100530
T15-T20-T25			
T27-T30-T40			

910XZN

dugókulcs
XZN® profilú



	L mm	Ft		
M4	50	3.870	3	009100559
M5	50	3.870	3	009100560
M6	50	3.870	3	009100561
M8	50	3.870	3	009100563
M10	50	4.260	3	009100565

910CF

3/8"-os villás dugókulcs



	A mm	L mm	Ft		
10	21,3	32,3	3.700	2	009100135
11	23,1	34,3	3.700	2	009100136
12	25,5	36,2	4.120	2	009100137
13	26,9	37,4	4.120	2	009100138
14	30,2	40,0	4.340	2	009100139
15	33,3	41,3	4.540	2	009100140
16	33,3	41,3	4.830	2	009100141
17	38,1	46,5	5.770	2	009100142
18	38,1	46,5	5.770	2	009100143
19	39,6	48,0	5.980	2	009100144



	Ft		
910CF/SB10	52.600	1	009100147
10-11-12-13-14-15			
16-17-18-19 mm			

910/15

Szűkítő közbetét 3/8" és 1/4"



L mm	Ø mm	□	□	Ft		
30	17,0	3/8	1/4	3.530	5	009100810



Ügyeljünk a forgató nyomatékra, fokozatosan növeljük, hogy a törést, illetve az esetleges sérülést elkerüljük.

910/16

Bővítő közbetét 3/8" és 1/2"



L mm	Ø mm	□	□	Ft		
32	18,0	3/8	1/2	3.870	5	009100814



910/20 - 910/21 - 910/22

3/8"-os toldó

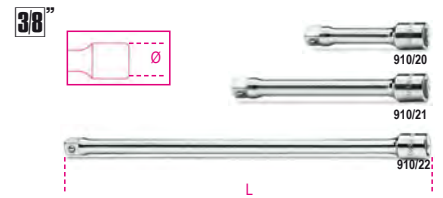

	L mm	Ø mm	Ft		
910/20	75	17	3.140	5	009100820
910/21	125	17	4.660	5	009100822
910/22	250	17	6.000	5	009100826

910AN

3/8"-os gömbvégű toldó

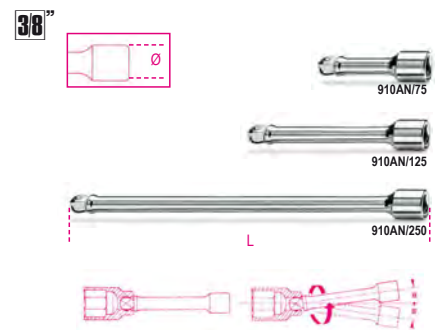

	L mm	Ø mm	Ft		
910AN/75	75	17	4.390	3	009100827
910AN/125	125	17	5.560	3	009100828
910AN/250	250	17	8.130	3	009100829

910/25

3/8"-os csukló



L mm	Ø mm	Ft		
54,6	19	8.060	5	009100830

910M/35

3/8"-os csuklós fém hajtószár



L mm	Ft		
250	23.050	3	009100839

910/36A

3/8"-os csuklós hajtószer, krómozott



UNI/ISO 3315 DIN 3122

L	L1	Ft	📦	📄
mm 255	mm 154	15.800	3	009100845

910/40

3/8"-os csuklós T-hajtószer, krómozott



L	L1	Ft	📦	📄
mm 420	mm 175	17.150	3	009100850

910/42

3/8"-os csúszkás T-hajtószer

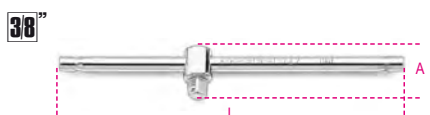

UNI/ISO 3315 DIN 3122

L	A	Ft	📦	📄
mm 210	mm 30,5	5.290	5	009100854

910/46

3/8"-os forgattyús hajtószer, krómozott

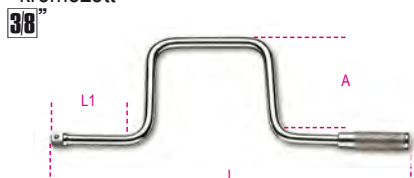

UNI/ISO 3315 DIN 3122

L	L1	A	Ft	📦	📄
mm 315	mm 80	mm 115	10.450	1	009100862

910/55

3/8"-os irányváltós racsní, 72 fogú, krómozott



UNI/ISO 3315 DIN 3122

L	Ø	A	Ft	📦	📄
mm 200	mm 30	mm 33	19.900	3	009100882

910/55Q

3/8"-os irányváltós racsní, 48 fogú, krómozott



UNI/ISO 3315 DIN 3122

L	Ø	A	Ft	📦	📄
mm 200	mm 30	mm 33	19.900	3	009100885

Nyomatékkulcs csatlakozási méretei, lásd a táblázatot a 929/C8 cikkszám alatt!

910M/55

3/8"-os irányváltós fémracsní



DIN 3122 - UNI ISO 3315

L	Ø	A	Ft	📦	📄
mm 178	mm 30	mm 26	27.150	2	009100875

910M/56

3/8"-os irányváltós csuklós fémracsní



L	Ø	A	Ft	📦	📄
mm 265	mm 31	mm 29	36.600	2	009100887

910/58

Irányváltós racsní
3/8"
52 fogú

- Hajtószer
- Nyitó és rögzítő gomb
- Irányváltás a fejen lévő műanyag gyűrű jobbra és balra forgatásával
- Bimateriál-nyél



L	Ø	A	Ft	📦	📄
mm 222	mm 37	mm 38,5	30.150	1	009100884

910.../C10

10 dugókulcs és 2 tartozék fémdobozban



910A/C10	Ft	📦	📄
	58.900	1	009100909

910A	6 - 7 - 8 - 10 - 11 - 12 13 - 14 - 17 - 19 mm
910/21	125 mm
910/55	

270x120x45 mm - 1,3 kg

910B/C10	Ft	📦	📄
	58.900	1	009100910

910B	6 - 7 - 8 - 10 - 11 - 12 13 - 14 - 17 - 19 mm
910/21	125 mm
910/55	

270x120x45 mm - 1,3 kg

910A/C16...

16 dugókulcs és 5 tartozék fémdobozban



910A/C16	Ft	📦	📄
	94.350	1	009100936

910A	6 - 7 - 8 - 9 - 10 - 11 - 12 - 13 14 - 15 - 16 - 17 - 18 - 19 21 - 22 mm
910/21	125 mm
910/22	250 mm
910/25	
910/42	
910/55	

335x145x60 mm - 2,3 kg

9899 910C16	Ft	📦	📄
	5.310	1	098990134

Hőformált tálcá, üres

910A/C16Q	Ft	📦	📄
	94.350	1	009100932

910A	6 - 7 - 8 - 9 - 10 - 11 - 12 - 13 14 - 15 - 16 - 17 - 18 - 19 21 - 22 mm
910/21	125 mm
910/22	250 mm
910/25	
910/42	
910/55Q	

335x145x60 mm - 2,3 kg

9899 910C16	Ft	📦	📄
	5.310	1	098990134

Hőformált tálcá, üres

910B/C16...

16 dugókulcs és 5 tartozék fémdobozban

38"



910B/C16 Ft 94.350 1 009100937

- 910B 6 - 7 - 8 - 9 - 10 - 11 - 12 - 13
14 - 15 - 16 - 17 - 18 - 19
21 - 22 mm
 - 910/21 125 mm
 - 910/22 250 mm
 - 910/25
 - 910/42
 - 910/55
- 335x145x60 mm - 2,3 kg

9899 910C16 5.310 1 098990134
Hőformált tálcá, üres

910B/C16Q Ft 94.350 1 009100933

- 910B 6 - 7 - 8 - 9 - 10 - 11 - 12 - 13
14 - 15 - 16 - 17 - 18 - 19
21 - 22 mm
 - 910/21 125 mm
 - 910/22 250 mm
 - 910/25
 - 910/42
 - 910/55Q
- 335x145x60 mm - 2,3 kg

9899 910C16 5.310 1 098990134
Hőformált tálcá, üres

910A/C17

17 hatlapú dugókulcs és 9 tartozék fémdobozban

38"



910A/C17 Ft 141.100 1 009100938

- 910A 6 - 7 - 8 - 9 - 10 - 11 - 12 - 13
14 - 15 - 16 - 17 - 18 - 19 - 20
21 - 22 mm
 - 910/15 □ 3/8 - ■ 1/4
 - 910/16 □ 3/8 - ■ 1/2
 - 910/21 125 mm
 - 910/22 250 mm
 - 910/25
 - 910/36A
 - 910/42
 - 910/46
 - 910/55
- 420x280x60 mm - 4,0 kg

910.../C29

17 dugókulcs 12 csavarhúzó-dugókulcs és 5 tartozék fémdobozban

38"



910A/C29 Ft 157.600 1 009100944

- 910A 6 - 7 - 8 - 9 - 10 - 11 - 12 - 13
14 - 15 - 16 - 17 - 18 - 19 - 20
21 - 22 mm
 - 910LP 1x5,5 - 1,2x6,5 - 1,2x8 mm
 - ⊕ 910PH PH1 - PH2 - PH3
 - 910PE 3 - 4 - 5 - 6 - 8 - 10 mm
 - 910/21 125 mm
 - 910/22 250 mm
 - 910/25
 - 910/42
 - 910/55
- 420x185x60 mm - 3,5 kg

910B/C29 Ft 157.600 1 009100945

- 910B 6 - 7 - 8 - 9 - 10 - 11 - 12 - 13
14 - 15 - 16 - 17 - 18 - 19 - 20
21 - 22 mm
 - 910LP 1x5,5 - 1,2x6,5 - 1,2x8 mm
 - ⊕ 910PH PH1 - PH2 - PH3
 - 910PE 3 - 4 - 5 - 6 - 8 - 10 mm
 - 910/21 125 mm
 - 910/22 250 mm
 - 910/25
 - 910/42
 - 910/55
- 420x185x60 mm - 3,5 kg

910AS/C13...

13 dugókulcs és 5 tartozék fémdobozban

38"



910AS/C13 Ft 93.800 1 009100925

- 910AS 1/4 - 5/16 - 11/32 - 3/8 - 7/16
1/2 - 9/16 - 19/32 - 5/8 - 11/16
3/4 - 13/16 - 7/8
 - 910/21 125 mm
 - 910/22 250 mm
 - 910/42
 - 910/25
 - 910/55
- 335x145x60 mm - 2,3 kg

910AS/MBM-C18

13 db-os inch-es dugókulcs készlet 5 tartozékkal, fémdobozban

38"



910AS/MBM-C18 Ft 101.000 1 009100926

- 910AS 1/4 - 5/16 - 11/32 - 3/8 - 7/16
1/2 - 9/16 - 19/32 - 5/8 - 11/16
3/4 - 13/16 - 7/8
 - 910/21 125 mm
 - 910/22 250 mm
 - 910/25
 - 910/42
 - 910M/55
- 335x145x60 mm - 2,5 kg

910A/C16HR

16 hatlapú dugókulcs és 5 tartozék szivacsbetétes fémdobozban

• forgó markolatós racsni

38"



910A/C16HR Ft 104.600 1 009100935

- 910A 6 - 7 - 8 - 9 - 10 - 11 - 12 - 13
14 - 15 - 16 - 17 - 18 - 19
21 - 22 mm
 - 910/21 125 mm
 - 910/22 250 mm
 - 910/25
 - 910/42 210 mm
 - 910/58
- 335x145x60 mm - 2,4 kg



920A

Hatlapú dugókulcs



UNI/ISO 2725 DIN 3124

Ø mm	Ø mm	L mm	Ø1 mm	Ft	🔧	📄
8	12,4	38	21,7	1.620	10	009200008
9	13,5	38	21,7	1.620	10	009200009
10	14,9	38	21,7	1.620	10	009200010
11	16,1	38	21,7	1.620	10	009200011
12	17,5	38	21,7	1.620	10	009200012
13	18,7	38	21,7	1.800	10	009200013
14	20,1	38	21,7	1.800	10	009200014
15	21,5	38	22,5	1.800	10	009200015
16	22,7	38	23,7	1.940	10	009200016
17	24,1	38	23,1	1.940	10	009200017
18	25,3	39	24,0	1.940	10	009200018
19	26,6	39	24,0	1.940	10	009200019
20	27,8	40	25,0	2.220	5	009200020
21	28,8	40	25,0	2.220	5	009200021
22	29,9	41	26,0	2.220	5	009200022
23	30,8	42	26,0	2.420	5	009200023
24	32,2	43	27,0	2.420	5	009200024
25	33,2	44	27,0	2.420	5	009200025
26	34,7	45	28,0	2.450	5	009200026
27	36,2	46	29,0	2.450	5	009200027
28	37,2	47	30,0	2.450	5	009200028
29	38,6	48	31,0	2.640	5	009200029
30	40,2	48	32,0	2.640	5	009200030
32	42,3	49	34,0	2.760	5	009200032



920A/SB13	Ft	🔧	📄
10-11-12-13-14-15-16 17-18-19-20-21-22 mm	31.650	1	009200040



920A/SB8	Ft	🔧	📄
23-24-25-26-27-28-30-32 mm	24.850	1	009200042

920MC

hatszögű dugókulcs,
színezett

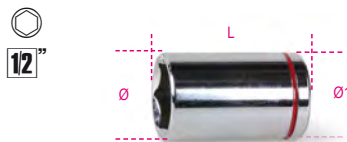

Ø mm	Ø mm	L mm	Ø1 mm	Ft	🔧	📄
8	13,2	38	22	2.210	5	009202008
10	15,3	38	22	2.210	5	009202010
11	16,5	38	22	2.210	5	009202011
12	17,8	38	22	2.210	5	009202012
13	19,0	38	22	2.210	5	009202013
14	20,3	38	22	2.210	5	009202014
15	21,6	38	22	2.210	5	009202015
16	23,0	38	23	2.300	5	009202016
17	23,9	38	24	2.300	5	009202017
18	25,0	38	25	2.300	5	009202018
19	26,5	38	24	2.300	5	009202019
21	28,8	38	27	2.370	3	009202021
22	29,9	40	28	2.370	3	009202022
24	32,8	40	30	2.400	3	009202024

920B

1/2"-os tizenkétszögű dugókulcs

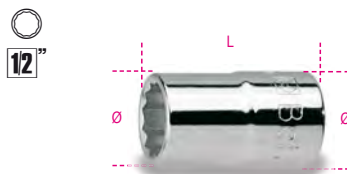

UNI/ISO 2725 DIN 3124

Ø mm	Ø mm	L mm	Ø1 mm	Ft	🔧	📄
8	12,4	38	21,7	1.620	10	009200108
9	13,5	38	21,7	1.620	10	009200109
10	14,9	38	21,7	1.620	10	009200110
11	16,1	38	21,7	1.620	10	009200111
12	17,5	38	21,7	1.620	10	009200112
13	18,7	38	21,7	1.800	10	009200113
14	20,1	38	21,7	1.800	10	009200114
15	21,5	38	22,5	1.800	10	009200115
16	22,7	38	23,7	1.940	10	009200116
17	24,1	38	23,1	1.940	10	009200117
18	25,3	39	24,0	1.940	10	009200118
19	26,6	39	24,0	1.940	10	009200119
20	27,8	40	25,0	2.220	5	009200120
21	28,8	40	25,0	2.220	5	009200121
22	29,9	41	26,0	2.220	5	009200122
23	30,8	42	26,0	2.420	5	009200123
24	32,2	43	27,0	2.420	5	009200124
25	33,2	44	27,0	2.420	5	009200125
26	34,7	45	28,0	2.450	5	009200126
27	36,2	46	29,0	2.450	5	009200127
28	37,2	47	30,0	2.450	5	009200128
29	38,6	48	31,0	2.640	5	009200129
30	40,2	48	32,0	2.640	5	009200130
32	42,3	49	33,9	2.760	5	009200132



920B/SB13	Ft	🔧	📄
10-11-12-13-14-15-16 17-18-19-20-21-22 mm	31.650	1	009200140



920B/SB8	Ft	🔧	📄
23-24-25-26-27 28-30-32 mm	24.850	1	009200142

920AL

Hatlapú dugókulcs,
hosszított kivitel



UNI/ISO 2725 DIN 3124

Ø mm	Ø mm	L mm	Ø1 mm	Ft	🔧	📄
10	14,7	77	21	4.610	5	009200626
12	17,8	77	21	4.610	5	009200627
13	19,0	77	22	4.610	5	009200628
14	20,3	77	22	4.610	5	009200629
15	21,5	77	22	4.610	5	009200630
16	22,8	77	22	4.750	5	009200631
17	24,0	77	23	4.750	5	009200632
18	25,0	77	24	5.190	5	009200633
19	26,5	77	25	5.190	5	009200634
21	29,0	77	27	5.770	5	009200635
22	30,0	77	28	5.770	5	009200636
23	31,5	77	29	5.770	5	009200637
24	32,8	77	30	6.530	5	009200638
27	36,5	77	33	6.510	3	009200639
30	40,0	77	36	8.310	3	009200640
32	42,8	77	38	8.310	3	009200641
36	48,0	77	41	13.650	3	009200642



920AL/SB11	Ft	🔧	📄
10-12-13-14-15-16 17-18-19-21-22 mm	60.600	1	009200644

920BL

Tizenkétszögű hosszú dugókulcs

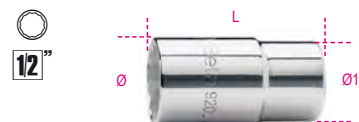

UNI/ISO 2725 DIN 3124

Ø mm	Ø mm	L mm	Ø1 mm	Ft	🔧	📄
10	14,7	77	21	4.610	5	009200310
12	17,8	77	21	4.610	5	009200312
13	19,0	77	22	4.610	5	009200313
14	20,3	77	22	4.610	5	009200314
15	21,5	77	22	4.610	5	009200315
16	22,8	77	22	4.750	5	009200316
17	24,0	77	23	4.750	5	009200317
18	25,0	77	24	5.190	5	009200318
19	26,5	77	25	5.190	5	009200319
21	29,0	77	27	5.770	5	009200321
22	30,0	77	28	5.770	5	009200322
23	31,5	77	29	5.770	5	009200323
24	32,8	77	30	6.530	5	009200324
27	36,5	77	33	6.510	3	009200327
30	40,0	77	36	8.310	3	009200330
32	42,8	77	38	8.310	3	009200332
36	48,0	77	41	13.650	3	009200336



920BL/SB11	Ft	🔧	📄
10-12-13-14-15-16-17-18 19-21-22 mm	60.600	1	009200338



920A/AS

Hatlapú dugókulcs



"	Ø mm	L mm	Ø1 mm	Ft		
3/8	14,6	37	21	1.870	2	009200270
7/16	16,5	37	21	1.870	3	009200272
1/2	19,0	37	22	1.990	3	009200273
9/16	20,3	37	22	1.990	3	009200274
19/32	21,0	37	22	2.190	3	009200275
5/8	22,8	37	22	2.190	3	009200276
11/16	25,0	37	24	2.210	3	009200277
3/4	26,5	38	25	2.210	3	009200279
25/32	28,0	38	26	2.530	3	009200280
13/16	29,0	38	27	2.530	3	009200281
7/8	30,0	40	28	2.530	3	009200282
15/16	32,8	42	30	2.640	3	009200284
1	35,0	42	32	2.640	3	009200285
1.1/16	36,5	43	33	2.870	2	009200287
1.1/8	39,0	43	35	2.950	2	009200289
1.3/16	41,0	46	36	3.220	2	009200290
1.1/4	42,8	46	38	3.210	2	009200292



920A-AS/SB11 Ft 30.800 1 009200295
3/8-7/16-1/2-9/16-5/8
11/16-3/4-13/16-7/8
15/16-1

920AS

Tizenkétcszögű dugókulcs

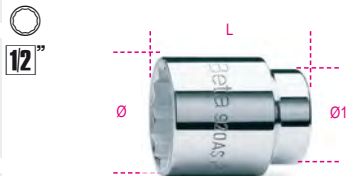

"	Ø mm	L mm	Ø1 mm	Ft		
3/8	14,9	38	21,7	1.870	3	009200201
7/16	16,1	38	21,7	1.870	3	009200202
1/2	18,7	38	21,7	1.990	3	009200203
9/16	20,1	38	21,7	1.990	3	009200204
5/8	22,7	38	22,5	2.190	3	009200206
19/32	21,5	38	23,7	2.190	3	009200207
11/16	25,3	39	24,0	2.210	3	009200208
3/4	26,6	39	24,0	2.210	3	009200209
25/32	27,8	40	25,0	2.530	3	009200210
13/16	28,8	40	25,0	2.530	3	009200211
7/8	29,9	41	26,0	2.530	3	009200212
15/16	32,2	43	27,0	2.640	3	009200214
1	34,2	45	28,0	2.640	3	009200216
1.1/16	36,2	46	29,0	2.870	2	009200217
1.1/8	38,6	48	31,0	2.950	2	009200218
1.3/16	40,2	48	32,0	3.220	2	009200219
1.1/4	42,3	49	33,5	3.210	2	009200220



920AS/SB11 Ft 30.800 1 009200225
3/8-7/16-1/2-9/16-5/8
11/16-3/4-13/16-7/8
15/16-1

920AS/L

Tizenkétcszögű hosszú dugókulcs



"	Ø mm	L mm	Ø1 mm	Ft		
1/2	19,0	77	22	6.330	2	009200352
9/16	20,3	77	22	6.330	2	009200353
5/8	22,8	77	22	6.330	2	009200355
11/16	25,0	77	24	6.310	2	009200357
3/4	26,5	77	25	6.960	2	009200358
13/16	29,0	77	27	7.960	2	009200360
7/8	30,0	77	28	7.960	2	009200361
15/16	32,8	77	30	8.000	2	009200362
1	35,0	77	32	8.820	2	009200363
1.1/16	36,5	77	33,0	9.360	2	009200364
1.1/8	37,8	77	34	9.740	2	009200365



920ASL/SB11 Ft 90.250 1 009200369
1/2-9/16-5/8-11/16
3/4-13/16-7/8-15/16
1-1.1/8-1.1/16

920U

multifunkciós dugókulcsok



mm	"	Ø	Ø1	L	Ft		
10	3/8	E12	M12	38	2.150	5	009201710
11	7/16	E14	M14	38	2.150	5	009201711
12	15/32	E16		38	2.150	5	009201712
13	1/2	M16		38	2.170	5	009201713
14	9/16	E18	M18	38	2.170	5	009201714
15	19/32			38	2.170	5	009201715
16	5/8	E20		38	2.200	5	009201716
17				38	2.200	5	009201717
18		E22		38	2.200	5	009201718
19	3/4	E24		38	2.200	5	009201719
20	25/32			38	2.260	3	009201720
21				38	2.260	3	009201721
22	7/8			38	2.260	3	009201722
24	15/16			38	2.310	3	009201724
27	1.1/16			42	2.340	3	009201727
30	1.1/8			44	2.430	3	009201730
32	1.1/4			44	2.620	3	009201732



920U/SB13 Ft 35.500 1 009201740
10-11-12-13-14-15-16
17-18-19-20-21-22 mm



920U/SB4 Ft 12.800 1 009201744
24-27-30-32 mm

920FTX

Dugókulcs Torx®-csavarokhoz

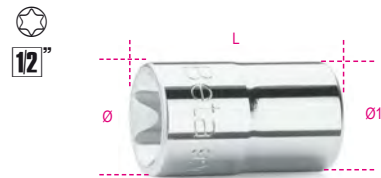

"	Ø mm	L mm	Ø1 mm	Ft		
E10	13,2	36	21	2.750	5	009200380
E12	15,0	37	21	2.750	5	009200381
E14	16,3	37	21	2.750	5	009200382
E16	18,8	37	22	2.750	5	009200383
E18	20,4	37	22	2.750	5	009200384
E20	22,9	37	22	2.930	5	009200385
E22	25,0	37	24	3.450	3	009200387
E24	26,5	40	25	3.860	3	009200388



920FTX/SB6 Ft 20.550 1 009200390
E10-E12-E14
E16-E18-E20



920FTX/C8 Ft 36.500 1 009200391
E10-E12-E14-E16
E18-E20-E22-E24

270X120X45 mm - 1 kg

920FTX/L

Hosszú dugókulcs Torx®-csavarokhoz



"	Ø mm	L mm	Ø1 mm	Ft		
E10	13,2	77	21,0	5.790	5	009200400
E12	15,0	77	21,0	5.790	5	009200401
E14	16,3	77	21,0	5.790	5	009200402
E16	18,8	77	21,8	5.790	3	009200403
E18	20,4	77	21,8	5.790	3	009200404
E20	22,9	77	22,0	5.790	3	009200405



920FTX-LSB6 Ft 38.600 1 009200409
E10-E12-E14
E16-E18-E20

920LP

Csavarhúzó-dugókulcs hasítottfejű csavarokhoz, krómozott, barnított fej



SxA mm	Ø mm	L mm	L1 mm	Ft	🔧	📦
1x5,5	22,5	62	24	4.490	3	009200452
1,2x6,5	22,5	62	24	4.490	3	009200453
1,2x8	22,5	62	24	4.490	3	009200454
1,6x9	22,5	62	24	4.490	3	009200456
2x12	22,5	62	24	4.490	3	009200458

920PH

Csavarhúzó-dugókulcs Phillips®-csavarokhoz, krómozott, barnított fej



PH	Ø mm	L mm	L1 mm	Ft	🔧	📦
1	22,5	56	18	3.930	3	009200471
2	22,5	56	18	3.930	3	009200472
3	22,5	56	18	3.930	3	009200473
4	22,5	56	18	3.930	3	009200474



920PH/SB4	Ft	🔧	📦
PH1-PH2-PH3-PH4	18.800	1	009200479

920LH/SB7

Csavarhúzó-dugókulcs készlet Phillips(R)-csavarokhoz krómozott, barnított fej



920LH/SB7	Ft	🔧	📦
920LP 1,2x6,5 - 1,2x8 1,6x9 - 2x12 mm 920PH PH2 - PH3 - PH4	34.050	1	009200478

920PE

1/2"-os imbusz-dugókulcs, krómozott, barnított hegy

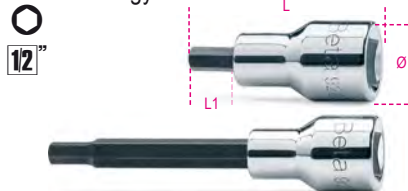

mm	Ø mm	L mm	L1 mm	Ft	🔧	📦
3	22,5	58	20	3.610	5	009200410
4	22,5	58	20	3.610	5	009200412
5	22,5	58	20	3.610	5	009200414

mm	Ø mm	L mm	L1 mm	Ft	🔧	📦
5L	22,5	100	62	3.930	5	009200415
6	22,5	58	20	3.610	5	009200417
6L	22,5	100	62	3.930	5	009200418
7	22,5	58	20	3.610	5	009200420
7L	22,5	100	62	3.930	5	009200421
8	22,5	58	20	3.610	5	009200423
8L	22,5	100	62	3.930	5	009200424
9	22,5	58	20	3.610	5	009200425
9L	22,5	140	102	4.220	5	009200426
10	22,5	58	20	3.610	5	009200428
10L	22,5	140	102	4.220	5	009200429
12	23,0	58	20	4.200	5	009200432
12L	22,5	140	102	4.770	5	009200433
14	23,0	58	20	4.200	5	009200434
14L	22,5	140	102	4.770	5	009200435
17	29,5	60	22	5.130	5	009200437
19	29,5	60	22	5.130	5	009200439



920PE/SB9	Ft	🔧	📦
4-5-6-8-10 mm 5L-6L-8L-10L mm	39.150	1	009200441



920PE/C10	Ft	🔧	📦
4-5-6-7-8-10 12-14-17-19 mm	52.800	1	009200443
📏 270X120X45 mm - 🏠 1,5 kg			

9899 920PE/C10	Ft	🔧	📦
Hőformált tálcá, üres	5.310	1	098990135

920PE/AS

Hatlapú imbusz-dugókulcs



"	Ø mm	L mm	L1 mm	Ft	🔧	📦
1/8	22,5	58	20	4.220	2	009200460
3/16	22,5	58	20	4.220	2	009200461
1/4	22,5	58	20	4.220	2	009200463
3/8	22,5	58	20	4.220	2	009200464
1/2	22,5	60	20	4.570	2	009200465
3/4	22,5	60	20	4.900	1	009200468



920PE-AS/SB6	Ft	🔧	📦
1/8-3/16-1/4-3/8-1/2-3/4	30.250	1	009200469

920BP

Hatlapú gömbfejű imbusz-dugókulcs

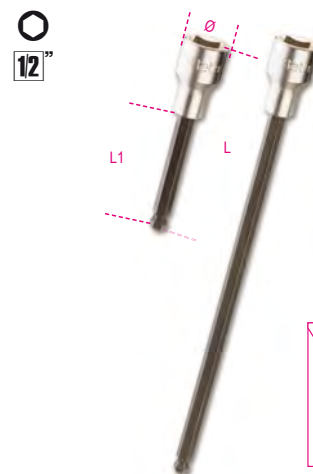

mm	Ø mm	L mm	L1 mm	Ft	🔧	📦
5L	22,5	100	62	4.490	5	009200490
5XL	22,5	240	202	5.830	1	009200495
6L	22,5	100	62	4.490	5	009200491
6XL	22,5	240	202	5.830	1	009200496
7L	22,5	100	62	4.490	5	009200492
8L	22,5	100	62	4.490	5	009200493
8XL	22,5	240	202	5.830	1	009200497
10L	22,5	140	102	4.870	5	009200494



920BP/SB8	Ft	🔧	📦
5L-6L-7L-8L-10L mm 5XL-6XL-8XL mm	45.150	1	009200500

920ME

1/2"-os imbusz-dugókulcs, krómozott



mm	Ø mm	L mm	L1 mm	Ft	🔧	📦
5	21	75	15,5	4.200	5	009200505
6	21	75	15,5	4.200	5	009200506
7	21	75	15,5	4.200	5	009200507
8	21	75	15,5	4.200	5	009200508
10	23	75	15,5	4.200	5	009200510
12	24	75	15,5	5.070	5	009200512
14	24	75	15,5	5.290	5	009200514
17	24	75	15,5	5.290	5	009200517



920ME/SB7	Ft	🔧	📦
5-6-8-10-12-14-17 mm	36.750	1	009200519

12"



920ME/C7
5-6-8-10-12-14-17 mm
Ft 41.800 1 009200518
250X100X35 mm - 1,4 kg

920TX

1/2"-os Torx® imbusz-dugókulcs, krómozott, barnított hegy

12"



Ø mm	L mm	L1 mm	Ft	1	009200520
T20	22,5	58	20	4.420	5 009200520
T20L	22,5	120	82	5.630	3 009200530
T25	22,5	58	20	4.420	5 009200521
T25L	22,5	120	82	5.630	3 009200531
T27	22,5	58	20	4.420	5 009200522
T27L	22,5	120	82	5.630	3 009200533
T30	22,5	58	20	4.420	5 009200523
T30L	22,5	120	82	5.630	3 009200534
T40	22,5	58	20	4.420	5 009200524
T40L	22,5	120	82	5.630	3 009200535
T45	22,5	58	20	4.420	5 009200525
T45L	22,5	120	82	5.630	3 009200537
T50	22,5	58	20	4.420	5 009200526
T50L	23,0	140	102	5.630	3 009200538
T55	23,0	58	20	5.880	3 009200527
T55L	23,0	140	102	7.890	3 009200539
T60	23,0	58	20	5.880	3 009200528
T60L	23,0	140	102	7.890	3 009200540
T70L	23,0	120	82	7.890	3 009200541

12"



920TX-SB9
T20-T25-T27-T30
T40-T45-T50-T55-T60
Ft 47.800 1 009200532



920TX-L/SB10
T20L-T25L-T27L-T30L-T40L-
T45L-T50L-T55L-T60L-T70L
Ft 68.850 1 009200545

12"



920TX/C9
T20-T25-T27-T30-T40
T45-T50-T55-T60
Ft 55.200 1 009200546
270X120X45 mm - 1,2 kg

9899 920TX/C9
Ft 5.310 1 098990136
Hőformált tálcá, üres

920RTX

Tamper Resistant Torx® imbusz-dugókulcs

12"



Ø mm	L mm	L1 mm	Ft	1	009200370
T20	22,5	58	20	4.740	5 009200370
T25	22,5	58	20	4.740	5 009200371
T27	22,5	58	20	4.740	5 009200372
T30	22,5	58	20	4.740	5 009200373
T40	22,5	58	20	4.740	5 009200374

12"



920RTX/SB5
T20-T25-T27-T30-T40
Ft 27.200 1 009200378

920XZN

1/2"-os XZN®-profilű imbusz-dugókulcs, krómozott, barnított fej

12"

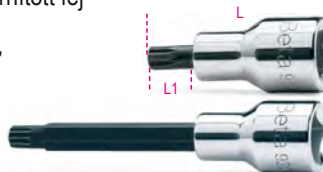

DIN 2324

Ø mm	L mm	L1 mm	Ft	1	009200559
M4	22,5	58	20	4.690	3 009200559
M5	22,5	58	20	4.690	3 009200560
M6	22,5	58	20	4.690	3 009200561
M6L	22,5	100	62	5.320	3 009200562
M8	22,5	58	20	4.690	3 009200563
M8L	22,5	100	62	5.320	3 009200564
M9	22,5	58	20	4.690	3 009200582
M9L	22,5	100	62	5.320	3 009200583
M10	22,5	58	20	4.690	3 009200565
M10L	22,5	100	62	5.320	3 009200566
M12	22,5	58	20	4.720	3 009200568
M12L	22,5	100	62	5.350	3 009200569
M14	23,0	58	20	4.720	3 009200571
M14L	23,0	100	62	5.350	3 009200572
M16	23,0	58	20	6.020	3 009200573
M18	23,0	58	20	6.010	3 009200574

12"



920XZN/SB7
M4-M5-M6-M8
M10-M12-M14
Ft 37.150 1 009200579

12"



920XZN/SB12
M5-M6-M8-M10-M12
M14-M16-M6L-M8L
M10L-M12L-M14L
Ft 67.450 1 009200577

12"



920XZN-L/S5
M6L-M8L-M10L
M12L-M14L
Ft 26.650 1 009200578

920ES

1/2"-os speciális imbusz-dugókulcs, krómozott, fekete hegy

12"



UNI 9326

Ø mm	L mm	L1 mm	Ft	1	009200587
7	(6R)	58	20	6.460	5 009200587
7XL	(6R)	240	202	9.270	1 009200607
9	(8R)	58	20	6.460	5 009200589
9XL	(8R)	240	202	9.270	1 009200609
10	(8S)	58	20	6.460	5 009200590
10XL	(8S)	240	202	9.270	1 009200610
11	(10R)	58	20	6.460	5 009200591
11XL	(10R)	240	202	9.270	1 009200611
12L	(10S)	100	62	7.200	3 009200592
12XL	(10S)	240	202	10.200	1 009200612
14L	(12S)	100	62	7.200	3 009200594
14XL	(12S)	240	202	10.200	1 009200614
16L	(14R)	100	62	7.200	3 009200596
16XL	(14R)	240	202	10.200	1 009200616

12"



920ES/SB7
7-9-10-11-12L-14L-16L
Ft 51.700 1 009200598

12"



920ES-XL/SB7
7XL-9XL-10XL-11XL
12XL-14XL-16XL
Ft 71.950 1 009200618

PM 1/2-Q5

12"



PM 1/2-Q5
Ft 72.519

920/15

Szűkítő közbetét 1/2" és 3/8"

12"



UNI/ISO 3316 DIN 3123

L mm	□	■	Ø mm	Ft	🔧	📄
42	1/2	3/8	22,0	4.200	5	009200810



Ügyeljünk a forgató nyomatékra, fokozatosan növeljük, hogy a törést, illetve az esetleges sérülést elkerüljük.

920/16

Bővítő közbetét 1/2" és 3/4"

12"



UNI/ISO 3316 DIN 3123

L mm	□	■	Ø mm	Ft	🔧	📄
46	1/2	3/4	26	5.330	5	009200814

920/20÷920/23

1/2"-os toldó

12"



UNI/ISO 3316 DIN 3123

	L mm	Ø mm	Ft	🔧	📄
920/20	75	22	5.100	5	009200818
920/21	125	22	6.260	5	009200822
920/22	255	22	7.000	5	009200826
920/23	375	22	9.420	2	009200827

920AN

1/2"-os gömbvégű toldó

12"

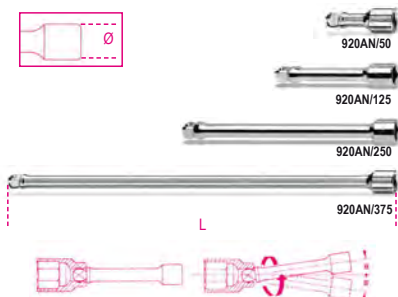

	L mm	Ø mm	Ft	🔧	📄
920AN/50	50	22	5.300	5	009200833
920AN/125	125	22	7.490	5	009200834
920AN/250	250	22	10.600	3	009200835
920AN/375	375	22	14.250	3	009200836

920/25

1/2"-os csukló

12"



UNI/ISO 3316 DIN 3123

L mm	Ø mm	Ft	🔧	📄
75	27	9.970	5	009200830

920/35A

1/2"-os csuklós hajtósár

12"



UNI/ISO 3315 DIN 3122

L mm	L1 mm	Ft	🔧	📄
285	160	19.550	3	009200846

920M/35

1/2"-os csuklós fémhajtósár

12"



UNI/ISO 3315 DIN 3122

L mm	Ft	🔧	📄
380	28.500	2	009200845

920M/35L

1/2"-os csuklós fém hajtósár, hosszított kivitel

12"



L mm

L mm	Ft	🔧	📄
600	43.100	1	009200843



Ügyeljünk a forgató nyomatékra, fokozatosan növeljük, hogy a törést, illetve az esetleges sérülést elkerüljük.

920/36A

1/2"-os csuklós hajtósár, krómzott

12"



UNI/ISO 3315 DIN 3122

L mm	L1 mm	Ft	🔧	📄
408	283	22.100	2	009200847

920/38

1/2" csuklós kihúzható külső négyszögű hajtósár markolattal

12"



L mm	L max mm	Ft	🔧	📄
262	402	33.100	1	009200839

920/40

1/2"-os csuklós T-hajtósár, krómzott

12"



L mm	L1 mm	Ft	🔧	📄
490	230	22.500	2	009200850

920/42

1/2"-os csúszkás T-hajtósár

12"

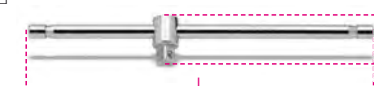

UNI/ISO 3315 DIN 3122

L mm	A mm	Ft	🔧	📄
305	42	7.070	5	009200854

920/44

1/2"-os hajlított hajtósár, krómzott

12"



UNI/ISO 3315 DIN 3122

L mm	L1 mm	Ft	🔧	📄
230	60	10.000	3	009200858

920/46

1/2"-os forgattyús hajtósár, krómzott

12"



UNI/ISO 3315 DIN 3122

L mm	L1 mm	A mm	Ft	🔧	📄
385	110	160	12.700	1	009200862

920/50

1/2"-os átnyomós irányváltós racsn



UNI/ISO 3315 DIN 3122

L	Ø	A	Ft	3	009200871
mm	mm	mm			
275	40	42	22.200		

920/50F

1/2"-os belső négyszögű racsn
krómozott



UNI/ISO 3315 DIN 3122

L	Ø	A	Ft	2	009200889
mm	mm	mm			
275	40	27	20.200		

920/55

1/2"-os irányváltós racsn,
72 fogú, krómozott



UNI/ISO 3315 DIN 3122

L	Ø	A	Ft	3	009200882
mm	mm	mm			
275	40	43	23.700		

920/55Q

1/2"-os irányváltós racsn,
48 fogú, krómozott



UNI/ISO 3315 DIN 3122

L	Ø	A	Ft	3	009200885
mm	mm	mm			
275	40	43	23.700		

920/55X

1/2"-os irányváltós racsn,
72 fogú, krómozott



UNI/ISO 3315 DIN 3122

L	Ø	A	Ft	3	009200895
mm	mm	mm			
200	30	33	20.350		

920/55LC

1/2"-os irányváltós racsn
"záró rendszerrel", 72 fogú,
krómozott



UNI/ISO 3315 DIN 3122

L	Ø	A	Ft	2	009200896
mm	mm	mm			
275	40	43	27.250		

920M/55

1/2"-os irányváltós fémracsn



L	Ø	A	Ft	1	009200893
mm	mm	mm			
253	38	35	30.750		

920/56A

1/2"-os csuklós irányváltós racsn,
72 fogú, krómozott



L	Ø	A	Ft	1	009200911
mm	mm	mm			
315	40	43	38.400		

920M/56

1/2"-os irányváltós csuklós
fémracsn



L	Ø	A	Ft	2	009200894
mm	mm	mm			
330	38	35,7	40.850		

920/58

Írányváltós racsn
1/2",
52-fogú

- Hajtózár
- Nyitó és rögzítő gomb
- Irányváltás a fejen lévő műanyag gyűrű jobbra és balra forgatásával
- Bimateriál-nyél



L	Ø	A	Ft	1	009200926
mm	mm	mm			
281	42,5	45	35.550		

Nyomatékkulcs csatlakozási méretei,
lásd a táblázatot a 929/C8 cikkszám alatt!



920.../C11

11 dugókulcs és 2 tartozék fémdobozban

12"



920A/C11 Ft 64.450 1 009200921

	920A	10 - 12 - 13 - 14 - 15 - 16 17 - 18 - 19 - 21 - 22 mm
	920/22	255 mm
	920/50	
420x185x60 mm - 2,5 kg		

920B/C11 Ft 64.450 1 009200922

	920B	10 - 12 - 13 - 14 - 15 - 16 17 - 18 - 19 - 21 - 22 mm
	920/22	255 mm
	920/50	
420x185x60 mm - 2,5 kg		

920.../C12...

12 dugókulcs és 5 tartozék fémdobozban

12"



920A/C12X Ft 97.100 1 009200933

	920A	10 - 11 - 12 - 13 - 14 - 17 - 19 22 - 24 - 27 - 30 - 32 mm
	920/21	125 mm
	920/22	255 mm
	920/25	
	920/42	
	920/55	
420x185x60 mm - 4,2 kg		

9899 920C12 Ft 5.590 1 098990116
Hőformált tálca, üres

920A/C12 Ft 95.600 1 009200931

	920A	10 - 11 - 12 - 13 - 14 - 17 - 19 22 - 24 - 27 - 30 - 32 mm
	920/21	125 mm
	920/22	255 mm
	920/25	
	920/42	
	920/50	
420x185x60 mm - 4,2 kg		

9899 920C12 Ft 5.590 1 098990116
Hőformált tálca, üres

920B/C12X Ft 97.100 1 009200934

	920B	10 - 11 - 12 - 13 - 14 - 17 - 19 22 - 24 - 27 - 30 - 32 mm
	920/21	125 mm
	920/22	255 mm
	920/25	
	920/42	
	920/55	
420x185x60 mm - 4,0 kg		

9899 920C12 Ft 5.590 1 098990116
Hőformált tálca, üres

920B/C12 Ft 95.600 1 009200932

	920B	10 - 11 - 12 - 13 - 14 - 17 - 19 22 - 24 - 27 - 30 - 32 mm
	920/21	125 mm
	920/22	255 mm
	920/25	
	920/42	
	920/50	
420x185x60 mm - 4,0 kg		

9899 920C12 Ft 5.590 1 098990116
Hőformált tálca, üres

920MC/C14

14 színezett hatszögű dugókulcs és 5 tartozék

12"



920MC/C14 Ft 104.100 1 009202964

	920MC	8 - 10 - 11 - 12 - 13 - 14 - 15 - 16 - 17 - 18 - 19 - 21 - 22 - 24 mm
	920/21	125 mm
	920/22	255 mm
	920/25	
	920/42	
	920/55	
420x185x60 mm - 4,2 kg		

920.../C20...

20 dugókulcs és 5 tartozék fémdobozban

12"



920A/C20X Ft 114.500 1 009200950

	920A	10 - 11 - 12 - 13 - 14 - 15 - 16 17 - 18 - 19 - 20 - 21 - 22 - 23 24 - 26 - 27 - 28 - 30 - 32 mm
	920/21	125 mm
	920/22	255 mm
	920/25	
	920/42	
	920/55	
420x185x60 mm - 5,1 kg		

9899 920C20 Ft 5.590 1 098990121
Hőformált tálca, üres

920A/C20 Ft 113.000 1 009200948

	920A	10 - 11 - 12 - 13 - 14 - 15 - 16 17 - 18 - 19 - 20 - 21 - 22 - 23 24 - 26 - 27 - 28 - 30 - 32 mm
	920/21	125 mm
	920/22	255 mm
	920/25	
	920/42	
	920/50	
420x185x60 mm - 5,1 kg		

9899 920C20 Ft 5.590 1 098990121
Hőformált tálca, üres

920A/C20Q Ft 114.500 1 009200955

	920A	10 - 11 - 12 - 13 - 14 - 15 - 16 17 - 18 - 19 - 20 - 21 - 22 - 23 24 - 26 - 27 - 28 - 30 - 32 mm
	920/21	125 mm
	920/22	255 mm
	920/25	
	920/42	
	920/55Q	
420x185x60 mm - 5,1 kg		

9899 920C20 Ft 5.590 1 098990121
Hőformált tálca, üres

920B/C20 Ft 113.000 1 009200949

	920B	10 - 11 - 12 - 13 - 14 - 15 - 16 17 - 18 - 19 - 20 - 21 - 22 - 23 24 - 26 - 27 - 28 - 30 - 32 mm
	920/21	125 mm
	920/22	255 mm
	920/25	
	920/42	
	920/50	
420x185x60 mm - 5,0 kg		

9899 920C20 Ft 5.590 1 098990121
Hőformált tálca, üres



920B/C20X	Ft	1	009200951
920B	114.500		
920/21			
920/22			
920/25			
920/42			
920/55			
420x185x60 mm - 5,0 kg			

9899 920C20	Ft	1	098990121
Hőfórmált tálcá, üres	5.590		

920.../C21...

21 dugókulcs és 5 tartozék fémdobozban

12"



920A/C21	Ft	1	009200952
920A	131.200		
920/21			
920/22			
920/25			
920/42			
920/46			
920/50			
420x280x60 mm - 6,5 kg			

920A/C21X	Ft	1	009200983
920A	132.700		
920/21			
920/22			
920/25			
920/42			
920/46			
920/55			
420x280x60 mm - 6,4 kg			

920B/C21	Ft	1	009200953
920B	131.200		
920/21			
920/22			
920/25			
920/42			
920/46			
920/50			
420x280x60 mm - 6,4 kg			

920B/C21X	Ft	1	009200984
920B	132.700		
920/21			
920/22			
920/25			
920/42			
920/46			
920/55			
420x280x60 mm - 6,4 kg			

920B/C30Q

30 dugókulcs és 5 tartozék fémdobozban

12"



920B/C30Q	Ft	1	009200975
920B	172.300		
920BL			
920/21			
920/22			
920/25			
920/42			
920/55Q			
420x280x60 mm - 7,6 kg			



920.../C33

20 dugókulcs, 13 csavarhúzó-dugókulcs és 5 tartozék fémdobozban

12"



920A/C33	Ft	1	009200985
920A	169.300		
920LP			
920PH			
920PE			
920/21			
920/22			
920/25			
920/42			
920/55			
420x280x60 mm - 6,7 kg			

920B/C33	Ft	1	009200986
920B	169.300		
920LP			
920PH			
920PE			
920/21			
920/22			
920/25			
920/42			
920/55			
420x280x60 mm - 6,7 kg			

920A/C17M - 920A/C17MR

17 hatlapú dugókulcs és 5 tartozék fémdobozban

12"



920A/C17M Ft 107.200 1 009200924

920A	10-11-12-13-14-15-16-17-18-19-20-21-22-24-27-30-32 mm
920/21	125 mm
920/22	255 mm
920/25	
920/42	305 mm
920/55	

420x185x60 mm - 5 kg

9899 920C17 Ft 9.820 1 098990137
Puha modul, üres

920A/C17MR Ft 119.100 1 009200937

920/21	125 mm
920/22	255 mm
920/25	
920/42	305 mm
920/58	

420x185x60 mm 5,1 kg

920/C37

37 dugókulcs és 5 tartozék fémdobozban

12"



920/C37 Ft 159.200 1 009200988

920B	10 - 11 - 12 - 13 - 14 - 15 - 16 17 - 18 - 19 - 20 - 21 - 22 - 23 24 - 26 - 27 - 28 - 30 - 32 mm
920AS	3/8 - 7/16 - 1/2 - 9/16 - 19/32 5/8 - 11/16 - 3/4 - 25/32 - 13/16 7/8 - 15/16 - 1 - 1.1/16 - 1.1/8 1.3/16 - 1.1/4
920/21	125 mm
920/22	255 mm
920/25	
920/42	
920/55	

420x280x60 mm - 7,5 kg

920AS/C10

10 tizenkétszögű dugókulcs és 2 tartozék fémdobozban

12"



920AS/C10 Ft 65.650 1 009200919

920AS	3/8 - 7/16 - 1/2 - 9/16 - 5/8 11/16 - 3/4 - 13/16 - 7/8 - 15/16
920/22	255 mm
920/50	

335x145x60 mm - 2,6 kg

920AS/C15

15 tizenkétszögű dugókulcs és 6 tartozék fémdobozban

12"



920AS/C15 Ft 123.500 1 009200947

920AS	3/8 - 7/16 - 1/2 - 9/16 - 5/8 - 11/16 3/4 - 13/16 - 7/8 - 15/16 - 1 1.1/16 - 1.1/8 - 1.3/16 - 1.1/4
920/21	125 mm
920/22	255 mm
920/25	
920/42	
920/46	
920/50	

420x280x60 mm - 5,9 kg

Beta

920AS/C17X

17 dugókulcs és 5 tartozék fémdobozban

12"



920AS/C17X Ft 113.900 1 009200942

920AS	3/8 - 7/16 - 1/2 - 9/16 - 19/32 - 5/8 11/16 - 3/4 - 25/32 - 13/16 - 7/8 15/16 - 1 - 1.1/16 - 1.1/8 - 1.3/16 - 1.1/4
920/21	125 mm
920/22	255 mm
920/25	
920/42	
920/55	

420x185x60 mm - 4,8 kg

920AS/MBM-C21

16 dugókulcs és 5 tartozék, fémdobozban

12"



920AS/MBM-C21 Ft 118.000 1 009200944

920AS	3/8 - 7/16 - 1/2 - 9/16 19/32 - 5/8 - 11/16 - 3/4 25/32 - 13/16 - 7/8 - 15/16 1 - 1.1/16 - 1.3/16 - 1.1/4
920M/55	
920/21	125 mm
920/22	255 mm
920/25	
920/42	

420x185x60 mm - 5,0 kg

Beta

920TX/C17

6 csavarhúzóbetét, 6 dugókulcs Torx®-csavarokhoz és 4 tartozék fémdobozban

12"



920TX/C17 Ft 107.700 1 009200989

	861TX	T8 - T10 - T15 - T20 - T25 - T27
	897	
	920TX	T27 - T30 - T40 - T45 - T50
	920FTX	E10 - E12 - E14 - E16 - E18 - E20
	920/20	75 mm
	920/22	255 mm
	920/55	
420x185x60 mm - 2,9 kg		

920A/C17HR

17 hatlapfejű dugókulcs és 5 tartozék kemény hőformázott tálcában, lemezdobozban

• forgó markolatos racsni

12"



920A/C17HR Ft 119.100 1 009200939

	920A	10-11-12-13-14-15-16-17-18-19-20-21-22-24-27-30-32 mm
	920/21	125 mm
	920/22	255 mm
	920/25	
	920/42	
	920/58	
420x185x60 mm - 5,1 kg		

920U/C17M

12 multifunkciós dugókulcs és 5 tartozék, puha habszivacs tálcában

12"



920U/C17M Ft 110.500 1 009201797

	920U	○ 10-11-12-13-14-15-16-17-18-19-20-21-22-24-27-30-32 mm * 3/8-7/16-15/32-1/2-9/16-19/32-5/8-3/4-25/32-7/8-15/16-1.1/16-1.1/8-1.1/4 ○ M12-M14-M16-M18 ○ E12-E14-E16-E18-E20-E22-E24
	920/21	125 mm
	920/22	255 mm
	920/25	
	920/42	305 mm
	920/55	275 mm
420x185x60 mm - 5 kg		

9899 920C17 Ft 9.820 1 098990137
Puha modul, üres

928A

Hatlapú dugókulcs

3/4"



UNI/ISO 2725
DIN 3124

mm	Ø	L	Ø1	Ft	U	PC
19	29,2	50	34	4.420	5	009280019
21	30,0	51	34	4.430	5	009280021
22	31,3	53	34	4.380	5	009280022
23	33,3	53	34	4.380	5	009280023
24	34,5	53	34	4.440	5	009280024
26	36,8	55	35	4.860	5	009280026
27	38,0	56	35	4.860	5	009280027
28	39,0	57	35	5.050	3	009280028
29	40,2	58	35	5.050	3	009280029
30	41,5	58	37	5.100	3	009280030
32	44,3	60	37	5.510	3	009280032
33	45,8	60	37	5.840	3	009280033
34	46,8	60	37	5.890	3	009280034
35	48,1	62	38	6.060	3	009280035
36	49,5	64	38	6.060	3	009280036
38	52,0	68	40	6.670	3	009280038
41	56,0	71	40	7.320	3	009280041
46	62,3	75	43	9.060	3	009280046
50	67,4	80	43	11.100	3	009280050
55	73,7	84	48	13.850	1	009280055
60	80,0	87	48	15.700	1	009280060

928B

Tizenkétszögű dugókulcs

3/4"



UNI/ISO 2725
DIN 3124

mm	Ø	L	Ø1	Ft	U	PC
19	29,2	50	34	4.420	5	009280119
21	30,0	51	34	4.430	5	009280121
22	31,3	53	34	4.380	5	009280122
23	33,3	53	34	4.380	5	009280123
24	34,5	53	34	4.440	5	009280124
26	36,8	55	35	4.860	5	009280126
27	38,0	56	35	4.860	5	009280127
28	39,0	57	35	5.050	3	009280128
29	40,2	58	35	5.050	3	009280129
30	41,5	58	37	5.100	3	009280130
32	44,3	60	37	5.510	3	009280132
33	45,8	60	37	5.840	3	009280133
34	46,8	60	37	5.890	3	009280134
35	48,1	62	38	6.060	3	009280135
36	49,5	64	38	6.060	3	009280136
38	52,0	68	40	6.670	3	009280138
41	56,0	71	40	7.320	3	009280141
46	62,3	75	43	9.060	3	009280146
50	67,4	80	43	11.100	3	009280150
55	73,7	84	48	13.850	1	009280155
60	80,0	87	48	15.700	1	009280160

928AS

Hatlapú dugókulcs

3/4"



"	Ø	L	Ø1	Ft	U	PC
7/8	32,0	53	34	4.860	1	009280202
15/16	34,5	53	34	4.860	1	009280203
1	36,2	55	35	5.130	1	009280204
1.1/16	38,0	56	35	5.130	1	009280205
1.1/8	40,2	58	35	5.290	1	009280206
1.1/4	44,2	60	37	5.800	1	009280208
1.5/16	45,8	60	37	6.220	1	009280209
1.3/8	48,1	62	38	6.540	1	009280210
1.7/16	49,5	64	38	6.860	1	009280211
1.1/2	52,0	68	40	7.330	1	009280212
1.5/8	56,0	71	40	7.960	1	009280214
1.11/16	58,8	74	40	9.230	1	009280215
1.13/16	62,3	75	43	10.450	1	009280217
1.7/8	65,0	78	43	11.200	1	009280218
2	68,3	80	43	12.850	1	009280219
2.1/16	71,5	83	48	14.850	1	009280220

928ME

Imbusz-dugókulcs, krómozott

3/4"

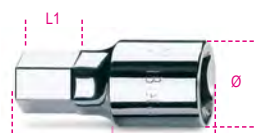

mm	Ø	L	L1	Ft	U	PC
14	35	75	15,5	9.890	2	009280514
17	35	75	15,5	9.890	2	009280517
19	35	75	15,5	9.890	2	009280519
22	35	75	22,5	9.900	2	009280522

928/15

Szűkítő közbetét 3/4"- 1/2",
krómozott



UNI/ISO 3316
DIN 3123

L mm	Ø mm	□	■	Ft	🔧	📄
51,5	34	3/4	1/2	7.350	5	009280801

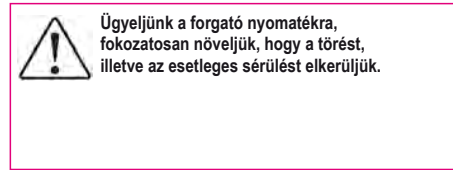

928/16

Bővítő közbetét 3/4"-1",
krómozott



UNI/ISO 3316
DIN 3123

L mm	Ø mm	□	■	Ft	🔧	📄
65	34	3/4	1"	9.030	5	009280807

928/20 - 928/21 - 928/22

3/4"-os toldó



UNI/ISO 3316
DIN 3123

	L mm	Ø mm	Ft	🔧	📄
928/20	100	34	9.010	3	009280810
928/21	200	34	12.050	3	009280815
928/22	380	34	18.150	3	009280825

928/25

Csukló 3/4"



UNI/ISO 3316 DIN 3123

L mm	Ø mm	Ft	🔧	📄
108	40	30.900	1	009280830

928/36A

3/4"-os csuklós hajtószár, krómozott



DIN 3122 - UNI ISO 3315

L mm	Ft	🔧	📄
545	37.050	1	009280844

928/42

3/4"-os csúszkás T-hajtószár,
krómozott

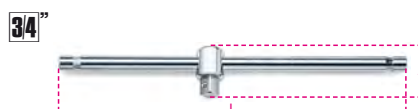

UNI/ISO 3315 DIN 3122

L mm	A mm	Ft	🔧	📄
450	62,5	19.750	3	009280850

928/55

3/4"-os irányváltós racsní,
72 fogú, krómozott



DIN 3122 - UNI ISO 3315

L mm	Ø mm	A mm	Ft	🔧	📄
510	58	59	61.700	2	009280862

**Nyomatékkulcs csatlakozási méretei,
lásd a táblázatot a 929/C8 cikkszám alatt!**

928.../C12

12 hatlapú dugókulcs és 5 tartozék,
fémdobozban



928A/C12	Ft	🔧	📄
	270.200	1	009280955

Ø	928A	22 - 24 - 27 - 30 - 32 - 34 - 36
36	928/21	200 mm
41	928/22	380 mm
46	928/25	
50	928/42	
55	928/55	

530x220x80 mm - 13,5 kg

928B/C12	Ft	🔧	📄
	270.200	1	009280957

Ø	928B	22 - 24 - 27 - 30 - 32 - 34 - 36
36	928/21	200 mm
41	928/22	380 mm
46	928/25	
50	928/42	
55	928/55	

530x220x80 mm - 13,5 kg

928AS/C12

12 hatlapú dugókulcs és 5 tartozék,
fémdobozban



928AS/C12	Ft	🔧	📄
	278.100	1	009280968

Ø	928AS	7/8-15/16-1.1/16-1.1/8-1.1/4
1.5/16-1.7/16-1.1/2-1.11/16	928/21	200 mm
1.13/16-1.7/8-2.1/16	928/22	380 mm
	928/25	
	928/42	
	928/55	

530x220x80 mm - 13,5 kg

929

Hatlapú dugókulcs



UNI/ISO 2725 DIN 3124

Ø	L	Ø1	Ft	🔧	📄
36	51	65	8.980	1	009290036
41	57	70	9.290	1	009290041
46	65	75	10.100	1	009290046
50	70	80	12.050	1	009290050
55	76	85	14.250	1	009290055
60	82	90	16.800	1	009290060
65	88	95	19.950	1	009290065
70	92	100	23.750	1	009290070
75	99	110	25.950	1	009290075
80	106	120	28.950	1	009290080

929/15

Szűkítő közbetét, 1"-3/4",
krómozott

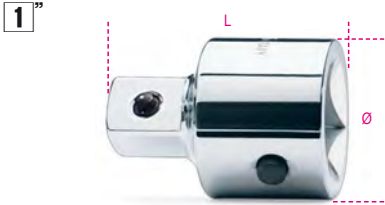

UNI/ISO 3316 DIN 3123

L mm	Ø mm	□	■	Ft	📦	📄
65	47	1"	3/4	15.800	2	009290801



Ügyeljünk a forgató nyomatékra,
fokozatosan növeljük, hogy a törést,
illetve az esetleges sérülést elkerüljük.

929/21 - 929/22

1"-os toldó



UNI/ISO 3316 DIN 3123

	L mm	Ø mm	Ft	📦	📄
929/21	200	47	20.400	1	009290815
929/22	400	47	29.800	1	009290825

929/42

1"-os csúszkás T-hajtósár,
krómozott



UNI/ISO 3315 DIN 3122

L mm	Ft	📦	📄
535	38.900	1	009290850

929/55

1"-os irányváltós racsní,
72 fogú, krómozott



UNI/ISO 3315 DIN 3122

L mm	Ø mm	A mm	Ft	📦	📄
770	62	63	80.950	1	009290860

929/55PR

Toldó a 929/55 racsníhoz



L mm	Ø mm	Ø1 mm	Ft	📦	📄
540	32	26	25.800	1	009290868

929/C8

8 dugókulcs és 5 tartozék,
fémdobozban



929/C8	Ft	📦	📄
	398.100	1	009290925

○ 929	46 - 50 - 55 - 60 - 65 70 - 75 - 80 mm
□ 929/15	□ 1" - ■ 3/4
□ 929/21	200 mm
□ 929/22	400 mm
□ 929/42	
⊗ 929/55	

📦 560x290x120 mm - 📦 29 kg

9899 CV/A

táska, üres



9899 CV/A	Ft	📦	📄
	12.500	1	098990001

583/C31-671B/C5-671B/C10-720ME/C8-860/C38P
861/C61P-900/C11-900AS/C10-/MB-C17-900/C24
900/C13-8-900/C13-5-900MB/C19-900MB/C28
900/C11HR-900AS/C10-/MB-C17-900AS/C17
MBM-900/C11Z-900MC/C24-900MC/C32-910.../C10
971/C8-920TX/C-920PE/C-920FTX/C-910.../C10

📦 270x120x45 mm

9899 CV/B

táska, üres



9899 CV/B	Ft	📦	📄
	14.400	1	098990002

352C/U-720MC/C13-727/C16-867/C20
900/C12MR-900/C12MZ-900U/C12M-910AS/C13...
910AS/MBM-C18-910A/C16...-910B/C16...
910A/C16HR-910A/C16...-910B/C16...-920AS/C10
920.../C11-1433/C11-1494/C14A-1529-1545/C5M

📦 335x145x60 mm

9899 CV/C

táska, üres



9899 CV/C	Ft	📦	📄
	18.250	1	098990003

920A/C17HR-920A/C17MR-920.../C12...
920A/C17M-910.../C29-902A/C22-867/C38
720/C24-450/C15-353N/C6-960KPC-920MC/C14
920U/C17M-920TX/C17-920...-920AS/MBM
C21-920AS/C17X-1547/C6-1495/C6-1489/C14
1461/C11A-1608/C9-1606A/C9-1602/C9

📦 420x185x60 mm

900/R55



900/R55	Ft	📦	📄
	13.500	1	009000871

666N/2-900/55-666/2

900/R55-Z



900/R55-Z	Ft	📦	📄
	13.500	1	009000872

900M/R55



900M/R55	Ft	📦	📄
	6.900	1	009000888

900M/55

910/R55



38"
72

Ft 13.250 1 009100879

910/R55
 599DGT/6-606/6-606/10-612
 665/6-665/10-665LB/6-665LB/10
 666N/5-666N/10-666N LBF.IN/5-
 666N LBF.IN/10
 666/6-666/10-668RGC/6-
 668RGC/10-910/55
 666/5-666HS/5-666HS/10-666 LBF.FT/2
 666 LBF.FT/5-666 LBF.FT/10

910M/R55



38"
48

Ft 7.230 1 009100888

910M/R55
 910M/55-910M/56

910/R55Q



38"
48

Ft 13.250 1 009100877

910/R55Q
 910/55Q

910/R55X



38"
48

Ft 13.250 1 009100897

910/R55X
 666N/2X-666/2X-666 LBF.FT/2X

920/R50



12"
72

Ft 12.900 1 009200866

920/R50
 614/50-667/20-667/30
 667N/20-667N/30-920/50

920/R55



12"
72

Ft 15.900 1 009200879

920/R55
 606/20-606/30-666/20-666/30-920/55
 920/56A- 599DGT/20-599DGT/30
 599DGT-AN/20-665/20-665/30-665LB/20
 665LB/30-666N/20-666N/30
 666N LBF.IN/20-666N LBF.IN/30-668RGC/20
 666 LBF.FT/20-666 LBF.FT/30

920M/R55



12"
72

Ft 8.000 1 009200888

920M/R55
 920M/55-920M/56

920/R55Q



12"
48

Ft 15.900 1 009200877

920/R55Q
 920/55Q

920/R55X



12"
72

Ft 13.150 1 009200878

920/R55X
 606/10X-612X
 666/10X-920/55X-599DGT/10X-599DGT-
 AN/10
 665/10X-665LB/10X-666N10X-
 666N LBF.IN/10X
 668RGC/10X-666 LBF.FT/10X
 666HS/20LC-666HS/30LC

920/R55LC



12"
72

Ft 16.900 1 009200887

920/R55LC
 920/55LC "Locking System"

928/R55



34"
72

Ft 25.800 1 009280859

928/R55
 928/55

928/R55X



34"
72

Ft 15.950 1 009280858

928/R55X
 614X

929/R55



1"
72

Ft 29.850 1 009290859

929/R55
 929/55

930

Erősített tizenkétszögű csőkulcs, krómzott



UNI 6745

Ø mm	L mm	Ø mm	Ø1 mm	Ft	1	009300006
6x7	100	9,5	11,0	5.260	3	009300006
8x9	108	12,5	14,0	6.590	3	009300010
10x11	116	15,0	16,5	6.800	3	009300014
12x13	124	17,5	19,0	8.160	3	009300018
14x15	132	20,0	21,5	8.960	3	009300023
16x17	140	23,0	24,0	10.350	3	009300027
18x19	148	25,0	26,5	11.250	3	009300032
20x22	156	28,0	30,0	12.700	2	009300036
21x23	163	29,0	31,5	13.850	2	009300040
24x26	173	33,0	35,5	17.150	2	009300044
25x28	182	34,5	38,0	18.500	2	009300048
27x29	191	37,0	39,5	21.950	2	009300052
30x32	200	40,5	43,0	25.700	2	009300056



Ft 75.150 1 009300081

930/S8
 6x7-8x9-10x11
 12x13-14x15-16x17
 18x19-20x22 mm
940/1 - /2
930/S13
 6x7-8x9-10x11-12x13
 14x15-16x17-18x19
 20x22-21x23-24x26
 25x28-27x29-30x32 mm
940/1 - /2 - /3



Ft 194.700 1 009300098

930/C13
 6x7-8x9-10x11-12x13
 14x15-16x17-18x19
 20x22-21x23-24x26
 25x28-27x29-30x32 mm
940/1 - /2 - /3

932

Tizenkétszögű pipakulcs, fényes krómozott

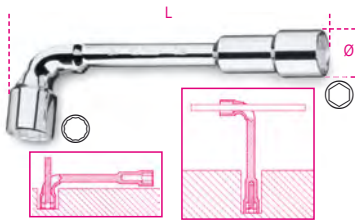

NF E 74.303

Ø mm	Ø mm	L mm	Ft	🔧	📄
6x6	11,5	110	5.940	5	009320006
7x7	12,5	116	6.060	5	009320007
8x8	13,0	120	6.310	5	009320008
9x9	14,0	125	6.440	5	009320009
10x10	16,5	133	6.720	5	009320010
11x11	17,5	143	7.330	5	009320011
12x12	19,0	148	7.800	5	009320012
13x13	19,5	154	8.320	5	009320013
14x14	21,5	167	8.530	5	009320014
15x15	22,5	182	9.050	5	009320015
16x16	24,5	193	9.460	5	009320016
17x17	26,0	198	9.500	5	009320017
18x18	26,5	215	10.400	5	009320018
19x19	29,0	220	11.250	5	009320019
20x20	30,5	222	12.150	3	009320020
21x21	30,5	236	14.050	3	009320021
22x22	32,5	250	15.200	2	009320022
23x23	33,5	256	16.850	2	009320023
24x24	35,0	272	17.950	2	009320024
25x25	36,5	282	18.850	2	009320025
26x26	37,5	296	21.700	2	009320026
27x27	39,0	296	22.400	2	009320027
28x28	39,0	314	24.900	2	009320028
30x30	42,5	348	29.700	2	009320030
32x32	45,5	364	33.650	2	009320032



	Ft	🔧	📄
932/S11 6-7-8-10-11-12 13-14-17-19-22 mm	92.950	1	009320080
932/S17 6-7-8-9-10-11-12 13-14-15-16-17 18-19-20-21-22 mm	154.500	1	009320081
932/S25 6-7-8-9-10-11-12-13 14-15-16-17-18-19 20-21-22-23-24-25 26-27-28-30-32 mm	340.500	1	009320082

933

Hatlapú pipakulcs fényes, krómozott

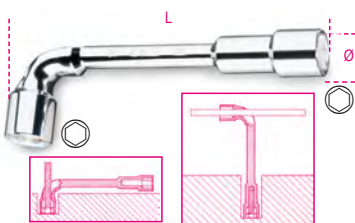

NF E 74.303

Ø mm	Ø mm	L mm	Ft	🔧	📄
6x6	11,5	110	5.940	5	009330006
7x7	12,5	116	6.060	5	009330007
8x8	13,0	120	6.310	5	009330008

Ø mm	Ø mm	L mm	Ft	🔧	📄
9x9	14,0	125	6.440	5	009330009
10x10	16,5	133	6.720	5	009330010
11x11	17,5	143	7.330	5	009330011
12x12	19,0	148	7.800	5	009330012
13x13	19,5	154	8.320	5	009330013
14x14	21,5	167	8.530	5	009330014
15x15	22,5	182	9.050	5	009330015
16x16	24,5	193	9.460	5	009330016
17x17	26,0	198	9.500	5	009330017
18x18	26,5	215	10.400	5	009330018
19x19	29,0	220	11.250	5	009330019
20x20	30,5	222	12.150	3	009330020
21x21	30,5	236	14.050	3	009330021
22x22	32,5	250	15.200	2	009330022
23x23	33,5	256	16.850	2	009330023
24x24	35,0	272	17.950	2	009330024
25x25	36,5	282	18.850	2	009330025
26x26	37,5	296	21.700	2	009330026
27x27	39,0	296	22.400	2	009330027
28x28	39,0	314	24.900	2	009330028
30x30	42,5	348	29.700	2	009330030
32x32	45,5	364	33.650	2	009330032



	Ft	🔧	📄
933/S11 6-7-8-10-11-12 13-14-17-19-22 mm	92.950	1	009330080
933/S17 6-7-8-9-10-11-12 13-14-15-16-17 18-19-20-21-22 mm	154.500	1	009330081
933/S25 6-7-8-9-10-11-12-13 14-15-16-17-18-19 20-21-22-23-24-25 26-27-28-30-32 mm	340.500	1	009330082

935

Könnyített hatlapú csőkulcs, krómozott



UNI 6746 DIN 896

Ø mm	L mm	Ft	🔧	📄
6x7	100	3.060	5	009350105
8x9	110	3.310	5	009350111
10x11	120	3.610	5	009350115
12x13	130	4.120	5	009350117
14x15	140	4.850	5	009350126
16x17	150	5.240	5	009350128
18x19	160	6.260	5	009350131
20x22	170	7.560	3	009350138
21x23	180	8.400	3	009350141
24x26	190	9.610	3	009350144
25x28	200	10.400	2	009350150
27x29	210	12.400	2	009350153
30x32	220	13.350	2	009350156

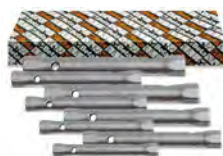

	Ft	🔧	📄
935/S8 6x7-8x9-10x11 12x13-14x15-16x17 18x19-20x22 mm	43.100	1	009350181
940/1 - /2			
935/S13 6x7-8x9-10x11 12x13-14x15-16x17 18x19-20x22-21x23 24x26-25x28-27x29 30x32 mm	102.600	1	009350183
940/1 - /2 - /3			

937

Hatlapú-tizenkétszögű pipakulcs, krómozott

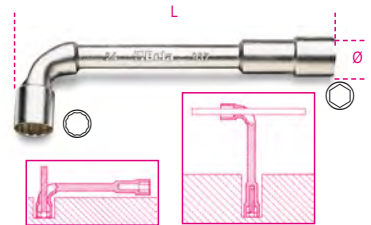

Ø mm	Ø mm	L mm	Ft	🔧	📄
6x6	11,5	110	3.270	5	009370006
7x7	12,5	116	3.400	5	009370007
8x8	13,0	120	3.560	5	009370008
9x9	14,0	125	3.750	5	009370009
10x10	16,5	133	3.940	5	009370010
11x11	17,5	143	4.150	5	009370011
12x12	19,0	148	4.510	5	009370012
13x13	19,5	154	4.690	5	009370013
14x14	21,5	167	5.100	5	009370014
15x15	22,5	182	5.730	5	009370015
16x16	24,5	193	6.210	5	009370016
17x17	26,0	198	6.410	5	009370017
18x18	26,5	215	6.640	5	009370018
19x19	29,0	220	6.870	5	009370019
20x20	30,5	222	7.760	3	009370020
21x21	30,5	236	8.550	3	009370021
22x22	32,5	250	8.980	2	009370022
23x23	33,5	256	9.620	2	009370023
24x24	35,0	272	10.650	2	009370024
25x25	36,5	282	13.300	2	009370025
26x26	37,5	296	13.600	2	009370026
27x27	39,0	296	13.800	2	009370027
28x28	39,0	314	16.550	2	009370028
30x30	42,5	348	17.800	2	009370030
32x32	45,5	364	19.950	2	009370032



	Ft	🔧	📄
937/S11 6-7-8-10-11-12 13-14-17-19-22 mm	54.900	1	009370080
937/S17 6-7-8-9-10-11-12 13-14-15-16-17 18-19-20-21-22 mm	93.500	1	009370081

940

Hajtósár a 930 és 935 típusú csőkulcsokhoz, krómozott



	Ø mm	L mm	Ft	🔧	📄
940/1	6+13	100	2.170	5	009400001
940/2	14+22	170	2.930	5	009400002
940/3	21+32	290	5.320	5	009400003

941

T-szárú dugókulcs, 12 x 6, műanyag markolattal



mm	L mm	L1 mm	A1 mm	Ft	csomagolás	partszám
7x7	200	91	35	10.600	2	009410107
8x8	220	107	50	11.400	2	009410108
9x9	220	109	50	11.700	2	009410109
10x10	236	111	50	11.950	2	009410110
11x11	236	114	50	12.450	2	009410111
12x12	255	122	50	13.550	2	009410112
13x13	255	124	55	13.800	2	009410113



941/S7	Ft	csomagolás	partszám
7-8-9-10-11-12-13 mm	85.450	1	009410170

DUGÓKULCS-CSAVARHÚZÓK MARKOLATTAL

Gyors, ismételt csavarozási műveletekhez alkalmas. A vékonyított hatlapú fej kis helyekhez is hozzáférést biztosít. A belső üreg a kiálló menetes részek esetén is könnyű csavarozást tesz lehetővé.



Ez különösen a 944BX típusú mély, nagy nyomatékú dugókulcs-csavarhúzókra érvényes. A fejen található hármás jelölés megkönnyíti a szükséges méret beazonosítását. A 943FL modell flexibilis éle, melynek acél magját egy köpeny védi, akkor is lehetővé teszi a nyomaték átadását, ha a csavar elmozdult.

942BX

Rövid hatlapú dugókulcs-csavarhúzó



UNI 6750

mm	L mm	L1 mm	A1 mm	Ft	csomagolás	partszám
4	190	70	13,0	5.440	5	009420003
5	190	70	14,0	5.440	5	009420004
5,5	190	70	12,5	6.180	5	009420005
6	190	70	14,5	6.180	5	009420006
7	190	70	15,5	6.440	5	009420007
8	202	70	18,5	6.440	5	009420008
9	202	70	19,5	6.440	5	009420009
10	202	70	20,5	6.890	3	009420010
11	202	70	21,5	6.890	3	009420011
12	202	70	22,5	6.890	3	009420012
13	202	70	23,5	7.670	3	009420013
14	202	70	24,5	7.670	3	009420014



942BX/S12	Ft	csomagolás	partszám
4-5-5,5-6-7-8-9 10-11-12-13-14 mm	78.550	1	009420030

943BX

Hosszú hatlapú dugókulcs-csavarhúzó



ISO 2236 UNI 6750

mm	L mm	L1 mm	A1 mm	Ft	csomagolás	partszám
4	270	150	13,0	6.020	5	009430003
5	270	150	14,0	6.020	5	009430004
5,5	270	150	12,5	6.530	5	009430005
6	270	150	14,5	6.530	5	009430006
7	270	150	15,5	7.010	5	009430007
8	282	150	18,5	7.010	5	009430008
9	282	150	19,5	7.010	5	009430009
10	282	150	20,5	7.500	3	009430010
11	282	150	21,5	7.500	3	009430011
12	282	150	22,5	7.500	3	009430012
13	282	150	23,5	8.020	3	009430013
14	282	150	24,5	8.020	3	009430014



943BX/S12	Ft	csomagolás	partszám
4-5-5,5-6-7-8-9 10-11-12-13-14 mm	84.650	1	009430030



943BX/D6	Ft	csomagolás	partszám
5-6-7-8-10-13 mm	42.100	1	009430026

943FL

Flexibilis dugókulcs-csavarhúzó, krómzott



mm	L mm	L1 mm	Ø mm	Ft	csomagolás	partszám
5	265	150	8	8.410	2	009430304
5,5	265	150	8	8.480	2	009430305
6	265	150	9	8.480	2	009430306
7	265	150	11	8.480	2	009430307
8	265	150	12	8.750	2	009430308
10	290	175	14	9.310	2	009430310



943FL/S6	Ft	csomagolás	partszám
5-5,5-6-7-8-10 mm	51.900	1	009430320

Beta

944BX

Hosszú hatlapú dugókulcs-csavarhúzó



ISO 2236 UNI 6750

mm	L mm	L1 mm	A1 mm	Ft	csomagolás	darab	azonosító
4	245	125	20	6.370	3	009440003	
5	245	125	25	6.370	3	009440004	
5,5	245	125	30	7.790	3	009440005	
6	245	125	35	7.790	3	009440006	
7	245	125	35	7.790	3	009440007	
8	257	125	50	8.300	3	009440008	
9	257	125	50	8.300	3	009440009	
10	257	125	50	8.650	3	009440010	
11	257	125	50	8.650	3	009440011	
12	257	125	50	9.380	3	009440012	
13	257	125	55	9.380	3	009440013	
14	257	125	55	9.380	3	009440014	



mm	L mm	L1 mm	A1 mm	Ft	csomagolás	darab	azonosító
4-5-5,5-6-7-8-9				98.150	1	009440062	



mm	L mm	L1 mm	A1 mm	Ft	csomagolás	darab	azonosító
5-6-7-8-10-13 mm				48.300	1	009440056	

949

T szárú egyszerű kulcs
mély hatlapfejű dugóvéggel



mm	L mm	L1 mm	A1 mm	Ft	csomagolás	darab	azonosító
8	220	160	50	11.050	2	009490008	
10	230	160	50	11.700	2	009490010	
12	240	175	50	12.150	2	009490012	
13	244	175	55	12.700	2	009490013	
14	250	190	55	13.650	2	009490014	
17	264	200	60	15.600	2	009490017	



mm	L mm	L1 mm	A1 mm	Ft	csomagolás	darab	azonosító
8-10-12-13-14-17mm				76.850	1	009490076	

950

T-szárú dugókulcs, krómzott

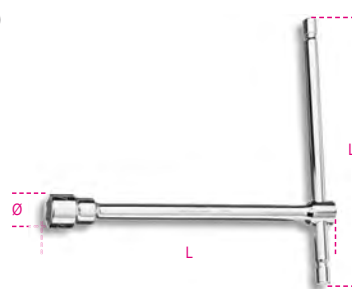

UNI 6742 DIN 3112

mm	L mm	Ø mm	L1 mm	Ft	csomagolás	darab	azonosító
6	210	10,1	145	7.920	3	009500006	
7	212	11,2	145	7.920	3	009500007	
8	220	12,4	160	8.430	3	009500008	
9	223	13,5	160	8.430	3	009500009	
10	230	14,9	160	9.160	3	009500010	
11	233	16,1	160	9.160	3	009500011	
12	240	17,5	175	10.150	3	009500012	
13	244	19,7	175	10.150	3	009500013	
14	250	20,1	190	11.200	3	009500014	
15	254	21,5	190	11.900	3	009500015	
16	260	22,7	200	13.150	3	009500016	
17	264	24,1	200	13.600	3	009500017	
19	274	26,6	230	16.850	3	009500019	
22	290	29,9	290	20.300	2	009500022	
24	300	32,2	320	23.300	2	009500024	
27	315	36,2	370	27.450	2	009500027	



mm	L mm	L1 mm	A1 mm	Ft	csomagolás	darab	azonosító
7-8-10-11-12 13-14-17-19 mm				96.600	1	009500079	
6-7-8-9-10-11-12-13 14-15-16-17-19-22 mm				158.300	1	009500082	



951 -ES TÍPUSÚ T-KULCSOK HATSZÖG ALAKÚ VÉGEKKEL



Amikor ezt a kulcsot még 1980-ban piacra dobták, forradalmnak számított. Nagy ellenállású csavarokkal végzett munkára tervezték, és neve összeforrt a gyors kezeléssel, a pontos illeszkedéssel és a rugalmas használhatósággal.

A hatszög alakú T-szár igény szerint állítható. A hatszög alakú végeket úgy tervezték, hogy a lehető legnagyobb nyomatékot továbbítsák a csavarra. A rúd hossza lehetővé teszi figyelemre méltó nyomaték könnyedén történő átadását a csavarokra.

A gyártás folyamatos fejlesztése többek között homokfúvott felületeket és éles szélű hatszög alakú végeket eredményezett, amelyek bármilyen csavarra pontosabb illeszkedést tesznek lehetővé, még sérült csavarok esetén is. A lézeres jelölés szilárdabb rudat eredményez.

951

T-szárú imbuszkulcs, krómozott

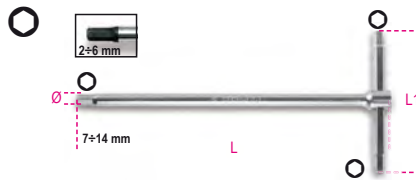

mm	L mm	L1 mm	Ø mm	Ft	csomagolás	alkotórész
2	125	63	4,0	7.210	5	009510521
2,5	150	63	4,0	7.210	5	009510525
3	150	63	4,0	7.210	5	009510530
3,5	175	76	5,5	7.440	5	009510535
4	175	76	5,5	7.440	5	009510540
4,5	195	87	6,5	8.150	5	009510545
5	195	87	6,5	8.150	5	009510550
6	215	99	8,0	9.420	5	009510560
7	230	109	9,0	10.200	5	009510570
8	250	122	10,0	10.200	5	009510580
9	265	132	11,0	12.700	5	009510590
10	280	142	12,0	12.700	5	009510610
12	305	160	15,0	17.300	3	009510620
14	330	178	17,0	21.150	3	009510640

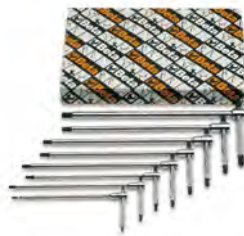

	Ft	csomagolás	alkotórész
951/S6 2,5-3-4-5-6-8 mm	49.650	1	009510687
951/S8 2-2,5-3-3,5-4-4,5-5-6 mm	62.250	1	009510693
951/S14 2-2,5-3-3,5-4-4,5-5-6-7-8-9-10-12-14 mm	146.500	1	009510695



	Ft	csomagolás	alkotórész
951/SP6 3-4-5-6-8-10 mm	61.900	1	009510696
951/SPV	11.450	1	009510697



951AS

T-szárú imbuszkulcs, a végeken hatszögprofil

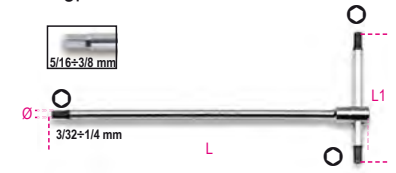

"	L mm	L1 mm	Ø mm	Ft	csomagolás	alkotórész
3/32	125	63	4,0	9.460	2	009510750
7/64	150	63	4,0	9.460	2	009510751
1/8	150	63	4,0	9.460	2	009510752
9/64	175	76	5,5	9.880	2	009510753
5/32	175	76	5,5	9.880	2	009510754
3/16	195	86	6,5	10.800	2	009510755
7/32	215	99	8,0	10.800	2	009510757
1/4	230	109	9,0	12.100	2	009510758
5/16	250	122	10,0	12.600	2	009510759
3/8	280	142	12,0	15.600	2	009510760



	Ft	csomagolás	alkotórész
951AS/S6X 1/8-3/16-7/32-1/4-5/16-3/8	71.350	1	009510771

951TX

T-szárú imbuszkulcs, a végeken négyszögprofil Torx®-csavarhoz



Ø	L mm	L1 mm	Ø mm	Ft	csomagolás	alkotórész
T6	125	63	4	8.740	3	009510806
T7	125	63	4	8.740	3	009510807
T8	125	63	4	8.990	3	009510808
T9	125	63	4	8.990	3	009510809
T10	150	63	4	9.220	3	009510810
T15	150	63	4	9.220	3	009510815
T20	175	76	5	9.780	3	009510820
T25	175	76	5	9.780	3	009510825
T27	195	87	6	10.550	3	009510827
T30	195	87	6	10.550	3	009510830
T40	215	99	7	11.950	3	009510840
T45	230	109	8	12.950	3	009510845
T50	250	122	9	13.800	3	009510850



	Ft	csomagolás	alkotórész
951TX/S6 T8-T10-T15-T20-T25-T30	57.550	1	009510866
951TX/S13 T6-T7-T8-T9-T10-T15-T20-T25-T27-T30-T40-T45-T50	133.300	1	009510863

952 -ES TÍPUSÚ T-KULCSOK CSUKLÓS HATSZÖG ALAKÚ DUGÓKULCSOKKAL

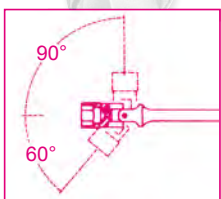

A kulcs sikerének titka a megbízható, pontos illesztés. A csukló sok éves használat alatt is megőrzi működését, nincs szükség beállításra. A dugókulcs forgási szöge: 60°.

Rögzített állásban 90°-ban is használható. Csúszó T-fogantyú, amely a rúd teljes hosszán bárhol megállítható a kívánt helyzetben. A fejen háromszoros méretjelölés található.

952

Csuklós T-kulcs, krómozott

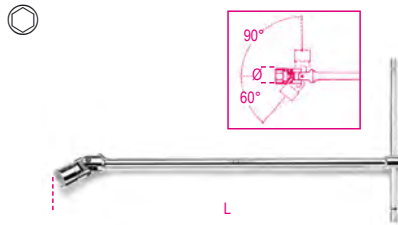

UNI 6743

mm	Ø mm	L mm	Ft	csomagolás	darab
6	9,5	395	11.650	5	009520006
7	10,7	395	11.650	5	009520007
8	12,1	395	11.650	5	009520008
9	13,2	395	11.650	5	009520009
10	14,6	400	12.700	5	009520010
11	15,8	400	12.700	5	009520011
12	17,0	400	12.700	5	009520012
13	18,7	432	13.650	5	009520013
14	19,7	432	13.650	5	009520014
15	20,9	450	16.800	3	009520015
16	22,0	450	16.800	3	009520016
17	23,4	450	16.800	3	009520017
18	24,7	450	16.800	3	009520018
19	26,0	500	20.600	3	009520019
20	27,4	500	20.600	3	009520020
21	28,5	500	20.600	3	009520021
22	29,7	500	20.600	3	009520022
24	32,4	500	20.600	3	009520024



952/S7	Ft	csomagolás	darab
8-10-11-13-14-17-19 mm	101.800	1	009520074
952/S10	142.900	1	009520080
7-8-10-11-12-13-14-15-17-19 mm			
952/S18	282.200	1	009520083
6-7-8-9-10-11-12-13-14-15-16-17-18-19-20-21-22-24 mm			

852



852

78,84



952AS

Csuklós T-kulcs

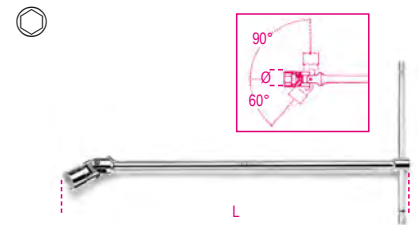

mm	Ø mm	L mm	Ft	csomagolás	darab
1/4	9,5	395	13.000	2	009520256
5/16	12,1	395	13.000	2	009520258
3/8	14,6	400	13.850	2	009520260
7/16	15,8	400	13.850	2	009520261
1/2	18,7	432	15.300	2	009520263
9/16	19,7	432	16.600	2	009520264
5/8	22,0	450	17.700	2	009520266
11/16	23,4	450	17.700	2	009520267
3/4	26,0	500	22.250	2	009520269

952L

Csuklós T-kulcs, hosszított kivétel, krómozott

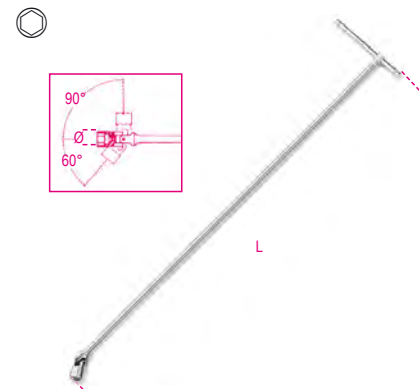

mm	Ø mm	L mm	Ft	csomagolás	darab
10	14,6	930	32.200	1	009520410
12	17,0	1063	32.200	1	009520412
13	18,7	1100	32.200	1	009520413
14	19,7	1100	32.300	1	009520414
15	20,9	1100	35.750	1	009520415
16	22,0	1100	35.750	1	009520416
17	23,4	1100	35.750	1	009520417
18	24,7	1100	35.750	1	009520418
19	26,0	1100	41.650	1	009520419

952FTX

Csuklós Torx® T-kulcs, krómozott

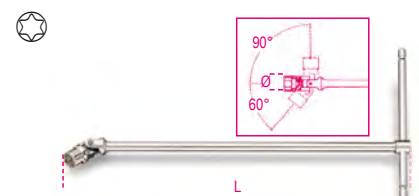

mm	Ø mm	L mm	Ft	csomagolás	darab
E6	8	392	13.900	2	009520106
E7	9	392	13.900	2	009520107
E8	10	395	15.700	2	009520108
E10	13	400	16.150	2	009520110
E12	15	440	19.700	2	009520112
E14	17	490	23.850	2	009520114
E16	19	490	23.850	2	009520116
E18	21	490	23.850	2	009520118
E20	23	490	23.850	2	009520120



952FTX/S9	Ft		
E6-E7-E8-E10-E12	174.800	1	009520141
E14-E16-E18-E20			

953

Csuklós T-szárú imbuszkulcs, krómozott

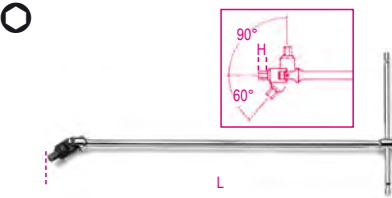

UNI 6754

mm	H mm	L mm	Ft		
3	5	395	12.600	5	009530130
3,5	6	395	12.600	3	009530135
4	6	395	12.600	5	009530140
4,5	7	395	12.600	3	009530145
5	7	395	12.600	5	009530150
6	9	400	13.550	5	009530160
7	10	425	14.900	3	009530170
8	11	425	14.900	5	009530180
10	13	440	17.700	5	009530200



953/S5	Ft		
3-4-5-6-8 mm	66.250	1	009530305
953/S9	Ft		
3-3,5-4-4,5	124.100	1	009530301
5-6-7-8-10 mm			

953TX

Csuklós T-Torx®-imbuszkulcs, krómozott, fekete hegy

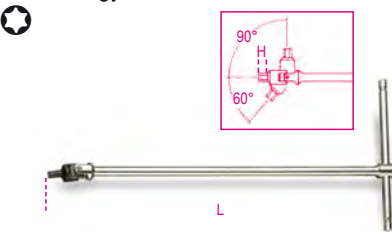

	H mm	L mm	Ft		
T20	11	396	15.600	2	009530020
T25	11	396	15.600	2	009530025
T27	11	396	15.600	2	009530027
T30	13	400	16.850	2	009530030
T40	13	400	16.850	2	009530040
T45	13	426	17.550	2	009530045
T50	14	442	20.600	2	009530050
T55	14	442	20.750	2	009530055



953TX/S8	Ft		
T20-T25-T27-T30	139.400	1	009530060
T40-T45-T50-T55			

JÁRMŰJAVÍTÁS

Járműjavító szerszámainkat, amelyeket a legigényesebb szakemberek használnak, a világ legmagasabb követelményeinek megfelelően fejlesztettük és gyártottuk, és rendszeresen teszteljük a legnagyobb terhelést jelentő üzemi körülmények között.

Több mint 50 éve büszkén dolgozunk együtt a legnagyobbakkal, akik segítenek termékeink folyamatos fejlesztésében és biztosítják a legmagasabb minőségi színvonalnak való megfelelést.

A járműjavító eszközök az alábbi szakaszokban találhatóak:

DIAGNOSZTIKA	1438 - 1499 1758VT - 1760TMC
MOTOR	955 - 989A 1438 - 1499
OLAJ ÉS SZŰRŐK	1438 - 1499 1877 - 1885
ELEKTROMOS RENDSZER	1438 - 1499
GYORSINDÍTÓK	1498BC/12 - 1498/40A
ERŐÁTVITEL	1438 - 1499
FELFÜGGESZTÉS	1549 - 1569CP
FÉKEK	1438 - 1499
KEREKEK	955 - 989A
KAROSSZÉRIA	1302 - 1369 1763 - 1767A
EGYÉB BERENDEZÉSEK	1878 - 3067
EMELÉSTECHNIKA	3029/2T - 3067/70-13T



955

Gyertyakulcs, krómozott, hatlapú

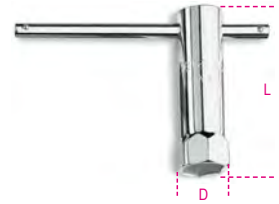

mm -"	D mm	L mm	Ft		
16	21	86	6.320	3	009550016
5/8					
20,8	29	86	6.320	3	009550021
13/16					

956C

1/2"-os gyertya-dugókulcs, krómozott, hatlapú



ISO 11168

mm -"	Ø mm	L mm	Ft		
14	18,8	70	11.750	3	009560008
9/16					
16	21,4	70	11.750	3	009560010
5/8					
17,8	23,6	70	11.750	3	009560011
11/16					
20,8	27,0	70	11.700	3	009560012
13/16					

956E

3/8"-os gyertya-dugókulcs, krómozott, hatlapú



ISO 11168

mm -"	Ø mm	L mm	Ft		
14	18,8	70	13.000	3	009560018
9/16					
16	21,4	70	13.000	3	009560020
5/8					
17,8	23,6	70	12.950	3	009560021
11/16					
20,8	27,0	70	12.950	3	009560022
13/16					

956F

dugókulcs
3/8" négyzetű belső csatlakozóval gyújtógyertyákhoz



mm -"	Ø mm	L mm	Ft		
14	18,8	70	14.250	1	009560114
9/16					
16	20,5	70	17.700	1	009560116
5/8					

Beta

956L

1/2"-os gyertyakulcs, tizenkétszög-profil, hosszított kivitel



mm - "	Ø mm	L mm	Ft	csomagolás	azonosító
14	19,0	250	24.300	2	009560214
9/16					
16	21,0	250	25.200	2	009560216
5/8					
17,8	24,0	250	26.900	2	009560217
11/16					
20,8	27,0	250	27.100	2	009560221
13/16					

957

Rövid csuklós T-gyertyakulcs, krómozott

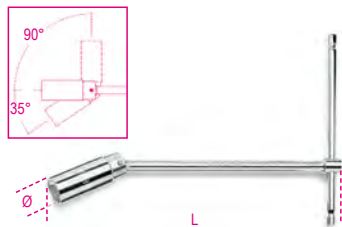

ISO 11168

mm - "	Ø mm	L mm	Ft	csomagolás	azonosító
16	21,4	275	18.300	3	009570000
5/8					
20,8	27,0	275	21.600	3	009570001
13/16					

959

Csuklós T-gyertyakulcs, krómozott

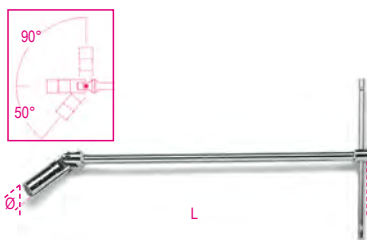

ISO 11168

mm - "	Ø mm	L mm	Ft	csomagolás	azonosító
14	18,8	483	21.450	3	009590009
9/16					
16	21,4	483	23.800	3	009590010
5/8					
20,8	27,0	527	31.100	3	009590011
13/16					

959R

Rugós gumibeté a 956C-956E-957-959-hez

	Ft	csomagolás	azonosító
959R/14 956C/14-956E/14	2.100	3	009590223
959R/16 956C/16-956E/16 957/16-959/16	2.100	3	009590224
959R/17,8 956C/17,8-956E/17,8	2.100	3	009590225
959R/20,8 956C/20,8-956E/20,8 957/20,8-959/20,8-959L	2.100	3	009590226

960

1/2"-os dízel porlasztócsúcs
kiszedő dugókulcs, krómozott,
tizenkétszögű



mm	Ø mm	L mm	Ft	csomagolás	azonosító
27	36,5	77	13.900	2	009600027

960A

1/2"-os nyitott dízel porlasztócsúcs
kiszedő dugókulcs, krómozott,
tizenkétszögű

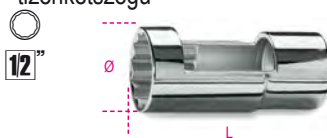

mm	Ø mm	L mm	Ft	csomagolás	azonosító
27	36,5	77	19.950	2	009600017

960BC/C5

5 db dugókulcs
elektromos csatlakozóval szerelt injektorokhoz

készlet tartalma:

- 1 nyitottvégű hatlapú dugókulcs 25 mm
- 1 nyitottvégű hatlapú dugókulcs 27 mm
- 1 nyitottvégű hatlapú dugókulcs 29 mm
- 1 nyitottvégű hatlapú dugókulcs 30 mm
- 1 tizenkétszögű dugókulcs 28 mm



960BC/C5	Ft	csomagolás	azonosító
	57.150	1	009600280

280x160x55 mm - 1,9 kg

960BC

nyitottvégű hatlapú dugókulcs
elektromos csatlakozással rendelkező
befecskendezőkhöz



mm	Ft	csomagolás	azonosító
25	17.050	1	009600285
27	17.050	1	009600287
29	17.050	1	009600289
30	17.050	1	009600290

960BC/P 28

tizenkétszögű dugókulcs
elektromos csatlakozással rendelkező
befecskendezőkhöz



mm	Ft	csomagolás	azonosító
28	17.050	1	009600288

960BT/B

Dugókulcs dízel üzemanyag-befecskendező
fűvóka szereléséhez

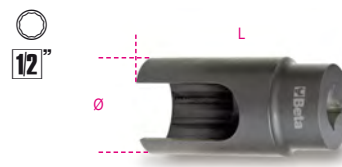

mm	Ø mm	L mm	Ft	csomagolás	azonosító
29	38,5	77	48.300	1	009600128

960ER

csúszókalapácsos szerszám befecskendező alátétek kiszerezéséhez
lépcsős fúrószár

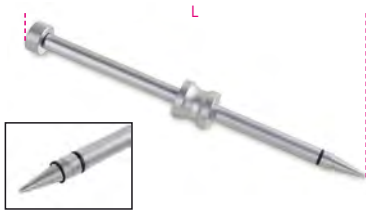

L	Ft		
mm			
350	25.400	1	009600726

960F

Dugókulcs fúvókatartó hornyos anyaghoz



Ø	Ø1	Ø2	Ft		
mm	mm	mm			
28,3	22	32	15.900	1	009600148

960G

Dugókulcs üzemanyag befecskendezőhöz, tizenkétszögű



Ø	Ø1	L	Ft		
mm	mm	mm			
28,5	22	32	16.850	1	009600151

960L

Dugókulcs a befecskendező fúvókatartó hornyos anyaghoz



Ø	Ø1	L	Ft		
mm	mm	mm			
30	22	122	18.350	1	009600153

960M

Dugókulcs a befecskendező fúvókatartó hornyos anyaghoz

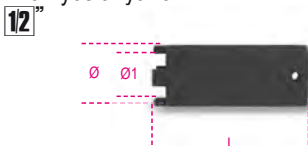

Ø	Ø1	L	Ft		
mm	mm	mm			
28,5	22	72	13.300	1	009600154

960H/C4

Dugókulcskészlet a fúvókatartó hornyos anyaghoz



960H/C4	Ft		
	46.900	1	009600152

960S

1/2"-os nyitott porlasztócsúcshoz kiesző dugókulcs, krómozott, tizenkétszögű

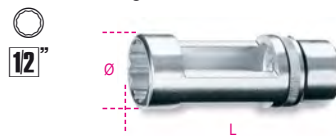

Ø	L	Ft		
mm	mm			
22	30	82	15.250	1

960SL

1/2"-os lambda-szonda dugókulcs, krómozott, nyitott hatlapú fej

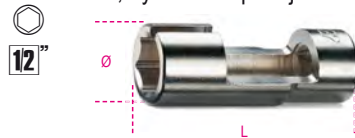

Ø	Ft		
mm			
33	23.950	2	009600085
○ 22xL= 85 mm			
33	27.450	2	009600110
○ 22xL= 110 mm			

960SN

Izzítógyertya kulcs dízel motorokhoz, krómozott



Ø	L	Ft		
mm	mm			
8	12,0	1/4	60	19.700
9	13,3	1/4	60	19.700
10	14,5	3/8	70	23.900
11	15,8	3/8	70	23.900
12	17,0	3/8	70	23.900

960T/C11

dugókulcs készlet érzékelők eltávolításához/beszereléséhez

Készlet tartalma:

- 1 kétoldalas hatlapú dugókulcs, méret: 1" - 11/16" olajnyomás érzékelőkhöz
- 1 nyitottvégű hatlapú dugókulcs, 29 mm, oxigénérzékelőkhöz
- 1 nyitottvégű tizenkétszögű dugókulcs, 27 mm, injektorokhoz
- 1 nyitottvégű hatlapú dugókulcs, 22 mm, vákuumkapcsolókhöz
- 1 nyitottvégű hatlapú dugókulcs, 22 mm, 80 mm hosszú, oxigénérzékelőkhöz
- 1 nyitottvégű hatlapú dugókulcs, 22 mm, 90 mm hosszú, oxigénérzékelőkhöz
- 1 nyitottvégű hatlapú dugókulcs, 22 mm, kompakt, 30 mm hosszú, oxigénérzékelőkhöz
- 1 nyitottvégű hatlapú dugókulcs, 22 mm, kompakt, 50 mm hosszú, oxigénérzékelőkhöz
- 1 nyitottvégű hatlapú és tizenkétszögű dugókulcs, 22 mm, kompakt, 34 mm hosszú, oxigénérzékelőkhöz
- 1 nyitottvégű hatlapú dugókulcs, 22 mm, cső formájú
- 1 menettűró M18x1,5



○ 22 - 29 mm

960T/C11	Ft		
	94.500	1	009600031

≡ 330x270x25 mm

960T/A

nyitottvégű hatlapú dugókulcs, 29 mm oxigénérzékelőkhöz



Ø	L	Ft		
mm	mm			
29	90	11.100	1	009600032

960T/B

nyitottvégű tizenkétszögű dugókulcs, 27 mm injektorokhoz

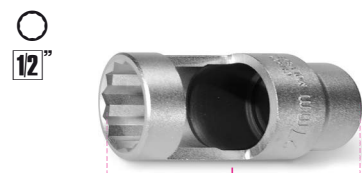

Ø	L	Ft		
mm	mm			
27	85	9.870	1	009600033



960T/C

nyitottvégű hatlapú dugókulcs, 22 mm vákuumkapcsolókhoz

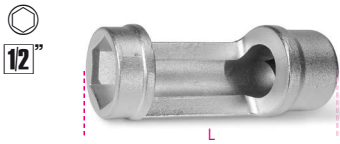

mm	L	Ft	
22	88	8.570	1 009600034

960T/D

nyitottvégű hatlapú dugókulcs, 22 mm, 90 mm hosszú, oxigénérzékelőkhez

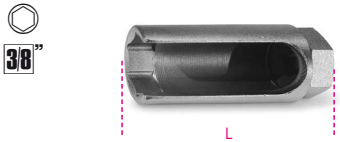

mm	mm	L	Ft	
22	25	90	7.800	1 009600035

960T/E

nyitottvégű hatlapú dugókulcs, 22 mm, 80 mm hosszú, oxigénérzékelőkhez

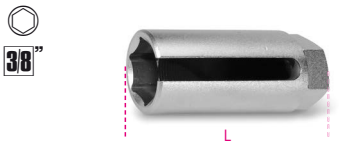

mm	mm	L	Ft	
22	25	80	7.170	1 009600036

960T/F

kétoldalas hatlapú dugókulcs, méret: 1" - 1/16" olajnyomás érzékelőkhez



"	mm	L	Ft	
1 - 1/16	28	74	6.750	1 009600037

960T/G

hatszögű csőkulcs, 22 mm

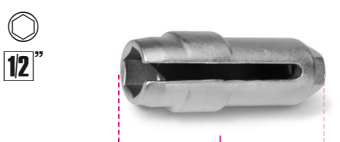

mm	mm	L	Ft	
22	25	98	19.400	1 009600038

960T/H

nyitottvégű hatlapú és tizenkétszögű dugókulcs, 22 mm, 34 mm hosszú, oxigénérzékelőkhez

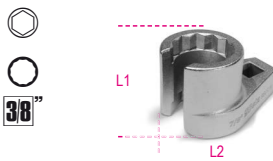

mm	L1	L2	Ft	
22	34	55	7.170	1 009600039

960T/I

nyitottvégű dugókulcs, kompakt, 30 mm hosszú, oxigénérzékelőkhez



mm	L1	L2	Ft	
22	30	81	9.500	1 009600040

960T/L

nyitottvégű dugókulcs, kompakt, 50 mm hosszú, oxigénérzékelőkhez

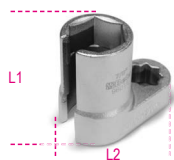

mm	L1	L2	Ft	
22	50	58	7.250	1 009600041

960T/M

M18x1,5 menet



mm	L	Ft	
21	50	2.360	1 009600042

960/22EP

kettős beosztású csuklós kulcs lambdaszondákhoz

sokoldalú használhatóság a hatszög/sokszög beosztásnak és a 180°-os csuklónak köszönhetően



L	mm	mm	Ft	
300	22	22	21.350	1 009600052

960/C6

3/8" dugókulcsok kipufogógáz hőmérséklet érzékelő szenzor eltávolításához/beszereléséhez

Készlet tartalma:
• 3 rövid, 13, 14, 17 mm
• 3 hosszú, 13, 14, 17 mm



960/C6	Ft	
	41.850	1 009600055

170x120x50 mm

960/D

nyitott, hatlapú hosszú dugókulcs, kipufogógáz hőmérséklet érzékelő szenzor eltávolításához/beszereléséhez



mm	Ft	
13	5.680	1 009600073
14	5.680	1 009600074
17	7.020	1 009600077

960YP

nyitott, hatlapú dugókulcs
kipufogógáz hőmérséklet érzékelő szenzor
eltávolításához/beszereléséhez

38"



mm	Ft		
13	6.120	1	009600063
14	6.280	1	009600064
17	8.130	1	009600067

960AVE

Dízel porlasztócsúcs vizsgáló
Common Rail rendszerhez



	Ft		
960AVE	104.300	1	009600245

430x310x50 mm - 2,0 kg

960CMB

Kompressziómérő közvetlen
benzinbefecskendezős motorokhoz



Bar	Ft		
4÷17	251.800	1	009600250

440x370x100 mm - 2,2 kg

960CMB/R2

tartalék kártya a 960CMB készülékhez



	Ft		
960CMB/R2	12.950	1	009600252

960CMD

Kompressziómérő dízel motorokhoz



Bar	Ft		
8÷40	275.400	1	009600270

440x370x100 mm - 2,4 kg

960CMD/R1

tartalék kártya a 960CMD készülékhez



	Ft		
960CMD/R1	12.850	1	009600271

960EPC

Szerszámkészlet izzítógyertyaelektroda
lehúzásához

M8x1 - M9x1 - M10x1 - M10x1,25



	Ft		
960EPC	253.000	1	009600790

270x230x80 mm - 900 g

960EPC/L

izzítógyertya elektródavég lehúzó készlet

M8x1 - M9x1 - M10x1 - M10x1,25



	Ft		
960EPC/L	474.900	1	009600890

270x230x80 mm - 2 kg

960E-PI/P

befecskendezőalátét lehúzó

• M10 menetes csavar a csúszókalapácsos lehúzóval (Beta 1540) történő használathoz



	Ft		
960E-PI/P	26.150	1	009600706

300x90x60 mm

960KC-M8/M9/M10

Szerszámkészlet törött és sérült izzítógyertya
szereléséhez

• Gyertyamenetek: M8-M9-M10



	Ft		
960KC-M8/9/10	170.200	1	009600801

380x290x50 mm - 2,3 kg

960KPC

Izzítógyertya Vibro-kihajtó, jobbos és balos, beállítható nyomaték

14
CE



960KPC Ft 112.300 1 009600780
8-9-10-11-12 mm
420x185x60 mm - 2,8 kg

960UC

szerszám készlet beszorult, deformált hegyű izzítógyertyák kihúzásához M8-M9-M10



960UC Ft 199.700 1 009600900
270x230x80 mm - 2,6 kg

960P

Vákuum és nyomásmérő pisztoly tartozékkal és adapterekkel



960P Ft 102.500 1 009600777
350x320x95 mm - 1,9 kg

960PI

Injektor fészekmaró készlet műanyagdobozban

Injektor fészek tisztításához

- Fészekmaró Ø 19 - 15 mm injektorokhoz
- Fészekmaró Ø 17 - 17 mm Delphi/Bosch (BMW/PSA/Renault/Ford) injektorokhoz
- Fészekmaró Ø 19 - 17 mm Bosch (Mercedes CDI) injektorokhoz
- Sarokmaró Ø 21 - 17 mm Fiat/Iveco injektorokhoz
- Nyél



960PI Ft 50.200 1 009600215
250x130x50 mm - 600 g

960PI/C19

19 darabos szerszámkészlet befecskendező fészek tisztításához

A készlet a következőket tartalmazza:

- 11 lapos furatköszörű, Ø:
14/14 mm - 15,5/15,5 mm - 15/19 mm - 17/19 mm - 17/17,5 mm - 17/19 mm - 17/19,5 mm - 17/20 mm - 18/21 mm - 19 mm - 20/21 mm
- 4 sarok furatköszörű, Ø:
15,5/15,5 mm - 17/17 mm - 17,5/20,5 mm - 17/21 mm
- Markolat és tartozékok csiszolóknak használatához



960PI/C19 Ft 135.400 1 009600217
360x230x60 mm

960PI/S

befecskendező fészek tisztító készlet

A készlet a következőket tartalmazza:

- 3 db acélkefe, Ø 18, 22, 25 mm, a befecskendező fészek tisztításához
- 2 db kefe, Ø 14 és 16 mm, a befecskendező fészek alapos tisztításához
- 6 db égéstéri furat lezáró dugó
- 1 db csőkefe égéstéri furat tisztításához
- 1 db rugalmas bittartó markolattal

14



960PI/S Ft 61.850 1 009600214
360x140x50 mm - 700 g

960VTC

hengerfej szivárgásvizsgáló benzinmotorhoz

miután a hengerbe sűrített levegőt juttatunk, a mérőműszer kimutatja az esetleges szivárgást



960VTC Ft 122.900 1 009600261
373x295x70,6 mm - 2,3 kg

960RPI

fúvó eszköz befecskendező fészek tisztításához

A következő izzítógyertyákkal szerelt motorokhoz M8x1 - M9x1 - M10x1 - M10x1.25



960RPI Ft 76.200 1 009600940

960PMC

Dízel porlasztócsúcs vizsgáló készülék, könnyűfém test, ütészálló műanyagtartály



Bar Max. 600 Ft 307.300 1 009600200

960AVL

Olajgőzelszívó, ütészálló műanyagból



Bar Max. 6 Ft 344.300 1 009600210

Beta

961P6

Elektronikus videoszkóp szondával



CE

- SD CARD (8 GB)
 - Flash-memória (8 GB)
 - Belső memória 128M
 - Kimenet TV-OUT
 - videó-formátum (MP4, AVI, 3GP)
 - 4 LED
 - USB-csatlakozó (beépített akkumulátor)
- MŰSZAKI ADATOK:
- Pixel: 640x480
 - Max. felbontás: 320x240
 - Szonda hossza: 1 m
 - Kameraátmérő: 6 mm
 - Videoformátum: MPEG4, 3GP, AVI, ASF
 - Fotóformátum: JPEG
 - Látószög: 0+180°
 - Dátumkijelzés: USB-kábel, SD-Card
 - Tápegység: 3,7V 2000 mAh

961P6 Ft 296.500 1 009610000

961P6/S

hajlékony szonda, 6 mm



	L mm	Ft		
961P6/S1	1000	131.300	1	009610006
961P6/S2	2000	141.900	1	009610262
961P6/S3	3000	162.200	1	009610263

962

Gumiabroncs szerelővas, krómozott



L mm	A mm	Ft		
300	21	9.690	5	009620003
400	25	11.400	5	009620004
500	27	14.800	3	009620005
600	27	19.200	3	009620006

962C



962C 279

962P

gumiabroncs szerelővas
gumi karcolásvédővel



L mm	A mm	Ft		
490	25	34.250	1	009620049

962M

gumiabroncs leszerelő/felszerelő eszköz

különösen alkalmas Runflat és
alacsony vállú gumi típusokhoz

- karcolásvédő befogópórák a tárcsákra rögzítéshez
- fészek a gumiabroncs szerelővas elhelyezésére



962M Ft 123.400 1 009620501

963

Feszítővas hegyes és hajlított lapos véggel



L mm	A mm	Ft		
400	23	14.400	5	009630001

964

Feszítővas hegyes és emeltyűs
véggel



L mm	A mm	Ft		
400	46	13.250	5	009640001

965

Feszítővas nyéllal



L mm	A mm	L1 mm	Ft		
300	16	185	6.630	2	009650013
450	20	312	9.380	2	009650014
600	20	462	10.800	2	009650016



965/S3 Ft 26.800 1 009650019

966/C3

3 darabos feszítővas készlet, széles és
hajlított állítható fejjel

- 200°-kal elfordítható fej
- A kiválasztott pozíciót automatikusan rögzíti



966/C3 Ft 50.500 1 009660103

L=200-250-300 mm

355x140x65 mm - 1,8 kg

720LS

Gépi dugókulcs hosszú és keskeny kivitel



	Ø mm	L mm	Ø1 mm	Ft	
720LS 36	36	48,0	78	29	12.300

Beta

Quality Tools

969B

Kerékagyszerelő dugókulcs

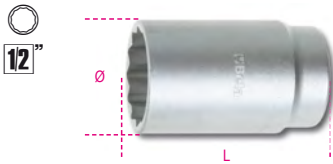

mm	Ø mm	L mm	Ft	1	009690124
24	36,0	76	8.570	1	009690124
27	36,0	76	8.480	1	009690127
30	40,0	76	8.960	1	009690130
31	42,0	76	8.920	1	009690131
32	42,5	76	9.590	1	009690132
34	45,0	76	10.500	1	009690134
35	46,0	76	10.750	1	009690135
36	49,0	76	12.550	1	009690136

969/C5

5 darabos dugókulcskészlet kerékagy szereléséhez műanyag kofferban



969/C5	Ft 52.350	1	009690201
--------	-----------	---	-----------

30-32-34-35-36

970B

Kerékagyszerelő dugókulcs Fiat Daily

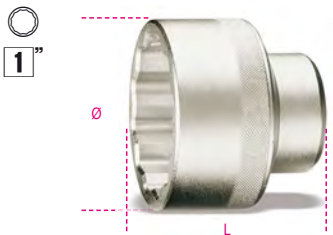

mm	Ø mm	L mm	Ft	1	009700010
65	88	75	43.250	1	009700010

970IVECO

körmös dugókulcs Iveco Daily kerékagy anyagához 2014-es és későbbi modellekhez

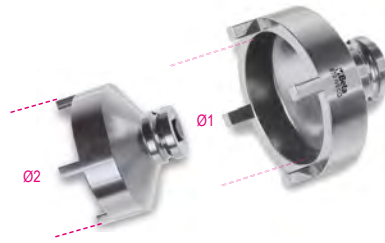

Ø1 mm	Ø2 mm	Ft	1	009700011
61,5	74,8	8.990	1	009700011

971/C8

nyomatécsavarhúzó tartozékokkal a guminyomás ellenőrző rendszerrel rendelkező gumiabroncs szelepek ellenőrzött meghúzásához



971/C8	Ft 132.300	1	009710108
--------	------------	---	-----------

583/6	1,2+6 Nm
892/0	
862TX	T10-T15-T20
900L	11-12 mm
986 78	

972/C4BMW

sérült kerékőr leszerelő készlet BMW és Mini gépjárművekhez



972/C4BMW	Ft 84.250	1	009720004
-----------	-----------	---	-----------

516x145x66 mm - 3,8 kg

972/C10

sérült kerékanya leszedő készlet

biztonsági és hagyományos anyagokhoz



972/C10	Ft 105.700	1	009720010
---------	------------	---	-----------

290x250x60 mm - 2,4 kg

973

4 db gumiabroncs tároló zsák

a következő felírtakhoz:
14" + 18" cikkszám 009730014
19" + 22" cikkszám 009730019



- megvédi az abroncsot a karcolástól és portól
- megakadályozza a nyári és téli gumik polimerjeinek korai fáradását tárolás során
- a kerékabroncs pozíció azonosítását segítő ikon (bal/jobb első/hátsó)
- hordozófüllel
- anyag: mosható nejlón

973 14"+18"	Ft 41.350	1	009730014
973 19"+22"	44.800	1	009730019

978 - 979

Keresztkulcs, hatlapú

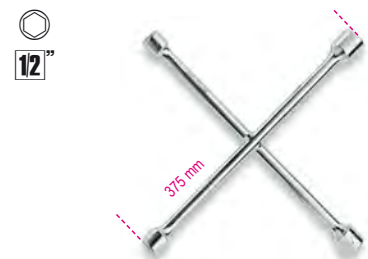

UNI/ISO 6788 DIN 3119

978	Ft 24.850	2	009780001
17x19x21x22 mm			
979	24.850	2	009790001
17x19x22x1/2 mm			

Beta

982

Keresztkulcs, hatlapú, krómozott

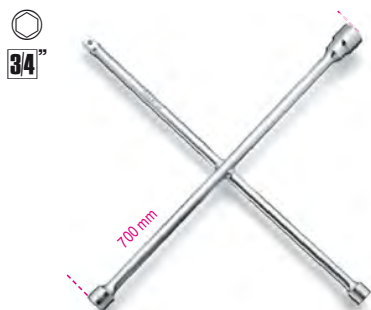

UNI/ISO 6788 DIN 3119

24x27x32x3/4 mm Ft 61.300 1 009820001

983PM

dörzskefe kerékagy tisztításhoz



Ø1 mm 90 Ø2 mm 150 Ft 27.150 1 009830010

983 PM/R-DA

csiszolókorong pár a 983PM modellhez



Ø mm 150 Ft 24.000 1 009830050

984

műanyag kerékanya burkolat fogó



L mm 195 H mm 4 Ft 9.960 1 009840005

985/B7

7 db vezetőcsap készlet kerék szereléshez

Méretek:

- M12X1,25 külső
- M12x1,25 belső
- M12x1,5 külső
- M12x1,5 belső
- M14x1,25 külső
- M14x1,5 külső
- M16x1,5 külső



985/B7 Ft 40.200 1 009850007

985M

külső vezetőcsap kerék szereléshez



	L mm	Ft	1	009850101
985M M12X1,25	150	4.900	1	009850101
985M M12X1,50	150	4.900	1	009850102
985M M14X1,25	150	5.370	1	009850103
985M M14X1,50	150	5.120	1	009850104
985M M16X1,50	150	5.640	1	009850105

985F

belső vezetőcsap kerék szereléshez



	L mm	Ft	1	009850106
985F M12X1,25	150	6.610	1	009850106
985F M12X1,50	150	7.140	1	009850107



Beta
Quality Tools

986 48

Szelepbehúzó szerszám, rövid kivitel

Automatikus szelepbehúzás



L mm 18 L1 mm 48 Ft 5.700 1 009860048

986 78

Szelepbehúzó szerszám

Automatikus szelepbehúzás



L mm 18 L1 mm 78 Ft 5.700 1 009860078

986PT

előkalibrált csavarhúzó 0,4 Nm gumiabroncs szelepekhez

automatikus szelep megtartás

a csúszómechanizmus lehetővé teszi, hogy ne sérüljön a szelep magjának tömítése



L mm 19 L1 mm 120 Ft 19.600 1 009860140

987

Gumiabroncs túszelep szerelő szerszám, védő gumibevonattal



L mm 310 Ft 11.850 1 009870001

987AR

gumiabroncs szelep szerelőszerzőm karcolásvédő bevonattal

- gumi és nylon talp ötvöztött és vas kerékabroncsokhoz
- gyors szelepcsatlakozó, nincs szükség becsavarásra



L mm 305 Ft 38.200 1 009870021

987P

Gumiabroncs túszelep szerelő szerszám, műanyagból

A szerelés közben a szelepet megtartja



L mm 335 Ft 9.970 1 009870011

988/K4

4 darabos vésőkészlet kemény műanyagból

- Különösen alkalmas az ólomsúly eltávolításához a könnyűfémfelnikről
- 3 vágóéllel sokoldalú felhasználást biztosít



988/K4 Ft 10.550 1 009880104
A= 19-21-25-38 mm

989

Keréksúlyszerelő fogó, krómozott



L mm 250 Ft 19.150 2 009890001

989A

keréksúlyszerelő fogó öntapadó súlyokhoz



A befogó pófa úgy van kialakítva, hogy a súlyok eltávolítása során az abronccsal ne érintkezzen

989A L mm 220 Ft 14.200 1 009890011

989B

keréksúlyszerelő kombinált fogó

funkciók:

- öntapadó súlyok eltávolítása fém felnikről
- súlyok eltávolítása vas felnikről
- levehető PE-HD fejű kalapács öntapadó súlyokhoz és vasfelnikhez
- keréksúly fogó pófák acélfelnikhez



L mm 230 Ft 20.450 1 009890015

990

Egyenes csipesz lekerekített hegygel, fogazott, rozsdamentes acélból, polírozott



L mm 130 Ft 4.560 5 009900001

991

Hajlított végű csipesz lekerekített fogazott hegygel, rozsdamentes acélból, polírozott



L mm 130 Ft 5.520 5 009910001

992

Egyenes csapos csipesz lekerekített fogazott hegygel, rozsdamentes acélból, polírozott



L mm 150 Ft 6.050 5 009920001

993

Hajlított végű csapos csipesz lekerekített fogazott hegygel, rozsdamentes acélból, polírozott



L mm 145 Ft 6.540 5 009930001

993PL

Műanyag bevonatú hajlított csipesz fogazott rozsdamentes acélból, PVC-bevonattal



L mm 150 Ft 6.540 3 009930010

 **Beta**

 **Beta**
Quality Tools

993G

Hajlított csapos csipesz sarkított, lekerekített, fogazott hegygel, rozsdamentes acélból, polírozott



L mm 160 Ft 5.820 3 009930030

994

Egyenes csipesz, erősen lekerekített, fogazott hegygel, rozsdamentes acélból polírozott



L mm 150 Ft 4.840 5 009940001

994PL

Műanyag bevonatú egyenes csipesz erősen lekerekített fogazott hegygel, rozsdamentes acélból, PVC-bevonattal



L mm 150 Ft 5.820 3 009940010

994TF

Egyenes csipesz teflonbevonattal, nem mágneses, saválló, erősen lekerekített, fogazott hegygel, rozsdamentes acélból, polírozott



L mm 150 Ft 7.820 3 009940020

996

Szélesfejű csipesz rozsdamentes acélból, polírozott



L mm 150 Ft 5.140 5 009960001

998

Önzáró csipesz, fogazott, rozsdamentes acélból, polírozott



L mm 155 Ft 9.050 5 009980001

999

Csipesz, nem mágneses, saválló, lapos lekerekített hegygel, rozsdamentes acélból, polírozott



L mm 115 Ft 7.080 3 009990011

999A

Egyenes csipesz, nem mágneses, saválló, hegyes végű, rozsdamentes acélból, polírozott



L mm 120 Ft 6.290 3 009990015

999B

Egyenes csipesz, nem mágneses, saválló, keskeny hegyű, rozsdamentes acélból, polírozott



L mm 120 Ft 6.270 3 009990017

999C

Egyenes csipesz, nem mágneses, saválló, tűhegyes, rozsdamentes acélból, polírozott



L mm 110 Ft 6.800 3 009990019

999D

Hajlított csipesz, nem mágneses, saválló, tűhegyes, rozsdamentes acélból, polírozott



L mm 115 Ft 7.560 3 009990021

999E

Hajlított csipesz, nem mágneses, saválló, keskeny hegygel, rozsdamentes acélból, polírozott



L mm 120 Ft 6.800 3 009990023

999G

Egyenes csipesz, nem mágneses, saválló, záró-szerkezettel, tűhegyes, rozsdamentes acélból, polírozott



L mm 140 Ft 6.800 3 009990027

999/B6N

6 darabos csipeszkészlet, saválló, nem mágneses



999/B6N Ft 44.400 1 009990060
999-999A-999B
999C-999D-999E



1002

önzáró fogó lekerekített, recézett pófával, rozsdamentes acélból



L mm 160 Ft 11.250 2 010020001

1008

Hosszú laposfogó PVC-bevonattal



ISO 5745

L mm 160 L1 mm 51,5 Ft 9.920 5 010080006

1008BM

Hosszú laposfogó, krómozott, gumibetétes műanyag nyéllel



ISO 5745

L mm 160 L1 mm 51,5 Ft 12.350 3 010080036

1009

Extra hosszú, félkerekcsőrű műszerészfogó kétrétegű csúszásmentes PVC-bevonattal



ISO 5745

L mm 160 L1 mm 56,5 Ft 9.920 2 010090006

1009L/A

Extra hosszú, egyenes, félkerekcsőrű műszerészfogó, különleges munkákhoz PVC-bevonattal



L mm 283 L1 mm 80 Ft 12.150 2 010090008

1009L/B

Extra hosszú 45°-os hajlított, félkerekcsőrű műszerészfogó Különleges munkákhoz PVC-bevonattal



L mm 273 L1 mm 73 Ft 12.600 2 010090009

1009L/C

Extra hosszú 90°-os hajlított, félkerekcsőrű műszerészfogó, különleges munkákhoz PVC-bevonattal



L mm 253 L1 mm 45 Ft 13.350 2 010090010

1009L/D

extrahosszú, félkerekcsőrű recézett műszerészfogó kettős csuklóval kétrétegű, csúszásálló PVC bevonatú nyéllel



L mm 342 L1 mm 71 Ft 14.200 1 010090058

1009L/DP

extrahosszú, 45° hajlított félkerekcsőrű, recézett, kétszuklós műszerészfogó 2 réteg csúszásmentes PVC bevonatú nyéllel



L mm 336 L1 mm 66 Ft 14.200 1 010090059

1009L/DP-S2

Kettős működésű, extra hosszú, félkerekcsőrű 2 darabos fogókészlet, recézett pófa



1009L/DP-S2 Ft 28.400 1 010090060

1010

Hosszú kerekcsőrű fogó PVC-bevonattal



ISO 5745

L mm 160 L1 mm 51,5 Ft 9.920 2 010100006

1010BM

Hosszú kerekcsőrű fogó, krómozott, gumibetétes műanyag nyéllel



ISO 5745

L mm 160 L1 mm 51,5 Ft 12.350 2 010100036

Beta

SEEGER-FOGÓ

TÖKÉLETES ILLESZTÉS

A tesztek kimutatták, hogy vállalatunk kizárólagos, hidegen sajtolt, különleges fordított kúpos kialakításának köszönhetően a Seeger-gyűrűk (rögzítőgyűrűk) kiválóan illeszkednek a Beta Seeger-fogóba.



NEHEZEBBEN TÖRŐ CSÚCSOK

A hidegen sajtolt csúcsoknak köszönhetően a Beta fogók a versenytársak hasonló termékeihez képest nagyobb tartósságot biztosítanak munka közben és véletlen leesés esetén is.



1031/S4

4 darabos Seeger-fogó készlet



	Ft	📦	🚚
1031/S4	43.500	1	010310000
1032 180			○ 19 ÷ 60 mm
1034 170			○ 19 ÷ 60 mm
1036 175			● 19 ÷ 60 mm
1038 175			● 19 ÷ 60 mm

1032

Egyenes belső Seeger-fogó, barnított, PVC-bevonattal



UNI 7914 DIN 5256

L mm	∅ mm	Ft	📦	🚚
140x0,9	8÷12	9.650	5	010320013
140x1,3	12÷25	9.420	5	010320014
180	19÷60	10.200	5	010320017
225	40÷100	12.500	3	010320021
300	85÷200	17.800	2	010320028

1033

45°-os hajlított belső Seeger-fogó, barnított, PVC-bevonattal



UNI 7914 DIN 5256

L mm	∅ mm	Ft	📦	🚚
140x0,9	8÷12	10.850	5	010330013
140x1,3	12÷25	10.600	5	010330014
180	19÷60	11.100	5	010330017
225	40÷100	14.250	3	010330021

1034

90°-os hajlított belső Seeger-fogó, barnított, PVC-bevonattal



UNI 7914 DIN 5256

L mm	∅ mm	Ft	📦	🚚
130x0,9	8÷12	10.850	5	010340013
130x1,3	12÷25	10.600	5	010340014
170	19÷60	11.100	5	010340017
210	40÷100	14.250	3	010340021
290	85÷200	19.350	2	010340028

1034L

90°-os hajlított hosszúcsőrű Seeger-fogó, krómozott, PVC-bevonatú nyellel



L mm	∅ mm	Ft	📦	🚚
190	40÷100	28.050	2	010340320

1036

Egyenes külső Seeger-fogó, barnított, PVC-bevonattal



UNI 7915 DIN 5254

L mm	∅ mm	Ft	📦	🚚
140x0,9	3÷10	10.700	5	010360013
140x1,3	10÷25	10.150	5	010360014
175	19÷60	10.600	5	010360017
225	40÷100	13.400	3	010360021
300	85÷200	21.350	2	010360028

1037

45°-os hajlított külső Seeger-fogó, barnított, PVC-bevonattal



UNI 7915 DIN 5254

L mm	∅ mm	Ft	📦	🚚
140x0,9	3÷10	11.600	5	010370013
140x1,3	10÷25	11.100	5	010370014
175	19÷60	11.600	5	010370017
225	40÷100	14.450	3	010370021

1038

90°-os hajlított külső Seeger-fogó, barnított, PVC-bevonattal



UNI 7915 DIN 5254

L mm	∅ mm	Ft	📦	🚚
135x0,9	3÷10	11.600	5	010380013
135x1,3	10÷25	11.100	5	010380014
175	19÷60	11.600	5	010380017
220	40÷100	14.450	3	010380021
300	85÷200	22.600	2	010380028

1039

Egyenescsőrű állítható, külső, belső Seeger-fogó, barnított, PVC-bevonattal



L mm	Ø mm	Ø mm	Ft	Icon	Icon
150	10÷15	6÷25	24.600	2	010390015

1558/C4

belső és külső seeger gyűrűkhöz használható szerszám csavaros működéssel

a négyszög csatlakozónak köszönhetően mindkét használati módban nagy erőt alkalmazás történik
Szállított hegyek:
Ø 2,5-3-3,5 mm



Ø mm	Ø mm	Ft	Icon	Icon
1558/C4 5,5 ÷ 77	5,5 ÷ 77	65.900	1	015580100

330x220x50 mm - 900 g

1044

Vízpumpafogó, villás, dupla csúszásálló PVC-bevonattal

· Új modell új pozíciókkal



ISO 8976

L mm	A max mm	L1 mm	Ft	Icon	Icon
250	48	39	12.650	5	010440250

1044F

Vízpumpafogó, barnított, villás PVC-bevonattal
· Modell új pozíciókkal



ISO 8976

L mm	A max mm	L1 mm	Ft	Icon	Icon
250	48	39	10.050	5	010440015

1047

Vízpumpafogó, stifttel állítható, dupla csúszásálló PVC-bevonattal



L mm	A max mm	L1 mm	Ft	Icon	Icon
180	30	29	16.800	2	010470180
240	36	35	15.850	2	010470240
300	50	48	25.850	1	010470300

1047BM

Vízpumpafogó fogasléces, stifttel állítható, bimateriál-nyél



L mm	A max mm	L1 mm	Ft	Icon	Icon
240	36	35	20.500	2	010470340

POLIGRIP - 1048N VÍZPUMPAFOGÓ

KIEMELKEDŐ FOGÁS ÉS EGYEDÜLÁLLÓAN KÖNNYŰ KEZELHETŐSÉG

- A fogak kialakítása miatt jobb fogás a kerek, illetve hatszögletű felületeken
- Az indukciós edzésű fogak tartósabbak
- A fej/ markolat közötti nagyobb szög jobb ergonomikus fogást tesz lehetővé
- Becsípődés elleni védelem a balesetek megelőzésére
- Innovatív, csúszásmentes, PVC bevonatú nyél
- A markolat nagyobb érintkezési felülete páratlanul könnyű fogást és kényelmet biztosít



1048N

vízpumpafogó, csúszásmentes PVC bevonatú nyéllel



ISO 8976

L mm	A max mm	L1 mm	S mm	Ft	Icon	Icon
175	36	31	11	11.500	3	010480910
250	46	38	13	12.450	5	010480915
300	60	44	14.8	18.400	2	010480920

1048N/D3

vízpumpafogó készlet

foszfátzott fej



1048N/D3	Ft	Icon	Icon
175-250-300 mm	42.350	1	010480923

1048BM

Vízpumpafogó, villás, bimateriál nyél

· Új modell új pozíciókkal
· Bimateriál-nyél

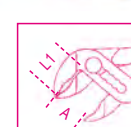

ISO 8976

L mm	A max mm	L1 mm	Ft	Icon	Icon
250	48	39	17.200	3	010480215

1048VN

vízpumpafogó, állítható, narancssárgára lakkozott

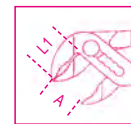

ISO 8976

L mm	A max mm	L1 mm	Ft	Icon	Icon
175	36	31	10.200	3	010480111
250	46	38	11.700	5	010480116
300	60	44	17.050	2	010480121

1050

Kettős állítású önzáró fogó, krómozott



L mm 220 Ft 32.000 2 010500022

1051

Kettős állítású önzáró fogó, hosszú kivitel, krómozott



L mm 255 Ft 35.100 2 010510025

1051GM

Kettős állítású önzáró fogó, önbeálló fej, krómozott



L mm 255 Ft 36.850 2 010510250

1051L

Kettős állítású önzáró fogó, széles tartományú



L mm 270 Ft 40.300 2 010510100

1051XL

Kettős állítású önzáró fogó, széles tartományú, extrahosszú pofa



L mm 270 Ft 47.400 2 010510140

1052

Állítható önzáró fogó, homorú pofájú, krómozott



L mm	A1 max mm	Ft	csomagolás	art. szám
140	22	10.800	3	010520014
190	36	12.100	3	010520019
240	42	12.850	3	010520024
300	55	21.750	2	010520030

1053

Önbeálló pofájú önzáró fogó, krómozott

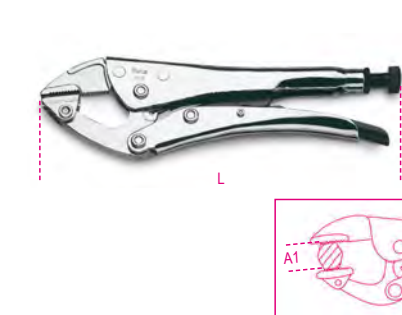

L mm 240 Ft 17.950 2 010530024

1054

Egyenes pofájú önzáró fogó, krómozott



L mm 235 Ft 15.450 2 010540022

1055

Ívelt pofájú önzáró fogó, krómozott, speciális pofaprofil

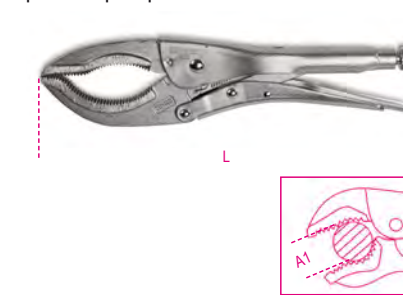

L mm 270 Ft 13.350 2 010550027

1055D

állítható önzáró fogó, anyacsavarokhoz és hengeres profilokhoz



L mm	A1 max mm	Ft	csomagolás	art. szám
195	22	11.200	2	010550119
235	43	12.550	2	010550123

1056

állítható hűtőszerelő önzáró fogó

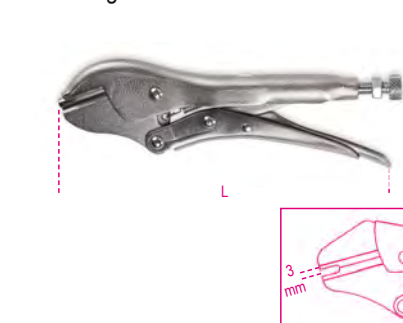

L mm 195 Ft 10.450 2 010560017



1057A

Önzáró fogó szabályozható feszítőerővel



L mm	Ft	2	010570124
240	22.750		

1058

Hosszú pófájú önzáró fogó, krómozott

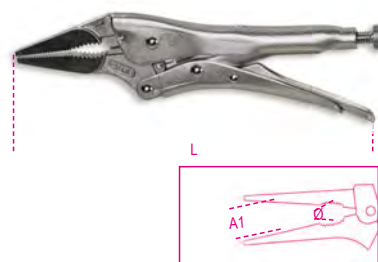

L mm	A1 max mm	Ø max mm	Ft	2	010580017
175	34	26	13.550		
225	46	31	14.050		2 010580025

1059

Csúszópofás önzáró fogó, krómozott

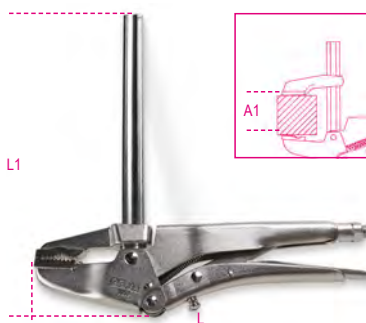

L1 mm	L mm	A1 mm	Ft	1	010590016
160	255	120	28.500		
270	255	220	29.700		1 010590027

Beta

1060

Hegesztőfogó szögvashoz, krómozott

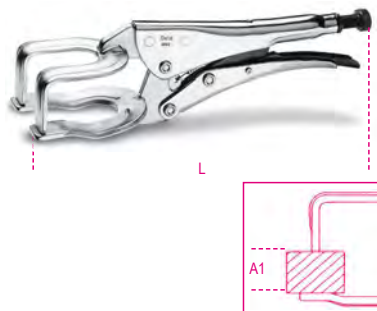

L mm	A1 max mm	Ft	2	010600020
200	50	16.850		
280	80	21.800		2 010600028

1061

Csőhegesztő önzáró fogó, krómozott

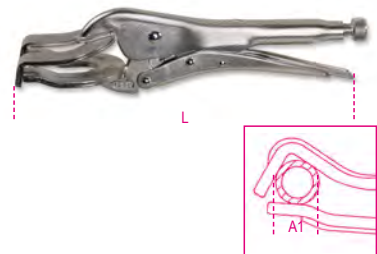

L mm	A1 max mm	Ft	2	010610027
275	80	16.550		

1062

C-pofás önzáró fogó, krómozott

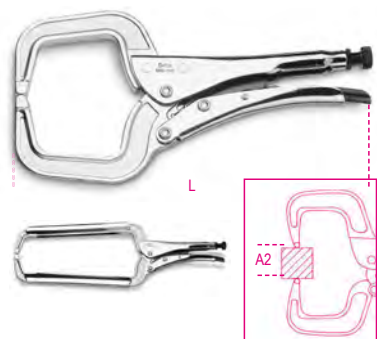

L mm	A2 max mm	Ft	2	010620017
170	50	13.350		
290	120	17.450		2 010620029
460	255	22.550		1 010620045

1062AL

C-pofás önzáró fogó, krómozott, alumíniumpofák

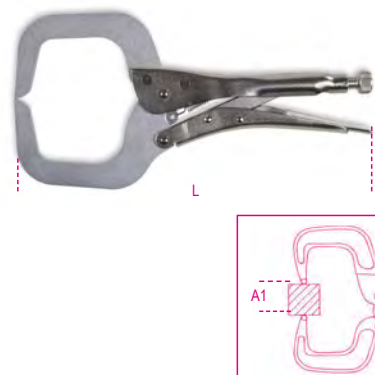

L mm	A1 max mm	Ft	2	010620327
275	88	23.500		

1062GM

C-pofás önzáró fogó, krómozott

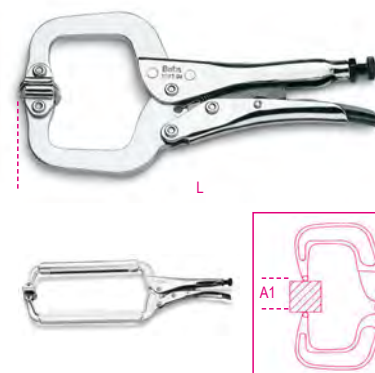

L mm	A1 max mm	Ft	2	010620217
170	45	14.850		
290	88	20.400		2 010620229
460	255	26.250		1 010620245

1063

Bádogos önzáró fogó, krómozott

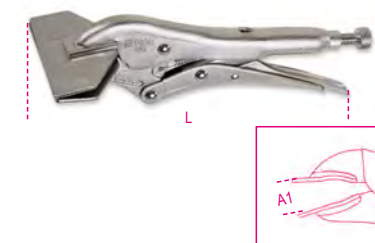

L mm	A1 max mm	Ft	2	010630021
200	31	15.850		

Beta

1064

Láncos önzáró fogó, krómozott



L mm	Ø mm	Ft	csomagolás	azonosító
230	150	20.100	2	010640023

1065F

Lyukasztófó, alumínium test, bélyeg és matrica acélból



Ø mm	L mm	Ft	csomagolás	azonosító
5	228	48.200	1	010650010
6	228	48.200	1	010650015

1065P

Peremezőfogó, acélmatrica, alumíniumtest



L mm	Ft	csomagolás	azonosító
228	48.750	1	010650020

1066

állítható önzáró fogó, 90° zárási szög

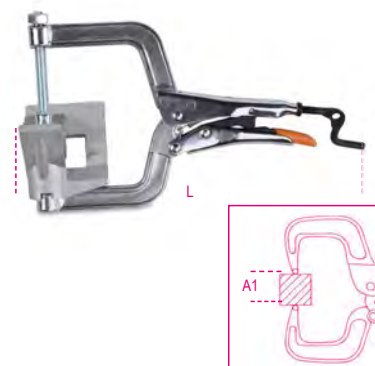

L mm	A1 max mm	g	Ft	csomagolás	azonosító
210	55	500	37.600	1	010660021

1067

állítható önzáró fogó, csuklós csőfogó pózával

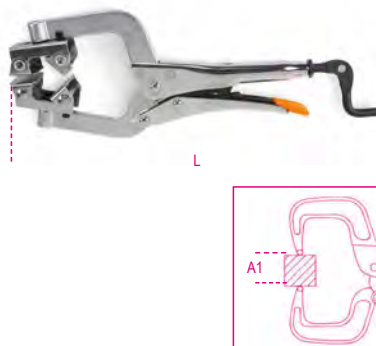

L mm	A1 max mm	Ft	csomagolás	azonosító
285	76	24.000	1	010670285
380	89	26.400	1	010670380

1077

Egyenes szélescsőrű bádogos fogó, barnított, PVC-bevonattal



L mm	A mm	L1 mm	Ft	csomagolás	azonosító
280	60	53	21.350	1	010770026

1078

45°-os hajlított szélescsőrű bádogos fogó, barnított, PVC-bevonattal



L mm	A mm	L1 mm	Ft	csomagolás	azonosító
280	60	77	21.800	1	010780026

1080D

Oldalsípófó, száruk kétrétegű, csúszásmentes PVC-bevonattal

műanyag vágásához

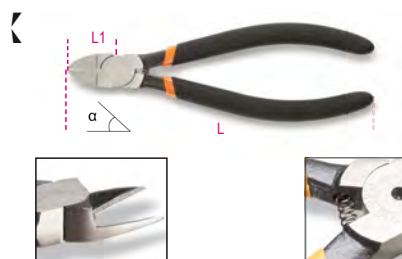

α	L mm	L1 mm	Ft	csomagolás	azonosító
15°	160	22	11.250	3	010800015
45°	160	22	13.550	3	010800045

1081

csípőfogó félkör vágóélel a száruk 2 rétegű csúszásmentes PVC réteggel burkoltak • Erőteljes mikromechanikai és elektronikai használathoz



L mm	L1 mm	Ft	csomagolás	azonosító
125	16	13.300	3	010810130

1082

oldalcsípőfogó, krómozott, csúszásmentes kétrétegű PVC bevonatú markolat



UNI/ISO 5749

L mm	L1 mm	mm	Ft	csomagolás	azonosító
140	20	1,6	10.050	5	010820004
160	22	1,6	10.750	5	010820006

1082G

oldalcsípőfogó, csúszásmentes kétrétegű PVC bevonatú ipari kivitel



UNI/ISO 5749

L mm	L1 mm	mm	Ft	csomagolás	azonosító
140	20	1,6	9.190	5	010820064
160	22	1,6	9.970	5	010820066

1082BM

oldalcsípőfogó, kétkomponensű markolat



UNI/ISO 5749

L mm	L1 mm	mm	Ft	csomagolás	azonosító
140	20	1,6	12.500	3	010820034
160	22	1,6	13.850	3	010820036

1082GBM

oldalcsípőfogó,
kétkomponensű markolat
ipari kivitel



UNI/ISO 5749

L mm	L1 mm	≠ mm	Ft	🔧	🚚
140	20	1,6	11.950	3	010820264
160	22	1,6	13.450	3	010820266

1084

erősített oldalcsípőfogó,
krómozott,
csúszásmentes kétrétegű PVC bevonatú
markolat



UNI/ISO 5749

L mm	L1 mm	≠ mm	Ft	🔧	🚚
160	22	1,6	11.750	5	010840006
200	28	2,0	14.800	3	010840010

1084G

erősített oldalcsípőfogó,
csúszásmentes kétrétegű PVC bevonatú
markolat
ipari kivitel



UNI/ISO 5749

L mm	L1 mm	≠ mm	Ft	🔧	🚚
160	22	1,6	10.750	5	010840066
200	28	2,0	13.900	3	010840070

1084BM

erősített oldalcsípőfogó,
krómozott,
kétkomponensű markolat



UNI/ISO 5749

L mm	L1 mm	≠ mm	Ft	🔧	🚚
160	22	1,6	14.550	3	010840036
200	28	2,0	18.300	3	010840040

1084GBM

erősített oldalcsípőfogó,
kétkomponensű markolat
ipari kivitel



UNI/ISO 5749

L mm	L1 mm	≠ mm	Ft	🔧	🚚
160	22	1,6	16.850	3	010840266
200	28	2,0	20.600	3	010840270

1088

Erősített homlokcsípőfogó
PVC-bevonattal

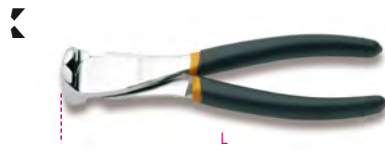

UNI/ISO 5748

L mm	L1 mm	≠ mm	Ft	🔧	🚚
160	9	1,6	14.250	2	010880006
200	11	2,0	18.400	2	010880010

1088BM

Erősített homlokcsípőfogó, krómozott,
gumibetétes műanyag nyéllal



UNI/ISO 5748

L mm	L1 mm	≠ mm	Ft	🔧	🚚
160	9	1,6	17.350	2	010880036
200	11	2,0	23.400	2	010880040

1092V

Áttételes erősített homlokcsípőfogó,
lakkozott

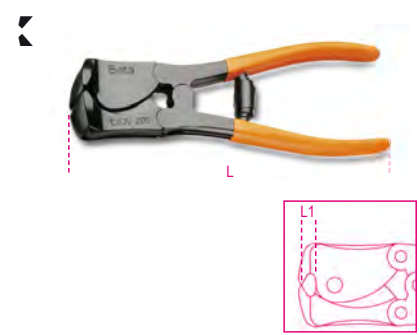

UNI/ISO 5748

L mm	L1 mm	≠ mm	Ft	🔧	🚚
180	8	2,0	56.950	2	010920280
200	9	2,5	59.500	2	010920310

1094V

Áttételes erősített oldalcsípőfogó,
lakkozott



UNI/ISO 5749

L mm	L1 mm	≠ mm	Ft	🔧	🚚
200	23	2,5	56.950	2	010940200

1095N

Áttételes oldalcsípőfogó, barnított,
krómozott



L mm	L1 mm	≠ mm	Ft	🔧	🚚
195	26	1,6	20.500	2	010950010

1096

Harapófogó, lakkozott



ISO 9243

L mm	L1 mm	≠ mm	Ft	🔧	🚚
160	21		7.900	5	010960016
200	23		9.270	5	010960020
250	30		12.050	5	010960025



1098

Rabitz-fogó, lakkozott



ISO 9242 DIN 5242

L	L1	Ft		
mm	mm			
190	12	7.920	5	010980190
220	13	8.960	5	010980220
250	15	10.500	5	010980250
280	18	11.450	5	010980280

1098PL

Rabitz fogó, PVC borítású nyél, lakkozott



ISO 9242 DIN 5242

L	L1	Ft		
mm	mm			
220	13	9.580	5	010980320
250	15	11.200	5	010980350
280	18	12.350	5	010980380

1101

Csapszegvágó, vágókés foszfátózott, lakkozott nyél gumibevonattal



L	L	Ft		
mm	mm			
300	12	22.950	2	011010030
350	14	28.050	2	011010035
450	18	34.350	1	011010045
600	24	47.550	1	011010060
750	30	61.450	1	011010075
900	36	81.850	1	011010090

L	R = 80	R = 140	g	
mm	Kgf=mm ²	Kgf=mm ²		
	Ø mm	Ø mm		
300	5	4	745	
350	6	5	1043	
450	7	6	1537	
600	9	7	2540	
750	11	8	3870	
900	12	9	6170	



1101R

Tartalékfej 1101-hez, foszfátózott



mm	1101	Ft		
300	300	13.900	1	011010130
350	350	16.200	1	011010135
450	450	20.150	1	011010145
600	600	27.600	1	011010160
750	750	34.400	1	011010175
900	900	45.250	1	011010190

1102

Mini csapszegvágó, foszfátózott, száruk lakkozottak

R= 80 Kgf/mm²



L	mm	Ft		
230	4	16.750	3	011020020

1103

csapszegvágó 90 fokos vágóélel rúdvashoz, csapszeghez és elektromosan hegesztett betonhálózhoz

max. Ø = 12 mm
max. Ø (HRC 48) = 6 mm



L	Ft		
mm			
950	67.800	1	011030090

1103R

tartalék fej a 1103 termékhez



1103R 950	Ft		
	43.750	1	011030190

1104

Drótkötélvágó, szárvég hőkezelt műanyag bevonattal



R=80 Kgf/mm²

L	mm	Ft		
420	12	58.350	1	011040004
600	16	86.450	1	011040006

1104R

Tartalékkész a 1104-hez



mm	Ft		
420	35.750	1	011040014
600	51.150	1	011040016

1105

Tömítéskivágó, barnított acélból



D	L	Ft		
mm	mm			
2	27	5.740	1	011050002
3	27	5.740	1	011050003
4	27	5.740	1	011050004
5	27	5.740	1	011050005
6	27	5.740	1	011050006
7	27	5.740	1	011050007
8	27	5.740	1	011050008
9	27	5.740	1	011050009
10	27	5.740	1	011050010
12	27	7.050	1	011050012
14	27	7.050	1	011050014
16	27	7.050	1	011050016
18	27	7.050	1	011050018
20	27	7.050	1	011050020
22	32	8.890	1	011050022
24	32	8.890	1	011050024
26	32	8.890	1	011050026
28	32	8.890	1	011050028
30	32	8.890	1	011050030
32	37	11.400	1	011050032
34	37	11.400	1	011050034
36	37	11.400	1	011050036
38	37	11.400	1	011050038
40	37	11.400	1	011050040
42	42	13.650	1	011050042
44	42	14.200	1	011050044
46	42	14.200	1	011050046
48	42	14.200	1	011050048
50	42	14.200	1	011050050

1105T20

nyél az 1105-höz
Ø 2-20 mm



L mm	Ft		
110	29.800	1	011050200

1105T30

Nyél a 1105-höz
Ø 3-30 mm



L mm	Ft		
175	58.150	1	011050205

1105T50

Nyél a 1105-höz
Ø 2-50 mm



L mm	Ft		
175	57.850	1	011050207

1105AD-50

Adapter a 1105T50-hez



Ø mm	Ft		
57	39.500	1	011050210

1105/C10T

10 darabos tömítéskivágó készlet,
Ø 3-20 mm, egy tartozékkal



1105/C10T	Ft		
	73.000	1	011050250

1105	3 - 4 - 6 - 8 - 10 - 12 - 14 - 16 - 18 - 20 mm		
1105T20			
135x92x32 mm			

1105/C16T

15 darabos tömítéskivágó készlet,
Ø 3-30 mm, egy tartozékkal



1105/C16T	Ft		
	110.300	1	011050255

1105	3 - 4 - 6 - 8 - 10 - 12 - 14 - 16 - 18 - 20 - 22 - 24 - 26 - 28 - 30 mm		
1105T30			
240x210x60 mm			

1105/C32T

29 darabos tömítéskivágó készlet,
Ø 2-50 mm, 3 tartozékkal



1105/C32T	Ft		
	214.300	1	011050257

1105	2 - 3 - 4 - 5 - 6 - 7 - 8 - 9 - 10 - 12 - 14 - 16 - 18 - 20 - 22 - 24 - 26 - 28 - 30 - 32 - 34 - 36 - 38 - 40 - 42 - 44 - 46 - 48 - 50 mm		
1105T50			
1105AD-50			
455x380x115 mm			

1112

Bádogos olló amerikai modell,
krómozott, nyél PVC-bevonattal

R = $\pm 0,05$ 60 Kgf/mm²



L	L1	S	A	Ft		
200	50	0,5	26	10.050	2	011120020
250	62	0,8	33	12.200	2	011120025
300	76	1,0	37	15.850	2	011120030
375	76	1,2	44	23.700	1	011120037

1114

Bádogos olló amerikai modell,
keskeny, egyenes élekkel
R = 60 Kgf/mm²

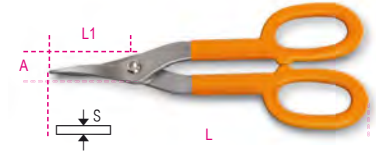

L	L1	S	A	Ft		
250	58	0,5	15	10.600	1	011140265
350	76	1	22	14.300	1	011140340

1118

Lemezolló acélszalag vágásához

Fe = Normálacél
Inox = rozsdamentes acél



L	L1	Fe	Inox	Ft		
310	42	S mm	S mm	17.300	2	011180001
		1	0,8			

1120A

Lemezolló

Fe = normál acél



L	Fe	Ft		
280	S mm	28.900	1	011200101
	1,2			

1120ARL - ARG

Tartalék az 1120A-hoz



1120ARL	Ft		
	6.890	1	011200110
1120ARG	Ft		
	8.560	1	011200120

1122

Áttételes egyenes lemezolló

Inox = rozsdamentes acél



L	L1	Inox	A	Ft		
250	40	S mm	mm	13.850	2	011220020
		1	24			

1123

Áttételes jobbos lemezolló

Inox = rozsdamentes acél

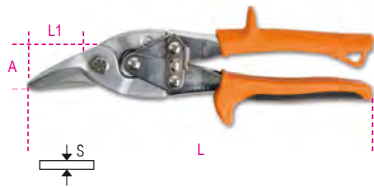

L	L1	Inox	A	Ft		
mm	mm	S mm	mm			
250	40	1	24	13.850	2	011230020

1124

Áttételes balos lemezolló

Inox = rozsdamentes acél



L	L1	Inox	A	Ft		
mm	mm	S mm	mm			
250	40	1	24	13.850	2	011240020

1125

Erosített áttételes jobbos lemezolló

Inox = rozsdamentes acél

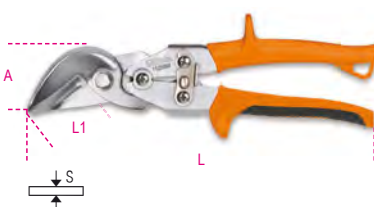

L	L1	Inox	A	Ft		
mm	mm	S mm	mm			
250	35	1	46	21.300	2	011250020

1126

Erosített áttételes balos lemezolló

Inox = rozsdamentes acél

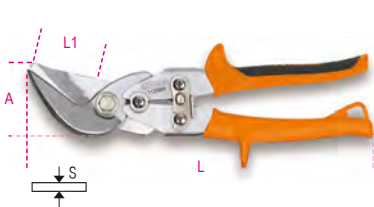

L	L1	Inox	A	Ft		
mm	mm	S mm	mm			
250	35	1	46	21.300	2	011260020

1122 - 1125MOL



		Ft		
1122 MOL	1122 - 1124	560	1	011220010
1123 MOL	1123	560	1	011230010
1125 MOL	1125 - 1126	560	1	011250040

1127

Drótvágó olló egyenes élű, krómozott, PVC-bevonattal



L	L1	Ft		
mm	mm			
150	35	6.180	5	011270001

1128BAX

kettős hatású villanszerelő olló, lépcsős profil, rozsdamentes acél, DLC bevonat

kettős hatású vágás: egy különleges bütyökkel a forgásponton létrejön a pengék hosszirányú elmozdulása, amely a zárási fázisban megnöveli a vágási teljesítményt.

lépcsős profil: 13 és 24 mm közötti furatok tágitására létrehozva műanyagokon.

DLC bevonat; A DLC (diamond-like carbon) egy újszerű, szénelapú bevonat: a nagyfokú keménység és az alacsony súrlódási együttható a felületen a grafit és gyémánt formában lerakódott szénnek köszönhető.

- nagy felületi keménység a pengénél (nagy kopásállóság és időtálló pengeélesség)
- alacsony súrlódási együttható (gördülékenység és vágási teljesítmény)
- kilazulásbiztos excentrikus csap
- széles markolat csőfogó nyakkal
- rugalmas műanyag tokkal



L	L1	mm ²	Ft		
mm	mm				
150	50	50	12.550	5	011280088

1128BMX

Egyenes élű műszerész olló rozsdamentes acélból, mikrofogazattal



L	L1	Ft		
mm	mm			
147	58,2	8.240	5	011280051

1128BMX/F

rugalmas műanyag tok a 1128BMX modellhez



	Ft		
1128BMX/F	640	1	011280059

Beta

1128FXS TÍPUSÚ MŰSZERÉSZ OLLÓ SKÁLABEOSZTÁSOS MARÓPROFILOKKAL

A műszerész olló újratervezéséhez megfigyeltük a szakembereket munka közben. Olyan univerzális szerszámot alkottunk, amely 4 fő funkciót egyesíti egy eszközben.

VÁGÁS Gyors és éles, akár 50 mm átmérőjű kábelekhez is, kábelvágó horonnyal és mikrofogazatú pengével a biztosabb fogáshoz.

BLANKOLÁS Az érzékeny, kilazulásbiztos csapnak köszönhetően a legvékonyabb kábel is pontosan blankolható.

KRIMPELÉS Biztonságos és tartós, kábelsarukhoz.

SÜLLYESZTÉS A maróprofilal pontosan és formásan mélyíthetők az átvezetődobozok furatai.



1128BAX KETTŐS HATÁSÚ VILLANYSZERELŐ OLLÓ LÉPCSŐS PROFILLAL, ROZSDAMENTES DLC BEVONATTAL

A 1128BAX ollók DLC-bevonatukkal tűnnek ki. A DLC (diamond-like carbon) egy újszerű, szénalapú bevonat: a nagyfokú keménység és az alacsony súrlódási együttható a felületen a grafit és gyémánt formában lerakódott szénnek köszönhető.

- A penge nagy felületi keménysége - kopásállóság és időtálló pengeélesség
- Alacsony súrlódási együttható - gördülékenysége és tapadásgátlás

Lépcsős profil: 13 és 25 mm közötti furatok tágitására alkalmas műanyagokon.



**+ NAGYOBB KEMÉNYSÉG
- KISEBB SÚRLÓDÁSI EGYÜTTHTATÓ**



1128BSX

Műszerész olló lépcsős maróprofilal tokban



L mm	L1 mm	Ft	5	011280061
148	58,2	11.900		

1128FX

műszerész olló, egyenes rozsdamentes acél él, mikrofogazattal, kábelvágó és krimpelő kábelsarukhoz és csövekhez

- Rugalmas, övre akasztható tokkal
- Bimateriál nyél
- Kilazulásbiztos csap



L mm	L1 mm	mm ²	Ft	5	011280090
145	52	50	12.400		

1128FXS

műszerész olló lépcsős maróprofilal, egyenes rozsdamentes acél él, mikrofogazattal, kábelvágó és krimpelő kábelsarukhoz és csövekhez

- Rugalmas, övre akasztható tokkal
- Bimateriál nyél
- Kilazulásbiztos csap
- Profil és maró: műanyagon fúrt lyukak tágitásához, 13-21 mm között.



L mm	L1 mm	mm ²	Ft	5	011280095
145	52	50	11.950		

1128BM

Egyenes élű műszerész olló



L mm	L1 mm	Ft	5	011280000
145	50	6.320		

1129BM

Hajlított élű műszerész olló



L mm	L1 mm	Ft	5	011290000
145	44	6.770		

1130BMX

univerzális olló rozsdamentes acél, egyenes élekkel mikrofogazattal



L mm	L1 mm	Ft	1	011300002
185	60	7.840		

1131CK

Kevlar®- és optikai szál vágó olló



L mm	L1 mm	Ft	1	011310001
203	75	32.450		

1132

Kábelvágó szigetelt réz és alumínium kábelhez PVC-bevonattal



UNI 8791

L	~	mm	mm ²	Ft	🔧	📄
170	14	50	19.250	2	011320107	
230	18	95	23.750	2	011320113	

1132BM

Kábelvágó, krómozott, gumibetétes műanyag nyéllel



UNI 8791

L	~	mm	mm ²	Ft	🔧	📄
170	14	50	23.850	2	011320137	
230	18	95	29.600	2	011320143	

1133

Kábelvágó réz kábel vágásához

325 mm²-ig



L	~	mm	mm ²	Ft	🔧	📄
600	32	300	67.850	1	011330001	

1133RL

Tartalékkész az 1133 modellhez



1133RL Ft 49.450 1 011330011

1134

Racsnis kábelvágó, barnított, műanyag nyél



L	~	mm	mm ²	Ft	🔧	📄
260	35	400	195.000	1	011340032	

1134RL

Tartalékkész az 1134-hez.



1134RL Ft 91.500 1 011340132

1134A

Racsnis kábelvágó, barnított, műanyag nyél



L	~	mm	mm ²	Ft	🔧	📄
240	45	500	293.200	1	011340045	

1134A/RL

Tartalékkész az 1134A-hoz



1134A/RL Ft 140.500 1 011340145



Beta

1142BM

Kábelcsupaszoló fogó, krómozott, gumibetétes műanyag nyéllel



UNI 7923

L	~	mm ²	mm	Ft	🔧	📄
160	0,5÷6	0-2,8	15.750	3	011420036	

1143

Vágó és csupaszoló fogó



L	~	mm ²	mm	Ft	🔧	📄
165	0,5÷6	1-3,2	32.150	1	011430001	

1143R

Tartalékkész 1143-hoz

1143R Ft 8.090 1 011430011

1144D

Kábelcsupaszoló



L	~	mm ²	mm	Ft	🔧	📄
170	4,5÷240	2,5-18	37.750	1	011440010	

1144D/RG

Tartalékkampó a 1144D-hez



1144D/RG Ft 12.400 1 011440012

1144D/RL

Tartalékkész a 1144D-hez

1144D/RL Ft 19.400 1 011440011

1144G

huzalcsupaszító

állítható pengével a keresztirányú és hosszirányú vágásokhoz



L	~	mm ²	mm	Ft	🔧	📄
140	6÷75	2,8-12	21.350	1	011440004	

1144G/RL

cserepenge a 1144G fogóhoz



1144G/RL	Ft	1	0114440005
	4.560		

1144L

kábelcsupaszoló állítható pengével kereszt- és hosszirányú blankoláshoz

sima és horog alakú visszahúzható pengével



L			Ft	1	0114440050
mm	mm ²	mm	12.350		
145	6-150	4-28			

1144T

kábelcsupaszoló, zsebben elfér, kábelvágóval



L			Ft	1	0114440060
mm	mm	g	9.260		
112	3,5 ÷ 9	40			

1148A

Automata kábelcsupaszoló fogó

10 mm² (8 AWG) hajlékony vezeték esetén
1,5 mm² (16 AWG) nem hajlékony vezeték esetén



L			Ft	1	011480100
mm	mm ²	mm	65.500		
190	0,02-10	0-4			

1148A/R

Tartalékpofo a 1148A-hoz



1148A/R	Ft	1	011480102
	27.750		

Beta

1148B

Automata vágó és csupaszoló fogó



L			Ft	1	011480200
mm	mm ²	mm	75.900		
190	4 ÷ 16	2-5			

1148B/R

Tartalékpofo a 1148B-hoz



1148B/R	Ft	1	011480202
	34.200		

1148P

automata kábelcsupaszoló fogó



L			Ft	1	011480300
mm	mm ²	mm	17.950		
165	0.2-6	0-3.5			

1149F

Automata vágó- és csupaszoló fogó



L		Ft	1	011490010
mm	mm ²	7.010		
175	0,2 ÷ 6			

1150

Kombinált fogó
Krómózott, polírozott
PVC-bevonattal

• Az eltolt csap növeli az erőkart, így csökkentve a vágáshoz szükséges erőt, amivel növeli a hatékonyságot.



ISO 5746

L	L1		Ft	5	011500046
mm	mm	mm	7.800		
160	42	1,6	8.490		011500048
180	46	1,8	9.230		011500050
200	50	2,0	10.100		011500052
220	50	2,0			

1150G

robosztus kombinált fogó
csúszásmentes kétrétegű PVC bevonatú
markolat
ipari kivitel

• Kimagasló minőség/ár arány
• Az eltolt csap növeli az erőkart, így csökkentve a vágáshoz szükséges erőt, amivel növeli a hatékonyságot.



ISO 5746

L	L1		Ft	5	011500066
mm	mm	mm	7.450		
160	42	1,6	8.580		011500068
180	46	1,8	8.790		011500070
200	50	2,0	9.510		011500072
220	50	2,0			

Beta

1150HPC STRAPABÍRÓ KOMBINÁLTFOGÓ M2 SZINTERACÉLBÓL KÉSZÜLT VÁGÓÉLEKKEL

- A decentralizált csap közelebb viszi a forgáspontot a vágási ponthoz, így módon növelve az erőkar hatását.
- A tökéletesen illeszkedő vágóélnek és a vékony kialakításnak köszönhetően a fogó rendkívül szűk helyeken is használható.
- A fogótest fokozott rugalmasságot és szilárdságot eredményező robusztus, hőedzett molibdén-acél ötvözet, amely minden körülmények között biztonságos tapadást biztosít.

Nyírófeszültség – statikus tesz =	-73%
Vágóélek átlagos élettartama (ISO 5744 szerinti vizsgálat) =	+127%
M2 acél vágóélek keménysége =	65HRC

RENDKÍVÜL INNOVATÍV

KRÓMOZOTT GYÖNGYHÁZ FELÜLET

KIEMELKEDŐ VÁGÓTELJESÍTMÉNY



1150HPC

robusztus kombinált fogó integrált vágóélel és decentralizált csappal krómozott, polírozott kétkomponensű markolat szabad csukló

integrált vágóél
acél: M2
vastagság: 0,20 mm
nyitási szög: 62°
keménység: 63+65 HRC



ISO 5746

L mm	L1 mm	mm	Ft		
180	42	1,8	24.600	2	011500618

1150BM

Kombinált fogó, krómozott, polírozott, gumibetétes műanyag nyéllal

- Az eltolt csap növeli az erőkart, így csökkentve a vágáshoz szükséges erőt, amivel növeli a hatékonyságot.



ISO 5746

L mm	L1 mm	mm	Ft		
160	42	1,6	9.680	3	011500146
180	46	1,8	10.650	3	011500148
200	50	2,0	11.750	3	011500150
220	50	2,0	12.550	2	011500152

1150GBM

robusztus kombinált fogó kétkomponensű markolat ipari kivétel

- Az eltolt csap növeli az erőkart, így csökkentve a vágáshoz szükséges erőt, amivel növeli a hatékonyságot.
- Kimagasló minőség/ár arány



ISO 5746

L mm	L1 mm	mm	Ft		
160	42	1,6	9.300	3	011500266
180	39	1,8	10.500	3	011500268
200	50	2,0	11.100	3	011500270
220	50	2,0	12.000	2	011500272

1153

Állítható kombináltfogó, krómozott, PVC bevonattal



UNI ISO 9343

L mm	L1 mm	Ft		
200	34	8.540	2	011530120

1162

extra hosszú laposfogó, krómozott, csúszásmentes kétrétegű PVC bevonatú markolat



ISO 5745

L mm	L1 mm	mm	Ft		
160	58	1,6	8.710	5	011620006
200	86	1,6	9.960	5	011620010



1162G

extra hosszú laposfogó,
csúszásmentes kétrétegű PVC bevonatú
markolat
ipari kivitel

• Kimagasló minőség/ár arány



ISO 5745

L mm	L1 mm	mm	Ft	5	3
160	58	1,6	7.500	5	011620066
200	86	1,6	9.400	5	011620070

1162BM

extra hosszú laposfogó,
krómozott,
kétkomponensű markolat



ISO 5745

L mm	L1 mm	mm	Ft	5	3
160	58	1,6	10.850	5	011620036
200	86	1,6	12.500	3	011620040

1162GBM

extra hosszú laposfogó,
kétkomponensű markolat
ipari kivitel

• Kimagasló minőség/ár arány



ISO 5745

L mm	L1 mm	mm	Ft	5	3
160	58	1,6	9.340	5	011620266
200	86	1,6	11.850	3	011620270

1164

Hajlított extra hosszú laposfogó
PVC-bevonattal



ISO 5745

L mm	L1 mm	mm	Ft	5	3
160	54	1,6	9.340	5	011640006
200	76	1,6	10.800	5	011640010

1164BM

Hajlított extra hosszú laposfogó,
krómozott, gumibetétes műanyag
szárral



ISO 5745

L mm	L1 mm	mm	Ft	5	3
160	54	1,6	11.750	3	011640036
200	76	1,6	13.650	3	011640040

1166

egyenes extra hosszú félkerescsőrű fogó,
krómozott,
csúszásmentes kétrétegű PVC bevonatú
markolat



ISO 5745

L mm	L1 mm	mm	Ft	5	3
160	56	1,6	8.710	5	011660006
200	76	1,6	9.960	5	011660010

1166G

egyenes extra hosszú félkerescsőrű fogó,
csúszásmentes kétrétegű PVC bevonatú
markolat
ipari kivitel

• Kimagasló minőség/ár arány



ISO 5745

L mm	L1 mm	mm	Ft	5	3
160	56	1,6	7.500	5	011660066
200	76	1,6	9.400	5	011660070

1166BM

egyenes extra hosszú félkerescsőrű fogó,
krómozott,
kétkomponensű markolat



ISO 5745

L mm	L1 mm	mm	Ft	5	3
160	56	1,6	10.850	3	011660036
200	76	1,6	12.500	3	011660040

1166GBM

egyenes extra hosszú félkerescsőrű fogó,
kétkomponensű markolat
ipari kivitel

• Kimagasló minőség/ár arány



ISO 5745

L mm	L1 mm	mm	Ft	5	3
160	56	1,6	9.780	3	011660266
200	76	1,6	11.850	3	011660270

1168

hajlított extra hosszú félkerescsőrű fogó,
krómozott,
csúszásmentes kétrétegű PVC bevonatú
markolat



ISO 5745

L mm	L1 mm	mm	Ft	5	3
160	54	1,6	9.340	5	011680006
200	76	1,6	10.800	5	011680010

1168G

hajlított extra hosszú félkerescsőrű fogó,
csúszásmentes kétrétegű PVC bevonatú
markolat
ipari kivitel

• Kimagasló minőség/ár arány



ISO 5745

L mm	L1 mm	mm	Ft	5	3
160	54	1,6	8.200	5	011680066
200	76	1,6	9.850	5	011680070

1168BM

hajlított extra hosszú félkerekcsőrű fogó,
krómozott,
kétkomponensű markolat



ISO 5745

L	L1	mm	Ft		
mm	mm	mm			
160	54	1,6	11.750	3	011680036
200	70	1,6	13.650	3	011680040

1168GBM

hajlított extra hosszú félkerekcsőrű fogó,
kétkomponensű markolat
ipari kivitel

• Kimagasló minőség/ár arány



ISO 5745

L	L1	mm	Ft		
mm	mm	mm			
160	54	1,6	10.650	3	011680266
200	70	1,6	11.950	3	011680270

1169/D3

1 kombinált fogó, 1 hosszú félkerekcsőrű fogó,
1 oldalcsípőfogó



1169/D3	Ft		
1082 160mm	27.950	1	011690053
1150 180mm			
1166 160mm			

1169G/D3

1 kombinált fogó,
1 hosszú félkerekcsőrű fogó,
1 oldalcsípőfogó, csúszásmentes kétrétegű
PVC bevonattal, ipari kivitel

• Kimagasló minőség/ár arány



1169G/D3	Ft		
1082G 160mm	26.050	1	011690073
1150G 180mm			
1166G 160mm			

1169BM/D3

1 kombinált fogó, 1 hosszú félkerekcsőrű fogó,
1 oldalcsípőfogó
Bimateriális nyél



1169BM/D3	Ft		
1082BM 160mm	35.350	1	011690133
1150BM 180mm			
1166BM 160mm			

1169GBM/D3

1 kombinált fogó,
1 hosszú félkerekcsőrű fogó,
1 oldalcsípőfogó, kétkomponensű markolat,
ipari kivitel

• Kimagasló minőség/ár arány



1169GBM/D3	Ft		
1082GBM 160mm	33.750	1	011690273
1150GBM 180mm			
1166GBM 160mm			

1171BM

Elektronikai laposfogó, polírozott
bimateriális szár



ISO 9655

L	L1	A	B	Ft		
mm	mm	mm	mm			
130	18	12	8	14.950	2	011710101

1172BM

Elektronikai laposfogó, hosszított kivitel,
polírozott
bimateriális szár

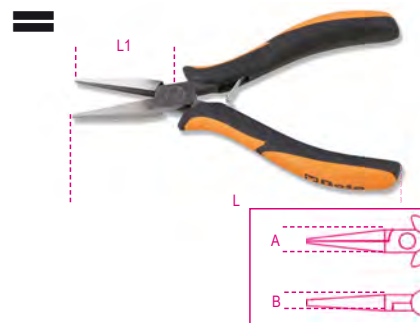

ISO 9655

L	L1	A	B	Ft		
mm	mm	mm	mm			
140	40	12	8	14.950	2	011720101

1172BM/P

Hajlított elektronikai laposfogó, hosszított
kivitel, polírozott
bimateriális szár



L	L1	A	B	Ft		
mm	mm	mm	mm			
140	38	12	13	16.750	2	011720102



1173BM

Elektronikai kerekcsőrű fogó, rövid kivitel, bimateriális szár



ISO 9655

L	L1	A	B	Ft	W	U
125	mm 22	mm 12	mm 8	14.950	2	011730101

1175BM

Elektronikai félkerekcsőrű fogó, rövid kivitel, polírozott bimateriális szár



ISO 9655

L	L1	A	B	Ft	W	U
140	mm 29	mm 12	mm 8	14.950	2	011750101

1177BM

Elektronikai félkerekcsőrű fogó, hosszított kivitel, bimateriális szár



ISO 9655

L	L1	A	B	Ft	W	U
140	mm 38	mm 12	mm 8	14.950	2	011770101

1177BM/Z

Elektronikai félkerekcsőrű fogó, hosszított kivitel, recézett bimateriális szár

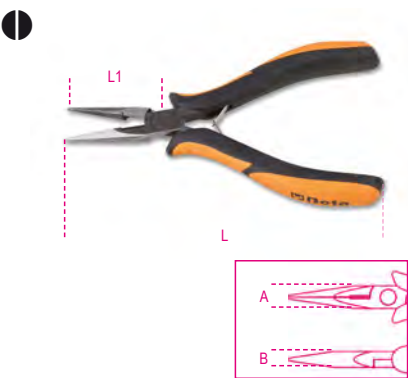

ISO 9655

L	L1	A	B	Ft	W	U
140	mm 39	mm 12	mm 8	16.750	2	011770113

1178BM

Elektronikai félkerekcsőrű fogó, hosszított kivitel, polírozott bimateriális szár

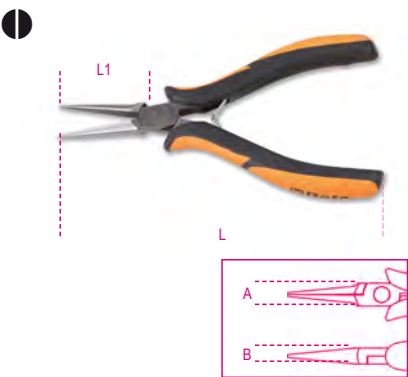

ISO 9655

L	L1	A	B	Ft	W	U
140	mm 37	mm 12	mm 8	16.750	2	011780101

1178BM/P

Elektronikai hajlított félkerekcsőrű fogó, hosszított kivitel, polírozott bimateriális szár

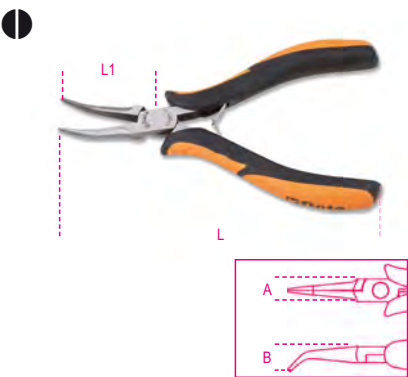

L	L1	A	B	Ft	W	U
140	mm 36,5	mm 12	mm 12	16.750	2	011780102

Rézvágó csípőfogók. Intenzívebb igénybevétel esetén lásd a 1081-es számú terméket.

1182BM

Speciális elektronikai oldalcsípőfogó, keskeny pófával bimateriális szár



ISO 9654

L	L1	A	Cu	Ft	W	U
mm 120	mm 11	mm 10	mm 1	16.750	2	011820101

1183BM

Speciális elektronikai oldalcsípőfogó, lekerekített pófával bimateriális szár



ISO 9654

L	L1	A	Cu	Ft	W	U
mm 120	mm 11	mm 10	mm 1	16.750	2	011830101



1184BM

Speciális elektronikai oldalcsípőfogó, lekerekített pófával bimateriális szár



ISO 9654

L mm	L1 mm	A mm	Cu mm	Ft	🔧	📄
120	11	10	1	16.750	2	011840101
130	13	12,5	1,25	16.750	2	011840102

1185BM

Speciális elektronikai oldalcsípőfogó, keskeny pófával bimateriális szár



ISO 9654

L mm	L1 mm	A mm	Cu mm	Ft	🔧	📄
120	11	10	1	16.750	2	011850101
130	13	12,5	1,25	16.750	2	011850102

1186BM

Speciális elektronikai oldalcsípőfogó, keskeny nyújtott pófával bimateriális szár



ISO 9654

L mm	L1 mm	A mm	Cu mm	Ft	🔧	📄
120	11	10	1	16.750	2	011860101
130	13	12,5	1,25	16.750	2	011860102

1188BM

Elektronikai oldalcsípőfogó középívással bimateriális szár



ISO 9654

L mm	L1 mm	A mm	Cu mm	Ft	🔧	📄
125	12	12	1,25	16.750	2	011880101
130	17	15	2	16.750	2	011880102

1190BM

Speciális elektronikai homlokcsípőfogó bimateriális szár



ISO 9654

L mm	L1 mm	A mm	Cu mm	Ft	🔧	📄
120	12	12	1,25	16.750	2	011900113

1191BM

Speciális elektronikai homlokcsípőfogó, ferde vágóéllel bimateriális szár



ISO 9654

L mm	L1 mm	A mm	Cu mm	Ft	🔧	📄
130	8	12	0,8	16.750	2	011910101

1191BM/L

Speciális elektronikai homlokcsípőfogó, ferde vágóéllel, hosszított kivitel, keskeny pófával bimateriális szár



ISO 9654

L mm	L1 mm	A mm	Cu mm	Ft	🔧	📄
130	18	12	1	16.750	2	011910110

1191R/5-M

tartalékrugó készlet elektronikai fogókhoz és csípőfogókhoz (Cikkszámok: 1171...1191)

	Ft	🔧	📄
1191R/5-M	3.030	1	011910995

1200MS

Mágnesező/mágnesmentesítő



	Ft	🔧	📄
1200MS	6.170	5	012000000



A CSAVARHÚZÓ EVOLÚCIÓJA!

Az ergonomikus markolat tökéletesen illeszkedik a kézbe. A nagy érintkezési felületnek köszönhetően kis erőfeszítéssel is nagy erőátvitel érhető el. A Beta kipróbált pengéi egyedi rugalmasságot, keménységet és kopásállóságot biztosítanak a felső kategóriás professzionális szerszámoknak. A nyolcszögű markolat megakadályozza az elgurulást. A precíziósan kialakított fejnél fogva a csavarhúzó az ujjak között is gyorsan forgatható. A markolaton elhelyezett lyuknál felakasztva a csavarhúzó könnyebben tárolható. Az új, hőkezelt gumi még az intenzív munkáknál is kényelmes fogást biztosít. A fej típusa és mérete a kerek markolatvégre van nyomtatva, így gyorsan beazonosítható.

● A Beta kipróbált pengéi egyedi rugalmasságot, keménységet és kopásállóságot biztosítanak a felső kategóriás professzionális szerszámoknak.

● Az ergonomikus markolat tökéletesen illeszkedik a kézbe. A nagy érintkezési felületnek köszönhetően kis erőfeszítéssel is nagy erőátvitel érhető el.

● A nyolcszögű szakasz megakadályozza az elgurulást.

● Az új, hőkezelt gumi még az intenzív munkáknál is kényelmes fogást biztosít.

● A markolaton elhelyezett lyuknál felakasztva a csavarhúzó könnyebben tárolható.



● A fej típusa és mérete a kerek markolatvégre van nyomtatva, így gyorsan beazonosítható.

● A precíziósan kialakított fejnél fogva a csavarhúzó az ujjak között is gyorsan forgatható.



1201E

csavarhúzó hasítottfejű csavarokhoz



ISO 2380

SxAxL mm	L1 mm	Ø mm	Ft	U	IT
0,4x2,5x50	146	2,5	1.480	5	012011003
0,4x2,5x75	166	2,5	1.620	5	012011006
0,5x3x75	171	3,0	1.630	5	012011009
0,5x3x100	196	3,0	1.680	5	012011012
0,6x3,5x75	171	3,5	1.660	5	012011018
0,6x3,5x100	196	3,5	1.700	5	012011021
0,8x4x100	196	4,0	1.710	5	012011030
0,8x4x125	221	4,0	1.710	5	012011033
0,8x4x150	246	4,0	1.830	5	012011036
1,0x5,5x100	209	5,0	2.030	5	012011039
1,0x5,5x125	234	5,0	2.100	5	012011040
1,0x5,5x150	259	5,0	2.190	5	012011042
1,2x6,5x100	220	6,0	2.360	5	012011048
1,2x6,5x125	234	6,0	2.450	5	012011050
1,2x6,5x150	270	6,0	2.520	5	012011051
1,2x8x150	282	8,0	3.350	3	012011057
1,2x8x200	332	8,0	3.570	3	012011060
1,6x10x200	332	9,5	3.990	3	012011066



1201E/S6	Ft	U	IT
0,5x3x75-0,6x3,5x100 0,8x4x100-1,0x5,5x100 1,2x8x150-1,6x10x200 mm	14.400	1	012011206

1201EN

csavarhúzó hasítottfejű csavarokhoz, extra rövid



ISO 2380

SxAxL mm	L1 mm	Ø mm	Ft	U	IT
0,8x4x30	86,5	4	2.250	3	012011103
1,2x6,5x30	86,5	6	2.390	3	012011106

1201E/DZ

csavarhúzó Dzus® fejű csavarokhoz



L mm	L1 mm	Ft	U	IT
53	173	5.430	2	012011501

1202E

csavarhúzó keresztfejű Phillips® csavarokhoz



UNI-ISO 8764

PHxDxL mm	L1 mm	Ft		
0x3x60	156	1.480	5	012021003
0x3x100	200	1.680	5	012021006
1x4,5x80	189	1.960	5	012021009
1x4,5x120	229	2.150	5	012021012
2x6x100	220	2.360	5	012021018
2x6x150	270	2.560	5	012021021
3x8x150	282	3.480	3	012021024
4x9,5x200	332	4.120	3	012021027



	Ft		
1202E/S4 PH0x3x60-PH1x4,5x120 PH2x6x150-PH3x8x150 mm	9.670	1	012021204

1202EN

csavarhúzó keresztfejű Phillips® csavarokhoz, extra rövid



UNI-ISO 8764

PHxDxL mm	L1 mm	Ft		
1x4,5x30	86,5	2.250	3	012021103
2x6x30	86,5	2.390	3	012021106

1202EL

hosszú csavarhúzó keresztfejű Phillips® csavarokhoz



UNI-ISO 8764-1

PHxDxL mm	L1 mm	Ft		
0x3x300	400	2.800	3	012021303
1x4,5x300	400	3.030	3	012021305
1x4,5x400	508	3.670	3	012021306
2x6x400	519	4.250	3	012021309

1203E/D

csavarhúzó készlet



	Ft		
1203E/D5 1201E 0,6x3,5x100-1,0x5,5x150 1,2x6,5x150 mm 1202E PH1x4,5x80-PH2x6x100 mm	10.750	1	012031001

	Ft		
1203E/D5PZ 1201E 0,5x3x75-0,8x4x125 1,0x5,5x150 mm 1209E/PZ PZ1x4,5x80-PZ2x6x100 mm	10.100	1	012031003

	Ft		
1203E/D6 1202E PH1x4,5x80-PH2x6x100 mm 1204E 0,4x2,5x60-0,5x3x100 0,8x4x100-1,0x5x125 mm	11.450	1	012031006

	Ft		
1203E/D7 1201E 0,5x3x75-0,8x4x100 1,0x5,5x100-1,2x6,5x150 mm 1202E PH0x3x60-PH1x4,5x80 PH2x6x100 mm	13.700	1	012031007

	Ft		
1203E/D8 1201E 0,5x3x75-0,8x4x125 1,0x5,5x150-1,2x6,5x150 mm 1202E PH0x3x60-PH1x4,5x80 PH2x6x100-PH3x8x150 mm	17.350	1	012031008

	Ft		
1203E/D8P 1201E 2,5x50-3x75-4x100-5,5x100- 6,5x150 mm 1202E PH0x60-PH1x80-PH2x100 mm	15.150	1	012031018

	Ft		
1203E/D10 1201E 0,4x2,5x50-0,5x3x75 0,8x4x100-1,0x5,5x100 1,2x6,5x150-1,2x8x150 mm 1202E PH0x3x60-PH1x4,5x80 PH2x6x100-PH3x8x150 mm	22.000	1	012031010

	Ft		
1203E/D10N 1201E 0,4x2,5x50-0,5x3x75-0,8x4x100- 1,0x5,5x150-1,2x6,5x150 mm 1201EN 0,8x4x30 mm 1202E PH0x3x60-PH1x4,5x80- PH2x6x100 mm 1202EN PH1x4,5x30 mm	19.850	1	012031019

Beta
Quality Tools



1203E/S



	Ft		
1203E/S8 1201E 2,5x50-3x75-4x100-5,5x125- 6,5x150 mm 1202E PH0x3x60-PH1x4,5x80- PH2x6x100 mm	15.250	1	012031009

	Ft		
1203E/S10 1201E 0,4x2,5x50-0,5x3x75 0,8x4x125-1,0x5,5x150 1,2x6,5x150-1,2x8x150 mm 1202E PH0x3x60-PH1x4,5x80 PH2x6x100-PH3x8x150 mm	22.150	1	012031021

1204E

csavarhúzó hernyócsavarokhoz



ISO 2380

SxDxL mm	L1 mm	Ft		
0,4x2,5x60	156	1.560	5	012041003
0,6x3x75	175	1.600	5	012041006
0,5x3x100	196	1.670	5	012041009
0,8x4x100	196	1.710	5	012041012
0,8x4x125	233	1.870	5	012041015
1x5x125	234	2.200	5	012041018
1x5x150	258	2.480	5	012041021
1,2x6,5x150	270	2.770	5	012041024



	Ft		
1204E/S5 0,4x2,5x60-0,5x3x100 0,8x4x100-1x5x125 1,2x6,5x150 mm	9.910	1	012041205

1204EL

hosszú csavarhúzó hernyócsavarokhoz

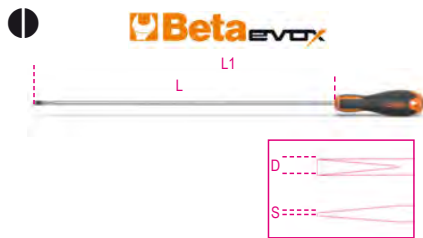

ISO 2380

SxDxL mm	L1 mm	Ft	cs	gép
0,5x2,5x200	300	2.280	3	012041303
0,5x3x300	400	2.680	3	012041306
0,8x4x400	508	3.350	3	012041309
1x5x400	508	3.590	3	012041315
1,2x6,5x400	519	4.550	3	012041318

1205E/ES

hatlapú imbusz csavarhúzó



mm	L mm	L1 mm	Ft	cs	gép
1,5	100	200	1.900	3	012051315
2	100	200	1.960	3	012051320
2,5	100	200	1.990	3	012051325
3	100	200	2.020	3	012051330
4	100	208	2.350	3	012051340
5	100	219	2.860	3	012051350
6	125	244	2.950	3	012051360
8	150	277	3.940	2	012051380



1205E/ES-S8	Ft	cs	gép
1,5-2-2,5-3-4-5-6-8 mm	19.950	1	012051408

1206E/BP

gömbfejű hatlapú csavarhúzó



mm	L mm	L1 mm	Ø mm	Ft	cs	gép
2	100	198	2,5	2.030	3	012061320
2,5	100	198	3,0	2.070	3	012061325
3	100	198	3,5	2.160	3	012061330
4	100	209	5,0	2.550	3	012061340
5	100	220	6,0	3.030	3	012061350
6	125	245	7,0	3.170	3	012061360
8	150	287	9,5	4.210	2	012061380



1206E/BP-S7	Ft	cs	gép
2-2,5-3-4-5-6-8 mm	19.200	1	012061407

1207E/TX

imbusz-csavarhúzó
Torx®-csavarokhoz



	L mm	L1 mm	Ø mm	Ft	cs	gép
T5	50	150	3	1.700	5	012071005
T6	60	156	4	1.700	5	012071006
T7	60	156	4	1.740	5	012071007
T8	60	156	4	1.790	5	012071008
T9	60	156	4	1.850	5	012071009
T10	80	189	5	2.270	5	012071010
T15	80	189	5	2.300	5	012071015
T20	100	209	5	2.360	5	012071020
T25	100	209	5	2.390	5	012071025
T27	100	220	6	2.620	5	012071027
T30	100	220	6	2.670	5	012071030
T40	130	262	7	3.670	2	012071040
T45	130	262	8	3.750	2	012071045



1207E/TX-D7	Ft	cs	gép
T6-T8-T10-T15 T20-T25-T30	15.500	1	012071207
1207E/TX-D13	Ft	cs	gép
T5-T6-T7-T8-T9-T10-T15 T20-T25-T27-T30-T40-T45	30.800	1	012071213

1208E/RTX

csavarhúzó a Tamper Resistant Torx®-csavarokhoz



	L mm	L1 mm	Ø mm	Ft	cs	gép
T9	60	156	4	1.840	5	012081009
T10	80	189	5	2.340	5	012081010
T15	80	189	5	2.390	5	012081015
T20	100	209	5	2.450	5	012081020
T25	100	209	5	2.480	5	012081025
T27	100	220	6	2.760	5	012081027
T30	100	220	6	2.800	5	012081030
T40	130	262	7	3.790	2	012081040

Beta EVOLX



1208E/RTX-D7	Ft	cs	gép
T9-T10-T15-T20 T25-T27-T30	17.050	1	012081207

1209E/PZ

csavarhúzó keresztfejű
Pozidriv®-Supadriv® csavarokhoz

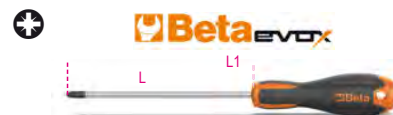

UNI-ISO 8764

PZ	L mm	L1 mm	Ft	cs	gép
0	60	156	1.550	5	012091000
1	80	189	2.070	5	012091003
2	100	220	2.510	5	012091006
3	150	282	3.690	3	012091009
4	200	327	4.250	3	012091012



1209E/PZ-S4	Ft	cs	gép
PZ0-PZ1-PZ2-PZ3	9.820	1	012091204

1209EN/PZ

csavarhúzó keresztfejű Pozidriv®-Supadriv®
csavarokhoz,
extra rövid



ISO 8764

PZ	L mm	L1 mm	Ft	cs	gép
1	30	87	2.250	3	012091103
2	30	87	2.390	3	012091106



1229LP

Műszerész csavarhúzó hasítottfejű csavarhoz, nikkelezett, barnított

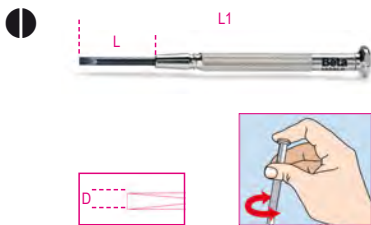

D mm	L mm	L1 mm	Ft		
1,0	17	75	1.390	5	012290210
1,2	21	85	1.390	5	012290212
1,4	21	89	1.390	5	012290214
1,8	23	94	1.390	5	012290218
2,0	23	98	1.390	5	012290220
2,4	26	103	1.390	5	012290224
3,0	28	108	1.670	5	012290230



1229LP/A6	Ft		
1,2-1,4-1,8-2-2,4-3 mm	8.460	1	012290300

1229PH

Phillips® műszerész csavarhúzó, nikkelezett, barnított

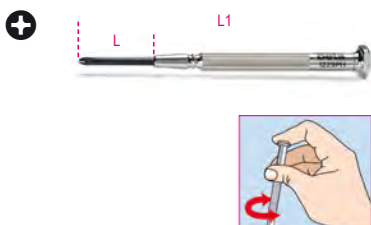

PH	L mm	L1 mm	Ft		
0	26	102	1.550	5	012290250
1	29	107	1.650	5	012290251

1229LPH/A6

6 műszerész csavarhúzó, műanyag dobozban

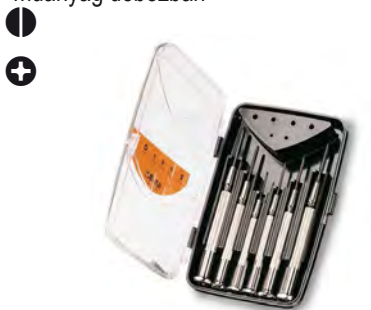

1229LPH/A6	Ft		
1229LP 1,4-2,0-2,4-3 mm	8.460	1	012290310
1229PH PH0-PH1			

1236B

Sarokcsavarhúzó hasítottfejű csavarokhoz

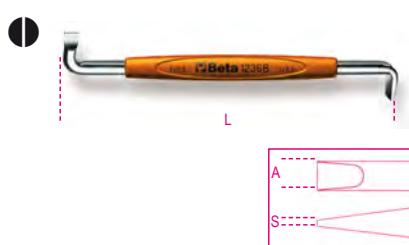

UNI 7079 DIN 5200

SxA mm	L mm	Ft		
0,8x4	100	2.460	5	012360201
1x5,5	125	2.900	5	012360202
1,2x8	150	3.530	5	012360204

1238B

Sarokcsavarhúzó Phillips®-csavarokhoz



UNI 7083 DIN 5208

PH	L mm	Ft		
1-2	125	2.880	5	012380201
3-4	200	4.850	5	012380203

1241

Üthető acélfejű csavarhúzó hasítottfejű csavarokhoz

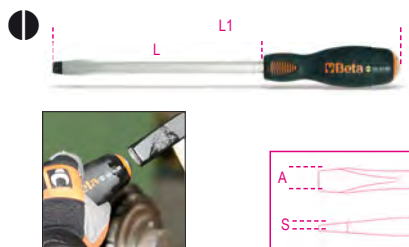

ISO 2380

SxAxL mm	L1 mm	Ft		
1x5,5x100	202	3.750	5	012410039
1,2x6,5x125	240	4.180	5	012410050
1,2x8x150	268	5.130	3	012410057
1,6x10x175	300	6.400	2	012410065
1,6x10x200	325	6.500	2	012410066
2,0x12x200	325	7.150	2	012410067
2,5x14x250	375	8.000	2	012410076

1242

Üthető acélfejű csavarhúzó Phillips® csavarokhoz



UNI/ISO 8764

PHxDxL mm	L1 mm	Ft		
1x4,5x100	202	3.660	5	012420209
2x6x100	215	4.330	5	012420218
3x8x150	268	5.650	3	012420221
4x11x200	325	7.290	2	012420224

1243LP/D6

6 darabos acélfejű csavarhúzó készlet hasítottfejű csavarokhoz



1243LP/D6	Ft		
1241 1x5,5x100-1,2x6,5x125-3x8x150-1,6x10x175-2,0x12x200-2,5x14x250 mm	34.600	1	012430016

1243/D7

7 darabos üthető csavarhúzó készlet



1243/D7	Ft		
1241 1x5,5x100-1,2x6,5x125-1,2x8x150-1,6x10x200 mm	33.200	1	012430017
1242 PH1x4,5x100-PH2x6x100-PH3x8x150 mm			



1243/S11

11 darabos acélfejú csavarhúzó készlet



1243/S11 Ft 62.050 1 012430021

1241	1x5,5x100-1,2x6,5x125-3x8x150-1,6x10x175-1,6x10x200-2,0x12x200-2,5x14x250 mm
1242	PH1x4,5x100-PH2x6x100-PH3x8x150-PH4x11x200 mm

1250

Csavartartó csavarhúzó

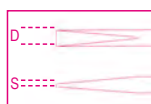

SxDxL mm	L1 mm	Ft	5	1
0,5x3x125	190	5.410	5	012500030
0,6x4x125	225	5.860	5	012500040
0,7x5x150	255	6.930	5	012500050

1251

Phillips® csavartartó csavarhúzó



PHxDxL mm	L1 mm	Ft	5	1
0x4x125	225	6.080	5	012510000
1x5x125	225	7.150	5	012510010
2x6x175	280	8.170	5	012510020

1252/S5



1252/S5 Ft 33.500 1 012520001

1250	0,5x3x125-0,6x4x125-0,7x5x150 mm
1251	PH1x5x150-PH2x6x175 mm

1253

Fáziskereső csavarhúzó - 150/250V

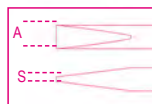

SxAxL mm	L1 mm	Ft	5	1
0,5x3,5x100	190	3.240	5	012530001

1253A

Fáziskereső csavarhúzó - 125/250V, dupla szigeteléssel



SxAxL mm	L1 mm	Ft	5	1
0,5x3x15	150	2.340	5	012530010

1254

Próbalámpa 6-24 V

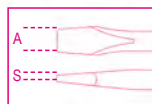

SxAxL mm	L1 mm	Ft	5	1
0,5x3x44	123	3.460	5	012540001

1256/C36-2

Műszerész csavarhúzó 36 cserélhető 4 mm-es bit-tel és mágneses hosszabbítóval



1256/C36-2 Ft 23.350 1 012560100

	1256TX	T3 - T4 - T5 - T6 - T7 T8 - T9 - T10 - T15
	1256RTX	T6 - T7 - T8 - T9 - T10
	1256LP	0,8 - 1,2 - 1,5 - 1,8 - 2 - 2,5 3 - 3,5 - 4 mm
	1256PE	0,7 - 0,9 - 1,3 - 1,5 - 2 mm
	1256PH	PH000 - PH00 - PH0 - PH1
	1256PZ	PZ000 - PZ00 - PZ0 - PZ1
	1256/20	
	1256/30	

130x60x35 mm - 200 g

1256LP

Csavarhúzóbetét 4 mm hasítottfejú csavarokhoz



SxA mm	L mm	Ft	5	1
0.25x0.8	27	440	5	012560001
0.25x1.2	27	440	5	012560002
0.3x1.5	27	440	5	012560003
0.35x1.8	27	440	5	012560004
0.4x2.0	27	440	5	012560005
0.4x2.5	27	440	5	012560006
0.5x3.0	27	440	5	012560007
0.6x3.5	27	440	5	012560008
0.8x4.0	27	440	5	012560009

1256PH

Csavarhúzóbetét 4 mm Phillips®-csavarokhoz



PH	L mm	Ft	5	1
000	27	440	5	012560011
00	27	440	5	012560012
0	27	440	5	012560013
1	27	440	5	012560014

1256PZ

4 mm betét Pozidriv® - Supradriv® illesztésű csavarokhoz



PZ	L mm	Ft	5	1
000	27	440	5	012560061
00	27	440	5	012560062
0	27	440	5	012560063
1	27	440	5	012560064

1256PE



Csavarhúzóbetét 4 mm hatszögű csavarokhoz



mm	L mm	Ft	5	1
0.7	27	440	5	012560021
0.9	27	440	5	012560022
1.3	27	440	5	012560023
1.5	27	440	5	012560024
2.0	27	440	5	012560025

1256TX



Csavarhúzóbetét 4 mm
Torx®-csavarokhoz

Ø	L mm	Ft	📦	📄
T3	27	460	5	012560041
T4	27	460	5	012560042
T5	27	460	5	012560043
T6	27	460	5	012560044
T7	27	460	5	012560045
T8	27	460	5	012560046
T9	27	460	5	012560047
T10	27	460	5	012560048
T15	27	460	5	012560049

1256RTX

Csavarhúzóbetét 4 mm
Tamper Resistant Torx®-csavarokhoz

Ø	L mm	Ft	📦	📄
T6	27	545	5	012560051
T7	27	545	5	012560052
T8	27	545	5	012560053
T9	27	545	5	012560054
T10	27	545	5	012560055

1256/20

Toldó, belső- és külső hatszög 4 mm



	Ft	📦	📄
1256/20	2.740	5	012560092

1256/30



Betéttartó nyéllel 4 mm



L mm	Ft	📦	📄
110	3.280	2	012560097

1257LP

Műszerész csavarhúzó hasítottfejű csavarhoz

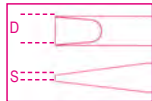
SxD mm	L mm	Ft	📦	📄
0,25x1,2	60	1.740	5	012570012
0,23x1,5	60	1.740	5	012570015
0,3x1,8	60	1.740	5	012570018
0,4x2	60	1.740	5	012570020
0,4x2,5	60	1.740	5	012570024
0,5x3	60	1.740	5	012570030
0,6x3,5	60	1.740	5	012570035
0,8x4	60	1.740	5	012570040





1257LP/S8	Ft	📦	📄
1257LP/S8	20.900	1	012570200

0,2x1,2-0,25x1,5
0,3x1,8-0,4x2-0,4x2,5
0,5x3-0,6x3,5-0,8x4 mm

1257PH

Phillips(R) műszerész csavarhúzó

PH	L mm	Ft	📦	📄
00	60	1.740	5	012570060
0	60	1.740	5	012570063
1	60	1.740	5	012570066

1257LPH/S8





1257LPH/S8	Ft	📦	📄
1257LPH/S8	20.900	1	012570210

1257PH PH00-PH0-PH1
1257LP 0,4x2-0,4x2,5-0,5x3
0,6x3,5-0,8x4 mm

1257ES

Műszerész csavarhúzó - hatszögű

mm	L mm	Ft	📦	📄
0,9	60	1.930	5	012570045
1,3	60	1.930	5	012570046
1,5	60	1.930	5	012570047
2	60	1.930	5	012570048
2,5	60	1.930	5	012570049
3	60	1.930	5	012570050

1257ESB/S8



1257ESB/S8	Ft	📦	📄
1257ESB/S8	23.650	1	012570230

1257ES 0,9-1,3-1,5-2-2,5-3 mm
1257BE 4-5 mm

1257TX

Torx® műszerész csavarhúzó



Ø	L mm	Ft	📦	📄
T5	60	2.000	5	012570075
T6	60	2.000	5	012570076
T7	60	2.000	5	012570077
T8	60	2.000	5	012570078
T9	60	2.000	5	012570079
T10	60	2.000	5	012570080
T15	60	2.000	5	012570081
T20	60	2.000	5	012570082



1257TX/S8	Ft	📦	📄
1257TX/S8	23.000	1	012570220

T5-T6-T7-T8
T9-T10-T15-T20

1257BE

Műszerész csavarhúzó - hatszögű



Ø mm	L mm	Ft	📦	📄
3,2	60	2.540	5	012570085
4	60	2.540	5	012570086
5	60	2.540	5	012570087
5,5	60	2.540	5	012570088

A BetaGrip csavarhúzócsalád a Beta sok éves tapasztalatának és a motorsport csapatokkal való szoros együttműködésének gyümölcse.

A legigényesebb szakembereket is kielégítő új, egyedi műszaki megoldások kialakítása során a kiemelkedő ergonómiát, szilárdságot és anyagminőséget tartottuk szem előtt.

- A csavarhúzó éle speciális, magas szilícium, króm és vanádium tartalmú acélból készült, ami jobb csavaró- és hajlítoszilárdságot biztosít. Nem csillogó, matt krómozást kapott.
- A csavarhúzó fej formáját úgy tervezték, hogy az éle tökéletesen illeszkedjen a csavarfejbe. A foszfátzott kivitel megakadályozza a fej oxidálódását és biztosítja a profil pontosságát.
- A markolat textúráját a versenygumik futófelülete ihlette, mely minden felületen maximális tapadást biztosít. A csavarhúzó így minden munkakörülmény között hatékony fogást biztosít, amikor a fejet a csavarra illesztjük.



1260

Csavarhúzó hasítottfejű csavarokhoz



ISO 2380

SxAxL mm	L1 mm	Ø mm	Ft		
0,4x2,5x50	150	2,5	1.850	5	012600003
0,4x2,5x75	175	2,5	1.890	5	012600006
0,5x3x75	175	3,0	1.920	5	012600009
0,5x3x100	200	3,0	1.980	5	012600012
0,6x3,5x75	175	3,5	2.060	5	012600018
0,6x3,5x100	200	3,5	2.100	5	012600021
0,8x4x100	208	4,0	2.260	5	012600030
0,8x4x125	233	4,0	2.340	5	012600033
0,8x4x150	258	4,0	2.420	5	012600036
1x5,5x100	208	5,0	2.590	5	012600039
1x5,5x125	233	5,0	2.620	5	012600040
1x5,5x150	258	5,0	2.890	5	012600042
1,2x6,5x100	219	6,0	3.150	5	012600048
1,2x6,5x125	244	6,0	3.250	5	012600050
1,2x6,5x150	269	6,0	3.380	5	012600051
1,2x8x150	277	8,0	4.150	3	012600057
1,2x8x200	327	8,0	4.300	3	012600060
1,6x10x200	327	9,5	5.270	3	012600066
2x12x250	377	10	6.200	3	012600069
2x14x250	377	10	6.530	2	012600073



	Ft		
1260/S6 0,4x2,5x75-0,5x3x75-0,8x4x125 1x5,5x150-1,2x6,5x150-1,2x8x200 mm	16.700	1	012600306

1260N

Csavarhúzó hasítottfejű csavarokhoz, extra rövid penge



ISO 2380

SxAxL mm	L1 mm	Ø mm	Ft		
0,8x4x30	87	4	2.410	5	012600103
1,2x6,5x30	87	6	2.620	5	012600106

1260E

Csavarhúzó hasítottfejú csavarokhoz, hatszögű penge



ISO 2380

SxAxL mm	L1 mm	Ø mm	Ft		
1,2x6,5x150	269	6,0	4.480	3	012600156
1,2x8x175	301	8,0	5.480	3	012600157
1,6x10x200	327	9,5	6.450	2	012600159
2x12x250	377	9,5	7.430	2	012600162

1260MC

csavarhúzó hasítottfejú csavarokhoz, színezett



SxAxL mm	L1 mm	Ø mm	Ft		
0,4x2,5x50	150	2,5	1.910	3	012602003
0,6x3,5x75	175	3,5	2.120	3	012602018
0,8x4x100	208	4,0	2.400	3	012602030
1x5,5x125	233	5,0	3.040	5	012602040
1,2x6,5x150	269	6,0	3.380	5	012602051

1262

Phillips®-csavarhúzó



UNI/ISO 8764

PHxDxL mm	L1 mm	Ft		
0x3x60	160	1.910	5	012620003
0x3x100	200	2.060	5	012620006
1x4,5x80	188	2.590	5	012620009
1x4,5x120	228	2.770	5	012620012
2x6x100	219	3.160	5	012620018
2x6x150	269	3.480	5	012620021
3x8x150	277	4.690	3	012620024
4x10x200	327	5.920	3	012620027



1262/S4	Ft		
PH0x3x60-PH1x4,5x80 PH2x6x100-PH3x8x150 mm	12.350	1	012620304

1262N

Phillips®-csavarhúzó, extra rövid penge



UNI/ISO 8764

PHxDxL mm	L1 mm	Ft		
1x4,5x30	87	2.410	5	012620103
2x6x30	87	2.670	5	012620106

1262E

Phillips®-csavarhúzó, hatszögű penge



UNI/ISO 8764

PHxDxL mm	L1 mm	Ft		
2x6x150	269	4.420	3	012620153
3x8x175	302	5.440	3	012620156
4x10x200	327	6.490	2	012620159

1262L

Phillips®-csavarhúzó, hosszú penge



UNI/ISO 8764-1

PHxDxL mm	L1 mm	Ft		
0x3x300	400	3.460	3	012620203
1x4,5x300	400	3.980	3	012620205
1x4,5x400	508	4.770	3	012620206
2x6x400	519	6.180	3	012620209

1262MC

csavarhúzó keresztfejú Phillips® csavarokhoz, színezett



PHxDxL mm	L1 mm	Ft		
0x3x60	160	2.050	3	012622003
1x4,5x80	188	2.670	3	012622009
2x6x100	219	3.320	3	012622018

1263/D...

Csavarhúzókészlet



1263/D6	Ft		
1260	15.950	1	012630006
1262			

0,5x3x75-0,8x4x100
1x5,5x125-1,2x6,5x150 mm
PH1x4,5x80-PH2x6x100 mm



1263/D7	Ft		
1262	16.550	1	012630017

PH0x3x60
PH1x4,5x80
PH2x6x100 mm
0,5x2,5x60-0,6x3x100
0,8x4x125-1x5x125 mm



1263/D7PZ	Ft		
1260	19.050	1	012630007

0,5x3x75-0,8x4x100
1x5,5x150-1,2x6,5x150 mm
PZ0 - PZ1 - PZZ



1263/D8	Ft		
1260	19.700	1	012630008

0,4x2,5x50-0,5x3x75
0,8x4x100-1x5,5x125
1,2x6,5x150 mm
PH0x3x60-PH1x4,5x80
PH2x6x100 mm



1263/D10	Ft		
1260	25.100	1	012630010

0,5x3x75-0,6x3,5x100
0,8x4x125-1x5,5x150
1,2x6,5x150 mm
0,8x4x30
PH0x3x60-PH1x4,5x80
PH2x6x100 mm
PH1x4,5x30

1263/S12

12 darabos csavarhúzókészlet



1263/S12 Ft 36.150 1 012630112

1260	0,4x2,5x50-0,5x3x75 0,6x3,5x100-0,8x4x125 1x5,5x125-1,2x6,5x150 1,2x8x200-1,6x10x200 mm
1262	PH0x3x60-PH1x4,5x80 PH2x6x100-PH3x8x150 mm

1263MC/D8

8 darabos színes csavarhúzókészlet



1263MC/D8 Ft 20.900 1 012632008

1260MC	0,4x2,5x50-0,5x3x75 0,8x4x100-1x5,5x125 1,2x6,5x150 mm
1262MC	PH0x3x60-PH1x4,5x80 PH2x6x100 mm

1264

Csavarhúzó hernyócsavarokhoz

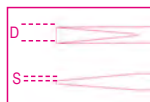

SxDxL mm	L1 mm	Ft	Icons
0,5x2,5x60	160	1.870	5 012640003
0,6x3x75	175	1.940	5 012640006
0,6x3x100	200	2.000	5 012640009
0,8x4x100	208	2.340	5 012640012
0,8x4x125	233	2.390	5 012640015
1x5x125	233	2.610	5 012640018
1x5x150	258	2.860	5 012640021
1,2x6,5x150	269	3.380	5 012640024



1264/S5 Ft 12.150 1 012640305
0,5x2,5x60-0,6x3x75
0,8x4x100-1x5x125-1,2x6,5x150 mm

1264L

Csavarhúzó hernyócsavarokhoz, hosszú penge



SxDxL mm	L1 mm	Ft	Icons
0,5x2,5x200	300	2.780	3 012640203
0,6x3x300	400	3.200	3 012640206
0,8x4x400	508	4.190	3 012640209
1x5x400	508	4.730	3 012640215
1,2x6,5x400	519	5.670	3 012640218

1265ES

Hatlapú imbusz csavarhúzó



mm	L mm	L1 mm	Ft	Icons
1,5	100	200	2.260	3 012650015
2	100	200	2.320	3 012650020
2,5	100	200	2.410	3 012650025
3	100	200	2.540	3 012650030
4	100	208	2.770	3 012650040
5	100	219	3.240	3 012650050
6	125	244	3.670	3 012650060
8	150	277	4.780	2 012650080



1265ES/S8 Ft 24.000 1 012650308
1,5-2-2,5-3-4-5-6-8 mm

1266BP

Hatlapú gömbfejű imbusz csavarhúzó



mm	L mm	L1 mm	Ft	Icons
2	100	200	2.510	3 012660020
2,5	100	200	2.610	3 012660025
3	125	225	2.730	3 012660030
4	125	233	3.000	3 012660040
5	120	239	3.480	3 012660050
6	140	259	3.940	3 012660060
8	160	287	5.080	2 012660080
10	160	287	5.910	2 012660100



1266BP/S8 Ft 29.250 1 012660308
2-2,5-3-4-5-6-8-10 mm

1267TX

Imbusz csavarhúzó Torx®-csavarokhoz



Ø	L mm	L1 mm	Ø mm	Ft	Icons
T5	50	150	3	2.800	5 012670005
T6	50	150	3	2.910	5 012670006
T7	50	150	3	3.000	5 012670007
T8	60	160	3	3.120	5 012670008
T9	60	167	4	3.290	5 012670009
T10	80	188	4	3.430	5 012670010
T15	80	188	4	3.640	5 012670015
T20	100	208	4,5	3.800	5 012670020
T25	100	208	5	4.040	5 012670025
T27	115	234	6	4.230	5 012670027
T30	115	234	6	4.390	5 012670030
T40	130	257	7	5.020	2 012670040
T45	130	257	8	5.460	2 012670045



1267TX/D7
T6-T8-T10-T15
T20-T25-T30

Ft 25.350
1 012670307



1267TX/S13
T5-T6-T7-T8-T9
T10-T15-T20-T25
T27-T30-T40-T45

Ft 49.150
1 012670312

1267MC/TX

imbusz csavarhúzó Torx® csavarokhoz,
nyéllel, színes



	L mm	L1 mm	Ø mm	Ft	📦	📄
T6	50	150	3	3.020	5	012672006
T8	60	160	3	3.110	5	012672008
T10	80	188	4	3.630	5	012672010
T15	80	188	4	3.730	5	012672015
T20	100	208	4,5	3.940	5	012672020
T25	100	208	5	4.040	3	012672025
T30	115	234	6	4.780	3	012672030



1267MC/TX-D7
T6-T8-T10-T15
T20-T25-T30

Ft 26.250
1 012672307

1268RTX

Imbusz csavarhúzó Tamper Resistant Torx®
csavarokhoz



	L mm	L1 mm	Ø mm	Ft	📦	📄
T9	60	167	4,0	3.560	3	012680009
T10	80	188	4,0	3.690	3	012680010
T15	80	188	4,0	3.800	3	012680015
T20	100	208	4,5	4.030	3	012680020
T25	100	208	5,0	4.180	3	012680025
T27	115	234	6,0	4.490	3	012680027
T30	115	234	6,0	4.610	3	012680030
T40	130	257	7,0	5.170	2	012680040



1268RTX/S8
T9-T10-T15-T20
T25-T27-T30-T40

Ft 33.550
1 012680307

1269PZ

Csavarhúzó Pozidriv® és Supadriv®
csavarokhoz



UNI/ISO 8764

PZ	L mm	L1 mm	Ft	📦	📄
0	60	160	2.220	5	012690000
1	80	188	2.860	5	012690001
2	100	219	3.520	5	012690002
3	150	277	4.990	3	012690003
4	200	327	6.380	3	012690004



1269PZ/S4
PZ0-PZ1-PZ2-PZ3

Ft 13.600
1 012690304

1269N/PZ

Csavarhúzó Pozidriv® és Supadriv®-
csavarokhoz, extra rövid penge



UNI/ISO 8764

PZ	L mm	L1 mm	Ft	📦	📄
1	30	87	2.340	5	012690011
2	30	87	2.640	5	012690012

1281BG

Csavarhúzónyél cserélhető szárakhoz



L mm	Ø mm	Ft	📦	📄
118	10	4.160	5	012810280

1281PM

Mágneses betéttartó szár



L mm	Ft	📦	📄
165	7.210	5	012810292

1281PB

Dugókulcstartó szár 1/4"



L mm	Ft	📦	📄
175	5.710	5	012810293

1281LP

Cserélhető csavarhúzószár hasítottfejú
csavarokhoz



	Ft	📦	📄
1281LP/1 0,8x4-1,2x6,5 mm	3.550	5	012810302
1281LP/2 1x5,5-1,2x6,5 mm	3.550	5	012810304

1281PH

Cserélhető csavarhúzószár Phillips®-csavarokhoz



PH	Ft	5	012810310
1-2	3.550		
2-3	3.550		012810312

1281LPH

Cserélhető csavarhúzószár hasítottfejű és Phillips®-csavarokhoz



	Ft	5	012810321
1281LPH/1 PH0-0,8x4 mm	3.550		
1281LPH/2 PH1-1x5,5 mm	3.550		012810322
1281LPH/3 PH2-1,2x6,5 mm	3.550		012810323

1281PZ

Cserélhető csavarhúzószár Pozidriv®- és Supadriv®-csavarokhoz



PZ	Ft	5	012810330
1-2	3.550		
2-3	3.550		012810332

1281PE

Cserélhető csavarhúzószár gömbölyű fejfel



mm	Ft	5	012810342
2,5	3.550		
3	3.550		012810343
4	3.550		012810344
5	3.550		012810345
6	3.550		012810346

1281TX

Cserélhető csavarhúzószár Torx®-csavarokhoz



	Ft	5	012810349
1281TX/1 T6-T8	3.810		
1281TX/2 T7-T9	3.810		012810350
1281TX/3 T10-T15	3.810		012810351
1281TX/4 T20-T25	3.810		012810352
1281TX/5 T30-T40	3.810		012810353

1281RTX

Cserélhető csavarhúzószár Tamper Resistant Torx®-csavarokhoz



	Ft	5	012810361
1281RTX/3 T10-T15	3.950		
1281RTX/4 T20-T25	3.950		012810362
1281RTX/5 T30-T40	3.980		012810363

1281BG/A9

9 darabos csavarhúzószár készlet 1 csavarhúzónyél, tokban



1281BG/A9	Ft	1	012810520
	41.200		

1281BG	
1281LPH/1	PH0-0,8x4 mm
1281LPH/2	PH1-1x5,5 mm
1281LPH/3	PH2-1,2x6,5 mm
1281PZ/1	PZ1-PZ2
1281PE	2,5 mm
1281PE	3 mm
1281PE	4 mm
1281PE	5 mm
1281PE	6 mm

1281BG-TX/A8

8 darabos csavarhúzószár készlet 1 csavarhúzónyél, tokban



1281BG-TX/A8	Ft	1	012810530
	38.950		

1281BG	
1281LPH/1	PH0-0,8x4 mm
1281LPH/2	PH1-1x5,5 mm
1281LPH/3	PH2-1,2x6,5 mm
1281TX/1	T6-T8
1281TX/2	T7-T9
1281TX/3	T10-T15
1281TX/4	T20-T25
1281TX/5	T30-T40

1281BG/B28NA

16 megfordítható csavarhúzószár, 9 dugókulcs 1/4", 2 tartozék és 1 csavarhúzónyél, műanyag tasakban



1281BG/B28NA	Ft	1	012810511
	92.650		

900	4 - 4,5 - 5 - 5,5 6 - 7 - 8 - 9 - 10 mm
1281BG	
1281PB	■ 1/4
900/25	
1281LP/1	0,8x4 - 1,2x6,5 mm
1281LP/2	1,0x5,5 - 1,2x6,5 mm
1281PH/1	PH1 - PH2
1281PH/2	PH2 - PH3
1281PZ/1	PZ1 - PZ2
1281PZ/2	PZ2 - PZ3
1281PE	2,5 - 3 - 4 - 5 - 6 mm
1281TX/1	T6 - T8
1281TX/2	T7 - T9
1281RTX/3	T10 - T15
1281RTX/4	T20 - T25
1281RTX/5	T30 - T40

2002/BV7-ZIP	Ft	1	020020060
	8.170		



A BetaMax csavarhúzókat számos jellemzőjét úgy alakítottuk, hogy a munka még könnyebb legyen.

- A markolatot a háromszögletű rész ihlette, ami a csukló maximális elfordulásának megfelelően 120°-ban optimális csavarozást tesz lehetővé.
- A kialakítás gyorscsavarozás és megszorítás esetén is kiemelkedően ergonomikus tulajdonságokkal bír.
- A krómozatlan fej tökéletes illeszkedést biztosít a csavarra, a foszfátréteg pedig megvédi az oxidációtól.

1290

Phillips®-csavarhúzó



ISO 2380

SxAxL mm	L1 mm	Ø mm	Ft		
0,4x2,5x50	146	2,5	2.300	5	012900003
0,4x2,5x75	171	2,5	2.360	5	012900006
0,5x3x75	171	3,0	2.400	10	012900009
0,5x3x100	196	3,0	2.540	10	012900012
0,6x3,5x75	171	3,5	2.740	10	012900018
0,6x3,5x100	196	3,5	2.830	10	012900021
0,8x4x100	196	4,0	2.810	10	012900030
0,8x4x125	221	4,0	2.910	10	012900033
0,8x4x150	246	4,0	3.060	10	012900036
1x5,5x100	209	5,0	3.150	10	012900039
1x5,5x150	259	5,0	3.590	10	012900042
1,2x6,5x100	220	6,0	3.920	10	012900048
1,2x6,5x150	270	6,0	4.190	10	012900051
1,2x8x150	282	7,0	5.230	3	012900057
1,2x8x200	332	7,0	5.530	3	012900060
1,6x10x200	332	8,0	6.600	3	012900066
2x12x250	382	10	8.830	2	012900069

1290/S

Csavarhúzókészlet



	Ft		
1290/S5	18.200	1	012900305
1290			0,5x3x75-0,8x4x100 -1x5,5x150 1,2x6,5x150 -1,2x8x150 mm

	Ft		
1290/S9X	34.400	1	012900319
1290			0,4x2,5x75 - 0,5x3,5x100 0,8x4x125 - 1x5,5x150 1,2x6,5x150 - 1,2x8x200 1,6x10x200 mm
1290N			0,8x4x30 -1,2x6,5x30 mm

1290N

Extra rövid csavarhúzó hasítottfejű csavarokhoz



ISO 2380

SxAxL mm	L1 mm	Ø mm	Ft		
0,8x4x30	86	4	3.010	5	012900103
1,2x6,5x30	86	6	3.370	5	012900106

1292

Csavarhúzó Phillips®-csavarokhoz



UNI/ISO 8764

PHxDxL mm	L1 mm	Ft		
0x3x60	156	2.220	10	012920003
0x3x100	196	2.520	5	012920006
1x4,5x80	189	3.040	10	012920009
1x4,5x120	229	3.370	10	012920012
2x6x100	220	4.030	10	012920018
2x6x150	270	4.450	10	012920021
3x8x150	282	5.570	3	012920024
4x10x200	332	7.750	3	012920027



	Ft		
1292/S4	14.850	1	012920304
			PH0x3x60-PH1x4,5x80 PH2x6x100-PH3x8x150 mm

1292N

Extra rövid csavarhúzó Phillips®-csavarokhoz



UNI/ISO 8764

PHxDxL mm	L1 mm	Ft		
1x4,5x30	86	2.880	5	012920103
2x6x30	86	3.130	5	012920106

1292L

Hosszú csavarhúzó Phillips®-csavarokhoz

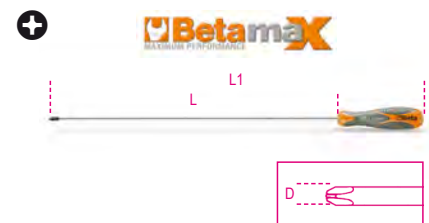

UNI/ISO 8764-1

PHxDxL mm	L1 mm	Ft		
0x3x300	396	4.880	3	012920203
1x4,5x400	509	5.970	3	012920206
2x6x400	520	7.490	3	012920209



1293/D...

Csavarhúzókészlet



1293/D6 Ft 19.800 1 012930401

1290 0,6x3,5x75-1x5,5x150
1,2x6,5x150 mm
1292 PH0x3x60 -PH1x4,5x80
PH2x6x100 mm

1293/D8 Ft 27.500 1 012930403

1290 0,5x3x75-0,8x4x100
1x5,5x150-1,2x6,5x150
1,2x8x150 mm
1292 PH0x3x60 -PH1x4,5x80
PH2x6x100 mm

1293/S...

Csavarhúzókészlet



1293/S8 Ft 24.600 1 012930208

1290 2,5x50-3x75-4x100-5,5x150
6,5x150 mm
1292 PH0x3x60 -PH1x4,5x80
PH2x6x100 mm

1293/S10 Ft 39.150 1 012930201

1290 0,4x2,5x50 -0,6x3,5x100
1x5,5x100-1,2x6,5x150
1,2x8x150-1,6x10x200 mm
1292 PH0x3x60 -PH1x4,5x80
PH2x6x100-PH3x8x150 mm

1293/S12 Ft 42.500 1 012930203

1290 0,5x3x75-0,8x4x125
1x5,5x150-1,2x6,5x150
1,2x8x200 mm
1290N 0,8x4x30 mm
1292 PH0x3x60 -PH1x4,5x80
PH2x6x100-PH3x8x150 mm
1292N PH1x4,5x30-PH2x6x30 mm

1293/S7 Ft 19.900 1 012930207

1292 PH0x3x60 -PH1x4,5x80
PH2x6x100 mm
1294 0,5x2,5x60-0,6x3x75
0,8x4x100-1x5x125 mm

1293ES

Hatlapú imbusz csavarhúzó



mm	L mm	L1 mm	Ø mm	Ft	1	012930001
2	100	196	3	3.060	5	012930001
2,5	100	196	4	3.060	5	012930002
3	100	196	4	3.210	5	012930003
4	100	196	5	3.630	5	012930004
5	100	209	6	3.970	5	012930005
6	125	245	7	4.570	5	012930006
8	150	282	10	5.910	2	012930008



1293ES/S7 Ft 27.400 1 012930057
2-2,5-3-4-5-6-8 mm

1293BP

Hatlapú imbusz csavarhúzó



mm	L mm	L1 mm	Ft	1	012930501
2	100	196	3.130	5	012930501
2,5	100	196	3.130	5	012930502
3	100	196	3.270	5	012930503
4	100	196	3.660	5	012930506
5	100	209	3.980	5	012930509
6	125	245	4.680	5	012930512
8	150	282	6.310	2	012930515



1293BP/S7 Ft 28.150 1 012930558
2-2,5-3-4-5-6-8 mm

1294

Csavarhúzó hernyócsavarokhoz



SxDxL mm	L1 mm	Ft	1	012940003
0,5x2,5x60	156	2.130	5	012940003
0,6x3x75	171	2.230	5	012940006
0,6x3x100	196	2.300	5	012940009
0,8x4x100	196	2.820	5	012940012
0,8x4x150	246	3.750	5	012940015
1x5x125	234	3.410	5	012940018
1,2x6,5x150	282	4.180	5	012940027



1294/S5 Ft 14.850 1 012940305
0,5x2,5x60-0,6x3x100
0,8x4x100-1x5x125
1,2x6,5x150 mm

1294L

Hosszú csavarhúzó
hernyócsavarokhoz

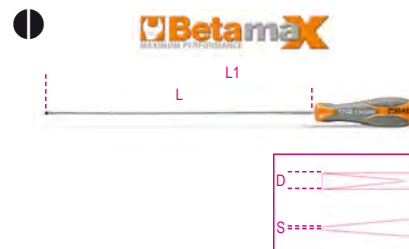

SxDxL mm	L1 mm	Ft	1	012940206
0,6x3x300	396	4.660	3	012940206
0,8x4x400	496	5.500	3	012940209
1x5x400	509	6.670	3	012940215
1,2x6,5x400	532	7.540	3	012940218

1295

Ütvecsavarhúzó



1295 Ft 21.200 1 012950001
L mm 130



1295/C14

Ütvecsavarhúzó készlet 14 betéttel és betéttartóval



1295/C14 Ft 52.850 1 012950108

	866LP	1,2x6,5 - 1,6x10 mm
	866PH	PH2 - PH3
	866PZ	PZ2 - PZ3
	866PE	5 - 6 mm
	866TX	T27 - T30 - T40 - T45 - T50 - T55
	895/6	□ 1/2 - ○ 5/16
	1295	■ 1/2

170x100x35 mm - 1,3 kg

1297TX

Ímbusz csavarhúzó Torx®-csavarokhoz



Ø	L mm	L1 mm	Ø mm	Ft	1	012970006
T6	50	146	3,0	4.110	5	012970006
T7	50	146	3,0	4.200	5	012970007
T8	60	156	3,0	4.230	5	012970008
T9	60	169	4,0	4.440	5	012970009
T10	80	189	4,0	4.690	5	012970010
T15	80	189	4,0	4.720	5	012970015
T20	100	209	4,5	4.830	5	012970020
T25	100	209	5,0	5.010	5	012970025
T27	115	235	6,0	5.170	5	012970027
T30	115	235	6,0	5.410	5	012970030
T40	130	262	7,0	5.890	2	012970040
T45	130	262	8,0	6.760	2	012970045



1297TX/S12 Ft 59.450 1 012970312
T6-T7-T8-T9-T10
T15-T20-T25-T27
T30-T40-T45



Betamax



1297TX/D6 Ft 29.850 1 012970409
T10-T15-T20
T25-T27-T30

1297TX/L

Ímbusz csavarhúzó Torx® csavarokhoz, hosszú



Ø	L mm	L1 mm	Ø mm	Ft	1	012970115
T15	210	319	4,0	4.890	2	012970115
T20	210	319	4,5	5.040	2	012970120
T25	210	319	5,0	5.220	2	012970125
T30	210	330	6,0	5.840	2	012970130
T45	210	342	8,0	6.460	2	012970145



Betamax



1297TX/L-S5 Ft 27.450 1 012970325
TX/L15-TX/L20-TX/L25-
TX/L30-TX/L45

1298RTX

Ímbusz csavarhúzó Tamper Resistant Torx®-csavarokhoz



Ø	L mm	L1 mm	Ø mm	Ft	1	012980009
T9	60	169	4,0	4.830	5	012980009
T10	80	189	4,0	4.940	5	012980010
T15	80	189	4,0	5.230	5	012980015
T20	100	209	4,0	5.290	5	012980020
T25	100	209	4,5	5.360	5	012980025
T27	115	235	5,5	5.710	5	012980027
T30	115	235	6,0	5.920	5	012980030
T40	130	262	7,0	6.270	2	012980040



Betamax



1298RTX/S8 Ft 43.550 1 012980308
T9-T10-T15-T20
T25-T27-T30-T40

1299PZ

Csavarhúzó Pozidriv®- és Supadriv®-csavarokhoz



UNI/ISO 8764

PZ	L mm	L1 mm	Ft	1	012990000
0	60	156	3.060	5	012990000
1	80	189	3.700	5	012990003
2	100	220	5.170	5	012990006
3	150	282	7.480	2	012990009
4	200	332	10.550	2	012990012



Betamax



1299PZ/S6 Ft 27.000 1 012990306
1299PZ PZ0-PZ1-PZ2-PZ3
1299NPZ PZ1-PZ2

1299N/PZ

Extra rövid csavarhúzó Pozidriv®- és Supadriv®-csavarokhoz



UNI/ISO 8764

PZ	L mm	L1 mm	Ft	1	012990021
1	30	86	3.620	5	012990021
2	30	86	3.990	5	012990024

Beta
Quality Tools

JÁRMŰJAVÍTÁS

Járműjavító szerszámainkat, amelyeket a legigényesebb szakemberek használnak, a világ legmagasabb követelményeinek megfelelően fejlesztettük és gyártottuk, és rendszeresen teszteljük a legnagyobb terhelést jelentő üzemi körülmények között.

Több mint 50 éve büszkén dolgozunk együtt a legnagyobbakkal, akik segítenek termékeink folyamatos fejlesztésében és biztosítják a legmagasabb minőségi színvonalnak való megfelelést.

A járműjavító eszközök az alábbi szakaszokban találhatóak:

DIAGNOSZTIKA	1438 - 1499 1758VT - 1760TMC
MOTOR	955 - 989A 1438 - 1499
OLAJ ÉS SZŰRŐK	1438 - 1499 1877 - 1885
ELEKTROMOS RENDSZER	1438 - 1499
GYORSINDÍTÓK	1498BC/12 - 1498/40A
ERŐÁTVITEL	1438 - 1499
FELFÜGGESZTÉS	1549 - 1569CP
FÉKEK	1438 - 1499
KEREKEK	955 - 989A
KAROSSZÉRIA	1302 - 1369 1763 - 1767A
EGYÉB BERENDEZÉSEK	1878 - 3067
EMELÉSTECHNIKA	3029/2T - 3067/70-13T



1302

Konvex egyengető idom, kerek, sima



g 770 Ft 36.350 1 013020001

1303

Hajlított egyengető idom



g 1350 Ft 27.350 1 013030001

1304

Egyengető alátét idom



g 875 Ft 36.250 1 013040001

1305

Egyengető idom



g 1190 Ft 22.200 1 013050001

1305Z

Rovátkás egyengető idom



g 1065 Ft 26.650 1 013050002

1306

Sarok egyengető idom



g 1040 Ft 21.550 1 013060001

1307

Normál egyengető idom

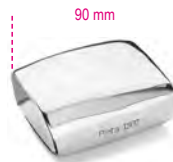

g 1100 Ft 41.600 1 013070001

1308

Ovális egyengető idom



g 1100 Ft 39.050 1 013080001

1310

Univerzális idom



g 1225 Ft 23.500 1 013100001

1312

Üllő idom



g 1220 Ft 49.850 1 013120001

1314

Konvex és lapostetejű idom



g 760 Ft 22.750 1 013140001

1326

Kanálvas



g 560 Ft 20.150 1 013260001

1327

Erősített kanálvas



g 1075 Ft 28.650 1 013270001

1328

Emelő kanálvas



g 935 Ft 25.750 1 013280001

1329

Kettős kanálvas



g 1800 Ft 78.750 1 013290001

1330

Hosszú kettős kanálvas



g 2125 Ft 83.950 1 013300001

1331

Hajlítós bőr betéttel



g 1100 Ft 46.850 1 013310001

1335BM

Műanyag nyeles karosszéria reszelő



g 500 Ft 13.850 2 013350010

1337/S5

5 darabos karosszériareszelő készlet, acélból

japán típus
(25-50-75-100-125 mm)



L mm 25-50-75-100-125 Ft 5.190 1 013370015

1338A - 1338B

Karosszériareszelő reszelőlapal



mm 1338A 9 360 38.750 2 013380001
1338B 12 360 40.400 2 013380002

1338

Karosszériareszelő az 1338R típusú reszelőlapokhoz



1338 Ft 21.350 2 013380003

1338R9 - 1338R12

Reszelőlap az 1338A-B típusú karosszériareszelőhöz



mm 1338R9 9 17.400 2 013380004
1338R12 12 19.050 2 013380005

1342

Extravékony laposvágó, krómozott



L mm 235 Ft 12.050 5 013420001

1342PM

Extra-vékony laposvágó kézvédővel



L mm 235 L1 mm 118 Ft 17.050 2 013420002

1342PMR

Tartalék kézvédő az 1342 típusú laposvágóhoz



1342PMR Ft 5.020 1 013420003

1343

Oldalvágó, krómozott



L mm 200 Ft 13.000 5 013430001

1344

vastagságmérő pár karosszéria lakatosok számára 10 rögzítő tapadókorongos pengével

- a következőkhöz javasolt:
- hátsó ablak pozicionálás
 - szerelés közben pozícióban tartás



1344 Ft 14.850 1 013440010

1344A/VW

célszerszám a VW ajtókilincs szereléséhez



L mm 260 Ft 4.220 1 013440100

1345

Karosszériakalapács, kerek domború fejjel, fanyéllal



1345 Ft 17.700 2 013450010

1351

Karosszériakalapács, kerek lapos fejjel, fanyéllal



1351 Ft 18.100 2 013510010

1353

Karosszériakalapács, kerek lapos fejjel, fanyéllal



1353 Ft 18.600 2 013530010

1357Z/45

Karosszériakalapács lapos, kerek rovátkás és sima négyszög fejjel, fanyéllal



1357Z/45 Ft 28.600 2 013570045

1359T

Karosszériakalapács, kerek lapos és horizontális fejjel, fanyéllal



1359 T Ft 17.650 2 013590010

1360G

puha gumikalapács, hengerfejűtömítés és kényes alkatrészek beépítéséhez

A puha ütőfelület elnyeli az ütés energiáját így meggátolja a megmunkált felület sérülését.



L mm 280 Ø mm 72 Ft 28.500 1 013600000

1360/K6

sík kerek fejű alumínium kalapács, cserélhető műanyag hegyek és metszőtü

- a következő tartozékokkal:
- 4 műanyag hegy
 - 1 darab, 2 különböző hosszúságra állítható metszőtü a kalapácsra illeszthető



L mm 320 Ø mm 34 Ft 34.650 1 013600006

1360/KP3

gömbfejű kalapács, cserélhető hegyek és metszőtü, műanyag

- Készlet tartalma:
- 1 210 g súlyú kalapács Ø 30 mm fejjel
 - 1 290 g súlyú kalapács Ø 40 mm fejjel
 - 1 75 g túska 5 mm hegygel



1360/KP3 Ft 39.950 1 013600050

1361/C12

Teflon® rúd készlet karosszéria javító műhelyek számára



1361/C12 Ft 62.950 1 013610012

≡ 275x160x57 mm

1361/K9

8 rúdból álló készlet karosszéria horpadás javításához

A készlet tartalma:

- gömbölyű fejű rúd, Ø 31 mm, hossz 110 cm
- csúcsos rúd, hossz 62 cm
- széles fejű rúd, hossz 112 cm
- horgos rúd, hossz 27 cm
- lapos, kerek fejű rúd, hossz 50 cm
- gömbölyű fejű rúd, Ø 19 mm, hossz 52 cm
- széles fejű rúd, hossz 27 cm
- kerek széles fejű rúd, hossz 28 cm
- vászonszák markolatokkal

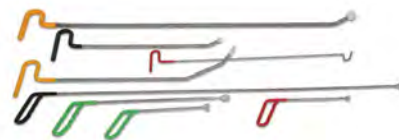

1361/K9 Ft 130.000 1 013610030



1362B

kerek buborék ellenőrző lap textilanyagból

- karvédett anyaggal bevont felület
- kis táskában szállítva



	Ø mm	Ft		
1362B	755	29.950	1	013620011

1364SE

állítható karosszériatartó állvány

Jellemzők:

- 4 forgókerék, 2 fékező
- az állvány 1 400 mm szélességig állítható
- az állvány 1 315 mm magasságig állítható
- rögzíthető
- az érintkező felület eltávolítható gumiborítással rendelkezik



L mm	H mm	P mm	Ft	
215=1400	780=1315	890	152.600	1 013640001

1364SV

karosszériatartó állvány
tálcával

Jellemzők:

- polietilén fedett érintkezési felület
- tálca méretei: 340x845x40 mm
- összehajtható



H mm	Ft		
1000	87.000	1	013640002

1364SCP

forgatható karosszériatartó állvány

különösen alkalmas motorháztetőkhöz, sárvédőkhöz és ajtókhöz

- 4 kerék, ebből 2 fékező forgókerék
- maximum 180°-ban elforgatható



H mm	L mm	P mm	Ft	
1300	1100	680	139.000	1 013640003

1364SP

karosszéria tartó állvány tapadókorongokkal

különösen alkalmas ablakokhoz

- 4 tapadókoronggal szállítva, Ø 95 mm
- a szélessége láncsal állítható
- polietilén burkolt cső



H mm	L mm	Ft	
1250	950	69.500	1 013640004



1365/K13

10 t hidrodinamikus szivattyú és tartozék
készlet karosszéria javításához
húzható táskában

A készlet a következőket tartalmazza:

- 10 tonnás hidrodinamikus szivattyú 1,5 méteres hajlékony csővel, 1/2" csatlakozóval
- dugattyú
- sárvédő húzó fogó, terhelhetőség 500 kg
- támasztó talp 150x90 mm
- "L" alap 50x50 mm
- 4 pontos lyukasztó
- Ø 50 mm kerek recézett lyukasztó
- 43 mm kúpos lyukasztó
- hosszabbító 240 mm
- hosszabbító 450 mm
- hosszabbító 475 mm
- gumi fej
- külső-külső csatlakozó tartozék szereléshez



	Ft		
1365/K13	313.400	1	013650013

900x420x180 mm

1365P10

hidrodinamikus szivattyú

1,5 méteres hajlékony cső, 1/2" csatlakozó



	Ft		
1365P10	138.400	1	013650110

1366A

buborék eltávolító szerszám
19 műanyag gombás készlettel

a következőkhöz ideális:

- jégverés buborékok
- ajtó rányitás okozta horpadások
- kisebb általános horpadások



	Ft		
1366A	35.100	1	013660200

1366B

csúszókalapács
horpadáskihúzó gombákhoz

a csúszókalapács súlya: 500 g



L
mm 440 Ft 22.200 1 013660250

1366KF

19 műanyag gombából álló
készlet a 1366A cikkszámhoz



1851VK-12V - 018510072

1366KF Ft 12.750 1 013660205

1366/K5

1,1 kg csúszókalapácsos pneumatikus
horpadás kihúzó

A készlet a következőket tartalmazza:

- 1 db Ø 75 mm tapadókorong
- 1 db Ø 100 mm tapadókorong
- 1 db Ø 125 mm tapadókorong
- 1 horog



1366/K5 Ft 91.450 1 013660010

610x240x90 mm

1366S

kocsis spotter karosszéria javításhoz

- mikroprocesszor segíti a hegesztési paraméterek kezelését
- teljesítmény és hegesztési idő beállítás
- beállítási tartomány 400÷2200 Ah
- egyes pont, pulzálásos, folyamatos üzem választókapcsoló
- hegesztési paraméter táblázat
- hővédelmi kijelzés
- gyorscsatlakozós pisztoly
- feszültség 230 V

CE



1366S Ft 727.500 1 013660000

1366S KIT

spotter tartozék készlet

- 10 peremes alátét
- 10 peremes alátét 90°
- 100 menetes csap 5x18 mm
- 100 önmetsző csap 5x18 mm
- 100 önmetsző csap 5x25 mm
- alátét horog Ø 8x16x1,5 mm
- elektróda M5-M6 csavarokhoz
- elektróda peremes alátétekhez



1366S KIT Ft 95.550 1 013660001

250x170x35

1366SL

húzókar
lemez helyreállításához

többhorgos csuklós fej
hullámhuzalal történő használathoz



L
mm 700 Ft 81.800 1 013660002

1366ST

húzó keresztartó
lemez helyreállításához

többhorgos csuklós fej
hullámhuzalal történő használathoz



L
mm 850 Ft 265.900 1 013660003

1366S/R1

3 pontos alátét
befogó



1366S/R1 Ft 9.980 1 013660501

1366S/R2

3 pontos alátét
lemez kihúzáshoz



1366S/R2 Ft 9.980 1 013660502

A jelzett árak 20 darabra vonatkoznak

1366S/R3

elektróda alátétekhez
Ø 8x16x1,5 mm



1366S/R3 Ft 11.850 1 013660503

1366S/R4

horog Ø 8x16x1,5 mm alátétekhez



1366S/R4 Ft 10.200 1 013660504

1366S/R5

alátétek Ø 8x16x1,5mm



1366S/R5 Ft 5.610 1 013660505

A jelzett árak 100 darabra vonatkoznak

Beta

1366S/R6

elektróda M5-M6 csavarokhoz



1366S/R6 Ft 11.800 1 013660506

1366S/R7

100 önmetsző csap 5x18 mm



1366S/R7 Ft 9.980 1 013660507

1366S/R8

100 önmetsző csap 5x25 mm



1366S/R8 Ft 13.600 1 013660508

1366S/R9

100 menetes csap M5 x 18 mm



1366S/R9 Ft 9.160 1 013660509

1366S/R10

10 peremes alátét



1366S/R10 Ft 6.410 1 013660510

1366S/R11

elektróda peremes alátétekhez



1366S/R11 Ft 32.850 1 013660511

1366S/R12

10 peremes alátét 90°



1366S/R12 Ft 12.600 1 013660512

1366S/R13

lemezmelegítő szélelektroda



1366S/R13 Ft 24.250 1 013660513

A jelzett árak 5 darabra vonatkoznak

1366S/R14

elektróda huzalhegyezéshez



1366S/R14 Ft 11.500 1 013660514

1366S/R21

hullámhuzal hűzőkar és hűző kereszttartó használatához

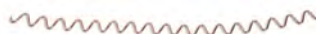

1366S/R21 Ft 8.550 1 013660551

A jelzett árak 10 darabra vonatkoznak

1366S/R22

mágneses tartó hullámhuzal részére



1366S/R22 Ft 28.200 1 013660552

1366S/R24

M4 húzógyűrű



1366S/R24 Ft 32.050 1 013660554

A jelzett árak 5 darabra vonatkoznak

1366S/R25

M5 húzógyűrű



1366S/R25 Ft 32.050 1 013660555

A jelzett árak 5 darabra vonatkoznak

1366S/R26

M6 húzógyűrű



1366S/R26 Ft 32.050 1 013660556

A jelzett árak 5 darabra vonatkoznak

1367/S4

kivágó matrica sorozat parkolás érzékelők beszereléséhez
méretek:
23 - 24 - 27 - 28

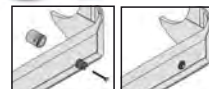

1367/S4 Ft 87.900 1 013670104

1367/K10

kivágó készlet parkolás érzékelők felszereléséhez

Készlet tartalma:
• méretek: 17 - 18 - 18,2 - 19 - 20 - 22,5 - 24 - 26 - 26,7 - 32 mm



Ø 12 mm

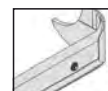
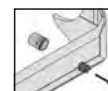

1367/K10 Ft 77.300 1 013670200

190x130x58 mm

Beta

1368

műanyagjavító készlet

- lehetővé teszi a műanyag alkatrészekben a repedések és törések gyors javítását

Tápfeszültség: 220÷240 V Shuko csatlakozóval
 Hőpisztoly kábel hossza: 3,5 m
 Tápvezeték hossza: 1,35 m
 2 teljesítmény szint: 35-75 W
 Hőpisztoly rézterminalokkal, 2 féle rögzítőkapocs beillesztő szöggel: 0°-90°
 Bemeneti védelem: hőmegszakító
 Kimeneti védelem: 10 A biztosíték
 Fémzseb a pisztoly elhelyezésére

CE



1368 Ft 167.300 1 013680001

1368G/K400

400 rögzítőkapocs készlet a 1368 készülékhez



1368G/K400 Ft 27.550 1 013680140

1368G/OD

hullámos egyenes rögzítőkapcsok a 1368 modellhez



1368G/OD Ft 6.890 1 013680100

A megadott árak 100 darabra vonatkoznak.

1368G/SD

spirális egyenes rögzítőkapcsok a 1368 modellhez



1368G/SD Ft 6.890 1 013680110

A megadott árak 100 darabra vonatkoznak.

1368G/CV

rögzítőkapcsok konvex szögekhez a 1368 modellhez



1368G/CV Ft 6.890 1 013680120

A megadott árak 100 darabra vonatkoznak.

1368G/C2U

rögzítőkapcsok konkáv szögekhez a 1368 modellhez



1368G/C2U Ft 6.890 1 013680130

A megadott árak 100 darabra vonatkoznak.

KALAPÁCSNYELEK

Hikori fából készült kalapácsnyelek:
 A hikori fa kiváló tulajdonságokkal rendelkezik, amely tökéletesen megfelel kalapácsnyélnek. Hosszú szálszerkezete elnyeli a rezgést és rendkívül ellenállóvá teszi töréssel szemben. Abban a valószínűtlen esetben, ha egyes szálok elszakadnak, a fej hirtelen leválásának kockázata mindenképp elenyésző.

Elhasználódás esetén a nyél cserélhető.

Mivel a fa természetes anyag, megőrzi saját nedvességtartalmát. Ezért a kalapácsot ne tárolja túl száraz helyen.

Üvegszálból készült kalapácsnyelek:
 Az üvegszál maggal ellátott kalapácsnyelek egyaránt tartósak és biztonságosak; a törés és sérülés kockázata minimális.

Ellenállnak az időjárásnak és a leggyakoribb vegyi anyagoknak.



- Kivételes keménységű üvegszálás mag

- Ergonomikus polipropilén váz

- Csúszásmentes, kényelmes elasztomer bevonat

1369/C11

11 darabos szerszámkészlet



1369/C11 Ft 323.800 1 013690033

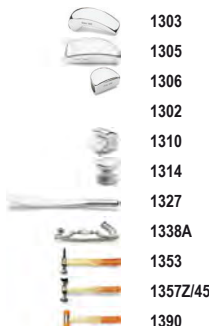

470x340x70 mm - 15,2 kg

1370

Lakatos kalapács német modell, fanyéllal



HICKORY

UNI 7778 DIN 1041

g	A mm	L mm	L1 mm	Ft	1	013700051
100	15	260	82	4.730	5	013700051
200	19	280	95	5.320	5	013700052
300	23	300	105	6.120	5	013700053
400	25	310	112	6.880	5	013700054
500	27	320	118	7.450	5	013700055
600	30	330	122	8.600	5	013700056
800	33	350	130	9.660	4	013700058
1000	36	360	135	11.350	4	013700060
1500	42	380	145	13.300	2	013700065
2000	47	400	155	16.150	1	013700070



1370/MR...

Tartalék nyél a 1370-hez



	Ft		
1370MR 100 1370/100	2.160	4	013700081
1370MR 200 1370/200	2.360	4	013700082
1370MR 300 1370/300	2.530	4	013700083
1370MR 400 1370/400	2.720	4	013700084
1370MR 500 1370/500	3.020	4	013700085
1370MR 600 1370/600	3.370	4	013700086
1370MR 800 1370/800	3.520	4	013700088
1370MR 1000 1370/1000	3.730	4	013700090
1370MR 1500 1370/1500	4.170	4	013700095
1370MR 2000 1370/2000	4.630	4	013700100

1370T

Lakatos kalapács német modell műanyag nyéllel



g	A mm	L mm	L1 mm	Ft		
200	19	280	95	8.230	5	013700620
300	23	300	105	8.900	5	013700630
500	27	320	118	9.720	5	013700650
800	33	350	130	10.400	4	013700680
1000	36	360	135	13.200	4	013700700
1500	42	365	145	15.900	2	013700750

1370F

Biztonsági lakatos kalapács, francia modell, fanyéllal



NF E 71.014

A mm	L mm	L1 mm	Ft		
24	260	77	280	8.400	2 013700424
26	260	80	310	8.910	2 013700426
28	280	86	400	9.430	2 013700428
30	280	92	450	9.580	2 013700430
32	300	100	550	10.400	2 013700432
36	300	104	720	13.350	2 013700436
40	330	110	1065	15.000	2 013700440
42	330	116	1080	15.850	2 013700442
50	380	138	1760	16.850	2 013700450
60	380	160	2585	20.050	2 013700460

1370F/MR...

Tartaléknyél a 1370F-hez



	Ft		
1370F/MR 24 1370F/24-26	2.160	2	013700474
1370F/MR 28 1370F/28-30	2.270	2	013700478
1370F/MR 32 1370F/32-36	2.660	2	013700482
1370F/MR 40 1370F/40-42	3.430	2	013700490
1370F/MR 50 1370F/50	3.780	2	013700495
1370F/MR 60 1370F/60	4.640	2	013700496

1370FT

Lakatos kalapács, francia modell, műanyag nyéllel



A mm	L mm	L1 mm	Ft		
28	280	86	530	14.050	1 013700528
30	280	92	625	14.250	1 013700530
32	300	100	750	15.450	1 013700532
36	300	104	930	17.750	1 013700536
40	330	110	1150	18.750	1 013700540
42	330	116	1250	19.350	1 013700542
50	380	138	2100	21.450	1 013700550
60	380	160	2750	23.400	1 013700560

1374F

Asztaloskalapács, francia modell, fanyéllal



NF E 71.012

A mm	L mm	L1 mm	Ft		
16	250	80	180	6.570	2 013740416
20	270	86	250	7.310	2 013740420
22	290	92	335	7.560	2 013740422
26	290	103	425	8.330	2 013740426
28	310	108	510	8.790	2 013740428
30	310	117	580	9.590	2 013740430

1374F/MR...

Tartaléknyél a 1374F-hez



	Ft		
1374F/MR 16 1374F/16	1.950	2	013740456
1374F/MR 20 1374F/20	2.030	2	013740460
1374F/MR 22 1374F/22-26	2.060	2	013740462
1374F/MR 28 1374F/28	2.310	2	013740468
1374F/MR 30 1374F/30	2.400	2	013740470

1375

Ácskalapács, fanyéllal



g	L1 mm	Ø mm	L mm	Ft		
300	95	25	300	7.370	3	013750000

1375/MR

Tartaléknyél a 1375-höz



	Ft		
1375/MR	3.300	2	013750003

1375A

ácskalapács, műanyag és üvegszál nyél



oz	g	L mm	L1 mm	Ft		
16	450	330	130	11.300	3	013750016
20	570	330	130	11.850	3	013750020

1375B

Ácskalapács, acélnyéllel



oz	g	L mm	L1 mm	Ft		
16	450	330	130	10.200	3	013750026
20	570	330	130	10.500	3	013750030

1376X

Szögletes fejű ácskalapács épületasztalosoknak, fanyéllal



g	A mm	L1 mm	L mm	Ft		
250	20	125	450	7.060	3	013760125
300	25	130	450	7.540	3	013760130
400	27	132	450	8.050	3	013760140

1376X/MR

Tartalék nyél 1376X-hez



1376X/MR	Ft		
	4.060	2	013760161

1376XT

Szögletes fejú ácskalapács épületasztalosoknak, műanyag nyéllel



g	A mm	L1 mm	L mm	Ft		
250	20	125	500	8.910	3	013760525
300	25	130	500	9.510	3	013760530
400	27	132	500	10.050	3	013760540

1376XT/MR

Tartaléknyél a 1376XT modellhez



1376MR/XT	Ft		
	4.540	2	013760585

1377

Gömbfejű lakatos kalapács, amerikai modell, fanyéllal



HICKORY

g	L mm	L1 mm	Ft		
340	330	95	11.150	2	013770134
450	350	102	11.600	2	013770145
570	350	110	13.400	2	013770157
680	360	116	13.650	2	013770168
900	380	120	14.950	2	013770190

1377/MR...

Tartaléknyél a 1377-hez



1377MR 340	Ft		
1377/340	2.400	2	013770234
1377MR 450	2.790	2	013770245
1377/450			
1377MR 570	3.050	2	013770257
1377/570			
1377MR 680	3.170	2	013770268
1377/680			
1377MR 900	3.810	2	013770290
1377/900			

1377T

kerekfejű és gömbfokú kalapács kazánkovácsok és bádigosok számára Faser nyél



g	L mm	L1 mm	Ft		
340	330	95	10.750	2	013770534
450	350	102	13.000	2	013770545
570	350	110	14.400	2	013770557
680	360	116	15.300	2	013770568
900	380	120	17.700	2	013770590

1378

Gömbfejű lakatos kalapács szimmetrikus véggel, amerikai modell, fanyéllal



HICKORY

g	L mm	L1 mm	Ø mm	Ft		
340	330	100	27	10.200	2	013780134
570	350	115	32	13.400	2	013780157

1378/MR...

Tartaléknyél a 1378-hoz



1378MR 340	Ft		
1378/340	2.310	2	013780234
1378MR 570	3.160	2	013780257
1378/570			

1379F

Műszerész kalapács, francia modell, fanyéllal



HICKORY

NF E 71.011

A mm	L mm	L1 mm	Ft		
16	250	126	6.570	2	013790416
18	250	135	7.060	2	013790418
20	260	142	7.630	2	013790420

1379F/MR...

Tartaléknyél a 1379F-hez



1379F/MR 16	Ft		
1379F/16-18	2.050	2	013790426
1379F/MR 20	2.330	2	013790430
1379F/20			

1380

Ráverő kalapács, fanyéllal



HICKORY

UNI 7777 DIN 6475

g	A mm	L mm	L1 mm	Ft		
800	38	260	90	8.440	2	013800208
1000	40	260	95	9.130	2	013800210
1250	43	260	100	9.580	2	013800212
1500	45	280	110	10.850	2	013800215
2000	50	300	120	14.050	2	013800220

1380/MR...

Tartaléknyél a 1380-hoz



1380MR 800	Ft		
1380/800-1000-1250	2.660	2	013800238
1380MR 1500	2.850	2	013800245
1380/1500			
1380MR 2000	3.180	2	013800250
1380/2000			

1380S

Ráverő kalapács nyélvédővel, fanyéllal



g	A mm	L mm	L1 mm	Ft		
800	36	260	90	9.170	2	013800400
1000	39	260	95	10.150	2	013800405
1250	43	260	100	10.950	2	013800410
1500	45	260	110	12.400	2	013800415

1380S/MR...

Tartaléknyél a 1380S-hez



1380S/MR 800	Ft		
1380S/800-1000-1250	2.800	2	013800417
1380S/MR 1500	3.070	2	013800419
1380S/1500			

1380T

Ráverőkalapács,
műanyag nyéllel



g	A mm	L mm	L1 mm	Ft		
800	35	260	85	12.600	2	013800308
1000	40	260	100	13.000	2	013800310
1250	42	260	110	14.000	2	013800312
1500	45	260	120	15.250	2	013800315
2000	49	295	120	18.250	1	013800320

1381

Hosszú ráverő kalapács
Hickory nyéllel



g	A mm	L mm	L1 mm	Ft		
3000	55	800	142	34.150	1	013810030
4000	60	900	152	38.150	1	013810040
5000	70	900	162	43.300	1	013810050
8000	80	900	185	73.350	1	013810080

* = kőrisfa nyél

1381/MR...

Tartaléknyél a 1381-hez



	Ft		
1381MR 3-4 1381/3000-4000	17.200	2	013810730
1381MR 5 1381/5000	18.250	2	013810750
1381MR 8 1381/8000	18.800	2	013810780

1381T

Ráverőkalapács,
műanyagnyél



g	A mm	L mm	L1 mm	Ft		
3000	55	900	142	37.700	1	013810330
4000	60	900	152	41.300	1	013810340
5000	70	900	162	46.800	1	013810350
8000	82	920	180	86.150	1	013810380

1385

Bronzkalapács, fanyéllel



g	A mm	L mm	L1 mm	Ft		
400	26	260	75	13.600	2	013850404
600	32	270	80	19.450	2	013850406
800	34	280	90	25.650	2	013850408
1000	37	280	100	31.650	2	013850410
1500	43	280	110	46.050	2	013850415
2000	48	300	120	63.150	1	013850420

1385/MR

Tartaléknyél a 1385 modellhez



	Ft		
1385MR 400 1385 400	3.810	2	013850464
1385MR 600 1385 600	3.920	2	013850466
1385MR 800 1385 800	4.000	2	013850468
1385MR 1000 1385 1000	4.310	2	013850470
1385MR 1500 1385 1500	4.670	1	013850475
1385MR 2000 1385 2000	4.970	1	013850480

1390

Műanyag kalapács,
cserélhető végekkel, fanyéllel



UNI 7784

Ø mm	L mm	L1 mm	Ft		
22	260	70	7.380	5	013900022
28	280	85	9.240	5	013900028
35	310	95	12.350	5	013900035
45	320	107	19.900	4	013900045
60	380	128	33.950	2	013900060

1390/MR...

Tartaléknyél a 1390-hez



	Ft		
1390MR 22 1390/22	1.860	2	013900222
1390MR 28 1390/28	2.110	2	013900228
1390MR 35 1390/35	2.460	2	013900235
1390MR 45 1390/45	3.030	2	013900245
1390MR 60 1390/60	3.690	2	013900260

1390R

Tartalék végek 1390-hez



Ø mm	Ft		
22	1.150	4	013900122
28	1.780	4	013900128
35	2.400	4	013900135
45	4.060	4	013900145
60	7.110	4	013900160

1390N

Kalapács cserélhető Nylon-végekkel, fanyéllel

Középkemény végek: 75 Shore
Olaj- és kopásálló
Lemez és fémek megmunkálására alkalmas



UNI 7784

Ø mm	L mm	L1 mm	Ft		
22	260	70	7.380	3	013900522
28	280	85	9.240	3	013900528
35	310	95	12.350	3	013900535
45	320	107	19.900	2	013900545
60	380	128	33.950	2	013900560

1390NR

Tartalék Nylon-végek 1390N modellhez



Ø mm	Ft		
22	1.150	4	013900622
28	1.780	4	013900628
35	2.400	4	013900635
45	4.060	4	013900645
60	7.110	4	013900660

1391

Gumikalapács



Ø mm	L mm	L1 mm	Ft		
35	280	90	11.500	2	013910135
50	320	105	15.250	2	013910150
55	355	110	17.800	2	013910155
65	380	130	24.500	2	013910165

1391A

Csempéző kalapács,
fehér gumból



g	Ø mm	L mm	L1 mm	Ft		
500	45	290	100	11.000	2	013910205
1000	60	300	120	14.300	2	013910210

1392

Ütéselnyelő műanyag kalapács,
cserélhető végekkel, acélnyéllel



Ø mm	L mm	L1 mm	Ft		
30	300	105	19.350	2	013920030
35	305	115	20.700	2	013920035
40	310	125	23.700	2	013920040
50	325	135	28.150	2	013920050
60	385	155	43.550	2	013920060

1392R

Tartalék végek az 1392-hez

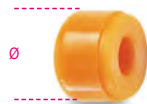

Ø mm	Ft		
30	2.570	4	013920230
35	3.750	4	013920235
40	5.690	4	013920240
50	7.610	4	013920250
60	11.450	4	013920260

1393

Gumikalapács



Ø mm	L mm	L1 mm	Ft		
50	315	90	5.150	3	013930050
60	340	110	5.750	3	013930060
70	370	130	6.790	2	013930070

JÁRMŰJAVÍTÁS

Járműjavító szerszámainkat, amelyeket a legigényesebb szakemberek használnak, a világ legmagasabb követelményeinek megfelelően fejlesztettük és gyártottuk, és rendszeresen teszteljük a legnagyobb terhelést jelentő üzemi körülmények között.

Több mint 50 éve büszkén dolgozunk együtt a legnagyobbakkal, akik segítenek termékeink folyamatos fejlesztésében és biztosítják a legmagasabb minőségi színvonalnak való megfelelést.

A járműjavító eszközök az alábbi szakaszokban találhatóak:

DIAGNOSZTIKA	1438 - 1499 1758VT - 1760TMC
MOTOR	955 - 989A 1438 - 1499
OLAJ ÉS SZŰRŐK	1438 - 1499 1877 - 1885
ELEKTROMOS RENDSZER	1438 - 1499
GYORSINDÍTÓK	1498BC/12 - 1498/40A
ERŐÁTVITEL	1438 - 1499
FELFÜGGESZTÉS	1549 - 1569CP
FÉKEK	1438 - 1499
KEREKEK	955 - 989A
KAROSSZÉRIA	1302 - 1369 1763 - 1767A
EGYÉB BERENDEZÉSEK	1878 - 3067
EMELÉSTECHNIKA	3029/2T - 3067/70-13T



1410/M

Gumigyűrű kiszedő szerszám



Ø mm	Ft		
3,5	7.250	2	014100051

1428

Sérültféjű csavar kiszedő



Ø mm	□	L mm	○ mm	Ft		
8	3/8	36	17	7.060	2	014280008
10	3/8	36	17	7.060	2	014280010
11	3/8	36	17	7.060	2	014280011
12	3/8	36	19	7.060	2	014280012
13	3/8	36	19	7.060	2	014280013
14	3/8	36	19	7.060	2	014280014
15	1/2	38	21	7.540	2	014280015
16	1/2	38	21	7.540	2	014280016
17	1/2	38	21	7.540	2	014280017
18	1/2	38	26	7.540	2	014280018
19	1/2	38	26	7.540	2	014280019
20	1/2	38	26	8.420	2	014280020
21	1/2	38	26	8.420	2	014280021
22	1/2	38	26	9.080	2	014280022
24	1/2	38	26	9.080	2	014280024
27	1/2	38	26	9.530	2	014280027

1428L

Sérültféjű csavar kiszedő, hosszított



Ø mm	Ft		
17	18.900	1	014280217
19	19.650	1	014280219
21	21.000	1	014280221



Ø mm	Ft		
1428L/B3 17-19-21 mm	59.550	1	014280303



Ø mm	Ft		
1428/SB11 8-10-11-12-13-14 15-16-17-18-19 mm	86.200	1	014280111
1428/SB5 20-21-22-24-27 mm	48.000	1	014280115

1429

Törtcsavarkiszedő

3/8"

1/2"



mm	□	L mm	Ft	☞	☞
2	3/8	60	4.860	3	014290002
3	3/8	60	4.860	3	014290003
4	3/8	60	4.860	3	014290004
5	3/8	60	5.110	2	014290005
6	3/8	60	5.110	2	014290006
8	1/2	70	5.440	2	014290008
10	1/2	70	5.440	2	014290010

3/8"

1/2"



1429/SB7	Ft	☞	☞
2-3-4-5-6-8-10 mm	39.950	1	014290107

1430/...

Törtcsavarkiszedő

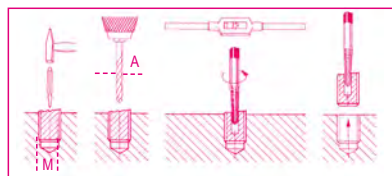

1430/1	M	A mm	Ft	☞	☞
1430/1	3÷6	2,5	1.370	10	014300006
1430/2	6÷8	3,0	1.470	10	014300008
1430/3	8÷11	4,5	1.770	10	014300011
1430/4	11÷14	6,0	2.360	10	014300014
1430/5	14÷18	8,0	2.720	10	014300018
1430/6	18÷24	11,0	5.280	5	014300024
1430/7	24÷33	14,0	8.090	5	014300033
1430/8	33÷50	21,0	10.250	5	014300050



1430/S5	Ft	☞	☞
1430/S5	10.350	1	014300105
1430/1-1430/2-1430/3			
1430/4-1430/5			
1430/S6	15.050	1	014300106
1430/1-1430/2-1430/3			
1430/4-1430/5-1430/6			
1430/S8	32.800	1	014300108
1430/1-1430/2-1430/3			
1430/4-1430/5-1430/6			
1430/7-1430/8			

1431/...

kúpos le húzószerszám törött csavarok és csapok eltávolításához

Stabilan nem megfogható csavarok és csapok eltávolításához, ütőmechanizmus

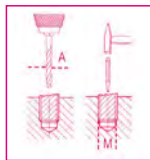

1431/3	M	A mm	L mm	□	Ft	☞	☞
1431/3	3÷6	2,5	59	5	2.320	10	014310051
1431/5	6÷8	5,0	68	5	2.320	10	014310052
1431/6	8÷11	6,0	72	6	2.780	10	014310053
1431/8	11÷14	8,0	77	8	2.980	10	014310054
1431/9	14÷18	9,0	82	9	3.200	10	014310055

1431/C5

kúpos le húzószerszám törött csavarok és csapok eltávolításához

Ütőmechanizmus

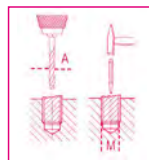

1431/C5	M mm	A mm	Ft	☞	☞
1431/C5	6÷18	3÷9	16.100	1	014310005

1433

Görgős töcsavarkihajtó

3/8"

1/2"

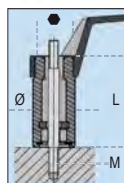

M mm	∅ mm	L mm	● mm	□	Ft	☞	☞
5	21	60	19	3/8	5.370	2	014330005
6	24	60	21	1/2	5.370	2	014330006
7	24	60	21	1/2	5.370	2	014330007
8	24	60	21	1/2	5.370	2	014330008
9	28	70	21	1/2	6.270	2	014330009
10	28	70	21	1/2	6.270	2	014330010
10,5	28	70	21	1/2	6.270	2	014330021
11	28	70	21	1/2	6.270	2	014330011
12	28	70	21	1/2	6.270	2	014330012
14	36	72	24	-	9.940	2	014330014
16	36	72	24	-	9.940	2	014330016

1433/C11

1/2"-os töcsavarkihajtó

3/8"

1/2"

☛



1433/C11	Ft	☞	☞
1433/C11	83.600	1	014330311
M5 - M6 - M7 - M8 - M9 - M10 - M10,5			
M11 - M12 - M14 - M16			
☞ 340x135x56 mm - ☛ 3,0 kg			

1435

Excenteres töcsavarkihajtó, krómzott



∅ mm	Ft	☞	☞
4÷20	39.750	1	014350001

1435R

Tartalék kerék az 1435 típusú excenteres töcsavarkihajtóhoz



1435R	Ft	☞	☞
1435R	11.900	1	014350010

1435/1

Excenteres töcsavarkihajtó, krómzott

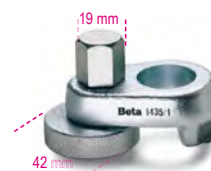

∅ mm	Ft	☞	☞
19÷26	49.350	1	014350002

1435/1R

Tartalék kerék az 1435/1 típusú excenteres töcsavarkihajtóhoz

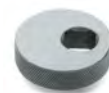

1435/1R	Ft	☞	☞
1435/1R	12.400	1	014350011

1437/C12

12 darabos szerszámkészlet
légszászereléshez



1437/C12 Ft 39.650 1 014370001
260x160x55 mm - 1,0 kg

1438

Kuplungtárcsa központosító



1438 Ft 20.700 1 014380001

1438R

Tartalék betétek az 1438
típusú központosítóhoz, műanyagból



Ø mm	Ft	1	014380101
14÷18	1.460	5	014380101
18÷21	1.460	5	014380102
22÷25	1.460	5	014380103

1438DCT

6-fokozatú DCT sebességváltó kiszerező/
beépítő szerszám
Volvo, Ford, Chrysler és Dodge típusokhoz

38"



1438DCT Ft 66.000 1 014380300

1438EVO

univerzális kuplungtárcsa központosító készlet

Az alkatrészek teljes mértékben fémből készültek



1438EVO Ft 119.500 1 014380011
290x200x60 mm - 2 kg

1438DSG

a VAG csoport kettős tengelykapcsolós
DSG sebességváltó reteszelés/kioldás kar



1438DSG Ft 12.350 1 014380200

1438K/DSG-2

6- és 7-fokozatú DSG váltós kuplungtárcsa
központosító készlet

6-fokozatú DSG és kézi váltóhoz,
7-fokozatú DSG (1. és 2. sorozat) és S-tronic váltóhoz.



1438K/DSG-2 Ft 242.400 1 014380260
350x370x117 mm - 10 kg

1438K/PWR

kiszerező/beépítő készlet
Powershift dupla kuplungos váltóhoz



1438K/PWR Ft 166.700 1 014380270
440x400x85 mm - 10 kg

1438DCT/S

kettős száraz tengelykapcsolós Ford
kuplungtárcsa központosító készlet

kuplungtárcsa központosításhoz
megbontással végzett munkák után mint például a szimering
csere



1438DCT/S Ft 126.800 1 014380305
440x400x85 mm - 8 kg

1439/K7

Sarokcsavarhúzó 90°, hosszított kivitel,
betéttel, dobozban



1439K7 Ft 79.700 1 014390101
500x120x60 mm - 825 g

1440/...

Dugattyúgyűrű szorító szalag



	Ø mm	L mm	Ft	📦	📄
1440/0	40÷75	50	11.250	1	014400000
1440/1	57÷125	80	15.250	1	014400010
1440/1A	57÷125	100	17.350	1	014400011
1440/2	90÷175	80	18.300	1	014400020
1440/2A	90÷175	100	19.200	1	014400021
1440/3	90÷175	165	28.450	1	014400030

1445/1 - 1445/2

Dugattyúgyűrű fogó, nikkelezett műanyag bevonatú szárral



	Ø mm	Ft	📦	📄
1445/1	50÷100	15.900	1	014450001
1445/2	90÷150	20.500	1	014450002

1452K

Szeleprugó feszítő fogó három pófával

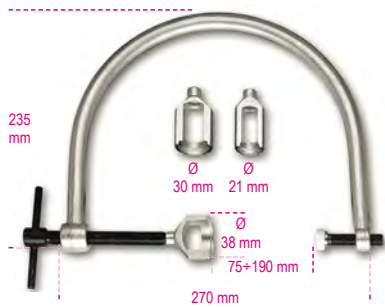

	Ft	📦	📄
1452K	60.300	1	014520100

1452PN/K

Pneumatikus szerszám motorszeleprugóhoz

1400 N



Ø mm	L mm	L1 mm	Ft	📦	📄
16-19-23	230	185	129.300	1	014520110
25-30-42					

1454P

kaparó tömítés és tömítőanyag maradék eltávolítására

különösen fejek és lapos felületek tisztításához ajánlott



L mm	L1 mm	Ø mm	Ft	📦	📄
210	32	3,3	15.950	1	014540010

1455SVP

Pneumatikus szelepcsiszoló

• Nyomás: 6 bar

CE



	Ft	📦	📄
1455SVP	149.700	1	014550001

1455SVP/R...

Tartalék tappancsok, alkatrészek az 1455SVP típusú szelepcsiszolóhoz



	Ft	📦	📄
1455SVP/R1	2.520	5	014550501
1455SVP/R2	2.520	5	014550502
1455SVP/R3	2.520	5	014550503

1457/B4

Rilsan csatlakozó kioldó eszköz készlet

Tartalmazott méretek:

- 6x8
- 10x12
- 15x16
- 18x1/2



	Ft	📦	📄
1457/B4	16.400	1	014570024

1458

Biztosítógyűrűfogó, krómozott, PVC-bevonatú szárral



DIN 5417	Ø mm	Ft	📦	📄
	30÷100	29.200	2	014580001

1460F

Szeleptömítés kisedő, nikkelezett, fekete pófákkal



	Ft	📦	📄
1460F	24.900	1	014600010

1461/C5G

Szerszámkészlet vezérlés beállításához Fiat/Alfa/Lancia/Opel/Suzuki/Ford dízelmotoroknál

1.3 Multijet motorok



	Ft	📦	📄
1461/C5G	116.900	1	014610053

280x245x75 mm 2,6 kg

1461/C6B

Szerszámkészlet vezérlés beállításához Peugeot/Citroën benzinmotoroknál

1.0-1.1-1.4-1.6-1.6 16v-1.6Gti-1.6 18V-1.8-1.8 16v-1.9-2.0-2.0 16v-2.0T-2.0 Hpi-2.2 16v motorok



	Ft	📦	📄
1461/C6B	184.600	1	014610063

310x290x120 mm 3,5 kg

1461/C6G

Szerszámkészlet vezérlés beállításához Peugeot/Citroën dízelmotoroknál

1.4-1.6-2.0D, 1.4-1.6TDCI, 1.4-1.6-2.0-2.2Hdi, 1.5-1.9-2.5D motorok



1461/C6G Ft 240.200 1 014610064
385x290x100 mm 3,8 kg

1461/C7B

Szerszámkészlet vezérlés beállításához Renault/Nissan benzinmotoroknál

1.4-1.6-1.8-2.0 16V motorok



1461/C7B Ft 139.400 1 014610072
280x245x75 mm 3,2 kg

1461/C8B

Szerszámkészlet vezérlés beállításához Ford benzinmotoroknál

1.25-1.4-1.6-1.6 SCTI-1.6 Ti-VCT-1.6 16V motorok



1461/C8B Ft 94.100 1 014610083
240x210x50 mm 1,8 kg

1461/C9B

Szerszámkészlet vezérlés beállításához Opel benzinmotoroknál

1.0 12V, 1.0-1.2-1.4 16V motorok



1461/C9B Ft 76.400 1 014610092
335x145x60 mm 2 kg

1461/C11A

Szerszámkészlet vezérlés beállításához Renault motoroknál

2.0 dCi motorok



1461/C11A Ft 70.850 1 014610111
420x280x60 mm - 1,2 kg

1461/C12A

Szerszámkészlet vezérlés beállításához Fiat motoroknál

1.9-2,2 JTS és 1,9 JTD Euro 4 motorok



1461/C12A Ft 139.400 1 014610123
280x245x75 mm - 1,8 kg

1461/C13B

Szerszámkészlet vezérlés beállításához Fiat 1.4 Multiair motoroknál



1461/C13B Ft 101.100 1 014610134
240x210x50 mm 2,8 kg

1461/C18B

Szerszámkészlet vezérlés beállításához Volkswagen/Audi/Seat és Skoda benzinmotoroknál

1.6-1.8-1.8T, 1.4-1.6-1.8-2.0 16V, 1.4-1.6-2.0 FSI motorok



1461/C18B Ft 179.400 1 014610182
310x290x120 mm 2,5 kg

1461/C20G

Szerszámkészlet vezérlés beállításához Fiat Iveco/Peugeot/Citroën/Ford dízelmotoroknál

2.2-2.3-3.0 Multijet motorok



1461/C20G Ft 315.800 1 014610221
385x290x100 mm 5,5 kg

1461/C21G

Szerszámkészlet vezérlés beállításához
Renault dízelmotornál
Motor: 1.6 dCi



1461/C21G Ft 184.900 1 014610222
310x290x120 mm 3 kg

1461/C23B

Szerszámkészlet vezérlés beállításához Opel
benzinmotornál
Motor: 1.0 - 1.2 - 1.4 Ecoflex



1461/C23B Ft 222.300 1 014610224
280x245x75 mm 2,5 kg

1461/C24B

Szerszámkészlet vezérlés beállításához Mini-
Peugeot/Citroën benzinmotornál

Motor: 1.4 - 1.6 (N12-N14)



1461/C24B Ft 277.900 1 014610225
280x245x75 mm 2,8 kg

1461/C25G

Szerszámkészlet vezérlés beállításához Mini
dízelmotoroknál
Motor: 1.6 dízel (W16D)



1461/C25G Ft 61.350 1 014610226
270x120x45 mm 1 kg

1461/C27G

Szerszámkészlet vezérlés beállításához BMW
dízelmotoroknál
Motor: 1.6-2.0D (N47-N47S)



1461/C27G Ft 113.400 1 014610228
280x245x75 mm 2 kg

1461/C28B

Szerszámkészlet a benzines Volkswagen,
Seat, Skoda motorok vezérlésének
beállításához
motorok: 1.0 - 1.0 Bluemotion Tech
1.0 Ecofuel/Ecomotive - 1.0 Green Tech



1461/C28B Ft 197.500 1 014610229
280x245x75 mm 1,7 kg

 **Beta**
Quality Tools

1461/C29B

Szerszámkészlet a benzines Ford motorok
vezérlésének beállításához
motorok: 1.0 EcoBoost



1461/C29B Ft 285.500 1 014610209
280x245x75 mm 2,6 kg

1461/C30G

Szerszámkészlet vezérlés beállításához
Volkswagen/Audi/Seat és Skoda Diesel
motoroknál
motorok: 1.6-2.0 CR TDI
2012 után gyártott motoroknál



1461/C30G Ft 247.500 1 014610231
280x245x75 mm 2 kg

1461/C32G

vezérlés beállító szerzámkészlet dízel Opel
motorokhoz
Motor típusok: 1.6 CDTi (B16)



1461/C32G Ft 133.200 1 014610233
270x230x80 mm 1,3 kg

 **Beta**
Quality Tools

1461/C33B

vezérlés beállító szerszámkészlet benzines Opel motorokhoz

Motor típusok: 1.0 - 1.0 Turbo SIDI Ecoflex



1461/C33B Ft 43.800 1 014610234

1462CF/C6

6 darabos nyitott sokszögkulcs készlet üzemanyag befecskendező csatlakozókhoz

méreték:
12-14-16-17-18-19 mm

12"



1462CF/C6 Ft 38.650 1 014620006

260x145x60 mm - 1,2 kg

1462CF

nyitott sokszögkulcs üzemanyag befecskendező csatlakozókhoz

12"



mm	Ft	1	014620012
12	6.130	1	014620012
14	6.200	1	014620014
16	6.460	1	014620016
17	6.450	1	014620017
19	6.710	1	014620019
18	6.690	1	014620018

1462CF-SN/C6

6 darabos nyitott, csuklós hatlapú dugókulcs készlet üzemanyag befecskendező csatlakozókhoz

méreték:
12-14-16-17-18-19

3/8"



1462CF-SN/C6 Ft 62.000 1 014620026

275x182x64 mm

1462CF-SN

nyitott, csuklós hatlapú dugókulcs üzemanyag befecskendező csatlakozókhoz

3/8"



mm	Ft	1	014620032
12	9.750	1	014620032
14	9.890	1	014620034
16	10.400	1	014620036
17	10.700	1	014620037
18	11.100	1	014620038
19	11.250	1	014620039

1462/KD

szerszámkészlet Denso befecskendezők kihúzásához, csúszókalapáccsal



1462/KD Ft 338.200 1 014620060

335x210x80 mm - 4,8 kg

1462/KI

Dízel porlasztócsúcs kiszedő szerszámkészlet Common-Rail rendszerhez

DELPHI-BOSCH-SIEMENS-DENSO porlasztócsúcs kiszedéséhez



1462/KI Ft 1.008.100 1 014620235

530x470x140 mm - 2,0 kg

1462/KMRC

szerszámkészlet a következő motoroknál a befecskendezők kihúzásához: Mercedes 2.1 L, 2.2 L, 3.0 V6 és Chrysler

Bosch (2.1 és 2.2 L) és Delphi (3.0) befecskendezőkhöz A befecskendezők a motor kivétele nélkül eltávolíthatók. Különösen ajánlott a következő modellekhez: Mercedes Vito, Vario, CLK, Sprinter, Viano, Classe M, GL, C, GLK, E, CLS, S, R, G Chrysler 300 C



1462/KMRC Ft 283.500 1 014620070

310x300x118 mm - 3,5 kg

1462/KU

univerzális szerszámkészlet common rail diesel befecskendezők kihúzásához

fogóval és csúszókalapáccsal



1462/KU Ft 298.000 1 014620100

390x290x100 mm - 4,5 kg

1462/MB

csúszókalapácsos injektor kihúzó készlet

Készlet tartalma:

- 1 db 4 kg-os csúszókalapács, hossz: 400 mm
- 1 db csuklós adapter, csavar M10x1.5, anya M22x1.5 mm
- 1 db adapter, csavar M22x1.5, anya M13x1.4 mm
- 1 db adapter, csavar M14x1.5, anya M27x1 mm
- 1 db adapter, csavar M14x1.5, csavar M25x1 mm
- 1 db adapter, csavar M14x1.5, csavar M27x1 mm
- 1 db adapter, csavar M14x1.5, anya M14x1.5 mm
- 1 db adapter, csavar M14x1.5, csavar M20x1 mm
- 1 db adapter, csavar M14x1.5, csavar M17x1 mm



1462/MB Ft 111.600 1 014620110

500x250x80 mm - 7,2 kg

1462AD/BSC

adapter a Bosch Common Rail befecskendezők kihúzásához

a Beta 960KI és Beta 1462/KU cikkekhez használható



1462AD/BSC Ft 86.250 1 014620435

1462AD/SMN

adapter készlet
Siemens és Denso befecskendezők
kihúzásához

a Beta 960KI/1462KI cikkekhez használható



1462AD/SMN Ft 129.300 1 014620436

1462/EI

univerzális vibrációs injektor kihúzó szerszám

- A hengerfej és az injektorok sérülése nélkül segíti a beragadt injektorok eltávolítását a foglalatból.
- Bármilyen injektor kihúzó készlettel használható, csúszókalapáccsal vagy anélkül.
- A szerszám rezgése közvetlenül a injektorra csatlakoztatott kihúzóúdra hat.
- A rezgés intenzitása a szabályozószeleppel állítható az adott munkának megfelelően.

CE



1462/EI Ft 364.500 1 014620240

1462PIM

lap pár
befecskendező karbantartáshoz
satus rögzítés
keresztmetszet:
Ø 11-12-13-14-16-19-20 mm



1462PIM Ft 41.600 1 014620502

1463/KIT

Szerszámkészlet a
vezérműtengely-bordás szij
rögzítéséhez



1463/KIT Ft 157.800 1 014630001

280x140x75 mm - 1,2 kg

1464T

Digitális teszter nyomás és kompresszió
méréséhez



A 960AD/TP2 készlettel együtt a következő ellenőrzéseket teszi lehetővé:

- benzines és diesel motor kompresszió
- motorolaj nyomás
- common rail alacsony nyomás
- benzinbefecskendezési nyomás

A 1464AP készlettel együtt a következő ellenőrzéseket teszi lehetővé:

- common rail rendszer valós nyomás
- nagynyomású szivattyú nyomás

JELLEMZŐK

- 5" érintőképernyő kijelző
- tölthető polimer-lítium akkumulátor
- 80 báros érzékelővel (alacsony nyomás) és USB kábellel szállítva

1464T Ft 354.100 1 014640050

1464T/SP80

nyomásérzékelő, 80 bar,
a 1464T és 960TP termékhez



1464T/SP80 Ft 112.500 1 014640053

960AD/TP2

Adapterkészlet 960TP-hez
műanyag kofferban



960AD/TP2 Ft 208.900 1 009600510

430x310x50 mm - 3,2 kg

1464CBD

teljes körű adapterkészlet diesel- és
benzinmotorok kompresszióméréséhez
az 1464T teszterhez

Lehetővé teszi a motorhoz történő csatlakozást a
dieselmotorok kompresszió ellenőrzéséhez a 1464T digitális
teszter részére

Tartalom:

- 8 próba gyújtógyertya visszacsapószeleppel
- 44 próba izzógyertya visszacsapószeleppel
- 1 állítható próba befecskendező személygépjárművekhez, kamionokhoz, hajómotorokhoz és mezőgazdasági gépekhez
- 1 90° adapter, nyomáscsökkentő szelep és csatlakozótömlő
- a 1464T teszternek fenntartott hely



1464CBD Ft 300.900 1 014640300

510x410x140 mm - 5,5 kg

1464IC

próba befecskendezőkből és áll
izzógyertyákból álló készlet a 1464T-hez

Lehetővé teszi a motorhoz történő csatlakozást a dieselmotorok
kompresszió ellenőrzéséhez a 1464T digitális teszter részére.

Tartalom:

- 22 próba izzógyertya
- 5 próba befecskendező
- 1 univerzális próba befecskendező személygépjárművekhez, kamionokhoz, hajómotorokhoz és mezőgazdasági gépekhez



1464IC Ft 235.700 1 014640350

559x312x50 mm - 4,5 kg

1464IC/RK

univerzális próba befecskendező készlet személygépjárművekhez, kamionokhoz, hajómotorokhoz és mezőgazdasági gépekhez

a 1464IC modellel együtt szállítva



1464IC/RK Ft 77.300 1 014640377

200x110x30 mm - 885 g

1464AP

Kiegészítő a 1464T teszterhez. Készlet a common rail dieselmotorok nagynyomású rendszerének vizsgálatához

A következőket tartalmazza:

- nagynyomású cső készlet
- csatlakozók
- 2.000 báros érzékelő



1464AP Ft 319.900 1 014640450

430x310x50 mm - 1,8 kg

1464APT

nagynyomású cső a 1464AP és 960TAP modellhez



1464AP T12X12 Ft 25.150 1 014640453
1464AP T12X14 Ft 25.150 1 014640454
1464AP T14X12-M1,0 Ft 25.150 1 014640455

1464AP T16X12



1464AP T16X12 Ft 31.750 1 014640456

1464FG

Kiegészítő a 1464T teszterhez és a 1464AP készlethez.

Hamis szabályozó egység készlet common rail diesel rendszer ellenőrzéséhez

A megfelelő teszterrel és adapterekkel használva lehetővé teszi annak megállapítását, hogy a probléma a magas nyomású szivattyúból, vagy a szabályozóból származik, ha a common rail diesel motorok magas nyomású rendszerében nem elégséges a nyomás.

Bosch, Delphi, Denso és Siemens nyomásszabályozókhoz javasolt



1464FG Ft 134.500 1 014640470

350x250x80 mm - 1,8 kg

1464FG/CP4

próba szabályozó Bosch CP4 szivattyúhoz, a 1464FG modellhez külön kapható



1464FG/CP4 Ft 20.000 1 014640475

1464APB

Kiegészítő a 1464T teszterhez. Az FSI motorok nagynyomású benzines rendszerének vizsgálatára szolgáló készlet

egy 200 báros érzékelőt és csatlakozó elemeket tartalmaz



1464APB Ft 156.000 1 014640500

240x210x50 mm - 0,5 kg

1464PB

Kiegészítő a 1464T teszterhez. 9 csatlakozós készlet az alacsony üzemanyag nyomás ellenőrzéséhez

A 1464T teszterhez csatlakoztatott gyorscsatlakozókon keresztül gyorsan elvégezhető a diesel és benzines motoroknál az alacsony üzemanyag nyomás ellenőrzése.



1464PB Ft 235.500 1 014640700

530x440x120 mm - 3,8 kg

1464ADB

készlet AdBlue® rendszernyomás ellenőrzésére a 1464T egységhez

A 1464T modellel szállított 80 báros szabvány érzékelőhöz szükséges adapterekkel szállítva



1464ADB Ft 39.800 1 014640620

240x210x50 mm - 0,5 kg

1464FAP

gázolaj részecskeszűrő (DPF) nyomás ellenőrző készlet a 1464T egységhez

Tartozékok:

- 500 mbar érzékelő
- 8 mm adapter gyorscsatlakozóval és T-szerelvénnyel
- 3 m hosszú RJ45 kábel



MŰSZAKI ADATOK
Nyomásmérés: 0÷500 mbar
Lépték: 1 mbar

1464FAP Ft 86.150 1 014640610

240x210x50 mm - 0,5 kg

1464PT

Turbónyomás ellenőrző készlet,
a 1464T egységhez

érzékelőt és
csatlakozó kábelt tartalmaz



1464PT Ft 67.950 1 014640550
240x210x50 mm - 380 g

1464TDI

A TDI motorok
szivattyúnyomását
ellenőrző készlet,
a 1464T egységhez

csatlakozó elemet
tartalmaz



1464TDI Ft 48.500 1 014640600
240x210x50 mm - 400 g

1464VD

Vákuum teszter készlet
a 1464T egységhez

A maximális vákuum érték méréséhez és tárolásához
Tartozékok:

- 800 mbaros érzékelő
- 6 és 8 mm-es adapterek
- 3-m hosszú RJ45 kábel

MŰSZAKI ADATOK
Vákuum teszt: 0+800 mbar
Lépték: 1 mbar
Maximum érték tárolása



1464VD Ft 86.150 1 014640570
240x210x50 mm

1464PF

fékrendszer nyomást ellenőrző készlet a
1464T egységhez

Adaptereket és csatlakozókat
tartalmaz



1464PF Ft 280.500 1 014640650
400x280x60 mm - 3 kg

1465

motor hatáskmérő

A berendezést a jármű akkumulátorára kötve a célszoftverrel az
endoterm motor kompresszió másodperceken belül ellenőrizhető a
motorhoz csatlakoztatás nélkül

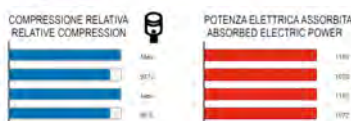

1. lépés: motor fordulatszám kalkuláció
 2. lépés: akkumulátor feszültségváltozásának ellenőrzése az egyes fordulatok alatt
 3. lépés: az önindító működéséből kiszámított elnyelt erő és a kompresszió hengerenkénti megjelenítése
 4. lépés: akkumulátor töltés és teljesítmény ellenőrzése
- MŰSZAKI ADATOK
Üzemi feszültség: 12V DC (akkumulátor)
Méretek: 140x75x30 mm
Kapcsos kábel hossza: 1300 mm
Súly: 215 g

1465 Ft 615.000 1 014650010

1466/C5

5 kulcsos készlet
fék légtelenítéshez

- a készlet a következőket tartalmazza:
- 5 kulcs 7-8-9-10-11 mm méret
 - 1 leeresztő cső visszacsapó szeleppel



1466/C5 Ft 50.650 1 014660100
260x170x50 mm - 600 g

1466L 11

fékolaj leeresztő kulcs, 11 mm
hosszabbított kivitel



1466L 11 Ft 16.800 1 014660211
11 mm L 60 mm

1466TLF

fékolaj leeresztő tartály
űrtartalom: 1,5 l

Gyorscsatlakozó a leeresztő csőhöz Ø 5.5 mm



1466TLF Ft 23.850 1 014660201

1467

Fékfolyadékleszívó



Min.nyomás: 5 bar - Max. nyomás 11,5 bar

1467 Ft 137.400 1 014670001
1,5 l

1467/RK1

pótcső készlet az 1467 készülékhez



1467/RK1	Ft 10.300	1	014670501
----------	--------------	---	-----------

1467/RK2

pótbetöltő az 1467 készülékhez



1467/RK2	Ft 40.200	1	014670502
----------	--------------	---	-----------

1467LF/2

elektromos fékfolyadékcsereelő készülék

„pulzáló” funkcióval



- A készülék automatikusan zár, ha a tartályban nincs fékfolyadék, így megakadályozza a levegősödést
- A tartály maximális űrtartalma: 20 l
- Üzemi nyomás: 0,4+3,5 bar
- Tápellátás: 230V
- Tartozékok:
 - Fékolaj leeresztő tartály
 - 1 E20 standard dugó

1467LF/2	Ft 861.200	1	014670099
----------	---------------	---	-----------

1467LF/RC

tartály gyűjtőcsővel az 1467/LF készülékhez



1467LF RC	Ft 38.200	1	014670125
-----------	--------------	---	-----------

1467TU

Záróelem fékfolyadék tartályokhoz

- a tartályok 90%-hoz alkalmazható
- a 1467LF cikkszámú Beta termékhez



1467TU	Ft 29.550	1	014670090
--------	--------------	---	-----------

1467T/C6

záróelem adapter készlet fékfolyadéktartályokhoz, a BETA 1467LF és 1467LF/2 modellhez

Készlet tartalma:

- 1 adapter Toyota gépjárművekhez
- 1 adapter Ford, Hyundai, Mazda, Mitsubishi, Nissan, Subaru gépjárművekhez
- 1 adapter Honda gépjárművekhez
- 1 adapter Mazda és Suzuki gépjárművekhez
- 1 adapter Nissan gépjárművekhez
- 1 fékfolyadék kieresztő adapter európai gépjárművekhez



1467T/C6	Ft 115.100	1	014670080
----------	---------------	---	-----------

350x240x85 mm - 1,8 kg

1468N

Szeleptányér lenyomó készülék

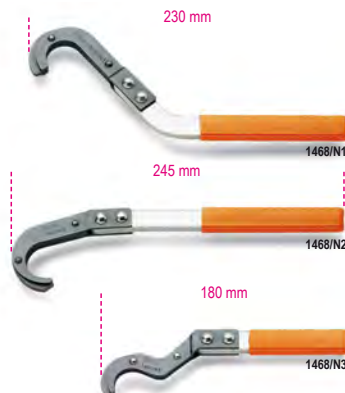

1468N/1	Ft 10.050	1	014680011
1468N/2	Ft 10.100	1	014680012
1468N/3	Ft 10.100	1	014680013

1470

Dobfékrugófó, nikkelezett



L mm	Ft	1	014700001
210	15.850	1	014700002
330	20.700	1	014700010
540	62.900	1	014700010

1470FT

Dobfékrugófó

Pofa 40° -ban hajlított
Nehezen hozzáférhető helyekre



L mm	Ft	1	014700000
184	16.900	1	014700000

1470PF

Dobfék fékmunkahenger szerelő szerszám

a pófák nyitva maradnak, így könnyű a munkahenger cseréje



A mm	Ft	1	014700200
25÷140	34.000	1	014700200

1471

Dobfékrugófó, nikkelezett, PVC-bevonatú szárral



L mm	Ft	1	014710001
330	31.250	1	014710001

1471A

Kézifékhozal fogó, barnított, PVC-bevonatú szárral



A max mm	B mm	Ft	2	014710010
45	5	37.750	2	014710010

1471GF

hajlítható horog pár a féknyereg megtartásához fékbetét csere közben



1471GF	Max kg 5	Ft 4.990	1	014710310
--------	-------------	-------------	---	-----------

1471M/C22

Levegős tárcsafékdugattyú szerelő szerszám, jobb és balmenetes, tartozékkal



1471M/C22	Ft 119.100	1	014710101
350x310x85 mm - 3,5 kg			

1471M/50

Levegős fékdugattyú szerelő készülék, jobb és balmenetes

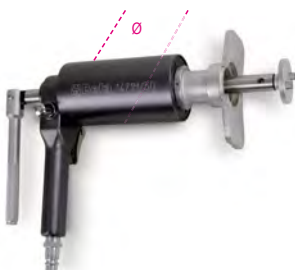

Ø 50	Kg 150	Bar 5÷8	Ft 68.500	1	014710069
---------	-----------	------------	--------------	---	-----------

1471M/P

Fékszerelő adapter TRW-Mégane-hoz



1471M/P	Ft 10.400	1	014710080
---------	--------------	---	-----------

1471M/W50

Fékszerelő adapter VW Passat 2005 utáni évjáratához



1471M/W50	Ft 3.630	1	014710079
-----------	-------------	---	-----------

1471PN/B1

Fékszerelő adapter Ford-hoz



1471PN/B1	Ft 3.630	1	014710081
-----------	-------------	---	-----------

1471PN/B2

Fékszerelő adapter Daily-hoz



1471PN/B2	Ft 5.120	1	014710082
-----------	-------------	---	-----------

1471PN/B3

Fékszerelő adapter BMW-hoz



1471PN/B3	Ft 3.790	1	014710083
-----------	-------------	---	-----------

1471PN/B4

Fékszerelő adapter BMW-hoz



1471PN/B4	Ft 3.790	1	014710084
-----------	-------------	---	-----------

1471PN/B5

Fékszerelő adapter Mini/ BMW-hez



1471PN/B5	Ft 3.160	1	014710085
-----------	-------------	---	-----------

1471CF

Ötszögű dugókulcs fékszereléshez



mm	Ft	1	014710314
14	6.920	1	014710319
19	6.920	1	014710319

1471CM

Ötszögű dugókulcs fékszereléshez



mm	Ft	1	014710360
10	6.920	1	014710360

1471CM/E11

Hattlapú dugókulcs, 11 mm, Mercedes ML (széria 166) fékszereléshez



mm	Ø	L	L1	Ft	1	014710361
11	24	75	15,5	7.380	1	014710361

1471PT/C5

gépi dugókulcs készlet fékhez

a Volkswagen, Audi és Porsche csoport járműveihez
• 3 db 10 szögű dugókulcs: 11,5 mm - 15 mm - 20 mm
• 2 db 7 szögű dugókulcs: Ø 14 mm - 22 mm



1471PT/C5	Ft 34.450	1	014710367
-----------	--------------	---	-----------

1471D2

első tárcsafék fék munkahenger visszanyomó zárt fékbetéteknél

két talppár a 2 és 4 dugattyús fék munkahengereken végzett műveletekhez



mm 10 Ft 32.000 1 014710301

250x170x60 mm 1,5 kg

1471T/C5

5 ütőkulcs kamion féknyereghez

nyomatékkulcsokkal használható megszorításhoz

méret:

- E18, E20, E24 Torx dugókulcs
- M24, M26 csillagkulcs



1471T/C5 Ft 99.300 1 014710400

275x220x60 mm - 3,1 kg

1472

Tömlőbilincsfogó, nikkelezett



1472 Ft 17.800 1 014720001

1472AU

Önzáró tömlőbilincsfogó, barnított, PVC-bevonatú szárral



mm 18-53 Ft 54.200 1 014720100

1472R/AU

póthegek az 1472AU fogóhoz



1472AU/R Ft 20.250 1 014720101

1472AU/P

Automata tömlőbilincsfogó hosszított, barnított, PVC-bevonatú zárral



mm 18-54 L mm 630 Ft 40.100 1 014720105

1472AU/RP

póthuzal az 1472AU/P fogóhoz



1472AUP/R Ft 11.300 1 014720106

1472B/RNLT

kettős beosztású dugókulcs, kifejezetten Renault motorokon alkalmazott szívócső bilincsekhez



1472B/RNLT Ft 5.560 1 014720250

1472FC

Rugós bilincsfogó



1472FC Ft 16.450 1 014720090

1472FC/GE

nagyhatású fogó Clic(R) bilincsekhez

különösen javasolt nagyméretű bilincsekhez



L mm 230 Ft 32.450 1 014720093

1472FC/L

360°-ban állítható fejú fogó flexibilis hosszabbítóval, Clic® bilincsekhez



L mm 630 Ft 45.750 1 014720095

1472FCL/RP

póthuzal az 1472FC/L fogóhoz



1472FCL/RP Ft 20.050 1 014720096

1472FCA

Visa® típusú tömlőbilincs eltávolító fogó



1472FCA Ft 24.600 1 014720041

1472H

Henn csatlakozó
eltávolító eszköz



1472H	L mm 100	Ft 9.570	1	014720000
-------	----------------	-------------	---	-----------

1472MT/VW

szívócsonk leválasztó tűske pár
VAG modellekhez

1.0 - 1.2 - 1.4 turbófeltöltős benzinmotorokon is használható.



1472MT/VW	Ft 5.570	1	014720500
-----------	-------------	---	-----------

1472TM

Tömlőbilincsfogó Multijet-szűrőhöz



1472TM	Ft 11.600	1	014720200
--------	--------------	---	-----------

1472VW

Önzáró tömlőbilincsfogó

Volkswagen és Mercedes



1472VW	Ft 18.950	1	014720051
--------	--------------	---	-----------

1473

OETIKER® bilincsfogó barnított,
PVC-bevonatú szárral



1473 275	Ft 43.900	1	014730001
----------	--------------	---	-----------

1473A

OETIKER® szemesbilincs
összehúzó fogó, barnított,
PVC-bevonatú szárral



1473A	Ft 39.600	1	014730010
-------	--------------	---	-----------

1473P

OETIKER® bilincsfogó
alacsony profilus



1473P	A Max mm 53	Ft 12.750	1	014730020
-------	-------------------	--------------	---	-----------

1473FN

Bilincs összehúzó és vágó szerszám nemes
acélból

Használható Panduit®-tal és ehhez hasonló bilincscsel



A mm 4,7÷9,5	Ft 26.550	1	014730501
-----------------	--------------	---	-----------

1473T

acélbilincs
eltávolító csípőfogó
lehetővé teszi a bilincsek elvágását
a védőharangok, csatlakozók stb. károsításának veszélye
nélkül



A Max mm 14	L mm 220	Ft 23.950	1	014730582
-------------------	----------------	--------------	---	-----------

1474/C4

4 darabos Volkswagen gyertyakiszedő készlet



1474/C4	Ft 41.200	1	014740100
---------	--------------	---	-----------

290x190x50 mm - 1 kg

1474E/VW

expanziós gyújtótekercs kihúzó
Volkswagen csoport



1474E/VW	Ft 10.650	1	014740120
----------	--------------	---	-----------

1474E/VW2

gyújtótekercs kiszedő
a VAG csoport járműveihez
1.0 - 1.2 - 1.4 - 2.0 motorokhoz



1474E/VW2	Ft 15.800	1	014740150
-----------	--------------	---	-----------

1474L

Gyertyakiszedő fogó, 15°-os hajlított pófával, hosszított kivitel, krómozott, PVC-bevonatú szárral

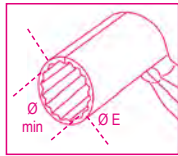

Ø min mm	Ø E mm	Ft		
14	20	32.700	2	014740010

1474DL

Hosszú gyertyakiszedő fogó, PVC-bevonattal

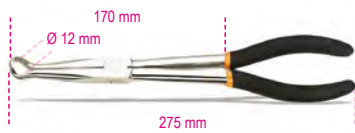

1474DL	Ft		
	15.400	1	014740015

1474G

hosszú hajlított csőrű fogó izzítógyertya sapkához



1474G	Ft		
	17.800	1	014740200

1475U

Kombinált fogó, krómozott, polírozott, PVC-bevonatú hajlított szárral

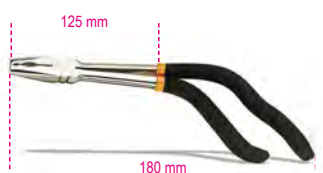

1475U	Ft		
	15.950	1	014750010

1476

Állítható kipufogócsővágó fogó, krómozott



Ø min mm	Ø max mm	L mm	Ft	
19	75	225	32.350	1 014760002

1476/RC

Tartalék vágólánc az 1476 típusú fogóhoz



1476/RC	Ft		
	17.100	1	014760012

1476A

Kipufogócsővágó fogó, PVC-bevonatú szárral



Ø min mm	Ø max mm	Ft	
30	95	41.250	1 014760005

1476A/RC

Tartalék vágólánc az 1476A típusú fogóhoz



1476A/RC	Ft		
	35.700	1	014760015

1476C/1

Kipufogócső tágitó szerszám



1476C/1	Ft		
Ø 30=42 mm L = 131 mm L1 = 51 mm	15.100	1	014760101

1476GT

fogó gumi tartóbetétek eltávolításához kipufogó csöveknél



L mm	A Max mm	S mm	Ft	
280	58	3	13.800	1 014760050

1476PSA

fogó kipufogó rögzítő csapos bilincshez, PSA csoport a csőrök formája és az automatikus fogasléc rögzítés lehetővé teszi a műveletet a csap kihúzása nélkül



L mm	A Max mm	S mm	Ft	
309	60	12,2	16.250	1 014760060

1476T

Dízelmotorturbina szerelő kulcs, Volkswagen Audi

Praktikus és gyors szerelést biztosít



Ø mm	Ft		
12	15.350	1	014760200

1477/C10

9 darabos sarokcsillagkulcs készlet ékszíjtárcsaanyához

1 sarokcsillagkulcs betéttartóval
4 dupla tizenkétszögű betét: 12x14 - 13x15 - 16x17 - 18x19 mm
5 betét Torx®-csavarokhoz: E10 - E12 - E14 - E16 - E18



1477/C10	Ft		
530x110x55 mm	65.850	1	014770310

1477D

Sarokcsillagkulcs ékszijtárcaanyához



mm	Ft	db	014770113
13	11.700	1	014770113
15	11.700	1	014770115
16	11.700	1	014770116
17	11.700	1	014770117
19	11.700	1	014770119

1477D/S5

5 darabos sarokcsillagkulcs készlet ékszijtárcaanyához



1477D/S5	Ft	db	014770200
13-15-16-17-19 mm	58.500	1	014770200

600x200x70 mm - 2,2 kg

1477K/7

Sarokcsillagkulcs-készlet átváltós racsnival és betétekkel



- 2 TORX-betét T40-T45
- 1 XZN 10-betét
- 1 hatlapú betét 8 mm
- 3 tizenkétszögű betét 10-12-13 mm

1477K/7	L mm	Ft	db	014770051
	250	59.850	1	014770051

1478

Áttételes kárpitpatent kisedő fogó, krómozott, PVC-bevonatú szárral



1478	Ft	db	014780001
	23.450	1	014780001

1478NSS

3 kioldópontos műanyag csap fogó



L mm	Ft	db	014780163
180	15.800	1	014780163

1478T

állítható fejű fogó műanyag nyomáscsipesz csapokhoz

90°-ban állítható fej



1478T	S mm	Ft	db	014780101
	4,5	17.950	1	014780101

1478/3P

3 kioldópontos műanyag csap fogó



1478/3P	Ft	db	014780151
	25.600	1	014780151

1478/K3

csap kisedő fogó készlet műanyag csapokkal

készlet tartalma:

- 1 db laposfogó
- 1 db 90°-ban hajlított fogó
- 625 db műanyag kapocs 16 különböző méretben
- kapcsok 3 db rakatolható PPL tárolóban



1478/K3	L mm	L1 mm	Ft	db	014780160
	180	170	41.650	1	014780160

1479

Kárpitpatent kisedő, krómozott, műanyag szárral

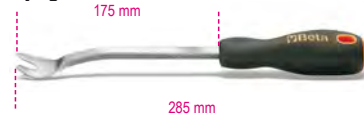

1479	Ft	db	014790001
	9.470	2	014790001

1479/B27

27 darabos nylon szerszámkészlet kárpitpatentekhez, és műanyagokon és tömítéseken történő munkavégzéshez felfüggeszhető tartóban



1479/B27	Ft	db	014790407
	31.550	1	014790407

1479LB/C5

5 darabos fém kárpitpatent kisedő készlet



1479LB/C5	Ft	db	014790150
	48.100	1	014790150

215x165x50 mm

1479L/S2

Teflon® multifunkciós kar pár



1479L/S2	Ft	db	014790510
	12.050	1	014790510

1479LV/S3

3 darabos multifunkciós bontórúd készlet, fém

méretek:

1479LV/1: 10x12 mm
1479LV/2: 4,8x9,6 mm
1479LV/3: 2,8x6 mm



1479LV/S3 Ft 13.450 1 014790100

1479L/K4

4 darabos bontórúd készlet műszerfalhoz és kényes alkatrészekhez



1479L/K4 Ft 13.100 1 014790604

1479ML/B17

17 darabos multifunkciós bontórúd készlet, műanyag

különösen aprólékos munkákhoz ajánlott



1479ML/B17 Ft 30.000 1 014790700

1479ML/S3

3 darabos multifunkciós bontórúd készlet, műanyag

Különösen aprólékos munkákhoz ajánlott



1479ML/S3 Ft 5.360 1 014790603

1479N/S5

5 darabos műanyag patentkiszedő készlet



1479N/S5 Ft 16.300 1 014790251

1479RB/1

Egyenes kárpitpatent kiszedő szerszám



1479RB/1 Ft 11.300 1 014790315

1479RB/2

Hajlított kárpitpatent kiszedő szerszám



1479RB/2 Ft 11.300 1 014790320

1479RB/3

Egyenes széles kárpitpatent kiszedő szerszám



1479RB/3 Ft 12.850 1 014790310

1479U/13

Kárpitpatent kiszedő szerszám, villa nemes acélból



1479U/13 Ft 9.820 2 014790010

1479U/32

Kárpitpatent kiszedő szerszám, villa nemes acélból



1479U/32 Ft 11.550 2 014790015

1480

gázolajszűrő feltöltő készlet elektromos szivattyú nélküli autókhoz

• Gumibroncsfűjő pisztollyal is használható

A készlet az alábbiakat tartalmazza:

- GM gyorscsatlakozók
- Renault, GM, Fiat 6 mm belső Ø gyorscsatlakozók
- Renault, GM, Fiat 7 mm belső Ø gyorscsatlakozók
- Ford gyorscsatlakozók
- PSA 6 mm belső Ø gyorscsatlakozók
- PSA 7 mm belső Ø gyorscsatlakozók
- Ford gyorscsatlakozók
- 2 kúpos adapter gyorscsatlakozó nélküli gépkocsikhoz



1480 Ft 155.800 1 014800010

410x320x70 mm

1481/C12

6 darab tömlőzáró fogó

A készlet áll:

- 2 különböző fogó 1/4"
- 2 különböző fogó 3/8"
- 2 különböző fogó 5/16"
- 6 darab rögzítő gumipánt



1481/C12 Ft 49.650 1 014810312

370x270x59 mm

1481K/S4

4 db önzáró csatlakozó
csövek lezárásához
méretek:
5/16" - 3/8" - 1/2" és hurok



1481K/S4	Ft 13.050	1	014810400
----------	--------------	---	-----------

1481PL/A

Tömlőzáró fogó

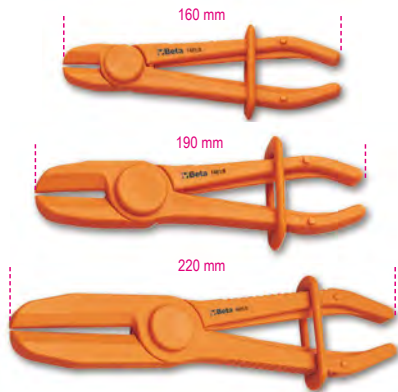

	Ø mm	Ft		
1481PL/A	8÷15	7.900	3	014810110
1481PL/B	15÷25	8.930	3	014810120
1481PL/C	25÷45	12.350	3	014810130

1481PL/S3

3 darabos tömlőzáró fogó készlet

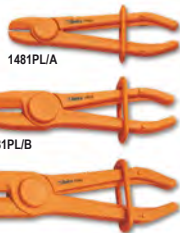

1481PL/S3	Ft 29.200	1	014810200
1481PL-A Ø 8÷15 mm			
1481PL-B Ø 15÷25 mm			
1481PL-C Ø 25÷45 mm			

1481T/C12

üzemanyagcső elzáró dugó

3 pár elzáró dugó gyorscsatlakozóval
üzemanyagcső lezárására



1481T/C12	Ft 51.100	1	014810212
-----------	--------------	---	-----------

≡ 275x220x45 mm - 540 g

1482

Állítható kulcs az üzemanyagtartály
szereléséhez



Ø mm	Ft		
89÷170	44.650	1	014820001
89÷200	48.500	1	014820002

1482A/1

3 lábás kulcs alumíniumból készült
üzemanyag tartály úszó gyűrűhöz

a 2011 óta a Fiat, Volkswagen, Opel, Chevrolet, Mercedes és
BMW csoportnál alkalmazott alumínium gyűrűk szereléséhez



Ø mm	Ft		
185	31.600	1	014820005

1482A/3

kulcs a PSA csoportnál használt
üzemanyag tartály úszó gyűrűhöz

a kialakítás lehetővé teszi a decentralizált tengely
segítségével történő gyűrű eltávolítást, a kényes úszó
sérülése nélkül



Ø mm	Ft		
157	36.100	1	014820007

1482A/5

üzemanyagtartály úszó rögzítőgyűrű
kulcs, 22 körcikkes

a VAG csoport gépkocsijaiba szerelt
műanyag gyűrűnél alkalmazható



Ø mm	Ft		
180	27.600	1	014820015

1482/8 - 1482/10

Benzincső lehúzó fogó, barnított,
PVC-bevonatú szárral



	Ø mm	Ft		
1482/8	8	15.750	2	014820008
1482/10	10	15.750	2	014820010

1482B

Benzincső lehúzó fogó



1482B	Ft 17.600	1	014820021
-------	--------------	---	-----------

1482SN

benzincső lehúzó fogó
csuklós pófával



L mm	Ft		
260	20.250	1	014820110

Beta

1482C

2 pár kúp a Fiat, Volkswagen, Jeep, Chrysler és Volvo csoportnál a gázolajszűrő csatlakozó kioldásához

gyors szűrőcsere a csatlakozók helyrehozhatatlan sérülése nélkül



1482C Ft 24.650 1 014820022

1482D

üzemanyagcső lehúzó fogó rugalmas toldalékkal



1482D Ft 41.650 1 014820026

1483K/12

légkondicionáló berendezés szelep kiszerező készlet torx ötszög bitfej sorozattal

A készlet a következőket tartalmazza:
 • 2 db nyolcszögű belső dugókulcs, Ø 12 és 15 mm, nagynyomású szelepekhez
 • 2 db 2,2 és 3,2 mm keresztmetszetű külső villás dugókulcs fojtószelepekhez
 • 1 sorozat torx ötszög bitfej a következő méretben: PT10, PT15, PT20, PT25, PT27, PT30, PT40



1/4"

1/4"



1483K/12 Ft 16.300 1 014830012
 120x80x35 mm

1483KV-PT/S7

ötszög bitfej készlet

méretek: PT10 - PT15 - PT20 - PT25 - PT27 - PT30 - PT40



1/4"



1483KV PT/S7 Ft 4.300 1 014830117

1483K/22

Készlet klímaberendezés karbantartásához



1483K/22 Ft 55.600 1 014830022
 300x230x55 mm - 1 kg

1484

2 darabos szerszámkészlet ékszíj szereléséhez

Gyors és korrekt szerelést biztosít az ékszíj sérülése nélkül



1484 Ft 49.900 1 014840010

1484PSA

Vízszivattyú hajtásíj felhelyező szerszám szíj feszítő nélküli modellekhez

a PSA és Opel csoport járműveire 1.0 - 2.0 motorokhoz



1484PSA Ft 5.650 1 014840012

1485BP

félköríves szerszám fogas ékszíjtárcsák reteszeléséhez

forgatható nyéllel állítható, kívülről szorítja és blokkolja a szíjtárcsát, nem veszélyezteti a környező érzékelőket



1485BP Ft 88.900 1 014850000
 A Max mm 130

1485BPM

félköríves szerszám alumínium befogópórákkal többhornyos ékszíjtárcsák reteszeléséhez

forgatható nyéllel állítható, kívülről szorítja és blokkolja a szíjtárcsát, nem veszélyezteti a környező érzékelőket



1485BPM Ft 90.650 1 014850002
 A Max mm 180

1485FCA/K2

vezérműsúly csapágy előfeszítő szerszám pár FCA csoport

1.2, 1.4 8/16 V és 1.4 Multiair motorokhoz javasolt

- 1 db 175 mm hosszú szerszám 13,5 mm hegyekkel
- 1 db 305 mm hosszú csuklós szerszám 13,5 mm hegyekkel



1485FCA/K2 Ft 47.800 1 014850220

1485FCA/T

csuklós eszköz a vezérműsúly csapágyak előfeszítéséhez az FCA csoport járműveinél



1485FCA/T Ft 17.350 1 014850210
 L mm 175 P mm 13,3

1485FCA/TS

eszköz a vezérműsúly csapágyak előfeszítéséhez az FCA csoport járműveinél



1485FCA/TS Ft 30.450 1 014850215
 L mm 305 P mm 13,5

1485FRD/T

feszítőkar a Ford motorokba szerelt segédhajtás ékszíjakhoz a generátor ékszíjtárcsák eltávolításához használható



1485FRD/T Ft 37.600 1 014850310
 L mm 450 Q mm 12,80

1485MRC/T

feszítőkar Mercedes motorokba szerelt
segédhajtás szijakhoz
M133 - M270 motorokhoz



L mm 510
T55
Ft 14.550
1 014850315

1485VLV/T

feszítőkar Volvo motorokba szerelt
segédhajtás szijakhoz

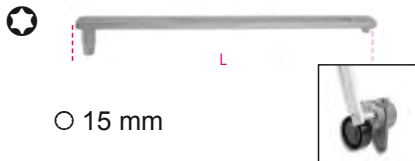

L mm 420
T50-T60
mm 15
Ft 31.150
1 014850320

1485TC

feszítőkar Ford, PSA, FCA motorokba
szerelt segédhajtás szijakhoz



L mm 475
Ft 25.050
1 014850330

1485/KIT

Vezérműszíj feszességmérő készlet



1485/KIT Ft 134.600
1 014850100

230x140x75 mm - 580 g

1485MJ

1.3 16 V Multijet motor vezérműtengely
reteszelő szerszám

2 fej 3 profilal az összes 1.3 16 V Multijet motorhoz
az FCA csoport, Opel, Ford és Suzuki modelleknél

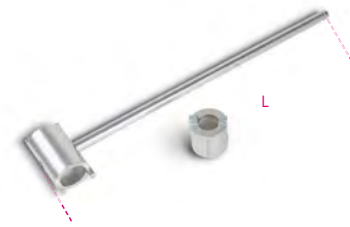

L mm 500
Ft 50.350
1 014850150

1485PMTJ

Multijet motor főtengelytárcsa kioldó kar

kifejezetten olyan geometriai kialakítás,
ami blokkolja a főtengelyt
a tárcsa eltávolítási műveletei közben



L mm 450
Ft 59.500
1 014850190

1485R

Vezérműtengely tárcsa forgató szerszám
kovácsolt acélból
2 pár hegygel szállítva



mm 30-120
mm 10 - 17
L mm 500
Ft 63.450
1 014850025

1485R/P10

Hegyek (párban)



1485R/P10 Ft 6.400
1 014850035

1485R/P17

Hegyek (párban)



1485R/P17 Ft 6.400
1 014850038

1485VAG/K2

vezérműszíj csapágy
előfeszítő szerszám pár

- 3 helyzetbe állítható fej
- 1 szerszám 12,5 mm fejjel
- 1 szerszám 21,5 mm fejjel



1485VAG/K2 Ft 29.650
1 014850080

1485VAG

vezérműszíj csapágy
előfeszítő szerszámok

- 3 állásba fordítható fej



L mm 190
P mm 12,5
Ft 15.500
1 014850062
L mm 195
P mm 21,5
Ft 14.600
1 014850071

1486/10

földgáz palack szelepkulcs

- VW csoport 2008 után
- Panda 2004 és 2012 között
- Grande Punto 2005 és 2012 között
- Ducato 2010 után
- új Doblò és Combo
- Cubo és Fiorino



36 mm

1486/10 Ft 56.450
1 014860110

Beta

1486/20

földgáz palack szelepkulcs

- Multipla
- Ducato 1. és 2. sorozat 2010 előtt
- Berlingo és Ranch
- C3 vas palackokkal
- Punto 1999 és 2010 között
- Dobló 1. orozat
- Daily és Iveco csoport
- Dr5

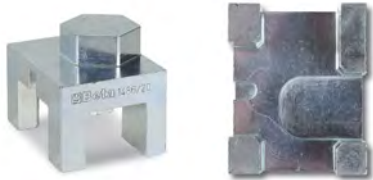

36 mm

1486/20 Ft 56.450 1 014860120

1486/30

földgáz palack szelepkulcs

- Zafira 2. sorozat
- Combo 1. sorozat

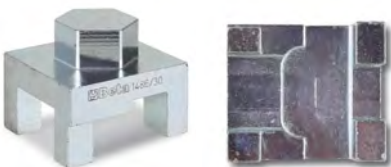

36 mm

1486/30 Ft 56.450 1 014860130

1486/40

földgáz palack szelepkulcs

- Touran 1. sorozat

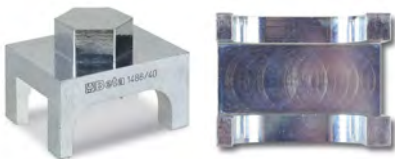

36 mm

1486/40 Ft 56.450 1 014860140

1486/50

földgáz palack szelepkulcs

- Panda 2012 után
- Új Ypsilon



36 mm

1486/50 Ft 56.450 1 014860150

1486/60

földgáz palack szelepkulcs

- C4 Picasso
- BRC berendezések



36 mm

1486/60 Ft 56.450 1 014860160

1486/70

földgáz palack szelepkulcs pár

- C3 kompozit palackokkal



36 mm

1486/70 Ft 100.100 1 014860170

1486/80

földgáz palack szelepkulcs

- B osztály
- Zafira 3. sorozat

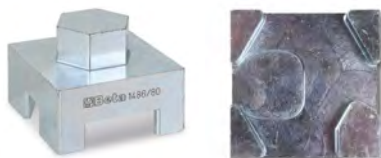

36 mm

1486/80 Ft 56.450 1 014860180

1486/90

földgáz palack szelepkulcs

- Zafira 1. sorozat
- Kangoo 1. sorozat
- Sprinter

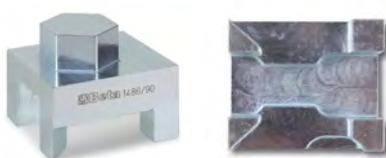

36 mm

1486/90 Ft 56.450 1 014860190

1487/K2

2 dugó hűtő leeresztőszelephez



17 mm

1487/K2 Ft 8.760 1 014870100

1488 - 1488L

Olajsűrűszedő dupla láncsal, krómozott



	Ø mm	Ft		
1488	60÷110	36.550	1	014880001
1488L	60÷160	40.400	1	014880050

1488/1

1/2"-os láncos olajsűrűszedő dugókulcs, krómozott



	Ø mm	Ft		
1488/1	60÷110	42.950	1	014880010

1488R...

pótlánc



		Ft		
1488RC	1488 350	14.550	1	014880101
1488R/L	1488/L 520	22.350	1	014880150
1488RC/1	1488/1	24.400	1	014880110

1489/31T

Ékszíjtárcsakulcs



	T50	15	31	Ft		
1489/31T				15.750	1	014890016

1489/33

Ékszíjtárcsakulcs



		Ft		
1489/33	33	5.900	1	014890010

1489/33P

Ékszíjtárcsulcs Bosch
FIAT Grande Punto



Ø	mm	Ft		
M 10	15	20.000	1	014890015

1489/E

Ékszíjtárcsulcs



Ø	mm	Ft		
10	15	13.350	1	014890025

1489R

Ékszíjtárcsulcs

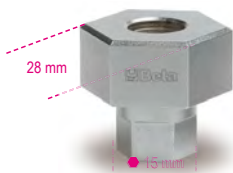

Ø	mm	Ft		
28		6.150	1	014890020

1489/Y

Ékszíjtárcsulcs Nippondenso



Ø	mm	Ft		
32		8.760	1	014890040

1489/C14

14 darabos szerszámkészlet váltóáramú
generátor ékszíjtárcsához



1489/C14	Ft		
	116.900	1	014890100

	867PE	8 mm
	867PE/L	8 mm
	867XZN/L	M10
	867TX/L	T50
	867/2	□1/2"
	920B	10 mm
	1489/33	
	1489/33P	M10
	1489R	
	1489/Y	
	1489/31T	T50
	1489/E	10 mm
	188	10 mm
	188	15 mm

420x250x45 mm - 1,9 kg

1490

Szíjas olajsűrőleszedő,
nikkelezett, PVC-bevonatú nyéllel

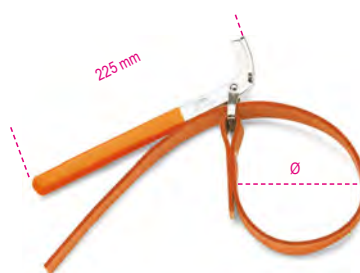

	Ø max	Ft		
1490/1	160	14.800	1	014900001
1490/2	240	15.800	1	014900002

1490/R1 - 1490/R2

textil cseresíj a 1490 modellhez



	Ø mm	Ft		
1490R/1	160	6.930	1	014900101
1490R/2	240	8.380	1	014900102

1490F

szíjas szűrőkulcs



Ø Max	Ft		
200	14.600	1	014900201

1491

Állítható fémszalagos
olajsűrőleszedő, könnyűfémtest



Ø	Ft		
65÷110	16.750	2	014910001

1491R

Tartalékszalag az 1491
típusú olajsűrőleszedőhöz



1491R	Ft		
	3.270	10	014910010

1491A

állítható olajsűrő leszedő

Pontos beállítás a feszítőkerettel



L	Ø min - Max	Ft		
345	55 ÷ 140	17.700	1	014910040

1491T

állítható teherautó olajsűrő leszedő

Pontos beállítás a feszítőkerettel
Szárítósűrőrköz



L	Ø min - Max	Ft		
500	70 ÷ 200	41.250	1	014910050

Beta

1492/1 - 1492/2

Állítható acélpántos
olajszűrőleszedő, nikkelezett,
PVC-bevonatú nyéllal



	Ø mm	Ft	📦	🚚
1492/1	60÷80	18.300	1	014920001
1492/2	80÷110	19.000	1	014920002

1492T

Szűrőleszedő kulcs



	Ø mm	H mm	Ft	📦	🚚
1492T 40	125÷145	40	14.400	1	014920540
1492T 75	120÷140	75	24.450	1	014920575

1493B

sokszögű olajszűrőleszedő kulcs
nehezen hozzáférhető helyekhez



mm	± mm	Ft	📦	🚚
24	8	7.610	1	014930524
27	8	7.880	1	014930527
32	8	8.060	1	014930532
36	8	8.570	1	014930536
38	8	8.790	1	014930538

1493B/S5

5 darabos sokszögű olajszűrő leszedő kulcs
készlet nehezen hozzáférhető helyekhez

méretetek:
24-27-32-36-38 mm



	Ft	📦	🚚
1493B/S5	31.750	1	014930599

1493

Olajszűrőleszedő

12"



Ø mm	N	Ft	📦	🚚
65	14	4.270	1	014930200
68	14	4.270	1	014930206
73	14	4.270	1	014930208
74	14	4.270	1	014930209
74	15	4.270	1	014930210
75-77	15	4.270	1	014930212
76	8	4.270	1	014930214
76	14	4.270	1	014930218
76-74	15	4.520	1	014930220
78	15	4.520	1	014930224
80	15	4.530	1	014930226
82-80	15	4.890	1	014930228
86	16	4.940	1	014930230
90	15	4.940	1	014930234
92	10	4.940	1	014930236
93	15	4.940	1	014930238
95	15	4.940	1	014930244
100	15	5.940	1	014930248
106	15	5.920	1	014930250
108	15	5.920	1	014930252
135	18	9.770	1	014930256

1493/PF

Purflux®-olajszűrőleszedő betét

12"



Ø mm	N	Ft	📦	🚚
66	6	4.270	1	014930202
76	12	4.270	1	014930216
76	30	4.520	1	014930222
86	18	4.940	1	014930232
93	36	4.940	1	014930240
93	45	4.940	1	014930242
96	18	4.940	1	014930246
108	18	6.520	1	014930254



1493/C30

28 darabos olajszűrőleszedő dugókulcskészlet

12"



A készletben található méretek (Ø mm)

1493:

65/14 - 67/14 - 68/14 - 73/14 - 74/15
76/15 - 75/77/15 - 76/14 - 76/8 - 78/15 - 80/15
82/15 - 86/16 - 90/15 - 92/10 - 93/15 - 95/15
100/15 - 106/15 - 108/15

1493PF (Purflux)

66/6 - 76/12 - 76/30 - 86/18

93/36 - 93/45 - 96/18 - 108/18

- 1 állítható univerzális kulcs Ø 65÷120 mm

	Ft	📦	🚚
1493/C30	106.200	1	014930000

530x400x110 mm - 4 kg

1493AL

olajszűrőleszedő dugókulcs

N= oldalak száma

38"

12"

📏



Ø mm	N	●	□	Ft	📦	🚚
64	14	27	1/2"	6.140	1	014930310
66,5	14	27	1/2"	5.380	1	014930315
74	14	27	1/2"	6.650	1	014930320
79	15	27	3/8"	6.140	1	014930325
84	14	27	3/8"	6.650	1	014930330
87	16	27	1/2"	8.470	1	014930335
92	15	27	3/8"	6.890	1	014930340
94,5	15	27	3/8"	6.890	1	014930345
100,5	15	27	3/8"	6.890	1	014930350

1493AL 4S

olajszűrőleszedő dugókulcs ázsiai autókhoz

4 szakaszos profil

38"

📏

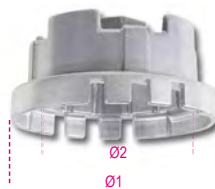

Ø1 mm	Ø2 mm	Ft	📦	🚚	
70	64,5	27	6.650	1	014930304
80	64,5	27	6.140	1	014930305

1493AL CF

olajszűrőleszedő hatlapfejű dugókulcs



Ø mm	H mm	Ft	1	014930424
24	34	4.000	1	014930424
27	34	4.000	1	014930427
30	34	4.000	1	014930430
32,5	34	4.240	1	014930432
36	34	4.240	1	014930436
38	34	4.240	1	014930438

1493/C19

18 darabos olajszűrőleszedő dugókulcskészlet.
különösen ajánlott ázsiai autókhoz

Ø mm	Lapsz.
63-64	14
66,5	14
74	14
79	15
84	14
87	16
92	15
94,5	15
100,5	15
64,5	14 körcikkes Toyota modellekhez
64,5	14 körcikkes Lexus modellekhez
6 db hatlapfejű dugókulcs, méret: 24-27-30-32,5-36-38 mm szűrőbetétekhez	
A készlet tartalmaz 1 állítható univerzális kulcsot Ø 58+93 mm	



1493/C19 Ft 93.450 1 014930019

490x450x60 mm - 4 kg

1493DSG

kulcs a DSG sebességváltó olajszűrő kiszéréséhez/beszéréséhez



Ø mm 24 Ft 14.900 1 014930800

1493FF

Olajszűrőleszedő kulcs
Ford Peugeot Citroën
Motor: TDCI-HDI

25 Nm-es nyomatékkulcs segítségével lehetővé teszi a műanyag korrekt eltávolítását



Ø mm 27 Ft 11.950 1 014930127

1493FT

Ford Transit gázolajszűrő kulcs

Mindegyik 2012 utáni Transit, Transit Custom és Tourneo Custom változathoz használható



Ø mm 115 Ft 9.980 1 014930085

1493J

Olajszűrőleszedő Multijet

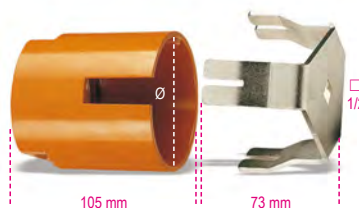

Ø mm 90 Ft 48.700 1 014930080

1493VW

gázolajszűrő leszedő,
VAG és Volvo modellekhez



Ø mm 82,5 Ft 7.340 1 014930086

1493HK

gázolajszűrő kulcs
Hyundai, Kia, 15-lapos



1493HK Ft 9.730 1 014930087

1493/C7

háromkaros önszabályozó kulcs
jobbmenetes/balmenetes olajszűrőkhöz
cserélhető karokkal

csúszásmentes gyémántozott felület
2 sorozat karral:
• 1 sorozat 20 mm hasznos hosszal
• 1 sorozat 38 mm hasznos hosszal



1493/C7 Ø mm 50÷100 Ø mm 16 Ft 53.950 1 014930079

210x150x50 mm

1493H

3-karú önbeálló olajszűrő leszedő,
jobbos-balos

Recézett befogópófa



1493H Ø mm 72÷127 H mm 62 Ft 12.650 1 014930077



1493/S-U

Jobb és balmenetes önzáró háromkörös olajsűrőleszedőkulcs



	□	∅ mm	Ft		
1493/S	3/8-1/2	80-115	34.150	1	014930074
1493/U	1/2	105-165	76.100	1	014930076

1493X

önzáró kulcs
balmenetes olajsűrőkhöz



	∅ mm	± mm	Ft		
1493X/1	60÷80	2,9	12.050	1	014930105
1493X/2	80÷98	2,9	12.050	1	014930110

1493Y

önzáró kulcs
jobbmenetes-balmenetes olajsűrőkhöz
nehéz változat

a 1493Y/2 cikkszámú termék
szűrítő szűrőkhöz is használható



	∅ mm	± mm	Ft		
1493Y/1	80÷110	7,3	51.800	1	014930120
1493Y/2	104÷145	7,3	79.300	1	014930122

1493C/ADB

AdBlue® sapka nyitó,
a PSA csoport járműveivel



	Ft		
1493C/ADB	5.550	1	014930900

1493U/ADB

AdBlue® leeresztő szelep kulcs



	Ft		
1493U/ADB	3.580	1	014930910

1494T/C5

speciális kulcskészlet
műanyag olajdugókhöz

Készlet tartalma:

- 1 kulcs a VAG csoport olajdugóhoz
- 1 kulcs BMW olajdugóhoz
- 1 kulcs a PSA és Ford csoport olajdugóhoz
- 1 kulcs Mercedes olajdugóhoz
- 1 T-szárú kulcs



	Ft		
1494T/C5	27.250	1	014940350

≡ 173x125x50 mm - 📦 360 g

1494BMW

speciális tok olajleeresztő dugók számára
BMW motorokhoz



	Ft		
1494BMW	5.790	1	014940315

1494FPC

speciális tok olajleeresztő dugók számára
Ford, Peugeot és Citroën motorokhoz



	Ft		
1494FPC	6.550	1	014940320

1494VW

különleges kulcs műanyag olajdugóhoz
Volkswagen csoport motorok

lehetővé teszi az olajteknőből a műanyag dugó
eltávolítását és felszerelését.

A Volkswagen csoport TFSI és TDI motorjaihoz készült



	Ft		
1494VW	8.800	1	014940305

1494MRC

speciális kulcs műanyag olajdugóhoz,
Mercedes motorokhoz



	Ft		
1494MRC	3.980	1	014940325

1494MAN

speciális kulcs műanyag olajdugóhoz,
DAF és MAN motorok



	Ft		
1494MAN	3.580	1	014940330

1494

Olajleeresztő dugókulcs-betét, négyszög



mm	Ft		
10	3.520	1	014940280

1494E

Olajleeresztő dugókulcs-betét, külső hatszög



mm	Ft		
8	3.520	1	014940208
9	3.520	1	014940209
10	3.520	1	014940210
11	3.520	1	014940211
12	3.520	1	014940212
14	3.520	1	014940214
17	3.520	1	014940217

1494Q

Olajleeresztő dugókulcs-betét, külső négyszög

12"



mm	Ft	1	014940258
8	3.520	1	014940258
9,5	3.520	1	014940259
12	3.520	1	014940262
13	3.520	1	014940263

1494T

Olajleeresztő dugókulcs-betét, külső háromszög

12"



mm	Ft	1	014940289
9,5	3.520	1	014940289

1494XZN

Olajleeresztő dugókulcs betét XZN®-csavarokhoz

12"



M	Ft	1	014940296
16	4.090	1	014940296

1494VW/K

motorolaj cserélő készlet VAG járművekhez



Készlet tartalma:
• 1 speciális tok olajleeresztő dugók számára
• 6 műanyag dugó olajteknőhöz

1494VW/K	Ft	1	014940310
	15.350	1	014940310

1494VW/KT

6 darabos műanyag sapka készlet az 1494VW/K termékhez



1494VW/KT	Ft	1	014940311
	8.840	1	014940311

1494/C14A

14 darabos szerszámkészlet olajcseréhez

12"



1494/C14A	Ft	1	014940150
	47.700	1	014940150

- 1494E 8-9-10-11-12-14-17
- 1494Q 8-9,5(3/8")-12-13
- 1494 10
- △ 1494T 9,5(3/8")
- 1494XZN M16

380x305x40 mm - 1,7 kg

1494M

hatszögű olajdugó szerszám mágneses és hajlékony

lehetővé teszi az olajleeresztő dugó eltávolítását égésveszély és bepiszkolódás nélkül



L	F	Ø	Ft	1	014940401
mm	kg	mm			
293	2,5	19	9.430	1	014940401

1495/C6

Olajleeresztő menetjavító készlet



• A nem megfelelő menetet 1495M megfelelő menettűréjével átvágjuk.

• A javítás olajleeresztés után történik.

A készlet tartalma:

- 1 menettűró M13x1.25 + 6 csavar+ 12 alátét
- 1 menettűró M13x1.5 + 6 csavar+ 12 alátét
- 1 menettűró M15x1.5 + 6 csavar+ 12 alátét
- 1 menettűró M20x1.5 + 6 csavar+ 12 alátét
- 1 menettűró M22x1.5 + 6 csavar+ 12 alátét

1495/C6	Ft	1	014950500
	101.600	1	014950500

420x185x60 mm - 2,1 kg

1495M

Tülméretes menettűró



M	Ft	1	014950553
13x1,25	6.630	1	014950553
13x1,50	5.360	1	014950563
15x1,50	5.880	1	014950565
17x1,50	6.610	1	014950567
20x1,50	7.380	1	014950570
22x1,50	9.720	1	014950572

1495T

6 olajleeresztő csavar és alátét



M	Ft	1	014950503
13x1,25	7.810	1	014950503
13x1,50	8.670	1	014950513
15x1,50	7.810	1	014950515
17x1,50	8.970	1	014950517
20x1,50	10.050	1	014950520
22x1,50	13.350	1	014950522

1496/C

Olajleeresztő kulcs, krómózott



8 x 10 mm	Ft	3	014960010
	8.710	3	014960010

1497D

Egyenes pofájú fogó relé szereléséhez

Biztonságos lehúzás minden típusú reléhez törésveszély nélkül



1497D	Ft	1	014970150
	13.150	1	014970150

A min+Max mm 15±50

1497BS

egyenes pófájú, vékony fogó relé és biztosíték szereléséhez

a hosszú és rendkívül vékony pófákkal a relé vagy biztosíték szűk helyen is biztonsággal lehúzható



L mm	L1 mm	A mm	Ft		
230	45	14	9.670	1	014970190

1497P

60°-ban hajlított pófájú fogó relé szereléséhez

Biztonságos lehúzás minden típusú reléhez törésveszély nélkül



A min=Max mm	Ft		
15÷50	13.600	1	014970160

1497SS

önzáró fogó vezetékek forrasztásához

A felső szorító párral a forrasztandó vezetékek könnyedén rögzíthetők és egymáshoz közel hozhatók.

A beépített reteszelőnek köszönhetően a vezetékek 6 különböző pozícióban helyezhetők el.



L mm	A min=Max mm	Ft		
245	14÷70	8.790	1	014970195

1497TE

elektromos csatlakozó leszedő fogó

a vékony csőrnek köszönhetően a bilincs a csatlakozók sérülése nélkül nyitható



L mm	A Max mm	Ø mm	Ft		
215	63	4	8.400	1	014970180

1497/C23

23 darabos szerszámkészlet az elektromos dugasz szerelésére



1497/C23	Ft		
	90.150	1	014970200

440x250x70 mm - 1,7 kg

1497/C94

94 darabos készlet a járművek tesztelésére alkalmas diagnosztikai készülékekhez

- 2 Kábelgyorscsatlakozó
- 2 Potencióméter
- 2 Kontroll-lámpa
- 2 SRS csatlakozó
- 2 Krokodilcsipesz
- 2 Tűszonda
- 2 Mérőcsúc
- 2 Duplabanándugó
- 4 Banándugó
- 24 Lapos kábelsaru 0.6+6 mm
- 12 Csatlakozó dugasz 1.6+3.9 mm
- 24 Hüvelyes kábelcsatlakozó 0.6+6 mm
- 12 Csatlakozó hüvely 1.6+3.9 mm



1497/C94	Ft		
	158.300	1	014970300

430x390x100 mm - 3 kg

1497RC

elektromos gyorscsatlakozó pár

- vezeték keresztmetszet: 1,5+3,5 mm
- feszültség: 0÷330 V
- legnagyobb áramerősség 5 A



1497RC	Ft		
	30.650	1	014970351

1497KB/S3

3 darabos készlet Knorr-Bremse elektromos csatlakozók eltávolítására

- 1 szerszám bajonettzáras csatlakozókhöz
- 1 egyfejű szerszám kétpólusú csatlakozókhöz
- 1 kétfejű szerszám 4-, 6- és 12-pólusú csatlakozókhöz



1497KB/S3	Ft		
	37.650	1	014970050

1497/S3

3 elektromos jel érzékelő kábel

- 1 db egyenes
- 1 db 45°
- 1 db 90°



1497/S3	Ft		
	8.660	1	014970400

1498

Feszültségvizsgáló műszer 3-48V

CE

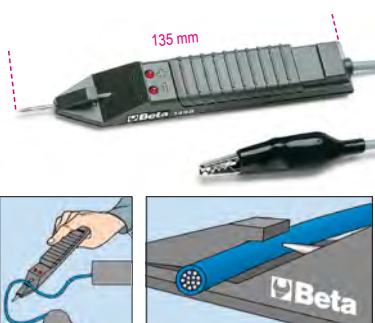

3÷48V	Ft		
	19.300	2	014980100

JÁRMŰJAVÍTÁS

Járműjavító szerszámainkat, amelyeket a legigényesebb szakemberek használnak, a világ legmagasabb követelményeinek megfelelően fejlesztettük és gyártottuk, és rendszeresen teszteljük a legnagyobb terhelést jelentő üzemi körülmények között.

Több mint 50 éve büszkén dolgozunk együtt a legnagyobbakkal, akik segítenek termékeink folyamatos fejlesztésében és biztosítják a legmagasabb minőségi színvonalnak való megfelelést.

A járműjavító eszközök az alábbi szakaszokban találhatóak:

DIAGNOSZTIKA	
	1438 - 1499 1758VT - 1760TMC
MOTOR	
	955 - 989A 1438 - 1499
OLAJ ÉS SZŰRŐK	
	1438 - 1499 1877 - 1885
ELEKTROMOS RENDSZER	
	1438 - 1499
GYORSINDÍTÓK	
	1498BC/12 - 1498/40A
ERŐÁTVITEL	
	1438 - 1499
FELFÜGGESZTÉS	
	1549 - 1569CP
FÉKEK	
	1438 - 1499
KEREKEK	
	955 - 989A
KAROSSZÉRIA	
	1302 - 1369 1763 - 1767A
EGYÉB BERENDEZÉSEK	
	1878 - 3067
EMELÉSTECHNIKA	
	3029/2T - 3067/70-13T



1498BC/12

többfunkciós külső gyorsindító, 12V

Műszaki adatok:

- Indítóáram: 600A
- Indítócsúcs: 1500A
- Akkumulátor típus: 4 cella, LifePo4
- Akkumulátorkapacitás: 25000mAh
- Polaritáscsere, rövidzárlat, túláram, túltöltés és túlmelegedés elleni védelem



CE



Tartozékok:

- Védőtok
- Indítókábel akkucsipeszekkel
- USB csatlakozó elektronikus eszközök töltéséhez
- LED akkumulátor töltésjelző
- USB és USB-C kábel
- Hálózati tápegység
- Multifunkciós LED zseblámpa

	L	P	H		Ft		
	mm	mm	mm			1	014980040
1498BC/12	225	100	40		146.500		

1498MN/12-C

tápkábel csipeszekkel az 1498BC/12 eszközhöz



		Ft		
			1	014980005
1498MN/12-C		23.300		

1498MN/12-R

hálózati adapter az 1498BC/12 mini gyorsindítóhoz



		Ft		
			1	014980003
1498MN/12-R		17.150		

1498MN/12-P

szivargyújtó csatlakozó az 1498BC/12 mini gyorsindítóhoz



		Ft		
			1	014980004
1498MN/12-P		11.550		

1498MN/12-U

USB vezeték U univerzális adapterrel



		Ft		
			1	014980009
1498MN/12-U		7.480		

1498LT/12

hordozható nagyteljesítményű ultrakönnyű gyorsindító

CE



A mikroprocesszor teljes védelmet nyújt a következők ellent: - fázis felcserélés - rövidzárlat- hibás feszültség- túlterhelés- alutöltés- túltöltés- túlmelegedésMŰSZAKI ADATOKÜzemi feszültség: 12 V

Folyamatos áramerősség: 800 A
Legnagyobb indítási áramerősség: 2000 A
Csúcs áramerősség: 4000 A
Vezetékek hossza: 500 mm
Akkumulátor típus: 4 cellás LifePo4
Memória Mentés funkció: IGEN
Méretek: 260 x 135 x 72 mm
Nettó súly: 2,5 kg
12 V 1,3 A töltőegységgel rendelkezik

		Ft		
			1	014980012
1498LT/12		332.800		

1498LT/12-SF

fali rögzítőkengyel a 1498LT/12 csavarbehajtóhoz



		Ft		
			1	014980013
1498LT/12-SF		55.700		

1498LT/12-R7

hálózati adapter a 1498LT/12 gyorsindítóhoz



		Ft		
			1	014980057
1498LT/12-R7		23.950		

1498LT/12-24

hordozható nagy teljesítményű gyorsindító, 12-24 V, ultrakönnyű,

használható személygépkocsikhoz, haszongépjárművekhez és tehergépjárművekhez



A mikroprocesszor teljes védelmet nyújt a következők ellen:

- fázis felcserélés
 - rövidzárlat
 - hibás feszültség
 - túlterhelés
 - alultöltés
 - túltöltés
 - túlmelegedés
- MŰSZAKI ADATOK
- Üzemi feszültség: 12/24V
 - Folyamatos áramerősség: 2000/1000 A
 - Legnagyobb indítási áramerősség: 5000/2500 A
 - Csúcs áramerősség: 10000/5000 A
 - csipesz áramerősség: 1000 A
 - Kábelhossz: 160 cm
 - Kábelátmérő: 25 mm²
 - Automatikus tápellátás: 4 Amp
 - Memória mentés funkció
 - Méretek: 350x240x140 mm
 - Súly: 5 kg

1498LT/12-24 Ft 788.000 1 014980014

1498/12

Külső gyorsindító és akkumulátortöltő személygépkocsikhoz 12 V, hordozható



- MŰSZAKI ADATOK:
- Indítócsúcs: 2200A
 - Vállszíj
 - Hermetikusan zárt ólomakkumulátor elektrolittal (AGM)

1498/12 Ft 257.300 1 014980480

13 kg

1498/24

Külső gyorsindító és akkumulátortöltő személygépkocsikhoz és haszongépjárműhöz, 12-24 V, hordozható



- MŰSZAKI ADATOK:
- Indítócsúcs: 4200A (12V) - 2100A (24V)
 - Vállszíj
 - Hermetikusan zárt ólomakkumulátor elektrolittal (AGM)

1498/24 Ft 514.800 1 014980490

1498B12/R02

Tartalék akkumulátor 12V, 1498B/12 és a 1498B/24 modellhez



1498B/12-R02 Ft 122.200 1 014980502

1498/12-24 R20

hálózati adapter 1498/12 és 1498/24 gyorsindítóhoz



1498/12-24 R20 Ft 31.900 1 014980520

1498/2A

12 V elektronikus motorkerékpár akkumulátor töltő

lehetővé teszi minden Pb Wet, Agm, Gel, Mf, Vrla típusú akkumulátor, és a LiTium LiFePo4 akkumulátor töltését



- két egyedi akkumulátor töltési típus a LiTiumos és az ólom akkumulátorokhoz
- automatikus többfázisú töltési ciklus
- polaritáscsere és rövidzárlat elleni védelem
- IP65 védelmi fok
- csipeszes vezetékkel és alátétgyűrűs vezetékkel szállítva
- tápfeszültség: 220-240 V

MŰSZAKI ADATOK

- töltőáram: 1A
- törlőkapacitás: 2 Ah-40Ah
- frekvencia: 50-60 Hz
- az akkumulátor feszültsége: 12 V
- méretek: 180x80x40 mm
- súly: 0,5 Kg

1498/2A Ft 517.500 1 014980102

1498/4A

6-12 V autó-motor elektronikus akkumulátortöltő



- polaritáscsere, rövidzárlat elleni védelem
- automatikus 6 vagy 12 Volt feszültség kijelölés
- automatikus akkumulátor típus kijelölés
- digitális kijelző háttérvilágítással
- lehajtható rögzítő horog

MŰSZAKI ADATOK

- Tápfeszültség: 220 V-240 V
- Frekvencia: 50-60 Hz
- Névleges áramerősség (min-max): 1-4 Amp
- Az akkumulátor feszültsége: 6 V/12 V
- Akkumulátor kapacitás: 4 Ah-80 Ah
- Feltöltési idő: 12 óra
- Védelmi fok: IP65

1498/4A Ft 62.750 1 014980104

1498SA/2A-4A

szivargyújtós csatlakozó a 1498/2A és 1498/4A készülékekhez



1498SA/2A-4A Ft 14.300 1 014980120

1498/8A

12 V autó-hasznójármű elektronikus akkumulátortöltő



- lassú és gyors töltés (2 A-8 A)
- lemerült akkumulátor helyreállítás funkció
- tápellátási funkció 13,8 V-5 A
- polaritáscsere és rövidzárlat elleni védelem
- kézi akkumulátor típus kijelölés
- digitális kijelző háttérvilágítással
- lehajtható rögzítő horog

MŰSZAKI ADATOK

Tápfeszültség: 220 V - 240 V
Frekvencia: 50-60 Hz
Névleges áramerősség (min-max): 2-8 Amp
Az akkumulátor feszültsége: 12 V
Akkumulátor kapacitás: 5 Ah-160 Ah
Memory Saver funkció: 13,8 V - 5 A
Védelmi fok: IP65

1498/8A Ft 88.400 1 014980108

1498/4A-8A CO

gyűrűs vezeték a 1498/4A és 8A készülékekhez



1498/4A-8A-CO Ft 5.850 1 014980114

1498/4A-8A CP

csipeszes vezeték a 1498/4A és 8A készülékekhez



1498/4A-8A-CP Ft 7.690 1 014980118

1498/2A-8A-PR

hosszabbító a 1498/2A/4A/8A modellekhez



1498/2A-8A-PR Ft 16.350 1 014980119

1498/16A

többfunkciós elektronikus akkumulátortöltő, 12-24V



- hátsó megvilágítású grafikus kijelző
- legnagyobb töltőáram: 16A folyamatosan
- töltés és töltésfenntartás
- polaritáscsere és rövidzárlat elleni védelem
- 9 töltési lépés
- csepptöltő rendszer
- BEMUTATÓTEREM funkció (13,8V - 12A)
- TÁP funkció (14V - 12A)
- memória mentés funkció (13,8V - 12A)
- akkumulátor helyreállítás funkció
- csipesztartó
- visszahúzó-rugós rögzítés
- tartozékok: csipeszes kábel, alátétgyűrűs kábel

MŰSZAKI ADATOK

Tápfeszültség: 220-240V
Teljesítmény: 240W
Töltőáram: 4-16A
Akkumulátor típusok: Agm - Wet - Lithium (LiFePo4)
Töltőkapacitás: 5-360Ah
Fenntartási kapacitás: 5-550Ah
Kimeneti feszültség: 12-24V
Legkisebb akkumulátorfeszültség: 0,8V
Védelmi fokozat: IP20

1498/16A Ft 201.000 1 014980126

1498/25A

többfunkciós elektronikus akkumulátortöltő, 12-24V



- Jellemzők:
- Háttérvilágítású grafikus kijelző
 - Legnagyobb folyamatos töltőáram: 25A
 - Töltés és töltésfenntartás
 - Polaritáscsere és rövidzárlat elleni védelem
 - 9 töltési szakasz
 - Csepptöltő rendszer
 - SHOW ROOM funkció (13,8V - 21A)
 - SUPPLY funkció (14V - 21A)
 - Memória mentés funkció (13,8V - 21A)
 - Akkumulátor helyreállítás funkció
 - Csipesztartó
 - Fekvő rögzítőkampó
 - Tartozékok: kábel csipeszel

Műszaki adatok:

• Tápellátás: 220-240V
• Teljesítmény: 390 W
• Töltőáram: 5-25A
• Akkumulátor típus: Agm - nedves - lítium (LiFePo4)
• Töltőkapacitás: 5-550 Ah
• Fenntartási kapacitás: 5-800 Ah
• Kimeneti feszültség: 12-24V
• Legkisebb akkumulátorfeszültség: 0,8V
• Védelmi fokozat: IP20

1498/25A L mm H mm P mm Ft 210.600 1 014980125



1498/120A

elektronikus akkumulátor töltő
többfunkciós, 12 Volt

Lehetővé teszi az akkumulátorok töltését,
és tápfeszültséget ad a járműveknek az össze
őndiagnosztikai fázis közben



- legnagyobb töltőáram 120 A folyamatosan
- töltés és fenntartás mikroprocesszor segítségével (CPU)
- akkumulátor helyreállítási funkció
- ECU átprogramozás és tápellátás
- polaritáscsere, rövidzárlat, hibás feszültség és túlterhelés elleni védelem

MŰSZAKI ADATOK

Tápfeszültség: 90-260 V
Teljesítmény: 1500 W
Töltőáram: 10-120 A
Akkumulátor típusok: Agm - Wet - Lithium (LifePo4)
Töltőkapacitás: 10-1200 Ah
Fenntartási kapacitás: 5-3600 Ah
Kimeneti feszültség: 12 Volt
Vezeték hosszúság rögzítőcsipeszekkel: 2700 mm
Méretek: 310 x 150 x 350 mm
Súly: 8,5 Kg

1498/120A Ft 1.328.100 1 014980142

1498/40A

12-24 V kocsiakra szerelt többfunkciós
akkumulátortöltő és gyorsindító



- 3 programozott és 1 kézi töltőciklus
- elektronikus szabályozó potenciométer
- WET-SPIRAL/GEL-AGM egyedi töltési folyamatok
- elektronikus vezérlési és védelmi rendszer
- 10 fázisú töltési folyamatok
- szulfátmentesítési és akkumulátor helyreállítási funkció
- supply funkció
- kettős feszültség 12-24 V
- megfelel a Start&Stop akkumulátorokhoz
- professzionális gumiszigeteléses rézsaruk

MŰSZAKI ADATOK

Tápellátás: 230 V
Kimeneti feszültség: 12-24 V
Töltőfeszültség: 1-40 A
Indítóáram: 350 A max egyenáram
Töltőkapacitás: 4-450 Ah

1498/40A Ft 478.100 1 014980140
330x250x792

1498SM

Adattároló egység 12 V

Személyautó-komputer tárolja az adatokat a karbantartás és
akkumulátorcseré közben



- Műszaki adatok:
- Automatik
 - Belső akkumulátor Pb 5 Ah
 - 12 Volt
 - Professzionális csatlakozás OBD dugasszal

1498SM Ft 100.300 1 014980020

1498SM-C

OBD II 12 V autó memória vezeték az
1498SM/C készülékhez



1498SM-C Ft 10.850 1 014980021

1498SM-CP

autó memória 12 V 1498SM/CP csipesz
vezeték



1498SM-CP Ft 10.500 1 014980022

1498SM-A

1498SM/A memóriamentő egység adapter



1498SM-A Ft 10.750 1 014980023

1498TB/6-12

analóg 6-12V akkumulátor vizsgáló

6V és 12V akkumulátorokhoz maximum 1000CCA-ig



Kábelhossz: 500 mm

1498TB/6-12 Ft 20.150 1 014980420
L 290 mm L1 170 mm P 75 mm

Beta

1498TB/12-24

digitális 12 V akkumulátor vizsgáló és 12-24 V indító és töltő rendszer elemző

- a következő tesztek elvégzését teszi lehetővé: akkumulátor, generátor (intelligens vagy normál) és indítómotor, dióda ripple és földelés próba
- szoftverrel rendelkezik a számítógépes teszt eredményének kinyomtatásához
- hátsó megvilágítású kijelző
- kompakt és ütővédtett szerkezet
- 10 nyelvű szoftver
- megfelelő bemenettel rendelkezik egy kihúzható külső mininyomtató csatlakoztatásához (opcionális Beta 1498ST/TB tartozék)



CE

MŰSZAKI ADATOK:

- alkalmazások: Akkumulátor teszt 12 V - Generátor teszt 12-24 V töltés - Indítórendszer teszt
- működési tartomány: 100-2000 CCA
- vonatkozó jogszabályok: CCA, SAE, DIN, EN, IEC, JIS
- támogatott akkumulátorok: PB, WET, GEL, AGM, AGM FLAT, EFB
- voltmérő: 9 V-36 V
- vezeték hosszúság: 1600 mm
- nyelvek: Olasz, angol, francia, német, spanyol, lengyel, román, holland, svéd és finn
- tartalmazott tartozékok: USB kábel és szoftver

1498TB/12-24 Ft 293.700 1 014980401

1498ST/TB

Mini-hőnyomtató a 1498TB/12 modellhez

- Mini-nyomtató közvetlenül csatlakoztatható a feszültségvizsgálóhoz
- Lehetővé teszi a teszt-eredmények nyomtatását



CE

1498ST/TB Ft 96.700 1 014980410

1498ST/TB ROT

tartalék papír a 1498ST/TB nyomtatóhoz



1498ST/TB ROT Ft 4.110 2 014980411

1498PC

feszültségstabilizátor 12 - 24 V

Nélkülözhetetlen a vezérlőegységek védelméhezhegesztés és gyorsindítóval történő indítás közben



1498PC Ft 39.750 1 014980801

1498TC

Digitális izzítógyertya tesztelő

Az izzítógyertya gyors és precíz teszteléséhez

- Minden izzítógyertya típushoz, 4,4-5-7-8,5-10-11 Volt
- Digitális kijelző háttérvilágítással
- Alkalmos acél- és kerámia izzítógyertyákhoz
- Rövidzárlat- és póluscserre védelem
- Automatikus kikapcsolás
- Hangjelzéssel
- LED-zseblámpa SMD
- Kompakt és ütőálló



CE

1498TC Ft 81.700 1 014980450

1499

Sztetoszkóp, acélszonda és fülhallgató, nylon nyéllel



1499 Ft 40.800 1 014990001

1500/...

Kétkörös univerzális csapágylehúzó, galvanizált

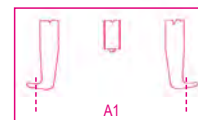

	L mm	Ft		
1500/1	100	33.750	1	015000301
1500/2	100	35.150	1	015000302
1500/3	150	57.700	1	015000303
1500/4	150	80.350	1	015000304
1500/5	205	145.600	1	015000305
1500/6	205	171.200	1	015000306
1500/7	205	257.600	1	015000307
1500/8	230	411.100	1	015000308

	A min+Max mm	A1 min+Max mm
1500/1	25÷80	70÷130
1500/2	25÷130	80÷180
1500/3	50÷160	105÷220
1500/4	60÷200	120÷270
1500/5	80÷250	160÷330
1500/6	80÷350	160÷420
1500/7	110÷520	195÷600
1500/8	170÷640	260÷715



1500/SP5 Ft 371.800 1 015000325
1500/1-1500/2-1500/3
1500/4-1500/5
1500/SPV 29.450 1 015000001

1500G/...

1 pár normál lehúzókerám az 1500 és az 1580/8I modellhez



	± mm	tit 1500	Ft		
1500G/1	35	/1-2	21.800	1	015000311
1500G/3	35	/3-4	32.050	1	015000313
1500G/5	35	/5-6-7	64.700	1	015000315
1500G/8	50	/8	79.350	1	015000317
		1580/8I			

1500N/...

Kétkörmös univerzális csapáglehúzó

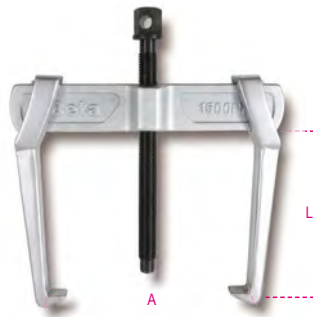

	A min+Max mm	L mm	Ft		
1500N0	18÷65	70	29.550	1	015000600
1500N1	23÷70	100	30.950	1	015000601
1500N2	23÷100	100	34.150	1	015000602
1500N3	35÷140	150	55.750	1	015000603
1500N4	35÷190	150	60.150	1	015000604
1500N5	43÷250	205	117.700	1	015000605
1500N6	43÷320	205	125.900	1	015000606



	Ft		
1500N/SP6	328.300	1	015000626
1500N/0-1500N/1-1500N/2-1500N/3			
1500N/4-1500N/5			
1500N/SPV	36.950	1	015000006

1500N/G...

Lehúzóköröm 1500N típusú csapáglehúzóhoz



	\pm mm	fit 1500N	Ft		
1500N/G0	10	/0	9.890	2	015000650
1500N/G1-2	12	/1-2	10.800	2	015000651
1500N/G3-4	17	/3-4	18.850	2	015000653
1500N/G5-6	23	/5-6	35.800	2	015000655

1501/1-2-3

Keskeny kétkörmös csapáglehúzó, galvanizált, barnított körömhegyek

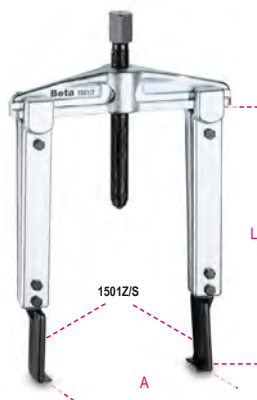

	L mm	Ft		
1501/1	100	76.500	1	015010101
1501/2	200	80.500	1	015010102
1501/3	250	85.600	1	015010103

	A min+Max mm
1501/1	25÷130
1501/2	25÷130
1501/3	25÷130

1501G/1-2-3

Keskeny köröm az 1501 modellhez, galvanizált



	L mm	Ft		
1501G/1	100	42.200	1	015010111
1501G/2	200	48.300	1	015010112
1501G/3	250	53.250	1	015010113

1501Z/S-P-R

Keskeny körömhegy az 1501G típusú körömhöz, barnított



	\pm mm	D mm	Ft		
1501Z/S	2,0	27	14.950	2	015010211
1501Z/P	3,6	27	15.150	2	015010212
1501Z/R	3,6	14	16.800	2	015010213

1502/...

kétkörmös univerzális csapáglehúzó gyors beállítással és zárással

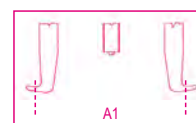
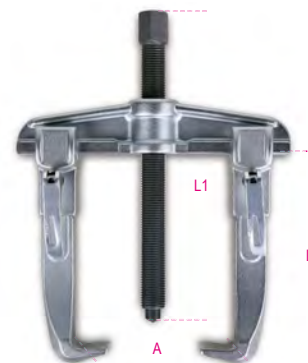

	L mm	L1 mm	Ft		
1502/0	100	166	50.200	1	015020000
1502/1	100	166	54.450	1	015020001
1502/2	150	247	86.850	1	015020002
1502/3	150	247	95.700	1	015020003
1502/4	200	321	164.800	1	015020004

	A min+Max mm	A1 min+Max mm
1502/0	40÷90	80÷130
1502/1	50÷130	90÷170
1502/2	65÷150	115÷210
1502/3	65÷190	125÷260
1502/4	70÷235	170÷335

1505V

ablaktörő és hátsó ablaktörő kar lehúzó

kivehető furatolt sárgaréz hegy
beépített ablakmosó fűvókával szerelt ablaktörő karok
lehúzásához



	A Max mm	L mm	Ft		
1505V	43	37	16.800	1	015050001

Beta

Beta

1505/C5

Ablaktörő kar lehúzó készlet

1db 2 karú lehúzó Ø 25+40 mm
4 db adapter Ø 25 mm, Ø 30 mm, Ø 35 mm, Ø 41 mm



mm	Ft		
12	58.350	1	015050300

320x150x60 mm - 1,2 kg

1506

Önzáró kétkörmös csapáglehúzó, galvanizált

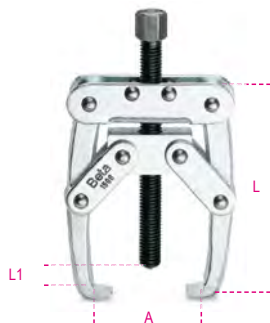

A	L	L1	Ft		
min+Max	mm	mm			
10÷50	80	40	18.400	1	015060001

1508/1 - 1508/2

Könnyített kétkörmös csapáglehúzó, galvanizált

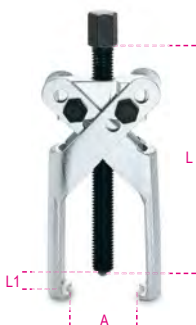

L	Ft		
mm			
1508/1	59.400	1	015080001
1508/2	70.450	1	015080002

A	L1
min+Max	mm
6÷100	85
10÷140	120



1511/1 - 2 - 3

Átfordítható, kétkörmös kettős működésű csapáglehúzó, galvanizált

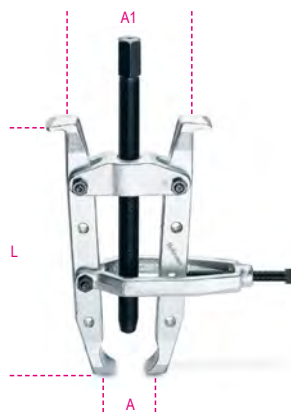

L	Ft		
mm			
1511/1	101.600	1	015110001
1511/2	127.300	1	015110002
1511/3	157.800	1	015110003

A	A1
min+Max	min+Max
mm	mm
1511/1	20÷100
1511/2	40÷150
1511/3	40÷150

1515/1 - 2 - 3

Állítható kétkörmös csapáglehúzó, galvanizált



L	Ft		
mm			
1515/1	13.850	1	015150101
1515/2	14.850	1	015150102
1515/3	21.950	1	015150103

A	L1
Max	mm
1515/1	60
1515/2	70
1515/3	90

1516/1 - 2 - 3

Állítható háromkörmös csapáglehúzó, galvanizált



L	Ft		
mm			
1516/1	19.750	1	015160001
1516/2	21.150	1	015160002
1516/3	29.750	1	015160003

A	L1
Max	mm
1516/1	60
1516/2	70
1516/3	90

1517

Állítható háromkörmös csapáglehúzó

- Nagy teljesítményű.
- Önzáró.



L	L1	Ø	Ft		
mm	mm	mm			
1517/90	182	60	101.200	1	015170000
1517/150	242	115	107.500	1	015170010
1517/200	307	150	122.600	1	015170020
1517/260	395	180	140.200	1	015170030

●	A	kg	N
mm	mm		
1517/90	19	18÷90	6000
1517/150	19	25÷150	6000
1517/200	19	40÷200	6000
1517/260	27	50÷260	8000



1517C KÉT-/HÁROMKÖRMÖS ÖNZÁRÓ CSAPÁGYLEHÚZÓ KÜLSŐ LEHÚZÁSRA

A Beta 1517C csapágylehúzójának önzáró mechanizmusát a kereszttartón lévő rugó biztosítja. Ez megkönnyíti a lehúzó pozicionálását és zárását a lehúzó pozicionálása után a körmöket a gyűrűsanyával rögzíthetjük.

Az egyedi kereszttartón elhelyezkedő négy fészeknek köszönhetően a 1517C csapágylehúzó könnyebb, gyorsabb munkákhoz kétkörmös illetve erősebb fogást kívánó munkákhoz háromkörmös változatban is használható.

A csavarfejen lévő biztonsági csapszeg a megengedett legnagyobb nyomaték túllépése esetén eltörik, így védve a lehúzót a túlterheléstől.



1517C/... két-/háromkörmös önzáró csapágylehúzó

- két- és háromkörmös használatra
- önzáró



	L mm	L1 mm	Ft		
1517C0	145	250	89.800	1	015170500
1517C1	200	300	110.400	1	015170501
1517C2	270	300	136.900	1	015170502

	A mm	● mm
1517C0	12÷140	18
1517C1	20÷180	18
1517C2	30÷280	18

1518/... Háromkörmös csapágylehúzó, galvanizált



	L mm	Ft		
1518/1	105	33.700	1	015180001
1518/2	135	42.750	1	015180002
1518/3	235	74.950	1	015180003
1518/4	270	108.300	1	015180004
1518/5	270	124.900	1	015180005
1518/6	270	133.800	1	015180006

	A min÷Max mm	L1 mm
1518/1	24÷100	105
1518/2	32÷160	150
1518/3	40÷220	220
1518/4	80÷250	240
1518/5	80÷300	350
1518/6	80÷350	400

1518U/... háromkörmös univerzális csapágylehúzó

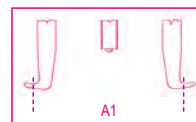
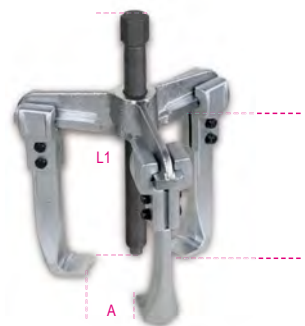

	L mm	L1 mm	Ft		
1518U/0	100	166	61.750	1	015180500
1518U/1	100	166	66.150	1	015180501
1518U/2	150	247	100.900	1	015180502
1518U/3	150	247	105.100	1	015180503
1518U/4	200	321	151.700	1	015180504

	A min÷Max mm	A1 min÷Max mm	● mm
1518U/0	40÷90	80÷130	17
1518U/1	50÷130	90÷170	17
1518U/2	65÷150	115÷210	22
1518U/3	65÷190	125÷260	22
1518U/4	70÷235	170÷335	27

1519/... háromkörmös univerzális csapágylehúzó gyorsan állítható és zárható

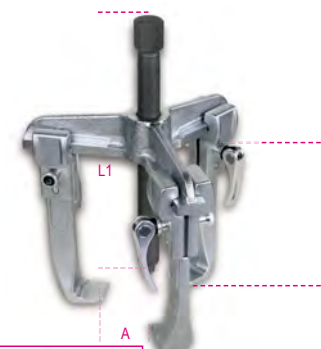

	L mm	L1 mm	Ft		
1519/0	100	166	71.450	1	015190000
1519/1	100	166	75.850	1	015190001
1519/2	150	247	108.400	1	015190002
1519/3	150	247	115.000	1	015190003

	A min÷Max mm	A1 min÷Max mm	● mm
1519/0	40÷90	80÷130	17
1519/1	50÷130	90÷170	17
1519/2	65÷150	115÷210	22
1519/3	65÷190	125÷260	22



1520/1 - 1520/2

Átfordítható, kétkörmös csapáglehúzó, galvanizált



	L mm	Ft		
1520/1	135	31.300	1	015200101
1520/2	235	53.900	1	015200102

	A Max mm	L1 mm
1520/1	110	85
1520/2	160	140

1521/1 - 1521/2

Átfordítható, háromkörmös csapáglehúzó, galvanizált



	L mm	Ft		
1521/1	135	41.800	1	015210101
1521/2	235	69.850	1	015210102

	A Max mm	L1 mm
1521/1	110	90
1521/2	160	140

1528

önzáró féktárcsa lehúzó



∅ 19 mm

	A min+Max mm	Ft		
	170÷380	87.250	1	015280000

☞ 480x240x60 mm - 📦 4,8 kg

1529

Ékszíjtárcsalehúzó készlet

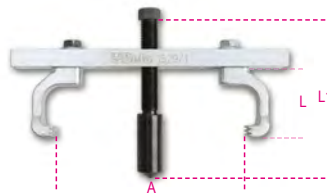

	A min+Max mm	L min+Max mm	L1 min+Max mm	Ft		
	24÷240	60÷95	90÷135	91.300	1	015290000

☞ 260x210x60 mm - 📦 2,6 kg

1529/C7

szíjtárcsa lehúzó

A készlet a következőket tartalmazza:

- 2 befogópófa kettős, 4,7 mm lábbal
- 2 befogópófa egyes, 4,3 mm lábbal
- 1 befogópófa kettős, 2,3 mm lábbal
- 1 befogópófa egyes, 2,3 mm lábbal

A befogópófa párok a műveleti igénynek megfelelően alakíthatók



	L mm	L1 mm	A min+Max mm	Ft		
1529/C7	50	72,5	53÷114	60.850	1	015290100

☞ 285x155x50 mm - 📦 2 kg

1529PI

univerzális befecskendező szivattyú szíjtárcsa lehúzó

- lehetővé teszi az üzemanyag befecskendező szivattyú szíjtárcsa gyors és pontos kiszerezését.
 - különösen a Fiat, Ford, Volkswagen, Citroen és Peugeot gyártmányokhoz javasolt
- 3 csavarpárt tartalmaz a lehúzónak a szíjtárcsához történő rögzítéséhez:

M6 x 1.0 x 49 mm

M7 x 1.0 x 75 mm

M8 x 1.25 x 76 mm



	Ft		
1529PI	43.300	1	015290051

1529/P6

nagynyomású gázolaj pumpa lehúzó, a VAG csoport járműveihez

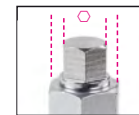

	mm	Ft		
	15-24	30.750	1	015290010

1530/C5

Kerékagy lehúzó készlet 3, 4, 5 körmös

Szerszámkészlet tartalmaz:

1 Univerzális karima 96÷138 mm

1 Hidraulikus működtetésű lehúzóengely 12 t

1 2,8 kg-os lendítő kerék, ne legyen feszítő csapszeg a kerékagy közepén



	Ft		
1530/C5	222.300	1	015300300

☞ 760x320x120 mm - 📦 11,5 kg

1530/C16

csúszókalapácsos készlet távtartó betétekkel kerékagy és csapágycsák kihúzásához 3, 4, 5 furatú kerekekénél

Ideális a kiálló központosító gyűrűvel szerelt kerékagyaknál

A készlet a következőket tartalmazza:

- 1 univerzális perem 90÷130 mm
- 1 csúszókalapács 5 kg
- 4 csatlakozó betét M12
- 4 csatlakozó betét M14



	Ft		
1530/C16	250.100	1	015300316

☞ 760x310x100 mm - 📦 13,5 kg

1531/C7

kerécsapágy belső gyűrű levezető készlet

méretetek:

- 1 fogó Ø 40÷45 mm
- 1 fogó Ø 45÷51 mm
- 1 fogó Ø 50÷55 mm
- 1 fogó Ø 55÷61 mm



1531/C7 Ft 307.100 1 015310107

390x315x96 mm - 4,3 kg

1532

Tömítésleszedő szerszám



1532 Ft 6.500 2 015320001

1533/...

Lehúzókegyl a szétválasztóhoz (1534), galvanizált



	L mm	Ft		
1533/2	150	45.250	1	015330002
1533/3	210	85.100	1	015330003
1533/4	315	134.400	1	015330004
1533/5A	305	161.300	1	015330006

	A min=Max mm	L1 mm
1533/2	45÷140	110
1533/3	55÷205	175
1533/4	90÷260	175
1533/5A	100÷360	235

1533PR/1 - 2 - 3

Toldat a levezetőkegylhez (1533), barnított



	Ft		
1533PR/1	9.630	1	015330011
1533/2			
1533PR/2	10.650	1	015330012
1533/3			
1533PR/3	11.300	1	015330013
1533/4-5			
1533PR/5A	11.300	1	015330016
1533/5A			

1534/...

Szétválasztó, galvanizált

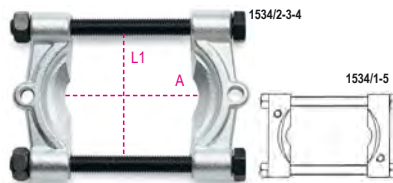

		Ft		
1534/1	1533/2	38.900	1	015340001
1534/2	1533/2	45.650	1	015340002
1534/3	1533/3	76.450	1	015340003
1534/4	1533/4	127.000	1	015340004
1534/5A	1533/5A	267.300	1	015340006

	A min=Max mm	L1 mm
1534/1	5÷60	63
1534/2	12÷75	75
1534/3	22÷115	118
1534/4	25÷155	154
1534/5A	30÷220	180

1535/C...

Leválasztó készlet, fémdobozban



1535/C1 Ft 119.800 1 015350001

	Ft		
1533/2			
1533PR/1			
1534/1			

260x180x40 mm - 2,5 kg

1535/C2 Ft 126.500 1 015350002

	Ft		
1533/2			
1533PR/1			
1534/2			

260x180x40 mm - 2,8 kg

1535/C3 Ft 208.300 1 015350003

	Ft		
1533/3			
1533PR/2			
1534/3			

380x280x55 mm - 8,0 kg

1535/C4 Ft 323.500 1 015350004

	Ft		
1533/4			
1533PR/3			
1534/4			

420x380x65 mm - 14,8 kg

1535/C5A Ft 498.600 1 015350006

	Ft		
1533/5			
1533PR/3			
1534/5			

530x510x85 mm - 27,2 kg

1539

Lemezcsúszató kalapács, krómozott



1539 Ft 68.450 1 015390001

1540

Lehúzókalapács, galvanizált

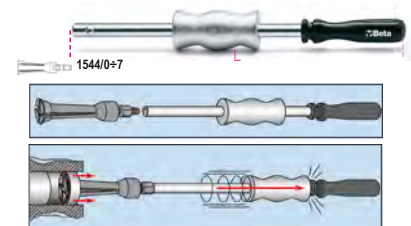

1540 Ft 38.200 1 015400001



Beta

1542/1 - 1542/2

Ellentartó belső csapáglehúzókhöz galvanizált



	A	1544	Ft		
	min+Max				
	mm				
1542/1	35÷75	0÷7	31.750	1	015420001
1542/2	60÷130	9C-10C	48.600	1	015420002

	L	L1
	mm	mm
1542/1	140	140
1542/2	175	160

1544/...

Kétkörmös belső csapáglehúzó, barnított

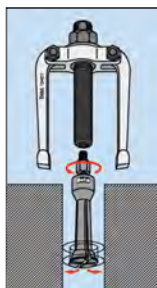

	C	Ø	Ft		
	mm	M			
1544/0	0,25	M10	29.100	1	015440100
A= 5÷7					
1544/A	0,80	M10	29.650	1	015440105
A= 7÷9					
1544/1	0,80	M10	30.000	1	015440110
A= 9÷12					
1544/2	1,15	M10	31.150	1	015440120
A= 13÷17					
1544/2B	1,00	M10	31.600	1	015440121
A= 14÷19					
1544/3	1,70	M10	32.200	1	015440130
A= 16÷21					
1544/4	1,65	M10	35.800	1	015440140
A= 20÷25					
1544/5	2,00	M10	38.900	1	015440150
A= 25÷30					
1544/6	3,00	M10	48.250	1	015440160
A= 30÷37					
1544/7	3,80	M10	55.800	1	015440170
A= 38÷45					
1544/9C	2,60	G 3/8"	78.650	1	015440189
A= 40÷75					
1544/10C	7,30	G 3/8"	110.700	1	015440199
A= 70÷115					

1545/C5M

Belső csapáglehúzó készlet 1542/1 ellentartó 5 darab 1544 típusú belső lehúzóval, fémdobozban



1545/C5M	Ft		
	214.200	1	015450011

1542/1	● 24 mm
1544/1	9÷12 mm
1544/2	13÷17 mm
1544/3	16÷21 mm
1544/4	20÷25 mm
1544/5	25÷30 mm

☞ 265x180x45 mm - 📦 2,4 kg

1547/C6

Csapáglehúzó sérült csapágyakhoz



1547/C6	Ft		
	84.650	1	015470006

☞ 420x185x60 mm - 📦 3 kg

1547/KP

3 darabos csapáglehúzó készlet



	Ø	Ft		
	mm			
1547KP/1	9-11-12,5	17.700	1	015470106
1547KP/2	5-6-8	12.250	1	015470206

1547P

Hatszögű toldók

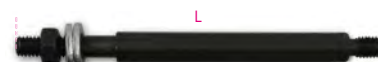

	L		Ft		
	mm	Ø			
1547P/1	205	1547/1	3.590	1	015470101
1547P/2	102	1547/2	2.290	1	015470201

1547PC/2

Toldók, kerek és rövid



	L		Ft		
	mm	Ø			
1547PC/2	42	1547/2	1.860	1	015470202

1547PL/2

Toldók, kerek és hosszú

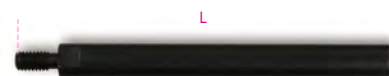

	L		Ft		
	mm	Ø			
1547PL/2	106	1547/2	2.090	1	015470203

1549

Lehúzó készlet kettős működésű gáznymásos lengéscsillapítóhoz

A rugó beszerelésekor az állvány feszes marad



1549	Ft		
	156.700	1	015490001

☞ 310x270x110 mm - 📦 3 kg

Beta

1550U

pneumatikus lengéscsillapító kiszerező eszköz gépjárművekhez, SUV modellekhez és haszongépjárművekhez

CE

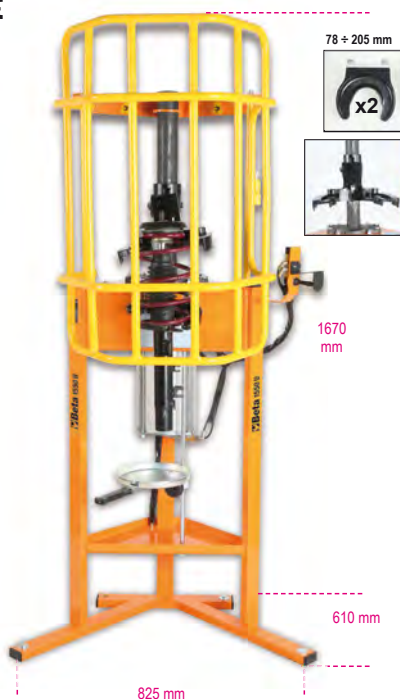

NAGYOBB TELJESÍTMÉNY: legnagyobb nyomóteljesítmény 2 t (10 bár)

UNIVERZÁLIS FELSŐ FOGÓ RENDSZER: egy beállítható felső talp segítségével lehetővé teszi az akár jobbmenetes, akár balmenetes összes rugóátmérő összenyomását

AKTÍV RUGÓBIZTONSÁGI RENDSZER: a biztonsági horog és a 3 rögzítőzelep segítségével biztosított a rugó elhelyezése/illesztése, végig megtartva ezt a helyzetet az összenyomási művelet során.

A rugó "nem megfelelő" elhelyezése esetén a rendszer leállítja a gépet.

"FULL BODY" VÉDŐRÁCS: a munkavégzési terület maximális biztonságát és védelmét biztosítja

MŰKÖDTETÉS VEZÉRLŐ KARRAL: nagyobb pontosság és érzékenység az összenyomási fázisban

MUNKAVÉGZÉSI HELYZET: munkavégzési magasság a hátsó kengyelen akár 875 mm-es magasságig

2 alsó kengyellel szállítva 78-205 mm átmérőhöz

MŰSZAKI ADATOK

Nyomóteljesítmény: 2 t (10 bár) - 1.6 t (8 bár) - 1.2 t (6 bár)

Rugó összenyomás úthossza: 335 mm

1550U Ft 1.175.800 1 015500010

1550U/CGS-R

süllyesztett felső befogópófa pár a 1550U készülékhez



1550U CGS-R Ft 266.200 1 015500035

1550U/MRC-ABE

különleges kengyel a 1550U eszközhöz egyedi kivitel a Mercedes A-B-E osztályokhoz



1550U/MRC-ABE Ft 232.900 1 015500031

1550U/MRC-C

különleges kengyel a 1550U eszközhöz egyedi kivitel a Mercedes C osztályhoz



1550U/MRC-C Ft 202.200 1 015500032

1550U/S...

alsó kengyel az 1550U eszközhöz



	Ø mm	Ft	1	015500014
1550U/S 130	78±130 mm	151.700	1	015500014
1550U/S 182	105±182 mm	151.300	1	015500015
1550U/S 205	125±205 mm	147.700	1	015500016

1550U/SS187

balmenetes kengyel az 1550U eszközhöz

különösen az olyan bal profilú rugókhöz javasolt, mint a Nissan Qashqai és Renault Koleos típusok



1550U/SS 187 Ft 151.300 1 015500018

1550U/M

szorító satu az 1550U lengéscsillapító kiszerező eszközhöz lehetővé teszi a lengéscsillapító szár rögzítését



1550U/M Ft 142.200 1 015500021

1551/C20

toronycsapágy szerelőkészlet

Készlet tartalma:

- 7 hatlapú dugókulcs, méretek: 16 - 17 - 18 - 19 - 21 - 22 - 24
- 1 hosszabbító, hossz: 120 mm
- 3 belső nyílású bit, méretek: 8x5 - 8x6 - 11x8
- 1 belső imbusz bit, méret: 10 mm
- 1 XZN® bit, méret: M10
- 1 Torx® bit, méret: T50
- 4 imbusz bit, méret: 5 - 6 - 7 - 8
- 1 bittartó hosszabbító, hossz: 95 mm
- 1 bittartó hosszabbító, hossz: 190 mm



Ø 8 - 21 mm

1551/C20 Ft 70.250 1 015510020

320x245x71 mm - 2,6 kg

1552/C9

készlet lengéscsillapító, lengőkar gömbfej és kormány csukló foglalat szétválasztásához

az egyes vagy kettős visszahúzófej (pl. a VAG csoportnál használt) kettős csuklókon is lehetővé teszi a munkát



Ø 13 mm

1552/C9 Ft 54.650 1 015520020

195x140x40 mm - 1,0 kg



1555/Q

Rugóösszehúzó Mac-Pherson-hoz.

Nyomóerő: 1500 kg

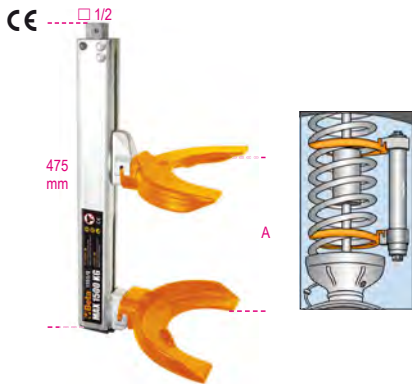

A	Ø	Ft	1	015550006
min+Max mm	min+Max mm			
65+354	80÷195	321.300		

1555/QS

Rugóösszehúzó Mac-Pherson-hoz



A	Ø	Ft	1	015550005
min+Max mm	min+Max mm			
70+300	80÷200	403.600		

1555S/BMW-RNT

Tányérok a rugóösszehúzóhoz BMW E39, E46 és Renault Mégane II 1555DS-hez és 1555/QS-hez



Ft	1	015550303
128.300		

1555C

Teleszkópos-rugóösszehúzó 4 tányérral és torziós tengellyel



A	Ø	N	t	Ft	1	015550202
min+Max mm	min+Max mm					
80+225	90+160	25000	8,5	398.600		

1556/1A

Lengéscsillapító rugóösszehúzó

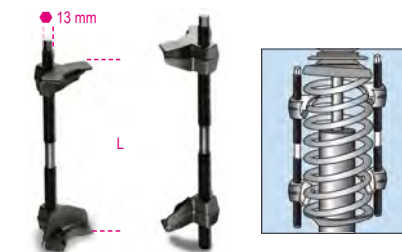

min L	Max	Ft	1	015560101
mm	mm			
65+320		95.450		

1556/2A

Lengéscsillapító rugóösszehúzó

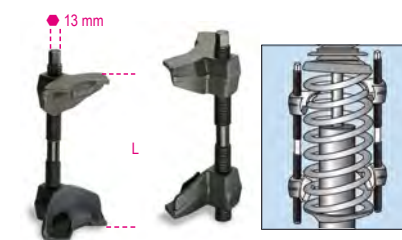

min L	Max	Ft	1	015560102
mm	mm			
65+200		95.050		

1557

Erősített dugókulcs teherautó lengéscsillapítóhoz



L	L1	Ft	1	015570137
mm	mm			
37	28	35.700		
46	34	36.150		
56	34	38.750		

1557V

Erősített dugókulcs Volvo teherautó lengéscsillapítóhoz



mm	Ft	1	015570299
27	18.250		

1557/S3

3 részes lengéscsillapító szerelő készlet, krómozott

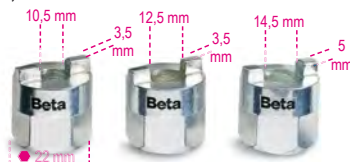

Ft	1	015570010
28.400		

1558/C4

belső és külső seeger gyűrűkhöz használható szerszám csavaros működéssel

a négyszög csatlakozónak köszönhetően mindkét használati módban nagy erőt alkalmazás történik
Szállított hegyek:
Ø 2,5-3-3,5 mm



Ø mm	Ø mm	Ft	1	015580100
5,5 ÷ 77	5,5 ÷ 77	65.900		

330x220x50 mm - 900 g

1558P

seegergyűrű hegyará a 1558 eszközhöz



Ø mm	Ft	1	015580125
2,5	2.890		
3,0	2.890		
3,5	2.890		

1558/C13

Belső és külső seeger gyűrűkhöz használható szerszámkészlet, csavaros működéssel

A négyszög csatlakozónak köszönhetően mindkét használati módban nagy erő fejthető ki

szállított hegyek:
• egyenes: Ø 2,5 - 3 - 3,5 - 3,8 mm
• 45°: Ø 2,5 - 3 - 3,5 - 3,8 mm
• 90°: Ø 2,5 - 3 - 3,5 - 3,8 mm



Ø mm	Ø mm	Ft	1	015580200
5,5 ÷ 77	5,5 ÷ 77	102.900		

330x220x45 mm - 1,6 kg

1559

Könnyített gömbfejlhúzó,
galvanizált



	A Max mm	Ø mm	Ft		
1559/22	50	18÷22	35.300	1	015590001
1559/36	90	36	157.600	1	015590036
1559/45	115	45	238.600	1	015590045

1559V/8T

Hidraulikus orsó a 1559/36 és az 1559/45
típusú gömbfejlhúzóhoz



Nm	t	Ft		
80000	8	120.600	1	015590145

1560/2

Gömbfejlhúzó, professzionális,
galvanizált



	A min÷Max mm	Ø mm	Ft		
1560/2	60÷85	20	74.150	1	015600002

1560A

Gömbfejlhúzó, galvanizált



	Ft		
1560A	103.300	1	015600601

1561/...

Gömbfejlhúzó, galvanizált



	L mm	A mm	Ø mm	Ft		
1561/1	39	36,6	18	26.600	1	015610001
1561/2	47	45,7	25	35.150	1	015610002
1561/3	63	62	30	50.300	1	015610003
1561/4	75	63	40	66.000	1	015610004

1562D

Gömbfejlhúzó

Alkalmos kormány gömbfej leszereléséhez 2 orsó és csavar
segítségével



A max mm	Ø mm	● mm	L mm	Ft		
50	39	26	155	134.400	1	015620239

1563/C4

4 darabos gömbfejszerelő készlet

légkalapáccsal való szereléshez

készlet tartalma:

- 1 fej M12x1.25 mm
- 1 fej M12x1.5 mm
- 1 fej M14x1.5 mm
- 1 fej M16x1.5 mm



22/24 mm

	Ft		
1563/C4	15.750	1	015630010

1565/1-2-3

Gömbfejszerelő villa, galvanizált



	Ø mm	L1 mm	Ft		
1565/1	18	65	30.600	1	015650001
1565/2	23	65	34.150	1	015650002
1565/3	30	88	36.150	1	015650003

1566N

Célszerszám kormánykar szereléséhez



Ø x L mm	Ø mm	□ mm	Ft		
28÷35 x 400	27	12	49.550	1	015660005
35÷45 x 190	27	-	48.550	1	015660008
35÷45 x 400	27	12	53.300	1	015660010

1566R

állítható célszerszám kormánykar
szereléséhez

12"



Ø mm	Ft		
27÷43	9.260	1	015660015

1566/G01

homokinetikus csukló lehúzó

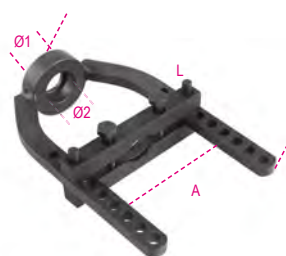

L mm	A mm	Ø1 mm	Ø2 mm	Ft		
250	115	29	36	58.950	1	015660052

1566P

féltengely bordázat
rugalmas gyűrű fogó

a fogó összenyomja a rugalmas gyűrűt, így módon
egyszerűsíti a féltengely beillesztését a homokinetikus
csuklóba



L mm	A Max mm	Ft		
280	36	26.650	1	015660091

1567

lengőkar gömbfejet és lengéscsillapítót a
toronyról lehúzó kar

A szerelő egyedül használhatja



A mm	B min÷Max mm	Ft		
1060	100÷300	132.000	1	015670001

1568

sűrített levegős
szilikon féltengely-gumiharang tágitó
8 tágitókar
maximális tágitás: 145 mm

CE



L mm	L1 mm	Ft	📦	🚚
420	195	96.550	1	015680001

1569/F

szerszámkészlet Fiat Panda, Fiat 500 és
Ford Ka szilentrögzítők lehúzásához és
behelyezéséhez



Ft	📦	🚚
174.700	1	015690021

1569/SB

szerszámkészlet a hátsó tengely szilentrögzítő,
a forgattyústengely és
kerékcsapágy tömítésének szereléséhez
• a perselyek közvetlenül használhatók mind a járműhöz mind
a hidraulikus préshez is



Ft	📦	🚚
109.400	1	015690016

📦 425x365x100 mm - 🏠 13 kg

1569CP

beütős beillesztő
kúpos csapágyakhoz és olajvédőkhöz

gyors beállítás



	Ø min+Max mm	L mm	Ft	📦	🚚
1569CP/50	9,5÷50	130	53.350	1	015690750
1569CP/90	18÷90	145	65.950	1	015690790

1570/3

Hidraulikus prés



t	L mm	L1 mm	• mm	Ft	📦	🚚
30	243	36	19	91.650	1	015700003

1580/8I

Kétkörmös csapágylehúzó
hidraulikus rásegítéssel, galvanizált

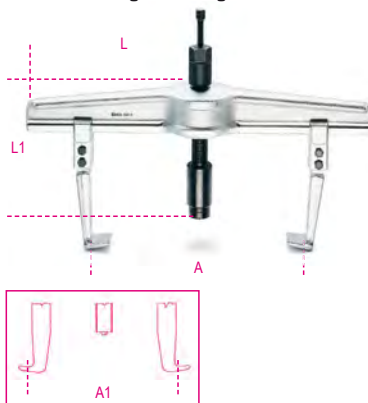

Ft	📦	🚚
608.400	1	015800008

	A min+Max mm	L mm	L1 mm	A1 min+Max mm	N Max
1580/8I	170÷640	715	280	260÷715	180000

1580GL

Lehúzó karok, hosszú kivitel, 1580/8I-hez



	L mm	Ft	📦	🚚
1580GL/8A	300	70.850	1	015800227
1580GL/8B	400	78.400	1	015800228
1580GL/8C	500	99.450	1	015800229

1585/5I - 6I - 7I

Háromkörmös csapágylehúzó
hidraulikus rásegítéssel, galvanizált

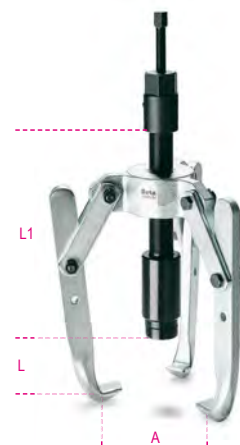

	Ft	📦	🚚
1585/5I	430.100	1	015850005
1585/6I	451.800	1	015850006
1585/7I	477.000	1	015850007

	A min+Max mm	L1 mm	L mm	N Max
1585/5I	50÷350	135	280	150000
1585/6I	50÷350	235	280	150000
1585/7I	50÷350	335	280	150000

1585GI/5 - 6 - 7

Körmekek az 1585I típusú
csapágylehúzóhoz, galvanizált

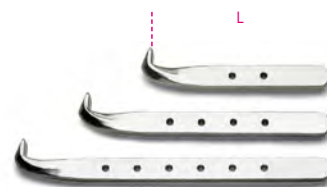

	L mm	Ft	📦	🚚
1585GI/5	135	40.250	1	015850205
1585GI/6	235	47.850	1	015850206
1585GI/7	335	57.850	1	015850207

1589VI

Hidraulikus lehúzó tengely,
barnított

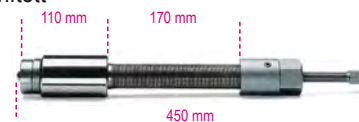

Ft	📦	🚚
254.400	1	015890001

1589PI/50 - 100 - 150

Toldal a hidraulikus lehúzó
tengelyhez



	L mm	L1 mm	Ft	📦	🚚
1589PI/50	50	70	23.750	1	015890005
1589PI/100	100	120	26.550	1	015890010
1589PI/150	150	170	29.150	1	015890015

1590

Univerzális párhuzamszorító, horganyzott



A max mm	L1 mm	Ft		
60	55	10.500	2	015900305
100	65	16.750	2	015900310
150	95	27.300	2	015900315

1591

Párhuzamszorító, horganyzott

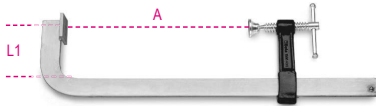

A ~	A max mm	L1 mm	Ft		
200	200	80	11.000	2	015910020
300	310	85	13.800	2	015910030
400	410	85	14.550	2	015910040
500	500	95	19.450	2	015910050
600	600	95	19.950	2	015910060
800	800	95	23.750	2	015910080
1000	1000	110	29.950	2	015910100

1593

Gyors párhuzamszorító, horganyzott

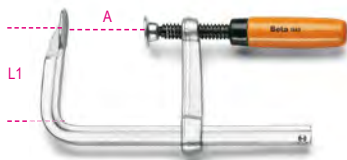

A ~	A max mm	L1 mm	Ft		
160	170	80	13.450	2	015930016
200	240	100	19.950	2	015930020
300	320	145	28.950	2	015930030

1594

Emélyűs gyors párhuzamszorító, horganyzott



A ~	A max mm	L1 mm	Ft		
200	240	145	43.400	1	015940020
250	290	145	45.850	1	015940025
300	340	145	49.400	1	015940030
400	430	150	51.800	1	015940040
500	530	150	54.350	1	015940050
600	630	150	56.300	1	015940060

1595

Gyors párhuzamszorító, horganyzott

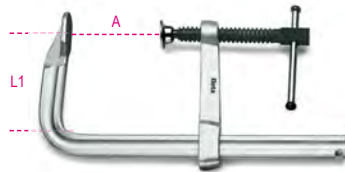

A ~	A max mm	L1 mm	Ft		
200	230	100	21.050	2	015950020
250	270	120	23.200	2	015950025
300	330	120	29.300	2	015950030
400	420	120	32.900	2	015950040
500	520	125	35.450	2	015950050
600	620	125	37.800	2	015950060
800	820	125	44.300	1	015950080
1000	1030	125	49.300	1	015950100

1599F

kovácsolt párhuzamsatu munkapadhoz

Acélöntésű. Mart és edzett pófák.
Elülső nyílás. Nagy befogási mélység.



L1 mm	BxH mm	Ø mm	A MAX mm	Ft		
100	92x46	11	125	131.200	1	015990100
125	108x54	13	150	164.300	1	015990125
150	125x62	13	200	231.500	1	015990150
175	140x70	15	220	312.300	1	015990175

1599GI

párhuzamsatu cserélhető pófákkal

- négyszögletes vezetőlappal a nagy igénybevételt jelentő munkákhoz
- cserélhető szorítófóák keményített felülettel

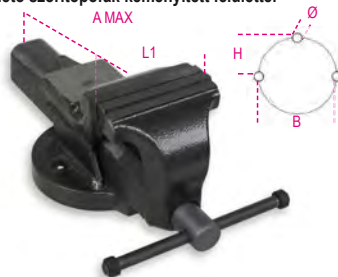

L1 mm	BxH mm	Ø mm	A MAX mm	Ft		
100	92x46	11	125	116.900	1	015990200
125	108x54	13	150	160.900	1	015990225
150	125x62	13	200	220.100	1	015990250
175	140x70	15	220	292.600	1	015990275

1599GR

szorítófopár és tartalékcsavar a 1599GI satuhoz



A mm	Ft		
1599GR 100	100	9.430	1 015990920
1599GR 125	125	11.850	1 015990925
1599GR 150	150	14.350	1 015990950
1599GR 175	175	16.800	1 015990975

1599P

párhuzamsatu munkapadhoz

Edzett pófák.
Lakkozott üllő.
Négyszögletes acél alap.

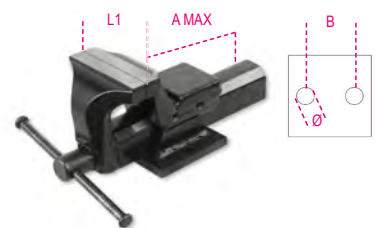

L1 mm	B mm	Ø mm	A MAX mm	Ft		
100	92	11	111	113.400	1	015990000
125	108	13	130	136.000	1	015990025
150	130	15	170	189.700	1	015990050

1599B

Forgóalap a 1599P satuhoz



1599B	1599P	Ft		
1599B 100	100	47.150	1	015990810
1599B 125	125	53.900	1	015990812
1599B 150	150	66.150	1	015990815

1599T

gépsatu

Speciális öntöttvas satu edzett és csiszolt pófákkal.
Kis és közepes, oszlopos fűrőgépekhez.

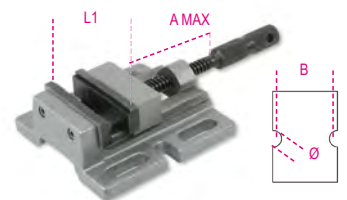

L1 mm	B mm	Ø mm	A MAX mm	Ft		
80	111	11	65	64.200	1	015990480
100	120	13	87	79.600	1	015990500

1599G

Szorítófogapár alumíniumból

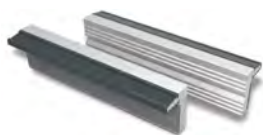

A mm	Ft	1	015990910
100	20.700	1	015990910
125	22.100	1	015990912
150	23.600	1	015990915
180	26.550	1	015990917

1600Q 8

négyágú keresztkulcs
(kapcsolószekrényekhez)

négyszög 5 / 6 / 7-8 mm
háromszög 7/9 mm
szárnyas kulcs 3-5 mm
hatszög 1/4"
hajtófejű 1.0x7 mm + keresztfejű PH2



L mm	Ft	1	016000008
76	13.250	1	016000008

1600Q 10

nyolcágú csuklós csavarkulcs, vezérlőpanel
kezelőknek

négyszög 5 / 6-7 / 8-9 mm
háromszög 5-6-7 / 8-9 / 10 mm
szárnyas kulcs 3-5 mm
hatszög 1/4"
hajtószár 1/4"



L mm	Ft	1	016000010
125	16.900	1	016000010

TANÚSÍTÁSI SZOLGÁLTATÁS MÉRŐMŰSZEREKHEZ

A mérőműszerek tanúsítása elengedhetetlen azokban az ágazatokban vagy alkalmazási területeken, ahol pontos, egyértelmű és felismerhető mérésekre van szükség.

A tanúsítás magában foglalja az Accredia tanúsítvány kiadását:

A Beta Utensili S.p.A. kérésre vállalja a tolmérők, digitális tolmérők, mérőórák, mikrométerek és mérőidomok tanúsítását. A szolgáltatás igénybevételéhez keresse márkakereskedésünket.



1650

Tolómérő acélból, tokban,
pontosság 0.05 mm

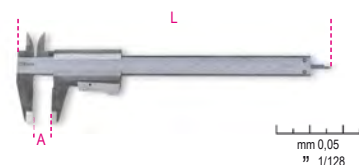

UNI EN ISO 13385-1DIN 862

A max mm	L mm	Ft	1	016500001
150	235	24.500	1	016500001
200	290	32.250	1	016500002

1650FD

Tolómérő féktárcsához,
rozsdamentes acélból,
pontosság 0.1 mm

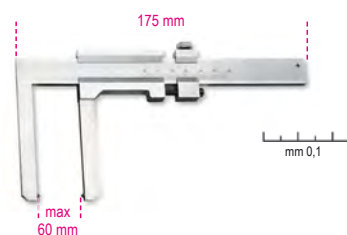

Ft	1	016500050
89.000	1	016500050

1650FT

Tolómérő dobfekekhez,
rozsdamentes acélból,
pontosság 0.05 mm

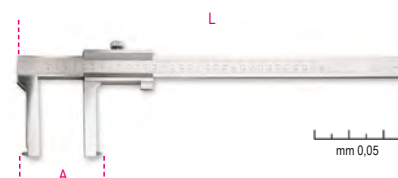

A max mm	L mm	Ft	1	016500060
1650FT/1	350	438	162.800	1 016500060
1650FT/2	500	550	289.800	1 016500070

1651DGTB

digitális tolmérő,
pontosság: 0,01 mm

Jellemzők:

- pontosság: 0,01 mm
- csúszórész csavarral állítható
- mm/coll megjelenítés
- bármely helyzetben nullázható
- 300 mm-ig kihúzható négyszögletes mélységmérő rúd
- kemény műanyag dobozban

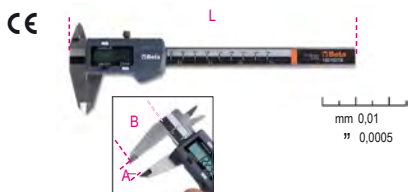

UNI EN ISO 13385-1DIN 862CE

A Max mm	L mm	B mm	Ft	1	016510211
150	235	40	44.200	1	016510211
200	285	50	57.600	1	016510212
300	400	60	75.300	1	016510213



1651DGTB/IP

digitális tolómérő,
pontosság: 0,01 mm,
IP67 védelem

- pontosság: 0,01 mm
- csúszórész csavarral állítható
- mm/coll megjelenítés
- csúsztatásra automatikusan bekapcsol
- bármely helyzetben nullázható
- HOLD funkció
- abszolút és inkrementális mérés

Az IP67 védelmi fokozat garantálja a teljes védelmet a por és a folyadékok ellen, vízhatlan

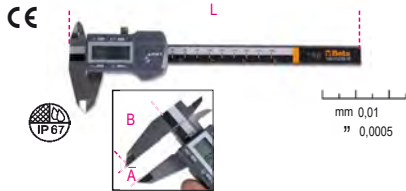

UNI EN ISO 13385-1 DIN 862CE

A Max mm	L mm	B mm	Ft	1	016510711
150	235	40	79.750	1	016510711

270x115x35 mm - 450 g

1652

Órás tolómérő nemesített acélból
kemény műanyag dobozban,
pontosság 0.02 mm

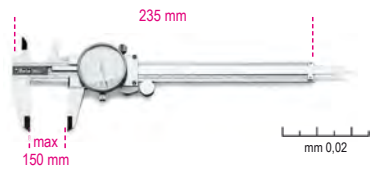

UNI EN ISO 13385-1DIN 862

1652	Ft	1	016520016
	51.750	1	016520016

1654

Tolómérő rozsdamentes acélból,
tokban, pontosság 0.02 mm



UNI EN ISO 13385-1DIN 862

A max mm	L mm	Ft	1	016540020
200	330	114.400	1	016540020
300	410	155.700	1	016540030



1654DGT

Digitális tolómérő
Pontosság: 1/100 mm

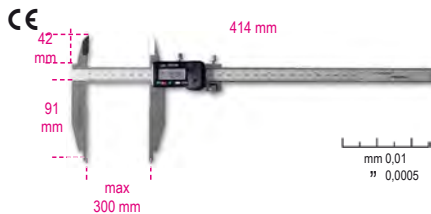

UNI EN ISO 13385-1DIN 862CE

1654DGT	Ft	1	016540111
	264.700	1	016540111

1656

Mélységmérő rozsdamentes acélból,
tokban, pontosság 0.02 mm



UNI EN ISO 13385-2DIN 862

A max mm	L mm	Ft	1	016560020
200	260	53.350	1	016560020
300	360	78.950	1	016560030

1657DGT/2

Digitális mélységmérő rozsdamentes
acélból, fadobozban,
pontosság: 0.01 mm

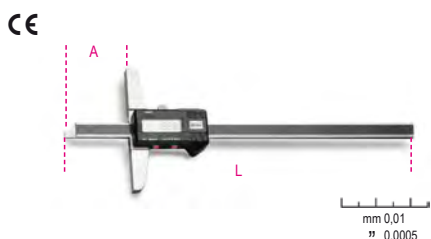

UNI EN ISO 13385-2DIN 862CE

1657DGT/2	A max mm	L mm	Ft	1	016570002
	200	270	100.500	1	016570002

1658/...

Mikrométer kemény műanyag
dobozban, pontosság 0.01 mm



DIN 863/II

	A mm	Ft	1	016580025
1658/25	0+25	31.050	1	016580025
1658/50	25+50	34.200	1	016580050
1658/75	50+75	38.150	1	016580075
1658/100	75+100	41.650	1	016580100

1658/C4

4-részes mikrométer készlet,
fadobozban



DIN 863

1658/C4	Ft	1	016580001
	124.900	1	016580001

1658/25	0+25 mm
1658/50	25+50 mm
1658/75	50+75 mm
1658/100	75+100 mm

365x245x35 mm - 2,5 kg

1658DGTB

Digitális külső mikrométer, IP65, pontosság:
0,001 mm

- pontosság: 0,001 mm
- edzett acél mérőfelület
- csúszórész rögzítőkarral állítható
- mm/coll megjelenítés
- bármely helyzetben nullázható
- abszolút és inkrementális mérés
- kalibrálókulccsal szállítva

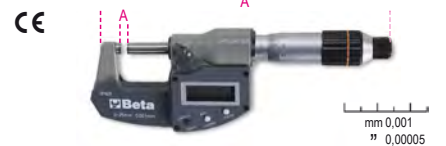

DIN 863CE

	Ft	1	016580525
1658DGTB 25	99.700	1	016580525
1658DGTB 50	124.200	1	016580550



1658SP/1

Mikrométer-állvány



1658SP/1	Ft	21.500	1	016580910
----------	----	--------	---	-----------

1659

Mérőórás vastagsgmérő,
pontosság 0.01 mm

C = mérési tartomány

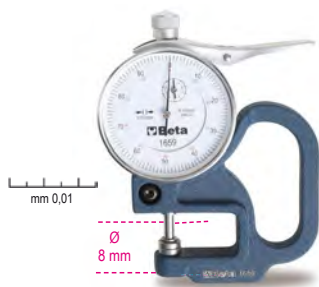

1659	C mm	0÷10	Ft	80.350	1	016590001
------	------	------	----	--------	---	-----------

1662/1 - 1662/2

Mérőóra, kemény műanyag
dobozban, pontosság 0.01 mm

C = mérési tartomány



DIN 878						
1662/1	C mm	0÷5	Ft	36.750	1	016620001
1662/2	C mm	0÷10	Ft	45.250	1	016620010

1662DGT/A

digitális mérőóra
század pontosságú mérés

C = Mérési tartomány

CE



1662DGT/A	C mm	0-12,5	Ft	112.600	1	016620311
-----------	------	--------	----	---------	---	-----------

1662AN

Mérőóra tapintóval
Pontosság: 1/100 mm

C=Mérési tartomány



DIN 2270						
1662AN	C mm	0÷0,8	Ft	86.150	1	016620200

1662SP0

Állítható mágneses állvány



1662SP0	Ft	30.450	1	016620800
---------	----	--------	---	-----------

1662SP2

Állítható mágneses állvány



1662SP2	Ft	55.250	1	016620910
---------	----	--------	---	-----------

1666

Precíziós derékszög rozsdamentes
acélból, köszörült és tükrösített



DIN 875/0						
L mm	L1 mm	Ft				
100	70	25.150	1	016660210		
150	100	36.500	1	016660215		
200	130	43.550	1	016660220		
250	165	56.850	1	016660225		
300	200	70.950	1	016660230		

1666A

Talpas precíziós derékszög
rozsdamentes acélból,
köszörült és tükrösített



DIN 875/0						
L mm	L1 mm	Ft				
100	70	37.600	1	016660110		
150	100	50.400	1	016660115		
200	130	71.050	1	016660120		
250	170	89.300	1	016660125		
300	200	113.900	1	016660130		

1668

talpas precíziós derékszög
normalizált acélból
köszörült



DIN 875/2						
L mm	L1 mm	Ft				
100	70	11.100	2	016680210		
150	100	15.100	2	016680215		
200	130	19.100	2	016680220		
250	165	28.350	1	016680225		
300	174	34.600	1	016680230		



1668A

Talpas precíziós derékszög normalizált acélból, köszörült



DIN 875/2

L mm	L1 mm	Ft	📦	🚚
100	70	13.250	2	016680110
150	100	20.250	2	016680115
200	130	25.850	2	016680120
250	165	36.900	1	016680125
300	176	44.250	1	016680130

1670

Precíziós derékszög acélból, köszörült



L mm	L1 mm	Ft	📦	🚚
100	70	7.530	3	016700010
150	100	7.770	3	016700015
200	130	8.090	3	016700020
250	160	8.190	3	016700025
300	175	8.940	3	016700030
400	230	14.350	2	016700040
500	280	15.200	2	016700050
600	330	16.350	2	016700060
800	420	23.450	1	016700080
1000	500	26.900	1	016700099

1670A

Talpas precíziós derékszög acélból, köszörült



L mm	L1 mm	Ft	📦	🚚
100	70	9.200	3	016700110
150	100	9.750	3	016700115
200	130	10.050	3	016700120
250	165	11.900	3	016700125
300	175	15.050	3	016700130
400	230	19.150	2	016700140
500	280	25.550	2	016700150
600	330	30.300	2	016700160
800	420	37.700	1	016700180
1000	500	44.450	1	016700199

1672

Állítható szögsablon csúszo szárral, a szár és az alaplap acélból készült, krómozott

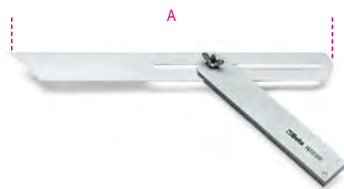

A mm	Ft	📦	🚚
300	21.400	2	016720030

1672A

Állítható szögsablon csúszo szárral a szár krómozott acélból, az alaplap alumíniumból készült

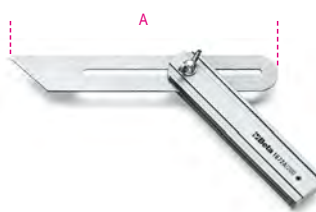

A mm	Ft	📦	🚚
200	11.250	3	016720120
300	12.250	3	016720130

1674A

Asztalos derékszög, a szár acélból, az alaplap alumíniumból készült



L mm	L1 mm	Ft	📦	🚚
300	169	10.400	2	016740130
400	214	13.050	2	016740140

1676

Szögmérő, rozsdamentes acélból

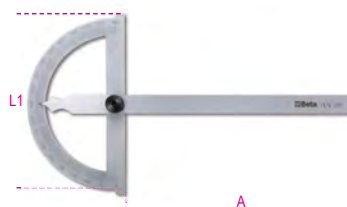

A	A mm	L1 mm	G mm	Ft	📦	🚚
120	120	80	1°	16.500	2	016760012
150	165	120	1°	19.050	2	016760015
200	210	150	1°	22.850	2	016760020
300	310	200	1°	30.400	1	016760030

1678/C3

Dőlésszögmérő, rozsdamentes acélból, kemény dobozban



1678/C3	L Max mm	D mm	Ft	📦	🚚
	300	70	117.600	1	016780030

1679

Univerzális görgős mérőeszköz, rozsdamentes acélból, pontosság 0.1 mm

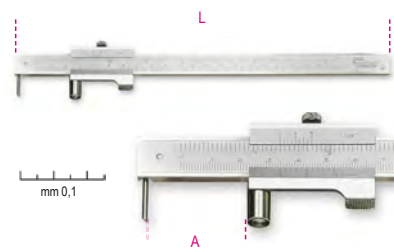

L mm	A Max mm	Ft	📦	🚚
235	200	35.600	1	016790020

1679/PR

cserehegy a 1679 tolómérőhöz



1679/PR	Ft	📦	🚚
	5.710	1	016790021

1680

Jelölő körző, edzett acéltest és hegyek

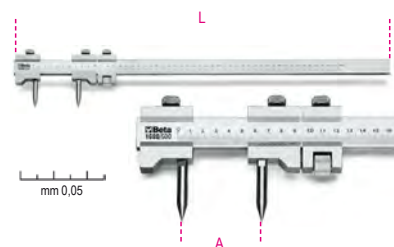

L mm	A Max mm	Ft	📦	🚚
660	500	117.600	1	016800050

1680A

Belső jelölő körző, edzett acélhegyek

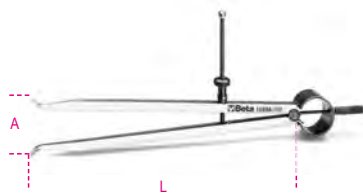

L mm	A Max mm	Ft	📦	📄
150	144	7.620	2	016800115
200	200	9.430	2	016800120
250	245	11.600	1	016800125
300	300	13.350	1	016800130

1680B

Külső jelölő körző, edzett acélhegyek



L mm	A Max mm	Ft	📦	📄
150	155	7.620	2	016800215
200	190	9.430	2	016800220
250	235	11.600	1	016800225
300	280	13.350	1	016800230

1680C

Precíziós jelölő körző, egyenes edzett acélhegyek



L mm	A Max mm	Ft	📦	📄
150	138	7.620	2	016800315
200	190	9.430	2	016800320
250	235	11.600	1	016800325
300	280	13.350	1	016800330

1682

Rugalmas skálás vonalzó, rozsdamentes acélból



L mm	H mm	± mm	Ft	📦	📄
150	13	0,5	1.230	5	016820015
200	13	0,5	1.300	5	016820020
250	13	0,5	1.630	5	016820025
300	13	0,5	2.110	5	016820030
500	13	0,5	4.580	2	016820050
1000	13	0,5	12.150	2	016820100

1683

Félmerev skálás vonalzó, rozsdamentes acélból

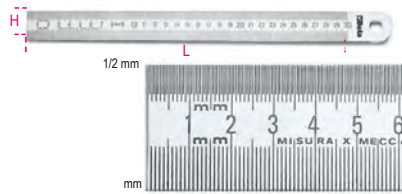

L mm	H mm	± mm	Ft	📦	📄
300	30	1	3.630	5	016830030
500	30	1	6.040	2	016830050
1000	30	1	15.250	2	016830100
1500	30	1	34.500	1	016830150

1685/C7

7-részes mérő- és jelölő készlet



1685/C7	Ft	📦	📄
	116.100	1	016850110

	1650	160 mm
	1658/25	0+25 mm
	1670	100 mm
	1680C	150 mm
	1682	150 mm
	1688BC	165 mm
	1688BC/R	

320x210x37 mm - 1,2 kg

1687A

90°-ban hajlított rajztű



1687A	L mm	L1 mm	Ft	📦	📄
	153	80	2.570	1	016870120

1687AC

Rövid 45°-ban hajlított rajztű



1687AC	L mm	L1 mm	Ft	📦	📄
	153	80	2.570	1	016870125

1687D

Egyenes rajztű



1687D	L mm	L1 mm	Ft	📦	📄
	153	80	2.570	1	016870110

1687U

Hajlított rajztű



1687U	L mm	L1 mm	Ft	📦	📄
	153	80	2.570	1	016870115

1687/S4

4 darabos rajztű készlet



1687/S4	Ft	📦	📄
1687A-1687AC 1687D-1687U	10.300	1	016870150

1688

Rajztű, edzett acélból



1688	L mm	Ø mm	Ft	📦	📄
	250	2	3.360	5	016880020

1688A

Rajztű, edzett acélból



1688A	L mm	Ø mm	Ft	📦	📄
	200	4	6.080	5	016880120

1688PC

rajztű
edzett acél, krómozott



	L mm	Ø mm	Ft		
1688PC	150	1	14.800	1	016880300

1688PC/R

póthegy az 1688PC rajztűhöz



	Ft		
1688PC/R	4.340	1	016880310

1688M

Ácsceruza



	L mm	Ft		
1688M	180	395	50	016880880

1690F

Üvegszálal colstok
Pontossági osztály: III

CE



	L m	S mm	Ft		
1690F/2	2	17	4.800	5	016900220

1690L

Colstok nyírfából
Pontossági osztály: III

CE



	L m	S mm	Ft		
1690L/2	2	17	5.340	5	016900200

Beta

1691BM

mérőszalag
kétkomponensű, ütésálló ABS ház
acélszalag
II. pontossági osztály

CE



	L m	S mm	Ft		
1691BM/5	5	25	6.590	1	016910205
1691BM/8	8	32	9.530	1	016910208
1691BM/10	10	32	11.450	1	016910210

1691MG

mágneses mérőszalag
ütésálló ABS ház,
acélszalag,
II. pontossági osztály

CE



	L m	S mm	Ft		
1691MG/5	5	25	8.090	1	016910405
1691MG/8	8	25	11.200	1	016910408
1691MG/10	10	25	12.400	1	016910410

1692

Mérőszalag, ütésálló bimateriál ABS-ház,
acélszalag, pontossági osztály: II

CE



	L m	S mm	Ft		
1692/2	2	16	3.140	5	016920052
1692/3	3	16	3.930	5	016920053
1692/5	5	19	5.620	5	016920055
1692/8	8	25	8.200	5	016920058

1693

lézeres távolságmérő,
20 m

MÉRÉSEK:

- egyedi távolságmérés
- folyamatos mérés vagy minimum mérés
- automatikus kikapcsolás
- elem üzemidő: akár 4 000 mérés



CE
IP54

MŰSZAKI ADATOK

Mérési tartomány: 0,05 ÷ 20m (0,2ft ÷ 66 ft)
Lépték: m, in, ft
Mérési pontosság: ±1,5 mm (± 0,06 in)
Lézerosztály: 2
Elemek: AAA 2 x 1,5V

	H mm	L mm	S mm	Ft		
1693 20	100	36	23	57.350	1	016930020

1693M

multifunkciós lézeres távolságmérő, 80m

MÉRÉSEK:

- egyedi távolságmérés
- folyamatos mérés vagy minimum mérés

FUNKCIÓK:

- összeadás/kivonás
- területmérés
- térfogatmérés
- közvetett mérés (Pythagorasz mérőmódszer)
- dőlésmérés

Automatikus kikapcsolás

Puha szövet tartóval szállítva

Elem üzemidő: akár 4 000 mérés



CE
IP54

MŰSZAKI ADATOK

Mérési tartomány: 0,05 ÷ 80 m (0,2ft ÷ 229 ft)
Lépték: m, in, ft
Mérési pontosság: ±1,5 mm (± 0,06 in)
Lézerosztály: 2
Max. tárhely: 99 egység

Elemek: AAA 2 x 1,5V

	H mm	L mm	S mm	Ft		
1693M 80	115	48	29	88.750	1	016930080

Beta

1694/L

Mérőszalag, ütészálló ABS-ház,
PVC-borítású üvegszál szalag,
pontossági osztály: III



	L m	S mm	Ft		
1694L10	10	13	5.110	1	016940110
1694L20	20	13	6.270	1	016940120

1694A/L

Fogantyús mérőszalag,
ütészálló ABS-ház,
PVC borítású üvegszál szalag,
Pontossági osztály: III



	L m	S mm	Ft		
1694A/L30	30	13	12.600	1	016940230
1694A/L50	50	13	16.350	1	016940250

1694B/L

Fogantyús mérőszalag, alumínium ház,
lakkozott acélszalag,
pontossági osztály: II



	L m	S mm	Ft		
1694B/L50	50	12,5	25.200	1	016940350

Beta

1695XS

Zseb vízmérték V-formájú mérőfelülettel,
mágneses, profilírozott alumínium
2 törésbiztos libella
Pontosság: 1 mm/m



L mm	H mm	S mm	Ft		
70	48,5	20	5.210	5	016950250

1696

Vízmérték eloxált alumíniumból,
2 törésbiztos libella,
pontosság: 1 mm/m



L mm	H mm	S mm	Ft		
200	50	19	8.680	2	016960002
400	50	19	9.980	2	016960004
500	50	19	10.800	2	016960005
600	50	19	11.600	2	016960006
800	50	19	14.500	2	016960008
1000	50	19	16.200	2	016960010

1696A

Vízmérték présöntött alumíniumból,
1 mérőfelület, 2 törésbiztos libellával,
pontosság: 1 mm/m



L mm	H mm	S mm	Ft		
300	43	23	12.400	2	016960103
400	43	23	13.150	2	016960104
500	43	23	14.300	2	016960105
600	43	23	15.750	2	016960106
800	43	23	25.450	1	016960108
1000	43	23	31.400	1	016960110

1696B

Mágneses vízmérték eloxált
alumíniumból, 2 törésbiztos libella,
pontosság: 1 mm/m



L mm	H mm	S mm	Ft		
200	49	22	13.350	2	016960202
300	49	22	14.050	2	016960203
400	49	22	14.850	2	016960204
500	49	22	17.800	2	016960205
600	49	22	19.000	2	016960206

1696D

Vízmérték présöntött alumíniumból
fogantyúval
4 finoman megmunkált mérőfelület és 3
törésbiztos libella
Pontosság: 1 mm/m



L mm	H mm	S mm	Ft		
300	47	25	11.600	2	016960353
400	47	25	13.150	2	016960354
500	47	25	14.300	2	016960355
600	47	25	16.200	2	016960356

1696S

Szintezőléc alumíniumból
2 törésbiztos libellával



L mm	H mm	S mm	Ft		
1500	90	25	42.250	1	016960415
2000	90	25	49.750	1	016960420
2500	90	25	62.600	1	016960425
3000	90	25	70.650	1	016960430

Beta

Beta

1697

keresztlézeres szintező,
30 méter, zöld fényű,
mágneses talppal és fali konzollal,
tokban

MŰSZAKI ADATOK

- önbeálló kereszt
- kézi használatához az önbeálló funkció kikapcsolható
- lézertápellátás 515 Nm, 2. lézertápellátás
- hatósugár: 30 m
- pontosság: 5 m-en ± 1 mm
- önbeálló tartomány: $3^\circ \pm 0.5^\circ$

- ABS és csúszásmentes gumi test
- 1/4"-os csatlakozó
- 2xAA elem
- elem üzemidő: 4 óra

TALP:

- mágneses talp egyedi és kombinált felhasználásra, 1/4"-os csatlakozó
- az állítható rögzítőkonzollal különböző fa- és fémpofilokhoz rögzíthető (a mágneses talppal együtt alkalmazva)
- gyors, 90°-os vízszintes és függőleges beállítás

CE



IP55

H mm	L mm	S mm	Ft	csomag	alkotórész
82	57	89,5	104.900	1	016970030

320x230x90 mm

1699L

Precíziós vízmérték, vasöntvény,
köszörült prizmaaplappal,
2 törésbiztos libella, fadobozban,
pontosság: 0.05 mm/m



DIN 877

L mm	A mm	Ft	csomag	alkotórész
1699L 200	49	125.300	1	016990002

1699L/1

Precíziós vízmérték kokillaöntvény,
köszörült prizmaaplappal,
2 törésbiztos libella, fadobozban,
pontosság: 0.02 mm/m



DIN 877

L mm	A mm	Ft	csomag	alkotórész
1699L/1 200	49	131.700	1	016990005

1699Q

Precíziós keretes vízmérték,
vasöntvény, 2 prizmaalakú
és 2 köszörült lapos alappal,
2 törésbiztos libella,
pontosság: 0.05 mm/m

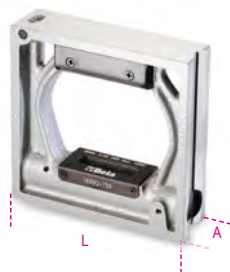

DIN 877

L mm	A mm	Ft	csomag	alkotórész
1699Q 150	40	177.300	1	016990015
200	48	221.000	1	016990020

1700N

Hegyes véső



L mm	S mm	Ft	csomag	alkotórész
1700N 250	16	6.280	5	017000005
300	16	6.800	5	017000006

1700N/PM

Hegyes véső
kézvédővel



L mm	S mm	Ft	csomag	alkotórész
1700N/PM 250	16	8.580	2	017000105
300	16	9.630	2	017000106

1701N

Laposvéső



L mm	A mm	S mm	Ft	csomag	alkotórész
1701N 250	23	16	6.870	5	017010001
300	23	16	7.370	5	017010003

1701N/PM

Laposvéső
kézvédővel



L mm	A mm	S mm	Ft	csomag	alkotórész
1701N/PM 250	23	16	8.900	2	017010101
300	23	16	9.950	2	017010103

1701PMR

Tartalék kézvédő az 1700N-hez
és az 1701N-hez



D mm	L mm	Ft	csomag	alkotórész
1701PMR 16	115	4.080	1	017010206

1701NE/...

Villanszerelő laposvéső



	SxL mm	Ft	csomag	alkotórész
1701NE3	10x200	4.110	5	017010406
1701NE4	10x250	4.380	5	017010409

1702N

Széles laposvéső



A mm	SxH mm	Ft	csomag	alkotórész
1702N 50	13x23	8.790	2	017020005
70	13x23	9.080	2	017020007

1702N/PM

Széles laposvéső
kézvédővel



A mm	SxH mm	Ft	csomag	alkotórész
1702N/PM 50	13x23	10.600	2	017020105
70	13x23	11.850	2	017020107



A szerszámot utóélezés közben
hűteni kell!

1702PMR

Tartalék kézvédő a 1702N-hez



L mm	Ft	csomag	alkotórész
1702PMR 115	3.090	1	017020200

1704

Szöghúzóvas ácsoknak nemesített acélból

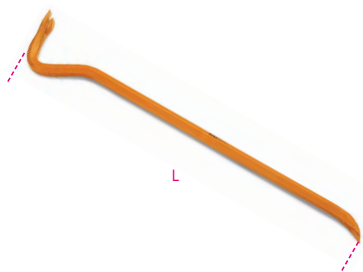

L mm	6 mm	mm	mm	Ft		
500	16	35	28	11.450	2	017040050
600	16	34	26	13.050	2	017040060
800	18	38	29	18.150	2	017040080

1704A

Feszítővas lapos és hegyes véggel kovácsolt acélból

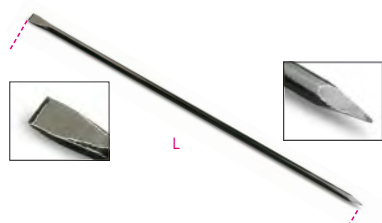

L mm	6 mm	mm	Ft		
1500	25	45	36.250	1	017040110
2000	28	55	46.800	1	017040120

1704C

Feszítővas lapos és hegyes véggel kovácsolt acélból, lakkozott



L mm	8 mm	min-MAX mm	mm	Ft		
1200	21-31	39	39.700	1	017040210	
1400	31-37	42	47.600	1	017040212	
1600	25-37	42	58.650	1	017040215	

1705

Csapózsínór alumíniumból



L m	Ft		
1705 30	7.580	4	017050001

1705PT

Jelölő por



g	Ft		
250	5.020	5	017050025

1706DGT

Digitális gumiprofil-mélységmérő



1706DGT	Ft		
	14.300	1	017060011

1707

Menetsablon

Az ISO-szabvány szerinti 60°-os metrikus és 55° Whitworth menetekhez



P (ISO)	W	Ft		
0,25÷6	62÷4x1"	7.030	5	017070001

1707A/1-2-3

Rádiusz-sablon



R mm	L mm	n	Ft		
1707A/1 1,0÷7,0	70	34	10.900	2	017070007
1707A/2 7,5÷15	85	32	11.500	2	017070015
1707A/3 15,5÷25	85	30	11.500	2	017070025

1708/8-13-20

Metrikus hézagmérő

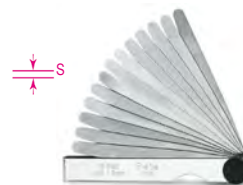

	Ft		
1708/8 S = 0,05÷0,50 mm	2.700	5	017080008
1708/13 S = 0,05÷1,00 mm	2.970	5	017080013
1708/20 S = 0,05÷1,00 mm	4.870	5	017080020

1709/10-1709/18

Csavaranyavágó, galvanizált



	L mm	A max mm	Ft		
1709/10	90	17 (M10)	21.550	1	017090010
1709/18	108	25 (M16)	34.300	1	017090018

1710

Hidraulikus csavaranyavágó, galvanizált



C min mm	C max mm	Ft		
7 (M4)	22 (M14)	99.250	1	017100001

1712E/1-2-3

Flexibilis mágneses csavarkiszedő

F = mágneserő



	L mm	D mm	F kg	Ft		
1712E/1	420	7,5	0,5	12.250	2	017120011
1712E/2	530	15	1,8	15.800	2	017120012
1712E/3	532	19	3,0	19.150	2	017120013

1712TF

Flexibilis teleszkópos mágneses csavarkiszedő

• Autó ablakos fúvóka tisztítóval
F= Mágneserő



L mm	D mm	F kg	Ft		
150÷590	11	1	7.960	1	017120600

1713M

Flexibilis csavarkiszedő

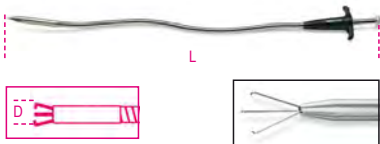

L mm	D mm	Ft	csomagolás	art. szám
500	7	16.850	2	017130011
1000	7	30.200	1	017130015

1714

Vizsgálótűkőr



L mm	D mm	Ft	csomagolás	art. szám
1714	155	25	5	017140001

1715

Teleszkópos csuklós vizsgálótűkőr



L mm	D mm	Ft	csomagolás	art. szám
1715	180+540	30	1	017150001

1715FL/A

Flexibilis négyzet alakú vizsgálótűkőr



L mm	A mm	B mm	Ft	csomagolás	art. szám	
1715FL/A	600	53	90	15.400	1	017150110

1715R/FL

2 darabos póttűkőr készlet az 1715FL/A és 1715FL/B eszközhöz

L mm	Ft	csomagolás	art. szám
1715R/FL	3.160	1	017150151

1715FL/B

Világító flexibilis téglalap alakú vizsgálótűkőr

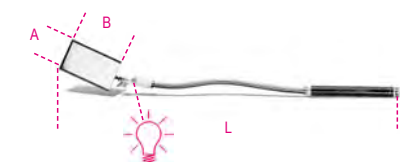

L mm	A mm	B mm	Ft	csomagolás	art. szám	
1715FL/B	553	53	90	18.750	1	017150115

1715B/R5L

5 darabos pótgéő készlet az 1715FL/B eszközhöz

L mm	Ft	csomagolás	art. szám
1715B/R5L	2.540	1	017150152

1716A

Szögletes hegyű ár általános használatra



L mm	L1 mm	mm	Ft	csomagolás	art. szám	
1716A	240	125	6	4.410	3	017160040

1716P

Hántoló tömítéshez



L mm	L1 mm	mm	Ft	csomagolás	art. szám	
1716P	250	125	6	5.280	3	017160020

1716Q

Négyzögletes hegyű ár



L mm	L1 mm	mm	Ft	csomagolás	art. szám	
1716Q	215	100	6	3.780	5	017160010

1716R

Kerekhegyű ár



L mm	L1 mm	mm	Ft	csomagolás	art. szám	
1716R	215	100	6	3.780	5	017160001

1716U

Hajlított hegyű ár általános használatra



L mm	L1 mm	mm	Ft	csomagolás	art. szám	
1716U	195	80	6	4.410	3	017160025

1717A

Kétélű hántoló, lakkozott, fanyélel



L mm	L1 mm	L2 mm	Ft	csomagolás	art. szám
150	70	260	8.290	2	017170015
200	75	310	9.100	2	017170020
250	100	360	10.100	2	017170025

1717B

Háromélű hántoló, lakkozott, fanyélel



L mm	L1 mm	L2 mm	Ft	csomagolás	art. szám
150	75	260	7.050	2	017170115
200	85	310	8.330	2	017170120
250	100	360	9.320	2	017170125

1717C

Lapos hántoló, lakkozott fanyélel



L mm	S mm	L1 mm	Ft	csomagolás	art. szám
150	18	270	7.060	2	017170215
200	20	320	8.070	2	017170220
250	25	370	9.050	2	017170225

1717D

Lapos hántoló vágóélel, lakkozott fanyélel



L mm	S mm	L1 mm	Ft	csomagolás	art. szám	
1717D 150	150	23	240	9.840	2	017170320

1717T

háromélű hántoló, 2 pengével



L mm	Ft	csomagolás	art. szám	
1717T	310	4.770	1	017170610

1717T RT

tartalék háromszögű penge



L mm	Ft	csomagolás	art. szám	
1717T RT	65	1.010	1	017170660

1717T RS

tartalék profilos penge



L mm	Ft	csomagolás	art. szám	
1717T RS	65	1.010	1	017170661

1717V

festékkaparók,
több oldalon használható pengék



	L mm	A mm	Ft		
1717V 38	200	38	3.190	1	017170703
1717V 65	285	65	6.950	1	017170706

1717V R

tartalék penge a 1717V termékhez



	L mm	Ft		
1717V R38	38	1.010	1	017170753
1717V R65	65	1.460	1	017170756

RESZELŐPROFILOK

Egyengető

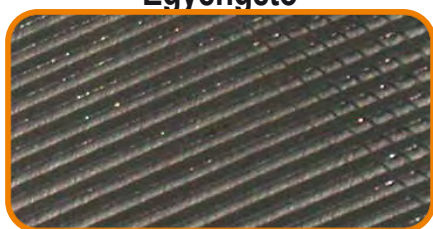

Nagyoló

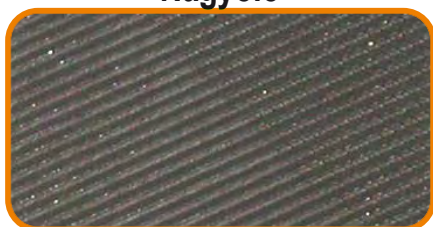

Simító



1718D...Q

szögletes nagyoló reszelő markolat nélkül

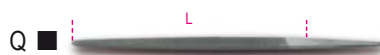

	L mm	L "	Ft		
1718D6/Q	150	6	3.530	5	017180121
1718D8/Q	200	8	4.210	5	017180131
1718D10/Q	250	10	5.750	5	017180141

1718A...Q

szögletes egyengető reszelő markolat nélkül

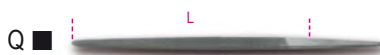

	L mm	L "	Ft		
1718A6/Q	150	6	3.620	5	017180021
1718A8/Q	200	8	4.340	5	017180031
1718A10/Q	250	10	6.000	5	017180041

1718D...T

háromszög nagyoló reszelő markolat nélkül



	L mm	L "	Ft		
1718D6/T	150	6	4.270	5	017180123
1718D8/T	200	8	5.440	5	017180133
1718D10/T	250	10	7.160	5	017180143

1718A...T

háromszög egyengető reszelő markolat nélkül



	L mm	L "	Ft		
1718A6/T	150	6	4.340	5	017180023
1718A8/T	200	8	5.630	5	017180033
1718A10/T	250	10	7.570	5	017180043

1718D...P

lapos nagyoló reszelő markolat nélkül



	L mm	L "	Ft		
1718D6/P	150	6	3.370	5	017180125
1718D8/P	200	8	3.990	5	017180135
1718D10/P	250	10	5.360	5	017180145

1718A...P

lapos egyengető reszelő markolat nélkül



	L mm	L "	Ft		
1718A6/P	150	6	3.530	5	017180025
1718A8/P	200	8	4.110	5	017180035
1718A10/P	250	10	5.700	5	017180045

1718D...M

félkerek nagyoló reszelő markolat nélkül



	L mm	L "	Ft		
1718D6/M	150	6	4.660	5	017180127
1718D8/M	200	8	5.750	5	017180137
1718D10/M	250	10	7.540	5	017180147

1718A...M

félkerek egyengető reszelő markolat nélkül



	L mm	L "	Ft		
1718A6/M	150	6	4.870	5	017180027
1718A8/M	200	8	5.900	5	017180037
1718A10/M	250	10	7.960	5	017180047

1718D...R

kerek nagyoló reszelő markolat nélkül



	L mm	L "	Ft		
1718D6/R	150	6	3.370	5	017180129
1718D8/R	200	8	3.990	5	017180139
1718D10/R	250	10	5.250	5	017180149

1718A...R

kerek egyengető reszelő markolat nélkül



	L mm	L "	Ft		
1718A6/R	150	6	3.530	5	017180029
1718A8/R	200	8	4.050	5	017180039
1718A10/R	250	10	5.480	5	017180049

1718D...S5

5 darabos nagyoló reszelő készlet markolat nélkül



	L mm	L "	Ft		
1718D6/S5	150	6	19.200	1	017180130
1718D8/S5	200	8	23.400	1	017180140
1718D10/S5	250	10	31.050	1	017180150

Beta
Quality Tools

1718A...S5

5 darabos egyengető reszelő készlet markolat nélkül



■ Q
▲ T
| P
▷ M
● R

	L mm	L "	Ft		
1718A6/S5	150	6	19.900	1	017180030
1718A8/S5	200	8	24.050	1	017180040
1718A10/S5	250	10	32.700	1	017180050

1719BMD...Q

szögletes nagyoló reszelő markolattal



	L mm	L "	Ft		
1719BMD6/Q	150	6	5.130	5	017190191
1719BMD8/Q	200	8	5.600	5	017190221
1719BMD10/Q	250	10	7.440	5	017190241
1719BMD12/Q	300	12	9.910	3	017190325

1719BMA...Q

szögletes egyengető reszelő markolattal



	L mm	L "	Ft		
1719BMA6/Q	150	6	5.020	5	017190021
1719BMA8/Q	200	8	5.900	5	017190052
1719BMA10/Q	250	10	7.630	5	017190071
1719BMA12/Q	300	12	11.450	3	017190311

1719BMX...Q

szögletes simító reszelő markolattal



	L mm	L "	Ft		
1719BMX6/Q	150	6	5.350	5	017190022
1719BMX8/Q	200	8	6.930	5	017190053
1719BMX10/Q	250	10	9.340	5	017190072

1719BMD...T

háromszög nagyoló reszelő markolattal



	L mm	L "	Ft		
1719BMD6/T	150	6	5.900	5	017190193
1719BMD8/T	200	8	6.890	5	017190223
1719BMD10/T	250	10	8.920	5	017190243
1719BMD12/T	300	12	13.300	3	017190326

1719BMA...T

háromszög egyengető reszelő markolattal



	L mm	L "	Ft		
1719BMA6/T	150	6	5.910	5	017190023
1719BMA8/T	200	8	7.260	5	017190054
1719BMA10/T	250	10	9.030	5	017190073
1719BMA12/T	300	12	13.850	3	017190313

1719BMX...T

háromszög simító reszelő markolattal



	L mm	L "	Ft		
1719BMX6/T	150	6	7.130	5	017190024
1719BMX8/T	200	8	9.340	5	017190055
1719BMX10/T	250	10	12.000	5	017190074

1719BMD...P

lapos nagyoló reszelő markolattal

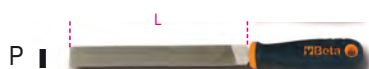

	L mm	L "	Ft		
1719BMD6/P	150	6	5.120	5	017190195
1719BMD8/P	200	8	5.360	5	017190225
1719BMD10/P	250	10	7.140	5	017190245
1719BMD12/P	300	12	9.730	3	017190327

1719BMA...P

lapos egyengető reszelő markolattal



	L mm	L "	Ft		
1719BMA6/P	150	6	5.250	5	017190025
1719BMA8/P	200	8	5.840	5	017190056
1719BMA10/P	250	10	7.540	5	017190075
1719BMA12/P	300	12	11.000	3	017190315

1719BMX...P

lapos simító reszelő markolattal



	L mm	L "	Ft		
1719BMX6/P	150	6	5.350	5	017190026
1719BMX8/P	200	8	7.030	5	017190057
1719BMX10/P	250	10	9.350	5	017190076

1719BMD...M

félkerek nagyoló reszelő markolattal



	L mm	L "	Ft		
1719BMD6/M	150	6	6.660	5	017190197
1719BMD8/M	200	8	7.190	5	017190227
1719BMD10/M	250	10	9.660	5	017190247
1719BMD12/M	300	12	13.650	3	017190328

1719BMA...M

félkerek egyengető reszelő markolattal



	L mm	L "	Ft		
1719BMA6/M	150	6	6.810	5	017190027
1719BMA8/M	200	8	7.970	5	017190058
1719BMA10/M	250	10	10.050	5	017190077
1719BMA12/M	300	12	15.100	3	017190317

1719BMX...M

félkerek simító reszelő markolattal



	L mm	L "	Ft		
1719BMX6/M	150	6	7.170	5	017190028
1719BMX8/M	200	8	9.050	5	017190059
1719BMX10/M	250	10	12.400	5	017190078

1719BMD...R

kerek nagyoló reszelő markolattal



	L mm	L "	Ft		
1719BMD6/R	150	6	5.120	5	017190199
1719BMD8/R	200	8	5.300	5	017190229
1719BMD10/R	250	10	7.150	5	017190249
1719BMD12/R	300	12	9.700	3	017190329

1719BMA...R

kerek egyengető reszelő markolattal



	L mm	L "	Ft		
1719BMA6/R	150	6	5.350	5	017190029
1719BMA8/R	200	8	5.870	5	017190060
1719BMA10/R	250	10	7.450	5	017190079
1719BMA12/R	300	12	10.050	3	017190319

1719BMX...R

kerek simító reszelő markolattal



	L mm	L "	Ft		
1719BMX6/R	150	6	6.200	5	017190031
1719BMX8/R	200	8	6.800	5	017190061
1719BMX10/R	250	10	9.340	5	017190081

1719BMA...B5

5 darab egyengető reszelő, tartóban



	L mm	L "	Ft		
1719BMA8/B5	200	8	32.850	1	017190297
1719BMA10/B5	250	10	41.700	1	017190298

1719BMD...B5

5 darab nagyoló reszelő, tartóban



	L mm	L "	Ft		
1719BMD8/B5	200	8	30.350	1	017190303
1719BMD10/B5	250	10	40.300	1	017190305

1719BMD...S5

5 darabos nagyoló reszelő készlet markolattal

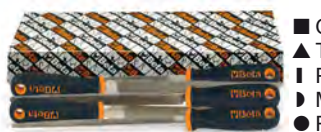

	L mm	L "	Ft		
1719BMD6/S5	150	6	27.950	1	017190200
1719BMD8/S5	200	8	30.350	1	017190230
1719BMD10/S5	250	10	40.300	1	017190250
1719BMD12/S5	300	12	56.300	1	017190363

1719BMA...S5

5 darabos egyengető reszelő készlet markolattal



	L mm	L "	Ft		
1719BMA6/S5	150	6	28.350	1	017190030
1719BMA8/S5	200	8	32.850	1	017190070
1719BMA10/S5	250	10	41.700	1	017190080
1719BMA12/S5	300	12	61.450	1	017190361

1719BMX...S5

5 darabos simító reszelő készlet markolattal



	L mm	L "	Ft		
1719BMX6/S5	150	6	31.200	1	017190032
1719BMX8/S5	200	8	39.150	1	017190069
1719BMX10/S5	250	10	52.450	1	017190082

1719BMB/P

Laposreszelő, műanyag nyéllel



L mm	L "	Ft		
250	10	11.250	5	017190152
300	12	13.600	5	017190153

1719BMC

Félkerek és laposreszelő, műanyag nyéllel



UNI 5569 - UNI 5568

	L mm	L "	Ft		
1719BMC/M 250	250	10	7.570	6	017190252
1719BMC/M 300	300	12	9.610	4	017190253
1719BMC/P 250	250	10	5.920	6	017190262
1719BMC/P 300	300	12	7.350	4	017190263

1719BM/RR

Kerek reszelő műanyag nyéllel



L mm	L "	Ft		
200	8	6.460	5	017190351

1719BM/RL

Laposreszelő műanyag nyéllel



L mm	L "	Ft		
200	8	6.040	5	017190360

1719BMR

Tartaléknyél a reszelőhöz



	L mm	A mm	Ft		
1719BMR/0	95	25	1.400	10	017190950
1719BMR/0B	110	29	1.400	10	017190955
1719BMR/1	110	29	1.400	10	017190951
1719BMR/1B	110	29	1.400	10	017190953
1719BMR/2	123	31	1.400	10	017190952
1719BMR/2B	123	31	1.400	10	017190954

	mm	"		
1719BMR/0	100/150	4/6	▲▲	●
1719BMR/0B	100/150	4/6	■	●
1719BMR/1	150/200	6/8	▲▲	●
1719BMR/1B	150/200	6/8	■	●
1719BMR/2	250/300	10/12	▲▲	●
1719BMR/2B	250/300	10/12	■	●

1720/...

egyengető türeszelők, szár Ø 3 mm

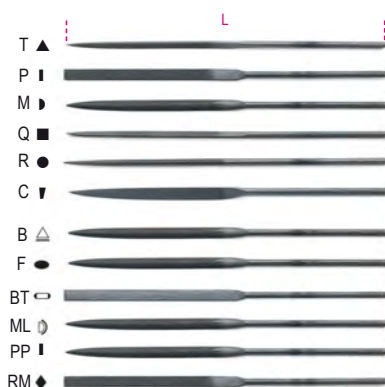

UNI 5569 UNI 5670

	L mm	Ft		
1720T	160	2.710	5	017200004
1720P	160	2.710	5	017200006
1720M	160	2.710	5	017200008
1720Q	160	2.710	5	017200009
1720R	160	2.710	5	017200010
1720C	160	2.710	5	017200012
1720B	160	2.710	5	017200005
1720ML	160	2.710	5	017200007
1720BT	160	2.710	5	017200011
1720F	160	2.710	5	017200013
1720PP	160	2.710	5	017200014
1720RM	160	2.710	5	017200015



	Ft		
1720/S3	8.130	1	017200000

1720/B



	Ft		
1720/B6	17.050	1	017200002
1720/B12	32.500	1	017200003

1720D/...

gyémánt fűrészelők
D126 szemcseméret



	L mm	Ft	csomagolás	art. szám
1720D/T	160	18.600	2	017200104
1720D/P	160	18.600	2	017200106
1720D/M	160	18.600	2	017200108
1720D/Q	160	18.600	2	017200109
1720D/R	160	18.600	2	017200110
1720D/C	160	18.600	2	017200112



	Ft	csomagolás	art. szám
1720D/B6	112.400	1	017200120

1721/B6

6 részes kontaktreszelő készlet



	Ft	csomagolás	art. szám
1721/B6	9.510	1	017210010

1723

Rugóbeakasztó, krómozott



	L mm	Ft	csomagolás	art. szám
1723	210	5.930	5	017230001

1725

Fűrész, fűrészkeret krómozott acélból,
nyél könnyűfémből, bimetal fűrészlappal



	L mm	L1 mm	Ft	csomagolás	art. szám
1725	420	300	8.420	4	017250001

1725CR

Mini fűrész, lakkozott alumíniumból



	L mm	L1 mm	Ft	csomagolás	art. szám
1725CR	250	150	4.630	5	017250010

1726

Fűrész, fűrészkeret lakkozott acélból,
nyél könnyűfémből, bimetal fűrészlappal

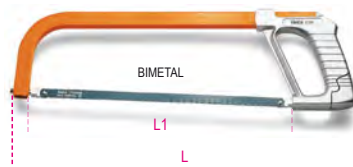

	L mm	L1 mm	Ft	csomagolás	art. szám
1726	440	300	11.450	4	017260001

1726BM

Fűrész fűrészlapfeszítővel, gyorslazítóval



	L mm	L1 mm	Ft	csomagolás	art. szám
1726BM	400	300	18.400	1	017260050

1727

Erősített fűrész, fűrészkeret lakkozott
acélból, fanyéllal, bimetal fűrészlappal

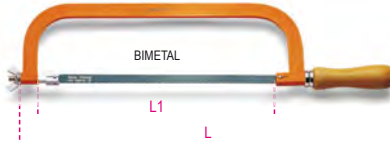

	L mm	L1 mm	Ft	csomagolás	art. szám
1727	515	300	7.910	4	017270001

1727BM

Egykezes fűrész



	L mm	L1 mm	Ft	csomagolás	art. szám
1727BM	315	300	9.560	5	017270020

1728...

Fűrészlap



	Ft	csomagolás	art. szám
1728LA	565	100	017280001
1725CR			
1725MQ			
1728BM	1.450	100	017280010
1725-1726			
1727-1727M			
1728CO	1.900	50	017280030
1725-1726			
1727-1727M			

1729CG

Gipszkartonfűrész



	L mm	L1 mm	Ft	csomagolás	art. szám
1729CG	310	160	9.230	2	017290200

1729DM 450

Fafűrész

Közepes fogazat, 12 fog/coll



	L mm	L1 mm	Ft	csomagolás	art. szám
1729DM 450	450	400	10.600	4	017290450

1730

univerzális spakli rozsdamentes acél pengével
és nyéllal



S mm	L mm	L1 mm	Ft	csomagolás	art. szám
38	210	85	2.140	2	017300038
63	220	95	2.610	2	017300063
75	220	95	2.920	2	017300075
100	220	95	3.250	2	017300100

1730M

keverő spatula,
rozsdamentes acél pengével és nyéllal



L1 mm	L mm	S mm	Ft	csomagolás	art. szám
150	245	27	3.100	2	017300215
200	330	28	5.880	2	017300220
250	365	36	7.450	2	017300225

1730V 38

üvegező spatula,
rozsdamentes acél penge



S mm	L mm	L1 mm	Ft	csomagolás	art. szám
38	225	100	2.140	2	017300338

1736A

reszelőtisztító kefe
rozsdamentes acél drót,
drót Ø: 0,5 mm



1736A	L mm 240	Ft 4.310	10	017360010
-------	----------------	-------------	----	-----------

1737

sárgaréz hullámos drótkefe
drót Ø: 0,2 mm



1737	L mm 145	Ft 2.120	10	017370001
------	----------------	-------------	----	-----------

1737NX

rézsel bevont acél drótkefe
drót Ø: 0,3 mm



1737NX	L mm 270	Ft 2.390	5	017370010
--------	----------------	-------------	---	-----------

1737AC

acél drótkefe,
5 soros
drót Ø: 0,3 mm



1737AC	L mm 275	Ft 2.270	5	017370020
--------	----------------	-------------	---	-----------

1737B

akkusaru és pólus tisztító
acél drótkefe
drót Ø: 0,3 mm



1737B	Ft 5.910	1	017370050
-------	-------------	---	-----------

1738

Sörtésecset



1738	L mm 210	H mm 30	Ft 3.430	10	017380001
------	----------------	---------------	-------------	----	-----------

1739B

Rozsdamentes acél



Ø mm	3,2	4	4,8	5	6	6,4
Alumínium	•	•	•	•	•	•
Nemesacél	•	•	•	•		

1739B	Ft 54.200	1	017390151
-------	--------------	---	-----------

1740A

Alumínium
Rozsdamentes acél



Ø mm	3,2	4	4,8	5	6	6,4
aluminium	•	•	•	•	•	•
Inox	•	•	•	•		

1740A	Ft 48.350	1	017400101
-------	--------------	---	-----------

1740B

Alumínium
Acél
Rozsdamentes acél

Alumínium
Acél
Rozsdamentes acél



Ø mm	2,4	3	3,2	3,2	4,8
alumínium	•	•	•	•	•
rozsdamentes acél	•	•	•	•	•
Inox	•	•	•	•	•

1740B 280	L mm 280	Ft 29.250	1	017400280
-----------	----------------	--------------	---	-----------

Ø mm	2,4	3,2	4,0	4,8	6,4
alumínium	•	•	•	•	•
rozsdamentes acél	•	•	•	•	•
Inox	•	•	•	•	•

1740B 330	L mm 330	Ft 34.200	1	017400330
-----------	----------------	--------------	---	-----------

1741B

Popszegecszúzó, komplett négy cserélhető
betéttel



Ø mm	2,4	3,2	4	4,8	5
Alumínium	•	•	•	•	•
Acél	•	•	•	•	•
Rozsdamentes acél	•	•	•		

1741B	Ft 15.850	1	017410000
-------	--------------	---	-----------

Beta

Beta

1741B/C5

1741B típusú popszegecshúzó készlet 700 alumínium szegeccsel



1741B/C5 Ft 49.150 1 017410025

	Ø mm	L mm	n.
1741RV2,9K	3,0	6	200
1741RV3,2K	3,2	8	200
1741RV3,8K	4,0	10	100
1741RV4K	4,0	12	100
1741RV4,8K	4,8	12	100

415x155x60 mm - 3,1 Kg

1741BP

Popszegecshúzó, 4 cserélhető betéttel



Ø mm	2,4	3,2	4	4,8	5
Alumínium	•	•	•	•	•
Acél	•	•	•	•	•
Rozsdamentes acél	•	•	•	•	•

1741BP Ft 22.900 1 017410350

1741U

Rozsdamentes acél

3 betét: a szegecses fix tartására



Ø mm	2,4	3	3,2	4	4,8
Alumínium	•	•	•	•	•
Acél	•	•	•	•	•
Nemesacél	•	•	•	•	•

1741U Ft 17.250 1 017410450

1741RV...K

Alumínium szegecses

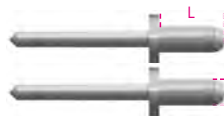

	Ft	1	017410191
1741RV 2,9K ØxL = 3x6 mm	7.350	1	017410191
1741RV 3,2K ØxL = 3,2x8 mm	7.610	1	017410192
1741RV 3,8K ØxL = 4x10 mm	9.740	1	017410193
1741RV 4K ØxL = 4x12 mm	10.850	1	017410194
1741RV 4,8K ØxL = 4,8x12 mm	13.400	1	017410195

A megadott árak 500 darabra vonatkoznak.

1742

Szegecsnyaroppantó fogó
4 cserélhető betéttel (1x M3;M4;M5;M6)



1742 Ft 51.750 1 017420001

M	Ø mm	L mm
3	5	11
4	6	11
5	7	13
6	9	17

1742KR

4 tartalékbetét a 1742-hez



	Ft	1	017420043
M3	22.150	1	017420043
M4	22.150	1	017420044
M5	22.150	1	017420045
M6	22.150	1	017420046

1742R-AL/M...

Alumínium szegecses a 1742-1742A-1946KF modellhez



	Ft	1	017420023
1742R-AL M3 ØxL = 5x10 mm M = 3	1.900	1	017420023
1742R-AL M4 ØxL = 6x12 mm M = 4	2.120	1	017420024
1742R-AL M5 ØxL = 7x13 mm M = 5	2.240	1	017420025
1742R-AL M6 ØxL = 9x15 mm M = 6	2.500	1	017420026

A megadott árak 20 darabra vonatkoznak.

1742R-A/M...

Acél szegecses a 1742-1742A-1946KF modellhez



	Ft	1	017420013
1742R-A M3 ØxL = 5x11 mm M = 3	2.170	1	017420013
1742R-A M4 ØxL = 6x11 mm M = 4	2.030	1	017420014
1742R-A M5 ØxL = 7x13 mm M = 5	2.260	1	017420015
1742R-A M6 ØxL = 9x17 mm M = 6	2.750	1	017420016
1742R-A M8 ØxL = 11x17 mm M = 8	2.640	1	017420018
1742R-A M10 ØxL = 13x24 mm M = 10	2.920	1	017420020

A megadott árak 20 darabra vonatkoznak
• A megadott árak 10 darabra vonatkoznak

1742/C4

Szegecsnyaroppantó fogó 1742 és 400 acél szegecs



1742/C4 Ft 113.600 1 017420005

	M	Ø mm	n.
1742R-A/M3	3	5	100
1742R-A/M4	4	6	100
1742R-A/M5	5	7	100
1742R-A/M6	6	9	100

415x155x60 mm - 2,9 kg

1742A

Erősített szegecsnyaroppantó
4 cserélhető fejjel



1742A Ft 193.100 1 017420100

M	Ø mm	L mm
5	7	13
6	9	17
8	11	17
10	13	24

1742A/KR

Négy cserélhető fej a 1742A modellhez

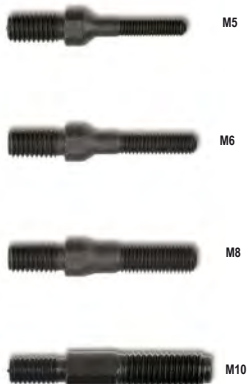

		Ft		
1742A/KR M5	M5	14.950	1	017420143
1742A/KR M6	M6	14.950	1	017420144
1742A/KR M8	M8	14.950	1	017420145
1742A/KR M10	M10	14.950	1	017420146

1742A/C

Szegecsanyaroppantó 1742A
60 menetes acélszegeccsel



	Ft		
1742A/C	218.100	1	017420105

	M	∅ mm	n.
1742R-A/M5	5	7	20
1742R-A/M6	6	9	20
1742R-A/M8	8	11	10
1742R-A/M10	10	13	10

536x310x80 mm - 2,1 kg

1749

Kinyomópisztoly lakkozott
fémlemezéből



	L min mm	Ft		
1749	340	5.280	2	017490001

1749A

Kinyomópisztoly, profi modell,
alumíniumcső



	L min mm	Ft		
1749A	360	17.000	1	017490010

1749A/RB

pótcső az 1749A eszközhöz

	Ft		
1749A/RB	360	1	017490051

1749A/RT

becsavarható homlokugó az 1749A
eszközhöz

	Ft		
1749A/RT	825	1	017490052

1749AC

Magas nyomású kinyomópisztoly



	L min mm	Ft		
1749AC	360	15.150	1	017490005

1750

karoszsírózó

a 1750CG zsírpatronnal vagy ömlesztett zsírral is használható



1 g, 550 bar Max

1750CG	cc	cc	L mm	Ft		
400	500	380	11.350	1	017500500	
600	750	450	17.800	1	017500750	

1750R/1 - 1750R/2

Flexibilis tartalék zsírzsócső,
műanyagból



	L mm	Ft		
1750R/1	310	2.630	2	017500030
1750R/2	410	2.920	2	017500040

1750RC

Merev hajlított zsírzsócső



	L mm	M mm	Ft		
1750RC	150	10x1	2.110	2	017500050

1750RT

"Hydraulic 4-pofás tartalék zsírzófej



	M mm	Ft		
1750RT	10x1	1.850	5	017500110

1750RP/1 - 1750RP/2

Zsírzófej lapos zsírzógombokhoz



	∅ mm	M mm	Ft		
1750RP/1	16	10x1	4.770	2	017500115
1750RP/2	22	10x1	10.800	2	017500120

1750CG

Zsírpatron az 1750B-es modellhez



	cc	Ft		
400	5.880	18	017500140	
600	7.370	18	017500160	

1750KG10

karos zsírzőkészülék, 10 kg térfogat,
2 m nagynyomású csővel

forgatható csatlakozóval rendelkezik a cső megtörésének
elkerülésére
fröccsöntött alumínium szivattyútest légtelenítő szeleppel

3 különböző nyomás szint beállítási lehetőség:

- 4 gr 275 bárnál
- 7 gr 206 bárnál
- 9 gr 137 bárnál



1750KG10 Ft 75.750 1 017500100

1750TA

nagynyomású 6 tűs
önzáró zsírzőfej

az elhelyezése után tengelyirányban és a zsírzőszemhez
rögzítve marad, nem szükséges a helyén tartani, mint a
közönséges zsírzőfejeket
könnyű leválasztás nyomás alatt álló zsírzőfejnél is
M10x1 menet: mindenféle zsírzőkészülékhez alkalmas:
elektromos, pneumatikus, kézi, stb.
550 bárig nem deformálódik



1750TA Ft 17.750 1 017500111

1750TLA

nagynyomású 6 tűs önzáró hosszú zsírzőfej

Az elhelyezése után tengelyirányban és a zsírzőszemhez
rögzítve marad
Könnyű leválasztás nyomás alatt álló zsírzőfejnél is
M10x1 menet: mindenféle zsírzőkészülékhez alkalmas:
elektromos, pneumatikus, kézi, stb.
550 barig nem deformálódik



1750TLA Ft 25.250 1 017500112

1750M

Mini-zsírzó

- Mikrofúvókával
- Elsősorban pneumatikus szerszámokhoz használható



	cc	D mm	L mm	Ft		
1750M	100	43	145	8.910	1	017500025

1750M3

mini zsírzó 3 zsírzőfejjel

- három cserélhető zsírzőfejjel: 0,7 - 1,0 - 1,4 mm
- elsősorban pneumatikus szerszámokhoz
- ömlesztett zsírral is használható



	cc	Ø mm	L mm	Ft		
1750M3	85	42	160	10.800	1	017500003

1751N

olajozó fémkanna,
flexibilis csővel



cc	D mm	L mm	Ft		
200	62	140	6.580	4	017510020
300	75	140	7.130	4	017510030
500	85	140	7.480	4	017510050
750	100	140	8.150	2	017510075
1000	100	140	8.850	2	017510100

1751NR

tartalék cső
a 1751N termékhez



200÷1000 Ft 2.000 5 017510110

1752

pumpás olajozó műanyag kanna, merev
csővel



cc	D mm	L mm	Ft		
200	67	140	4.190	4	017520002
300	77	140	4.330	4	017520003
500	95	140	4.490	4	017520005
700	95	140	5.030	2	017520007

1752R

Tartalékcső az 1752 típusú kannához



200÷700 Ft 1.580 5 017520020

1753

pumpás olajozó műanyag kanna, flexibilis
csővel



cc	D mm	L mm	Ft		
200	65	190	4.160	4	017530002
300	80	190	4.240	4	017530003
500	95	190	4.420	4	017530005
700	95	190	5.030	2	017530007

1753R

Tartalékcső az 1753 típusú kannához



200÷700 Ft 1.650 5 017530020

1754

Pumpás olajozó műanyag kanna,
flexibilis, műanyag csővel



cc	D mm	L mm	Ft		
150	60	130	3.670	5	017540015
250	65	130	4.140	5	017540025

1755

Olajozó műanyag flakon, kiálló csővel



cc	L mm	A mm	Ft		
30	160	30	2.760	5	017550003
80	170	47	3.020	5	017550008
150	230	58	3.350	5	017550015

1756

olajbefecskendező

ásványi olajokhoz is alkalmas



cc	L mm	Ft		
5	140	8.900	2	017560001

1756B

olajbefecskendező

- recézett felülettel
- felhasználási hőmérséklet: -10 °C - +60 °C
- minimum SAE 10 viszkozitású olaj



cc	L mm	Ft		
500	280	8.670	2	017560220

1756C

polipropilén
olajbefecskendező 200 ml

- alkalmas fékfolyadékhoz is
- dupla EPDM tömítés
- üzemeltetési hőmérséklet: 0°C ± +50°C
- legkisebb olajviszkozítás; ISO 150, SAE 90 (fékolaj), SAE 40 (motorolaj)



1756C	Ft			
	13.850	1	017560502	

1756D

Polipropilén olajbefecskendező 1500 ml

- Dupla tömítés NBR
- Üzemeltetési hőmérséklet: +0 - +50 °C
- NEM alkalmas üzemanyaghoz

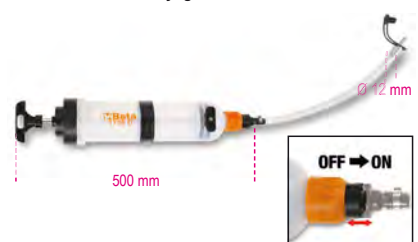

1756D	Ft			
	31.050	1	017560515	

1756G

gázolaj befecskendező
űrtartalom: 1,5 l

- Felhasználás:
- gázolajszűrők feltöltése
 - adaléktartály feltöltése



- Készlet tartalma:
- 2 cső mama gyorscsatlakozóval gázolaj olajcsövek csatlakoztatásához
 - 2 papa gyorscsatlakozó, fém
 - 1 kúp alakú adapter gumitömítőkhez

1756G	Ft			
	57.600	1	017560615	

1756C-20R

O-gyűrű pár az 1756C befecskendezőhöz

1756C-20R	Ft			
	1.300	1	017560503	

1756D-20R

O-gyűrű pár az 1756D befecskendezőhöz

1756D-20R	Ft			
	3.060	1	017560516	

1757

Desztillált víz tartó flakon, műanyagból



cc	D mm	Ft		
250	60	1.390	4	017570002
500	75	1.670	4	017570004
1000	90	2.300	2	017570006

1757A

Akkumulátorsav feltöltő kanna,
műanyagból



cc	Ft			
2000	16.950	1	017570020	

1758

önbeálló tölcser

különösen alkalmas azoknál
az autóknál, amelyek nem rendelkeznek
mélyedéssel a töltőfedélben



1758	Ft			
	24.200	1	017580020	

1758ADB-D



1758 ADB-D	I Max	Ft		
	1	15.850	1	017580050

1758ADB-45°

visszafolyásgátló tölcser AdBlue®-hoz,
45°-os csatlakozóval



1758 ADB-45°
Max 1 Ft 17.500 1 017580060

1758A

visszafolyásgátló tölcser
Ø 38 mm gyorscsatlakozóval
A Volkswagen csoport járműveihez



1758A Ft 32.950 1 017580010

1758B

visszafolyásgátló tölcser
gyorscsatlakozóval
Különösen alkalmas a
VAG modellekhez



1758B Ft 16.700 1 017580030

1758B-1,6

visszafolyásgátló tölcser, 1600 ml,
gyorscsatlakozóval
gyorscsatlakozó
VAG modellekhez



H1 H2 Ø Ft
mm mm mm 16.800 1 017580033

1758B-RNT

gyorscsatlakozó
a 1758B-1758B-1,6 visszafolyásgátló
tölcserhez
Renault 1.5 dCi motorhoz



1758B-RNT Ft 11.750 1 017580035

1758B/K5

gyorscsatlakozó adapter készlet
a 1758B - 1758B-1,6 visszafolyásgátló
tölcserhez

- Készlet tartalma:
- 1 adapter 1.5 dCi Renault, Dacia és Nissan motorokhoz
 - 1 adapter 1.5/1.6 dCi Renault, Dacia és Nissan motorokhoz
 - 1 adapter 3.0 BMW dizelmotorhoz
 - 1 adapter a VAG csoport 1.5/2.0 benzinmotorjaihoz
 - 1 csapos csatlakozó adapter a visszafolyásgátló tölcserhez



1758B/K5 Ft 42.600 1 017580040

1758LG

formálható alumínium lemez gumiburkolattal,
a folyadékok csatornázásához



L H Ft
mm mm 18.400 1 017580006

1758M

Tölcser



1758M L Ft
mm 350 5.290 1 017580000

1758R

folyadék tartály

praktikus levehető rugalmas kiöntőcső



1758R 1 Ft 3.280 1 017580201
1758R 2 Ft 3.940 1 017580202
1758R 3 Ft 7.150 1 017580203
1758R 5 Ft 8.720 1 017580205

1758VT

Hengerfejvizsgáló készülék

A széndioxid kibocsátás mértékének gyors kijelzése



1758VT Ft 69.800 1 017580100

290x190x50 mm - 1kg

1758VT/L

kontrasztfoliadék hengerfej vizsgálathoz



1758VT/L Ft 19.950 1 017580101

1759

Optikai fagyálló-, akkumulátorsav-, tárcsamosó- és AdBlue®-folyadék vizsgáló készülék

Erősített tokban szállítva

Automatikus hőmérsékletkompenzáció

Akkumulátorsav: Mérés tartomány:

1,1 - 1,3 kg/l

Propilénes hűtőfolyadék:

-25°C - -50°C

Etilénes hűtőfolyadék: -25°C - -50°C

Tárcsamosófolyadék: -25°C - -40°C

AdBlue: Karbamidmérés: 30 %-45 %



1759 Ft 64.500 1 017590251

1759A

Fagyállóvizsgáló, üvegtest



1759A L mm Ft 340 27.600 1 017590001

1759B

Savsűrűségmérő



1759B L mm Ft 280 17.700 1 017590005

1759HD/3

Hűtőrendszer tömítettségét ellenőrző készülék

• Lehetővé teszi a nyomás alatt lévő rendszer esetleges szivárgásának vizsgálatát (csövek, csatlakozók, szivattyúk és hűtők) és a rendszer gyors feltöltését levegősődés nélkül



1759HD/3 Ft 231.900 1 017590063
☞ 600x500x140 mm - 📦 6,5 kg

1759HD/RR

Hűtőtöltőkészülék

• Lehetővé teszi a berendezés gyors feltöltését levegősődés nélkül



1759HD/RR Ft 69.800 1 017590064
☞ 450x310x110 mm - 📦 2,2 kg

1759LR

hűtőrendszer átmosó pisztoly

sűrített levegős,
a magas víznyomás hatékony átmosást biztosít

- 6 db csatlakozóadapterrel szállítva
- rögzíthető működtető kar folyamatos használathoz
- vizes gyorscsatlakozóval szállítva



1759LR L mm Ft 402 173.800 1 017590070
☞ 390x330x100

1759HD/TRUCK

teherautó hűtőrendszer ellenőrző és tömítő készülék



1759HD/TRUCK Ft 160.900 1 017590065
☞ 440x330x100 mm - 📦 3 kg

1759TT

4 pár dugó turbókör teszteléséhez
tömlőfúvatóval
használható



1759TT Ft 84.450 1 017590300
☞ 400x160x100 mm - 📦 1,8 kg

TANÚSÍTÁSI SZOLGÁLTATÁS ELEKTRONIKUS MŰSZEREKHEZ

Az elektronikus mérőműszerek, így a multiméterek, lakatfogók, tachométerek és hőmérők tanúsítása elengedhetetlen azokban az ágazatokban vagy alkalmazási területeken, ahol pontos, egyértelmű és felismerhető mérésekre van szükség. Infravörös hőmérők esetén 4 pontos kalibrációs jegyzőkönyv (minimum, maximum és két közbelső pont) kiadására kerül sor ENAC szerinti nyomon követhetőséggel.

A Beta Utensili S.p.A. kérésre tanúsítási szolgáltatást biztosít. A szolgáltatás igénybevételéhez keresse márkakereskedésünket.

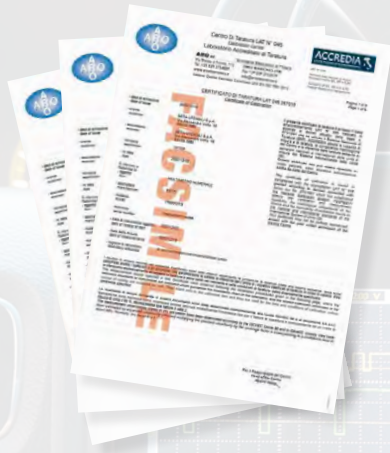

1760DGT

Automotív univerzális digitális multiméter



Műszaki adatok
 RPM (Tacho):
 2- és 4-hengeres motorokhoz
 RPM4 600 - 4000 U/perc
 RPM4 600 - 12000 U/perc(x10 U/perc)
 RPM2/DIS 300 - 4000 U/perc
 RPM2/DIS 300 - 6000 U/perc (x10 U/perc)
 Dwell-Winkel/Pillanatnyi állás: 4-8 CYL
 Feszültség DC: 400mV-4/40/400/1000V
 Feszültség AC: 4/40/400/700V
 Egyenáram DC: 40/400mA-4/20A
 Váltakozóáram AC: 40/400mA-4/20A
 Ellenállás: 400Ω-4/40/400kΩ-4/40MΩ
 Kapacitás: 40/400nF-4/40/100μF
 Frekvencia: 5/50/500Hz-50/500-10MHz
 Kitérés tényező: 0,1 - 99,9%
 Impulzustényező: 1 - 10ms
 Diódateszt: Jelteszt 0,3mA
 Folytonosság teszt: <150Ω - Jelteszt <0,3mA
 Kijelző: LCD folyadékkristályos kijelző, 4-soros, rejtett világítással
 Érintésvédelem: Kategória II 1000V
 Automatikusan kikapcsolás: 30 perc
 Áramforrás: 1 9V elem (együtt szállítva)
 Indukciós csipesz (együtt szállítva)
 2 mérőcsúc (együtt szállítva)
 Tok (együtt szállítva)
 Használati utasítás

1760DGT Ft 107.500 1 017600005

1760DG/2

digitális hordozható multiméter gépkocsikhoz, 2-csatornás oszcilloszkóppal és hullámgenerátorral



MŰSZAKI ADATOK
 Kijelző: 2.8" színes TFT
 Felbontás: 320 x 240 pixel
 Tápellátás: 100V-240V AC, 50Hz-60Hz; DC BEMENET 5V DC-2A
 Akkumulátor: 2 x 2600 mAh

MULTIMÉTER MŰSZAKI ADATOK
 Teszt lehetőségek: feszültség, áramerősség, ellenállás, kapacitás, diódateszt, be-ki
 Max. feszültség: 600V AC-DC
 Max. áramerősség: 10A AC-DC
 Max. áramerősség: 40MOHM
 Max. kapacitás: 100μF

OSZCILLOSZKÓP MŰSZAKI ADATOK
 Független
 Sávszélesség: 40MHz
 Mintavételi frekvencia tartomány: 250MSa/s (egy csatorna) - 125MSa/s (két csatorna)
 SEC/DIV tartomány: 5ns/div + 500s/div 1,2,5 sorozat
 Vertikális
 VOLTS/DIV tartomány: 10mV/div+10V/div BNC bemenettel
 Választható analóg, sávszélesség limit, jellemző: 20MHz
 Alsó frekvenciament (-3db): ≤10Hz a BNC
 DC erősítés pontosság: ± 3% normál vagy közepes üzemmód, 10V/div + 10 mV/div
 Triggerek: Edge
 mód: Auto, Normál, Egyedi
 Lejtő: Emelkedő, Eső, Emelkedő és Eső
 Forrás: CH1, CH2
 Bemenet
 csatolás: DC, AC vagy GND
 Támogatott mérőszonda csillapítási tényezők: 1X, 10X, 100X, 1000X
 Hullámforma generátor
 Hullámforma frekvencia: Szinuszos (1Hz+25MHz), Négyzetűg (1Hz+10MHz), Fűrészfog (1Hz+1MHz), EXP (1Hz+5MHz)
 Szélesség: 2.5Vpp (50Ω) - 5Vpp (magas impedancia)
 Kimeneti impedancia: 50Ω

Méret: 199 x 98 x 40 mm
 Súly: 624g

1760DG/2 Ft 334.700 1 017600008

1760B

Univerzális digitális multiméter



CE

VÉGREHAJTHATÓ MÉRÉSEK

Feszültség DC: 200 mV-2/20/200/1000V
 Feszültség AC: 2-20/200/700V
 Áram DC: 2/20/200 mA-20 A
 Áram AC: 2/200 mA- 20 A
 Ellenállás: 200Ω - 2/20/200 kΩ - 2/20 MΩ
 Kapacitás: 2/20/200 nF - 2/200 μF
 Hőmérséklet: -20° + 1000°C/ -4 °F ~ +2000°F
 Frekvencia: 20kHz
 Tápegység: 1 9V-elem (együtt szállítva)

1760B Ft 66.150 1 017600012

1760/OHM

Multiméter/Megaohmméter magasfeszültségű szigetelés vizsgáló
 Effektív érték mérés: TRUE RMS



CE

CAT. IV
 600V
 CAT. III
 1000V

Méréstartomány	Bázisprecízió	
Feszültség AC/DC: 50mV - 1000V	±0.06% - ±0.1% rdg	
Áramerősség AC/DC: 0.01μA - 10A	±0.5% - ±1% rdg	
Ellenállás: 0.01Ω - 50MΩ	±0.2% - ±2% rdg	
Meg OHM: 0.01 - 5000MΩ	±4% rdg. max current 1mA	
Kapacitás: 5nF - 10mF	±1.5% - ±3% rdg	
Frekvencia: 50Hz - 100 MHz	±0.02% - ±0.1% rdg	
Hőmérséklet: -50°C - +1350°C	±0.5% rdg	
Diódateszt: 3V dc		
Folytonosságteszt: <30 Ω		

1760/OHM Ft 326.500 1 017600025

1760/RMS

Diódateszt 3V DC ±10% rdg

EN61010-1
 EN61326-1



CE

Mérési tartomány
 Feszültség AC/DC 110mV - 600 V ±0,8% - ±2% rdg
 Áramerősség AC/DC 110μA - 10A ±1,5%-±2% rdg
 Ellenállás 110Ω - 40MΩ ±1,2%-±2,5% rdg
 Kapacitás 11nF-40nF±5%-±10%rdg (11mF-ig)
 Frekvencia 1100 Hz - 110 MHz ±1,2%-±1,5% rdg
 Hőmérséklet - 32 °C - 1000 °C ± 3% - ±5% rdg
 Diódateszt 3V DC ±10 % rdg
 Folytonosság teszt <30Ω

1760/RMS Ft 119.000 1 017600020

1760S

digitális multiméter, kompakt kivitel
 TRUE RMS (effektív érték) mérés



CE

Végrehajtható mérések:
 Feszültség DC: 200 mV-2/20/200/600V
 Feszültség AC: 100/600 V
 Áram DC: 200 mA-10 A
 Áram AC: 0,01-10 A
 Ellenállás: 200Ω - 2/20/200 kΩ - 2 MΩ
 Dióda mérés: 0,4 ± 0,7
 Tápellátás: 2 db 1,5V elem, AAA

1760S Ft 33.600 1 017600022

153x75x42 mm

1760PA/80

AC/DC Lakatfogó 80A

Speciális készülék a járművek alacsony áramvesztés vagy áramfelvétel mérésére



CE

1760PA/80 Ft 87.950 1 017600020

1760PA/AC

Lakatfogó

A: AC
 V: AC/DC



CE

PARAMÉTEREK

Feszültség DC 400 mV - 4/40/400/600 V
 Feszültség AC 400 mV - 4/40/400/600 V
 Váltóáram AC 40/400/1000 A
 Ellenállás 400Ω - 4/40/400 kΩ - 4/40 MΩ
 Frekvencia 5/50/500 Hz - 5/50/500 kHz - 5/10 MHz
 Teljesítmény 40/400 nF - 4/40/100 F
 Hőmérséklet - 20 °C 1000 °C / -4 °F 1832 °F
 Áramforrás 1 9V-elem (együtt szállítva)

1760PA/AC Ft 72.250 1 017600050

1760PA/AC-DC

Lakafogó és digitális multiméter

A: AC/DC
V: AC/DC

CE



A: AC/DC
V: AC/DC

VÉGREHAJTHATÓ MÉRÉSEK:
Feszültség DC: 0.1mV ÷ 600V
Feszültség AC: 0.1mV ÷ 600V
Áram AC: 0.01A ÷ 1000A
Áram DC: 0.01A ÷ 1000A
Ellenállás: 0.1Ω ÷ 40MΩ
Teljesítmény: 0.001nF ÷ 40 μF
Frekvencia: 0.001kHz ÷ 4kHz
Hőmérséklet: -40°C ÷ 1000 °C
-40°F ÷ 1832°F

1760PA/AC-DC Ft 126.300 1 017600000

1760PA/AC-DC2000

lakafogó és digitális multiméter Bluetooth csatlakozással

TRUE RMS funkció AC tartományban

A: AC/DC
V: AC/DC

CE



Végrehajtható mérések:

- Feszültség DC: 0.1mV ÷ 1000V
- Feszültség AC: 0.1mV ÷ 1000V
- Áram AC: 0.01A ÷ 2000A
- Áram DC: 0.01A ÷ 2000A
- Ellenállás: 0.1Ω ÷ 60MΩ
- Teljesítmény: 1nF ÷ 6000 μF
- Frekvencia: 10kHz ÷ 20kHz
- Hőmérséklet: -20 °C ÷ 1000 °C
- -4 °F ÷ 1832 °F
- Tápellátás: 3 db 1,5V elem, AA (a csomag tartalma)
- Bluetooth kapcsolat (4.0 verzió)

H mm 300 L mm 110 P mm 43 Ft 258.700 1 017600003

380x280x100 mm - 1,78 kg

1760DGT-R3

pótheygek digitális multiméterekhez és lakafogókhoz



1760DGT-R3 Ft 9.160 1 017600603

1760/RSE

jeldetektor

Lehetővé teszi a részegységek, így a közös nyomócsöves elektronikus injektorok, benzin/LPG elektronikus injektorok, piezoelektromos injektorok, áramlásszabályozó szeleoid szelepek, EGR szeleoid szelepek és tekercsek tápellátásának tesztelését



CE

A villamos rendszer egyes részeinek diagnosztizálásához a szondát csak az ellenőrizendő komponens közelébe kell tartani. A vezérlőegységgel ellátott elektromechanikus/elektronikus komponenseket tartalmazó rendszerben az eszköz a következők ellenőrzését teszi lehetővé:

- a vezérlőegység tápellátása és a vezérlőfunkciók megfelelő működése
- a vezérlőegység és vezérelt komponens közötti kábelek hatékonysága
- a tesztelt komponens nincs-e kiköve
- a komponens esetleges rövidzárata
- a komponens megfelelő elektronikus működése

1760/RSE Ft 235.100 1 017600170



1760/TC2

Digitális fordulatszámérő műszer



CE

A műszerrel mérhető:

Fordulatszám (Fordulat/perc-RPM)
Forgási sebesség (Fordulat/perc-RPM)
Kerületi sebesség (m/perc vagy ft/perc)

Műszaki adatok

LCD kijelző (1-5)

Méréstartomány:

Abstand 2,5 ÷ 99.999 fordulat/perc

Érintkező csúcsos mérés 0,5 ÷ 19.999 fordulat/perc

Kerületi sebesség 0,05 ÷ 1.999,9 m/perc

Érzékelési idő: 0,8 mp

Tápegység: 4 db 1,5 V-os elem (AA) vagy 6 V (külön kell megrendelni)

Együtt szállítva:

Adapter érintkező csúcsos méréshez

Külső (érintkező) gumicsúcs 2 db

Belső (érintkező) gumicsúcs 1 db

Kerületméréshez 1 db kerék

Fényvisszaverő címke

Gépkönyv

Műanyag tok

1760/TC2 L mm 230 H mm 74 Ft 91.950 1 017600161

1760R/TC2

Fényvisszaverő címke 1760/TC2 modellhez



1760R/TC2 Ft 8.560 1 017600561

1760K

AC érintés nélküli feszültségérzékelő, mini LED lámpával

tartomány: 200 - 1000 Vac 50/60Hz

CAT III - 1000 V

2 db AAA elemmel működik (együtt szállítva)



CE
CAT III-
1000V

1760K Ft 14.800 1 017600140

1760PT

kombinált feszültség és folytonosság tesztter
12 - 690 V AC/DC

funkciók:

- folytonosság
- fázisforgatás
- fáziskeresés
- LED elemlámpa

CE



IP64
CATIV
- 600V ;
CATIII -
1000V

1760PT Ft 58.200 1 017600150

1760/IR500

digitális infrahőmérő kettős célzólézerrel

nem alkalmas testhőmérséklet mérésére



CE

MŰSZAKI ADATOK

Hőmérséklet-tartomány: -50 + 500 °C (-22 + +932 °F)
Hőmérséklet kijelzési lépték: 0,1 °C (0,1 °F)
Emissziófaktor: 0,1 + 1 állítható
Pontosság: -50 °C + +20 °C (+/- 3 °C); 20 + 500 °C (+/-2% vagy 2 °C)
Távolság/mért felület aránya (D:S): 12:1
Automatikus kikapcsolás: kb. 10 másodperc
Működési hőmérséklet tartomány: 0 °C + 50 °C
Tárolási hőmérséklet: -20 °C + 60 °C
Tápellátás: 1 db 9V elem

1760/IR500 Ft 77.950 1 017600350

1760/IR1000

digitális infrahőmérő kettős célzólézerrel

nem alkalmas testhőmérséklet mérésére



CE

MŰSZAKI ADATOK

Hőmérséklet-tartomány: -50 °C + 1000 °C (-58 °F + +1832 °F)
Hőmérséklet kijelzési lépték: 0,1 °C (0,1 °F)
Emissziófaktor: 0,1 + 1 állítható
Pontosság: -50 °C + 20 °C (+/- 3,5 °C); 20 °C + 300 °C (+/-1% vagy 1 °C); 300 °C + 1000 °C (+/-1,5%)
Távolság/mért felület aránya (D:S): 20:1
Működési hőmérséklet tartomány: 0 °C + 50 °C
Tárolási hőmérséklet: -10 °C + 60 °C
Tápellátás: 2 db 1,5V AAA típusú elem

1760/IR1000 Ft 131.000 1 017600400

1760/IR1600

lézeres digitális infrahőmérő Lézerpointerrel

nem alkalmas testhőmérséklet mérésére



CE

MŰSZAKI PARAMÉTEREK

Mérési tartomány: -50 °C-1600 °C / -58 °F-2912 °F
Mértékegység: °C/°F
Mérési pontosság: ±1,5% vagy ±2 °C 20 °C-nál
Lézer teljesítmény: <1mW
Visszajelzés: 1 másodperc
Emissziófaktor: 0,10-1,0 beállítható
Távolság/mért felület aránya (D:S) 50:1
Üzemeltetési hőmérséklet: 0 °C + 50 °C / 32 °F + 122 °F
Relatív páratartalom: 10%-90% RH
LCD-kijelző rejtett világítással
Adatmegőrző funkció
Automatikus kikapcsolás
Áramforrás: 1 9V-elem (együtt szállítva)
Védőburkolat háromlábú alumínium állvánnyal
Használati utasítás

1760/IR1600 mm 200 mm 115 Ft 311.600 1 017600461

1760LX

hordozható digitális luxmérő

EN61010-1
EN61326-1



CE

Műszaki adatok:

Mérési tartomány Alapvető pontosság
Lux mérési tartomány: 0-200000 ±3%
FC mérési tartomány: 0-20000 ±3%
Tápellátás: 1 x 9V

1760LX L mm 165 Ft 41.150 1 017600820

1760TMC

infravörös hőkamera

kompakt hőkamera érintésmentes hőmérséklet méréshez, alkalmazható az építőiparban, mechanikus, elektromos és fűtőberendezéseknél

LCD TFT kijelző, 2", 240x320
érzékelő, 32x32 pixel
adat rögzítési frekvencia 7Hz
érzékenység <347mK
forró és hideg pontok automatikus rögzítése
képfarmátum: .bmp (max. 100 kép)
állítható emissziós tényező
tápellátás: 3 AAA alkáli elem
USB interfész
IP54
hőmérséklettartomány: -20 °C + +600 °C
infravörös sáv: 6.5+14µm
látható és infravörös kép egyesítés: 0,5; 1; 2m
riasztás funkció, elfogadható maximum- és minimumhőmérséklet választás



CE

1760TMC 600 Ft 394.200 1 017600710

Beta

1760WM

digitális légkerékes légáramlásmérő

EN61010-1
EN61326-1



Műszaki adatok:

Mérési tartomány Alapvető pontosság
m/s légsebesség tartomány: 0.4-30 ±2%
k/n légsebesség tartomány: 1.4-108 ±2%
ft/m légsebesség tartomány: 80-5900 ±2%
mil/h légsebesség tartomány: 0.8-58 ±2%
CFM légáramlás tartomány: 0.99990 ±0.9.999 ft2
CMM légáramlás tartomány: 0.99990 ±0.9.999 m2
CMS légáramlás tartomány: 0.99990 ±0.9.999 m2

	L mm	Ft		
1760WM	170	33.300	1	017600800

1761

huzalfeszítő fogó
automatikus beállással



	L mm	Ft		
1761	255	26.000	1	017610101

1761RS/1

átfordítható huzalfeszítő fogó
automatikus beállással



	L mm	Ft		
1761RS/1	220	46.850	1	017610130

1762

Bőrlükasztó fogó



	Ø mm	L mm	Ft	
1762	2-2,5-3 3,5-4-4,5	210	11.900	2 017620001

1763

autókárpitos kapocsfogó



	Ft		
1763	14.600	1	017630001

1763G/S500

500 autókárpitos kapocs



	Ft		
1763G/S500	26.600	1	017630105

1764/K5

kézi szegecselő műanyag szegecszekhez

4x10 különböző méretű szegeccsel szállítva

készlet tartalma:

- 10 db szegecs, Ø 5x17.2 mm
- 10 db szegecs, Ø 5x15.8 mm
- 10 db szegecs, Ø 6.3x25.2 mm
- 10 db szegecs, Ø 6.6x17.2 mm



	Ft		
1764/K5	18.450	1	017640001

1765/C24

24 darabos szerszám készlet autórádió
kiszereléséhez



	Ft		
1765/C24	68.050	1	017650001

1766

Kéttappancsos vákuumos üvegfogó



	max kg	Ft		
1766	50	50.650	2	017660001

1766A

Egytappancsos vákuumos üvegfogó



	max kg	Ft		
1766A	30	12.500	2	017660005

1766/8

8 darabos szélvédőkivágó készlet



	Ft		
1766/8	185.000	1	017660100

1766ER

üvegtömítő elem kihúzó
markolattal

lehetővé teszi az üvegtömítő elem hatékony eltávolítását
sérülésveszély nélkül



1766ER Ft 8.730 1 017660501

1766ER/VW

kis profilú üvegtömítő elem kihúzó

elsősorban a VAG csoport
nehezen hozzáférhető üvegtömítőihez



L mm 215 H mm 4 Ft 4.510 1 017660510

1766L

Belső szélvédőkivágó, műanyag
nyéllel



1766L Ft 20.400 1 017660015

1766LI

drótbelleesztő kar üvegkivágó készülékhez

élezett szélek tömítőanyag vágáshoz



1766LI Ft 6.710 1 017660016

1766I

Külső szélvédőkivágó, fémnnyéllel



1766I Ft 19.400 2 017660020

1766G

Acélkábel tárcsához

Négyzet keresztmetszetű



50 m Ft 17.550 1 017660025

1766T

acéldrót üvegekhez

háromszög keresztmetszet



50 m Ft 20.250 1 017660026

1767A

teleszkópos rúd

- fáradt támasztóteleszkópos motorháztető és csomagtartófedelek megtartására
- használható a blokkolt pedálok megtartására



L mm 640 ÷ 1090 Ft 27.350 1 017670000

1767B

pedál- és kormányrögítő

az állító mechanizmus
pontos beállítást biztosít,
amikor a jármű gázpedálja le van nyomva



1767B Ft 58.950 1 017670100

490x285x95 mm - 2,4 kg

1767PMC

Műanyagtálca kis tárgyak elhelyezésére,
mágneses, kerek



1767PMC Ft 8.330 1 017670020

1767PMR

Műanyagtálca kis tárgyak elhelyezésére,
mágneses, téglalap alakú

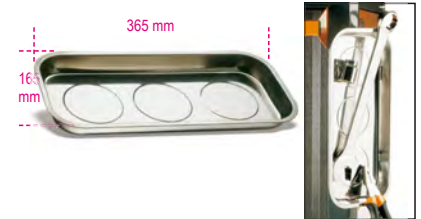

1767PMR Ft 17.300 1 017670010

1768

alumínium fellépő küszöb

csúszásmentes bevonattal
maximális teherbírás: 200 kg



L mm 960 L1 mm 300 H mm 475 Ft 77.650 1 017680010

1770

Deorkés extra lapos letörhető
pengével, 9 mm széles



1770 L mm 140 A mm 9 Ft 6.770 10 017700001

1770A

Dekorkés letörhető pengével 3 tartalékpengével



1770A L mm 135 A mm 9 Ft 2.500 5 017700025

1770RL

Letörhető dekorkéspenge, 9 mm széles



1770RL Ft 2.210 5 017700010

1770BM

Dekorkés, 9 mm, 6 tartalékpengével szállítva



1770BM L mm 140 A mm 9 Ft 5.160 10 017700050

1771

Dekorkés, 18 mm, 3 tartalékpengével szállítva



1771 Ft 3.820 10 017710000

1771BM

Dekorkés 6 tartalékpengével



1771BM L mm 170 A mm 18 Ft 7.560 10 017710050

1771HD

dekorkés, 18 mm, 6 tartalékpengével
• automatikus penge behúzás
• csavaros rögzítés



1771HD L mm 190 A mm 18 Ft 10.400 5 017710100

1771RL

Letörhető dekorkéspenge, 18 mm széles 1771HD



1771RL Ft 3.180 5 017710010

1772M

kés behúzható biztonsági pengével 3 pengével szállítjuk

automatikus rugós pengebehúzás
• fröccsöntött fém test
• nyélbe épített kapcsolóhúzó



1772M L mm 170 A mm 18 Ft 9.430 5 017720040

1772R

Behúzható pengéjű kés 5 pengével szállítva



1772R L mm 125 A mm 18 Ft 7.030 5 017720006

1772H

Kés behúzható pengével, 1 tartalék pengével



1772H L mm 170 A mm 18 Ft 7.320 5 017720029

1772RL/2

Egyenes hosszított tartalékpenge a 1772H, 1772M, 1772R, 1774, 1777BMT, 1777T típusú késhez 10 darabos egységcsomagban

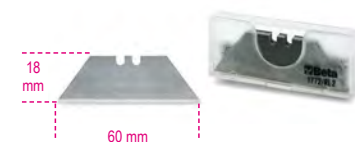

1772RL/2 Ft 1.830 5 017720017

1773A

Dekorkés letörhető dekorkéspengével, 25 mm széles



1773A L mm 180 A mm 25 Ft 7.380 10 017730000

1773RL

Letörhető dekorkéspenge, 25 mm széles



1773RL Ft 7.140 5 017730015

1774

Hántoló kés műanyagból pengevédővel



1774 L mm 155 L1 mm 60 Ft 1.620 5 017740001

1774A

Hántoló bimateriális nyéllel



1774A L mm 300 A mm 40 Ft 5.210 1 017740011

1774A/RL

10 penge a 1774A és 1774S hántolóhoz

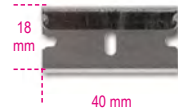

1774A/RL Ft 2.460 1 017740511

1774S

matricakaparó



1774S A mm 40 L mm 100 Ft 3.110 2 017740021

1777BM

Behajtható pengéjű kábelblankoló kés, penge nemesacélból, a kábelek csupaszításához



1777BM	L mm	L1 mm	A mm	Ft		
	190	80	16	4.570	5	017770100

1777T

Behúzható pengéjű kés acélból, 5 tartalékpengével szállítva



1777T	L mm	A mm	L1 mm	Ft		
	160	19	65	10.450	5	017770030

1777BMT

Dekorkés egyenes pengével 4 pozícióba állítható penge 4; 9.5; 15.5; 21.5 mm 3 pengével szállítva



1777BMT	L mm	L1 mm	A mm	Ft		
	170	80	19	10.850	5	017770050

1778AN

behajtható pengéjű kés, rozsdamentes acél penge, könnyű eloxált alumínium markolat • tokban



1778AN	L mm	A mm	L1 mm	Ft		
	204	26	84	16.300	5	017780065

1778AX

behajtható pengéjű kés, fogazott rozsdamentes acél penge, alumínium nyél, könnyebb nyitást biztosító fogazás • tokban



1778AX	L mm	A mm	L1 mm	Ft		
	189	26	80	20.950	5	017780026

1778CM

behajtható pengéjű kés, terepszínű hőkezelt acél penge tokban



1778CM	L mm	A mm	L1 mm	Ft		
	195	24	80	13.150	5	017780099

1778M7

behajtható pengéjű kés, rozsdamentes acél mini penge, üvegszál betétes markolat • tokban



1778M7	L mm	A mm	L1 mm	Ft		
	163	24	68	12.100	5	017780015

1778P

behajtható pengéjű kés, rozsdamentes acél penge, alumínium nyél, nyomógombos nyitómechanizmus • tokban



1778P	L mm	A mm	L1 mm	Ft		
	193	29	72	13.550	5	017780088

1778SCL

behajtható pengéjű kés soft carbon look kivitel penge edzett acélból tokkal szállítva



1778SCL	L mm	A mm	L1 mm	Ft		
	180	22	78	12.400	5	017780089

1778SOS

autós elsősegély kés ablaktörő kalapács és biztonsági öv vágó funkcióval tokban



1778SOS	L mm	A mm	L1 mm	Ft		
	205	25	85	13.350	5	017780080

1778V18

behajtható pengéjű kés alumínium nyél • tokban



1778V18	L mm	A mm	L1 mm	Ft		
	195	25	85	12.400	5	017780018

1778X

hajós kés rozsdamentes acélból, alumínium nyéllal tokban



1778X	L mm	L1 mm	A mm	Ft		
	185	85	25	11.600	2	017780050

MULTIFUNKCIÓS SZERSZÁM – 1778MT

A BETA multifunkciós szerszámát a BETA-ra jellemző tulajdonságok - a páratlan minőségű fogó, korszerű anyagok és a legújabb technológia - különböztetik meg a kereskedelmi forgalomban kapható más termékektől. A piacon legnépszerűbb kialakítású csavarokhoz való 11 betét minden környezetben és helyzetben - a kempingezéstől a hajózáson és barkácsoláson át a vadászatig - ideális.



22 FUNKCIÓ

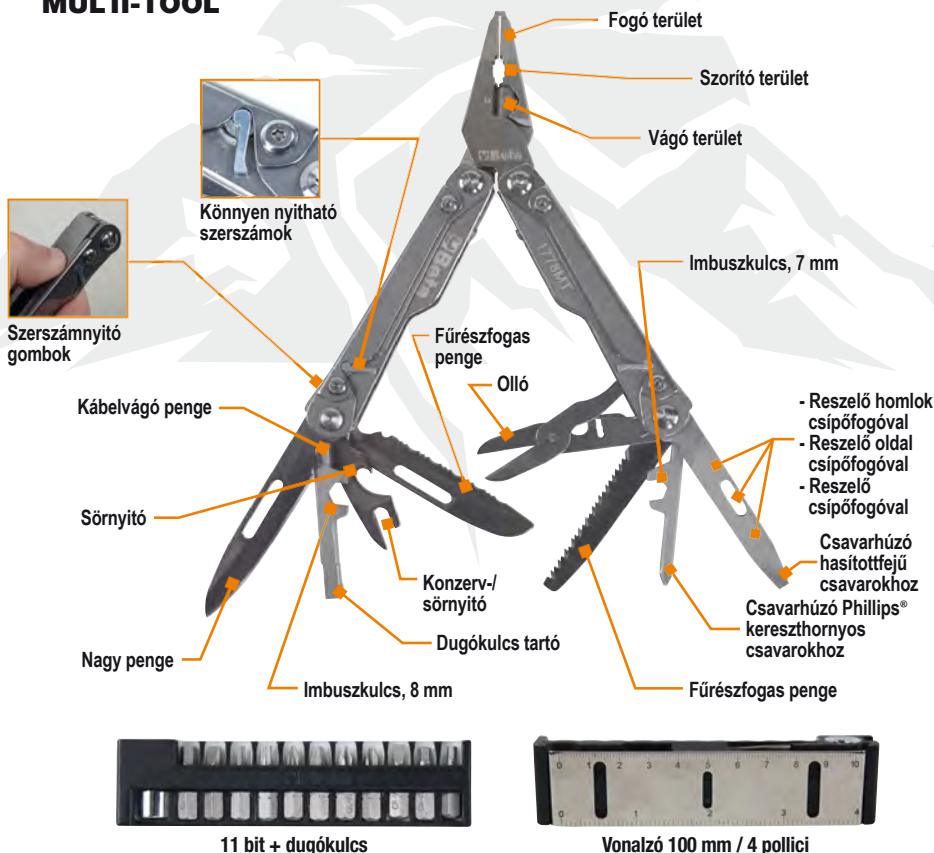

11 bit + dugókulcs



Vonalzó 100 mm / 4 pollici

1778MT

multifunkciós szerszám
csavarhúzó betétekkel és tokkal
9 szerszám
22 funkció



L mm	L1 mm	Ft	🔧	📦
180	115	48.100	1	017780055

1781

Hosszú élű drótvágó olló, krómozott



L mm	Ft	🔧	📦
1781 132	7.130	2	017810001

1783

Olló, könnyített kivitel



L mm	Ft	🔧	📦
215	5.910	5	017830021
240	6.940	5	017830024

1784

Erősített olló, nyél PVC-bevonattal



L mm	Ft	🔧	📦
175	8.760	2	017840017
200	11.450	2	017840020
250	15.750	2	017840025
300	20.900	2	017840030

1800/100

Emelőpárna (Max. 100 kg)

- Emel, szinten tart
- Ajtó és ajtószárny rögzítése • Ajtók és ablakok szerelésénél



A mm	B mm	S mm	Ft	🔧	📦
160	150	2+55	23.300	3	018000000



VILÁGÍTÁS

A világítási termékcsalád olyan termékek széles választékát tartalmazza, amelyeket a felhasználók minden igényének kielégítésére terveztek, a kis méretű csövek ellenőrzésétől a nagy munkaterületek megvilágításáig.

ZSEBLÁMPÁK

Az új, magával ragadó kialakítás, a technikai fejlesztések és a nagy méretválaszték lehetővé teszi a legmegfelelőbb zseblámpa kiválasztását olyan kritériumok alapján, mint a fényerő, az akkumulátor élettartama és a teljesítmény.

LÁMPÁK ÉS SPOTLÁMPÁK

A továbbfejlesztett LED-technológiának, az akkumulátorok hosszabb élettartamának, a rövidebb töltési időnek, az anyagokra való alapos odafigyelésnek és az innovatív megoldások folyamatos keresésének köszönhetően a Beta munkalámpái a tervezés, a funkcionalitás és a teljesítmény kiemelkedő kombinációját jelentik.

Olyan átfogó termékpalalettát kínálunk, amely célja, hogy a szakemberek a legjobb tudásuk szerint dolgozhassanak, bármilyen szektorban és bármilyen körülmények között.



VEZETÉK NÉLKÜL

Az új vezeték nélküli technológiának köszönhetően a modern reflektorok és lámpák egyetlen töltőállomáson tölthetők. Az új 1839BRV

töltőállomáson a legújabb reflektorok és lámpák kábelek nélkül, egyszerre tölthetők. Emellett a kihúzható konzol mobiltelefonok töltését is lehetővé teszi.



CRI - Color Rendering Index - Színvisszaadási index

CCT - Correlated Color Temperature - Korrelált színhőmérséklet

SPOT LÁMPÁK

TERMÉK	LUMEN	AKKUMULÁTOR	TÖLTÉSI IDŐ	ÉLETTARTAM	IP/IK	CCT	CRI
1837C/2100	500 - 1000 - 2100	Li-Ion 11.1V; 4400 mAh	4.0h	9 - 2.5h	IP65 - IK07	6500K	80+
1837C/4300	1100 - 2100 - 4300	Li-Ion 11.1V; 5200 mAh	4.0h	6 - 1.5h	IP65 - IK07	6500K	80+
1837M	500 - 1000 - 2000	Li-Ion 11.1 V, 5200 mAh	3.5h	2 - 8h	IP65 - IK07	2700-3500-4500-5500-6500K	96+
1838FLASH	360 - 720	Li-Ion 7.4 V; 4000 mAh	4.0h	4 - 8h	IP65	6300K	-
1838POCKET	160 - 400 - 800	Li-Ion 3.7 V; 2600 mAh	4.0h	3 - 9h	IP65	6500K	80+

LÁMPÁK

TERMÉK	LUMEN	AKKUMULÁTOR	TÖLTÉSI IDŐ	ÉLETTARTAM	IP/IK	CCT	CRI
1838/11LED	320	Li-Ion 3.7V; 4200 mAh	4.0h	4h	IP65	6500K	
1838AM	60 - 700 120 (spot)	Li-Ion 3.7V; 2600 mAh	4.0h - USB-C	2.5 - 16h 10h (spot)	IP54 - IK07	6500K	80+ 70+
1838COB	100 - 200 75 (spot)	Li-Ion 3.7V; 1600 mAh	3.0h	3-6h 4h (spot)	IP65	6000K	80+
1838P	80 - 50	Li-Ion 3.7V; 700 mAh	2.5h	4h	IP20	6000K	80+
1838SLIM	100 - 200 180 (back) 80 (spot)	Li-Ion 3.7 V, 700 mAh	2.5h - USB-C	2 - 4h 2h (back) 3h (spot)	IP54 - IK07	6500K	80
1838UV	75 - 150	Li-Ion 3.7V; 1600 mAh	3.0h	3h	IP20	6000K	80
1838SW	250 - 500 - 1000	Li-Ion 3.6V; 3350 mAh	4.5 - 6.5h	3 - 7h	IP65 - IK07	6500K	80+
1838E	500 - 1000 - 2000	Li-Ion 3.6V; 3350 mAh	4.5 - 6.5h	3 - 9h	IP20 - IK07	5500K	80+

FEJLÁMPÁK

TERMÉK	LUMEN	AKKUMULÁTOR	TÖLTÉSI IDŐ	ÉLETTARTAM	IP/IK	CCT	CRI
1836B	125 - 250	Li-Ion 3.8V; 1600 mAh	3.0h	5h	IP65 - IK07	6000K	80+
1836AW	30 - 200 - 400	Li-Ion 3.7V; 1500 mAh	2.5h	4-18h	IP65 - IK07	6500K	80+

ELEMLÁMPÁK

TERMÉK	LUMEN	AKKUMULÁTOR	TÖLTÉSI IDŐ	ÉLETTARTAM	IP/IK	VILÁGÍTÓ TÁVOLSÁG
1833XS/1	100	1 x AAA	-	5h	IP66	85m
1833XS/2	200	2 x AAA	-	10h	IP66	112m
1833S	500	2 x AA	-	10h	IP66	140m
1833M	700	3 x AAA	-	7.5h	IP66	170m
1833L	1100	3 x AA	-	8.5h	IP66	330m
1833L/USB	1200	Li-Ion 3.7 V, 2600 mAh	3.0h - USB-C	3.0h	IP66	230m
1833XL	1500	3xD	-	22h	IP66	290m
1834RR	130	Li-Ion 3.7 V, 550 mAh	2.0h	1h	IP30	-
1837F	500	3 x AA	-	14.5h	IP66	125m
1837F/USB	600	Li-Ion 3.7 V, 2900 mAh	4.0h - USB-C	10h	IP66	280m

1833L/USB

újrátölthető LED zseblámpa intenzív fényerővel, robusztus eloxált alumíniumból, 1 200 lumenig

- állítható gyújtópont
- 3 fényerősség beállítás
- elem üzemidő: 3 óra
- IP66
- világító távolság: 230 m
- alacsony töltés jelző (<15%)
- USB-C csatlakozón tölthető
- töltő nélkül szállítva



L mm 240	Ft 44.700	1	018330054
----------------	--------------	---	-----------

1833RB-L/USB

tartalék akkumulátor a 1833L/USB termékhez

1833RB-L/USB	Ft 22.400	1	018330975
--------------	--------------	---	-----------

1833XS/1

LED lámpa, robusztus eloxált alumíniumból

- 100 lumen
- állítható gyújtópont
- elemek: 1xAAA (nem tartozék)
- IP66
- elem üzemidő: 5 óra
- világító távolság: 85 m



L mm 92	Ft 7.700	3	018330000
---------------	-------------	---	-----------

1833XS/2

LED lámpa, robusztus eloxált alumíniumból

- 200 lumen
- állítható gyújtópont
- elemek: 2xAAA (nem tartozék)
- IP66
- akkumulátor üzemidő: 10 óra
- világító távolság: 112 m



L mm 133	Ft 8.430	3	018330001
----------------	-------------	---	-----------

1833S

LED zseblámpa intenzív fényerővel,
robosztus eloxált alumíniumból,
500 lumenig

- állítható gyújtópont
- 2 fényerősség beállítás
- elemek: 2xAA (nem tartozék)
- elem üzemidő: 10 óra
- IP66
- világító távolság: 140 m



L
mm 150 Ft 13.950 1 018330002

1833M

LED zseblámpa intenzív fényerővel,
robosztus eloxált alumíniumból,
700 lumenig

- állítható gyújtópont
- 2 fényerősség beállítás
- elemek: 3xAAA (nem tartozék)
- alacsony töltés jelző (<15%)
- elem üzemidő: 7,5 óra
- IP66
- világító távolság: 170 m



L
mm 162 Ft 17.400 1 018330003

1833L

LED zseblámpa intenzív fényerővel,
robosztus eloxált alumíniumból,
1 100 lumenig

- állítható gyújtópont
- 2 fényerősség beállítás
- elemek: 3xAA (nem tartozék)
- alacsony töltés jelző (<15%)
- elem üzemidő: 8,5 óra
- IP66
- világító távolság: 330m



L
mm 196 Ft 26.900 1 018330004

1833XL

LED zseblámpa intenzív fényerővel,
robosztus eloxált alumíniumból,
1 500 lumenig

- állítható gyújtópont
- 2 fényerősség beállítás
- elemek: 3xD (nem tartozék)
- alacsony töltés jelző (<15%)
- elem üzemidő: 22 óra
- IP66
- világító távolság: 290 m



L
mm 300 Ft 33.700 1 018330005

1834RR

szivargyújtó csatlakozóról
tölthető LED lámpa

állítható fény
Szivargyújtó aljzatról tölthető 10 - 28 V DC
IP30
130 Lumen



1834RR Ft 20.400 1 018340520

1836AW

tölthető, vezeték nélküli LED fejlámpa,
kettős fényerővel

- kettős világítás:
elől: 3 fényerősség, LED COB, 30 - 200 - 400 lumen
fejlámpa (reflektor): LED COB, 400 lumen
- újratölthető elem: Li-Ion 3,7 V, 1500 mAh, 5,55 Wh
- USB-C csatlakozó
- USB-C kábellel szállítva
- töltési idő: 2,5 óra
- elem üzemidő:
elől: 4-18 óra
fejlámpa (reflektor): 4 óra
- IP 65
- IK 07



1836AW Ft 27.250 1 018360051

1836B

tölthető csuklós LED fejlámpa, kettős
fényerővel és ON/OFF érzékelővel

- érintkezés nélküli ON/OFF érzékelő
- 250 Lumen
- Működési idő: 3-6 óra
- IP65



1836B Ft 50.150 1 018360200

1837F

Mágneses flexibilis lámpa, intenzív
fényű LED-ekkel,
robosztus eloxált alumíniumból,
500 lumen

- állítható gyújtópont
- 2 fényerősség beállítás
- elemek: 3xAA (nem tartozék)
- elem üzemidő: 14,5 óra
- töltésjelző
- IP66



L
mm 460 Ft 33.200 1 018370050

1837F/USB

Tölthető, mágneses flexibilis lámpa
intenzív fényű LED-ekkel,
robosztus eloxált alumíniumból,
600 lumen

- állítható gyújtópont
- 2 fényerősség beállítás
- elem üzemidő: 10,0 óra
- USB-C töltés
- IP66



L
mm 460 Ft 48.950 1 018370060

1837RB-F/USB

tartalék akkumulátor a 1837F/USB termékhez

1837RB-F/USB	Ft 17.100	1	018370960
--------------	--------------	---	-----------

1838POCKET

csuklós LED zsebreferktor kettős világítással és vezeték nélküli töltővel

- kettős világítás:
- fő lámpa: LED COB, 3 fényerősség: 160 - 400 - 800 lumen
- reflektor: LED SMD, 250 lumen
- világítási szög: fő lámpa: 160°
reflektor: 18°
- újratölthető 3,7V 2600mAh Li-ion elem
- 2 töltési mód: vezeték nélküli 1839BRW töltő állomás
USB-C csatlakozós tápegység
- töltési idő: vezeték nélküli töltő állomáson 4,5 óra
tápegységről 4 óra
- elem üzemidő: fő lámpa: 3-9h
reflektor: 4,5 óra
- 3-LED elem töltöttségi szint kijelző
- 210°-ban elforgatható
- csúszásmentes gumitest
- mágneses talp
- 1 mágnes a talpon
- IP65
- IK07
- USB-C kábellel szállítva



L mm	I mm	S mm	Ft	1	018380080
98	82	39	26.200		

1837C

tölthető LED reflektor az építőipar számára

- 3 fényerősség
- akkumulátortöltő: bemenet: 100-240V AC - 50/60Hz;
kimenet: 15V 1,5A
- töltési idő: 4 óra
- 3-LED töltésjelző
- 180°-ig elforgatható
- IP65 víz- és porvédelem
- IK07 ütészállóság



LxHxI mm	Lm	h	Ft	1	018370210
220x225x70	2100	2.5	64.000		
	1000	5.0			
	500	9.0			
266x236.6x59	4300	1.5	96.350		018370430
	2100	3.0			
	1100	6.0			

1837C/RA2100-4300



1837C/RA2100-4300	Ft 10.300	1	018370970
-------------------	--------------	---	-----------

1837M

tölthető LED COLOUR MATCH lámpa, színbeállításhoz, magas színvisszaadási index (CRI 96+), max. 2000 lumen

- 3 fényerő szint: 500/1000/2000 lumen
- CRI (színvisszaadási index): 96+
- CCT (korrelált színhőmérséklet): 2700K/ 3500K/ 4500K/ 5500K/ 6500K
- akkumulátortöltő: bemenet: 100-240V AC - 50/60Hz; kimenet: 15V 1,5A
- gyorskioldós töltőcsatlakozás
- töltési idő: 3,5 óra
- akkumulátor üzemidő: 8/4/2 óra
- töltésjelző
- gomb és LED színhőmérséklet jelző
- gomb és LED fényerő jelző
- 180°-ban elforgatható
- IP65
- IK07



LxHxI mm	Lm	h	Ft	1	018370450
220x225x70	500	8.0	106.600		
	1000	4.0			
	2000	2.0			

1837M/RA



1837M/RA	Ft 19.250	1	018370975
----------	--------------	---	-----------

1837S

háromlábú teleszkópos állvány munkalámpához

- fémből készült
- állítható magasság: 70+155 cm
- A 1837C és 1838FLASH modellel kompatibilis



h cm	Ft	1	018370500
70+170	20.200		

1838FLASH

Ultrakompakt feltölthető lámpa, legjobb megoldás mindenféle körülmények között.

INTENZÍV EGYENLETES FÉNY: max. fényerő 720 lumen, akkumulátorról és hálózatról egyaránt működtethető
BÁRMILYEN POZÍCIÓBAN RÖGZÍTHETŐ:
-felületekre: három oldalon csúszásmentes gumival vagy 1/4"-os belsőmenetes állvánnyal (Fényképezőgép Standard-állvány)
-fémekre: mágnessel vagy 360°-ban forgó horoggal
KOMPAKT: Csak 85x100x155 mm-es hely szükséges ahhoz, hogy a lámpát a szerszámtáskában is könnyen elhelyezhessük és szűk helyen használhassuk
ROBOSZTUS: Nehéz mechanikai kihívásoknak is megfelel. Tartós, hosszú élettartamú



1838FLASH	Ft 131.900	1	018380300
-----------	---------------	---	-----------

1838RB/FLASH

Tartalék akkumulátor 1838/FLASH modellhez

1838RB/FLASH	Ft 28.150	1	018380930
--------------	--------------	---	-----------

1838/11LED

Rendkívül nagy fényerejű tölthető LED lámpa lítium-polimeres akkumulátorral

- Kompakt csúszásmentes gumitest
- Egyszerűen cserélhető homloküveg
- Állítható kámpó
- 110-230 Vac töltőkészülékkel
- 340 Lumen
- Fejrézsi led a többirányú világításhoz



1838/11LED Ft 63.800 1 018380111

1838RA/10-11LED

pót tápegység az 1838/10LED és 1838/11LED lámpához

CE

1838RA/10-11LED Ft 13.400 1 018380903

1838RB/10LED

pótakkumulátor az 1838/10LED és 1838/11LED lámpákhoz

1838RB/10LED Ft 21.300 1 018380902

1838RR/11LED

töltőtálc az 1838/11LED lámpához

1838RR/11LED Ft 13.850 1 018380914

1838RV/11LED

karcvédő üveg a 1838/11LED lámpához



1838RV/11LED Ft 1.880 2 018380905

1838AM

tölthető LED szerelőlámpa, kettős fénykibocsátással, csuklós, 180°-ban elforgatható, mágneses forgótalppal és kámpóval

- kettős fénykibocsátás:
 - elől: LED COB, 60-700 lumen, potenciométerrel szabályozható spot (fej): LED SMD, 120 lumen, KI-BE kapcsoló
- újratölthető 3.6V 2600mAh Li-ion elem
- USB-C csatlakozó
- 100-240V / 50-60Hz töltővel szállítva
- töltési idő: 4 óra
- elem üzemidő:
 - elől: 2,5-16 óra
 - spot (fej): 10 óra
- 3-LED elem töltöttségi szint kijelző

- csuklós, 180°-ban elforgatható (a tengelyhez képest $\pm 90^\circ$ -ban)
- mágneses talp (neodímium mágnes), 90°-ban elforgatható
- forgó alap és kámpó

- IP54
- IK07



L I S L1
mm mm mm mm
1838AM 405 40 45 175 Ft 40.600 1 018380400

1838COB

tölthető hordozható LED lámpa

- felfüggeszhető, csúszásgátló és ütésálló gumiházzal
- Lítium-polimer akkumulátor
- Mágneses talp, 180 fokban állítható
- 100-240 Vac / 50-60 Hz töltővel
- 100/200 lumen; SPOT 75 lumen
- Üzemidő: 6 ó / 3 ó; SPOT 4 ó
- töltési idő: 3 óra
- IP65

CE
IP65



1838COB Ft 35.850 1 018380010

1838P

tölthető toll lámpa, kettős fénykibocsátással: lámpa vagy zseblámpa

- Kompakt test csúszásmentes gumiból
- 50/80 Lumen
- Zsebhez rögzítő horog
- Mágneses talp, 180 fokban állítható
- USB/3.5 mm jack töltőkábelrel szállítva
- Üzemidő: 2.5 óra
- IP20

CE
IP65



1838P Ft 30.850 1 018380005

1838SLIM

tölthető csuklós keskeny 3-LED-es szerelőlámpa

- hármas világítás
- elől: 100/200 lumen/ hátul: 180 lumen/ spot (fej): 80 lumen
- mágneses talp
- töltési idő: 2,5h
- működési idő: 2-4 óra/ spot

CE
IP54



L I S
mm mm mm
1838SLIM 307 17 29 Ft 22.650 1 018380221

 Beta

 Beta

1838SW

tölthető csuklós LED szerelőlámpa
vezeték nélküli töltővel

- kettős világítás:
- elől: LED COB, 3 fényerősség: 250 - 500 - 1000 lumen
- spot (fej): LED SMD, 200 lumen
- újratölthető 3,6V 3.350mAh Li-ion elem
- 2 töltségi mód: vezeték nélküli 1839BRW töltő állomás
USB-C csatlakozós tápegység
- töltségi idő: vezeték nélküli töltő állomáson 6,5 óra
tápegységről 4,5 óra
- elem üzemidő: elől: 3-5 óra
spot (fej): 7 óra
- 3-LED elem töltöttségi szint kijelző
- 180°-ban elforgatható talp
- csúszásmentes gumitest
- kettős kámpó
- 3 mágnes a hátoldalon
- 1 mágnes a talpon
- IP65
- IK07
- USB-C kábellel szállítva



L	I	S	Ft	1	018380142
mm	mm	mm			
260	53	40	37.400		

1838UV

UV + fehér fényű tölthető lámpa
ideális a szivárgások keresésére

- Kompakt csúszásmentes gumi test
- 100-240 Vac / 50-60 Hz tápegységgel
- 150 lumen / UV



L	I	S	Ft	1	018380150
mm	mm	mm			
260	53	40	59.800		

1838E

tölthető motortér bevilágító LED lámpa

- három fényerősség: 500/1000/2000 lumen
- 360°-ban elforgatható
- állítható hossz: 116 ± 188 cm
- alumínium test
- csúszásmentes gumikámpó
- USB-C töltés
- 2 töltségi mód:
lámpa USB csatlakozóján keresztül
belső akkumulátor USB csatlakozóján keresztül
- töltővel szállítva
bemeneti teljesítmény: 100-240V ~ 50/60Hz
kimeneti teljesítmény: DC 5V - 2000 mA
- elem üzemidő: 3-9 óra
- IP20
- IK07

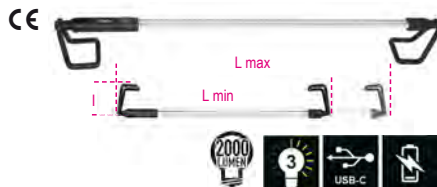

IP20
IK07

L min	L max	I	Ft	1	018380270
mm	mm	mm			
1170	1880	150	70.350		

1838E-BT

tölthető akkumulátor az 1838E lámpához,
USB-C csatlakozóval

- Li-Ion 3,6V
- DC 5V - 2000 mA

CE

1838E-BT	Ft	1	018380271
	19.850		

1839BRW

vezeték nélküli töltő állomás,
a 1838POCKET és 1838SW szerelőlámpával
kompatibilis

- két mágneses töltőhely egyidejű használathoz
- kihúzható támasz a vezeték nélküli mobiltelefon töltéshez
- LED töltési állapotjelző
- max. teljesítményfelvétel: 10W x2
- bemenet: AC 100-240V 50/60Hz
- kimenet: DC 12V 1,5A
DC 9V 2A
DC 5V 3A
- USB-C csatlakozó
- falra szerelhető: 3 erős mágnes a hátoldalon
2 csavarlyuk

- IP20
- IK07



L	I	S	Ft	1	018390002
mm	mm	mm			
101	190	28	31.550		

1839/R5

USB-C QC 3.0 kábel, tartalék a 1838POCKET
és 1839BRW modellhez

1839/R5	Ft	1	018390505
	3.360		

1839/R6

USB Q C3.0 gyorsöltő transzformátor, tartalék
a 1838POCKET és 1839BRW modellhez

1839/R6	Ft	1	018390506
	9.880		

1839/R1

USB kimenetes transzformátor, pótalkatrész
az 1833L/USB, 1836B, 1837F/USB,
1838COB, 1838P, 1838S, 1838SLIM, 1838UV,
1838AM, 1838E lámpához

CE

1839/R1	Ft	1	018390501
	8.590		

1839/R2

USB/jack 3.5 mm-es vezeték, pótalkatrész az
1836B; 1838P; 1838COB; 1838UV lámpához

1839/R2	Ft	1	018390502
	3.400		

1839/R4

USB/USB-C kábel, tartalék a 1833L/USB,
1833F/USB, 1838SLIM, 1838S, 1838AM,
1838E termékhez

1839/R4	Ft	1	018390504
	2.890		

Beta

Beta

1840BM

Szerelőlámpa
E 27 foglalatú izzó
Feszültség 230V
Izzó nélkül



CE



IP20

1840BM V 230 W 60 L mm 420 Ft 26.200 1 018400101

1842LED/BM

nagy fényerejű LED lámpa, 230 Vac

- 10 m vezeték
- kompakt test csúszásgátló gumbiól
- könnyen cserélhető homloküveg
- állítható horog
- 340 Lumen
- a fejrészen LED a többirányú megvilágításért



CE



1842LED/BM L mm 230 Ft 53.550 1 018420301

1842LED/ABM

nagy fényerejű LED lámpa, 24 V

- 10 m vezeték
- kompakt test csúszásgátló gumbiól
- könnyen cserélhető homloküveg
- állítható horog
- 340 Lumen
- a fejrészen LED a többirányú megvilágításért



CE



1842LED/ABM L mm 230 Ft 49.350 1 018420311

KÁBELDOBOK



A Beta új, változatos és átfogó kábeldobjait úgy terveztük és fejlesztettük, hogy minden szakember igényeit a legmesszebbmenők kielégítsék.

- A kábeldob családban számos különféle hosszúságú és típusú kábel megtalálható, köztük LED lámpával és SCHUKO aljzattal és dugókkal szerelt változatok.
- Tömlődobjainkra 8 mm és 10 mm átmérőjű tömlőket csévélünk.

A nagy ellenállású rugó kiváló tartósságot és kiemelkedően egyenletes csévéelést biztosít. A vastag polipropilén dob rendkívül ütésálló. Az automatikus visszacsévéelést leállító retesz könnyen kikapcsolható, lehetővé téve a folyamatos behúzást.

Mindegyik kábeldob 180°-ban elforgatható fali konzolt, valamint a fali tartóra való gyors rögzítést és leszerelést biztosító kiegészítő konzolt tartalmaz.

KÁBELDOBOK

A nem kevesebb, mint 18 változattal álló termékcsaládot úgy terveztük, hogy minden munkahelyzetben megállja a helyét és a legigényesebb felhasználókat is kielégítse. A kábeldobokba modelltől függően 10-30 méteres, 2x1,0 mm² és 5Gx1,5mm² keresztmetszet közötti H05VV-F és H07RN-F típusú kábelek kerülnek. Az összes kábeldob – 3Gx2,5mm² keresztmetszetig – hővédő kapcsolót is tartalmaz, mely az áramkör túlterhelése esetén kapcsol be.



TÖMLŐDOBOK 337

Pneumatikus szerszámokhoz használható 10-15 méteres, 8-10 mm átmérőjű tömlőcsalád.

A termékeink szivárgásmentesek, ezért vízzel is használhatók.

Termék	==	Vezetők	Keresztmetszet	Kábeltípus	Hossz	Hővédő kapcsoló	Tartozék
1842 15-H05/LED	018420821	2x	1,0 mm ²	H05VV-F	15+1 m	IGEN	LED lámpa
1843 15-H05	018430215	2x	1,5 mm ²	H05VV-F	15+1 m	IGEN	
1844 10-H05	018440310	3G	1,5 mm ²	H05VV-F	10+1 m	IGEN	-
1844 15-H05	018440315			H05VV-F	15+1 m	IGEN	-
1844 15-H07	018440317			H07RN-F	14+1 m	IGEN	-
1844 30-H05	018440330			H05VV-F	30+2 m	IGEN	-
1844 15-H05/SCK	018440316	3G	1,5 mm ²	H05VV-F	15+1 m	IGEN	SCHUKO
1844 15-H07/SCK	018440318			H07RN-F	14+1 m	IGEN	SCHUKO
1845 12-H05	018450365	3G	2,5 mm ²	H05VV-F	12+1 m	IGEN	
1845 15-H07	018450367			H07RN-F	15+1 m	IGEN	
1845 25-H07	018450377			H07RN-F	25+1,5 m	IGEN	
1846 10-H05	018460405	4G	1,5 mm ²	H05VV-F	10+1 m	NEM	
1846 10-H07	018460407			H07RN-F	10+1 m	NEM	
1846 15-H05	018460415			H05VV-F	15+1 m	NEM	
1847 10-H05	018470420	4G	2,5 mm ²	H05VV-F	10+1 m	NEM	
1847 15-H07	018470427			H07RN-F	15+1 m	NEM	
1848 10-H05	018480510	5G	1,5 mm ²	H05VV-F	10+1 m	NEM	
1848 15-H07	018480517			H07RN-F	15+1 m	NEM	

1842

LED lámpával szerelt automata kábeldob,
100-240 Vac

- 230/12V biztonsági transzformátorral
- H05VV-F 2x1,0 mm²kábel
- feltekert kábelhossz: 15 m
- 1.5 m tápkábel SCHUKO csatlakozóval
- dobon kívüli kábel hossza: 1 m
- a reteszelő mechanizmus kikapcsolható, így a kábel folyamatos visszahúzását teszi lehetővé
- 180°-os elforgatható konzollal és kiegészítő gyorscsatlakozó konzollal szállítva

CE



IP42
IP65

L=15 m



L
m

Ft



1842 15-H05/LED H05VV-F 15+1 120.300 1 018420821

1846R-LED/BM

LED pótlámpa

12-24 V - AC-DC



1846LED/BM R Ft 37.050 1 018460331

1843

automata kábeldob 2x1,5 mm² kábelrel

- H05VV-F 2x1,5 mm² kábel
- hővédő kapcsolóval
- feltekert kábelhossz: 15 m
- dobon kívüli kábel hossza: 1 m
- tápkábel nélkül szállítva
- a reteszelő mechanizmus kikapcsolható, így a kábel folyamatos visszahúzását teszi lehetővé
- max. teljesítmény (felcsévélve): 1300W (230V-20°C)
- max. teljesítmény (kiengedve): 2300W (230V-20°C)
- 180°-os elforgatható konzollal és kiegészítő gyorscsatlakozó konzollal szállítva

CE



IP42



L
m

Ft



1843 15-H05 H05VV-F 15+1 80.350 1 018430215

1844

automata kábeldob 3Gx1,5 mm² kábelrel

- 3Gx1,5 mm² kábel
- hővédő kapcsolóval
- dobon kívüli kábel hossza: 1 m (kivéve a 1844 30-H05, 2 m)
- tápkábel nélkül szállítva
- a reteszelő mechanizmus kikapcsolható, így a kábel folyamatos visszahúzását teszi lehetővé
- max. teljesítmény (felcsévélve): 1500W (230V-20°C)
- max. teljesítmény (kiengedve): 2500W (230V-20°C)
- 180°-os elforgatható konzollal és kiegészítő gyorscsatlakozó konzollal szállítva

CE



IP42



L
m

Ft



1844 10-H05	H05VV-F	10+1	75.900	1	018440310
1844 15-H05	H05VV-F	15+1	78.400	1	018440315
1844 15-H07	H07RN-F	14+1	85.350	1	018440317
1844 30-H05	H05VV-F	30+2	150.500	1	018440330

1844SCK

automata kábeldob 3Gx1,5 mm² kábelrel és
SCHUKO csatlakozóval

- 3Gx1,5 mm² kábel
- hővédő kapcsolóval
- dobon kívüli kábel hossza: 1 m
- 1,5 m tápkábelrel és SCHUKO csatlakozóval szállítva
- a reteszelő mechanizmus kikapcsolható, így a kábel folyamatos visszahúzását teszi lehetővé
- max. teljesítmény (felcsévélve): 1500W (230V-20°C)
- max. teljesítmény (kiengedve): 2500W (230V-20°C)
- 180°-os elforgatható konzollal és kiegészítő gyorscsatlakozó konzollal szállítva

CE



IP42

L=15 m



L
m

Ft



1844 15-H05/SCK	H05VV-F	15+1	81.750	1	018440316
1844 15-H07/SCK	H07RN-F	14+1	88.550	1	018440318

1845

automata kábeldob 3Gx2,5 mm² kábelrel

- 3Gx2,5 mm² kábel
- hővédő kapcsolóval
- dobon kívüli kábel hossza: 1 m (kivéve a 1845 25-H07RN-F, 1,5 m)
- tápkábel nélkül szállítva
- a reteszelő mechanizmus kikapcsolható, így a kábel folyamatos visszahúzását teszi lehetővé
- max. teljesítmény (felcsévélve): 2000W (230V-20°C)
- max. teljesítmény (kiengedve): 3000W (230V-20°C)
- 180°-os elforgatható konzollal és kiegészítő gyorscsatlakozó konzollal szállítva

CE



IP42



L
m

Ft



1845 12-H05	H05VV-F	12+1	161.800	1	018450365
1845 15-H07	H07RN-F	15+1	161.800	1	018450367
1845 25-H07	H07RN-F	25+1,5	203.600	1	018450377

1846

automata kábeldob 4Gx1,5 mm² kábelrel

- 4Gx1,5 mm² kábel
- hővédő kapcsolóval
- dobon kívüli kábel hossza: 1 m
- tápkábel nélkül szállítva
- a reteszelő mechanizmus kikapcsolható, így a kábel folyamatos visszahúzását teszi lehetővé
- max. teljesítmény (felcsévélve): 1400W (230V-20°C)
- max. teljesítmény (kiengedve): 1900W (230V-20°C)
- 180°-os elforgatható konzollal és kiegészítő gyorscsatlakozó konzollal szállítva

CE



IP42



L
m

Ft



1846 10-H05	H05VV-F	10+1	86.850	1	018460405
1846 10-H07	H07RN-F	10+1	89.950	1	018460407
1846 15-H05	H05VV-F	15+1	89.950	1	018460415

1847

automata kábeldob 4Gx2,5 mm² kábelrel

- 4Gx2,5 mm² kábel
- hővédő kapcsoló nélkül
- dobon kívüli kábel hossza: 1 m
- tápkábel nélkül szállítva
- a reteszelő mechanizmus kikapcsolható, így a kábel folyamatos visszahúzását teszi lehetővé
- max. teljesítmény (felcsévéve): 2000W (230V-20°C)
- max. teljesítmény (kiengedve): 2700W (230V-20°C)
- 180°-os elforgatható konzollal és kiegészítő gyorscsatlakozó konzollal szállítva

CE

IP42



	L m	Ft		
1847 10-H05	H05VV-F 10+1	93.450	1	018470420
1847 15-H07	H07RN-F 15+1	173.700	1	018470427

1848

automata kábeldob 5G2x1,5 mm² kábelrel

- 5Gx1,5 mm² kábel
- hővédő kapcsoló nélkül
- dobon kívüli kábel hossza: 1 m
- tápkábel nélkül szállítva
- a reteszelő mechanizmus kikapcsolható, így a kábel folyamatos visszahúzását teszi lehetővé
- max. teljesítmény (felcsévéve): 1400W (230V-20°C)
- max. teljesítmény (kiengedve): 1900W (230V-20°C)
- 180°-os elforgatható konzollal és kiegészítő gyorscsatlakozó konzollal szállítva

CE

IP42



	L m	Ft		
1848 10-H05	H05VV-F 10+1	97.000	1	018480510
1848 15-H07	H07RN-F 15+1	185.400	1	018480517

1850D

3 sebességű hőlégfúvó pisztoly

- 1. pozíció 250 l/perc 50 °C
- 2. pozíció 250 l/perc 400 °C
- 3. pozíció 500 l/perc 550 °C

CE



	L mm	H mm	Ft		
1850D	255	210	49.050	1	018500018

1850E

állítható elektronikus hőlégfúvó pisztoly

- 1. pozíció 250-500 l/perc 50 °C
- 2. pozíció 250-500 l/perc 50-650 °C

- digitális kijelző
- hőmérséklet és légátesztés szabályozó gomb
- 4 tárolt program és egyedi programozási lehetőség

- 1. program 150 °C kb. 400 l/perc
- 2. program 200 °C kb. 400 l/perc
- 3. program 300 °C kb. 450 l/perc
- 4. program 400 °C kb. 500 l/perc

CE



	L mm	H mm	Ft		
1850E	255	210	102.400	1	018500020

1851VK

hőragasztó-pisztoly 12 ragasztóstifttel, táskában

- teljesítmény: 80 W
- ø 11 mm és 12 mm ragasztóstifthez

CE



	Ft		
1851VK	20.950	1	018510058

320x250x50 mm

1851VK-12C

12 ragasztó stift
Ø 11 mm



	Ft		
1851VK-12C	5.150	1	018510062

1851VK-12V

12 db hőragasztó stick
festett felületekhez
Ø 11 mm



	Ft		
1851VK-12V	5.070	1	018510072

1852R1750

hordozható indukciós hevítő készülék



CE

- felmelegíti és kioldja a különösen megszorult csavarokat, anyákat, kerékagyakat és csapágyakat, láng használata nélkül
- lehetővé teszi bármilyen ferromágneses fém felmelegítését

Tartozékok:

- két homlokzati tekercs 19 és 26 mm átmérővel anyák kioldásához
- egy lapos fűtőtekercs felületek melegítéséhez
- egy 800 mm hosszú rugalmas fűtőtekercs
- műanyag táskában szállítva

Műszaki adatok:

- bemeneti feszültség: 230V AC, 50/60 Hz
- bemeneti áramerősség: max. 7,5A
- teljesítmény: max. 1.75 kW

OPCIÓK

Ezen kívül további fűtőtekercs méretek is rendelhetők

ELŐNYÖK

- Idő megtakarítás: gyors és nagy pontosságú melegítés
- Tűzbiztonság: nem hoz létre lángot, maximális biztonság a kezelő számára
- Praktikus: egy kézzel használható, és a fűtőtekercsek könnyen cserélhetők

FELHASZNÁLÁSI TERÜLETEK

- Autóipar
- Ipari karbantartás
- Légi jármű ipar
- Hajóipar
- Petrolkémia ipar

	Ft		
1852R1750	589.800	1	018520175

480x370x130 mm - 4,5 kg

1852S-CNT

tekercs



	Ft		
1852S-CNT	43.850	1	018520520

1852S-CC

tekercs



	Ft		
1852S-CC	35.600	1	018520521

1852S-KR/CNT

tartalék alkatrész készlet tekercshez



1852S-KR/CNT	Ft		
	18.700	1	018520522

1852S-L

oldalsó fűtőtekercs



	Ø	M	L	Ft		
	mm		mm			
1852S-L 19	19	M6	220	17.600	1	018520501
1852S-L 20	20	M8	220	17.600	1	018520502
1852S-L 23	23	M10	220	17.600	1	018520503
1852S-L 26	26	M12	220	17.600	1	018520504
1852S-L 32	32	M16	220	17.600	1	018520505
1852S-L 38	38	M20	220	20.100	1	018520506
1852S-L 45	45	M22	220	22.200	1	018520507

1852S-F

homlokzati fűtőtekercs



	Ø	M	L	Ft		
	mm		mm			
1852S-F 19	19	M6	220	17.600	1	018520508
1852S-F 20	20	M8	220	17.600	1	018520509
1852S-F 23	23	M10	220	17.600	1	018520510
1852S-F 26	26	M12	220	17.600	1	018520511
1852S-F 32	32	M16	220	17.600	1	018520512
1852S-F 38	38	M20	220	20.100	1	018520513
1852S-F 45	45	M22	220	22.050	1	018520514

1852S-FLESS

rugalmas fűtőtekercs



	Ft		
1852S-FL 750	13.350	1	018520519
1852S-FL 800	33.300	1	018520515
1852S-FL1000	41.800	1	018520517
1852S-FL1500	51.100	1	018520518

1852 S-PIATTE

lapos fűtőtekercs



1852S-PIATTE	Ft		
	20.100	1	018520516

Beta

Beta
Quality Tools



HEGESZTÉSTECHNIKAI



**INVERTERES
HEGESZTŐKÉSZÜLÉKEK**

Könnyen használható, kiváló hegesztési karakterisztikájú hegesztőkészülékek különböző elektródákhoz. Túlfeszültség és túlmelegedés védelem. Az elektróda letapadását gátló (anti-sticking) funkció. Kompakt és könnyű. Ideális karbantartási, könnyűipari és barkács munkálatokhoz.



HEGESZTŐPAJZSOK

A Beta többféle, automatikusan sötétedő LCD hegesztőpajzsot kínál többek között ívhegesztéshez, MIG/MAG, TIG és plazmahegesztéshez. A védelmet és kényelmet az összes aktuális munkavédelmi szabványnak való teljes körű megfelelés garantálja.



**HEGESZTÉSTECHNIKAI
KIEGÉSZÍTŐK**

A hegesztési munkákhoz kiegészítők széles választéka kapható.



**GÁZOS
ŐNHEGESZTŐ
KÉSZÜLÉKEK**

Kisebb karbantartási és mikroelektronikai munkákhoz készült hegesztőkészülékek és kiegészítők. A vezetékes hegesztőkészülékek mellett a Beta többféle butángázos megoldást kínál, mely villamosáram nélküli, szabadtéri munkavégzést is lehetővé tesz.

1808

Forrasztópáka acélezott hegygel, komplettírozva egy egyenes kemény hegygel 1824R8



W	V	Ft	1	018080001
20/130	230	29.650	1	018080001

1812 150

pillanatforrasztó páka



W	V	Ft	1	018120015
150	230	42.350	1	018120015

1814M

Forrasztópáka kemény hegygel



W	V	Ft	1	018140225
25	230	23.250	1	018140225
30	230	25.100	1	018140230
40	230	27.200	1	018140240

1820

forrasztópáka



1820 30	Ft	1	018200003
30W L = 210mm	17.800	1	018200003
1820 60	20.400	1	018200006
60W L = 220mm			
1820 80	28.600	1	018200008
80W L = 260mm			

1822

nagyteljesítményű forrasztópáka



1822 120	Ft	1	018220012
120W LxA = 250x125 mm	44.700	1	018220012
1822 180 <td>47.300</td> <td>1</td> <td>018220018</td>	47.300	1	018220018
180W LxA = 250x125mm			
1822 320 <td>57.950</td> <td>1</td> <td>018220032</td>	57.950	1	018220032
320W LxA = 250x140mm			

1823 60

digitális vezérlésű forrasztóállomás forrasztópákával

- Folyamatos hőmérséklet szabályozás 160°C és 480°C között, ±1%-os pontossággal.
- Memória funkció a kikapcsolás pillanatában kijelölt hőmérséklet mentésére.
- 3 gyorsválasztó gomb (200-300-400°C).



W	Ft	1	018230060
60	170.000	1	018230060

1823R/60

cseré forrasztópáka a 1823 60 modellhez



1823R 60	Ft	1	018230066
	34.150	1	018230066



1824R

Tartalék forrasztópákahegyek

1824R 08	Ft	1	018240100
1808	12.550	1	018240100
1824R 12	1.660	1	018240301
1812/150			
1824R 14-M25	1.660	1	018240152
1814M/25			
1824R 14-M30	1.660	1	018240153
1814M/30			
1824R 14-M40	1.660	1	018240154
1814M/40			
1824R 20	2.160	1	018240302
1820/30			
1824R 60	2.170	1	018240303
1820/60			
1824R 80	3.310	1	018240304
1820/80			
1824R 120-180	27.150	1	018240305
1822/120 -/180			
1824R 320	34.700	1	018240307
1822/320			
1824R ST-60	4.750	1	018240308
1823-60			

1825B

forrasztóon huzal, antioxidáns

- 1mm² huzal, 250g
- Sn 99.3%; Cu 0.7%



1825B	Ft	1	018250251
	25.250	1	018250251

1827

Gázal működő forrasztópáka, beállítható



1827	Ft	1	018270001
	54.200	1	018270001

1827PC

Kúpos hegy az 1827-hez



1827PC 1,6	Ft	1	018270501
	10.950	1	018270501
1827PC 3,2	10.950	1	018270502

1827PCL

Késszerű hegy az 1827-hez



1827PCL 2,4	Ft	1	018270503
	10.950	1	018270503

1827PFL

Tartalékhegy az 1827-hez



1827PFL Ft 10.950 1 018270504

1827/K

Gázzal működő forrasztópáka 7 tartozékkal
PUR-habszivaccsal bélelt kofferban



- Teljesítmény: 30 Watt-125 Watt
- Forrasztóhegy hőmérséklet beállítható 250 °C-500 °C között
- Gázáteresztés szabályozó
- Felfűtési idő:
15 másodperc a bekapcsolás után
- A tartály 120 percre elegendő gázt tartalmaz
- Áttetsző tartály a gázmennyiség figyeléséhez
- Butángázzal újratölthető

1827/K Ft 83.800 1 018270100

1827F

butángázos forrasztó készülék

tartály 35 g

- három csereszabatos fúvóka, 550°C; 1000°C és 1300°C
- merev táskában, állvánnyal szállítva



1827F Ft 60.200 1 018270200

1830T

Ónszippantó antisztatikus hegygel



L mm 190 Ft 6.100 5 018300021

1860BH/120A

Egyenáramú inverteres hegesztőkészülék
rutilos, bázikus és rozsdamentes acél
elektrodás MMA hegesztéshez,
kompakt és könnyen szállítható
Arc force (ívstabilizáló), hot start (emelt
indítóáram), anti-sticking (letapadásvédelem)
és hővédelem funkció
szabályozási áramerősség: 10÷120A
tápfeszültség: 1 x 230 V

munkavégzési tényező (40°C) :
25% - 120 A
50% - 80 A
100% - 60 A
védelmi fok: IP22S
használható elektrodák: Ø 1.6 - 3.2 mm rutilos, bázikus, inox,
öntöttvas, stb.
16 mm² vezetékkel szállítva

CE



1860BH/120A Ft 135.500 1 018600121

1860BH/160A

Egyenáramú inverteres hegesztőkészülék
rutilos, bázikus és rozsdamentes acél
elektrodás MMA hegesztéshez,
kompakt és könnyen szállítható
Arc force (ívstabilizáló), hot start (emelt
indítóáram), anti-sticking (letapadásvédelem)
és hővédelem funkció
szabályozási áramerősség: 10÷160A
tápfeszültség: 1 x 230 V

munkavégzési tényező (40°C) :
25% - 160 A
60% - 100 A
100% - 80 A
védelmi fok: IP22S
használható elektrodák: Ø 1.6 - 4 mm rutilos, bázikus, inox,
öntöttvas, stb.
16 mm² vezetékkel szállítva

CE



1860BH/160A Ft 174.700 1 018600161

1860BH/200A

Egyenáramú inverteres hegesztőkészülék
rutilos, bázikus és rozsdamentes acél
elektrodás MMA hegesztéshez,
kompakt és könnyen szállítható
Arc force (ívstabilizáló), hot start (emelt
indítóáram), anti-sticking (letapadásvédelem)
és hővédelem funkció
szabályozási áramerősség: 10÷200A
tápfeszültség: 1 x 230 V

munkavégzési tényező (40°C) :
25% - 200 A
60% - 130 A
100% - 100 A
védelmi fok: IP22S
használható elektrodák: Ø 1.6 - 4 mm rutilos, bázikus, inox,
öntöttvas, stb.
16 mm² vezetékkel szállítva

CE



1860BH/200A Ft 194.300 1 018600201

1860BH R/CM

tartalék földkábel
a 1860BH-120/160/200A inverteres
hegesztőkészülékekhez



1860BH R/CM Ft 18.600 1 018600612

1860BH R/CS

tartalék elektróda kábel
a 1860BH-120/160/200A inverteres
hegesztőkészülékekhez



1860BH R/CS Ft 22.700 1 018600613

1860BHT/160A

egyenáramú inverteres hegesztőkészülék acélelektrodás MMA és TIG hegesztéshez, kompakt és könnyen szállítható

Arc force (ívstabilizáló), STICK/TIG (lift arc), hot start (emelt indítóáram), anti-sticking (letapadásvédelem) és hővédelem funkció
szabályozási áramerősség: 10+160 A
tápellátás: 1x230 V
munkavégzési tényező (40°C):
60% - 160 A
100% - 130 A
védelem: IP23S
használható elektrodák: Ø 1.6 - 4 mm, rutilos, bázikus, rozsdamentes acél.
25 mm² kábelekkel szállítva

CE



1860BHT/160A	Ft	1	018600179
	340.400		

1860BHT R/CM

tartalék földkábel a 1860BHT TIG hegesztőkészülékhez



1860BHT R/CM	Ft	1	018600616
	29.000		

1860BHT R/CS

tartalék hegesztő fogó kábel a 1860BHT TIG hegesztőkészülékhez



1860BHT R/CS	Ft	1	018600617
	37.400		

1860M

mágneses, derékszögű szorító hegesztéshez billenős szorítópfával

ideális eltérő méretű darabok rögzítéséhez

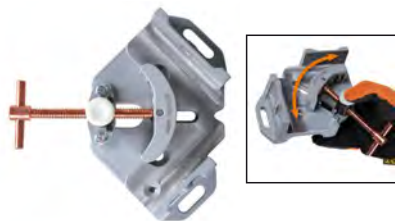

1860M	L max mm	Ft	1	018600301
	30	30.000		

1860DM

mágneses korong fémlemezekkel való munkához

fémlemezek mozgatásához és rögzítéséhez ideális egyenletes mágneses erő a korong teljes felületén lyukas fogantyú a könnyebb függőleges mozgatáshoz



1860DM 16	kg max	Ft	1	018600310
	16	21.300		
1860DM 40	kg max	Ft	1	018600311
	40	30.100		

1860PMIG

univerzális fogó MIG hegesztéshez



1860PMIG	L mm	L1 mm	Ft	2	018600350
	215	44	15.450		

1860EI

mágneses négyszög, 90°, belső és külső szögekhez

Ideális cső vagy lapos részegységek rögzítésére 18 kg mágneses erő, 30° és 60° letörés a hatszögű lyuknak köszönhetően könnyeb leválasztani a mágnes a fémről



1860EI	L mm	L1 mm	S mm	Ft	1	018600290
	165	110	35	13.000		

1860RG

állítható mágneses négyszög, 30°-270°

Ideális cső vagy lapos részegységek rögzítésére 27 kg mágneses erő, hajlítót imbuszkulccsal a rögzítési szög állításához, csapszeggel a 30°-45°-90°/270°-180° szög rögzítéséhez a hatszögű lyuknak köszönhetően könnyeb leválasztani a mágnes a fémről



1860RG	L mm	S mm	Ft	1	018600255
	155	35	23.700		

1860SQ

45°/90° mágneses négyszög

ideális cső vagy lapos részegységek rögzítésére 35 Kg mágneses erő nem igényel elemet, a BE/KI kapcsolás a belső mágnesek megdöntésével érhető el hatékony forgácsmentesítés a mágnesek KI helyzetbe állításával



1860SQ	Ft	1	018600210
	35.700		

7041LCD/4S

LCD hegesztőpajzs automatikus sötétedéssel, ívhegesztéshez; MIG/MAG, TIG és plazmahegesztéshez. 4 érzékelő TRUE COLOR szűrő szolárcellák és lítium akkumulátorok biztosítják az LCD filter áramellátását és hosszú élettartamát

- Látómező: 98x80 mm
- Sötétedési tartomány: 5+8.5/ 9-13, belső beállítás
- UV/IR-védelem: DIN16
- Sötétedési idő: 1/25000 s
- Világosodási idő: 0,1-2,0s
- Állítható sötétedés érzékenység és késleltetés
- Automatikus be- és kikapcsolás
- Készülék üzemmod
- Alacsony töltöttség kijelző

- Ergonomikus kialakítás, könnyű súly, kiegyensúlyozott
- Állítható gyűrűsanya



CE

7041LCD/4S	Ft	1	070410001
	103.800		

7041LCD/4S-VE

karcálló üveg a 7041LCD/4S modellhez

7041LCD/4S-VE	Ft	2	070410101
	3.190		

7041LCD/4S-VI

belső üveg a 7041LCD/4S modellhez

7041LCD/4S-VI	Ft	2	070410102
	1.430		

Beta
Quality Tools

7042LCD

LCD-hegesztő pajzs automatikus sötétéddéssel az ívhegesztéshez MIG/MAG; TIG és plazmahegesztéshez.

Áramellátás szolárcellákkal és Lithium-akkumulátorokkal, hosszú élettartamú LCD-filtterekkel

- Látómező 98x43 mm
- Sötétéddési szakasz DIN 9-13 külső beállítás
- UV/IR-védelem
- Sötétéddési idő: 1/25000 s
- Világosodási idő: 0.25-1s
- Sötétéddés érzékenysége és késedelme beállítható
- Automatikus be- és kikapcsolás
- Köszörülési üzemmód
- Optimális forma problémamentes légzés



7042LCD Ft 75.150 1 070420001

7042LCD/RV

karcálló üveg a 7042LCD, 7043 modellhez

7042LCD/RV Ft 1.510 2 070420101

7042LCD/RV-INT

belső üveg a 7042LCD, 7043 modellhez

7042LCD/RV-INT Ft 1.290 2 070420102

7043

LCD hegesztőpajzs automatikus sötétéddéssel, ívhegesztéshez; MIG/MAG, TIG és plazmahegesztéshez, napelemes tápegység

- látómező: 92x43 mm
- sötétéddési tartomány: DIN 9-13, külső beállítás
- UV/IR védelem
- sötétéddési idő: 1/1000 s
- világosodási idő: 0,1-1,0 mp
- állítható sötétéddés késleltetés
- automatikus be- és kikapcsolás
- köszörülés üzemmód
- az optimalizált kialakításnak köszönhetően könnyebb lélegezni leeresztett rostállyal



7043 Ft 39.800 1 070430001

1870

20 literes száraz-nedves porszívó

- egyfokozatú by-pass motor
 - feszültség 220/240 V
 - frekvencia 50/60 Hz
 - legnagyobb teljesítmény 1200 W
 - levegőszállítás l/mp. 58
 - legnagyobb nyomáscsökkenés 190 mbár
 - legnagyobb antistatikus PP tartálykapacitás 20 l
 - zajkibocsátás <70 dB(A)
 - kábelhossz 5 m
 - tartozékartó kocsis
 - Ø 36 mm TARTOZÉKOK
 - 1 flexibilis cső ergonomikus markolattal
 - 2 merev hosszabbító cső
 - 1 többfunkciós kefe padlóhoz és folyadékhoz
 - 1 rés szívófej
- SZÜRŐRENDSZEREK
- 1 felületi levegőszűrő betét 1900 cm² - 12 mikron névl.
 - 1 habvédő szűrő PPI 45/PPI 30

CE



IPX4

1870 Ft 88.350 1 018700020

1870I

20 literes száraz-nedves porszívó rozsdamentes acél tartály

- egyfokozatú by-pass motor
 - tápfeszültség: 220/240 V
 - frekvencia: 50/60 Hz
 - legnagyobb teljesítmény: 1200 W
 - szállított levegő mennyiség: 58 l/mp
 - legnagyobb szívónyomás: 190 mbar
 - max. tartálykapacitás: 20 liter, rozsdamentes acélból
 - zajkibocsátás: <70 dB(A)
 - Kábelhossz: 5 m
 - SZABVÁNY TARTOZÉKOK Ø 36 mm
 - 1 flexibilis gégecső ergonomikus markolattal és levegőszabályozóval
 - 2 merev hosszabbító cső
 - 1 1 többfunkciós kefe padlóhoz és folyadékhoz
 - 1 rés szívófej
 - 1 papírszak
- SZÜRŐRENDSZEREK
- 1 felületi levegőszűrő betét 1900 cm² - 12 mikron névl.
 - 1 habvédő szűrő PPI 45/PPI 30

CE



IPX4

1870I Ft 89.000 1 018700220

1872L

35 literes száraz-nedves porszívó "L" osztályú minősítés

- kétfokozatú by-pass motor
 - feszültség 220/240 V
 - frekvencia 50/60 Hz
 - legnagyobb teljesítmény 1100 W
 - levegőszállítás l/mp. 55
 - legnagyobb vákuum 220 mbár
 - az antistatikus PE-HD anyagú tartály térfogata 35 l
 - zajkibocsátás <70 dB(A)
 - vezetékossz 6 m
 - Ø 36 mm TARTOZÉKOK
 - 1 flexibilis cső ergonomikus markolattal
 - 2 műanyag hosszabbító cső
 - 1 kombinált kefe váz
 - 1 folyadékgyűjtő gumis betét
 - 1 nyeles szívófej
- SZÜRŐRENDSZEREK
- 1 nemszőtt szövet szűrőzsák, "L" szűrési osztály
 - 1 szűrőbetét "L" osztályú IFA minősítéssel
 - 1 habvédő szűrő PPI 45/PPI 30
 - 2 PP PET csatlót utószűrő

CE



IPX4

1872L Ft 194.200 1 018720135

1873

30 literes száraz-nedves porszívó, ROZSDAMENTES acél tartállyal

- kétfokozatú by-pass motor • feszültség 220/240 V
 - frekvencia 50/60 Hz • legnagyobb teljesítmény 1100 W
 - levegőszállítás l/mp. 55
 - legnagyobb nyomáscsökkenés 220 mbár
 - legnagyobb rozsdamentes acél tartálykapacitás 30 l
 - zajkibocsátás <61 dB(A) • kábelhossz 6 m
 - tartozékartó kocsis
 - Ø 45 mm TARTOZÉKOK
 - 1 flexibilis cső ergonomikus markolattal
 - 2 rozsdamentes acél hosszabbító cső
 - 1 ipari kefe váz • 1 ipari szőnyegpadló szívóbetét
 - 1 ipari folyadékgyűjtő gumis betét
 - 1 rés szívófej
- SZÜRŐRENDSZEREK
- 1 papír szűrőzsák
 - 1 felületi levegőszűrő betét 1900 cm² 12 mikron névl.
 - 1 habvédő szűrő PPI 45/PPI 30

CE



1873 30 Ft 258.400 1 018730030

1874

50 literes száraz-nedves porszívó,
ROZSDAMENTES acél tartállyal

- kétfokozatú by-pass motor • feszültség 220/240 V
 - frekvencia 50/60 Hz • legnagyobb teljesítmény 1350 W
 - levegőszállítás l/mp. 55
 - legnagyobb nyomáscsökkenés 240 mbár
 - legnagyobb rozsdamentes acél tartálykapacitás 50 l
 - zajkibocsátás <63 dB(A)
 - kábelhossz 6 m • tartozékartó kocsi
 - Ø 45 mm TARZOZEKOK
 - 1 flexibilis cső ergonomikus markolattal
 - 2 rozsdamentes acél hosszabbító cső
 - 1 ipari kefe váz • 1 ipari szőnyegpadló szívóbetét
 - 1 ipari folyadékgyűjtő gumis betét
 - 1 rés szívófej
- SZŰRŐRENDSZEREK
- 1 papír szűrőzsák
 - 1 felületi levegőszűrő betét 5200 cm² 12 mikron névl.
 - 1 habvédő szűrő PPI 45/PPI 30

CE



1874 50 Ft 328.000 1 018740050

1875LT

vizes takarítógép szőnyeghez/kárpithoz

Ideális textil felületek mélytisztításához.
A nagynyomású mosószeres vizet a szennyeződéssel együtt visszaszívja, így a felület szinte teljesen száraz marad.

Kiegészítők:

- 1 tömlő ergonomikus fogantyúval
- 1 adagolóegység
- 2 merev cső
- 1 kis fúvóka
- 1 nagy fúvóka
- 6 méteres hálózati kábel, reteszelővel

CE



1875LT Ft 250.400 1 018750000

1875SP/K3

kárpittisztító kefe készlet

- 1 lapos kefe Ø 48 mm
- 1 lapos kefe Ø 100 mm
- 1 félgömb alakú kefe Ø 90 mm
- 1/4" gépi dugókulcs

1/4



ISO 1173 E 6,3

1875SP/K3 Ft 8.060 1 018750010

1870-20/5S

5 vízszintes papírzsák az 1870-
1875LT modellhez



1870 20/5S Ft 20.700 1 018700021

1870-72 /FC

szűrőbetét, 1900 cm² névl. 12 mikron, az 1870
- 1870I - 1873 - 1875LT modellhez



1870-72 /FC Ft 17.700 1 018700026

1870-72/FL

folyadékiszívó szűrő
az 1870 - 1870I - 1872L - 1873 - 1874 -
1875LT modellekhez



1870 72/FL Ft 6.340 1 018700027

1872L 35/FC

szűrőbetét, "L" osztály
a 1872L 35 készülékhez



1872L 35/FC Ft 22.500 1 018720144

1872L 35/5S

5 nemszőtt szövet szűrőzsák, "L" szűrési
osztály



1872L 35/5S Ft 33.800 1 018720136

1873-30/5S

5 függőleges papírzsák az 1873 modellhez



1873 30/5S Ft 21.250 1 018730031

1874-50/5S

5 függőleges az 1874 modellhez



1874 50/5S Ft 26.600 1 018740051

1874-50/FC

szűrőbetét, 5200 cm² névl. 12 mikron, az 1874
modellhez



1874 50/FC Ft 21.950 1 018740056

1877

kocsis fáradtolaj gyűjtő
90 literes tartállyal

- szintjelző
- nagy átmérőjű teknő szűrőcsepegtető ráccsal, úrtartalom 12 l
- pneumatikus tartályürítés 1,8 m hosszú csővel
- szerszámtartó tál

CE



1877 Ft 291.400 1 018770008

Beta

1877A

kocsis fáradtolaj gyűjtő/elszívó,
90 literes tartállyal és előkamrával

- szintjelző
- nagy átmérőjű teknő szűrőcepegető ráccsal, űrtartalom 12 l
- átlátszó előkamra, űrtartalom 9,5 l
- szívócső hossza 1,8 m
- pneumatikus tartályürítés 1,8 m hosszú csővel
- szerszámtartó tál

A következő tartozékokkal szállítva:

- 1 merev szonda Ø 5x700 mm
- 1 flexibilis szonda Ø 5x700 mm
- 1 merev szonda Ø 6x600 mm
- 1 flexibilis szonda Ø 6x700 mm
- 1 merev szonda Ø 7x700 mm
- 1 flexibilis szonda Ø 8x700 mm
- VW, BMW, CITROËN adapterek

CE



1877A Ft 509.200 1 018770080

1877F

fáradtolaj gyűjtő
1 literes palackokhoz

- egyszerre 4 palackhoz
- 2 db 2 literes marmonkannával szállítva



H mm 405 L mm 270 P mm 240 Ft 42.450 1 018770100

JÁRMŰJAVÍTÁS

Járműjavító szerszámainkat, amelyeket a legigényesebb szakemberek használnak, a világ legmagasabb követelményeinek megfelelően fejlesztettük és gyártottuk, és rendszeresen teszteljük a legnagyobb terhelést jelentő üzemi körülmények között.

Több mint 50 éve büszkén dolgozunk együtt a legnagyobbakkal, akik segítenek termékeink folyamatos fejlesztésében és biztosítják a legmagasabb minőségi színvonalnak való megfelelést.

A járműjavító eszközök az alábbi szakaszokban találhatóak:

DIAGNOSZTIKA	1438 - 1499 1758VT - 1760TMC
MOTOR	955 - 989A 1438 - 1499
OLAJ ÉS SZŰRŐK	1438 - 1499 1877 - 1885
ELEKTROMOS RENDSZER	1438 - 1499
GYORSINDÍTÓK	1498BC/12 - 1498/40A
ERŐÁTVITEL	1438 - 1499
FELFÜGGESZTÉS	1549 - 1569CP
FÉKEK	1438 - 1499
KEREKEK	955 - 989A
KAROSSZÉRIA	1302 - 1369 1763 - 1767A
EGYÉB BERENDEZÉSEK	1878 - 3067
EMELÉSTECHNIKA	3029/2T - 3067/70-13T



1878 2

folyadékgyűjtő tartály

- Maximális űrtartalom: 2 l
- Különösen alkalmas
- robogók olajcseréjéhez



1878 2 l 2 H mm 85 Ft 6.290 1 018780002

1878 3

olajgyűjtő tartály
teherautó kerékagyhoz
cseppmentes olajleeresztés



1878 3 l 3 Ft 8.210 1 018780003

1878 4

folyadékgyűjtő tartály,
hordozható

- motorkerékpárokhoz alkalmazható
- maximális űrtartalom: 4 l
- fröccsenésgátló



1878 4 l 4 H mm 100 Ft 13.800 1 018780004

1878 8

folyadékgyűjtő tartály

- motorkerékpárokhoz alkalmazható magasság
- maximális űrtartalom: 8 l



1878 8 l 8 H mm 110 Ft 7.070 1 018780008

1878 11

Folyadékgyűjtő tartály

- Max. űrtartalom 11 l
- Folyadékleeresztő csavar
- A belső fal megakadályozza a folyadék kicsapódását szállítás közben



1878 11	11	Ft	14.250	1	018780011
---------	----	----	--------	---	-----------

1878 30

Folyadéktartály

- Maximális űrtartalom: 30 l
- Fröccsenésgátló
- 4 guruló görgő

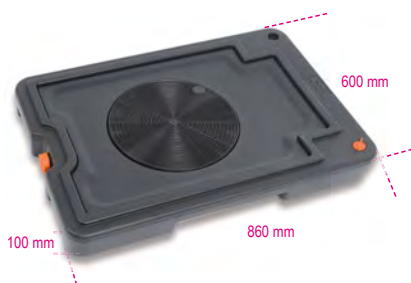

1878 30	30	Ft	55.700	1	018780030
---------	----	----	--------	---	-----------

1879

Kézi és pneumatikus folyadékelszívó, 9,5 l



1879		Ft	121.500	1	018790001
------	--	----	---------	---	-----------

1879 6

kézi folyadékleszívó,
6 l



1879 6		Ft	109.900	1	018790000
--------	--	----	---------	---	-----------

1879R/K4

4 pöttyéből álló készlet az 1879
folyadékelszívóhoz



1879R/K4		Ft	23.150	1	018790504
----------	--	----	--------	---	-----------

1879/FUEL

kézi folyadékleszívó,
6 l
szénhidrogénekhez



1879/FUEL	6	Ft	54.050	1	018790010
-----------	---	----	--------	---	-----------

1880

karos hordópumpa

- olajhoz
- nem használható vízbázisú folyadékokhoz, savakhoz, dízelolajhoz, benzinhoz és hasonló folyadékokhoz
- tartozék: hordócsatlakozó, teleszkópos szívószár és kifolyó
- 60, 100 és 200 literes hordóhoz



1880	gr	240	Ft	22.400	1	018800001
------	----	-----	----	--------	---	-----------

1880ADB

forgódugattyús AdBlue® szivattyú

- 20 fordulatonként 5 liter átmenés
- hordó bővítők 1,20 méterig
- 1 db finom menetes hordó csatlakozó, finom menetes
- 1 nagy menetemelkedésű hordó csatlakozó



1880ADB		Ft	70.850	1	018800101
---------	--	----	--------	---	-----------

1881

Pneumatikus pumpa 3:1

CE



1881	l/min	18	Ft	201.000	1	018810001
------	-------	----	----	---------	---	-----------

1882

Olajozó pisztoly flexibilis kifolyóval és
csepegésgátlóval

- 1/2"-os csatlakozó
- Max. átfolyás 65 l/perc
- Max. üzemi nyomás 100 bar
- Blokkoló szerkezet



1882		Ft	60.200	1	018820010
------	--	----	--------	---	-----------

1883

Digitális olajátfolyószámoló

- 1/2"-os csatlakozó
- Útés ellen védő gumi
- 1 CR2 elemmel szállítva
- Max. teljesítmény: 0÷35 l/perc (0÷9 gal/perc)
- Max. nyomás: 50 bar (750 psi)
- Viskozitás: 8÷5000 mPas
- Pontosság: ±0,5%

CE



1883		Ft	88.900	1	018830035
------	--	----	--------	---	-----------

1883NC

Adepter, külső menet 1/2"
1882 és 1883 modellhez



1883NC		Ft	5.370	1	018830135
--------	--	----	-------	---	-----------

1884

Olajfeltöltő berendezés kézi és automatikus sebességváltóhoz és differenciálműhöz

Komplett 12 adapterrel a direkt csatlakoztatáshoz



1884 Ft 193.000 1 018840010

AT-101	FORD
AT-102	UNIVERSAL (Bmw, Honda, Nissan...)
AT-103	VW-AUDI
AT-104	VW-AUDI-PORSCHE
AT-105	VW-AUDI-MINI COOPER
AT-106	MERCEDES
AT-107	DSG
AT-108	VW-AUDI CVT
AT-109	VOLVO
AT-110	TOYOTA-LEXUS
AT-111	SKODA
AT-112	VW Passat/Tiguan <2007

1884/C12

adapter táska az 1884 berendezéshez



1884/C12 Ft 71.250 1 018840100

1884N/C8

8 darabos adapterkészlet az 1884 berendezéshez

készlet tartalma:

- 1 adapter - Infiniti, 7-sebesség, M8x1.0
- 1 adapter - Honda, Hyundai, Kia 5x8x200 mm
- 1 adapter - Skoda M18x1.5
- 1 adapter - Mini M14x1.5
- 1 adapter - Nissan M10x1.5
- 1 adapter - Nissan Juke M12x1.25
- 1 adapter - GM M12x1.75
- 1 adapter - VAG csoport, 7-sebesség



1884N/C8 Ft 48.750 1 018840200

200x145x40 mm - 400 g

1889

Acél hordótartó
2 db 200 literes hordó szállítására és raktározására

- Epoxypulverrel melegen lakkozva
- Könnyen szállítható emelővillás targoncával vagy raklap emelő targoncával
- Nem rakható egymásra



1889 Ft 328.100 1 018890200

1889CF

univerzális kulcs hordók nyításához

- 1 belső hatszög Ø 38 mm
- 1 profil 4 szegmenses Ø 42 mm
- 1 penge 17x7 mm



L 270 mm Ft 14.000 1 018890010

1885

automata sebességváltó karbantartó állomás

Az egyszerű, irányított eljárásnak köszönhetően minden fajta automata sebességváltó teljes mosási ciklusa biztonságosan elvégezhető.

Megakadályozza az automata sebességváltó váltóolajának előregedését eredő károsodását, így könnyen és gyorsan megelőzhető a jellemző meghibásodások, például: zajos váltó, besülő fogaskerekek, hirtelen kapcsolt fogaskerekek, hosszú váltási idő.



CE



FUNKCIONÁLIS SPECIFIKÁCIÓK

Automata üzemmód
Lépésenként követhető eljárás integrált adatbázissal
A befecskendezett olaj és kiengedett olaj mennyiségi kiegyenlítésével biztosítja, hogy a rendszerben mindig azonos mennyiségű olaj legyen
Áramlásmérő az olajmennyiség vizuális nyomkövetéséhez
Minden műveletről nyomtatható rekord

AUTOMATIKUS SPECIFIKÁCIÓK

Oldószert befecskendezés (opcionális)
Sebességváltó rendszer átmosása
Olaj leeresztés az olajteknőből
Olaj leürítése a nyomtatkékváltóból
Olaj befecskendezése a nyomtatkékváltóba

MŰSZAKI ADATOK

Tápellátás: 220V - 50 Hz
Hátsó megvilágítású olajvizsgáló 2 fehér fényű LED-del
2 digitális mérleg
Digitális mérleg, lépték +/- 10 g
Elektronikus kártya háttérvilágítású grafikus kijelzővel

1885 Ft 3.886.800 1 018850010

 Beta

 Beta

1885/C1

automata sebességváltó alkatrész készlet a 1885 modellhez

Készlet tartalma:

- 1885/C1-R1 Land Rover Freelander sebességváltó alkatrészek
- 1885/C1-R2 DP0 sebességváltó alkatrész
- 1885/C1-R3 ZF 9HP sebességváltó alkatrész
- 1885/C1-R4 ZF 9HP sebességváltó nivópálca
- 1885/C1-R5 Mercedes sebességváltó nivópálca
- 1885/C1-R6 AISIN TG82 sebességváltó alkatrészek
- 1885/C1-R7 AISIN TG81 sebességváltó alkatrészek
- 1885/C1-R8 Renault-Nissan sebességváltó alkatrészek



1885/C1 Ft 338.700 1 018850110

1885/C1-R1

Land Rover Freelander sebességváltó alkatrészek a 1885 modellhez
lc01430



1885/C1-R1 Ft 30.150 1 018850111

1885/C1-R2

DP0 sebességváltó alkatrész a 1885 modellhez
lc0990



1885/C1-R2 Ft 51.500 1 018850112

1885/C1-R3

ZF 9HP sebességváltó alkatrész a 1885 modellhez
lc0992



1885/C1-R3 Ft 57.500 1 018850113

1885/C1-R4

ZF 9HP sebességváltó nivópálca a 1885 modellhez
lc0192



1885/C1-R4 Ft 32.200 1 018850114

1885/C1-R5

Mercedes sebességváltó nivópálca a 1885 modellhez
K-A-M



1885/C1-R5 Ft 53.900 1 018850115

1885/C1-R6

AISIN TG82 sebességváltó alkatrészek a 1885 modellhez
lc01820



1885/C1-R6 Ft 57.550 1 018850116

1885/C1-R7

AISIN TG81 sebességváltó alkatrészek a 1885 modellhez
lc0150



1885/C1-R7 Ft 57.550 1 018850117

1885/C1-R8

Renault-Nissan sebességváltó alkatrészek a 1885 modellhez
lc02150



1885/C1-R8 Ft 57.550 1 018850118

1885/C2

automata sebességváltó alkatrész készlet a 1885 modellhez

Készlet tartalma:

- 1885/C2-R1 Audi 8HP sebességváltó alkatrészek
- 1885/C2-R2 ZF 9HP sebességváltó alkatrészek hőcserélő nélkül
- 1885/C2-R3 Audi 0KC sebességváltó alkatrész
- 1885/C2-R4 AG4-ZF 4HP sebességváltó alkatrészek
- 1885/C2-R5 FIAT sebességváltó alkatrészek
- 1885/C2-R6 Audi Q5-Q7 sebességváltó alkatrészek
- 1885/C2-R7 Audi 0B5 sebességváltó alkatrész



1885/C2 Ft 276.000 1 018850120

1885/C2-R1

Audi 8HP sebességváltó alkatrészek a 1885 modellhez
lc0993



1885/C2-R1 Ft 55.550 1 018850121

1885/C2-R2

ZF 9HP sebességváltó alkatrész hőcserélő nélkül a 1885 modellhez
lc0860



1885/C2-R2 Ft 36.350 1 018850122

1885/C2-R3

Audi 0KC sebességváltó alkatrész a 1885 modellhez
lc02020



1885/C2-R3 Ft 57.550 1 018850123

1885/C2-R4

AG4-ZF 4HP sebességváltó alkatrészek a 1885 modellhez
lc0750



1885/C2-R4 Ft 48.900 1 018850124

1885/C2-R5

FIAT sebességváltó alkatrészek a 1885 modellhez
lc0061



1885/C2-R5 Ft 21.500 1 018850125

1885/C2-R6

Audi Q5-Q7 sebességváltó alkatrészek a 1885 modellhez
lc0680



1885/C2-R6 Ft 53.900 1 018850126

1885/C2-R7

Audi 0B5 sebességváltó alkatrész a 1885 modellhez
lc01720



1885/C2-R7 Ft 32.200 1 018850127

1885/C3

automata sebességváltó alkatrész készlet a 1885 modellhez

Készlet tartalma:

- 1885/C3-R1 Mercedes DSG sebességváltó alkatrész
- 1885/C3-R2 POWERSHIFT sebességváltó alkatrész
- 1885/C3-R3 Toyota IQ sebességváltó alkatrészek
- 1885/C3-R4 Mazda sebességváltó alkatrészek
- 1885/C3-R5 Renault Laguna-Esp sebességváltó alkatrészek
- 1885/C3-R6 Nissan Juke sebességváltó alkatrészek
- 1885/C3-R7 AISIN TF71 FV sebességváltó alkatrészek
- 1885/C3-R8 AISIN TF71 FP sebességváltó alkatrészek
- 1885/C3-R9 AISIN TF71 FO sebességváltó alkatrészek
- 1885/C3-R10 AISIN TF71 FS sebességváltó alkatrészek



1885/C3 Ft 486.700 1 018850130

1885/C3-R1

lc0191



1885/C3-R1 Ft 57.550 1 018850131

1885/C3-R2

POWERSHIFT sebességváltó alkatrész a 1885 modellhez
lc0190



1885/C3-R2 Ft 57.550 1 018850132

1885/C3-R3

Toyota IQ sebességváltó alkatrészek a 1885 modellhez
lc0991



1885/C3-R3 Ft 57.550 1 018850133

1885/C3-R4

Mazda sebességváltó alkatrészek a 1885 modellhez



1885/C3-R4 Ft 57.550 1 018850134

1885/C3-R5

Renault Laguna-Esp sebességváltó alkatrészek a 1885 modellhez



1885/C3-R5 Ft 57.550 1 018850135

1885/C3-R6

Nissan Juke sebességváltó alkatrészek a 1885 modellhez
lc02140



1885/C3-R6 Ft 57.550 1 018850136

1885/C3-R7

AISIN TF71 FV sebességváltó alkatrészek a 1885 modellhez
lc01420



1885/C3-R7 Ft 57.550 1 018850137

1885/C3-R8

AISIN TF71 FP sebességváltó alkatrészek a 1885 modellhez
lc001420/1



1885/C3-R8 Ft 57.550 1 018850138

1885/C3-R9

AISIN TF71 FO sebességváltó alkatrészek a 1885 modellhez
lc001420/2



1885/C3-R9 Ft 57.550 1 018850139

1885/C3-R10

AISIN TF71 FS sebességváltó alkatrészek a 1885 modellhez
lc001420/3



1885/C3-R10 Ft 57.550 1 018850140

1885/XC60

Volvo XC60 sebességváltó kiegészítők a 1885 modellhez



1885/XC60 Ft 58.050 1 018850151

1893/134A

automata töltőállomás R134a hűtőközeggel működő légkondicionáló berendezésekhez

Teljesen automatikus modell, gázmennyiségeket tartalmazó személy- és tehergépjármű adatbázissal, kompresszor olaj mennyiségekkel és típusokkal, öndiagnosztizáló szoftver a rutin karbantartási feladatokhoz.

Az adatbázis a szoftveren keresztül frissíthető.

A berendezés mind manuális és teljesen automatikus üzemmódban is üzemeltethető (az első esetben a kezelőnek kell az egyes lépéseket végrehajtani, míg az utóbbi esetben nincs szükség kezelőre).



CE



R134A (250 ml)

FUNKCIONÁLIS SPECIFIKÁCIÓK

Automata üzemmód

Személy- és tehergépjármű lista hűtőközeg mennyiségekkel,

illetve kompresszor olaj mennyiségekkel és típusokkal

A csőben lévő hűtőközeg automatikus visszanyerése

A csővezetékben az újratöltött hűtőközeg mennyiség kompenzálása

A nem kondenzálható hűtőközeg automatikus leürítése

Meghibásodások és szükséges karbantartások automatikus jelentése

Méret ø 80 mm

Digitális vákuummérő

MŰSZAKI ADATOK

Gáztartály: 15 kg

Vákuumszivattyú: 75 l/perc

Digitális mérleg: 50 kg

Elektronikus kártya háttérvilágítású kijelzővel

Kinyerési sebesség: 500 fordulat/perc

Tápellátás: 220 V

1893/134A Ft 2.861.000 1 018930001

1893/1234YF

automata töltőállomás R1234yf hűtőközeggel működő légkondicionáló berendezésekhez

Teljesen automatikus modell, gázmennyiségeket tartalmazó személy- és tehergépjármű adatbázissal, kompresszor olaj mennyiségekkel és típusokkal, öndiagnosztizáló szoftver a rutin karbantartási feladatokhoz. Az adatbázis a szoftveren keresztül frissíthető. A berendezés mind manuális és teljesen automatikus üzemmódban is üzemeltethető (az első esetben a kezelőnek kell az egyes lépéseket végrehajtani, míg az utóbbi esetben nincs szükség kezelőre).



1234YF (250 ml)

FUNKCIONÁLIS SPECIFIKÁCIÓS

Automata üzemmód
Személy- és tehergépjármű lista hűtőközeg mennyiségekkel, illetve kompresszor olaj mennyiségekkel és típusokkal
A csőben lévő hűtőközeg automatikus visszanyerése
A csövekben az újratöltött hűtőközeg mennyiség kompenzálása
A nem kondenzálható hűtőközeg automatikus leürítése
Meghibásodások és szükséges karbantartások automatikus jelentése
Méret \varnothing 80 mm
Digitális vákuummérő

MŰSZAKI ADATOK

Gáztartály: 15 kg
Vákuumszivattyú: 75 l/perc
Digitális mérleg: 50 kg
Elektronikus kártya háttérvilágítású kijelzővel
Kinyerési sebesség: 500 fordulat/perc
Tápellátás: 220 V

1893/1234YF Ft 2.960.900 1 018930012

1893TR/134A

R134a gáz szivárgáskereső



1893TR/134A ml 250 Ft 20.700 1 018930901

1893TR/1234YF

R1234yf gáz szivárgáskereső



1893TR/1234YF ml 250 Ft 23.300 1 018930902

1893TR/CI

hibrid kompresszor jelölő folyadék



1893TR/CI ml 250 Ft 23.750 1 018930903

1895G

vezérlőjel generátor elektronikus befecskendezéshez (benzines és LPG üzemű) elektronikus injektorokhoz és szolenoid szelepekhez

A következő komponensek hatáskörének önálló ellenőrzését teszi lehetővé:
- EGR szolenoid szelepek
- benzines és LPG üzemű motorok elektronikus injektorai
- változtatható geometriájú turbinák szolenoid szelepei
- új generációs légkondicionáló berendezések kompresszorai



ELŐNYÖK

- Lehetővé teszi, hogy a komponens mechanikus működésének ellenőrzését
- Az ultrahangos mosóberendezésekkel együtt biztosítja az alkatrészek hatékonyabb tisztítását, elektronikusan felügyelve a mosófázist
- Elengedhetetlen a légkondicionáló berendezések, így a kompresszor és a vezérlőszelep hatékony működésének ellenőrzéséhez
MŰSZAKI JELLEMZŐK
Benzines és LPG üzemű injektor vezérlő:
- kimenetek száma: 4
- ellenőrzési idő: 1-60 mp
- Üzemidő: 5-10 ms
Impulzusfrekvencia tartomány: 1-10 Hz
PWM eszköz vezérlés:
- kimenetek száma: 1
- ellenőrzési idő: 1-60 perc
- Automatikus vagy manuális
- Munkaciklus beállítás: 10%-85%
- Jelfrekvencia beállítás: 120-250 Hz
4 FASTON mama csatlakozót tartalmaz
Tápellátás: 110-220 V
Méret: 334x240x74 mm
Súly: 4 kg

1895G Ft 878.800 1 018950800

1895/S

1895 típusú ultrahangos mosóberendezéshez való állítható tartó

Segíti az injektorok megfelelő elhelyezését az ultrahangos mosóberendezésben

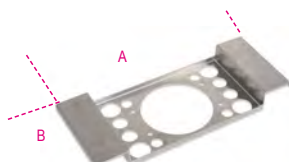

1895/S A mm 340 B mm 140 Ft 52.350 1 018950501

1895 6

ultrahangos mosótál, 6 literes

speciális gáztalanító funkcióval



- a folyadék fűtésével és az ultrahang alkalmazásával lehetővé teszi az alkatrészek, és általában a fém munkadarabok hatékony tisztítását (befecskendezők, karburátorok, szelepek, stb.)
- digitális kijelző a mosási hőmérséklet és idő beállításával
- kettős mosófunkció: "soft" és "normal"
- egy általános tisztításhoz elég 50/60°C hőmérsékletű víz használata
- egy alaposabb tisztítás érdekében adjon hozzá kifejezetten ultrahangos tálakhoz ajánlott habzásmentes mosóoldatot
- a gáztalanító funkció meggyorsítja a levegő eltávolítását a mosótál teljes térfogatán belül, növelve ezzel az ultrahang hatékonyságát

MŰSZAKI ADATOK

Mosótál térfogat: 6 liter
Úritő csap
Teljesítmény: 150 Watt
Fűtésteljesítmény: 300 Watt
Hőmérséklet szabályozás: 0+80 °C
Mosási idő szabályozás: 0-99 perc
Frekvencia: 40 kHz
Tápfeszültség: 220/230 V
Teljes méret: 530x330x380 mm
Tál mérete: 300x155x150 mm
Kosár mérete: 250x105x100 mm
Max. teherbírás: 5,5 kg

1895 6 Max 5,5 Ft 284.400 1 018950060

1895 13

ultrahangos mosótál, 13 literes

speciális gáztalanító funkcióval



- a folyadék fűtésével és az ultrahang alkalmazásával lehetővé teszi az alkatrészek, és általában a fém munkadarabok hatékony tisztítását (befecskendezők, karburátorok, szelepek, stb.)
- digitális kijelző a mosási hőmérséklet és idő beállításával
- kettős mosófunkció: "soft" és "normal"
- egy általános tisztításhoz elég 50/60°C hőmérsékletű víz használata
- egy alaposabb tisztítás érdekében adjon hozzá kifejezetten ultrahangos tálakhoz ajánlott habzásmentes mosóoldatot
- a gáztalanító funkció meggyorsítja a levegő eltávolítását a mosótál teljes térfogatán belül, növelve ezzel az ultrahang hatékonyságát

MŰSZAKI ADATOK

Mosótál térfogat: 13 liter
Úritő csap
Teljesítmény: 300 Watt
Fűtésteljesítmény: 400 Watt
Hőmérséklet szabályozás: 0+80 °C
Mosási idő szabályozás: 0-99 perc
Frekvencia: 40 kHz
Tápfeszültség: 220/230 V
Teljes méret: 350x325x320 mm
Tál mérete: 325x235x145 mm
Kosár mérete: 257x185x100 mm
Max. teherbírás: 12 kg

1895 13 Max 12 Ft 454.700 1 018950130

1895/27

ultrahangos mosótál
27 literes

speciális gázáltalító funkcióval



CE

- a folyadék fűtésével és az ultrahang alkalmazásával lehetővé teszi az alkatrészek, és általában a fém munkadarabok hatékony tisztítását (befecskendezők, karburátorok, szelepek, stb...)
- digitális kijelző a mosási hőmérséklet és idő beállításával
- kettős mosófunkció: "soft" és "normál"
- egy általános tisztításhoz elég 50/60°C hőmérsékletű víz használata
- egy alaposabb tisztítás érdekében adjon hozzá egyedi, ultrahangos tálakhoz ajánlott habzásmentes mosóoldatot
- a gázáltalító funkció meggyorsítja a levegő eltávolítását a mosótál teljes térfogatán belül, növelve ezzel az ultrahang hatékonyságát

MŰSZAKI ADATOK

Mosótál térfogat: 27 liter

Úritó csap

Teljesítmény: 500 Watt

Fűtésteljesítmény: 500 Watt

Hőmérséklet szabályozás: 0+80°C

Mosási idő szabályozás: 0-99 perc

Frekvencia: 40 kHz

Tápfeszültség: 220/230 V

Méret: 530x330x380 mm

1895/27	Max 25	Ft 639.800	1	018950270
---------	--------	------------	---	-----------

1895/RC

tartókeret 1895 típusú ultrahangos mosóberendezéshez



	L mm	L1 mm	A mm	Ft		
1895/RC6	250	105	100	19.800	1	018950506
1895/RC13	257	185	100	31.600	1	018950513
1895/RC27	450	250	150	51.450	1	018950527

9881U



9881U 1 (1-2)	526
9881U 1 (3)	526

9882R



9882R 1 (1-2)	526
9882R 1 (3)	526

1897

professzionális asztali szemcseszűrő

Kifejezetten ajánlott különböző (fém, műanyag, üveg, kerámia, fa, stb.) felületek megmunkálásához A megerősített acéllemezből készült fülke egyedülállóan stabil és robusztus.

A fülke tulajdonságai:

- mágneszáras ajtó
- perforált fémlémez lap
- szabvány porszívócsatlakozó, ø 36 mm
- polikarbonát betekintőablak, 6 mm
- LED lámpa
- pneumatikus kör (sűrített levegő csatlakozó)
- ravasszal működtethető homokszűrő pisztoly



CE

MŰSZAKI ADATOK

Fülke hasznos mérete: 600x520x320 mm

Külső méret: 660x530x500 mm

Súly: 38 kg

Munkalap: perforált fémlémez

Világítás: LED

Levegőfelhasználás: 340 l/perc 7 atmoszférán

Tápellátás: 220 V - 50 Hz

1897	Ft 1.746.700	1	018970066
------	--------------	---	-----------

1897/CRB

korund az 1897 típusú szemcseszűrőhöz, 25 kg zsák



1897/CRB	Ft 88.200	1	018970101
----------	-----------	---	-----------

1897/G

gránáthomok az 1897 típusú szemcseszűrőhöz, 25 kg zsák



1897/G	Ft 70.900	1	018970104
--------	-----------	---	-----------

1897/MV

üveg mikrogömb az 1897 típusú szemcseszűrőhöz, 25 kg zsák



1897/MV	Ft 116.300	1	018970103
---------	------------	---	-----------

1898/K40

kézi alkatrészmosó mechanikus alkatrészek tisztításához, fertőtlenítéséhez, melegített folyadék cirkulálásával

- megtakarítható az oldószerek és szénhidrogének ártalmatlanítási költsége
- a Beta enzim- és baktériumalapú ökológiai tisztítószere eltávolítja az olajmaradékot a mechanikus alkatrészekből
- az enzimatis folyamat elősegíti az olajos rész és koszos szilárd rész szétválasztását; a baktériumok szén-dioxidja és vízze bontja, így regenerálva a tisztítószert



CE

BERENDEZÉS:

- hosszúsórtéjű ecset és csatlakozó cső
- jobb és bal kézzel üzemeltethető
- perforált rozsdamentes acél rács
- fékezhető kerek
- üzemi hőmérséklet kijelzés és alacsony szint figyelmeztetés

EGYÜTT SZÁLLÍTOTT TARTOZÉKOK:

- 2 kanna 20 literes környezetbarát folyékony tisztítószer és 2 csomag baktérium

MŰSZAKI ADATOK

- Max. szivattyú kapacitás: 10 l/perc

- Tartálykapacitás: 40 l

- Üzemi hőmérséklet: +5 °C ÷ +40 °C

- Méretek: 900 x 1000 x 750 mm

- Súly: 50 kg (üresen)

1898/K40	Ft 1.514.600	1	018980004
----------	--------------	---	-----------

FIGYELEM!

A 1898/K40 termék a következő országokban forgalmazható: Ausztria, Belgium, Franciaország (2021-től), Magyarország, Olaszország, Hollandia, Lengyelország, Portugália, Spanyolország, Egyesült Királyság.

1898/B

egy flakon baktérium, 400 ml az 1898/K40 alkatrészmosóhoz



1898/B	Ft 39.000	1	018980904
--------	-----------	---	-----------

FIGYELEM! Az 1898/B termék a következő országokban forgalmazható: Ausztria, Belgium, Egyesült Királyság, Franciaország, Hollandia, Lengyelország, Magyarország, Olaszország, Portugália, Spanyolország

1898/D

20 literes környezetbarát tisztítófolyadék az 1898/K40 alkatrészmosóhoz



1898/D Ft 77.350 1 018980920

FIGYELEM: Az 1898/D termék a következő országokban forgalmazható: Ausztria, Belgium, Egyesült Királyság, Franciaország, Hollandia, Lengyelország, Magyarország, Olaszország, Portugália, Spanyolország

1898/M

túlnyomásos permetező
2 literes tartállyal

- állítható fúvóka: egyenes sugár - ködpermetezés
- fokozatbeosztás (0,5 l - 1 l - 1,5 l - 2 l)
- egyenes sugárhoz záróbillentyű
- szénhidrogénnel nem használható



H mm 340 l 2 Ft 6.710 1 018980930

1898/S

kézi permetező
5 literes tartállyal

- rozsdamentes acél fúvóka
- egyenes sugárhoz záróbillentyű
- állítható fúvóka: egyenes sugár - ködpermetezés
- vállpánt a könnyű szállításhoz
- fúvóka beakasztó
- 1,2 méteres tömlő
- szénhidrogénnel nem használható



H mm 415 l 5 Ft 11.600 1 018980932

1899A

DPF/FAP® rendszer tisztító berendezés

A korom- és hamulerakódás miatt károsodott DPF és FAP® rendszerek időszakos tisztítására és regenerálására szolgáló speciális mosószer



Tartozékok:

- 1 db 2 méteres adagolócső
- 1 db gyorscsatlakozó + fúvóka a nyomásérzékelőhöz
- 1 db menetes csatlakozó (M18x1,5) tömlős fúvóka a lambda szonda közvetlen csatlakoztatásához
- 1 hosszabbító tömlő
- 1 db DPF/FAP® fúvóka
- 1 db mágneses lándzsatarató
- 1 DPF/FAP® vezeték beállító kábellel, tömszelencés menetes csatlakozó (M14/16/18 mm) a lambda szondához
- Műszaki jellemzők:
- Üzemi feszültség: 12 V
- tápkábel hossza: 3,9 m
- tartálykapacitás: 1 l

1899A Ft 459.600 1 018990010

1899SI

2-in-1 injektor és szívócsonk tisztító berendezés

a gázolaj- és benzinüzemű motorok befecskendezőinek és szívócsonkjának időszakos tisztításához használt speciális mosószerekkel eltávolítható a lerakódott szén és égéstermék



Jellemzők:

- Üzemi feszültség: 12V
- 2 db tömlő gyorscsatlakozóval
- 2 tartály (kapacitás: 1 l/tartály)

1899SI Ft 1.642.100 1 018990030

2080/VG

ABS szerszámtáska kifordítható tálcákkal

- Felső rendszerező kis alkatrészeknek (145 mm átmérőjű) és 4 kifordítható tálcával:
- 1 db 305 mm átmérőjű tálcával
- 3 db 445 mm átmérőjű tálcával
- A 3 nagyobb tálcához szállított 12 elválasztóval tálcánként maximum 8 rekesz hozható létre



2080/VG Ft 62.350 1 020800100

445x445x550 mm - 3,4 kg

2250-O

forgatható ülés tálcával



2250-O Ft 42.300 1 022500011

2252

Kerekos ülőke



2252-G Ft 73.100 1 022520002

2252KR4

Tartalékkerekek az ülőkéhez



2252KR4 Ft 24.200 1 022520900

Beta
Quality Tools

2258-0

ülés számszámkocsival



2258-0 Ft 75.350 1 022580011

2254A

autóponyva, kültéri használatra, víztaasztító és UV-álló

A ponyva megvédi a javításra váró sérült járművet

Műszaki jellemzők

- UV védelemmel ellátott külső
- puha, nem karcoló belső
- 6 zsinórral biztosítható a ponyva feszes felfekvése
- az első ajtóknál elhelyezett 2 cipzár megnyitásával a ponyva eltávolítása nélkül is be lehet szállni
- tükrözsebek
- tükröző



3 változatban kapható:

- az M méretet kompakt autókhoz ajánljuk
- az L méretet szedánokhoz és kombikhoz ajánljuk
- az XL méretet SUV-okhoz ajánljuk

	LxPxH mm	Ft		
/M	4400x1450 x1300	60.950	1	022540002
/L	5300x1450x1150	68.250	1	022540000
/XL	4700x1450x1580	62.300	1	022540001

2254C

tapadókorongos karosszéria védőpanel

lágított szövet, a felső részén 4 tapadókoronggal



2254C Ft 21.750 1 022540200

2254F

személyautó komplett első rész védőtakaró

Lehetővé teszi a jármű teljes elülső részének védelmét, meghagyva a fényszóró és a radiátor nyílásokat



- Vízhatlan
- Olaj és zsír álló
- Rögzítés zsinórok segítségével
- Anyaga: 98% poliamid/nylon, 2% poliuretán

2254F Ft 36.800 1 022540150

2254K

Újrafelhasználható ülés, kormány és sebességváltó gomb védőhuzat

A legtöbb jármű üléshez, kormányhoz és sebességváltó gombhoz használható



2254K Ft 11.900 1 022540101

2254SM

aláfekvő szivacs, EVA

Kettős kivitel:

- 1 oldal puha EVA
- 1 oldal kemény karbon a jobb csúszásért



2254SM Ft 30.300 1 022540033

2254T

térdvédő szőnyeg

Csúszásgátló EVA anyagból



2254T Ft 11.050 1 022540047

3000L

Aláfekvő ágy

- PVC és habosított gumibevonattal, magas komfort

Három állásban rögzíthető fejtámla



3000L Ft 71.450 1 030000210

3000L/RLS

Tartalékkezek az aláfekvő ágyhoz



3000L/RLS Ft 5.190 6 030000212

3002

Aláfekvő ágy és ülőke

- Acélváz
- Szivacsos párna PVC-bevonattal
- Gyors átalakítás: aláfekvő ágy vagy ülőke



3002 Ft 44.700 1 030020001

3002/RLS

6 pótkerék 3002 aláfekvő ágyhoz



3002/RLS Ft 11.700 1 030020501

3003

Ütésálló műanyag aláfekvő ágy

• Kerék Ø: 76 mm



3003	Ft	1	030030001
	34.450		

3003/RLS

6 pótkerék 3003 aláfekvő ágyhoz



3003/RLS	Ft	1	030030501
	18.950		

3003C

Ütésálló műanyag aláfekvő

- Részei:
- szénszálazs fej- és derékrész
 - felső fémlamezek mágneses tartozékok tárolására
 - 6 db Ø 79 mm gumikerék
 - Max. teherbírás: 120 kg
 - Súly: 5,5 kg



3003C	Ft	1	030030100
	89.050		

3003C/RLS

6 tartalék kerék a 3003C aláfekvő ágyhoz



3003C/RLS	Ft	1	030030600
	41.600		

3003PRO

Ütésálló műanyag aláfekvő

- Részei:
- ergonomikus fejpárna
 - puha hátvédő
 - 2 db 178 mm kettőscsapágyú kerék az egyenetlen felületeken, csöveken/kábeleken való zavarmentes mozgásért
 - 1 forgókerék
 - két magassági beállítás: 38 vagy 76 mm
 - 2 hordozható LED lámpa (250 lumen)
 - rögzítőmágnessel
 - teherbírás: 200 kg
 - súly: 7,7 kg



C max	H min	H Max	H1	Ft	1	030030150
200	170	230	230	126.500		

3003PRO/SP

falra szerelhető műanyag tartó a 3003PRO aláfekvőhöz

falra, emelőre, fiókos szekrényre vagy más berendezésre rögzíthető, így az aláfekvő biztonsági zárral felszerelt gyorsrögzítő rendszerhez rögzíthető



3003PRO/SP	Ft	1	030030151
	28.950		

3003PRO/PM

mágneses szerszámtartó, kerék, 3003PRO aláfekvőhöz

az aláfekvő keréktárcsájához rögzítve megtartja a kis tárgyakat



3003PRO/PM	Ft	1	030030152
	3.020		

3003PRO/RCR

hátsó tartalék kerék pár a 3003PRO aláfekvő ágyhoz



3003PRO/RCR	Ft	1	030030650
	31.200		

3003PRO/RRG

első tartalék kerék a 3003PRO aláfekvő ágyhoz



3003PRO/RRG	Ft	1	030030651
	9.650		

3003PRO/RT

LED szerelőlámpa pótmágnesekekkel a 3003PRO aláfekvő ágyhoz

- 250 lumen
- Elemek: 4xAAA (nem tartozék)



3003PRO/RT	Ft	1	030030652
	6.930		

3004

kerékék



3004	H	L	L1	Ft	1	030040000
	225	475	200	14.800		



JÁRMŰJAVÍTÁS

Járműjavító szerszámainkat, amelyeket a legigényesebb szakemberek használnak, a világ legmagasabb követelményeinek megfelelően fejlesztettük és gyártottuk, és rendszeresen teszteljük a legnagyobb terhelést jelentő üzemi körülmények között.

Több mint 50 éve büszkén dolgozunk együtt a legnagyobbakkal, akik segítenek termékeink folyamatos fejlesztésében és biztosítják a legmagasabb minőségi színvonalnak való megfelelést.

A járműjavító eszközök az alábbi szakaszokban találhatóak:

DIAGNOSZTIKA	1438 - 1499 1758VT - 1760TMC
MOTOR	955 - 989A 1438 - 1499
OLAJ ÉS SZŰRŐK	1438 - 1499 1877 - 1885
ELEKTROMOS RENDSZER	1438 - 1499
GYORSINDÍTÓK	1498BC/12 - 1498/40A
ERŐÁTVITEL	1438 - 1499
FELFÜGGESZTÉS	1549 - 1569CP
FÉKEK	1438 - 1499
KEREKEK	955 - 989A
KAROSSZÉRIA	1302 - 1369 1763 - 1767A
EGYÉB BERENDEZÉSEK	1878 - 3067
EMELÉSTECHNIKA	3029/2T - 3067/70-13T



3006

traktor és markológép
kerék emelő és pozícionáló

- legnagyobb teherbírás 1500 kg
- legkisebb kerék átmérő 1000 mm
- legnagyobb kerék átmérő 2200 mm
- legnagyobb kerék vastagság 800 mm

CE



3006 Ft 755.100 1 030060000

3006 R/R/GF

fékezhető tartalék kerék a 3006
kerékemelőhöz és pozícionálózhoz



3006 R/R/GF Ft 19.650 1 030060501

3006 R/R/G

tartalék kerék a 3006 kerékemelőhöz és
pozícionálózhoz



3006 R/R/G Ft 16.800 1 030060502

3007

alváz alá illeszthető kocsis első/hátsó
mechanika nélküli járművekhez

- elsőhid vagy hátsóhid nélküli járművek hatékony mozgatószerszám a munkavégzési fázisban
- 4 elforduló kerék, kettő fékezett, fényzökemencében használható
 - 2 állítható tartóelemmel minden alvázhöz alkalmazkodik
 - legnagyobb teherbírás 800 kg

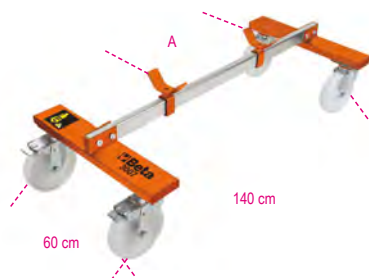

3007 A Max mm 110 Ft 246.300 1 030070001

3007 R/R/GF

fékezhető tartalék kerék a 3007
alváz alá illeszthető kocsisoz



3007 R/R/GF Ft 42.350 1 030070501

3007 R/R/G

tartalék kerék a 3007
alváz alá illeszthető kocsisoz



3007 R/R/G Ft 37.000 1 030070502

3008

szimpla és dupla teherautó kerék emelő és
pozícionáló

- legnagyobb teherbírás 700 kg
- legkisebb magasság 140 mm
- legnagyobb magasság 660 mm
- görgő tengelytáv 470+740 mm
- hidraulikus biztosítás túlterhelés esetén
- elforduló első kerekek

CE



3008 Ft 1.241.900 1 030080100

3009

Autóroller balesetben sérült autók
mozgatószerszám

- Max. teherbírás 550 kg
- 4 elfordítható kerék
- Hengerszélesség: 200 mm
- Max. 240 mm széles autókerékhez

- Alkalmos:
- Balesetben sérült autók vontatásához
 - Autószerelő és karosszériajavító műhelyekben
 - Bemutatótermekben járműmozgatószerszám



3009 A B Ft 173.500 1 030090001

3009R/GR4

4 darabos kocsik kerékcsoport 3009 R/GR4



3009R/GR4	Ft	1	030090501
	68.350	1	030090501

3010/T...

1 pár szerelőbák



C max	H min	H max	H1	L	L1
kg	mm	mm	mm	mm	mm
2000	280	425	245	185	165

3010T 2	Ft	1	030100002
	36.500	1	030100002

C max	H min	H max	H1	L	L1
kg	mm	mm	mm	mm	mm
3000	285	430	250	180	195

3010T 3	Ft	1	030100003
	43.800	1	030100003

C max	H min	H max	H1	L	L1
kg	mm	mm	mm	mm	mm
6000	400	580	340	245	280

3010T 6	Ft	1	030100006
	63.050	1	030100006

C max	H min	H max	H1	L	L1
kg	mm	mm	mm	mm	mm
10000	471	735	420	330	290

3010T 10	Ft	1	030100010
	107.700	1	030100010

3011/T

Hidraulikus emelő



C max	H min	H Max	L
kg	mm	mm	mm
3500	170	366	86

3011T 3,5	Ft	1	030110035
	40.800	1	030110035

C max	H min	H Max	L
kg	mm	mm	mm
5000	203	467	118

3011T 5	Ft	1	030110050
	45.700	1	030110050

C max	H min	H Max	L
kg	mm	mm	mm
10000	220	484	114

3011T 10	Ft	1	030110100
	68.850	1	030110100

C max	H min	H Max	L
kg	mm	mm	mm
15000	230	497	113

3011T 15	Ft	1	030110150
	86.550	1	030110150

C max	H min	H Max	L
kg	mm	mm	mm
20.000	245	521	115

3011T 20	Ft	1	030110200
	122.600	1	030110200

3010H

nagy teherbírású tartóbak



C Max	H min	H Max	L	L1
kg	mm	mm	mm	mm
15.000	445	631	300	300

3010H 750	Ft	1	030100150
	135.900	1	030100150

C Max	H min	H Max	L	L1
kg	mm	mm	mm	mm
15.000	645	1077	300	300

3010H 1100	Ft	1	030100165
	168.900	1	030100165

3010V



C Max	H min	H Max	L	L1
kg	mm	mm	mm	mm
20.000	410	600	330	330

3010V 680	Ft	1	030100200
	193.600	1	030100200

C Max	H min	H max	L	L1
kg	mm	mm	mm	mm
20.000	665	1090	460	460

3010V 1170	Ft	1	030100220
	246.600	1	030100220

3012

motortartó kengyel



L	C max	Ft	1	030120010
mm	kg			
1500	500	123.400	1	030120010
1800	400	166.100	1	030120018

3012C

alsó motortartó kengyel

autókhoz és haszongépjárművekhez ideális



3012C	Ft	1	030120255
	325.500	1	030120255

3012I

Motortartó kengyel, alsó

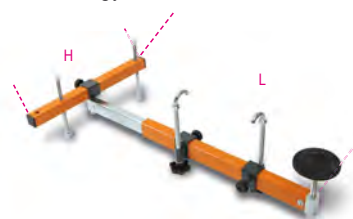

3012I	L	H	Ft	1	030120250
	mm	mm			
	630=960	190	287.300	1	030120250

Beta

Beta
Quality Tools

3014

Motortartóbak



3014 Ft 156.800 1 030140010

3014R/GR5

5 pótkerék a 3014 motortartó állványhoz



3014R/GR5 Ft 39.650 1 030140501

3014 SAR

Motortartóbak

- Könnyen kezelhető, helytakarékos
 - A motor és a hajtómű 360°-os elfordítását teszi lehetővé
 - Maximális biztonság és stabilitás
- Max. teherbírás: 450 kg



3014 SAR Ft 574.400 1 030140360

3014SAR/RR

4 pótkerék a 3014SAR motortartó állványhoz



3014SAR/RR Ft 53.750 1 030140370

3014SAR/1

Folyadékgyűjtő tartály a 3014 SAR modellhez

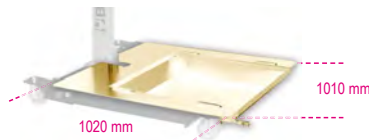

3014SAR/1 Ft 165.800 1 030140361
1020x1010x11 mm

3014SAR/2

Kengyel a hajtómű tartóblokkra történő rögzítéséhez a 3014 SAR modellhez

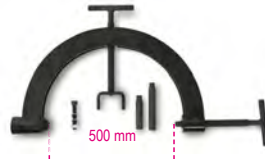

3014SAR/2 Ft 161.500 1 030140362

3023

hidraulikus hajtómű emelő állító csavarral

maximális teherbírás: 400 kg



3023 H min-Max mm Ø mm Ft 83.400 1 030230050

3025

Hidraulikus daru kettőshatású szivattyúval

Max. teherbírás: 1 t

CE



H mm P mm L mm L1 mm Ft 1650 1560 1000 835 770.000 1 030250001

3025/RF

2 rögzített pótkerék a 3025 hidraulikus daruhoz



3025/RF Ft 84.600 1 030250901

3025/RG

2 elforduló pótkerék a 3025 hidraulikus daruhoz



3025/RG Ft 122.700 1 030250902

3025/PF

Hordóemelő

Max. teherbírás: 300 kg

CE



3025/PF A mm B mm Ft 550+640 70 124.900 1 030250011

3026 0,3

Hidraulikus hajtómű emelő

CE



H min H Max L L1 Ø mm mm mm mm mm Ft 1120 1970 450 450 25 284.700 1 030260003

3026/R0,3

4 elforduló pótkerék a 3026 0,3 hidraulikus emelőhöz



3026/R 0,3	Ft	1	030260903
	61.300		

3026 0,5

Hidraulikus hajtómű emelő

Max. teherbírás: 500 kg

CE



H min	H Max	L	L1	Ø	Ft	1	030260005
mm	mm	mm	mm	mm	335.100		
1140	1990	600	550	30			

3026/R0,5

4 elforduló pótkerék a 3026 0,5 hidraulikus emelőhöz



3026/R 0,5	Ft	1	030260905
	88.750		

3026 1,0

hidraulikus hajtómű emelő

Legnagyobb teherbírás 1 t

CE



H min	H Max	L	L1	Ø	Ft	1	030260010
mm	mm	mm	mm	mm	410.800		
1140	1990	650	550	35			

3026/R 1,0

4 tartálék forgókerék a 3026 1,0 hidraulikus emelőhöz



3026/R 1,0	Ft	1	030260910
	111.700		

3026/S

Forgatható tartó állítható persellyel a 3026 modellhez

Max. teherbírás: 500 kg

CE



3026/S	Ft	1	030260501
	240.000		

3026/SP

univerzális emelő hajtóművekhez

Lehetővé teszi, hogy a kezelő egyedül, gyorsan és biztonságosan kisserelje és visszaszerelje a személygépkocsik, haszonjárművek és terepjárók hajtóműveit

CE



3026/SP	Ft	1	030260505
	280.400		

3026/SA

Kerékagy támasz hidraulikus hajtómű emelőhöz

• Kerékagy karbantartáshoz és lengéscsillapító cseréhez
• A 3026 0,3 és 3026 0,5 hidraulikus hajtómű emelőhöz csatlakoztatható



3026/SA	Ø	Ft	1	030260510
	mm	59.850		
	30,4			

3026/SAM

Lengéscsillapító támasz hidraulikus hajtómű emelőhöz

• Lengéscsillapítók kitámasztásához a felfüggesztő kar leszerelése esetén
• Lengéscsillapító konzol, max. átmérő 80 mm, kiegészítő adapter max. 60 mm átmérőhöz
• A 3026 0.3 és 3026 0.5 hidraulikus hajtómű emelőhöz csatlakoztatható



3026/SAM	Ft	1	030260515
	76.700		

3027 10

Hidraulikus prés mozgó dugattyúval

Max.teherbírás: 10 t

CE



3027 10	Ft	1	030270010
	680.500		
	90 kg		

3027 20

Hidraulikus prés

20 t

Max.teherbírás: 20 t

CE



3027 20	Ft	1	030270020
	941.800		
	131 kg		

3027 30

hidraulikus prés mozgó dugattyúval és csőrőlővel

legnagyobb teljesítmény: 30 t

CE



3027 30 Ft 1.641.400 1 030270030

245 kg

3027 50

Hidraulikus prés mozgó dugattyúval

Max. teherbírás: 50 t

CE



3027 50 Ft 2.246.800 1 030270050

368 kg

PRÉSEK

A Beta prések széles skáláját kínálja.

A 3027 préscsaládot intenzív használatra terveztük; ezt az első osztályú anyagok és kivitel garantálja, míg a 3028 sorozat kiemelkedő ár/érték arányt képvisel.

3027 100

elektrohidraulikus motoros prés mozgó dugattyúval

műszaki jellemzők:

- maximális teherbírás: 100 t
- tápellátás: 380 V (három fázis)
- frekvencia: 50 Hz
- villanymotor teljesítmény: 1,5 kW
- kétsélességű vezérlőegység
- karos elosztóval működtethető
- láncos raklap emelés

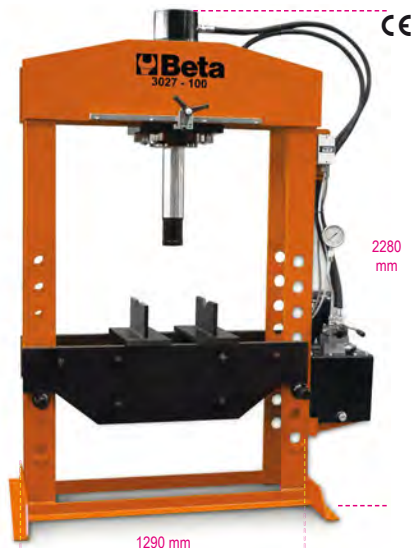

- A szállítás biztonsága érdekében a prést olaj nélkül szállítjuk (Eni OSO 46 - ESSO NUTO 46 vagy egyenértékű olaj).
- Tápkábel nélkül szállítva.

3027 100 Ft 4.892.000 1 030270100

980 kg

3027/KP

kiütő készlet és lemez a 3027 prés modellhez



		Ft		
3027/KP10	3027 10	152.700	1	030270510
3027/KP20	3027 20	204.000	1	030270520
3027/KP30	3027 30	204.000	1	030270530
3027/KP50	3027 50	239.100	1	030270550
3027/KP100	3027 100	480.800	1	030270551

3027/KPP50

Lábkapcsoló a hidraulikus préshez, a 3027 20-30-50 modellhez



3027/KPP50 Ft 99.500 1 030270555

3027/PR

prés tartó szerzőszám agy, csapágy és szilentrögzítő blokk behúzóhoz/beillesztéshez

Agyak, csapágyak és szilentrögzítők ki- és beszerelését segítő univerzális rendszer prés alatt végzett munkához, tartóval és kiegészítővel.

A szerzőszám szabálytalan formájú agyakhoz/királycsapokhoz is alkalmazkodik.



MŰSZAKI ADATOK

Hatósugár: min. 130 mm - max. 186 mm

Méret: 300 x 300 mm

Súly: 13 kg

Maximális teherbírás: 20 t

3027/PR Ft 318.400 1 030270400

3028 20

hidraulikus prés mozgó dugattyúval

maximális teherbírás: 20 t
függetlenül állítható felső rész
csúszódugattyú

CE

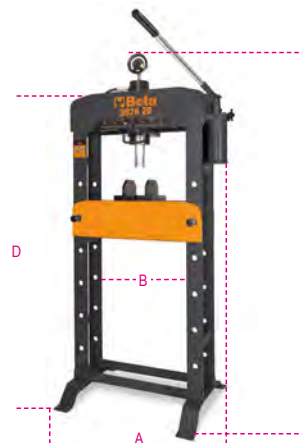

A B C D Ft 850 540 1830 1602 579.500 1 030280020

3028SP/20

védőburkolat a 3028 20 préshez



3028SP/20 Ft 70.450 1 030280021

3028 30

hidraulikus prés mozgó dugattyúval

maximális teherbírás: 30 t
függgőlegesen állítható felső rész
csúszódugattyú

CE

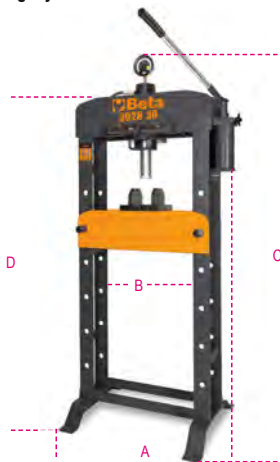

A	B	C	D	Ft	1	030280030
850	540	1850	1650	806.100	1	030280030

3028SP/30

védőburkolat
a 3028 30 préshez



3028SP/30	Ft	1	030280031
	70.450	1	030280031

3028 50

hidraulikus prés mozgó dugattyúval és
csőrőlővel
maximális teherbírás: 50 t
csőrőlővel állítható felső rész
csúszódugattyú

CE

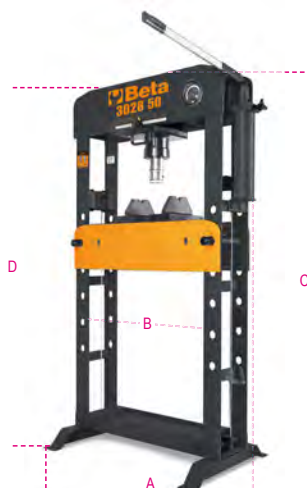

A	B	C	E	Ft	1	030280050
1100	750	1850	820	1.412.900	1	030280050

3028SP/50

védőburkolat
a 3028 50 préshez



3028SP/50	Ft	1	030280051
	74.450	1	030280051

3029/2T

2 tonnás, 4 kerek alacsony profilú
hidraulikus emelő

- Gyorspedál
- Acélváz és nejlón kerék
- Legkisebb magasság: 75 mm

CE



3029/2T	Ft	1	030290020
	189.000	1	030290020

3029L/2T

alacsony profilú hosszú krokodil emelő, 2 t

- Lehetővé teszi a munkavégzést olyan alacsony
hasmagasságú járművön, ahol az emelési pont mélyen van.
- Szabályozott visszaeresztési sebesség
 - Gyorspedál
 - Nejlón kerekek

CE



3029L/2T	Ft	1	030290120
	213.200	1	030290120

3029/2T-L/RP

85 mm-es tartalék gumipogácsa
a 3029/2T és 3029L/2T emelőhöz



3029/2T-L/RP	Ft	1	030290502
	6.250	1	030290502

3029/2T-L/R6

tartalék hátsó kerék
a 3029/2T, 3029L/2T, 3030H/2T, 3033E/3T
emelőhöz



3029/2T-L/R6	Ft	1	030290506
	21.300	1	030290506

3029/2T-L/R5

tartalék első kerék
a 3029/2T és 3029L/2T emelőhöz



3029/2T-L/R5	Ft	1	030290505
	19.500	1	030290505

3030/2T

Hidraulikus krokodilemelő 2T
6 kéréssel

- Elől műanyag dupla kerék (PTFE)
- Optimális kezelhetőség nem sík és egyenetlen felületen
- Maximális teherbírás: 2 tonna

CE



3030/2T	Ft	1	030300020
	320.200	1	030300020

43 kg

3030/2T-R5

csapos első kerék a 3030 2T emelőhöz



3030 2T/R5	Ft	1	030300505
	11.150	1	030300505

3030/2T-R6

hátsó pótkerék a 3030/2T emelőhöz



3030 2T/R6	Ft	1	030300506
	17.900	1	030300506

3030/2TRP

85 mm tartalék gumilap
a 3030/2T-hez



3030/2TRP Ft 2.150 5 030300501

3030H/2T

magas hidraulikus emelő,
2 t, 6 kerékkel

lehetővé teszi a padlószinttől magasan elhelyezkedő és nagyobb emelkedésű lengéscsillapítókkal szerelt gépjárművek emelését • szabályozott visszaeresztési sebesség
• gyorspedál
• nejlón kerekek

CE



H min-Max mm 85+780 L mm 1010 L1 mm 300 Ft 284.000 1 030300220

3033/3T

Hidraulikus emelő 3T
hosszú kivétel

- Alkalmos főként kisebb szállító járművekhez
- Max. teherbírás: 3 t
- Poliamid-kerekek

CE



3033/3T Ft 422.100 1 030330030

3033E/3T

hidraulikus emelő,
3 t

- szabályozott visszaeresztési sebesség
- nejlón kerekek

CE



H min-Max mm 95+515 L mm 700 L1 mm 370 Ft 169.200 1 030330130

3033S 3T/R2

első pótkerék
a 3033E/3T emelőhöz



3033S 3T/R2 Ft 14.250 1 030330532

3035

Autókerékszállító kocsi

- Az autókerekek könnyen szállíthatók Ø 980 mm-ig
- A robusztus keret lehetővé teszi az autókerekek könnyű szállítását, illetve kezelhetőségét
- A rakodófelület vízszintesen is használható és különböző pozícióba állítható
- 2 kerék Ø 260 mm
- 2 kerék Ø 125 mm
- Max. rakodási magasság 1,60 m
- Max. terhelhetőség 200 kg
- 2 pozícióba állítható villák:
Első pozíció max. távolság 880 mm
Második pozíció max. távolság 980 mm



3035 Ft 403.000 1 030350100

3036

gumiabroncs szállító/tároló állomás

Nyomot nem hagyó gumikerekek



3036 Ft 57.950 1 030360063

3061/2T

2 tonnás - 2 lépcsős pneumatikus emelő

CE



A következőkkel rendelkezik:

- háromlépcsős nagy ellenállású membrán és belső teleszkópos vezető
- végállási megállító berendezés és biztonsági szelepek túlterhelés esetére
- emelőberendezéseken is használható

MŰSZAKI ADATOK

teherbírás: 2 t
súly 14 kg
üzemi nyomásigény: 8-10 bár
magasság: min.132 - max. 326 mm

3061/2T Ft 368.200 1 030610020

3061/2T-P50

50 mm-es hosszabbító a 3061/2T modellhez



3061/2T P50 Ft 30.600 1 030610021

3061/2T-P100

100 mm-es hosszabbító a 3061/2T modellhez



3061/2T P100 Ft 41.000 1 030610022

3065/20-10T

20-10 t hidropneumatikus emelő szállítókárával

Hordozható, könnyű, az országúti szervizeknél ideális

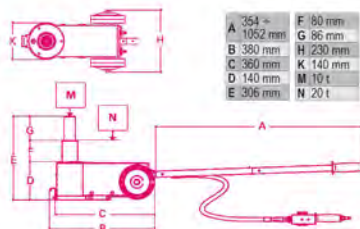

A	354 mm	F	80 mm
B	1052 mm	G	86 mm
C	380 mm	H	230 mm
D	360 mm	K	140 mm
E	140 mm	M	10 t
		N	20 t

- egy 75 és egy 60 mm-es hosszabbítót tartalmaz

MŰSZAKI ADATOK
teherbírás: 20-10 tonna
súly: 23 kg
tápnymomás: 8-10 bar
levegőfogyasztás: 400 l/perc

3065/20-10T Ft 1.118.600 1 030650100

3065/40-20T

40/20 tonnás hidropneumatikus emelő

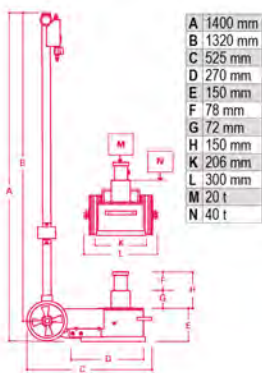

A	1400 mm
B	1320 mm
C	525 mm
D	270 mm
E	150 mm
F	78 mm
G	72 mm
H	150 mm
K	206 mm
L	300 mm
M	20 t
N	40 t



- nehéz haszongépjárművekhez javasolt
- praktikus és jól szállítható mozgó műhelyekkel is
- automatikus dugattyú visszahúzóadás
- két süllyesztőszelep terhelés alatt sebességellenőrzéssel

MŰSZAKI ADATOK
teherbírás: 40/20 tonna
súly: 39 kg
üzemi nyomásigény: 8-10 bár
levegőfogyasztás 400 l/perc

3065/40 20T Ft 1.216.300 1 030650200

3067/60-15T

60-30-15 t hidropneumatikus emelő

A csak 120 mm legkisebb magasságával különösen alkalmas városi és turista autóbusszoknál, és tömegközlekedési járműveknél történő használatra

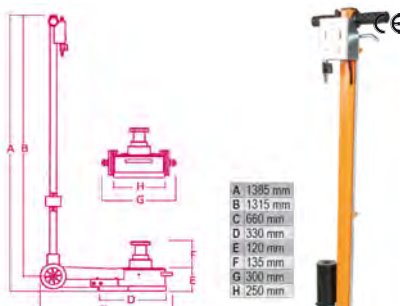

A	1385 mm
B	1315 mm
C	660 mm
D	330 mm
E	120 mm
F	135 mm
G	300 mm
H	250 mm

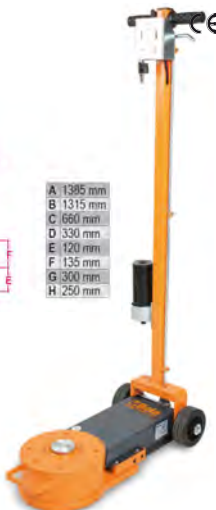

- automatikus dugattyú visszaállítás
- két süllyesztőszelep terhelési sebesség ellenőrzéssel
- egy 70 és egy 120 mm-es hosszabbítót tartalmaz

MŰSZAKI ADATOK
teherbírás: 60-30-15 tonna
súly: 56 kg
tápnymomás: 8-10 bar
levegőfogyasztás: 600 l/p

3067/60-30-15T Ft 1.862.000 1 030670120

3067/70-13T

70-43-23-13 t hidropneumatikus emelő

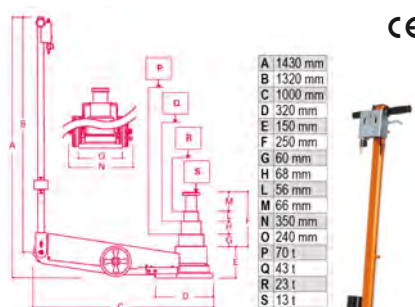

A	1430 mm
B	1320 mm
C	1000 mm
D	320 mm
E	150 mm
F	250 mm
G	60 mm
H	68 mm
L	56 mm
M	66 mm
N	350 mm
O	240 mm
P	70 t
Q	43 t
R	23 t
S	13 t

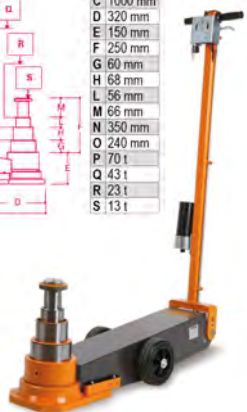

- Hosszú változat, teherautók, nyergesvontatók, autóbusszok és mezőgazdasági gépek esetén történő használatra alkalmas
- automatikus dugattyú visszahúzóadás
- két süllyesztőszelep terhelés alatt sebességellenőrzéssel

MŰSZAKI ADATOK
teherbírás: 70-43-23-13 tonna
súly: 74 kg
üzemi nyomásigény: 8-10 bár
levegőfogyasztás 600 l/perc

3067/70 13T Ft 2.275.200 1 030670130

Beta



MOTORKERÉKPÁR-SZERELŐ SZERSZÁMOK



3040C

állítható hátsó kerék állvány
motorkerékpárhoz

- Mattfekete lakkozás
- 4 hőkezelt gumikerék
- V-adapterpár
- L-adapterpár



3040C Ft 33.800 1 030400002

3040C/S1

V-adapterpár
a 3040C-hez



3040C/S1 Ft 4.960 1 030400503

3040C/S2

L-adapterpár gumiból
a 3040C-hez



3040C/S2 Ft 6.510 1 030400504

3041C

állítható első kerék állvány
motorkerékpárhoz

- Mattfekete lakkozás
- 4 hőkezelt gumikerék
- Görgős adapterpár
- Kúpos adapterpár



3041C Ft 29.950 1 030410002

3041C/12

Görgős adapterpár
a 3041C-hez



3041C/12 Ft 6.840 1 030410512



3041C/16

kúpos adapterpár
a 3041C-hez



3041C/16 Ft 4.550 1 030410516

3042C

előlső állvány
a motorkerékpár kormánycsövéhez

- Mattfekete lakkozás
- 4 hőkezelt gumikerék
- 8 csapszegből álló készlet: Ø 13 - 15 - 15.5 - 17 - 19 - 20 - 21 - 27



3042C Ft 52.450 1 030420002

3043C

egykarú motorkerékpár állvány
balos

- Mattfekete lakkozás
- 4 hőkezelt gumikerék

- Opcionális csapszeg



3043C Ft 39.150 1 030430002

3043C/ 41÷47

Csapszeg
a 3043C-hoz



	Ø mm	Ft	1	030430551
3043C/41 Ducati	21,5 ÷ 25,5	8.650	1	030430551
3043C/42 KTM - Triumph	27,5	8.650	1	030430552
3043C/43 MV	42,5	9.570	1	030430553
3043C/44 Ducati	40,5	9.570	1	030430554
3043C/45 Honda	28,5	8.650	1	030430555
3043C/47 BMW	53,5	11.400	1	030430557



3047C

pedálos cross/enduro
motorállvány



3047C Ft 24.950 1 030470002

3048C

acél cross racing tartóállvány



3048C Ft 24.950 1 030480002

3050/CC

Custom, Enduro, Cross, Scooter
alsó bölcscsavaros középállvány

állítható tartó készletet tartalmaz

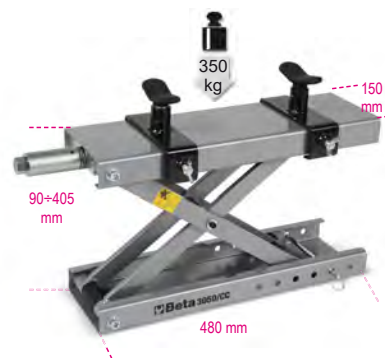

3050/CC Ft 65.650 1 030500012



3050/600

elektro-hidraulikus motorkerékpár emelő,
600 kg

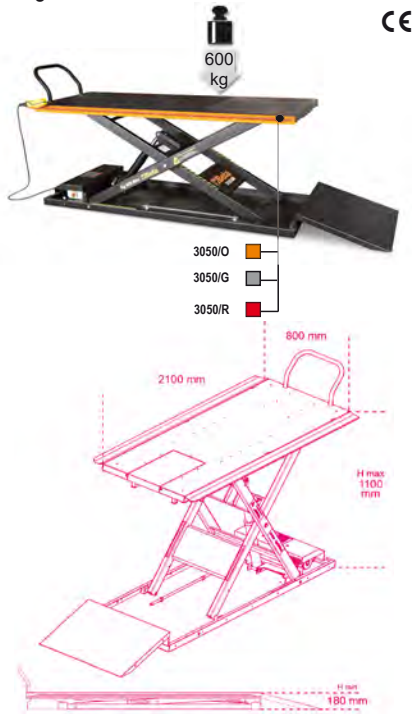

Műszaki adatok

- Elektromos, mechanikus és hidraulikus biztosítószerkezetek
- Teherbírás: 600 kg
- Integrált elektro-hidraulikus egység: 230V - 50 Hz
- Hidraulikus szivattyú
- Szabályozott visszaeresztési sebesség
- Olvadóbiztosítékos védelem kábelszakadás esetére
- Nyomógombos vezérlő panel
- CE tanúsítvány, TÜV bevizsgálás

	L	L	H min	H Max	Ft		
	mm	mm	mm	mm			
3050/O	975	2100	185	1110	1.956.800	1	030500201
3050/G	975	2100	185	1110	1.956.800	1	030500202
3050/R	975	2100	185	1110	1.956.800	1	030500203

3050/KA

szélesítő készlet a 3050/600 emelőhöz



	A	B	Ft		
	mm	mm			
3050/KA-O	107,5	2100	464.000	1	030500221
3050/KA-G	107,5	2100	464.000	1	030500222
3050/KA-R	107,5	2100	464.000	1	030500223

3050/MS

kerékszorító satu a 3050/60 emelőhöz



a motorkerékpár első kereke a hidhoz rögzíthető



	Ft		
3050/MS	274.700	1	030500032

3050/MV

mechanikus kerékszorító satu
3050/600 emelőhöz



	Ft		
3050/MV	466.700	1	030500034

3050/LA

csúszásmentes lemez pad
a 3050/60 emelőhöz

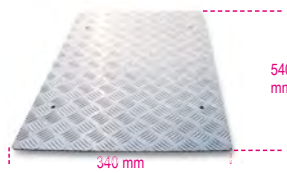

	Ft		
3050/LA	46.700	1	030500062

9562T1

garázs szőnyeg, 100x80 cm



különösen alkalmas a BETA 3071 és 3071B motorkerékpár emelő alá

- könnyen tisztítható, csúszásmentes, gumibevonátú alsórész



	L	H	Ft		
	cm	cm			
9562T1	100	80	22.400	1	095620150

9562T3

garázs szőnyeg
Méret: 300x160 cm



- Különösen alkalmas motorkerékpár emelők alá

- Védi a padlót az olaj- és benzincsopeptől, környezetbarát
- Könnyen tisztítható, csúszásmentes, gumibevonátú alsórész



	L	H	Ft		
	cm	cm			
9562T3	300	160	96.900	1	095620300

3054

mobil állvány középső kitámasztós
motorkerékpárhoz
vagy hátsó keréken lévő oldaltámaszhoz



	Ft		
3054	111.200	1	030540000

3055M

automatikus satu furgonokhoz



lehetővé teszi a motor első
kerékének rögzítését



	Ft		
3055M	42.250	1	030550002

3057

alumínium rámpa motor felrakodáshoz/
lerakodáshoz

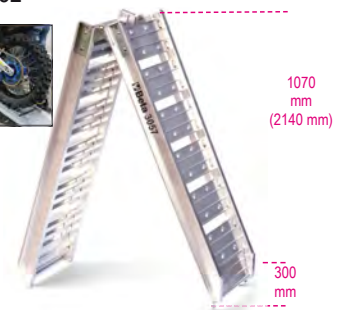
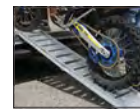

	Ft		
3057	84.500	1	030570001

3070B

statikus kézi kiegyensúlyozó eszköz



- lehetővé teszi a kerekek kiegyensúlyozását műhelyben és versenypályán
- gördülőcsapágyakkal, pozicionálás szintezővel és állítható lábakkal rendelkezik a maximális pontosság érdekében
- kettős kúppal a kerékgagyakhoz

	Ft		
3070B	51.550	1	030700100

3070B/...

kiegyensúlyozó rúd
a 3070B kiegyensúlyozóhoz



	Ø1	Ø2	Ft		
3070B/10	30	10	9.070	1	030700101
3070B/12	30	12	10.900	1	030700102
3070B/14	40	14	13.200	1	030700103

3070BE/K

hordozható, kézzel hajtott elektronikus
kerékiegyensúlyozó



kézzel hajtott, mikroprocesszoros kerékiegyensúlyozó rendszer
(motor nélkül),
vas vagy ötvözet autó- és motorkerékpár-kerekek
kiegyensúlyozására



- kompakt, könnyen szállítható, használható műhelyben és versenypályán
- munkapadra vagy falra szerelhető
- a szoftver tartalmazza az összes kiegyensúlyozó programot, lehetőséget az öntapadós keréksúly pozíciók leolvasására (ALUS), küllők mögé rejtett keréksúlyokra (SPLIT) és a kiegyensúlyozatlanság optimalizálására
- a BETA 3070BE/S állítható konzollal együtt használható (opcionális)

A KERÉKCENTRÍROZÓVAL SZÁLLÍTOTT TARTOZÉKOK

- rugalmas mérőléc
- gyűrűsanya kézikerékkel és 3 db Ø 45 + 110 mm átmérőjű kúppal

MŰSZAKI ADATOK

Tápfeszültség: 115-230V AC o 12-24V DC
Max. felvett teljesítmény: 0,15 kW
Centrírozási sebesség: 100 rpm
Mérési bizonytalanság: 1 g
Felni szélesség: 1,5" + 20" (40 + 510 mm)
Max. kerék átmérő: max. 75 kg

	Ft		
3070BE/K	1.176.400	1	030700250

3070BE/S

állítható konzol a 3070BE hordozható
elektronikus kerékiegyensúlyozóhoz



segítségével a kerékiegyensúlyozó falra vagy munkapadra
rögzíthető, csökkentve a helyigényt



	L	L1	Ft		
3070BE/S	514	280	468.300	1	030700201

3070BE/F

univerzális motorkerékpár illesztőperem, Ø 40
mm,
a 3070BE kerékiegyensúlyozóhoz
Ø 15 + 35 mm központi átmenőfuratú abroncsokhoz, és max.
Ø 68 mm peremes kerekek kiegyensúlyozásához



	Ft		
3070BE/F	636.400	1	030700202

3070BE/B

8 részes befogóbetét motorkerékpár
kerekekhez,
a 3070BE kerékiegyensúlyozóhoz
A következő átmérőjű kerekekhez:
28 - 25 - 22 - 20 - 19,05 - 17 - 16 - 15



	Ft		
3070BE/B	716.000	1	030700203

3071A

gumiabroncs szerelővas cross- és enduro
motorokhoz



Könnyű és gyors abroncs leszedés a versenypályán; a széles,
masszív horganyzott acél szerkezet stabil fogást garantál
szerelés közben. A nagyobb kényelem érdekében BETA
3071RS konzolra szerelhető

Jellemzők:

- Ergonomikus gumi markolat a könnyű és biztos fogásért
- Gumi rögzítő a rúd lezárásához szállítás közben
- 17" + 21" méretű cross- és enduro motor abroncsok szereléséhez

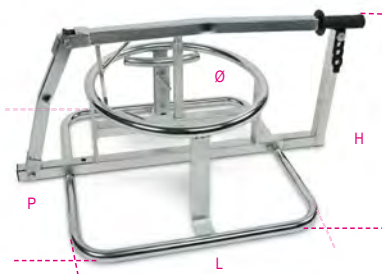

	L	H	P	Ø	Ft		
3071A	570	400	850	440	197.100	1	030710000

3071B

gumiabroncs szerelővas mini motorokhoz és
mini terepmotorokhoz (dirt bike)



Könnyű és gyors abroncs leszedés a versenypályán; a széles,
masszív horganyzott acél szerkezet stabil fogást garantál
szerelés közben. A nagyobb kényelem érdekében BETA
3071RS konzolra szerelhető

Jellemzők:

- Ergonomikus gumi markolat a könnyű és biztos fogásért
- Legtöbb mini motor és mini terepmotor szereléséhez

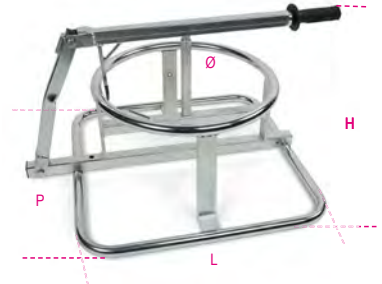

	L	H	P	Ø	Ft		
3071B	570	330	650	340	184.000	1	030710010

3071RS

konzol a BETA 3071A és 3071B gumiabroncs
szerelővashoz



A BETA 3071A és 3071B gumiabroncs szerelővasat
megemelve megkönnyíti az abroncs leszedését. Horganyzott
acél keret. A négyszögletes talp stabil tartást biztosít.

- 4 rögzítőhoroggal

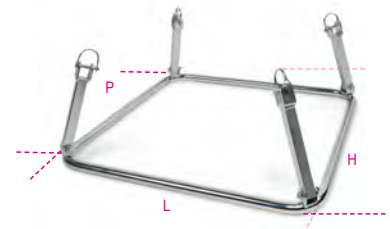

	L	H	P	Ft		
3071RS	670	275	670	85.650	1	030710020

962C

gumiabroncs szerelővas pár
cross és enduro motorokhoz, mini motorokhoz
és mini terepmotorokhoz (dirt bike)
a BETA 3071A és 3071B modellel együttes használatra



	L	A	Ft		
962C	420	30	47.000	1	009620020

3072N

motorkerékpár hátsó lengéscsillapító szerelőpad, kézi szereléshez

A motorkerékpár hátsó lengéscsillapítójának teljesen biztonságos szétszerelését teszi lehetővé az állítható karoknak köszönhetően, ami a legtöbb lengéscsillapítóhoz használható, vagy használható akár a tartozék betéttel.
- opcionális zárógyűrűk

Tulajdonságok

- Legtöbb motorkerékpár hátsó lengéscsillapítójához használható
- Függőlegesen 8 pozícióban állítható
- 3 állítható kar állítható magasságú rögzítőekkel
- lengéscsillapító zárólemez
- ollós emelő
- gumitalpak
- lengéscsillapító rögzítőcsap

Műszaki adatok

Emelő hosszabbító: max. 130 mm
Emelőkar hosszabbító: max. 55 mm
Rögzítő hosszabbító: max. 18 mm
Emelőerő: max. 1 t

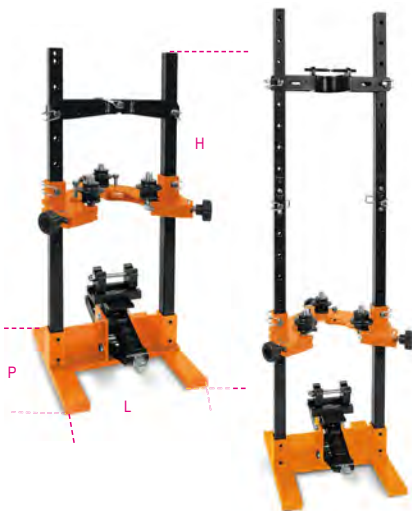

	L	H	P	Ft		
	mm	mm	mm			
3072N	390	785	390	445.400	1	030720010

3073

univerzális villa olajvédő beillesztő egység

35 és 45 mm közötti szárahhoz



	Ft		
3073	34.650	1	030730001

3075A

hatszögű dugókulcs kerékagy anyákhöz



	Ø	L	Ft		
	mm	mm			
3075A 28	28	38	10.900	1	030750028
3075A 30	30	40	11.950	1	030750030

3075B

sokszögű dugókulcs DUCATI kerékagy anyához



	Ø	L	Ft		
	mm	mm			
3075B 55	55	70,7	29.250	1	030750155

3075MV

sokszögű dugókulcs MV AGUSTA kerékagy anyához

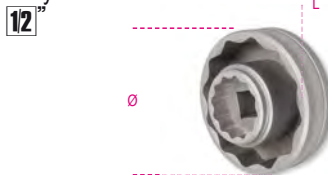

	Ø	L	Ft		
	mm	mm			
3075MV 56	56	70,7	31.850	1	030750156

3075/CM

összetett sokszögű imbuszkulcs kerékcsapokhoz



	Ft		
3075/CM	16.300	1	030750212
Ø	12-14-17-19-22-24 mm		

3075/K10

univerzális cserélhető fejű kulcskészlet és 10 betét kerékküllők meghúzásához

Méretetek: 5.2 - 5.4 - 5.6 - 5.8 - 6.0 - 6.2 - 6.4 - 6.6 - 6.8 - 7.0



	Ft		
3075/K10	22.050	1	030750410

3079/21

huzal olajozó

Lehetővé teszi a tengelykapcsoló és gáz huzalok megfelelő kenését, javítva a hüvely csúszóképességét és a huzal élettartamát.



	Ft		
3079/21	3.110	1	030790021

3080/C15

láncszem eltávolító és beillesztő készlet

Átmérő 3-4-5 mm, és regina készlet



	Ft		
3080/C15	119.700	1	030800015

420x185x60 mm

3080R/CS3

3 db pótv csapkinnyomó a 3080/C15 láncszem eltávolító készlethez

átmérő 3-4-5 mm



	Ft		
3080R/CS3	22.050	1	030800503

3081

hordozható láncbontó egység

Erőteljes, és összehajtható az enduro táskában történő szállítás megkönnyítéséhez.

A következő láncokhoz használható 415, 420, 428, 520, 525, 530, 532



	Ft		
3081	17.550	1	030810010

3085

szerszám a fékdugattyúk szétválasztásához

Motorkerékpár és robogó féknyergekhez ajánlott



	Ft		
3085	39.650	1	030850010

3091

belső menetes lehúzó
lendkerékhez



	M	Ft		
3091/10	24x1,5	8.150	1	030910010
3091/20	26x1,0	8.320	1	030910020
3091/25	27x1,0	9.590	1	030910025
3091/30	28x1,0	8.680	1	030910030
3091/40	30x1,0	11.500	1	030910040
3091/45	30x1,5	11.500	1	030910045
3091/50	32x1,5	13.050	1	030910050
3091/60	33x1,5	13.650	1	030910060
3091/70	35x1,0	18.550	1	030910070
3091/75	35x1,5	18.550	1	030910075
3091/80	38x1,5	20.400	1	030910080

3092

külső menetes lehúzó
lendkerékhez



	M	Ft		
3092/10	18x1,5	4.090	1	030920010
3092/20	19x1,0	4.920	1	030920020
3092/25	27x1,0	5.830	1	030920025
3092/30	27x1,25/20x1	5.190	1	030920030
3092/35	22-26x1,5	5.190	1	030920035
3092/40	25x1,5/22x1	5.190	1	030920040
3092/50	26-28x1,0	5.190	1	030920050
3092/60	28x1,5	4.950	1	030920060

3093/E

szerszám lendkerék, tengelykapcsoló harang
és szíjtárcsa reteszeléséhez



	Ft		
3093/E	14.400	1	030930100

3093/U

kombinált lehúzó lendkerékhez



	Ft		
3093/U	14.350	1	030930050
M10x1.25R			
M14x1.5R			
M16x1.5R			
M18x1.5R			
M24x1.0R			
M27x1.0L			

3094PA

OFFROAD motorkerékpár szerelő panel



Fém váz; a lábak a vázba hajthatók; versenypálya melletti felállításához ajánlott
3 színben kapható:
• 3094PA-O narancs
• 3094PA-G szürke
• 3094PA-R piros

Választható tartozékok:
• 3200 PR papírtekerccstartó
• 2499PF/M univerzális mágneses flakontartó

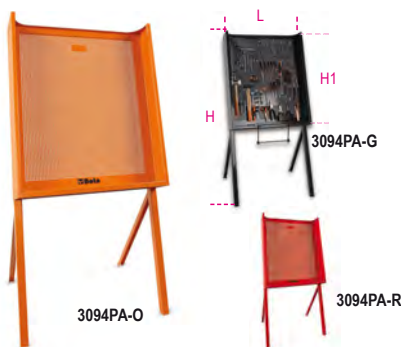

	L	H	H1	Ft		
	mm	mm	mm			
3094PA-O	750	1555	900	205.000	1	030940101
3094PA-G	750	1555	900	205.000	1	030940102
3094PA-R	750	1555	900	205.000	1	030940103

3095

motorkerékpár motor szerelőállvány



állítható tartóoszlopok a motoron végzett kényelmes munka érdekében



	H	P	L	L1	Ft		
	mm	mm	mm	mm			
3095	360	460	640	460	237.700	1	030950001

3099E

kültéri motorkerékpár ponyva, víz- és porálló



karcolás, por és napfény elleni védelem



„M” méret a sport és naked motorkerékpárokhoz és közepes robogókhoz
„L” méret a maxi enduro és crossover motorkerékpárokhoz

	M	Ft		
3099E/M	M	32.000	1	030990102
3099E/L	L	39.500	1	030990103

3099T

beltéri motorkerékpár ponyva, elasztikus szövetből



karcolás, por és napfény elleni védelem



„M” méret a sport és naked motorkerékpárokhoz és közepes robogókhoz
„L” méret a maxi enduro és crossover motorkerékpárokhoz
„XL” méret a túra motorkerékpárokhoz

	M	Ft		
3099T/M	M	27.950	1	030990202
3099T/L	L	34.150	1	030990203
3099T/XL	XL	41.250	1	030990204





KERÉKPÁRSZERELŐ SZERSZÁMOK

A kerékpározás mindig is része volt a Beta életének. A kerékpáros szakemberek számára készült "Kerékpárszerelő szerszámok melléklet" kifejezetten hagyományos és elektromos kerékpárok karbantartásához kifejlesztett termékeinket mutatja be.



Tour de France 2020 and 2021



Partnership 2022

*Official contributor
of Eolo KOMETA cycling*



Partnership 2022



3910



Elektromos kerékpáremelő

- Maximális teherbírás: 40 kg
- Hajtóműtartó maximum magassága: 135 cm
- Beépített kerék kiegyensúlyozó állvány
- Innovatív thru-axle (innovatív, gyorszárás rögzítő) rendszer
- A legtöbb villárhoz használható befogó adapterekkel
- Villacsatlakozó adapterrel szállítva, thru-axle nélkül
- Összehajtható és könnyen szállítható
- Emelési súly: 48 kg

CE

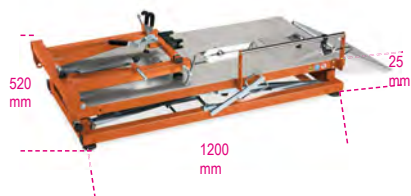

3910 Ft 1.562.400 1 039100010

3912TP



TOP műhelypad kerékpárok karbantartásához

- Hajtóműtartó biztosító csappal
- Teleszkópos, csapágyazott szerszámtartó fiók (490x365x90 mm)
- Beépített kerék kiegyensúlyozó állvány
- Innovatív thru-axle rögzítő rendszer



3912TP Ft 526.000 1 039120050

3912PP



PRO műhelypad kerékpárok karbantartásához

- Hajtóműtartó biztosító csappal
- Beépített kerék kiegyensúlyozó állvány
- Innovatív thru-axle rögzítő rendszer



3912PP Ft 283.100 1 039120150

3912TP/A



befogó adapter thru-axle villákhöz

3912TP, 3912PP és 3910 típusú műhelypadhoz



L mm 39 Ø mm 30 Ø1 mm 5 Ft 7.150 1 039120052

3912TP/C



univerzális befogó adapter thru-axle villákhöz, hatlapú dugókulcsos meghúzáshoz

3912TP, 3912PP és 3910 típusú műhelypadhoz



L mm 29 Ø mm 30 Ft 7.150 1 039120054

3912TP/FOX



befogó adapter for FOX® villákhöz

3912TP, 3912PP és 3910 típusú műhelypadhoz



L mm 38 Ft 7.150 1 039120058

3912TP/QRE



adapter túske villákhöz, thru-axle nélkül

3912TP, 3912PP és 3910 típusú műhelypadhoz



L mm 108 Ft 11.800 1 039120064

3912TP/ROAD



befogó adapter országúti kerékpár villákhöz

3912TP, 3912PP és 3910 típusú műhelypadhoz



L mm 33 Ø mm 35 Ft 7.810 1 039120060

3912TP/RS



befogó adapter ROCKSHOX® thru-axle villákhöz

3912TP, 3912PP és 3910 típusú műhelypadhoz



L mm 35 Ø mm 30 Ft 7.150 1 039120056

3912TP/ST



befogó adapter SUNTOUR villákhöz

3912TP, 3912PP és 3910 típusú műhelypadhoz



L mm 31 Ø mm 30 Ø1 mm 18 Ft 7.810 1 039120062



3916MMP

egykaros műhelysatu kerékpárok karbantartásához

- 360°-ban elforgatható satu, önbeálló pofák és mikrométeres állíthatóság
- Teherbírás: 25 kg
- Műanyag szerszámtartó tál



3916MMP Ft 268.000 1 039160150

3918MML

kerékpárszerelő állvány, könnyű, összecsukszható

- 360°-ban elforgatható tartó
- Teherbírás: 15 kg
- Maximális magasság: 150 cm



3918MML Ft 121.500 1 039180010

3921

a láncvilla-sebességváltó láncvonalat beállító szerszám

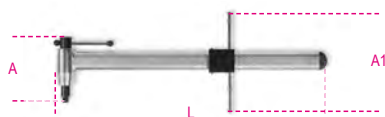

L mm 440 A mm 115 A1 mm 165 Ft 39.850 1 039210010

3923

készvezető szerszám airfoil vázcsövek vágáshoz 80 mm-ig, és 1" és 1.1/2" közötti kormányoszlop vágáshoz

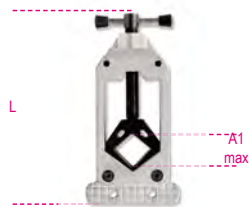

L mm 160 A1 max mm 80 Ø max mm 45 Ft 18.700 1 039230010

3927

kormányreteszelő



3927 L mm 365 Ft 9.810 1 039270010

3932U

professzionális láncbontó készülék 5-11V sebességű láncokkal kompatibilis



L mm 164 L1 mm 115 Ft 18.450 1 039320011

3935

lánckopás jelző



L mm 120 Ft 2.270 1 039350010

3937

patenszem fogó



L mm 170 Ft 6.010 1 039370010

3948

hajtókar lehúzó

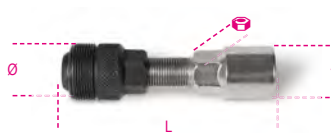

Ø mm 14 L mm 79 Ø mm 20 15 Ft 4.940 1 039480015

3952

egyszerű kúpos kulcs



Ø mm	L mm	Ft	1	2
13	205	8.410	2	039520013
14	205	8.410	2	039520014
15	205	8.410	2	039520015
16	205	8.410	2	039520016
17	205	8.410	2	039520017
18	205	8.410	2	039520018
19	205	8.410	2	039520019
20	205	8.600	1	039520020
21	205	8.600	1	039520021
22	205	8.600	1	039520022
24	205	8.820	1	039520024



3952/S7	Ft	1	2
13-14-15-16	58.850	1	039520207
17-18-19 mm			
3952/S11	93.500	1	039520211
13-14-15-16			
17-18-19-20-21-22-24 mm			

3953

pedálkulcs



Ø mm 15 L mm 401 Ft 13.350 1 039530015

3955

univerzális kormány sorozat villáskulcs



Ø mm	L mm	Ft	1	2
30x32	292	12.550	1	039550108
32x36	319	13.650	1	039550114

3961 3,2

fekete küllőhúzó kulcs 3,2 mm



Ø mm 3,2 Ft 3.310 1 039610032

3961 3,3

zöld küllőhúzó kulcs 3,3 mm



Ø mm 3,3 Ft 3.310 1 039610033

39613,5

piros küllőhúzó kulcs 3,5 mm



mm 3,5 Ft 3.310 1 039610035

3961U

professzionális küllőhúzó kulcs 3,2 - 4,0 mm



mm 3,2 - 4,0 Ft 5.370 1 039610100

3962SH

kettős Shimano küllő húzókulcs



L mm 132 A1 mm 4,3 A2 mm 4,4 Ft 5.150 1 039620010

3962MV

kettős Mavic küllő húzókulcs



L mm 135 A1 mm 4,3 A2 mm 8,4 Ft 5.280 1 039620020

3963P

speciális kulcs lapított küllőkhöz



L mm 129 Ft 2.810 1 039630010

3964

speciális küllőcsavar behajtó kulcs



L mm 170 L1 mm 89 Ft 7.070 1 039640010

3965

sablon 20" és 29" közötti kerekek egyenesfutásának beállításához



L mm 680 Ft 25.900 1 039650010

3965C

professzionális kerék központosító



- 20" és 29" közötti átmérőhöz
- 10 és 20 mm közötti tengelyátmenet adapter

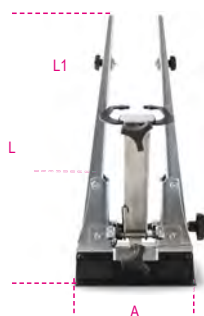

L mm 500 L1 mm 380 A mm 285 Ft 153.800 1 039650110

3967

fogaskerék leszedő láncos kulcs



- 11 sebességes kazettás láncokerekekig kompatibilis
- 2PVC markolat
- Rögzített agyas kerekekhez is használható



L mm 289 Ft 21.850 1 039670010

3969

gumiszerelő vas



L mm 200 A mm 15,6 Ft 3.090 1 039690010

3969K3

3db gumiszerelő, műanyag



L mm 113 Ft 1.700 1 039690130

3971

Shimano műanyag csavar kulcs



- Shimano Hollowtech II hajtóművekhez használható



N° 8 mm 8 Ft 4.520 1 039710010

3972

hajtómű lehúzó kulcs



- alkalmas a Shimano® Hollowtech II, Campagnolo® Ultra-torque, FSA®, SRAM® rendszerekhez



L mm 252 Ft 5.990 1 039720010

3973PF

Press-Fit csapágy lehúzó



- Alkalmas 24 és 30 mm közötti belső átmérőkhöz



L mm 240 Ft 9.380 1 039730001

3973/1

lehúzó dugókulcs 16 bordás hajtóműhöz



- Alkalmas a Shimano® XTR BB93, Dura-Ace® BB9000 rendszerekhez



12" Ø mm 39 mm 24 L mm 34 Ft 7.540 1 039730010

3973/2

lehúzó dugókulcs 16 bordás hajtóműhöz



- Alkalmas a Shimano® BBR60 (Ultegra® 11 sebességes) rendszerekhez

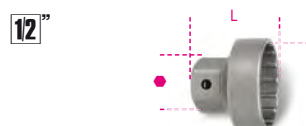

12" Ø mm 41 mm 24 L mm 35 Ft 7.540 1 039730020

3973/3

lehúzó dugókulcs 16 bordás hajtóműhöz



• alkalmas a Shimano® Hollowtech II, Campagnolo® Ultra-torque, FSA®, SRAM® rendszerekhez

12"



Ø int. mm	● mm	L mm	Ft		
46	24	53,5	7.540	1	039730030

3973/4

lehúzó dugókulcs 20 bordás hajtóműhöz
nikkelezett központi csappal



• Alkalmas a Shimano és ISIS rendszerekhez

12"



Ø mm	L mm	● mm	Ft		
31,5	55	24	4.510	1	039730040

3975

kormány és hajtómű összeszerelő prés



• Az 1", 1.1/8", 1.1/4", 1.1/2" és 2" méretű kormányfedelek beszerelésére alkalmas



L mm	Ø mm	Ft		
360	16x1	99.400	1	039750010

3984/1

4 körmös BMX szabadonfutó
lehúzó kulcs

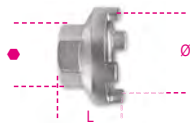

Ø mm	L mm	● mm	Ft		
35	25,5	24	4.090	1	039840010

3984/2

Shimano szabadonfutó lehúzó kulcs



Ø mm	L mm	● mm	Ft		
22,8	26	24	2.270	1	039840020

3984/3

kazettás vezetőcsapos Shimano
szabadonfutó lehúzó kulcs



12"

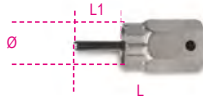

Ø mm	L mm	L1 mm	Ft		
23,5	65	25	4.160	1	039840030

3984/4

vezetőcsapos Campagnolo
szabadonfutó lehúzó kulcs



Ø mm	L mm	L1 mm	● mm	Ft		
23	51	13	24	4.930	1	039840040

3984/5

2 körmös szabadonfutó lehúzó kulcs



12"



Ø mm	L mm	● mm	Ft		
18,5	38	21	3.940	1	039840050

3984/6

4 körmös szabadonfutó lehúzó kulcs



12"



Ø mm	L mm	● mm	Ft		
19,5	36	21	3.940	1	039840060

3991

tárcsafék betét hátrahúzó kar



L mm	A mm	α	Ft		
222	36	7°	13.200	1	039910010

3992

kulcs féktárcsa egyenesbe állításához



L mm	A1 mm	Ft			
234	55	2,2	7.610	1	039920010

Beta

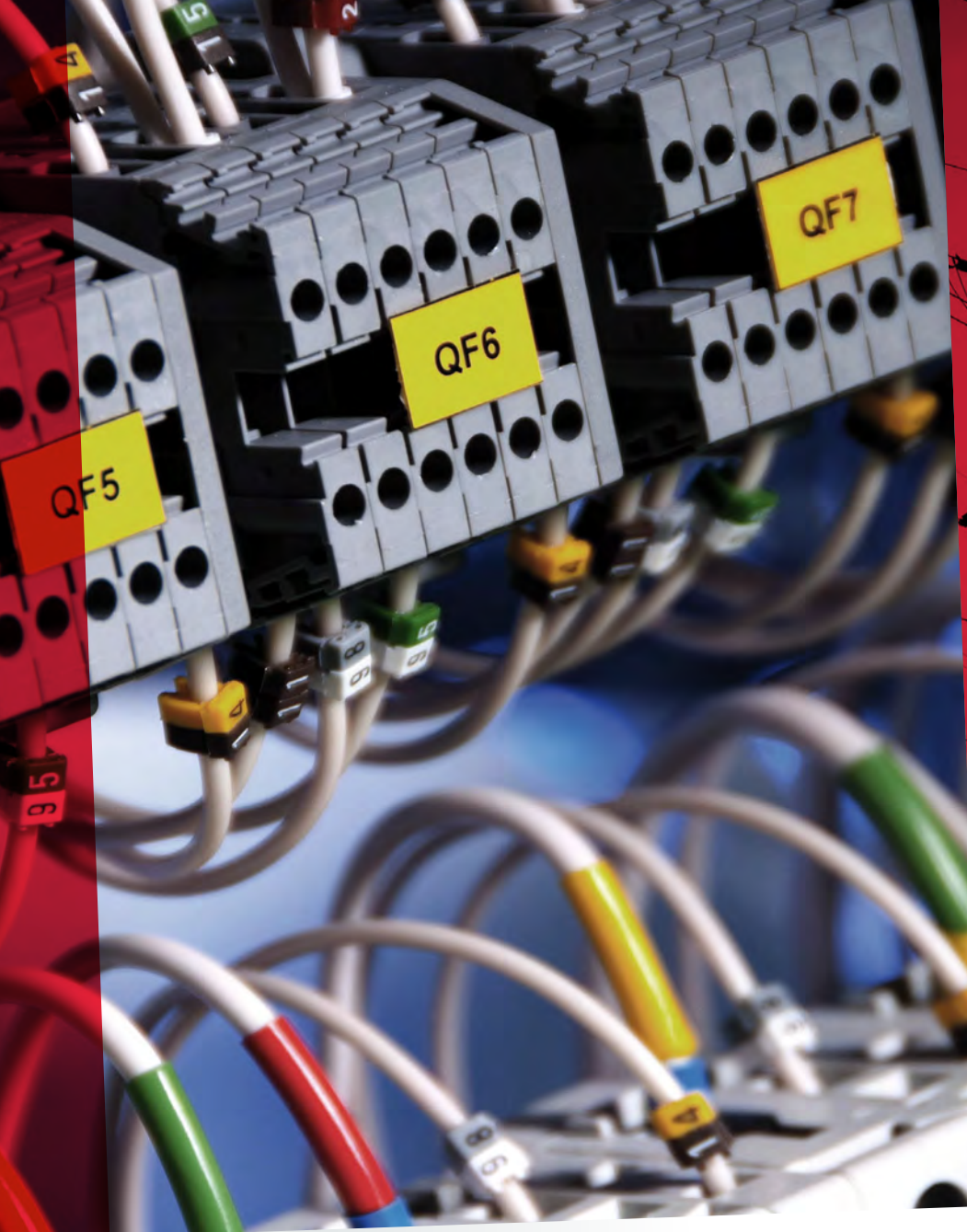

1000V-IG SZIGETELT SZERSZÁMOK

A Beta által gyártott szigetelt szerszámok tervezésénél az elektromossággal kapcsolatos előírásokat tartották szem előtt. Minden szigetelt szerszám lehetővé teszi a munkát feszültség alatti berendezéseken: váltóáramnál 1000 V alatti, egyenáram esetén 1500 V alatti feszültségig. A minőség, a teljesítmény és a használat biztonsága megfelel a 60900-as szabvány előírásainak, minden egyes szerszámot átfogó vizsgálat alá vonnak. Vizsgálják a nyél csúszásmentességét és tűzbiztonságát, valamint a szerszámot 10000 V-os feszültség esetén. A választékra és a hőformált tálcákra vonatkozóan lásd a megfelelő fejezeteket!

A Beta összes szigetelt szerszáma az EN60900 szabvány előírásainak figyelembevételével kerül gyártásra és a legjobb európai tanúsítványkibocsátó hatóságok engedélyezik.



Istituto Italiano del Marchio di Qualità - I



Verband der Elektrotechnik
Elektronik Informationstechnik - D

1000 V

MUNKAVÉDELMI VIZSGÁLATOK: az 1 000 V berendezéseken alkalmazott szerszámainkat 10 000 V-on teszteltük. A Beta minden egyes szigetelt szerszáma 10 kV-os vizsgálaton esik át, ezzel biztosítva a páratlan minőségű munkaeszközök megfelelőségét a legszigorúbb munkabiztonsági előírásoknak. Szerszámainkat akár 1 000 V AC (1 500 V DC) berendezéseken is használhatja.

MUNKAVÉDELMI SZABVÁNYOK:

Amellett, hogy a szerszámaink a gyártás során szigorú ellenőrzéseken esnek át, használat előtt mindig ellenőrizze a szigetelő nyél épségét és győződjön meg, hogy az nem sérült. A szerszámot érő mechanikus és vegyi igénybevétel, illetve a hőfeszültség mértéke szorosan összefügg azzal, hogy az meddig őrzi meg dielektromos tulajdonságait. A szigetelőanyag sérülése esetén a szerszámot már nem lehet biztonságosan használni feszültség alatt lévő berendezéseken. Mindig viseljen védőszemüveget és szigetelt kesztyűt.

GYÁRTÁS SORÁN VÉGZETT ELLENŐRZÉSEK



100% szemrevételezés:

A szerszámok felületének minden látható sérüléstől mentesnek kell lennie.

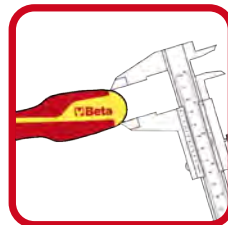

Méretellenőrzés:

A szerszám minden méretének meg kell felelnie a tervezési specifikációknak.



Töréstesztek:

A szerszámot két órán át -25 °C-on tartjuk, majd háromszor ráütünk (ehhez a szabványban meghatározott súlyt használjuk); a szigetelő nyélen semmilyen sérülésnek nem szabad mutatkoznia.

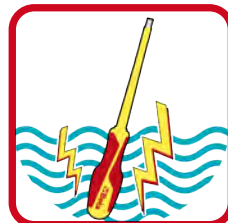

Villamos szigetelésvizsgálat:

A szerszámot 24 órán keresztül vízbe merítjük, majd 3 percig 10 kV feszültségnek tesszük ki. A disszipáció nem haladhatja meg a szabványban meghatározott értékeket.



Penetrációvizsgálat:

A szerszám nyelére +70 °C-on két órán keresztül 2 kg súlyt helyezünk. Később a mechanikus nyomásnak kitétt területbe 3 percen keresztül 5 kV feszültséget vezetünk. Nem haladhat át áram a szerszámon.

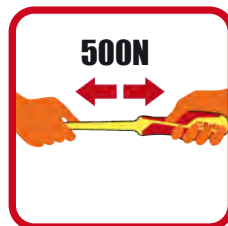

Adhéziós teszt:

A szerszámot 168 órán át +70 °C-on tartjuk, majd 500 N terhelésnek tesszük ki, melynek során a markolata nem csúszhat le.

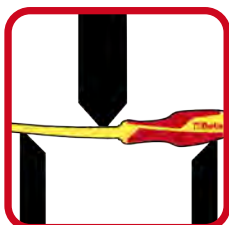

Mechanikai vizsgálat:

A szerszámoknak meg kell felelniük a vonatkozó ISO szabványokban meghatározott mechanikai teljesítmény előírásoknak.



Jelölések kitörölhetetlenségi vizsgálata:

Izopropil alkohollal végzett tapadásvizsgálatot követően a jelöléseknek olvashatóknak kell maradni.



Lángterjedési vizsgálat:

A lángot 10 másodpercig szerszám irányába fordítjuk, majd a következő 20 másodperc során a láng magassága nem haladhatja meg a 120 mm-t.



52MQ

Egyoldalvas villáskulcs



EN 60900

mm	L mm	Ft		
6	90	12.850	1	000520106
7	96	12.850	1	000520107
8	100	12.850	1	000520108
9	108	12.850	1	000520109
10	110	12.850	1	000520110
11	120	12.850	1	000520111
12	132	13.600	1	000520112
13	140	14.050	1	000520113
14	146	14.500	1	000520114
15	166	15.050	1	000520115
16	156	16.350	1	000520116
17	168	16.200	1	000520117
18	170	16.850	1	000520118
19	176	16.650	1	000520119
21	190	18.850	1	000520121
22	200	18.500	1	000520122
24	225	20.150	1	000520124
27	210	27.200	1	000520127
30	240	28.800	1	000520130
32	240	29.300	1	000520132

89MQ

Egyoldalvas csillagkulcs



EN 60900

mm	L mm	Ft		
6	150	16.000	1	000890106
7	155	16.000	1	000890107
8	155	16.000	1	000890108
9	160	16.000	1	000890109
10	170	16.200	1	000890110
11	180	16.650	1	000890111
12	190	18.300	1	000890112
13	195	19.200	1	000890113
14	200	20.400	1	000890114
15	210	21.200	1	000890115
16	216	22.350	1	000890116
17	218	22.550	1	000890117
18	236	23.150	1	000890118
19	240	23.250	1	000890119
21	250	26.350	1	000890121
22	255	27.250	1	000890122
24	280	30.850	1	000890124
27	300	32.200	1	000890127
30	320	37.900	1	000890130
32	340	38.300	1	000890132

110MQ

Állítható villáskulcs skálával



EN 60900

L mm	A max mm	Ft		
200	28	35.250	1	001100520
250	30	38.150	1	001100525
300	30	57.800	1	001100530

606MQ/50

Nyomatékkulcs hangjelzéssel,
irányváltós racsnival



EN 60900
UNI EN 26789
ISO 6789

Nm	Kgfm	lbf.ft	A mm	L mm	g
5÷50	0,5÷5	4÷40	90	375	1130

606MQ/50 Ft 318.700 1 006060705

850MQ

VDE-mágneses betéttartó
bimateriál-nyéllel



IMQ CSV
EN 60900

L mm	L1 mm	D mm	Ft		
233	125	12,5	9.420	1	008500910

910MQ/B

tizenkétszögű dugókulcs



EN 60900

mm	L mm	Ø1 mm	Ø mm	Ft		
6	45	14	24	11.300	1	009100616
7	45	15	24	11.300	1	009100617
8	45	16	24	11.300	1	009100618
9	45	17	24	11.300	1	009100619
10	45	19	24	11.300	1	009100620
11	45	20	24	11.300	1	009100621
12	45	24	24	11.300	1	009100622
13	45	24	24	11.300	1	009100623
14	45	25	24	11.300	1	009100624
15	45	27	24	12.050	1	009100625
16	45	27,5	24	12.050	1	009100626
17	45	30	24	12.500	1	009100627
18	45	31	24	12.500	1	009100628
19	45	32	24	12.500	1	009100629

910MQ/PE

imbusz dugókulcs



EN 60900

mm	Ø mm	L mm	Ft		
4	24	100	15.100	1	009100604
5	24,5	100	15.100	1	009100605
6	25,0	100	15.100	1	009100606
8	25,0	100	15.100	1	009100608
10	25,5	100	15.750	1	009100610

910MQ/TK

dugókulcs

Torx® csavarokhoz



EN 60900

mm	Ø mm	L mm	L1 mm	Ft		
15	23	116	61	18.900	1	009100641
20	24,5	116	65	18.900	1	009100642
25	24,5	116	65	18.900	1	009100643
27	24,5	116	65	18.900	1	009100644
30	24,5	116	65	19.400	1	009100645
40	24,5	116	65	19.600	1	009100646

910MQ/XZN

dugókulcs

XZN® csavarokhoz



EN 60900

mm	Ø mm	L mm	L1 mm	Ft		
M8	24	106	57	18.250	1	009100658
M10	24	106	57	18.550	1	009100660

910MQ/PT

3/8" hosszabbító



EN 60900

Nm	L mm	L1 mm	Ft		
12	80	35,5	98.350	1	009100801

910MQ/21

3/8"-os toldó



EN 60900

L mm	Ø mm	Ft		
140	13,4	22.100	1	009100804

910MQ/22

3/8"-os toldó



EN 60900

L mm	Ø mm	Ft		
265	13,4	24.900	1	009100805

910MQ/T

3/8"-os T-hajtósár

3/8"



Δ 1000 V

EN 60900

L mm 200 L1 mm 165 Ft 25.650 1 009100807

910MQ/55

3/8" irányváltós racsní

3/8"



Δ 1000 V

EN 60900

L mm 203 D mm 41 A mm 67 Ft 71.000 1 009100808

910MQ/C16

8 tizenkét szögű dugókulcs,
4 hatszögű dugókulcs
és 4 tartozék

3/8"



Δ 1000 V

EN 60900

910MQ/C16 Ft 318.200 1 009100917

- 910MQ/B 8 - 10 - 11 - 12 - 13 - 14 - 17 - 19 mm
- 910MQ/PE 4 - 5 - 6 - 8 mm
- 910MQ/21 125 mm
- 910MQ/22 250 mm
- 910MQ/T
- 910MQ/55

914MQ/A

hatszögű dugókulcs,
3/8"-os,
különleges poliamid-alapú technopolimerből

Speciálisan a hibrid és elektromos autók akkumulátoraihoz fejlesztve

Nyomatékkulccsal való használatra

3/8"



Δ 1000 V

EN 60900

Ø mm	Ø mm	L mm	Ø1 mm	Ft		
8	17,5	45	20	7.090	2	009140008
10	20,5	45	20	7.090	2	009140010
13	24	45	20	7.090	2	009140013
17	30	45	22	7.090	2	009140017

3/8"



EN 60900

914MQ-A/S4 Ft 28.350 1 009140054
8-10-13-17 mm

920MQ/A

1/2"-os hatlapú dugókulcs

1/2"



Δ 1000 V

EN 60900

Ø mm	Ø mm	L mm	Ø1 mm	Ft		
8	21,5	57	27,5	11.600	1	009200238
9	21,5	57	27,5	11.600	1	009200239
10	21,5	57	27,5	11.600	1	009200240
11	21,5	57	27,5	11.600	1	009200241
12	23,0	57	27,5	11.600	1	009200242
13	23,0	57	27,5	11.600	1	009200243
14	23,0	57	27,5	11.650	1	009200244
16	23,0	57	27,5	12.200	1	009200246
17	30,0	57	27,5	12.200	1	009200247
18	32,0	57	27,5	12.950	1	009200248
19	32,2	57	27,5	12.950	1	009200249
20	32,0	57	27,5	13.500	1	009200250
21	34,0	57	27,5	14.050	1	009200251
22	36,0	57	27,5	14.050	1	009200252
24	39,0	57	27,5	14.300	1	009200254
27	42,0	57	27,5	14.850	1	009200257
30	44,0	57	27,5	15.150	1	009200260
32	48,0	57	27,5	15.600	1	009200262

920MQ/PE

Imbusz-dugókulcs

1/2"



Δ 1000 V

EN 60900

Ø mm	L mm	L1 mm	Ft		
*4	28,5	94,50	10,5	19.750	1 009200264
*5	28,5	94,5	10,5	19.750	1 009200265
*6	28,5	94,5	10,5	19.750	1 009200266
*8	28,5	94,5	10,5	19.750	1 009200268
10	28,5	94,5	10,5	21.150	1 009200267
12	28,5	94,5	10,5	21.150	1 009200269

920MQ/21

1/2"-os toldó

1/2"



Δ 1000 V

EN 60900

L mm 135 Ø mm 28 Ft 22.900 1 009200804

920MQ/22

1/2"-os toldó

1/2"



Δ 1000 V

EN 60900

L mm 264 Ø mm 30 Ft 26.100 1 009200805

920MQ/T

1/2"-os T-hajtósár

1/2"



Δ 1000 V

EN 60900

L mm 200 L1 mm 163 Ft 26.250 1 009200807

920MQ/55A

1/2"-os irányváltós racsní

1/2"

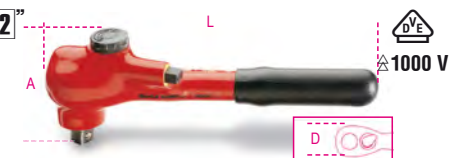

Δ 1000 V

EN 60900

L mm 240 D mm 50 A mm 89 Ft 98.300 1 009200809

920MQ/C16

9 hatlapú dugókulcs
3 imbusz-dugókulcs külső négyszöggel
és 4 tartozék

12"



Δ 1000 V

EN 60900

920MQ/C16 Ft 365.700 1 009200917

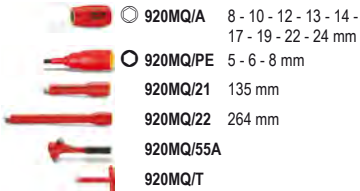

420x280x60 mm - 5,2 kg

943MQ

Hosszú dugókulcs-csavarhúzó



EN 60900

mm	L mm	L1 mm	D mm	Ft		
5,5	233	125	12,2	7.350	1	009430235
6	233	125	12,5	7.350	1	009430236
7	240	125	14,3	7.840	1	009430237
8	240	125	15,3	8.100	1	009430238
10	252	125	17,3	8.360	1	009430240
13	252	125	21,3	9.140	1	009430243

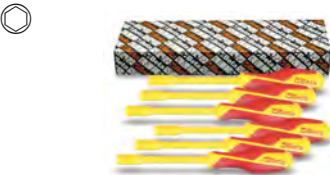

943MQ/S6 Ft 48.150 1 009430250
5,5-6-7-8-10-13 mm

951MQ

T-szárú imbuszkulcs



Δ 1000 V

EN 60900

mm	L mm	L1 mm	Ft		
3	120	105	18.550	1	009510703
* 4	165	105	18.950	1	009510704
* 5	170	105	18.950	1	009510705
* 6	168	105	18.950	1	009510706
* 8	165	105	19.950	1	009510708
10	200	105	21.150	1	009510710

993MQ

Hajlított csapos csipesz lekerekített fogazott hegygel



Δ 1000 V

EN 60900

L mm 147 Ft 16.600 1 009930040

994MQ

Egyenes csipesz erősen lekerekített fogazott hegygel



Δ 1000 V

EN 60900

L mm 145 Ft 15.250 1 009940040

1010MQ

Hosszított kerekcsőrű műszerészfógó, krómzott



Δ 1000 V

EN 60900

L mm 160 L1 mm 51,5 Ft 19.400 1 010100096

1048MQ

Vízpumpafógó, stifttel állítható, szigetelt, 1000V
• krómzott



Δ 1000 V

EN60900

L mm 250 A max mm 48 L1 mm 39 Ft 26.150 1 010480315

1082MQ

Oldalsípőfógó, krómzott



Δ 1000 V

EN 60900

L mm 140 L1 mm 20 $\frac{mm}{mm}$ 1,6 Ft 18.650 1 010820094
160 22 1,6 Ft 19.900 1 010820096

1084MQ

Erősített oldalsípőfógó



Δ 1000 V

EN 60900

L mm 200 L1 mm 26 $\frac{mm}{mm}$ 2,0 Ft 25.450 1 010840100

1088MQ

Erősített homlokcsípőfógó



Δ 1000 V



EN 60900

L mm 160 L1 mm 7 $\frac{mm}{mm}$ 1,6 Ft 23.250 1 010880096

2115P L-MQ32



2115PL-MQ32

350

1128MQ

Műszerészolló, rozsdamentes acél él, mikrofogazattal



Δ 1000 V

IEC60900

L mm 145 L1 mm 45 Ft 19.950 1 011280101

1132MQ

Szigetelt nyelű kábelvágó, réz és alumínium kábel vágásához



Δ 1000 V

EN 60900

L mm 230 $\frac{mm}{mm}$ 18 Ft 36.600 1 011320193

1142MQ

Kábelcsupaszoló fogó, krómozott



EN 60900

L mm	mm ²	Ft	1	011420096
160	0,5÷6	21.950		

1150MQ

Kombinált fogó, krómozott



EN 60900

L mm	L1 mm	mm	Ft	1	011500096
160	37	1,6	15.600		
180	39	1,8	16.900		011500098
200	43	2,0	17.750		011500100
220	46	2,0	19.050		011500102

1162MQ

Egyenes laposfogó, extra hosszú, krómozott



EN 60900

L mm	L1 mm	mm	Ft	1	011620096
160	56	1,6	16.800		011620096
200	76	1,6	17.950		011620100

1164MQ

Hajlított extra hosszú laposfogó



L mm	L1 mm	mm	Ft	1	011640096
160	54	1,6	17.350		011640096
200	76	1,6	18.850		011640100

1166MQ

Egyenes félkerékcserő fogó, extra hosszú, krómozott



EN 60900

L mm	L1 mm	mm	Ft	1	011660096
160	56	1,6	16.800		011660096
200	76	1,6	17.950		011660100

1168MQ

Hajlított félkerékcserő fogó, extra hosszú, krómozott



EN 60900

L mm	L1 mm	mm	Ft	1	011680096
160	50	1,6	17.350		011680096
200	70	1,6	18.850		011680100

1272MQF

csavarhúzók keresztfejű Phillips® csavarokhoz

Slim



EN60900

PHxDxL mm	L1 mm	Ft	3	012720609
1x4,5x80	187	4.180		
2x6x100	218	4.730		012720618

1272MQ

Phillips®-csavarhúzó



EN 60900

PHxDxL mm	L1 mm	Ft	3	012720703
0x3x60	160	3.340		
1x4,5x80	187	4.050		012720709
2x6x100	218	4.670		012720718
3x8x150	276	5.980		012720724
4x10x200	326	7.050		012720727



Ft	1	012720751
25.100		

1272MQ/S5
PH0x3x60-PH1x4,5x80
PH2x6x100-PH3x8x150
PH4x10x200 mm

Beta
Quality Tools

1273MQF/D...

6 darabos slim csavarhúzókészlet



1273MQF/D4	Ft	1	012730604
1272MQF	1x4,5x80-2x6x100 mm		
1274MQF	0,6x3,5x100-1x5,5x125 mm		

1273MQF/D6	Ft	1	012730606
1272MQF	1x4,5x80-2x6x100 mm		
1274MQF	0,6x3,5x100-1x4,5x100- 1x5,5x125-1,2x6,5x150 mm		

1273MQ/D6

6 csavarhúzó



1273MQ/D6	Ft	1	012730851
1274MQ	0,5x3x100 -0,8x4x100 1,0x5,5x125 mm		
1272MQ	PH0x3x60 -PH1x4,5x80 PH2x6x100 mm		

1274MQF

csavarhúzók hernyócsavarokhoz



EN60900

SxDxL mm	L1 mm	Ft	3	012740603
0,6x3,5x100	200	4.020		
1x4,5x100	205	4.520		012740606
1x5,5x125	232	4.720		012740609
1,2x6,5x150	268	5.670		012740612

1274MQ

Villanszerelő csavarhúzó

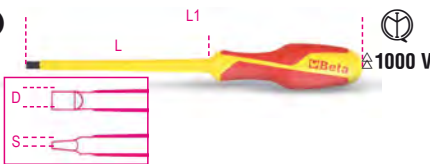

EN 60900

SxDxL mm	L1 mm	Ft	3	012740700
0,4x2,5x75	175	3.200		
0,5x3x100	200	3.360		012740703
0,8x4x100	207	3.940		012740706
1x5,5x125	232	4.300		012740709
1,2x6,5x150	268	5.110		012740712
1,2x8x175	301	6.140		012740715
1,6x10x200	326	7.000		012740718

**1274MQ/S6**

0,5x3x100-0,8x4x100
1x5,5x125-1,2x6,5x150
1,2x8x175-1,6x10x200 mm

Ft 29.850
1 012740751

1275MQ/C

kombinált csavarhúzó PH keresztornyos +
egyeses hornyú csavarokhoz

keskeny



EN60900

PH1+LPP	Ft	1	012750409
PH2+LPP	Ft	2	012750418

1276MQ/C

kombinált csavarhúzó PZ keresztornyos +
egyeses hornyú csavarokhoz

keskeny

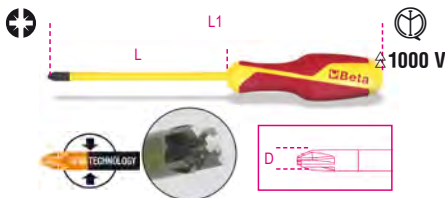

EN 60900

PZ1+LPP	Ft	2	012760409
PZ2+LPP	Ft	2	012760418

1279MQ/F

csavarhúzó Pozidriv®-Supradriv®
keresztornyos csavarokhoz

keskeny



EN60900

pz	L mm	L1 mm	Ft	1	012790409
1	80	187	4.000	3	012790409
2	100	218	4.390	3	012790418

1279MQ

Pozidriv®- és Supradriv® csavarhúzó



EN 60900

PZ	L mm	L1 mm	Ft	1	012790703
0	60	160	3.460	3	012790703
1	80	187	4.120	3	012790709
2	100	218	4.760	3	012790718
3	150	276	6.080	2	012790724



1279MQ/S4 Ft 18.400
PZ 0-1-2-3 1 012790751

1725MQ

Fűrész



EN 60900

1725MQ	L mm	H mm	Ft	1	017250030
	260	85	36.650		

1777MQ/C

Kábelkés

• többeres kábelhez



EN 60900

1777MQ/C	L mm	Ft	1	017770026
	190	15.000		

1777MQ/U

Kábelkés



EN 60900

1777MQ/U	L mm	Ft	1	017770011
	190	12.750		

1777RL/U

4 Tartalékpenge a 1777MQ/U modellhez

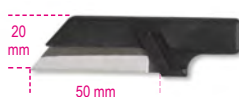

1777RL/U	Ft	1	017770021
	10.750		

1995MQ/T

Szigetelő aláfekvő

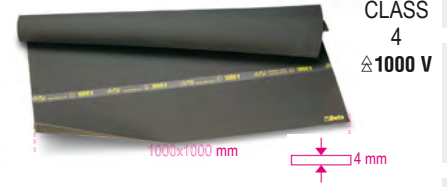
VDE 0303
EN 60243

1995MQ/T	LxSxH mm	Ft	1	019950030
	1000x1000	124.000		

1995MQ/G1 - G2

Szigetelt védőkesztyű



EN 60903

1995MQ/G1	Gr.	L mm	Ft	1	019950010
1995MQ/G2	10	410	49.700	1	019950013

1996MQ/T

szigetelt szövet

500x500mm

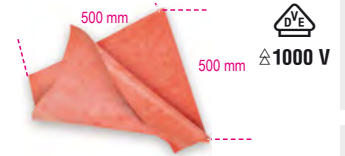

DIN EN 61112

1996MQ/T	S mm	Ft	1	019960005
	1.0	39.700		

1996MQ/GM

kompozit szigetelt védőkesztyű

EN60903
EN388EN 60903
EN 61482

1996MQ/GM 9	Gr.	L mm	Ft	1	019960109
1996MQ/GM 10	10	410	68.250	1	019960110

1996SVG

pneumatikus vizsgáló szigetel
védőkesztyűkhöz
az EN90603 szabvány szerinti kötelező vizsgálat



1996SVG	Ft	1	019960133
	159.800		



LEESÉSVÉDETT SZERSZÁMOK

Beta H-SAFE

A Beta H-SAFE szerszám választék több mint 200 terméket tartalmaz, melyek megtartó rendszere egyedileg tervezett, hogy ellenálljon az extrém mechanikai igénybevételnek a páratlan biztonság színvonalájaként.

Használhatóság szempontjából fontos a kényelem is, ezért a kettős aktív részből álló szerszámok, mint a 42-es számú csillagvilláskulcs, egy olyan huzal segítségével csatlakoznak, amely végigfuthat a szerszámtesten, míg a csavaró mozgással használt szerszámok, mint például a csavarhúzó esetében egy szabadon elforduló gyűrűvel csatlakoznak, ami megakadályozza a rögzítőhuzal felcsavarodását.



A H-SAFE rendszert a Beta üzemeiben tervezték, tesztelték és gyártották. A Beta H-SAFE biztonsági rendszer segítségével a szerszámok kényelmes és biztonságos módon mindig kéznél vannak.

35HS

Erősített laposvágó, krómozott H-SAFE



L mm	A mm	Ft	🔧	📦
200	23,0	16.500	1	000354004
250	28,5	20.100	1	000354005

42HS

Csillag-villáskulcs, krómozott H-SAFE



DIN 3113 UNI-ISO 7738

🔧 mm	L mm	Ft	🔧	📦
6x6	95	7.010	1	000424506
7x7	105	7.080	1	000424507
8x8	116	7.180	1	000424508
9x9	127	7.340	1	000424509
10x10	137	7.550	1	000424510
11x11	148	7.580	1	000424511
12x12	158	7.740	1	000424512
13x13	169	7.810	1	000424513
14x14	180	8.270	1	000424514
15x15	190	8.470	1	000424515
16x16	201	8.750	1	000424516
17x17	212	9.140	1	000424517
18x18	222	9.340	1	000424518
19x19	233	9.550	1	000424519
20x20	243	9.960	1	000424520
21x21	254	10.350	1	000424521
22x22	264	10.800	1	000424522
23x23	275	11.100	1	000424523
24x24	285	11.650	1	000424524
25x25	296	11.950	1	000424525
26x26	307	12.400	1	000424526
27x27	317	13.200	1	000424527
28x28	328	13.350	1	000424528
29x29	338	14.500	1	000424529
30x30	349	15.000	1	000424530
32x32	370	16.400	1	000424532
34x34	391	26.450	1	000424534
36x36	412	29.550	1	000424536

42HS/AS

Csillag-villáskulcs, krómozott H-SAFE



🔧 mm	L mm	Ft	🔧	📦
1/4x1/4	95	7.610	1	000424106
5/16x5/16	116	7.770	1	000424108
3/8x3/8	137	8.110	1	000424110
7/16x7/16	148	8.380	1	000424111
1/2x1/2	169	8.470	1	000424113
9/16x9/16	180	8.600	1	000424114
5/8x5/8	201	9.430	1	000424116
11/16x11/16	212	9.780	1	000424117
3/4x3/4	233	10.150	1	000424119
13/16x13/16	254	11.400	1	000424121
7/8x7/8	264	11.600	1	000424122

Ø	L mm	Ft	1	000424124
15/16x15/16	285	13.050	1	000424124
1x1	296	13.350	1	000424125
1.1/16x1.1/16	317	14.500	1	000424127
1.1/8x1.1/8	338	15.250	1	000424129
1.1/4x1.1/4	370	18.300	1	000424132
1.5/16x1.5/16	391	22.550	1	000424133

55HS

Villáskulcs, krómozott H-SAFE



UNI-ISO 10102 DIN 3110

Ø	L mm	Ft	1	000554012
6x7	120	5.510	1	000554012
8x9	140	5.620	1	000554021
10x11	155	5.890	1	000554030
12x13	170	6.200	1	000554042
14x15	185	6.630	1	000554054
16x17	202	7.030	1	000554060
18x19	220	7.440	1	000554066
20x22	236	8.060	1	000554075
21x23	245	8.290	1	000554078
22x24	245	8.910	1	000554081
24x27	262	9.690	1	000554090
30x32	297	12.050	1	000554108
34x36	325	27.600	1	000554117

91HS-C

Feltűző csillagkulcs, krómozott H-SAFE



Ø	Ø	Ft	1	000914036
mm	mm			
36	54	37.900	1	000914036
41	62	44.150	1	000914041
46	69	49.250	1	000914046

91HS

Feltűző csillagkulcs, krómozott H-SAFE



Ø	Ø	Ft	1	000914236
mm	mm			
36	54	74.250	1	000914236
41	62	80.500	1	000914241
46	69	92.100	1	000914246

92HS

Csőtoldatok a 91. típusú kulcsokhoz,
krómozott H-SAFE



L	91	Ø	Ft	1	000924020
mm	mm	mm			
610	32+41	22	36.350	1	000924020
760	46+55	25	42.850	1	000924030

93HS

Állványozó csillagkulcs állványcsavarokhoz,
krómozott H-SAFE



Ø	L	Ft	1	000934021
mm	mm			
21x22	310	22.600	1	000934021

96TBP-HS

hajlított gömbfejű imbuszkulcsok nagy
nyomatékú T-markolattal,
H-SAFE



Ø	L	L1	Ø	Ft	1	000964685
mm	mm	mm	mm			
2,5	153	55	4	11.050	1	000964685
3	153	55	4	11.450	1	000964686
4	179	70	5	11.650	1	000964687
5	200	84	6	11.850	1	000964688
6	221	103	7	12.650	1	000964689
8	255	117	10	14.700	1	000964690
10	285	132	12	16.150	1	000964692

96THS

T-szárú imbuszkulcs,műanyag markolattal
H-SAFE

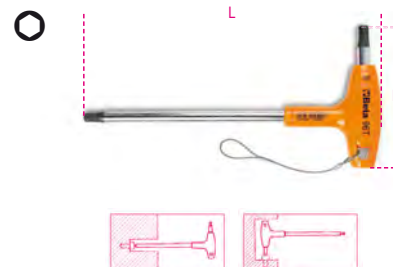

mm	L	L1	Ft	1	000964935
	mm	mm			
2,5	153	55	10.200	1	000964935
3	153	55	10.350	1	000964936
4	179	70	10.600	1	000964938
5	200	84	10.800	1	000964940
6	221	103	11.550	1	000964941
8	255	117	13.700	1	000964943
10	285	132	15.150	1	000964945

96THS-AS

T-szárú imbuszkulcs,műanyag markolattal
H-SAFE



Ø	L	L1	Ø	Ft	1	000964673
"	mm	mm	mm			
5/32	200	84	6	11.500	1	000964673
3/16	200	84	6	11.500	1	000964674
7/32	221	103	7	12.750	1	000964675
1/4	236	106	8	13.200	1	000964676
5/16	255	117	10	14.350	1	000964678
3/8	285	132	12	15.700	1	000964680

97TTXHS

T-szárú Torx®-imbuszkulcs, műanyag
markolattal, krómozott, fekete hegyek H-SAFE

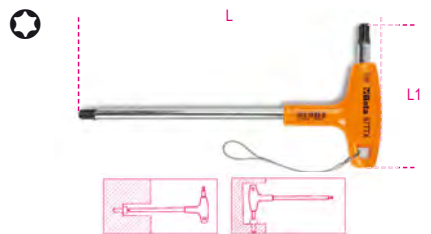

Ø	L	L1	Ft	1	000974710
	mm	mm			
T10	179	70	10.350	1	000974710
T15	179	70	10.550	1	000974715
T20	179	70	10.800	1	000974720
T25	179	70	11.050	1	000974725
T30	200	84	12.450	1	000974730
T40	221	103	13.300	1	000974740
T45	236	106	14.500	1	000974745
T50	255	117	17.400	1	000974750

111E-HS

állítható villáskulcs skálával, krómozott

H-SAFE

- Jobbmenetes orsó
- Mm/coll skála



DIN 3117 ISO 6787

L	L	A max	Ft	1	001114120
mm	"	mm			
200	8	29	17.550	1	001114120
250	10	34	19.900	1	001114125
300	12	40	24.600	1	001114130
380	15	45	42.000	1	001114138
450	18	54	66.450	1	001114145

142HS

Csillag-villáskulcs irányváltós racsnival
H-SAFE



Ø mm	L mm	Ft	■	📄	📁
8x8	136	13.000		1	001424008
9x9	143	13.400		1	001424009
10x10	159	13.650		1	001424010
11x11	168	13.900		1	001424011
12x12	174	14.100		1	001424012
13x13	180	14.550		1	001424013
14x14	190	14.900		1	001424014
15x15	200	15.600		1	001424015
16x16	216	16.700		1	001424016
17x17	233	16.950		1	001424017
18x18	239	17.850		1	001424018
19x19	248	18.100		1	001424019
21x21	285	22.000		1	001424021
22x22	285	22.400		1	001424022
24x24	325	25.650		1	001424024
27x27	355	34.300		1	001424027
30x30	420	39.600		1	001424030
* 32x32	420	41.400		1	001424032

360HS

„Stillson” csőfogó kovácsolt acélból H-SAFE



L mm	Ø max "	Ft	■	📄	📁
250	1" gas	20.850		1	003604025
350	1 1/2" gas	26.100		1	003604035
450	2" gas	33.850		1	003604045
600	2 1/2" gas	48.400		1	003604060



LC system,
kétgolyós biztosító rendszer,
a kulcs csak gombnyomásra old

666HS

Kioldó nyomatékkulcs
Irányváltós racsnival
Jobb oldali meghúzáshoz
Pontosság: ± 3%



ISO 6789

Nm	Kgfm	lbf.ft	■	D mm	A mm	L mm	■	g
10÷50	1÷5	7÷37	3/8	30	33	312		660

666HS/5 Ft 108.500 1 006664005

Nm	Kgfm	lbf.ft	■	D mm	A mm	L mm	■	g
20÷100	2÷10	15÷75	3/8	30	33	381		730

666HS/10 Ft 110.400 1 006664010

Nm	Kgfm	lbf.ft	■	D mm	A mm	L mm	LC system	■	g
40÷200	4÷20	30÷150	1/2	40	43	470	system*		1010

666HS/20LC Ft 124.000 1 006664021

Nm	Kgfm	lbf.ft	■	D mm	A mm	L mm	LC system	■	g
60÷300	6÷30	50÷220	1/2	40	43	598	system*		1380

666HS/30LC Ft 138.500 1 006664031

900E-HS/55

rányváltós racsni H-SAFE



DIN 3122 - UNI-ISO 3315

L mm	Ø mm	A mm	■	Ft	■	📄	📁
125	25	18	1/4	19.350		1	009004880

910E-HS/55

rányváltós racsni H-SAFE

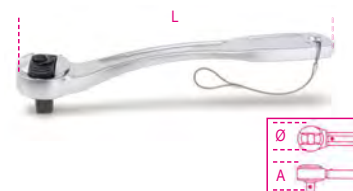

DIN 3122 - UNI-ISO 3315

L mm	Ø mm	A mm	■	Ft	■	📄	📁
200	30	33	3/8	22.750		1	009104880

920E-HS/55LC

rányváltós racsni H-SAFE Locking system

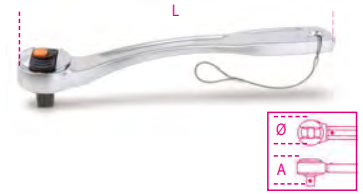

DIN 3122 - UNI-ISO 3315

L mm	Ø mm	A mm	■	Ft	■	📄	📁
275	40	43	1/2	33.250		1	009204860

932HS

Tizenkétszögű pipakulcs, fényes krómozott
H-SAFE

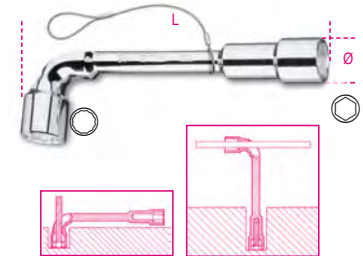

NF E 74.303

Ø mm	L mm	Ft	■	📄	📁
6x6	11,5	110	11.150	1	009324006
7x7	12,5	116	11.400	1	009324007
8x8	13,0	120	11.900	1	009324008
9x9	14,0	125	12.050	1	009324009
10x10	16,5	133	12.550	1	009324010
11x11	17,5	143	13.150	1	009324011
12x12	19,0	148	13.650	1	009324012
13x13	19,5	154	13.850	1	009324013
14x14	21,5	167	14.450	1	009324014
15x15	22,5	182	15.050	1	009324015
16x16	24,5	193	15.500	1	009324016
17x17	26,0	198	15.700	1	009324017
18x18	26,5	215	16.900	1	009324018
19x19	29,0	220	18.100	1	009324019

1032HS

Egyenes belső Seeger-fogó, barnított, PVC-
bevonattal H-SAFE



UNI 7914 DIN 5256

L mm	Ø mm	Ø1 mm	A mm	Ft	■	📄	📁
140x1,3	12÷25	1,3	20	15.250	1	010324014	
180	19÷60	1,9	21	16.250	1	010324017	

 **Beta**

1034HS

90°-os hajlított belső Seeger-fogó, barnított, PVC-bevonattal H-SAFE



UNI 7914 DIN 5256

L	Ø	Ø1	A	Ft		
mm	mm	mm	mm			
170	19+60	1,9	21	17.200	1	010344017

1036HS

Egyenes külső Seeger-fogó, barnított, PVC-bevonattal H-SAFE



UNI 7915 DIN 5254

L	Ø	Ø1	A	Ft		
mm	mm	mm	mm			
140x1,3	10=25	1,3	20	16.250	1	010364014
175	19+60	1,9	21	16.700	1	010364017

1038HS

90°-os hajlított külső Seeger-fogó, barnított, PVC-bevonattal H-SAFE



UNI 7915 DIN 5254

L	Ø	Ø1	A	Ft		
mm	mm	mm	mm			
175	19+60	-	21	17.650	1	010384017

1048BM-HS

Vízpumpafogó, villás, bimateriál nyél H-SAFE

- Új modell új pozíciókkal
- Bimateriál-nyél

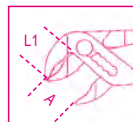

ISO 8976

L	A max	L1	g	Ft		
mm	mm	mm				
250	48	39	460	24.900	1	010484215

1052HS

Állítható önzáró fogó, homorú pofájú, krómozott H-SAFE

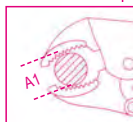

L	A	A1 max	S	Ft		
mm	mm	mm	mm			
240	72	42	10,0	19.950	1	010524024

1082BM-HS

Oldalsípőfogó, krómozott, gumibetétes műanyag nyéllel H-SAFE

1088BM-HS

Erősített homlokcsípőfogó, krómozott, gumibetétes műanyag nyéllel H-SAFE

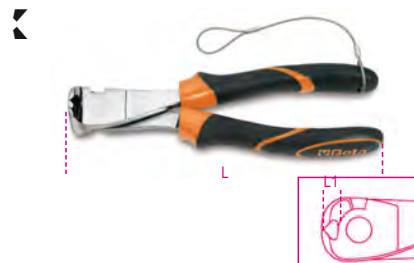

UNI/ISO 5748

L	L1	mm	A	Ft		
mm	mm	mm	mm			
160	9	1,6	28,0	23.800	1	010884036
200	11	2,0	36,0	29.900	1	010884040

1128BAX-HS

kettős hatású villanszerelő olló, lépcsős profil, rozsdamentes acél, DLC bevonat H-SAFE

kettős hatású vágás: egy különleges bütyökkel a forgásponton létrejön a pengék hosszirányú elmozdulása, amely a zárási fázisban megnöveli a vágási teljesítményt.

lépcsős profil: 13 és 24 mm közötti furatok tágitására létrehozva műanyagokon.

DLC bevonat; A DLC (diamond-like carbon) egy újszerű, szénalapú bevonat: a nagyfokú keménység és az alacsony súrlódási együttható a felületen a grafit és gyémánt formában lerakódott szénnek köszönhető.

- nagy felületi keménység a pengénél (nagy kopásállóság és időtálló pengeélesség)
- alacsony súrlódási együttható (gördülékenység és vágási teljesítmény)
- kilazulásbiztos excentrikus csap
- széles markolat csőfogó nyakkal
- rugalmas műanyag tokkal



L	L1	mm	Ft		
mm	mm	mm			
150	50	50	18.100	1	011284088



UNI/ISO 5749

L	L1	mm	A	Ft		
mm	mm	mm	mm			
160	22	1,6	28,0	20.750	1	010824036



1132BM-HS

Kábelvágó, krómozott, gumibetétes műanyag nyéllel H-SAFE



UNI 8791

L	mm	A	B	Ft	1	011324143
230	18	37	12,5	36.550		

1150BM-HS

Kombinált fogó, krómozott, polírozott, gumibetétes műanyag nyéllel H-SAFE



ISO 5746

L	L1	mm	A	Ft	1	011504146
160	42	1,6	22,0	18.000		
180	46	1,8	25,0	18.750		
200	50	2,0	27,0	19.950		

1166BM-HS

Egyenes extra hosszú félkerécsőrű fogó, krómozott, gumibetétes műanyag szárral H-SAFE



ISO 5745

L	L1	mm	A	Ft	1	011664040
200	76	1,6	22,0	18.350		

1168BM-HS

Hajlított extra hosszú félkerécsőrű fogó, krómozott, gumibetétes műanyag szárral H-SAFE



ISO 5745

L	L1	mm	A	Ft	1	011684040
200	70	1,6	22,0	19.450		

1290HS

Phillips®-csavarhúzó H-SAFE

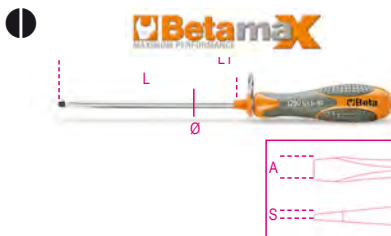

ISO 2380

SxAxL	L1	Ø	Ft	1	012904006
0,4x2,5x75	171	2,5	6.170		
0,5x3x100	196	3,0	6.420		
0,6x3,5x100	196	3,5	6.790		
0,8x4x100	196	4,0	6.790		
0,8x4x150	246	4,0	7.160		
1x5,5x150	259	5,0	8.210		
1,2x6,5x150	270	6,0	8.640		
1,2x8x150	282	7,0	9.580		
1,6x10x200	332	8,0	11.000		

1292HS

Csavarhúzó Phillips®-csavarokhoz H-SAFE



UNI/ISO 8764

PHxDxL	L1	Ft	1	012924006
0x3x100	196	6.320		
1x4,5x120	229	7.330		
2x6x150	270	8.840		
3x8x150	282	10.150		

1294HS

Csavarhúzó hernyócsavarokhoz H-SAFE



SxDxL	L1	Ft	1	012944003
0,5x2,5x60	156	5.980		
0,6x3x75	171	6.040		
0,8x4x100	196	6.830		
1x5x125	234	7.940		

1299HS

Csavarhúzó Pozidriv®- és Supadriv®-csavarokhoz H-SAFE



UNI/ISO 8764

PZ	L	L1	Ft	1	012994000
0	60	156	6.820		
1	80	189	7.700		
2	100	220	9.530		
3	150	282	12.150		

1370T-HS

Lakatos kalapács német modellműanyag nyéllel H-SAFE



g	A	L	L1	Ft	1	013704630
300	23	300	105	15.250		
500	27	320	118	16.550		
1000	36	360	135	20.250		

Beta

Beta

1370FT-HS

Lakatos kalapács, francia modell, műanyag nyéllel H-SAFE



A	L	L1	B	Ft		
28	280	86	22	20.850	1	013704528
30	280	92	24	21.050	1	013704530
36	300	104	29	24.900	1	013704536

1390HS

Műanyag kalapács, cserélhető végekkel, fanyéllal H-SAFE



UNI 7784

D	L	L1	Ft		
35	310	95	18.950	1	013904035
45	320	107	27.500	1	013904045

1392HS

Ütéselnyelő műanyag kalapács, cserélhető végekkel, acélnyéllal



D	L	L1	Ft		
35	305	115	28.100	1	013924035
40	310	125	31.050	1	013924040
50	325	135	36.150	1	013924050
60	385	155	52.800	1	013924060

1602A-HS

Saruzófógo szigetelt kábelsarukhoz, standard modell, krómazott, műanyag szárral H-SAFE

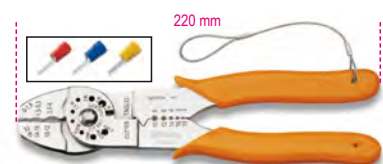

L	A	B	Ft		
220	42	4	30.150	1	016024005

1682HS

Rugalmas skálás vonalzó, rozsdamentes acélból H-SAFE

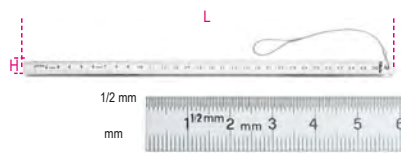

L	H	±	Ft		
200	13	0,5	6.360	1	016824020
300	13	0,5	7.140	1	016824030

1692HS

Mérőszalag, ütészálló bimateriál ABS-ház, acélszalag, pontossági osztály: II H-SAFE



L	S	Ft		
3	16	8.990	1	016924053
5	19	10.650	1	016924055

1708HS/20

Metrikus hézagmérő H-SAFE

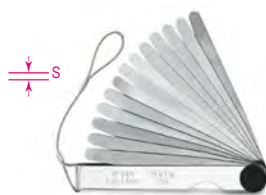

s	S	L	Ft		
0,05±1,0	0,002±0,040	105	9.910	1	017084020

1727HS

Erősített fűrész, fűrészkeret lakkozott acélból, fanyéllal, bimetal fűrészlappal H-SAFE

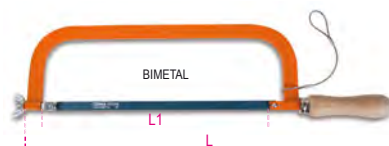

L	L1	Ft		
515	300	13.500	1	017274001

1743HS

Kábelkötégetelő fogó H-SAFE

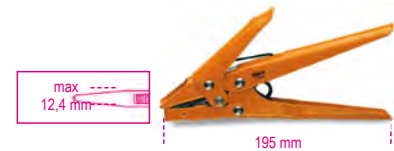

L	A	B	Ft		
195	85	17	28.700	1	017434001

1750HS

Karoszsírzó H-SAFE



1 g, 550 bar Max

cc	L	Ft		
500	380	14.950	1	017504500

1760BHS

Univerzális digitális multiméter H-SAFE



VÉGREHAJTHATÓ MÉRÉSEK

Feszültség DC: 200 mV-2/20/200/1000V
 Feszültség AC: 2-20/200/700V
 Áram DC: 2/20/200 mA-20 A
 Áram AC: 2/200 mA- 20 A
 Ellenállás: 200Ω - 2/20/200 kΩ - 2/20 MΩ
 Kapacitás: 2/20/200 nF - 2/200 μF
 Hőmérséklet: -20° + 1000°C/ -4 °F ~ +2000°F
 Frekvencia: 20kHz
 Tápegység: 1 9V-elem (együtt szállítva)

L	Ft		
1760BHS	90.750	1	017604012

1772H-HS

Kés behúzóval, 1 tartalék pengével
H-SAFE



L mm	A mm	Ft		
170	18	12.000	1	017724029

1778SOS-HS

autós elsősegély kés,
ablaktörő kalapács és
biztonsági öv vágó funkcióval,
tokban,
H-SAFE



L mm	A mm	L1 mm	Ft	
205	25	85	19.200	1 017784080

8871

Biztonsági öv, fémcstanggal és dupla zárral



L cm min-max	Ft		
70-100	55.150	1	088710070
100-135	60.350	1	088710100

8872A

Merev szíj

• 8871 övhöz



L cm	Ft		
20-140	9.820	1	088720050

8872AS

A zár húzással nyílik

• 8871 övhöz



D mm	Ft		
25	8.570	1	088720525

8873

Munkaeszköz hordozó zsák önzáró és
zipzáras zárral

• 8871 övhöz



Ft		
44.500	1	088730230

8877

Amortizált csatoló heveder

• MAX 2.7 kg



L cm min-max	DxL mm	Ft	
70-110	40x80	11.400	1 088770080

8877M

Amortizált csatoló heveder

• Tekeredés megelőző csatlakozóval • MAX 2.7 kg



L cm min-max	DxL mm	Ft	
20-140	30x60	21.400	1 088770510

8879

Csuklóvédő húzással nyílik

• MAX 2.7 kg



D mm	Ft		
30	13.300	1	088790025

8880

Merev csatoló heveder

• Tekeredés megelőző csatlakozóval



L Cm	D mm	Ft	
30	10	10.450	1 088800030

8883

Munkaeszköz hordozó zsák

• 840-es, dörzsölés megelőző nylon • MAX 20 kg • A zipzárt
a zárvegen blokkoló karabéllyal • 6 munkaeszköz rögzítő
hevederrel • Belső zsebbel



DxH cm	Ft		
30x40	108.300	1	088830030





NEMESACÉL SZERSZÁMOK



A Beta Inox szerszámokat olyan speciális helyeken használják, ahol a korrózió nem megengedett.

Néhány példa:

- Nukleáris területek
- Gyógyszeripar - C osztály
- Vegyes külszíni munka
- Biotechnológiai és bio orvostudományi laboratóriumok
- Élelmiszeripar

A Beta Inox szerszámok nem rozsdásodnak.

A nem rozsdamentes anyagokból készített szerszámok használata során a csavarokon és anyákon a részecskék leválnak, a korróziós folyamat megindul és ez esztétikai problémát és néhány esetben strukturális problémát is okoz.

Felhasználási területek:

- Hajóépítés,
- Építőipar,
- Szolárberendezések,
- Autóipar.



ROZSDAMENTES
ACÉL
+ NEM
ROZSDAMENTES
ACÉL SZERSZÁM=
ROZSDA



ROZSDAMENTES
ACÉL
+ ROZSDAMENTES
ACÉL SZERSZÁM=
NINCS
ROZSDA

TULAJDONSÁGAI

Az anyagok gondos megválasztása és a jobb hőkezelés a Beta Inox szerszámoknak olyan mechanikai tulajdonságokat kölcsönöznek, amelyek közül néhány - az átlagos Beta szerszámok tulajdonságaival összehasonlítva - azokat felülmúlja.

A termékek ergonómiája és dizájnya ugyanaz, mint a több mint 75 éve ismert és a felhasználók által nagyra értékelt Beta szerszámoké.

Fontos tulajdonság továbbá, hogy a rozsdamentes acél 100%-ban újrahasznosítható.



Rozsdamentes acélból készült termékek logója. A Centro Inox - az Olasz Rozsdamentes Acél Fejlesztési Szövetség - által kiadott logó, amely védjegyzí a rozsdamentes acélból készült termékeket.

34INOX

Laposvágó,
rozsdamentes acélból



L	A	Ø	Ft		
mm	mm	mm			
160	18	18	14.500	1	000340318
200	20	20	21.500	1	000340320

39INOX

Támasztóék,
rozsdamentes acélból



L	A	S	Ft		
mm	mm	mm			
100	50	10	9.680	1	000390310
150	50	13	18.050	1	000390315
200	40	40	54.500	1	000390320

42INOX

Csillag-villáskulcs,
rozsdamentes acélból

- Keskeny fejek
- Nagy korrózióállóság
- Kiváló műszaki tulajdonságok



DIN 3113 - UNI ISO 7738

Ø	L	Ft		
mm	mm			
6x6	95	4.780	2	000420306
7x7	105	4.880	2	000420307
8x8	116	5.010	2	000420308
9x9	127	5.750	2	000420309
10x10	137	5.880	2	000420310
11x11	148	6.090	2	000420311
12x12	158	6.290	2	000420312
13x13	169	6.510	2	000420313
14x14	180	6.870	2	000420314
15x15	190	7.010	2	000420315
16x16	201	7.220	2	000420316
17x17	212	7.810	2	000420317
18x18	222	9.050	2	000420318
19x19	233	9.350	2	000420319
21x21	254	13.650	1	000420321
22x22	264	14.300	1	000420322
24x24	285	15.850	1	000420324
27x27	290	45.550	1	000420327
30x30	320	55.250	1	000420330
32x32	340	61.100	1	000420332
36x36	360	86.350	1	000420336
38x38	430	91.900	1	000420338
41x41	430	107.300	1	000420341
46x46	480	124.500	1	000420343
50x50	520	133.200	1	000420345
55x55	560	145.500	1	000420347
60x60	595	162.800	1	000420350



L	Ft		
mm			
42INOX/S11	72.800	1	000420391
6-8-10-11-12-13-14-15-16-17-19 mm			



Ft		
63.550	1	000420387
42INOX/SC9 8-10-11-12-13-14-15-17-19 mm		
42INOX/SCV9	3.380	1 000420303

42INOX-AS

Csillag-villáskulcs,
rozsdamentes acélból



Ø	L	Ft		
mm	mm			
1/4x1/4	95	5.810	1	000420356
5/16x5/16	116	6.030	1	000420358
3/8x3/8	137	7.310	1	000420360
7/16x7/16	148	7.800	1	000420361
1/2x1/2	169	7.980	1	000420363
9/16x9/16	180	8.620	1	000420364
5/8x5/8	201	9.020	1	000420366
11/16x11/16	212	10.500	1	000420367
3/4x3/4	233	11.850	1	000420369
13/16x13/16	254	15.600	1	000420371
7/8x7/8	264	16.200	1	000420372
15/16x15/16	285	18.100	1	000420373



Ft		
74.900	1	000420396
42INOX-AS/S9 1/4-5/16-3/8-7/16-1/2-9/16-5/8-11/16-3/4		



96BPINOX

Hajlított gömbfejű imbuszkulcs,
rozsdamentes acélból



mm	L	L1	h	Ft		
	mm	mm	g			
2	91	22	4	2.030	4	000961441
2,5	91	22	6	2.030	4	000961442
3	101	24	11	2.150	4	000961443
4	112	29	19	2.360	4	000961444
5	131	33	32	2.850	4	000961445
6	154	36	51	3.160	4	000961446
7	164	40	65	4.180	2	000961447
8	175	44	116	4.910	2	000961448
10	197	51	189	6.080	2	000961450



Ft		
20.000	1	000961455
96BPINOX/B6 2,5-3-4-5-6-8 mm		
32.250	1	000961456
96BPINOX/B9 2-2,5-3-4-5-6-7-8-10 mm		
96BPINOX/BV	2.520	1 000961459

96BPINOX-AS

Hajlított hatlapfejű belső kulcs
gömbölyű szélekkel,
rozsdamentes acélból

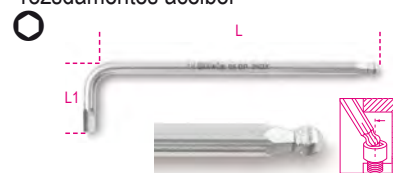

"	L	L1	h	Ft		
	mm	mm	g			
5/64	91	22	5,5	2.570	4	000961989
3/32	91	22	5,3	2.570	4	000961990
7/64	101	24	10,5	2.810	4	000961991
1/8	101	24	10,7	2.820	4	000961992
9/64	112	29	18,7	3.070	4	000961993
5/32	112	29	18,7	3.060	4	000961994
3/16	131	33	31,5	4.060	2	000961995
7/32	154	36	50,0	4.310	2	000961996
1/4	164	40	70,0	4.590	2	000961997
5/16	175	44	115,0	5.300	2	000961998
3/8	197	51	186,5	6.570	2	000961999



Ft		
31.800	1	000962000
96BPINOX-AS/B8 5/64-3/32-1/8-5/32-3/16-7/32-1/4-5/16		
96BPINOX/BV	2.520	1 000961459

96TINOX

T-szárú imbuszkulcs markolattal, rozsdamentes acélból

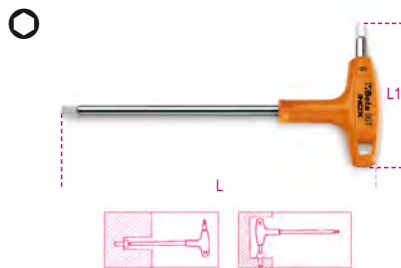

mm	L mm	L1 mm	Ft		
2,5	153	55	4.770	2	000961935
3	153	55	5.130	2	000961936
4	179	70	5.550	2	000961938
5	200	84	6.050	2	000961940
6	221	95	6.650	2	000961941
7	236	106	7.630	2	000961942
8	255	117	9.140	2	000961943
10	285	132	11.600	2	000961944



	Ft		
96TINOX/S5 2,5-3-4-5-6 mm	28.150	1	000961952
96TINOX/S8 2,5-3-4-5-6-7-8-10 mm	56.500	1	000961954

96TINOX-AS

T szárú belső hatlapfejű kulcs műanyag markolattal, rozsdamentes acélból

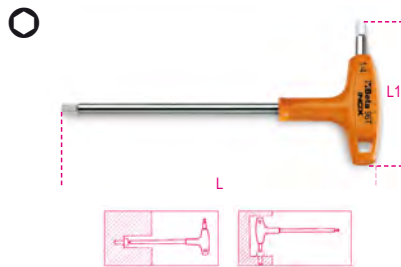

"	L mm	L1 mm	Ø mm	Ft		
3/32	153	55	3	5.300	2	000961861
7/64	153	55	4	5.560	2	000961862
1/8	179	70	4	6.050	2	000961863
9/64	179	70	5	6.300	2	000961864
5/32	200	84	6	6.570	2	000961865
3/16	200	84	6	7.030	2	000961866
7/32	221	103	7	8.070	2	000961867
1/4	236	106	8	8.570	2	000961868
5/16	255	117	10	10.050	2	000961869
3/8	285	132	12	11.000	2	000961870



	Ft		
96TINOX-AS/S7 3/32-1/8-5/32-3/16-7/32-1/4-5/16	51.650	1	000961877

111INOX

Állítható görgős villáskulcs, rozsdamentes acélból



DIN 3117 - ISO 6787

L mm	L "	A max mm	A1 mm	Ft		
150	6	18	45	36.300	1	001110315
200	8	24	58	47.550	1	001110320
250	10	30	70	57.650	1	001110325

362INOX

Amerikai csőfogó, rozsdamentes acélból



L mm	Ø max mm	Ft		
300	58	84.250	1	003620430

920INOX-A

Kézi dugókulcs hatlapú kialakítás, rozsdamentes acélból



DIN 3124 - UNI ISO 2725

Ø mm	Ø mm	A mm	L mm	Ft		
8	15	10	40	9.930	2	009203008
9	16	10	40	10.500	2	009203009
10	17	10	40	11.150	2	009203010
11	18	11	40	11.350	2	009203011
12	19	11	40	12.200	2	009203012
13	20	11	40	12.700	2	009203013
14	21	11	40	13.000	2	009203014
15	23	11	40	13.800	2	009203015
16	24	11	40	13.950	2	009203016
17	25	11	40	14.300	2	009203017
18	26	13	42	14.750	2	009203018
19	28	13	42	15.000	2	009203019
20	29	13	42	17.200	1	009203020
21	30	13	43	17.800	1	009203021
22	31	15	43	18.050	1	009203022
24	34	15	43	20.400	1	009203024
27	38	18	46	25.600	1	009203027
30	42	20	46	30.800	1	009203030
32	44	20	46	34.750	1	009203032

920/55INOX

Írányváltós racsní 1/2" négyszögű külső csatlakozóval 72 fogas mechanizmus, rozsdamentes acélból



L mm	Ø mm	A mm	Ft		
264	40	43	83.400	1	009203882

920/R55INOX

12"



	Ft		
920/R55INOX	35.100	1	009203879

1048INOX

Vízpumpa fogó, zárt csuklós, rozsdamentes acélból
• 7 állású modell

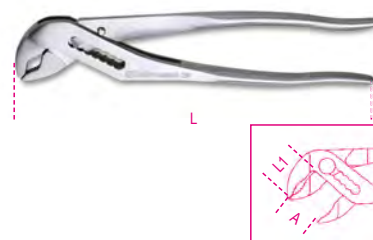

L mm	A max mm	L1 mm	Ft		
250	33	33	59.700	1	010480325

1082INOX

Oldalsípófogó, rozsdamentes acélból



L mm	L1 mm		Ft		
150	20,0	1,6	41.400	1	010820350

1150INOX

Robusztus kombinált fogó, rozsdamentes acélból decentralizált csap nyitott csuklós szabad csuklós



L mm	L1 mm	Ft		
180	39	39.650	1	011500518

1153INOX

Kétállású, állítható kombináltfogó, rozsdamentes acélból



L mm	L1 mm	Ft		
150	26	42.800	1	011530315

1290INOX

Csavarhúzó hasítottfejú csavarokhoz,
szár rozsdamentes acélból

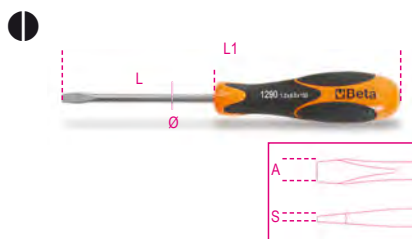

ISO 2380

SxAxL mm	L1 mm	Ø mm	Ft	🔧	📦
0,4x2,5x50	146	2.5	2.830	4	012900403
0,5x3x75	171	3.0	3.010	4	012900409
0,8x4x100	196	4.0	3.260	4	012900430
1,0x5,5x150	259	5.0	4.170	4	012900442
1,2x6,5x150	270	6.0	4.540	4	012900451

1292INOX

Csavarhúzó Phillips®-csavarokhoz,
szár rozsdamentes acélból

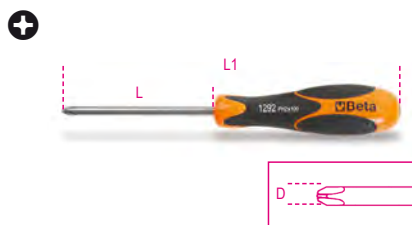

ISO 8764

PHxDxL mm	L1 mm	Ft	🔧	📦
0x3x60	156	2.870	4	012920403
1x4,5x80	189	3.470	4	012920409
2x6x100	220	4.170	4	012920418

1293INOX/D8

8 darabos csavarhúzókészlet,
rozsdamentes acélból



1293INOX/D8	Ft	🔧	📦
28.300	1	012930408	
1290INOX	0,4x2,5x50-0,5x3x75 0,8x4x100-1,0x5,5x150-		
1292INOX	1,2x6,5x150 mm PH0x60-PH1x80 PH2x100 mm		

1370INOX

Szerelőkalapács
német modell,
rozsdamentes acélból



g	A mm	L mm	L1 mm	Ft	🔧	📦
500	25	240	101	31.650	1	013700375

1377INOX

Gömbvégű és kerekfejú
kalapács,
kazánkövácások és bádigosok számára,
rozsdamentes acélból



g	L mm	L1 mm	Ft	🔧	📦
230	220	82	23.700	1	013770623
340	220	90	33.400	1	013770634

1730INOX

Univerzális spakli,
rozsdamentes acélból



A mm	L mm	Ft	🔧	📦
50	200	22.200	1	017300450

G20TSS

Ötrekeszes szerszámok láda rozsdamentes
acélból (AISI 304)



G20TSS	Ft	🔧	📦
105.600	1	021203001	

📏: 450x200x210 mm - 🏋️: 4kg

Beta

C04TSS-7

7 fiókos szerszámkocsi teljesen rozsdamentes acélból
Nem hagynak nyomot a kerekek.

Főbb jellemzők:

- Hét darab 570 x 410 mm teleszkópos, csapágyazott fiókkal;
- 6 fiók magassága 83 mm;
- 1 fiók magassága 170 mm;
- 4 kerék Ø 125 mm
- 2 rögzített és 2 elfordítható (kettő fékkel)
- Központi zár elől;
- Teljesen rozsdamentes acél szerkezet;
- Kerekek, tartóelemek, csapágyak, fiókbelső és fiókvezetők rozsdamentes acélból
- Alumínium fiókfogantyúk

63 kg

Beta
INOX
STAINLESS STEEL

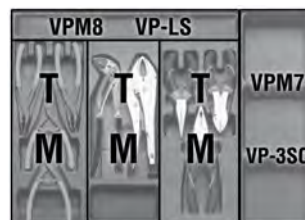

h	max
83 mm	25 kg
170 mm	30 kg

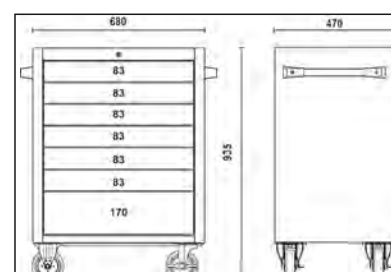
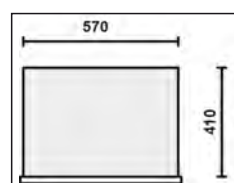

C04TSS/7

Ft 1.028.700 024003077

SZIKRAMENTES SZERSZÁMOK



RÉZ-BERILIUM (CU-BE)

A specifikus **Beta** szikramentes szerszámok biztonságosan használhatók olyan robbanásveszélyes helyeken, ahol gyúlékony folyadékok, vagy gázok fordulnak elő, ahol antimágneses és extrém korróziómentes szerszámok használata kötelező.



Beta szikramentes szerszámokat a BAM (Szövetségi Anyagkutató és Vizsgáló Intézet) a 99/92/EC Európai Irányelvnek megfelelően tanúsítja.



FIGYELEM! Robbanásveszély lehetséges ACETILÉN-es környezetben.

A szikramentes szerszámok mechanikai tulajdonságai mások, mint az átlagos acélszerszámoké. Ajánlatos ezeket megfelelő körültekintéssel és óvatossággal használni és a túlterhelést elkerülni.

ROBBANÁSVESZÉLYES ZÓNÁK

		ROBBANÁSVESZÉLYES ZÓNÁK	
ATEX		KÖZEPES ALACSONY	NAGYON ALACSONY
GÁZ		ZONE 1 Az a térség, ahol normál üzemmódban robbanásveszélyes gyúlékony gáz, pára vagy köd levegővel keveredve atmoszférikus környezetben alkalmanként van jelen.	ZONE 2 Az a térség, ahol normál üzemmódban robbanásveszélyes gyúlékony gáz, pára vagy köd levegővel keveredve atmoszférikus környezetben ritkán, rövid ideig, rendszertelenül van jelen.
		ZONE 21 Az a térség, ahol normál üzemmódban robbanásveszélyes gyúlékony por levegővel keveredve atmoszférikus környezetben gyakorta, vagy rendszeresen képződhet.	ZONE 22 Az a térség, ahol normál üzemmódban robbanásveszélyes gyúlékony por levegővel keveredve atmoszférikus környezetben normális módon nem vagy csak rövid ideig képződik.
POR			

30BA

Kiütő, szikramentes



Ø mm	L mm	S mm	Ft		
5	150	15	24.600	1	000300806
8	150	17	30.200	1	000300808
10	150	19	37.250	1	000300810

31BA

Kiütő, szikramentes



Ø mm	L mm	Ft		
3	110	10.550	1	000310853
4	110	22.200	1	000310854
6	115	34.700	1	000310856
8	120	39.800	1	000310858

31BA/C

szikramentes Kiütő pontozók



Ø mm	Ø1 mm	L mm	Ft		
*6	12	150	16.200	1	000310876
*7	13	150	18.950	1	000310877
*12	18	175	40.600	1	000310882
*13	29	255	127.900	1	000310883

32BA

szikramentes pontozó



Ø mm	L mm	Ft		
14	150	30.450	1	000320811

34BA

Laposvágó, szikramentes



L mm	A mm	Ft		
200	22	46.650	1	000340801
250	24	77.300	1	000340803
300	25	102.000	1	000340802

96BAF-AS

szikramentes hajlított imbuszkulcs



mm	L mm	L1 mm	Ft	1	000962831
*1/16	59	25	25.000	1	000962831
*5/64	59	25	25.850	1	000962832
*3/32	59	25	27.300	1	000962833
*7/64	59	25	28.650	1	000962834
*1/8	59	25	29.900	1	000962835
*9/64	64	29	31.300	1	000962836
*5/32	65	30	33.000	1	000962837
*3/16	79	31	35.250	1	000962838
*7/32	85	37	36.100	1	000962839
*1/4	85	37	37.900	1	000962840
*5/16	92	44	41.000	1	000962842
*3/8	110	45	44.050	1	000962844
*7/16	119	48	96.650	1	000962845
*1/2	140	55	109.900	1	000962846
*9/16	150	58	122.200	1	000962847

99BA

Körmöskulcs, szikramentes



mm	A mm	Ft	1	000990803
32-75	4,0	80.000	1	000990803
50-120	4,5	123.900	1	000990805
115-170	4,5	197.600	1	000990811

110BA

Állítható villáskulcs, szikramentes



L mm	A max	Ft	1	001100810
100	13	57.700	1	001100810
150	18	66.000	1	001100815
200	24	78.950	1	001100820
250	30	94.250	1	001100825
300	36	132.000	1	001100830
375	46	178.200	1	001100837
*450	55	249.300	1	001100845
*600	65	419.800	1	001100860

330BA

Csővágó, szikramentes



330BA/2	Ø max 50 mm 2"	L mm 375	Ft 311.600	1	003300822
330BA/2	Ø max 50 mm 2"	L mm 375	Ft 311.600	1	003300822

330BA/2R

tartalék kés és tű a 330BA gázcsővágó eszközhöz, szikramentes



330BA/2-R	Ft 30.600	1	003300822
330BA/2-R	Ft 30.600	1	003300822

363BA

Csőfógó, amerikai modell, szikramentes



L mm	Ø max mm	Ft	1	003630815
150	1/2" gas	99.250	1	003630815
200	1" gas	102.700	1	003630820
250	1 1/2" gas	116.500	1	003630825
300	2" gas	146.200	1	003630830
350	2" gas	184.900	1	003630835
450	2 1/2" gas	282.100	1	003630845
600	3" gas	394.600	1	003630860

378BA

Svéd csőfógó, szikramentes, réz és berillium ötvözet



L mm	Ø max * mm	Ft	1	003780800
430	1" 1/2 gas	308.400	1	003780800
530	2" gas	374.700	1	003780801

386BA

Erősített láncos csőfógó, szikramentes

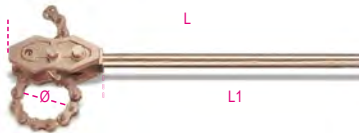

L mm	Ø max mm	L1 mm	Ft	1	003860806
600	100	470	460.800	1	003860806
900	200	750	764.900	1	003860809

911BA

tizenkétszögű dugókulcs szikramentes

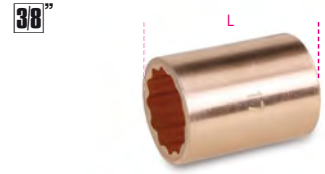

mm	L mm	Ft	1	009110806
6	28	18.600	1	009110806
7	28	20.050	1	009110807
8	28	21.250	1	009110808
9	28	22.500	1	009110809
10	32	30.950	1	009110810
11	32	32.650	1	009110811
12	32	34.400	1	009110812
13	32	36.350	1	009110813
14	32	37.900	1	009110814
15	32	38.450	1	009110815
16	32	40.300	1	009110816
17	32	41.900	1	009110817
18	32	42.550	1	009110818
19	32 32	44.200	1	009110819

911BA/16

szűkítő közbetét 3/8" és 1/2", szikramentes

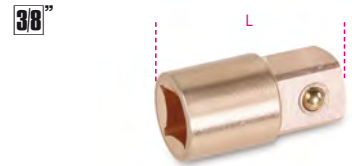

L mm	3/8"	1/2"	Ft	1	009110836
34	3/8"	1/2"	39.000	1	009110836

911BA/20

3/8"-os toldó, szikramentes



L mm	Ft	1	009110840
75	31.850	1	009110840

911BA/55

3/8"-os átnyomós irányváltós racsní, szikramentes

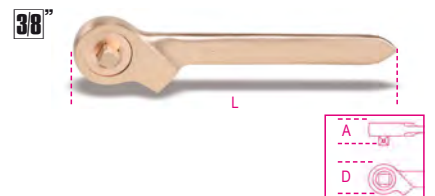

L mm	D mm	A mm	Ft	1	009110882
200	45	16.5	67.700	1	009110882



921BA

Tizenkétszögű dugókulcs, szikramentes

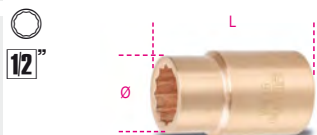

mm	Ø mm	L mm	Ft	📏	📦
8	24,0	40	30.650	1	009210808
9	24,0	40	32.400	1	009210809
10	16,5	40	36.850	1	009210810
11	17,5	40	38.500	1	009210811
12	18,5	40	40.500	1	009210812
13	19,5	40	42.650	1	009210813
14	20,0	40	43.600	1	009210814
15	21,5	40	45.800	1	009210815
16	24,0	40	47.350	1	009210816
17	25,0	40	48.300	1	009210817
18	25,0	40	49.900	1	009210818
19	28,0	42	51.850	1	009210819
20	29,0	42	54.300	1	009210820
21	30,0	43	55.250	1	009210821
22	30,5	43	57.400	1	009210822
24	34,0	43	67.400	1	009210824
25	36,0	43	73.550	1	009210825
26	37,5	43	77.500	1	009210826
27	37,5	45	81.500	1	009210827
28	38,9	46	85.500	1	009210828
30	41,5	46	98.200	1	009210830
32	43,5	46	109.300	1	009210832

921BA-AS

tizenkétszögű dugókulcs, szikramentes

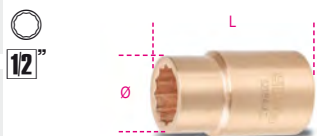

"	Ø mm	L mm	Ft	📏	📦
5/16	24,0	40	34.300	1	009210958
3/8	24,0	40	37.400	1	009210960
7/16	24,0	40	40.700	1	009210961
1/2	24,0	40	43.800	1	009210963
9/16	24,0	40	44.800	1	009210964
5/8	25,0	40	51.750	1	009210966
11/16	25,5	40	56.000	1	009210967
3/4	28,0	42	61.050	1	009210969
13/16	30,0	43	64.650	1	009210971
7/8	31,5	43	70.100	1	009210972
15/16	34,0	43	75.050	1	009210974
1	36,0	43	83.500	1	009210975
1.1/16	38,0	46	90.750	1	009210977
1.1/4	42,0	46	119.700	1	009210982
1.7/16	50,5	50	147.100	1	009210986

921BA/15

szűkítő közbetét 1/2" és 3/8", szikramentes



L mm	□	■	Ft	📏	📦
34	1/2	3/8	35.250	1	009210839

921BA/16

szűkítő közbetét 1/2" és 3/4" szikramentes



L mm	□	■	Ft	📏	📦
34	1/2	3/4	45.900	1	009210840

921BA/21 - 921BA/22

Toldó 1/2", szikramentes



	L mm	Ø mm	Ft	📏	📦
921BA/21	125	30	50.000	1	009210842
921BA/22	250	31	69.850	1	009210844

921BA/25

Csukló, belső- és külső négyszög 1/2", szikramentes



L mm	Ø mm	□	■	Ft	📏	📦
80	25	1/2	1/2	52.050	1	009210845

921BA/42

Csúszkás T-hajtószár 1/2", szikramentes



L mm	Ft	📏	📦
250	84.400	1	009210846

921BA/50

1/2"-os racsn, szikramentes



L mm	D mm	A mm	Ft	📏	📦
250	45	16,5	101.200	1	009210850

921BA/R50

pótalkatrész készlet szikramentes



L mm	Ft	📏	📦
1/2"	28.800	1	009210851

926BA

Tizenkétszögű dugókulcs, szikramentes

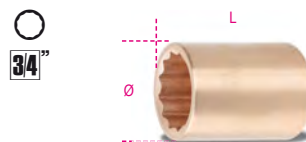

mm	Ø mm	L mm	Ft	📏	📦
22	40	55	59.000	1	009260822
24	40	55	73.550	1	009260824
26	40	55	83.650	1	009260826
27	40	55	88.600	1	009260827
28	41	55	102.800	1	009260828
30	43	60	104.200	1	009260830
32	45	60	117.900	1	009260832
34	48	60	126.500	1	009260834
36	50	60	135.800	1	009260836
38	53	60	144.600	1	009260838
41	57	65	159.400	1	009260841
46	63	65	187.500	1	009260846
50	68	70	207.700	1	009260850

926BA/15

szűkítő közbetét 3/4" és 1/2" szikramentes



L mm	□	■	Ft	📏	📦
55	3/4	1/2	50.700	1	009260861

926BA/22

Toldó 3/4", szikramentes



L mm	Ø mm	Ft	📏	📦	
926BA/22	200	38	105.200	1	009260872

926BA/42

Csúszkás T-hajtószár, külső négyszög 3/4", szikramentes



L mm	Ft	📏	📦
400	148.100	1	009260876

926BA/50

Racsnis hajtósár 3/4", szikramentes



L	D	A	Ft		
mm	mm	mm			
300	61	22	152.400	1	009260880

926BA/R50

pótalkatrész készlet szikramentes



3/4"	Ft		
	49.350	1	009260881

937BA

Dugókulcs, szikramentes



Ø	L	A	Ft		
mm	mm	mm			
13	240	45	38.750	1	009370813
17	260	51	55.500	1	009370817
19	270	55	57.900	1	009370819
22	278	59	76.550	1	009370822
24	286	63	82.200	1	009370824
27	294	69	87.500	1	009370827
30	302	75	95.700	1	009370830
32	310	81	105.200	1	009370832
*36	330	85	124.500	1	009370836
*41	350	90	149.800	1	009370841

951BA

T-szárú imbuszkulcs, szikramentes



mm	L	L1	Ft		
mm	mm	mm			
4	100	90	64.750	1	009510904
5	100	90	67.400	1	009510905
6	100	90	71.250	1	009510906

961BA

Feszítővas, szikramentes



L	A	Ft		
mm	mm			
250	39	56.200	1	009610802
350	55	84.900	1	009610806

963BA

feszítővas hegyes és hajlított lapos véggel, szikramentes



L	A	Ft		
mm	mm			
500	24	155.800	1	009630801
*800	24	249.300	1	009630803
*1000	30	523.800	1	009630805

964BA

Szerelővas, szikramentes



L	Ft		
mm			
385	149.600	1	009640801

964BA/L

Univerzális hordonyító, szikramentes

Fémhordók nyitásához



*964BA/L	L	Ft		
	mm			
	510	759.700	1	009640821

965BA

Biztonsági szelepszáró kulcs, szikramentes



A	A1	L	Ft		
mm	mm	mm			
30	44	200	66.950	1	009650830
32	50	300	91.050	1	009650832
35	47	250	74.000	1	009650835
40	50	300	86.000	1	009650840
45	58	350	111.100	1	009650845
48	62	375	116.900	1	009650848
50	67	400	127.000	1	009650850
55	73	450	150.900	1	009650855
60	79	500	162.300	1	009650860
*65	82	550	185.700	1	009650865
*70	85	600	204.600	1	009650870

966BA

Biztonsági szelepszáró kulcs, szikramentes

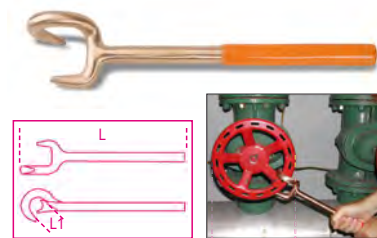

L	L1	Ø min+max	Ft		
mm	mm	mm			
350	40	50+150	145.400	1	009660801

966BA/V

szikramentes kulcsok, biztonsági szelepekhez

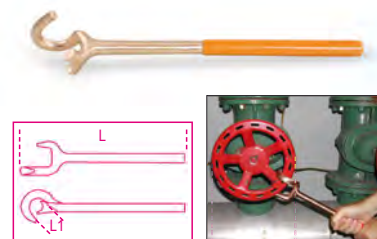

L	L1	Ø min+max	Ft		
mm	mm	mm			
370	36	125+250	142.900	1	009660812
430	48	250+400	209.000	1	009660814

1032BA

szikramentes fogó egyenes csőrrel rugalmas biztosító gyűrűkhöz, furatokhoz PVC bevonatú nyéllel



L	Ø	Ft		
mm	mm			
200	40+100	98.150	1	010320820

1036BA

szikramentes fogó egyenes csőrrel rugalmas biztosító gyűrűkhöz, tengelyekhez PVC bevonatú nyéllel

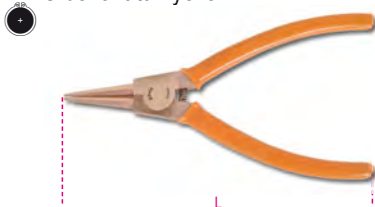

L	Ø	Ft		
mm	mm			
200	40+100	98.150	1	010360820

1046BA

vízpumpafogó
fogasléces forgópánt,
szikramentes



L mm	A max mm	Ft	🔧	📦
250	32	120.000	1	010460801
★300	52	159.800	1	010460803

1052BA

önzáró vízpumpa fogó
homorú pófájú, szikramentes

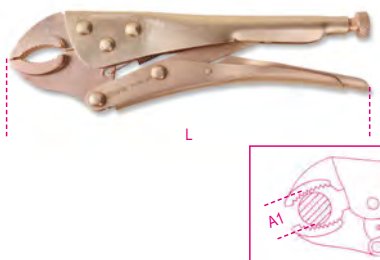

L mm	A1 max mm	Ft	🔧	📦
225	40,0	130.300	1	010520824

1082BA

Oldalcsípőfogó, szikramentes

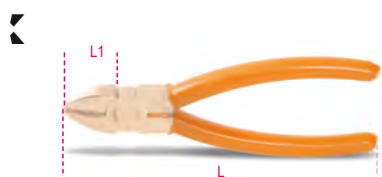

L mm	L1 mm	Ft	🔧	📦
160	22	86.100	1	010820801

1100BA

csapszegvágó,
szikramentes



L mm	Ft	🔧	📦
600	504.800	1	011000860

1137BA

Csupaszoló fogó



L mm	L1 mm	Ft	🔧	📦
185	30	163.100	1	011370801

1137BA/RC

Tartalékpenge a 1137BA-hoz



1137BA/RC	Ft	🔧	📦
	31.650	1	011370851

1150BA

Kombinált fogó, szikramentes



L mm	L1 mm	Ft	🔧	📦
200	40	101.200	1	011500820

1162BA

Egyenes extra hosszú laposfogó,
szikramentes



L mm	L1 mm	Ft	🔧	📦
150	54	79.500	1	011620815

1166BA

Egyenes extra hosszú félkerékcsőrű fogó,
szikramentes



L mm	L1 mm	Ft	🔧	📦
150	54	79.500	1	011660815

1270BA

Csavarhúzó hasítottfejű csavarokhoz,
szikramentes



AxL mm	L1 mm	Ft	🔧	📦
3x75	178	14.500	1	012700803
4x100	209	18.650	1	012700804
5x150	250	24.000	1	012700805
6x150	270	26.500	1	012700806
10x250	382	39.700	1	012700810
8x200	312	28.850	1	012700808

1272BA

Csavarhúzó Phillips®-csavarokhoz,
szikramentes



PHxDxL mm	L1 mm	Ft	🔧	📦
1x5x100	209	20.150	1	012720801
2x6x150	270	27.000	1	012720802
3x8x200	332	31.650	1	012720803

1277BA

imbusz-csavarhúzó Torx® csavarokhoz,
szikramentes



Ø	L mm	L1 mm	Ø mm	Ft	🔧	📦
T10	75	184	5	18.750	1	012770810
T15	75	184	5	22.850	1	012770815
T20	100	209	6	29.900	1	012770820
T25	125	209	6	30.950	1	012770825
T30	150	270	6	34.050	1	012770830
T40	200	332	8	40.550	1	012770840

1370BA

Lakatos kalapács, szikramentes,
fanyéllal



g	A mm	L mm	L1 mm	Ft	🔧	📦
500	30	310	108	53.350	1	013700805
1000	35	340	137	95.050	1	013700810

1370BA/MR

Tartaléknyél a 1370BA modellhez

	Ft		
1370BA/MR 500	9.300	1	013700865
1370BA/500			
1370BA/MR 1000	11.500	1	013700870
1370BA/1000			

1370BA/PL

szikramentes lakatos kalapács, műanyag nyéllel



g	A mm	L mm	L1 mm	Ft		
500	30	310	108	53.350	1	013700815
1000	35	340	137	95.050	1	013700820

1375BA/PL

gömbfejű körmös kalapács szikramentes műanyag nyéllel



g	L mm	L1 mm	Ø mm	Ft		
680	321	125	30	69.300	1	013750800

1377BA

kerekfejű és gömbfokú kalapács kazánkovácsok és bádigosok számára, szikramentes



g	L1 mm	L mm	Ft		
340	90	280	34.600	1	013770834

1377BA/PL

kerekfejű és gömbfokú kalapács kazánkovácsok és bádigosok számára, Faser nyél, szikramentes



g	L1 mm	L mm	Ft		
340	90	280	34.600	1	013770884

1379BA

Rozsdaeltávolító kalapács, szikramentes, fanyéllal



g	L1 mm	L mm	Ft		
500	142	315	67.450	1	013790850

1380BA

Ráverő kalapács, szikramentes, fanyéllal



g	L1 mm	L mm	Ft		
1000	100	400	115.600	1	013800810
1500	118	400	142.200	1	013800815
2000	126	400	186.800	1	013800820

1380BA/MR

Tartaléknyél a 1380BA modellhez

	Ft		
1380BA/MR 1000	11.950	1	013800860
1380BA/1000			
1380BA/MR 1500	11.950	1	013800865
1380BA/1500			
1380BA/MR 2000	11.950	1	013800870
1380BA/2000			

1380BA/PL

szikramentes ráverőkalapács, műanyag nyéllel



g	L1 mm	L mm	Ft		
500	80	310	66.100	1	013800955
1000	94	350	123.300	1	013800960
1500	115	400	172.000	1	013800965
2000	125,5	400	229.000	1	013800970

1381BA

szikramentes ráverő kalapács, fanyéllal



g	L1 mm	L mm	Ft		
5000	179	900	433.700	1	013810850
*8000	190	900	690.200	1	013810858

1381BA/MR

Tartaléknyél a 1381BA modellhez

	Ft		
1381BA/MR 5000	18.850	1	013810870
1381BA/5000			
*1381BA/MR 8000	21.950	1	013810878
1381BA/8000			

1381BA/PL

szikramentes hosszú nyelű ráverőkalapács, műanyag nyéllel



g	L1 mm	L mm	Ft		
5000	172	900	448.800	1	013810885
8000	204	900	836.800	1	013810888

1390BA

Műanyagbetétes kalapács, szikramentes



Ø mm	L mm	L1 mm	Ft		
*52	370	130	93.200	1	013900805

1390BA/R

Nylon cserefej a 1390BA kalapácshoz



D mm	Ft		
52	19.350	4	013900885



1602BA

saruzófógo
szigetelt kábelcsukókhoz, könnyített kivitel,
szikramentes



mm ²	L mm	Ft	1	016020801
0.75÷6	200	115.200		

1701BA

hatszögű laposvágó,
szikramentes



L mm	A mm	S mm	Ft	1	017010810
150	12	10	21.350		
200	16	14	34.150		017010814
250	18	14	41.600		017010815
350	19	17	107.700		017010817

1703BA/A

Fejsze, szikramentes



L mm	L1 mm	A mm	Ft	1	017030082
340	145	82	95.000		

1703BA/P

Csákány, szikramentes

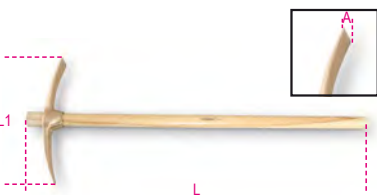

A mm	L mm	L1 mm	Ft	1	017030150
56	1050	410	247.500		

1703BA/PL

Ásólapát, szikramentes



A mm	L1 mm	L mm	Ft	1	017030200
240	420	990	207.700		

1717BA

Spakli, merev, szikramentes



A mm	Ft	1	017170801
60	50.250		
80	55.750		017170803

1717BA/1

Hántoló, szikramentes



A mm	L mm	Ft	1	017170805
100	220	103.000		

1719BA8

8"-os reszelő, szikramentes



	L mm	Ft	1	017190801
1719BA8/P	200	61.250		
1719BA8/M	200	63.700		017190805
1719BA8/R	200	65.150		017190810
1719BA8/T	200	59.700		017190815
1719BA8/Q	200	59.700		017190820

1719BA12

12" reszelő, szikramentes



	L mm	Ft	1	017190831
1719BA12/P	300	111.700		

1727BA

Fűrész fűrészlappal, szikramentes



L mm	L1 mm	Ft	1	017270801
500	300	201.900		

1728BA

Fűrészlap, szikramentes, réz és berillium
ötvözet



L mm	Ft	1	017280801
300	39.550		

1737BA

Drótkéfe gyújtógyertyához, szikramentes



L mm	A mm	Ft	1	017370801
294	29	25.250		

1758BA

szikramentes tölcse



Ø mm	H mm	Ft	1	017580815
160	150	43.700		

1776BA

Kés, szikramentes



L1 mm	L mm	Ft	1	017760801
145	250	55.650		

1784BA

Ólló, szikramentes



L mm	Ft	1	017840822
225	98.050		



1972/12

ultrakompakt 12 V fúró csavarbehajtó

- ultrakompakt, csak 176 mm hosszú, ultrakönnyű, csak 1,1 kg akkumulátorral, és tökéletesen kiegyensúlyozott
- kétsébséges mechanika acél fogaskerekekkel és 18 állású tengelykapcsolóval
- legnagyobb nyomaték 34 Nm és 1500 f/p (350 f/p első fokozatban); legnagyobb furatkészítés 10 mm acélban és 20 mm fában
- 2Ah akkumulátorok, töltésszelzővel a gépházon
- háromszoros akkumulátor védelem (hővédelem, túlterhelés elleni védelem, és az esetleges cellák közötti töltésvesztés felügyelete) nyújt nagyobb biztonságot és garantál időtálló magas teljesítményt
- csúszásmentes ergonomikus markolat
- előlő LED
- 10 mm önzáró tokmány
- jobb/bal oldali zárókapocs
- becsavarás-kicsavarás-reteszelés (szállításhoz) választókapcsoló
- merev táskában, 2 db 2 Ah lítium ion akkumulátorral és gyorstöltővel (45 p) szállítva

1,1 kg

1972/12

Ft 157.600 Ft 019720012



Beta 3-YEAR WARRANTY



1984/18QM

18 V brushless impulzusos irányváltós csavarbehajtó

szénkefe nélküli digitális brushless motor: a teljesítőképesség jelentős növekedésével jár, többek között: nagyobb teljesítmény, kisebb energiafogyasztás, kiterjesztett hasznos motor élettartam, rendkívüli kompaktság, jobb teljesítményadagolás a nyomógomb segítségével.

- 5 Ah akkumulátorok töltésszelzővel
- ultrakompakt: csak 196 mm hosszúság
- 1/2" külső négyzetű csatlakozó dugókulcs tartó gyűrűvel
- jobb/bal oldali övkapocs
- hármass előlő LED világítás
- teljesen fémből készült fogaskerékház
- becsavarás-kicsavarás-reteszelés (szállításhoz) választókapcsoló
- csúszásmentes ergonomikus markolat
- háromszoros akkumulátor védelem (hővédelem, túlterhelés elleni védelem, és az esetleges cellák közötti töltésvesztés felügyelete) nyújt nagyobb biztonságot és garantál időtálló magas teljesítményt

4 kijelölhető üzemmód:

- 1: 270 Nm; 1400 f/p
- 2: 360Nm; 2000 f/p
- 3: 450 Nm; 2750 RPM

A: 450 Nm Autostop - amíg a csavarbehajtó szabad forgást észlel, a legnagyobb nyomaték/fordulatszám értéket használja (450 Nm; 2750 f/p). amikor az anya végálláshoz érkezik, és nem forog tovább, a csavarbehajtó 1 másodpercig továbbra is a legnagyobb nyomaték/fordulatszám értéket használja, majd alacsonyabb értékere áll vissza, hogy ne sérüljön az anya

- merev táskában, 1/4" hatlapfejű bittartó adapterrel, 2 db 5 Ah lítiumion akkumulátorral és gyorstöltővel (80 perc) szállítva

2,3 kg

1984/18QM

Ft 447.000 Ft 019840018



Beta 3-YEAR WARRANTY

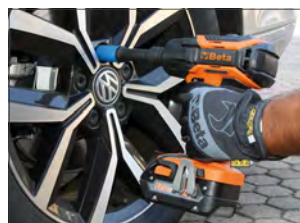

A BETA ÚJ, SAJÁT MÁRKÁJÚ SAROKCSISZOLÓI



A Beta kínálatában egyaránt megtalálhatók vezetékes és akkumulátoros szerszámgépek.

A vezetékes csiszolók jellemzői és teljesítménye az alkalmazási területtől függenek.

Teljesítmény, megbízhatóság és tartósság: ez jellemzi a Beta új termékcsaládját, természetesen kiegészülve a maximális biztonsággal és könnyű használattal a szakemberek számára.

• **Kiemelkedő teljesítmény:**

- Nagy teljesítményű, műgyanta kötésű, kopásálló, robusztus motor
- A porvédővel kialakított levegőcsatorna optimális hűtést biztosít

• **Páratlan biztonság a felhasználóknak:**

- Tengelyzár a gyors korongcseréhez
- Véletlen beindítás elleni védelem
- Lágýindítás - az indításkor fellépő túláram korlátozására

• **Egyedi kényelem és könnyű kezelhetőség:**

- A csúszásmentes ergonomikus markolat jobban kézben tartható
- A lapos hajtóműfej lehetővé teszi a szűk helyen végzett munkát

A 4 méter hosszú gabalyodásmentes kábellel könnyebben körbejárhatók a munkadarabok
Mindkét oldalra felszerelhető kiegészítő markolat

1956 115-750W

sarokcsiszoló Ø 115 mm korongokhoz

Vágáshoz, csiszoláshoz és nagyoláshoz ideális

Nagy teljesítményű motor (750 W)

Csúszásmentes, ergonomikus markolat a nagyobb kényelemért és biztonságért

A lapos hajtóműfej lehetővé teszi a szűk helyeken végzett munkát

Rendkívül könnyű (mindössze 1,8 kg)

Fő jellemzők

- Véletlen beindítás elleni védelem
- Mindkét oldalra felszerelhető kiegészítő markolat
- Szerszám nélküli korongcsere (gyorskioldó)
- Tengelyzár a gyors korongcseréhez
- Tengelyreteszelő kapcsoló
- A porvédővel kialakított levegőcsatorna optimális hűtést biztosít
- Szervizkulccsal szállítva

📏 1,8 kg



1956 115-750W

Ft 28.300 1 019560011

1956 125-1400W

sarokcsiszoló Ø 125 mm korongokhoz

Vágáshoz, csiszoláshoz és nagyoláshoz ideális

Nagy teljesítményű motor (1400 W) – Változtatható fordulatszám
Csúszásmentes, ergonomikus markolat a nagyobb kényelemért és biztonságért

A lapos hajtóműfej lehetővé teszi a szűk helyeken végzett munkát

Fő jellemzők

- Véletlen beindítás elleni védelem
- Mindkét oldalra felszerelhető rezgéscsillapító oldalfogantyú
- Szerszám nélküli korongcsere (gyorskioldó)
- Tengelyzár a gyors korongcseréhez
- Tengelyreteszelő kapcsoló
- A porvédővel kialakított levegőcsatorna optimális hűtést biztosít
- Szervizkulccsal szállítva

📦 2,5 kg



1956 125-1400W

Ft 55.150 1 019560125

1956 230-2400W

sarokcsiszoló Ø 230 mm korongokhoz

Komplex nyíró, csiszoló és reszelő munkákhoz ideális

Nagy teljesítményű motor (2400 W)
Csúszásmentes, ergonomikus markolat a nagyobb kényelemért és biztonságért

Fő jellemzők

- Véletlen beindítás elleni védelem
- Lágyindítás funkció a zökkenőmentes indításhoz és az indításkor fellépő túláram korlátozására
- Mindkét oldalra felszerelhető rezgéscsillapító oldalfogantyú
- Csavaros korongcsere
- Tengelyzár a gyors korongcseréhez
- Tengelyreteszelő kapcsoló
- A porvédővel kialakított levegőcsatorna optimális hűtést biztosít
- Szervizkulccsal szállítva

📦 5,8 kg

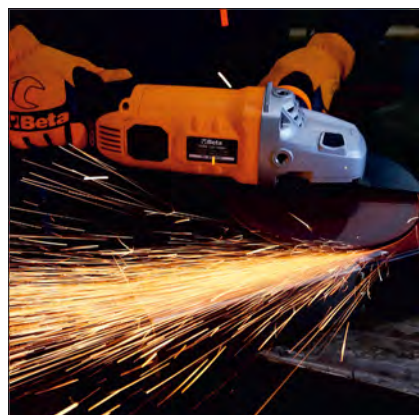

1956 230-2400W

Ft 74.250 1 019560230



PNEUMATIKUS SZERSZÁMOK ÉS TAROZÉKOK

A Beta több mint 20 évvel ezelőtt pneumatikus szerszámokkal és azok tartozékaival bővítette termékpalettáját. Az alant felsorolt szerszámok elsősorban az autóiipar és az ipari karbantartás területén használhatók: ütvecsavarbehajtók, racsnik, fúrógépek, csiszoló- és polírozó gépek, stb. Időközben szoros együttműködés alakult ki termékeink professzionális felhasználóival, ami állandó fejlesztést garantált. Ennek a fejlesztésnek köszönhetően a piac ma elismeri a Beta pneumatikus szerszámait, azok megbízhatóságát és teljesítményét.



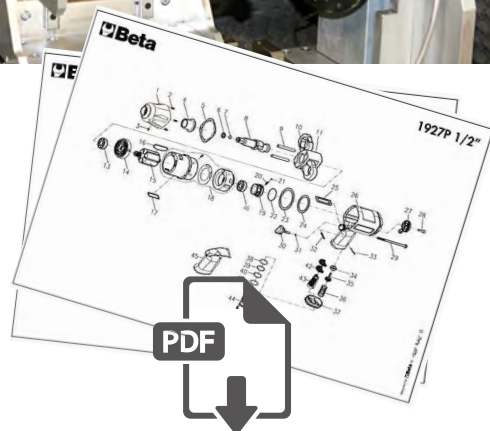
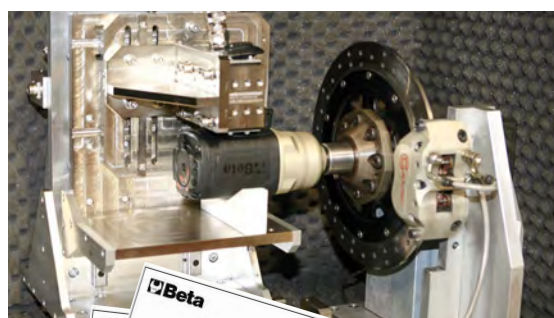















Annak érdekében, hogy a piac követelményeinek tökéletesen megfelelhessen, a Beta folyamatosan fejleszti pneumatikus eszközeit. Ez a folyamat lehetővé teszi, hogy a know-how jelentősen növekedjen és a vevők igényeit teljesíteni tudja.



www.beta-tools.com







ÚTMUTATÓ A PNEUMATIKUS SZERSZÁMOK KIVÁLASZTÁSÁHOZ

ÜTVECSAVARBEHAJTÓK















■	TERMÉK	KATALÓGUSSZÁM	ANYAG	 max. Nm	 db (A) LpA	 db (A) LpW	 l/min.	 kg	MŰKÖDÉSI MECHANIZMUS	 m/s ²
3/8"		1924F	Alumínium	108	93.6	104.6	59	0,5	Dupla ütőkalapács	6.85
3/8"		1924B	Alumínium	353	91	95	80	1,5	Ütőszegecs	7.9
3/8"		1924CD	Kompozit anyag	410	91.7	102.7	79	1,3	Dupla ütőkalapács	6.2
1/2"		1927AN	Alumínium	244	89.4	100.4	190	2,1	Szimpla ütőkalapács	8.63
1/2"		1927G	Alumínium	325	92.2	103.2	113	1,2	Szimpla ütőkalapács	9.96
1/2"		1927B	Alumínium	705	98.0	109.0	133	2,1	Ütőszegecs	14.08
1/2"		1927XM	Alumínium	770	102	113	122	1,3	Szimpla ütőkalapács	7.5
1/2"		1927CD	Kompozit anyag	1.020	95.5	106.5	130	2,3	Dupla ütőkalapács	7.2
1/2"		1927P	Kompozit anyag	1.750	95.1	106.1	290	2,0	Dupla ütőkalapács	6.7
3/4"		1928XM	Alumínium	1.600	91.8	102.8	175	2,9	Dupla ütőkalapács	12.96
3/4"		1928DA	Alumínium	1.695	96	99.5	300	4,3	Dupla ütőkalapács	3.6
3/4"		1928DAL	Alumínium	1.695	96	99.5	300	4,8	Dupla ütőkalapács	3.6
3/4"		1928CD	Kompozit anyag	1.800	97.5	108.5	215	3,5	Dupla ütőkalapács	11.4
1"		1930CD	Kompozit anyag	2.445	95.6	97.1	410	7,1	Dupla ütőkalapács	3,6
1"		1930PA	Alumínium	2.445	96.0	97.1	410	9,6	Dupla ütőkalapács	7,2
1"		1930A	Alumínium	2.445	103.3	114.3	460	9,5	Dupla ütőkalapács	67
1"		1930LH	Alumínium	2.441	97.1	108.1	282	7,1	Dupla ütőkalapács	17.4
1"		1930LA	Alumínium	2.445	95.6	97.1	460	10,6	Dupla ütőkalapács	3,6
1"		1930HLA	Alumínium	3.661	99	101	460	16,4	Dupla ütőkalapács	16,4
1 1/2"		1930ZL	Alumínium	4.068	102.4	113.4	480	15	Dupla ütőkalapács	69.6

ÚTMUTATÓ A PNEUMATIKUS SZERSZÁMOK KIVÁLASZTÁSÁHOZ

PNEUMATIKUS ÜTVECSAVARBEHAJTÓK

■	TERMÉK	KATALÓGUSSZÁM	 max. Nm	 db (A) LpA	 db (A) LpW	 l/min.	 kg	 m/s ²
1/4"		1921B1	24	96	85	90	0,4	2.6
1/4"		1921M1	27	84	88	96	0,6	1.8
1/4"		1922P1	68	90.6	101.6	88	0,6	8.61
3/8"		1921M2	27	84	88	96	0,6	1.8
3/8"		1922P2	68	90.6	101.6	88	0,6	8.61
1/2"		1921N3	68	80	87	140	1,2	2.6
1/2"		1922P3	136	94.9	105.9	113	1,5	18.28

KÖSZÖRŰK

	TERMÉK	KATALÓGUSSZÁM	MOTORTELEJESÍTMÉNY	 db (A) LpA	 db (A) LpW	 l/min.	 kg	 m/s ²
		1933	0,20 kW	80.0	87.0	230	0,38	4.53
		1933L	0,20 kW	80.0	87.0	270	0,67	1.15
		1933AN90	0,20 kW	80.0	87.0	230	0,51	1.24
		1933I	0,38 kW	80.0	87.0	260	0,67	4.53
		1933IL	0,38 kW	79.0	97.0	113	1,4	1.6
		1933IH	0,75 kW	88.1	99.1	370	0,8	2.6
		1933ILH	0,75 kW	85.7	96.7	370	1,2	1.4
		1933AN90-H	0,75 kW	85.6	96.6	370	1,1	6.7
		1934MAV	0,04 kW	71	76	115	0,2	2.5
		1934MAV70	0,08 kW	80	87	115	0,2	4

1921B1

Baby-irányváltós racsn

1/4"

CE



Üresjárat fordulatszám	350 fordulat/perc
Max. nyomaték	24 Nm
Csavar Ø	CI 8.8 M7●11 mm
Csavar Ø	CI 12.9 M6●10 mm
Levegőcsatlakozás	1/4" GAS
Üzemi nyomás	6,2 bar
Ajánlott tömlő-Ø	8 mm
Átlagos levegőfelhasználás	68 l/perc
Súly	0,4 kg

"	kg	Ft		
1/4	0,6	97.500	1	019210001

1921M1

irányváltós racsn, kompakt kivitel

• Sebességszabályozás

1/4"

CE



Üresjárat fordulatszám	200 fordulat/perc
Max. forgatónyomaték	27 Nm
Csavar Ø	CI 8.8 M7●11 mm
Csavar Ø	CI 12.9 M6●10 mm
Levegőcsatlakozás	1/4" GAS
Üzemi nyomás	6,2 bar
Ajánlott tömlő-Ø	8 mm
Átlagos levegőfelhasználás	96 l/perc
Súly	0,6 kg

"	kg	Ft		
1/4	0,6	85.800	1	019210005

1921M2

irányváltós racsn, kompakt kivitel

• Sebességszabályozás

3/8"

CE



Üresjárat fordulatszám	200 fordulat/perc
Max. forgatónyomaték	27 Nm
Csavar Ø	CI 8.8 M7●11 mm
Csavar Ø	CI 12.9 M6●10 mm
Levegőcsatlakozás	1/4" GAS
Üzemi nyomás	6,2 bar
Ajánlott tömlő-Ø	8 mm
Átlagos levegőfelhasználás	96 l/perc
Súly	0,6 kg

"	kg	Ft		
3/8	0,6	85.800	1	019210015

1921N3

irányváltós racsn

• Sebességszabályozás

1/2"

CE



Üresjárat fordulatszám	150 fordulat/perc
Max. forgatónyomaték	68 Nm
Csavar Ø	CI 8.8 M10●16 mm
Csavar Ø	CI 12.9 M8●13 mm
Levegőcsatlakozás	1/4" GAS
Üzemi nyomás	6,2 bar
Ajánlott tömlő-Ø	10 mm
Átlagos levegőfelhasználás	140 l/perc
Súly	1,2 kg

"	kg	Ft		
1/2	1,2	85.800	1	019210025

1922P1

csúszóalapácsos irányváltós racsn

• Impulzív "Kettős rocking dog" mechanizmus

1/4"

CE



Szabad fordulatszám	700 ford/perc
Legnagyobb nyomaték	68 Nm
Csavar/anya méret	CI 8.8 M10●16 mm
Csavar/anya méret	CI 12.9 M8●13 mm
Levegőcsatlakozó	1/4" GAS
Üzemi nyomás	6,2 bar
levegőcső belső Ø	10 mm
Átlagos levegőfogyasztás	88 l/p
Súly	0,6 kg

"	kg	Ft		
1/4	0,6	120.600	1	019220006

1922P2

csúszóalapácsos irányváltós racsn

• Impulzív "Kettős rocking dog" mechanizmus

3/8"

CE



Szabad fordulatszám	700 ford/perc
Legnagyobb nyomaték	68 Nm
Csavar/anya méret	CI 8.8 M10●16 mm
Csavar/anya méret	CI 12.9 M8●13 mm
Levegőcsatlakozó	1/4" GAS
Üzemi nyomás	6,2 bar
levegőcső belső Ø	10 mm
Átlagos levegőfogyasztás	88 l/p
Súly	0,6 kg

"	kg	Ft		
3/8	0,6	120.600	1	019220010

1922P3

csúszóalapácsos irányváltós racsn

• Impulzív "Kettős rocking dog" mechanizmus

1/2"

CE



Szabad fordulatszám	600 ford/perc
Legnagyobb nyomaték	136 Nm
Csavar/anya méret	CI 8.8 M12●18 mm
Csavar/anya méret	CI 12.9 M10●16 mm
Levegőcsatlakozó	1/4" GAS
Üzemi nyomás	6,2 bar
levegőcső belső Ø	10 mm
Átlagos levegőfogyasztás	113 l/p
Súly	1,5 kg

"	kg	Ft		
1/2	1,5	197.300	1	019220013

1924F

kompakt "butterfly" irányváltós csavarbehajtó

• Impulzív "Kettős rocking dog" mechanizmus

3/8"

CE



Szabad fordulatszám	12 000 ford/perc
Legnagyobb nyomaték	108 Nm
Csavar/anya méret	CI 8.8 M12●18 mm
Csavar/anya méret	CI 12.9 M10●16 mm
Levegőcsatlakozó	1/4" GAS
Üzemi nyomás	6,2 bar
levegőcső belső Ø	10 mm
Átlagos levegőfogyasztás	59 l/p
Súly	0,5 kg

"	kg	Ft		
3/8	0,5	100.900	1	019240025



1924B

Írányváltós ütvecsavarbehajtó, kompakt kivitel

- "Pin Clutch" ütőmechanizmus



Üresjárat fordulatszám	10.000 fordulat/perc
Max. forgatónyomaték	353 Nm
Csavar Ø	CI 8.8 M16 ● 24 mm
Csavar Ø	CI 12.9 M14 ● 21 mm
Levegőcsatlakozás	1/4" GAS
Üzemi nyomás	6,2 bar
Ajánlott tömlő Ø	8 mm
Átlagos levegőfelhasználás	80 l/perc
Súly	1,5 kg

■	kg	Ft	1	019240021
3/8	1,5	110.300		

1924XM

Írányváltós ütvecsavarbehajtó

- Szimpla ütőmechanizmus



Üresjárat fordulatszám	9 000 fordulat/perc
Max. forgatónyomaték	515 Nm
Csavar Ø	CI 8.8 M16 < 34 mm
Csavar Ø	CI 12.9 M14 < 27 mm
Levegőcsatlakozás	1/4" GAS
Üzemi nyomás	6,2 bar
Ajánlott tömlő Ø	10 mm
Átlagos levegőfelhasználás	122 l/perc
Súly	1,3 kg

■	kg	Ft	1	019240030
3/8	1,3	95.200		

1927B/K5

Írányváltós ütvecsavarozó, alumínium, 5 gépi dugókulccsal, táskában



Üresjárat fordulatszám	7 000 fordulat/perc
Max. forgatónyomaték	705 Nm
Csavar Ø	CI 8.8 M22 ● 34 mm
Csavar Ø	CI 12.9 M18 ● 27 mm
Levegőcsatlakozás	1/4" GAS
Üzemi nyomás	6,2 bar
Ajánlott tömlő Ø	10 mm
Átlagos levegőfelhasználás	133 l/perc
Súly	2,1 kg

■	kg	Ft	1	019270122
1/2	3,5	98.350		
350x305x86 mm				

1924CD

Írányváltós ütvecsavarbehajtó plattírozott anyagból

- dupla ütőmechanizmus



Üresjárat fordulatszám	10.000 fordulat/perc
Max. nyomaték	410 Nm
Csavar Ø	CI 8.8 M16 ● 24 mm
Csavar Ø	CI 12.9 M14 ● 21 mm
Levegőcsatlakozás	1/4" GAS
Üzemi nyomás	6,2 bar
Ajánlott tömlő Ø	8 mm
Átlagos levegőfogyasztás	79 l/perc
Súly	1,3 kg

■	kg	Ft	1	019240007
3/8	1,3	152.100		

1927B

Írányváltós csavarbehajtó

- Impulzív "Pin Clutch" mechanizmus



Üresjárat fordulatszám	7 000 ford/perc
Legnagyobb nyomaték	705 Nm
Csavar/anya méret	CI 8.8 M22 ● 34 mm
Csavar/anya méret	CI 12.9 M18 ● 27 mm
Levegőcsatlakozó	1/4" GAS
Üzemi nyomás	6,2 bar
Levegőcső belső Ø	10 mm
Átlagos levegőfogyasztás	133 l/p
Súly	2,1 kg

■	kg	Ft	1	019270022
1/2	2,1	85.800		

1927CD

Írányváltós ütvecsavarbehajtó plattírozott anyagból

- dupla ütőmechanizmus



Üresjárat fordulatszám	7.000 fordulat/perc
Max. forgatónyomaték	1.020 Nm
Csavar Ø	CI 8.8 M22 ● 34 mm
Csavar Ø	CI 12.9 M18 ● 27 mm
Levegőcsatlakozás	1/4" GAS
Üzemi nyomás	6,2 bar
Ajánlott tömlő Ø	10 mm
Átlagos levegőfelhasználás	130 l/perc
Súly	2,3 kg

■	kg	Ft	1	019270007
1/2	2,3	179.500		

1927CD/K3

irányváltós csavarbehajtó és három gépi dugókulcs készlet

- Kétkalapácsos ütőmechanizmus

12"
CE



720LC17-19-21 mm

Szabad fordulatszám	7.000 ford./perc
Legnagyobb nyomaték	1.020 Nm
Csavar/anya méret	CI 8.8 M22●34 mm
Csavar/anya méret	CI 12.9 M18●27 mm
Levegőcsatlakozó	1/4" GÁZ
Üzemi nyomás	6,2 bár
Levegő cső belső Ø	10 mm
Átlagos levegőfogyasztás	130 l/perc
Súly	1,9 kg

1/2"	kg	Ft	1	019270107
350x305x86 mm	4	194.900		

1927P/K3

irányváltós ütvecsavarozó kompozit anyagból, 3 gépi dugókulccsal

12"
CE



720LC17-19-21 mm

Üresjárat fordulatszám	7.500 fordulat/perc
Max. forgatónyomaték	1.750 Nm
Csavar Ø	CI 8.8 M24<36 mm
Csavar Ø	CI 12.9 M20<30 mm
Levegőcsatlakozás	1/4" GAS
Üzemi nyomás	6,2 bar
Belső tömlőátmérő (Ø)	10 mm
Átlagos levegőfelhasználás	280 l/perc
Súly	2,9 kg

1/2"	kg	Ft	1	019270118
350x305x86 mm	4	177.300		

1927XM

kompakt irányváltós csavarbehajtó

- Impulzív egykalapácsos mechanizmus

12"
CE



Ø 1/4" GAS BSPT

Szabad sebesség	10.000 ford./perc
Legnagyobb nyomaték	770 Nm
Csavar/anya kapacitás	CI 8.8 M22●34 mm
Csavar/anya kapacitás	CI 12.9 M18●27 mm
Levegőcsatlakozó	1/4" GAS
Üzemi nyomás	6,2 bar
Levegőcső belső Ø	10 mm
Átlagos levegőfogyasztás	122 l/perc
Súly	1,3 kg

1/2"	kg	Ft	1	019270030
350x305x86 mm	1,3	112.700		

1927P

irányváltós ütvecsavarbehajtó, jobbos-balos, plattírozott anyagból

- Dupla ütőmechanizmus

12"
CE



Ø 1/4" GAS BSP

Üresjárat fordulatszám	7.500 fordulat/perc
Max. forgatónyomaték	1.750 Nm
Csavar-Ø	CI 8.8 M24●36 mm
Csavar-Ø	CI 12.9 M20●30 mm
Levegőcsatlakozás	1/4" GAS
Üzemi nyomás	6,2 bar
Ajánlott tömlő-Ø	10 mm
Átlagos levegőfelhasználás	290 l/perc
Súly	2 kg

1/2"	kg	Ft	1	019270008
350x305x86 mm	2,0	139.800		

1927PAL

irányváltós ütvecsavarbehajtó plattírozott anyagból

- Dupla ütőmechanizmus
- 2" hosszú szár

12"
CE



Ø 1/4" GAS BSP

Üresjárat fordulatszám	7 500 fordulat/perc
Max. forgatónyomaték	1.750 Nm
Csavar Ø	CI 8.8 M24<36 mm
Csavar Ø	CI 12.9 M20<30 mm
Levegőcsatlakozás	1/4" GAS
Üzemi nyomás	6,2 bar
Ajánlott tömlő Ø	10 mm
Átlagos levegőfelhasználás	290 l/perc
Súly	2,2 kg

1/2"	kg	Ft	1	019270009
350x305x86 mm	2,2	189.400		

1927XM/K5

irányváltós kompakt csavarbehajtó és 5 gépi dugókulcs készlet

- Egykalapácsos ütőmechanizmus

12"
CE



720 17-19-21-22-24 mm

Szabad fordulatszám	10.000 ford./perc
Legnagyobb nyomaték	770 Nm
Csavar/anya méret	CI 8.8 M22●34 mm
Csavar/anya méret	CI 12.9 M18●27 mm
Levegőcsatlakozás	1/4" GÁZ
Üzemi nyomás	6,2 bár
cső belső Ø	10 mm
Átlagos levegőfogyasztás	122 l/perc
Súly	1,3 kg

1/2"	kg	Ft	1	019270129
307x206x86 mm	2,8	125.800		

1927AN

Írányváltós sarokütevcsavarbehajtó, jobbos-balos

- Egy ütőműves

1/2"

CE



Üresjárat fordulatszám	4.700 fordulat/perc
Max. forgatónyomaték	244 Nm
Csavar-Ø	CI 8.8 M14 ● 21 mm
Csavar-Ø	CI 12.9 M12 ● 19 mm
Levegőcsatlakozás	1/4" GAS
Üzemi nyomás	6,2 bar
Ajánlott tömlő-Ø	10 mm
Átlagos levegőfelhasználás	190 l/perc

1/2"	kg	Ft	1	019270012
	2,1	197.300		

1927G

kompakt irányváltós csavarbehajtó

- Egyes ütőmechanizmus

1/2"

CE



Üresjárat fordulatszám	8500 ford/perc
Legnagyobb nyomaték	325 Nm
Csavar/anya méret	CI 8.8 M16 ● 24 mm
Csavar/anya méret	CI 12.9 M14 ● 21 mm
Levegőcsatlakozó	1/4" GAS
Üzemi nyomás	6,2 bar
Levegőcső belső Ø	10 mm
Átlagos levegőfogyasztás	113 l/p
Súly	1,2 kg

1/2"	kg	Ft	1	019270050
	1,2	181.200		

1927SP-AM

mágneses tartó pneumatikus csavarbehajtóhoz

- két nagymegtartású, védőgumival szerelt mágnessel rendelkezik
- egy 1/2" csavarbehajtó, 4 dugókulcs és 1 nyomatékkulcs elhelyezését teszi lehetővé
- teherbírás: 10 kg



400 g	Ft	1	019270000
	24.050		

1928XM

írányváltós ütvecsavarbehajtó

- Dupla ütőmechanizmus
- Robusztus, kompakt modell, nagy forgatónyomaték
- Egykezes irányváltó gomb
- 3-fokozatú csavarbehajtás
- levegőelvezetés a markolaton keresztül

3/4"

CE



Üresjárat fordulatszám	4 800 fordulat/perc
Max. forgatónyomaték	1 600 Nm
Csavar Ø	CI 8.8 M27 ● 41 mm
Csavar Ø	CI 12.9 M24 ● 36 mm
Levegőcsatlakozás	3/8" GAS
Üzemi nyomás	6,2 bar
Ajánlott tömlő Ø	10 mm
Átlagos levegőfelhasználás	175 l/perc
Súly	2,9 kg

3/4"	kg	Ft	1	019280030
	2,9	281.800		

1928CD

Írányváltós ütvecsavarbehajtó plattírozott anyagból

- dupla ütőmechanizmus

3/4"

CE



Üresjárat fordulatszám	4.500 fordulat/perc
Max. forgatónyomaték	1.800 Nm
Csavar Ø	CI 8.8 M27 ● 41 mm
Csavar Ø	CI 12.9 M24 ● 36 mm
Levegőcsatlakozás	3/8" GAS
Üzemi nyomás	6,2 bar
Ajánlott tömlő Ø	10 mm
Átlagos levegőfelhasználás	215 l/perc
Súly	3,5 kg

3/4"	kg	Ft	1	019280007
	3,5	326.400		

1928DA

Írányváltós ütvecsavarbehajtó

- Dupla ütőmechanizmus

3/4"

CE



Üresjárat fordulatszám	5.000 fordulat/perc
Max. nyomaték	1.695 Nm
Csavar Ø	CI 8.8 M30 ● 46 mm
Csavar Ø	CI 12.9 M27 ● 41 mm
Levegőcsatlakozás	3/8" GAS
Üzemi nyomás	6,2 bar
Ajánlott tömlő Ø	10 mm
Átlagos levegőfelhasználás	240 l/perc
Súly	4,3 kg

3/4"	kg	Ft	1	019280022
	4,3	274.100		

1928DAL

Írányváltós ütvecsavarbehajtó, jobbos-balos

- Dupla ütőmechanizmus
- 6" hosszú meghajtótengely
- Robusztus, kompakt modell; nagy forgatónyomaték
- Egyszerű irányváltás
- 3-fokozatú csavarbehajtás
- Levegőelvezetés a markolaton keresztül
- Ergonómikus, csúszásmentes markolat

3/4"

CE



Üresjárat fordulatszám	5.000 fordulat/perc
Max. forgatónyomaték	1.695 Nm
Csavar Ø	CI 8.8 M27 ● 41 mm
Csavar Ø	CI 12.9 M24 ● 36 mm
Levegőcsatlakozás	3/8" GAS
Üzemi nyomás	6,2 bar
Ajánlott tömlő Ø	10 mm
Átlagos levegőfelhasználás	240 l/perc
Súly	4,8 kg

3/4"	kg	Ft	1	019280023
	4,8	338.500		

1928K4

1 irányváltós ütvecsavarbehajtó, 4 hosszú gépi dugókulcs

- "Pin Clutch" ütőmechanizmus

3/4"
CE



728L 27-30-32-36 mm

Üresjárat fordulatszám	4.000 fordulat/perc
Max. nyomaték	1.493 Nm
Csavar Ø	CI 8.8 M27●41 mm
Csavar Ø	CI 12.9 M24●36 mm
Levegőcsatlakozás	3/8" GAS BSP
Üzemi nyomás	6,2 bar
Ajánlott tömlő Ø	10 mm
Átlagos levegőfelhasználás	260 l/perc
Csavarbehajtó súlya	5,2 kg

3/4"	kg	Ft	1	019280104
410x330x106 mm	9,3	329.700		

1930LH

irányváltós csavarbehajtó

- Kettős ütőmechanizmus

1"
CE



Üresjárat fordulatszám	6 000 ford/perc
Legnagyobb nyomaték	2 441 Nm
Csavar/anya méret	CI 8.8 M36●55 mm
Csavar/anya méret	CI 12.9 M30●46 mm
Levegőcsatlakozó	1/2" GAS
Üzemi nyomás	6,2 bar
Levegőcső belső Ø	13 mm
Átlagos levegőfogyasztás	280 l/p
Súly	7,1 kg

1"	kg	Ft	1	019300030
	7,1	456.000		

1930LA

irányváltós ütvecsavarbehajtó

- Dupla ütőmechanizmus

1"
CE



Üresjárat fordulatszám	4.000 fordulat/perc
Max. forgatónyomaték	2.445 Nm
Csavar Ø	CI 8.8 M36●55 mm
Csavar Ø	CI 12.9 M30●46 mm
Levegőcsatlakozás	1/2" GAS
Üzemi nyomás	6,2 bar
Ajánlott tömlő Ø	13 mm
Átlagos levegőfelhasználás	460 l/perc
Súly	10,6 kg

1"	kg	Ft	1	019300037
	10,6	418.800		

1930CD

irányváltós ütvecsavarbehajtó plattírozott anyagból

- Dupla ütőmechanizmus

1"
CE



Üresjárat fordulatszám	4.000 fordulat/perc
Max. forgatónyomaték	2.445 Nm
Csavar Ø	CI 8.8 M36●55 mm
Csavar Ø	CI 12.9 M30●46 mm
Levegőcsatlakozás	1/2" GAS
Üzemi nyomás	6,2 bar
Ajánlott tömlő Ø	13 mm
Átlagos levegőfelhasználás	320 l/perc
Súly	7,1 kg

1"	kg	Ft	1	019300022
	7,1	537.300		

1930PA

irányváltós ütvecsavarbehajtó

- Dupla ütőmechanizmus

1"
CE



Üresjárat fordulatszám	3.500 fordulat/perc
Max. forgatónyomaték	2.445 Nm
Csavar-Ø	CI 8.8 M36●55 mm
Csavar-Ø	CI 12.9 M30●46 mm
Levegőcsatlakozás	1/2" GAS
Üzemi nyomás	6,2 bar
Ajánlott tömlő-Ø	13 mm
Átlagos levegőfelhasználás	350l/perc
Súly	9,6 kg

1"	kg	Ft	1	019300032
	9,6	412.900		

1930A

irányváltós csavarbehajtó

- Kétkalapácsos ütőmechanizmus

1"
CE



Szabad fordulatszám	4.000 ford./perc
Legnagyobb nyomaték	2.445 Nm
Csavar/anya méret	CI 8.8 M36●55 mm
Csavar/anya méret	CI 12.9 M30●46 mm
Levegőcsatlakozó	1/2" GAS
Üzemi nyomás	6,2 bar
Levegő cső belső Ø	13 mm
Átlagos levegőfogyasztás	460 l/perc
Súly	9,5 kg

1"	kg	Ft	1	019300036
	9,5	485.600		

1930HLA

Íranyváltós ütvecsavarbehajtó

• Dupla ütőmechanizmus

1

CE



Üresjárat fordulatszám	3.000 fordulat/perc
Max. forgatónyomaték	3.661 Nm
Csavar Ø	Cl 8.8 M42 ● 65 mm
Csavar Ø	Cl 12.9 M33 ● 50 mm
Levegőcsatlakozás	1/2" GAS
Üzemi nyomás	6,2 bar
Ajánlott tömlő Ø	13 mm
Átlagos levegőfelhasználás	460 l/perc
Súly	16,4 kg

1	kg	16,4	Ft	707.000	1	019300040
---	----	------	----	---------	---	-----------

1930ZL

Íranyváltós ütvecsavarbehajtó

• Dupla ütőmechanizmus

1/2

CE



Üresjárat fordulatszám	3.000 fordulat/perc
Max. forgatónyomaték	4.068 Nm
Csavar Ø	Cl 8.8 M42 ● 65 mm
Csavar Ø	Cl 12.9 M36 ● 55 mm
Levegőcsatlakozás	1/2" GAS
Üzemi nyomás	6,2 bar
Ajánlott tömlő Ø	13 mm
Átlagos levegőfelhasználás	480 l/perc
Súly	15 kg

1 1/2	kg	15	Ft	886.600	1	019300070
-------	----	----	----	---------	---	-----------

1931CD6

Íranyváltós fúrógép kompozitházzal

ø6

CE



Üresjárat fordulatszám	2.600 fordulat/perc
Fúrótokmány	1÷6 mm
Motorteljesítmény	0,23 kW
Felfogóméret	3/8" - 24UNF
Levegőcsatlakozás	1/4" GAS
Üzemi nyomás	6,2 bar
Ajánlott tömlő-Ø	8 mm
Átlagos levegőfelhasználás	130 l/perc
Súly	0,6 kg

1	kg	0,6	Ft	101.200	1	019310006
---	----	-----	----	---------	---	-----------

1931CD10

Íranyváltós fúrógép kompozitházzal

ø10

CE



Üresjárat fordulatszám	1.800 fordulat/perc
Fúrótokmány	1÷10 mm
Motorteljesítmény	0,38 kW
Felfogóméret	3/8" - 24UNF
Levegőcsatlakozás	1/4" GAS
Üzemi nyomás	6,2 bar
Ajánlott tömlő-Ø	10 mm
Átlagos levegőfelhasználás	170 l/perc
Súly	1 kg

1	kg	1,0	Ft	91.550	1	019310010
---	----	-----	----	--------	---	-----------

1931CD13

Íranyváltós fúrógép kompozitházzal

ø13

CE



Üresjárat fordulatszám	800 fordulat/perc
Fúrótokmány	1,0÷13 mm
Motorteljesítmény	0,38 kW
Felfogóméret	1/2" - 20UNC
Levegőcsatlakozás	1/4" GAS
Üzemi nyomás	6,2 bar
Ajánlott tömlő-Ø	10 mm
Átlagos levegőfelhasználás	170 l/perc
Súly	1,3 kg

1	kg	1,3	Ft	134.900	1	019310013
---	----	-----	----	---------	---	-----------

1931AN10

Íranyváltós sarokfúrógép

ø10

CE



Üresjárat fordulatszám	1.400 fordulat/perc
Fúrótokmány	1÷10 mm
Motorteljesítmény	0,38 kW
Felfogóméret	3/8" - 24UNF
Levegőcsatlakozás	1/4" GAS
Üzemi nyomás	6,2 bar
Ajánlott tömlő-Ø	10 mm
Átlagos levegőfelhasználás	150 l/perc
Súly	1,1 kg

1	kg	1,1	Ft	101.200	1	019310030
---	----	-----	----	---------	---	-----------

1932B10

Írányváltós fúrógép



Üresjárat fordulatszám	1.800 fordulat/perc
Fúrótokmány	1+10 mm
Motorteljesítmény	0,44 kW
Felfogóméret	3/8" - 24UNF
Levegőcsatlakozás	1/4" GAS
Üzemi nyomás	6,2 bar
Ajánlott tömlő-Ø	10 mm
Átlagos levegőfelhasználás	160 l/perc
Súly	1,2 kg

kg	Ft		
1,2	72.850	1	019320040

1932RS13

Írányváltós fúrógép



Üresjárat fordulatszám	750 fordulat/perc
Fúrótokmány	1,5+13 mm
Motorteljesítmény	0,55 kW
Felfogóméret	3/8" - 24UNF
Levegőcsatlakozás	1/4" GAS
Üzemi nyomás	6,2 bar
Ajánlott tömlő-Ø	10 mm
Átlagos levegőfelhasználás	160 l/perc
Súly	1,4 kg

kg	Ft		
1,4	92.750	1	019320043

1932B13

Írányváltós fúrógép



Üresjárat fordulatszám	400 fordulat/perc
Fúrótokmány	1,5+13 mm
Motorteljesítmény	0,34 kW
Felfogóméret	1/2" - 20UNC
Levegőcsatlakozás	1/4" GAS
Üzemi nyomás	6,2 bar
Ajánlott tömlő-Ø	10 mm
Átlagos levegőfelhasználás	180 l/perc
Súly	1,6 kg

kg	Ft		
1,6	106.800	1	019320004

1933IH

nagyteljesítményű egykezes egyenes rúdcsiszoló

• Patron, Ø 3 mm és 6 mm



Üresjárat fordulatszám	20.000 fordulat/perc
Patron	3 - 6 mm
Motorteljesítmény	0,75 kW
Levegőcsatlakozás	1/4" GAS
Üzemi nyomás	6,2 bar
Ajánlott tömlő-Ø	10 mm
Átlagos levegőfelhasználás	370 l/perc
Súly	800 g

g	Ft		
800	72.150	1	019330006



1933ILH

nagyteljesítményű egykezes egyenes hosszított rúdcsiszoló

• Patron, Ø 3 mm és 6 mm

CE



Üresjárat fordulatszám	20.000 fordulat/perc
Patron	3 - 6 mm
Motorteljesítmény	0,75 kW
Levegőcsatlakozás	1/4" GAS
Üzemi nyomás	6,2 bar
Ajánlott tömlő-Ø	10 mm
Átlagos levegőfelhasználás	370 l/perc
Súly	1,2 kg

kg	Ft		
1,2	135.700	1	019330011

1933AN90-H

nagyteljesítményű sarokcsiszoló

• Patron, Ø 3 mm és 6 mm

CE



Üresjárat fordulatszám	15 000 fordulat/perc
Patron	3 - 6 mm
Motorteljesítmény	0,75 kW
Levegőcsatlakozás	1/4" GAS
Üzemi nyomás	6,2 bar
Ajánlott tömlő-Ø	10 mm
Átlagos levegőfelhasználás	370 l/perc
Súly	1,1 kg

kg	Ft		
1,1	135.300	1	019330021

1933

Egykezes egyenes rúdcsiszoló

• Szállítás 3 - 6 mm-es patronnal

CE



Üresjárat fordulatszám	25.000 fordulat/perc
Patron	3 - 6 mm
Motorteljesítmény	0,20 kW
Levegőcsatlakozás	1/4" GAS
Üzemi nyomás	6,2 bar
Ajánlott tömlő-Ø	10 mm
Átlagos levegőfelhasználás	230 l/min
Súly	380 g

g	Ft		
380	53.800	1	019330001

1933I

Egykezes egyenes rúdcsiszoló

• Szállítás: 3-6 mm patronnal

CE



Üresjárat fordulatszám	20.000 fordulat/perc
Patron	3 - 6 mm
Motorteljesítmény	0,38 kW
Levegőcsatlakozás	1/4" GAS
Üzemi nyomás	6,2 bar
Ajánlott tömlő-Ø	10 mm
Átlagos levegőfelhasználás	260 l/min
Súly	670 g

670 g 61.400 Ft 1 019330005

1933L

Egykezes egyenes hosszított rúdcsiszoló

• Szállítás: 3-6 mm patronnal

CE



Üresjárat fordulatszám	25.000 fordulat/perc
Patron	3 - 6 mm
Motorteljesítmény	0,20 kW
Levegőcsatlakozás	1/4" GAS
Üzemi nyomás	6,2 bar
Ajánlott tömlő-Ø	10 mm
Átlagos levegőfelhasználás	270 l/min
Súly	670 g

670 g 68.800 Ft 1 019330015

1933IL

Egykezes egyenes hosszított rúdcsiszoló

• Szállítás: 3-6 mm patronnal

CE



Üresjárat fordulatszám	20.000 fordulat/perc
Patron	3 - 6 mm
Motorteljesítmény	0,38 kW
Levegőcsatlakozás	1/4" GAS
Üzemi nyomás	6,2 bar
Ajánlott tömlő Ø	10 mm
Átlagos levegőfelhasználás	113 l/min
Súly	1,4 kg

1,4 kg 82.550 Ft 1 019330010

1933AN90

Egykezes sarokcsiszoló

• Szállítás: 3-6 mm patronnal

CE



Üresjárat fordulatszám	20.000 fordulat/perc
Patron	3 - 6 mm
Motorteljesítmény	0,20 kW
Levegőcsatlakozás	1/4" GAS
Üzemi nyomás	6,2 bar
Ajánlott tömlő-Ø	10 mm
Átlagos levegőfelhasználás	230 l/min
Súly	510 g

510 g 68.800 Ft 1 019330020

1934BV

Alacsonyfordulatú gumiabroncs polírozó

• Szállítás: 3-6 mm patronnal

CE



Üresjárat fordulatszám	3.700 fordulat/perc
Patron	3 - 6 mm
Motorteljesítmény	0,37 kW
Levegőcsatlakozás	1/4" GAS
Üzemi nyomás	6,2 bar
Ajánlott tömlő-Ø	10 mm
Átlagos levegőfelhasználás	113 l/min
Súly	0,84 kg

840 g 73.350 Ft 1 019340000



1934MAV

Egykezes mikro rúdcsiszoló

CE



Üresjárat fordulatszám	56.000 fordulat/perc
Patron	3 mm
Motorteljesítmény	0,04 kW
Levegőcsatlakozás	1/4" GAS BSPT
Üzemi nyomás	6,2 bar
Ajánlott tömlő-Ø	4,5 mm
Átlagos levegőfelhasználás	115 l/min
Súly	0,2 kg

205 g 63.850 Ft 1 019340010

1934MAV70

Nagy fordulatszámú Mikro-egykezes rúdcsiszoló

CE



Üresjárat fordulatszám	70.000 fordulat/perc
Patron	3 mm
Motorteljesítmény	0,08 kW
Levegőcsatlakozás	1/4" GAS BSPT
Üzemi nyomás	6,2 bar
Ajánlott tömlő-Ø	4,5 mm
Átlagos levegőfelhasználás	115 l/min
Súly	0,21 kg

210 g 105.500 Ft 1 019340030

1935F

Írányváltós csavarbehajtó



kg	Ft	1	019350045
1,3	103.100		

1936/4A

Sarokcsiszoló



kg	Ft	1	019360024
1,8	167.100		

1936/5A

Sarokcsiszoló



kg	Ft	1	019360025
1,9	167.100		

1936/7A

Sarokcsiszoló



kg	Ft	1	019360027
2,7	223.900		

1937

Excentercsiszoló mintázott markolattal, kenés nélkül, plattírozott anyagból

• Rezgőkör keresztmetszete 5 mm



kg	Ft	1	019370001
0,86	180.000		

1937R/P

Csiszolótányér Ø 150 mm, 6-lyukú perforált a 1937-hez



Ft	1	019370002
18.600		

1937KC

mini excenteres csiszoló

- 2 db csiszolótányér Ø 50 mm és Ø 75 mm
- 10 db csiszolópapír tárcsa Ø 50 mm finomság 400, 600, 800
- 10 db csiszolópapír tárcsa Ø 75 mm finomság 400, 600, 800



kg	Ft	1	019370171
1,4	100.100		



1937C...

csiszolópapír tárcsa a 1937KC készülékhez



Ø mm	P	Ft		
50	400	5.730	1	019370175
50	600	5.730	1	019370176
50	800	5.730	1	019370177
75	400	7.400	1	019370178
75	600	7.400	1	019370179
75	800	7.400	1	019370180

* A jelzett árak 10 darabra vonatkoznak

1937KL

mini polírozó

- Csiszolóanyag Ø 75 mm
- 2 csiszolószivacs Ø 90 mm - 1937/KL-DSB, 1937/KL-DSG
- Baránygyapjú Ø 90 mm - 1937/KL-DLA

CE



Szabad sebesség	3.200 ford/perc
Teljesítmény	0,25 kW
Csiszolóanyag méret	75 mm
Tengely csavarment	M6
Levegőcsatlakozó	1/4" GAS BSPT
Üzemi nyomás	6,2 bár
cső belső Ø	10 mm
Átlagos levegőfogyasztás	91 l/perc
Polírozó készülék súlya	0,75 kg
Készlet súlya	1,8 kg

kg	Ft		
1,8	109.600	1	019370161

1937KL-D

tartozékok a 1937/KL polírozógéphez



Ø mm	Ft		
1937KL-DLA 90	9.610	1	019370164
1937KL-DSB 90	9.610	1	019370165
1937KL-DSG 90	9.610	1	019370166

1937K...

csiszolóanyagok a 1937KC és 1937KL készülékekhez



Ø mm	1937KC	1937KL	Ft		
1937KC-RP 50	•		10.400	1	019370173
1937KL-RP 75	•	•	12.950	1	019370163

1937M

Multifunkciós-csiszoló 16 tartozékkal

CE



Üresjárat fordulatszám	3.500 fordulat/perc
Motorteljesítmény	0,34 kW
Levegőcsatlakozás	1/4" GAS
Üzemi nyomás	6,2 bar
Ajánlott tömlő-Ø	10 mm
Átlagos levegőfelhasználás	113 l/min
Csiszológép súlya	1,5 kg
Szerszámkészlet súlya	4,5 kg

kg	Ft		
4,5	300.800	1	019370011

458x495x116 mm

1937M-01÷11

Tartozék a 1937M modellhez



L mm	1937M-	Ft		
1937M-01 30		11.050	1	019370101
1937M-02 30		11.050	1	019370102
1937M-03 11		9.680	1	019370103
1937M-04 23		9.680	1	019370104
1937M-05 11		9.680	1	019370105
1937M-06 23		9.680	1	019370106
* 1937M-07 16		27.550	1	019370107
1937M-08 13	07	9.680	1	019370108
1937M-09 26	07	9.680	1	019370109
1937M-10 11	03, 05	9.680	1	019370110
1937M-11 23	01, 02, 04, 06	9.680	1	019370111

* A megadott árak 6 darabra vonatkoznak

1937N10

Szalagcsiszológép 10 mm

CE



Üresjárat fordulatszám	20.000 fordulat/perc
Motorteljesítmény	0,37 kW
Szalagméret	10x330 mm
Levegőcsatlakozás	1/4" GAS
Üzemi nyomás	6,2 bar
Ajánlott tömlő Ø	10 mm
Átlagos levegőfelhasználás	374 l/min
Súly	0,9 kg

kg	Ft		
0,9	118.100	1	019370041

1937N10-GR

Csiszolószalag a 1937N10 modellhez



P	Ft		
1937N10-GR60 60	12.350	1	019370146
1937N10-GR80 80	12.350	1	019370148
1937N10-GR100 100	12.350	1	019370150
1937N10-GR120 120	12.350	1	019370152

A megadott árak 10 darabra vonatkoznak

1937N20

Szalagcsiszoló

CE



Üresjárat fordulatszám	16.000 fordulat/perc
Motorteljesítmény	0,45 kW
Szalagméret	20x520 mm
Levegőcsatlakozás	1/4" GAS
Üzemi nyomás	6,2 bar
Ajánlott tömlő Ø	10 mm
Átlagos levegőfelhasználás	400 l/min
Súly	1,6 kg

kg	Ft		
1,6	137.400	1	019370051

1937N20-GR

Csiszolószalag a 1937N20 modellhez



	P	Ft		
1937N20-GR60	60	15.950	1	019370156
1937N20-GR80	80	15.950	1	019370158
1937N20-GR100	100	15.950	1	019370160
1937N20-GR120	120	15.950	1	019370162

A megadott árak 10 darabra vonatkoznak

1938

Szélvédőkivágó

• 1 egyenes 57 mm-es penge

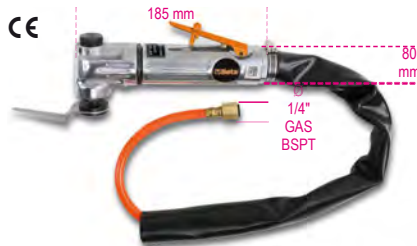

Rezgés/perc	20.000
Levegőcsatlakozás	1/4" GAS
Üzemi nyomás	6,2 bar
Ajánlott tömlő-Ø	6,5 mm
Átlagos levegőfelhasználás	200 l/min
Súly	1,0 kg

kg	Ft		
1,0	92.500	1	019380021

1938R/L

Pengék szélvédőkivágóhoz

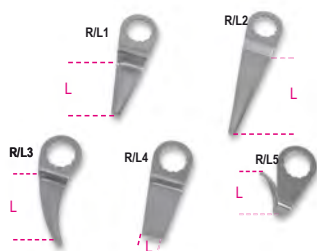

	L mm	Ft		
1938R/L1	57	7.690	1	019380041
1938R/L2	90	14.450	1	019380042
1938R/L3	30	8.730	1	019380043
1938R/L4	8	12.450	1	019380044
1938R/L5	36	14.150	1	019380045

1938R/S5

5 darabos pengekészlet a 1938-hoz

1938R/S5	Ft		
	57.450	1	019380055

1940

légkalapács

• Kalapácsrugóval és gyorsan cserélhető hatszög-tokmánnal



Ütésszám/perc	3 500
Véső csatlakozási méret	Ø 11 mm
Dugattyú méret	19 mm
Dugattyú löket	67 mm
Levegőcsatlakozás	1/4" GAS
Üzemi nyomás	6,2 bar
Ajánlott tömlő Ø	8 mm
Átlagos levegőfelhasználás	240 l/perc
Súly	1,9 kg

kg	Ft		
1,9	76.050	1	019400001

1940/C6

légkalapács 5 vésővel és kiegészítőkkel

• Fémlemezek, csapszeg és karosszéria vágására, hegesztési pontok, szegecsek, vakolat- és csempe eltávolítására alkalmas

• A praktikus ABS szerszámtáskában szállított készlet a következő elemeket tartalmazza:

- 1 légkalapács (1940)
- 1 lapos véső (1940SN)
- 1 bontó véső (1940ST)
- 1 hegyesvéső (1940SD)
- 1 hajlított véső (1940SPS)
- 1 lemezvágó véső (1940SDT)
- 1 kalapácsrugó (1940MT)
- 1 bajonettzár hatszögű vésőszarakhoz



Ütésszám/perc	3.500
Véső csatlakozási méret	Ø 11 mm
Dugattyú méret	19 mm
Dugattyú löket	67 mm
Levegőcsatlakozás	1/4" GAS
Üzemi nyomás	6,2 bar
Ajánlott tömlő Ø	8 mm
Átlagos levegőfelhasználás	240 l/min
Súly	3,3 kg

kg	Ft		
3,3	109.700	1	019400000

320x240x90 mm

1940MT

Tartalék kalapácsrugó az 1940 típusú pneumatikus kalapács



1940MT	Ft		
	4.730	5	019400110

1940S...

Véső az 1940 modellhez



1940SN	Ft		
	5.760	5	019400020
1940ST	Ft		
	5.760	5	019400021
1940SD	Ft		
	5.760	5	019400022
1940SPS	Ft		
	5.760	5	019400023
1940SDT	Ft		
	5.760	5	019400024

1940/S5

5-részes vésőkészlet az 1940 modellhez



1940/S5	Ft		
	26.200	1	019400030

1940E10

légkalapács

• kompatibilis a 10 mm-es hatlapfejű csatlakozású vésőkkel
• kalapácsrugóval és bajonettzáras biztonsági tartóelemmel szállítva



Ütésszám/perc	2 900
Csatlakozó méret	Ø 10 mm
Dugattyú méret	19 mm
Dugattyú löket	67 mm
Véső csatlakozási méret	1/4" GAS
Üzemi nyomás	6,2 bar
Ajánlott tömlő Ø	10 mm
Átlagos levegőfelhasználás	76 l/perc
Súly	1,7 kg

kg	Ft		
1,7	83.800	1	019400010

1940E10/MT

tartórugó a 1940E10 légkalapáczhoz



1940E10/MT	Ft	5	019400112
	625		

1940E10/S...

vésők a 1940E10 légkalapáczhoz



1940E10/SN	Ft	5	019400040
1940E10/ST	4.120	5	019400041
1940E10/SD	4.120	5	019400042
1940E10/SPS	4.120	5	019400043
1940E10/SDT	4.120	5	019400044

1940E10/S5

5 vésőből álló sorozat a 1940E10 légkalapáczhoz



1940E10/S5	Ft	1	019400050
	20.600		

1942A

Levegős fűrés

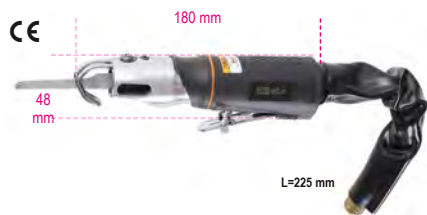

Löklet/perc.	10.000
Lökethosszúság	10 mm
Levegőcsatlakozás	1/4" GAS BSP
Üzemi nyomás	6,2 bar
Ajánlott tömlő-Ø	8 mm
Átlagos levegőfelhasználás	75 l/min
Súly	550 g

550	Ft	1	019420000
	125.600		

1942LR

Bimetal-fűrészlapp 1942A modellhez



1942LR	Ft	5	019420032
	2.830		

1944A

axiális tűs revétlenítő

CE



Percenkénti ütészám	3.800
Dugattyú löket	33 mm
Tűszám	19
Tű Ø	3 mm
Levegőcsatlakozó	1/4" GAS
Üzemi nyomás	6,2 bar
Levegőcső belső Ø	10 mm
Átlagos levegőfogyasztás	85 l/p
Súly	2,8 kg

2,8	Ft	1	019440011
	134.500		

1944N

tűs revétlenítő



Percenkénti ütészám	3800
Dugattyú löket	33 mm
Tűszám	19
Tű Ø	3 mm
Levegőcsatlakozó	1/4" GAS
Üzemi nyomás	6,2 bar
Levegőcső belső Ø	8 mm
Átlagos levegőfogyasztás	85 l/p
Súly	2,7 kg

2,7	Ft	1	019440002
	171.300		

1944AR

Tűs készlet az 1944A-1944N típusú revétlenítőhöz



1944AR 2	Ø	n.	Ft	1	019440015
	2	29	18.050		
1944AR 3	3	19	14.200	1	019440005

1944PA

tűtartó talp a 1944N és 1944A készülékekhez



1944PA 2	Ø	N.	Ft	1	019440016
	2	29	20.100		
1944PA 3	3	19	15.250	1	019440006

1945S

tűzőgép

• Használt tűzőkapocs típus 80, keresztmetszet 0,95 x 0,65 mm (21 Gauge), hosszúság 4 - 16 mm, szélesség 12,8 mm



Tárkapacitás	157 db.
Levegőcsatlakozó	1/4" GÁZ
Üzemi nyomás	4,2 - 7 bar
Levegőcső belső Ø	8 mm
Levegőfogyasztás (7 bar)	0,34 l/ciklus
Súly	0,87 kg

0,9	Ft	1	019450000
	78.750		

1945S/G...

tűzőkapocs, 80-as típus, 0,95x0,65 mm (21 vastag), szélesség 12,8 mm, 1945S modellhez



• 1945S/G4	L	Ft	1	019450004
	4	7.550		
1945S/G6	6	2.920	1	019450006
1945S/G8	8	3.260	1	019450008
1945S/G10	10	3.600	1	019450010
1945S/G12	12	4.030	1	019450012
1945S/G14	14	4.390	1	019450014
1945S/G16	16	4.800	1	019450016

Az árak 5 000 darabra vonatkoznak
• Az árak 10 000 darabra vonatkoznak



1945C

kombinált tűző és szegező gép

- Használt kapocs típus 90, keresztmetszet 1,25 x 1,0 mm (18 Gauge), hosszúság 16 - 40 mm, szélesség 5,8 mm
- Használt bognárszeg típus B12, keresztmetszet 1,25 x 1,0 mm (18 Gauge), fejméret 1,9 mm



Tárkapacitás	100 db.
Levegőcsatlakozó	1/4" GÁZ
Üzemi nyomás	5 - 8 bar
Levegőcső belső Ø	8 mm
Levegőfogyasztás (7 bar)	1,12 l/ciklus
Súly	1,16 kg

kg	Ft	1	019450200
1,16	113.400		

1945C/G...

tűzőkapocs, 90-es típus, 1,25x1,0 mm (18 vastag), szélesség 5,8 mm, 1945C modellhez

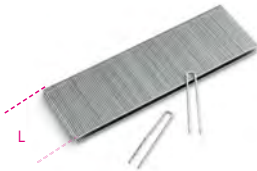

	L mm	Ft	1	
1945C/G16	16	5.860	1	019450216
1945C/G19	19	6.910	1	019450219
1945C/G22	22	7.580	1	019450222
1945C/G25	25	8.870	1	019450225
1945C/G28	28	9.410	1	019450228
1945C/G32	32	10.950	1	019450232
1945C/G35	35	11.800	1	019450235
1945C/G38	38	13.150	1	019450238
1945C/G40	40	14.100	1	019450240

Az árak 5 000 darabra vonatkoznak.

1945C/GP...

bognárszeg, B12-es típus, 1,25x1,0 mm (18 Gauge), fejméret 1,9 mm, 1945C modellhez

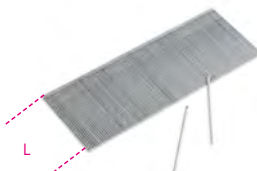

	L mm	Ft	1	
1945C/GP15	15	3.030	1	019450255
1945C/GP16	16	3.140	1	019450256
1945C/GP20	20	3.750	1	019450260
1945C/GP25	25	4.320	1	019450265
1945C/GP30	30	5.060	1	019450270
1945C/GP32	32	5.530	1	019450272
1945C/GP35	35	5.890	1	019450275
1945C/GP38	38	6.430	1	019450278
1945C/GP40	40	6.570	1	019450280
1945C/GP45	45	7.250	1	019450285
1945C/GP50	50	7.930	1	019450290

Az árak 5 000 darabra vonatkoznak.



1945P

tűzőgép

- Használt tű típus B6, Ø 0,64 mm (23 Gauge), hosszúság 12 - 35 mm



Tárkapacitás	145 db.
Levegőcsatlakozó	1/4" GÁZ
Üzemi nyomás	4 - 7 bar
Levegőcső belső Ø	8 mm
Levegőfogyasztás (7 bar)	0,27 l/ciklus
Súly	0,87 kg

kg	Ft	1	019450100
0,87	123.800		

1945P/S...

tű, B6 típus, Ø 0,64 mm (23 Gauge), a 1945P modellhez



	L mm	Ft	1	
1945P/S12	12	3.560	1	019450112
1945P/S15	15	3.920	1	019450115
1945P/S18	18	4.260	1	019450118
1945P/S20	20	4.890	1	019450120
1945P/S21	21	4.950	1	019450121
1945P/S22	22	5.080	1	019450122
1945P/S25	25	5.490	1	019450125
1945P/S30	30	6.250	1	019450130
1945P/S35	35	7.190	1	019450135

Az árak 10 000 darabra vonatkoznak.

1946T

szegecs húzó

- cserélhető húzófejekkel 2,4 - 3,2 - 4,0 - 4,8 mm méretű acél, rozsdamentes acél, alumínium és vörösréz szegecszekhez



Húzóteljesítmény	9 000 N
Lökethossz	16 mm
Legnagyobb szegecs méret	Ø rozsdamentes acél 4,8 mm
Levegőcsatlakozó	1/4" GÁZ
Üzemi nyomás	6,2 bar
Levegőcső belső Ø	8 mm
Levegőfogyasztás	2,0 l/ciklus
Súly	1,7 kg

kg	Ft	1	019460021
1,7	118.200		

1946C4,8

szegecs húzó

- Automatikus beszívással
- Összeszerelve szállítjuk 2,4 - 3,2 - 4,0 - 4,8 mm méretű acél, rozsdamentes acél, alumínium és réz szegecszekhez



Húzóerő	8.900 N
Lökethossz	15 mm
Legnagyobb szegecsméret	Ø rozsdamentes acél 4,8 mm
Levegőcsatlakozó	1/4" GÁZ
Üzemi nyomás	6,2 bar
Levegőcső belső Ø	10 mm
Levegő fogyasztás	2,6 l/ciklus
Súly	1,5 kg

kg	Ft	1	019460006
1,5	242.900		



1946C7,8

szegecshúzó

- Automatikus beszívással
- Összeszerelve szállítjuk 4,8 - 5,6 - 6,4 - 7,8 mm méretű acél, rozsdamentes acél, alumínium és réz szegecsekhez

CE



Húzóerő	16.900 N
Lökethossz	22,5 mm
Legnagyobb szegecsméret	Ø rozsdamentes acél 7,8 mm
Levegőcsatlakozó	1/4" GÁZ
Üzemi nyomás	6,2 bar
Levegőcső belső Ø	10 mm
Levegőfogyasztás	4,9 l/ciklus
Súly	1,8 kg

kg	Ft	1	019460008
1,8	377.400		

1946C/T...

fejek a szerkezeti szegecsekhez



Ø mm	Ft	1	019460016
1946C/T4,8	4,8	14.250	
1946C/T6,4	6,4	14.250	1 019460018

1946KF

Rozsdamentes acél Ø M8

- Felhasználható szegecsanyag: acél, nemesacél, alumínium és réz, M4, M5, M6, M8

CE



Húzóerő	14.235 N
Lökethossz	7 mm
Max. szegecs Ø	Nemesacél Ø M8
Levegőcsatlakozás	1/4" GAS
Üzemi nyomás	6,2 bar
Ajánlott tömlő-Ø	10 mm
Átlagos levegőfelhasználás	2,1 l/ök
Szegecsanyagrapantó súlya	2,1 kg
Készlet súlya	3,4 kg

kg	Ft	1	019460012
3,4	795.800		

1946KF/M...

Tartalékstiftek a 1946KFmodellhez



	Ft	1	019460124
1946KF/M4	26.550	1	019460125
1946KF/M5	26.550	1	019460126
1946KF/M6	26.550	1	019460128
1946KF/M8	25.450	1	

1947

KIT-kinyomó

- Kit-kinyomópisztoly szilikon, ragasztó és közepes sűrűségű tömítőanyaghoz
- Szabvány (210 x 50 mm) merev és lágy patronokkal használható

CE



Patron méret	210x50 mm
Patron úrtartalom	350 ml
Levegőcsatlakozás	1/4" GAS
Üzemi nyomás	4,8 bar
Ajánlott tömlő Ø	10 mm
Átlagos levegőfelhasználás	120 l/perc
Súly	1,1 kg

kg	Ft	1	019470001
1,1	25.700		

1947H

tömítőanyag pisztoly

- Szabvány műanyag vagy fémpatronos szilikon és tömítőanyag kinyomó pneumatikus pisztoly
- Szabvány (215/218 x 50/51 mm) merev és lágy patronokkal használható
- Integrált nyomáscsökkentővel

CE



Patron méret	210x50 mm
Patron úrtartalom	300/310 ml
Levegőcsatlakozás	1/4" GAS
Üzemi nyomás	4 ÷ 8 bar
Ajánlott tömlő Ø	2,5 mm
Átlagos levegőfelhasználás	120 l/perc
Súly	750 g

g	Ft	1	019470011
750	92.250		

1947G

zsírzópisztoly

fröccsöntött alumínium fej
ergonomikus markolat sarkos kiképzéssel, hogy szűk térben is alkalmazható legyen
hosszú élettartamú sárgaréz szelep
400 g betétekkel vagy 500 cm³ folyékony zsírral működik
a cső méretei: 54 (belső) x 260 mm
levegőcsatlakozó: 1/4" GAS
üzemi nyomás: 4 ÷ 10 bár
súly: 1,9 kg

CE



1947G	Ft	1	019470051
	64.600		

1947G2

2 az 1-ben zsírzópisztoly

Folyamatos és szakaszos zsírázhoz
Fröccsöntött alumínium fej
Ergonomikus markolat
400 g patronokkal vagy max. 500 cm³ folyékony zsírral működik

CE



A cső méretei	54 (belső) x 276 mm
Levegőcsatlakozás	1/4" GAS BSP
Üzemi nyomás	3 ÷ 10 bar
Súly	2,2 kg

1947G2	Ft	1	019470060
	69.150		



1948

gravírozó

• Acél, rozsdamentes acél, alumínium, üveg, kő és kerámia gravírozására

CE



Ütésszám/perc 3 500 + 3 800
Max. keménység 60 HRC
Levegőcsatlakozás 1/4" GAS
Üzemi nyomás 6,2 bar
Átlagos levegőfelhasználás 50 l/perc
Súly 150 g

g 150 Ft 121.300 1 019480001

1948PR

Tartalék-wolframkarbidhegy a 1948 modellhez

• Max. keménység: 60 HRC



1948PR Ft 46.900 1 019480005

1949U5

lefúvató pisztoly 5 fúvókával

- Csúcsmínőségű, ütészálló üvegszálas anyagból
- 3 acél fúvóka, 100/160/320 mm, karcálló, gumi védősapkával
- 1 "Turbo" fúvóka üvegszállal erősített műanyagból, biztonsági sapkával
- 1 forgatható fúvóka, 100 mm, üvegszállal erősített műanyagból
- Gyorscsatlakozó rendszer



Menetes réz betét 1/4" GAS
Üzemi nyomás 10 bar
Maximális üzemi nyomás 15 bar
Átlagos levegőfelhasználás 280 l/perc
Üzemi hőmérséklet -10°C ÷ 80°C
Súly 93 g

g 93 Ft 14.250 1 019490030

1949U5/A

acél fúvóka, 100 mm, karcálló védő gumisapkával a 1949U5 - 1949P modellhez



1949U5/A Ft 2.680 1 019490131

1949U5/B

acél fúvóka, 160 mm, karcálló védő gumisapkával a 1949U5 - 1949P modellhez



1949U5/B Ft 2.720 1 019490132

1949U5/C

acél fúvóka, 320 mm, karcálló védő gumisapkával a 1949U5 - 1949P modellhez



1949U5/C Ft 3.450 1 019490133

1949U5/D

forgatható fúvóka, 100 mm, üvegszállal megerősített műanyag, a 1949U5 - 1949P modellhez



1949U5/D Ft 2.490 1 019490134

1949U5/E

„Turbo” fúvóka üvegszállal erősített műanyagból, biztonsági sapkával



1949U5/E Ft 1.260 1 019490135

1949U5/F

lapos, legyező formájú fúvóka üvegszállal erősített műanyagból az 1949U5 és 1949P modellhez



1949U5/F Ft 1.740 1 019490136

1949U5/G

OSHA fúvóka üvegszállal erősített műanyagból az 1949U5 és 1949P modellhez



1949U5/G Ft 1.340 1 019490137

1949BC

Lefúvató pisztoly gumifúvókával

- Ütészálló plattírozott ház
- Karcmentes cserélhető gumifúvóka



Alumíniumbetét, belsejében 1/4" GAS
Üzemi nyomás 6-8 bar
Max. üzemi nyomás 15 bar
Átlagos levegőfelhasználás 87 l/min
Üzemi hőmérséklet -20°C ÷ 70°C
Súly 120 g

g 120 Ft 6.890 1 019490022

1949BC/RU

5 gumifúvóka a 1949BC pisztolyhoz



1949BC/RU Ft 8.720 1 019490122

1949P

kis méretű lefúvató pisztoly

- Kopásálló, ütészálló kompozit anyagból
- Fúvóka gyorsrögztető rendszer
- Gyűrűsanyával állítható levegőmennyiség

Ø 1/4" GAS BSPT



Sárgaréz betét 1/4" GAS
Üzemi nyomás 6÷8 bar
Maximális üzemi nyomás 15 bar
Átlagos levegőfelhasználás 280 l/perc
Üzemi hőmérséklet -10°C ÷ 85°C
Súly 70 g

g 70 Ft 9.380 1 019490031

1949T

Teleszkópos lefúvatópisztoly, progresszíven szabályozható fúvóhatás

- Markolat ütészálló kompozit anyagból
- Elfördíthető acél teleszkópos cső: 165 mm + 300 mm

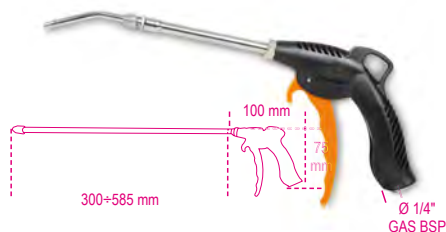

Alumíniumbetét, belse menet

Üzemi nyomás

Max. üzemi nyomás

Átlagos levegőfelhasználás

Üzemi hőmérséklet

Súly

1/4" GAS

6÷8 bar

15 bar

144 l/min

-20°C + 70°C

190 g

g 190 Ft 11.250 1 019490040

1949F2

lefúvató pisztoly

- Csúcsmínőségű, ütészálló és karcmentes, hőszigetelt üvegszál anyagból
- A speciálisan kialakított szelep és kar lehetővé teszi a levegőmennyiség optimális, folyamatos szabályozását
- Műanyag védőkupak biztosítja a használaton kívüli védelmet

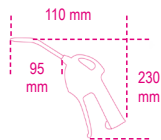

Ø 1/4" GAS BSP

Sárgaréz betét

Üzemi nyomás

Maximális üzemi nyomás

Üzemeltetési hőmérséklet

Súly

1/4" GAS

4-8 bar

12 bar

-20°C + 70°C

125 g

g 125 Ft 6.450 1 019490028

1949GPA

tömlőfúvató

- ütészálló gumi burkolatú test
- fém billentyű
- üzemi nyomás: 0,5÷12 bar (7÷174 psi)
- nyomásleeresztő gomb
- nyomásmérő
- tömlő hossz: 58 cm
- 360°-ban elforduló tömlő
- 1/4" levegőcsatlakozó



bar psi Ft 1949GPA 0,5÷12 7÷174 41.450 1 019490018

1949DGT/2

digitális tömlőfúvató

- ütészálló gumi burkolatú test
- fém billentyű
- üzemi nyomás: 0,5÷12 bar (7÷174 psi)
- 4 mértékegység: bar/psi/kpa/kgf
- háttérvilágítású LCD kijelző
- pontosság: 0,05 bar
- önkikapcsolás 1,5 perc után
- tömlő hossz: 58 cm
- 360°-ban elforduló tömlő
- tápellátás: 2 AAA elem
- 1/4" levegőcsatlakozó



bar psi Ft 1949DGT/2 0,5÷12 7÷174 51.300 1 019490021

1949GPN

Tömlőfúvató ABS-ház

- EWG-Manométer skálával 0,7÷12 bar (1/10 bar felosztásban)
- Mindkét szervós nyomógomb lehetővé teszi a gumibroncs pontos és gyors felpumpálását (+) és gyors leeresztését (-)
- Kalibrálási bizonyítvánnyal együtt szállítva
- Ütészálló burkolattal és akasztó füllel szállítva
- Menetsatlakozás: 1/4" GAS
- Forgatható levegő csatlakozó 7 mm átmérőjű gumitömlővel



bar g Ft 1949GPN 0,7÷12 810 79.150 1 019490011

1949M

nyomásmérő gumibroncsokhoz



bar psi g Ft 1949M 0÷4 5÷60 280 29.100 1 019490400

1950BZK

abroncsszerelő légágyú

- a nyomógombos másodlagos markolattal a szerszám használat közben stabil tartható
- tartály űrtartalom: 18 l
- üzemi nyomás: 3-8 bar
- tartály maximum nyomás: 16 bar
- nyomásmentesítő szelep
- skálázott mérő
- a műanyag bemenet megakadályozza a perem sérülését

CE



Ft 1950BZK 138.500 1 019500078

1949R

lefúvató pisztoly gépjármű radiátorok tisztításához a markolatra merőleges 5 lyuk lehetővé teszi a szennyeződés hatékony eltávolítását a hűtőről



L mm Ft 1949R 600 6 29.300 1 019490050



1951

mosópisztoly

- autókárpit, szőnyegpadló, ülés és csomagtartó tisztításhoz ajánlott



Szabad fordulatszám

Tartály térfogat	1 L
Levegőcsatlakozó	1/4" GAS
Üzemi nyomás	6,2 bar
Levegő cső belső Ø	8 mm
Átlagos levegőfogyasztás	110 l/min
Súly	650 g

g	Ft		
650	56.600	1	019510051

1951A

mosópisztoly

- Autókárpit, szőnyegpadló, ülés és csomagtartó tisztításhoz ajánlott
- Megfelelő mosószerekkel használható
- 1 literes tartály
- A tartályban tárolt folyadék kiáramlását szabályozó csappal rendelkezik
- 1,8 m hosszú bordáscsővel szállítva



Tartálykapacitás	1 l
Levegőcsatlakozás	1/4" GAS
Üzemi nyomás	6,2 bar
Belső tömlőátmérő (Ø)	8 mm
Átlagos levegőfelhasználás	120 l/perc
Súly	800 g

g	Ft		
800	92.300	1	019510101

1952

professzionális festékszóró pisztoly

- Öntött alumínium test, fekete, kémiai nikkel bevonattal
- Műanyag tartály cseppfogóval, 3/8" BSP menet
- Csatlakozó: 1/4" BSP hengeres gázmenet
- Nyomás- és levegőszabályozó
- Szabályozható fúvóka a kerek és szórt szóráskep között állítható
- Festék mennyiség szabályozó
- Karbantartáshoz szükséges szervizkulccsal szállítva

CE



Ø mm	Ft		
1952 1,2	1,2	64.450	1 019520012
1952 1,5	1,5	64.450	1 019520015
1952 1,8	1,8	64.450	1 019520018
1952 2,0	2,0	64.450	1 019520020

1900S

automatikus rugós tömlődob ütésálló műanyag test, levegőhöz és vízhez

- max. üzemi nyomás: 15 bar
- fonott poliuretán tömlő
- polipropilén váz
- a tömlőt a kívánt hosszban rögzítő szerkezet
- a reteszelő mechanizmus kikapcsolható, így a tömlő folyamatos visszahúzását teszi lehetővé
- üzemi hőmérséklet tartomány víz esetén: -5 °C / +50 °C
- 180°-os elforgatható konzollal és kiegészítő gyorscsatlakozó konzollal szállítva

CE



D1xD mm	L m	Ø GAS BSP	Ft		
8x12	10	1/4"	62.950	1	019000080

1900M

automatikus rugós tömlődob ütésálló műanyag test, levegőhöz és vízhez

- max. üzemi nyomás: 15 bar
- fonott poliuretán tömlő
- polipropilén váz
- a tömlőt a kívánt hosszban rögzítő szerkezet
- a reteszelő mechanizmus kikapcsolható, így a tömlő folyamatos visszahúzását teszi lehetővé
- üzemi hőmérséklet tartomány víz esetén: -5 °C / +50 °C
- 180°-os elforgatható konzollal és kiegészítő gyorscsatlakozó konzollal szállítva

CE



D1xD mm	L m	Ø GAS BSP	Ft		
8x12	15	1/4"	98.300	1	019000085
10x14	15	3/8"	89.700	1	019000115

1914

98 Shore kihúzható poliuretán spiráltömlő

- Legnagyobb üzemi nyomás 12 bar



L m	D1xD mm	Ø GAS BSP	Ft		
4	5x8	1/4"	9.650	1	019140054
6	5x8	1/4"	11.200	1	019140056
10	5x8	1/4"	14.650	1	019140060

1915B

95 Shore poliuretán spiráltömlő 9 méterre kihúzható

- Legnagyobb üzemi nyomás 10 bar

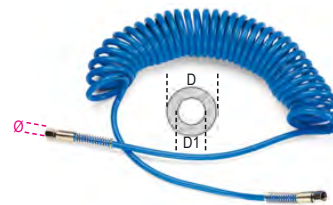

D1xD mm	Ø GAS BSP	Ft		
6,5x10	1/4"	16.950	1	019150011
8x12	1/4"	20.100	1	019150012
11x16	3/8"	33.450	1	019150013

Beta

1915C

95 Shore poliuretán spiráltömlő
12 m-ig kihúzható

• Legnagyobb üzemi nyomás 10 bar

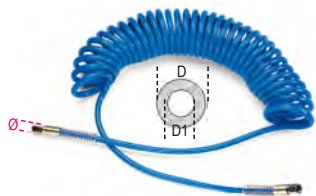

D1xD mm	Ø GAS BSP	Ft	5	10
6,5x10	1/4"	20.050	1	019150014
8x12	1/4"	24.750	1	019150015
11x16	3/8"	40.600	1	019150016

1915C/L

95 Shore poliuretán spiráltömlő
15 m-ig kihúzható

• Legnagyobb üzemi nyomás 10 bar

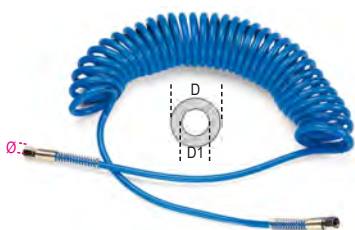

D1xD mm	Ø GAS BSP	Ft	5	10
8x12	1/4"	32.300	1	019150115
11x16	3/8"	53.400	1	019150116

1915D

95 Shore huzalhálós poliuretán cső
hosszúság 9 m

• Legnagyobb üzemi nyomás 15 bar



D1xD mm	Ø GAS BSP	Ft	5	10
8x12	1/4"	20.150	1	019150017
11x16	3/8"	32.300	1	019150018

1915E

95 Shore huzalhálós poliuretán cső
hosszúság 12 m

• Legnagyobb üzemi nyomás 15 bar



D1xD mm	Ø GAS BSP	Ft	5	10
8x12	1/4"	26.350	1	019150019
11x16	3/8"	40.200	1	019150020

1915E/XL

95 Shore huzalhálós poliuretán cső tekeres
hosszúság 50 m

• Legnagyobb üzemi nyomás 15 bar



D1xD mm	Ø GAS BSP	Ft	5	10
8x12	1/4"	92.200	1	019150519
11x16	3/8"	153.900	1	019150520

1916I

Gyorscsatlakozó, olasz modell
külső GAS menet, hengeres, BSP



Ø GAS BSP	Ft	5	10
1/4"	1.130	5	019160001
3/8"	1.270	5	019160002

1916G

Gyorscsatlakozó, európai modell
külső GAS menet, hengeres, BSPT



Ø GAS BSPT	Ft	5	10
1/4"	1.110	5	019160005
3/8"	1.400	5	019160010
1/2"	1.760	5	019160012

1916GF

gyorscsatlakozó, olasz modell
belső GAS menet, hengeres BSP



Ø GAS BSP	Ft	5	10
1/4"	1.100	5	019160055
3/8"	1.260	5	019160060

1916GFE

gyorscsatlakozó, európai modell
belső GAS menet, hengeres BSPT



Ø GAS BSPT	Ft	5	10
1/4"	1.170	5	019160075
3/8"	1.590	5	019160082
1/2"	1.710	5	019160084

1916JM

gyorscsatlakozó, ázsiai modell
külső GAS menet, hengeres BSPT



Ø GAS BSPT	Ft	5	10
1/4"	1.560	1	019160406
3/8"	1.700	1	019160410

1916JF

gyorscsatlakozó, ázsiai modell
belső GAS menet, hengeres BSP



Ø GAS BSPT	Ft	5	10
1/4"	1.550	1	019160456
3/8"	1.680	1	019160460

1916P

gyorscsatlakozó, olasz modell
gumitömlőhöz való hüvellyel



D1xD mm	Ft	5	10
6x14	1.590	5	019160256
8x17	1.670	5	019160258
10x19	2.200	5	019160260

Beta

1916S

gyorscsatlakozó, olasz modell, rugós

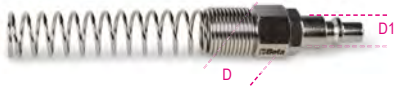

D1xD mm	Ft	🔧	📄
6x8	1.590	5	019160306
8x10	1.660	5	019160308
10x12	2.110	5	019160310

1917M

Univerzális golyórögztésű gyorscsatlakozó hüvely
ütésálló gumival
külső GAS menet, hengeres, BSP
• Csatlakoztatható a 1916I és a 1916G modellhez



Ø GAS BSP	Ft	🔧	📄
1/4"	4.010	5	019170001
3/8"	4.010	5	019170003
1/2"	4.510	5	019170004

1917F

univerzális golyórögztésű gyorscsatlakozó hüvely, ütésálló gumival
belső GAS menet, hengeres BSP

• csatlakoztatható a 1916I és 1916G gyorscsatlakozókhoz



Ø GAS BSP	Ft	🔧	📄
1/4"	4.230	5	019170005
3/8"	4.120	5	019170010
1/2"	4.710	5	019170014

1917JM

univerzális golyórögztésű gyorscsatlakozó hüvely ázsiai modellekhez
külső GAS menet, hengeres BSP



Ø GAS BSP	Ft	🔧	📄
1/4"	6.510	1	019170406
3/8"	6.550	1	019170410
1/2"	7.010	1	019170412

1917JF

golyórögztésű gyorscsatlakozó hüvely ázsiai modellekhez
belső GAS menet, hengeres BSP



Ø GAS BSP	Ft	🔧	📄
1/4"	6.550	1	019170456
3/8"	6.560	1	019170460

1917RG

forgatható univerzális gyorscsatlakozó hüvely

- Alumínium, belső GAS menet, hengeres BSP, külső menet, hengeres BSP
- Az összes olasz és európai csatlakozó modellhez csatlakoztatható
- Csatlakoztatott levegő nélkül is szabad elforgatás



Ø GAS BSP	Ft	🔧	📄
1/4"	8.530	1	019170252

1917SP

univerzális golyórögztésű gyorscsatlakozó gumitömítőhöz való hüvellyel



D1xD mm	Ft	🔧	📄
6x14	4.490	5	019170206
8x17	4.610	5	019170208
10x19	5.390	5	019170210

1917ST

univerzális golyórögztésű gyorscsatlakozó, rugós



D1xD mm	Ft	🔧	📄
6x8	4.340	5	019170306
8x10	4.240	5	019170308
10x12	4.780	5	019170310

1918

külső menetes tömlőcsatlakozó



D1 mm	Ø GAS BSP	Ft	🔧	📄
6	1/8"	940	3	019180106
8	1/8"	940	3	019180108
6	1/4"	1.020	3	019180116
8	1/4"	1.100	3	019180118
10	1/4"	1.100	3	019180120
10	3/8"	1.240	3	019180130
12	3/8"	1.270	3	019180132
10	1/2"	1.670	3	019180140
12	1/2"	1.730	3	019180142

1918N

menetes adapter (BSPT)



Ø GAS	Ø1 GAS	Ft	🔧	📄
1/4"	1/4"	1.100	5	019180300
3/8"	3/8"	1.270	5	019180310
1/2"	1/2"	1.710	5	019180320

1918R

menetes adapter (BSPT)



Ø GAS	Ø1 GAS	Ft	🔧	📄
1/4"	3/8"	1.240	5	019180200
3/8"	1/2"	1.670	5	019180210

1919FE1/4

Levegőelőkészítő



Levegőcsatlakozás/kimenet

Manométermenet
Max. átfolyás
Max. üzemi nyomás
Üzemi hőmérséklet
Szűrési finomság
Tartály úrtartalma
Súly

1/4" GAS BSPT
1/8" GAS BSPT
750 l/min
9,5 bar
0,5 - 8,5 bar
5 - 60 °C
5 micron
15 cl levegő / 25 cl olaj
700 g

g	Ft	🔧	📄
700	41.750	1	019190200

1919RB-FE1/4

1 pár tartalék tartály
a 1919FE1/4"-hoz



1919RB-FE1/4 Ft 8.920 1 019190210

1919RF-FE1/4

Tartalék szűrőbetét az 1919FE1/4
típusú
levegőelőkészítőhöz



1919RF-FE1/4 Ft 2.430 1 019190230

1919RM-FE1/4

Tartalékmanométer az 1919FE1/4
típusú levegőelőkészítőhöz



1919RM-FE Ft 4.930 1 019190220

1919F1/4 Levegőelőkészítő

Ø 1/4"



Levegőcsatlakozás/kimenet 1/4" GAS BSPT
Max. áteresztés 1000 l/perc
Max. üzemi nyomás 9,5 bar
Üzemi nyomás 0,5 - 8,5 bar
Üzemi hőmérséklet 5 - 60 °C
Szűrési finomság 5 µm
Tartály úrtartalma 60 cl levegő / 90 cl olaj
Súly 1,3 kg

1919F1/4 Ft 65.700 1 019190250

1919F3/8 Levegőelőkészítő

Ø 3/8"



Levegőcsatlakozás/kimenet 3/8" GAS BSPT
Max. áteresztés 1350 l/perc
Max. üzemi nyomás 9,5 bar
Max. üzemi nyomás 0,5 - 8,5 bar
Üzemi hőmérséklet 5 - 60 °C
Szűrési finomság 5 µm
Tartály úrtartalma 60 cl levegő / 90 cl olaj
Súly 1,3 kg

1919F3/8 Ft 65.700 1 019190350

1919F1/2 Levegőelőkészítő

Ø 1/2"



Levegőcsatlakozás/kimenet 1/2" GAS BSPT
Max. áteresztés 2500 l/perc
Max. üzemi nyomás 9,5 bar
Max. üzemi nyomás 0,5 - 8,5 bar
Üzemi hőmérséklet 5 - 60 °C
Szűrési finomság 5 µm
Tartály úrtartalma 60 cl levegő / 90 cl olaj
Súly 1,3 kg

1919F1/2 Ft 65.700 1 019190450

1919RB-F

1 pár tartalék tartály az 1919F - 1/4", 3/8", 1/2"
típusú levegőelőkészítőhöz



1919RB-F Ft 11.500 1 019190510

1919RF-F

Tartalék szűrőbetét az 1919F - 1/4", 3/8", 1/2"
típusú levegőelőkészítőhöz



1919RF-F Ft 4.230 1 019190530

1919RM-F

Tartalék manométer az 1919F - 1/4", 3/8",
1/2" típusú levegőelőkészítőhöz



1919RM-F Ft 6.690 1 019190520

1919ML

Mini olajozó



Ø	L mm	Ø mm	Ft	1
1/4"	63	36	8.590	019190030
3/8"	63	36	9.230	019190032

1919SC

Mini nedvesség leválasztó



Ø	L mm	Ø mm	Ft	1
1/4"	80	40	10.850	019190035

1919L

ISO 32 kenőolaj

Sűrűség (20°C) 875 Kg/m³
Viszkozitás (40°C) 32 cSt
Lobbanáspont COC 210°C



1919L cc 500 Ft 7.530 5 019190050



SZERSZÁMTÁROLÓK ÉS KÉSZLETEK

KÉSZLETEK KISEBB TÁSKÁKHOZ ÉS BŐRÖNDÖKHÖZ

KÉSZLETEK KÉZIKOCSIHOZ

	Ilośc szt.	2009N/BV	2028/WV	2029/WV	2032/TV	2033L/WV	2036/TV	C99	C99V1	C99V3/2C	C4	C5	C5S	C6T	C7	C8	C10	C9	C10S	C11 CP15L	C16	CP17	CP17L	C12	C14	CP15	C18	C19	C19L	C20	C20L	C41S	C41H	C42H	
		5914VU/M	Általános karbantartáshoz	109																															
5915VU/0	Általános karbantartáshoz	35									460																								
5915VU/1	Általános karbantartáshoz	45																																	
5915VU/2	Általános karbantartáshoz	49																																	
5915VU/3	Általános karbantartáshoz	74																																	
5915VU/4	Általános karbantartáshoz	80																																	
5915VU/5	Általános karbantartáshoz	111																																	
5915VU/AS	Általános karbantartáshoz	68																																	
5940SBK	Motorkerékpárok és kerékpárok javítása	125																																	
5941VU/M	Általános karbantartáshoz	64																																	
5980EL/A	Elektronikai	57	475		475	475																													
5980EL/B	Elektronikai	98		476		476	476																												
5980ET/A	Elektrotechnikai	70	473		473																				473										
5980ET/B	Elektrotechnikai	64		474		474	474																		474										
5980ID	Víz- és gázszerelő	35	477																																
5980MQ	Elektrotechnikai	46		474																															
5980U/BIKE	Motorkerékpárok és kerékpárok javítása	90																																	
5990V1	Általános karbantartáshoz	44						467	467																										
5990V3	Általános karbantartáshoz	116						467		467																									

TECHNIKAI ANYAGBÓL KÉSZÜLT SZERSZÁMTÁSKÁK ÉS HÁTIZSÁKOK

- FUNKCIONALITÁS
- STRAPABÍRÁS
- TARTÓSSÁG

Ez a három fogalom a Beta szövettől készült tárolóeszközeinek három sarokköve. A Beta szerszámtáskái és hátizsákjai strapabíró technikai anyagból készülnek, egyaránt ellenállnak a kopásnak és elhasználódásnak, varratai és alja megerősítettek,

ami megbízhatóságot és tartósságot eredményez.

Minden tárolóeszköz különleges jellemzőkkel rendelkezik, a tárolókat különböző felhasználásokra és a rendelkezésre álló hely optimális

kihasználására tervezték: a

cipzáras zsebek, a teleszkópos fogantyúk, a kerékvédők, a megerősített vállpántok és átlátszó dokumentumtárolók az egyes táskák és hátizsákok számos sajátosságai közül csak néhányat képviselnek.

A gondos odafigyelés a részletekre és a sokféleségre, valamint a szerszámok teljesen biztonságos szállításának fokozott figyelembevétele biztosítja, hogy ezek a termékek minden munkahelyi helyzetben ideális megoldást jelentsenek.



POLIPROPILÉN SZERSZÁMOS LÁDÁK

A Beta a szerszámok számára széles választékot kínál, hogy bármilyen igénynek megfeleljen!

A Beta szerszámok ládája és szerszámokcsijai erős, vastag, ütésálló, korrózióálló polipropilénből készülnek, amely ellenáll a nagy igénybevételnek – pl. alacsony hőmérsékletnek.

Válassza ki azt a terméket, amely a legjobban megfelel az Ön munkája szerinti

igénynek: klasszikus szerszámokcsij, kerek kocsi egyszerű szállításhoz, TSA zárral ellátott változatok a teljesen szabad utazáshoz, végül az alumínium vagy vízzáró változatok.

A Beta legtöbb szerszámokcsija és szerszámokcsija a különböző munkák igényeinek és alkalmazási területeinek megfelelően válogatott szerszámkészletekkel is kaphatók, legyen az elektronika, hidraulika, hajózás vagy karbantartás.



2001/B26

26 darabos szerszámkészlet textiltokban



2001/B26 Ft 88.250 1 020010215

55 6x7 - 8x9 - 10x11 - 12x13 - 14x15 - 16x17 mm

96N/SC9 1,5 - 2 - 2,5 - 3 - 4 - 5 - 6 - 8 - 10 mm

1044F 250 mm

1128BMX 145 mm

1150 180 mm

1201E 3x75 - 4x100 - 5,5x150 mm

1202E PH1x80 - PH2x100 mm

1370 300 g

1692 2 m

1770A 9 mm

2001/BV Ft 21.050 1 020010051

2001/BZV

szerszámtáska tartós hightech szövettől

- Dupla felső pánt az optimális fogáshoz
- Elülső cipzáros dokumentumtároló zseb
- A hátoldalon elhelyezett tépőzáras pánttal a táska a kocsi fogantyújára rögzíthető
- 20 kényelmes szerszámokcsiz (6 zseb és 14 gumipánt)
- Kalapáccstartó fülek
- C9/RT vállszíjjal is kapható (külön kell megrendelni)



2001/BZV Ft 17.750 1 020010151

380x290x60 mm - 675 g



2001/BZ24 MQ

összehajtható táska 24 darabos
szerszámkészlettel villanszereléshez



2001/BZ24 MQ Ft 122.900 1 020010154

	n.
1128BMX	1
1150MQ 180 mm	1
42 8-10-13-17-19 mm	5
1274MQ 3x100 - 4x100 - 5,5x125 mm	3
1272MQ PH0x60 - PH1x80 - PH2x100 mm	3
96BP/SC9 1,5-2-2,5-3-4-5-6-8-10 mm	9
1253	1
1082MQ 160 mm	1

2001/BZ27 VU

összehajtható táska 27 darabos
szerszámkészlettel univerzális alkalmazásra



2001/BZ27 VU Ft 103.000 1 020010157

	n.
1128BMX	1
1150 180 mm	1
42 7-8-10-13-17-19 mm	6
1201E 3x75 - 4x100 - 5,5x150 mm	3
1202E PH0x60- PH1x80 - PH2x100 mm	3
96/SC9 1,5-2-2,5-3-4-5-6-8-10 mm	9
1370 300 g	1
1048N 250 mm	1
1692/5 5 m	1
1771 18 mm	1

2002/BV6

tartós poliészterből készült összetekkerhető
szerszámtok, üres

- 6 különböző méretű praktikus szerszámtartó zseb
- A megerősített anyagból készült fülek köszönhetően könnyen szállítható
- A belső hajtóka megakadályozza, hogy a szerszámok kiessenek
- Körben mindenhol megerősített varrás
- Kettős tépőzár
- Méret nyitott állapotban: 175 x 240 mm



2002/BV6 Ft 3.580 1 020020000

2002/BVL6

tartós poliészterből készült összetekkerhető
szerszámtok, üres

- 6 különböző méretű praktikus szerszámtartó zseb
- A megerősített anyagból készült fülek köszönhetően könnyen szállítható
- A belső hajtóka megakadályozza, hogy a szerszámok kiessenek
- Körben mindenhol megerősített varrás
- Kettős tépőzár
- Méret nyitott állapotban: 220 x 290 mm



2002/BVL6 Ft 4.590 1 020020010

2002/BV7-ZIP

tartós poliészterből készült összetekkerhető
szerszámtok, üres

- 7 különböző méretű praktikus szerszámtartó zseb és kis cipzáros szerszámtartó zseb
- A megerősített anyagból készült fülek köszönhetően könnyen szállítható
- A belső hajtóka megakadályozza, hogy a szerszámok kiessenek
- Körben mindenhol megerősített varrás
- Kettős tépőzár
- Méret nyitott állapotban: 355 x 220 mm



2002/BV7-ZIP Ft 8.170 1 020020060

2002/BV8

tartós poliészterből készült összetekkerhető
szerszámtok, üres

- 8 különböző méretű praktikus szerszámtartó zseb
- A megerősített anyagból készült fülek köszönhetően könnyen szállítható
- A belső hajtóka megakadályozza, hogy a szerszámok kiessenek
- Körben mindenhol megerősített varrás
- Kettős tépőzár
- Méret nyitott állapotban: 395 x 360 mm



2002/BV8 Ft 4.590 1 020020020

2002/BV9

tartós poliészterből készült összetekkerhető
szerszámtok, üres

- 9 különböző méretű praktikus szerszámtartó zseb
- A megerősített anyagból készült fülek köszönhetően könnyen szállítható
- A belső hajtóka megakadályozza, hogy a szerszámok kiessenek
- Körben mindenhol megerősített varrás
- Kettős tépőzár
- Méret nyitott állapotban: 325 x 290 mm



2002/BV9 Ft 4.590 1 020020030

2002/BV12

tartós poliészterből készült összetekkerhető
szerszámtok, üres

- 12 különböző méretű praktikus szerszámtartó zseb
- A megerősített anyagból készült fülek köszönhetően könnyen szállítható
- A belső hajtóka megakadályozza, hogy a szerszámok kiessenek
- Körben mindenhol megerősített varrás
- Kettős tépőzár
- Méret nyitott állapotban: 650 x 355 mm



2002/BV12 Ft 7.660 1 020020040

2002/BV13

tartós poliészterből készült összetekkerhető szerszámtok, üres

- 13 különböző méretű praktikus szerszámtartó zseb
- A megerősített anyagból készült fülnek köszönhetően könnyen szállítható
- A belső hajtóka megakadályozza, hogy a szerszámok kiessenek
- Körben mindenhol megerősített varrás
- Kettős tépőzár
- Méret nyitott állapotban: 330 x 190 mm



2002/BV13 Ft 4.590 1 020020050

2002/BV42

tartós poliészterből készült összetekkerhető szerszámtok, üres

- 42 különböző méretű praktikus szerszámtartó zseb: 18 gumipánt és 24 zseb (egy tépőzár)
- A megerősített anyagból készült fülnek köszönhetően könnyen szállítható
- Fém gyűrűkkel a falra akasztható
- Körben mindenhol megerősített varrás
- Robusztus duplacsatos zár
- Méret nyitott állapotban: 595 x 535 mm



2002/BV42 Ft 10.750 1 020020070

2005MPU

övtáska, üres, nylonból, övvel

- Öt nagy szerszámtartó zseb
- Egy ollótartó zseb elől
- Karabinerhorog a csaton a ragasztószalaghoz
- Állítható öv (70 ÷ 120 cm)

Méretetek: 155x285x80 mm



2005MPU Ft 10.000 1 020050060

2005PA/D

Övtáska, üres, nylonból, övvel



2005PA/D Ft 26.950 1 020050000

2005PA/E

övtáska, üres, nylonból, övvel

- Két nagy zseb szerszámtartó gumipánttal
- Két ollótartó zseb elől
- Két praktikus oldalzseb:
- bal oldali zseben erős fémhorog a mérőszalagnak
- dupla jobb oldali zseb zsinóros tasakkal és cipzárral
- Karabinerhorog a csaton a ragasztószalaghoz
- Állítható öv (70 ÷ 120 cm)

Méretetek: 260x250x190 mm



2005PA/E Ft 15.500 1 020050030

2005PA/S

Övtáska, üres, nylonból, övvel



2005PA/S Ft 13.650 1 020050020

2009N/BV

Karbantartó szerszámtáska, bőr



2009N/BV Ft 114.000 1 020090200

530x220x190 mm

2009ID

Karbantartó szerszámkészlet táskával



2009ID Ft 336.500 1 020091013
(2009N/BV+5980ID)

2028/VV

polipropilén szerszámtáska

2 szerszámtartó panel
Kivehető válaszfalás belső aljzat Kettős kombinációs zár



2028/VV Ft 100.900 1 020280010

480x190x400 mm

2028E

táska szerszámkészlettel elektronikai és elektrotechnikai felhasználásra



2028EL/A Ft 437.400 1 020281014
(2028/VV+5980EL/A)

2028ET/A Ft 444.800 1 020281018
(2028/VV+5980ET/A)

2029/VV

szerszámtáska, keményfalú, polipropilén,
aluminium profillal merevítve

2 számszámpanel
Az alrészben kivehető és állítható rekeszekkel
Vállszíj
2 kulcsos zár



2029/VV	Ft	1	020290000
480x227x408 mm	132.300		

2029E

Szerszámkészlet műszerészeknek
és villanszerelőknél szerzámtáskában



2029 BG MQ (2029/VV+5980MQ)	Ft	1	020291257
2029ET/B (2029/VV+5980ET/B)	791.300		
2029EL/B (2029/VV+5980EL/B)	615.300	1	020291021
	598.100	1	020291017

2032/TV

Műanyag kerek szerzámtáska

2 számszámpanel
Szerzámtáska
Feneklap kivehető elválasztókkal



2032/TV	Ft	1	020320110
450x200x400 mm	172.000		

2032/TE

Szerszámkészlet műszerészeknek és
villanszerelőknél, kerek szerzámtáskában



2032TET/A (2032/TV+5980ET/A)	Ft	1	020321328
2032TEL/A (2032/TV+5980EL/A)	515.900		
	508.500	1	020321314

2033L/VV

aluminium műszerésztáska, üres

- Kiemelten ütészálló
- Karcmentes kivétel
- Ergonomikus, gumis fogantyú
- Kettős kombinációs zár

- 2 számszámpanel gumipánttal
- Kivehető elválasztók



2033L/VV	Ft	1	020330250
470x203x373 mm	147.300		

2033L

szerszámkészlet műszerészeknek és
villanszerelőknél aluminium szerzámtáskában



2033LEL/A (2033L/VV+5980EL/A)	Ft	1	020331224
2033LEL/B (2033L/VV+5980EL/B)	483.800		
2033LET/B (2033L/VV+5980ET/B)	613.100	1	020331225
	630.300	1	020331237

2036/TV

Kerek szerzámtáska polipropilén,
aluminium profillal merevítve

2 számszámpanel
Teleszkópos fogantyúval
Csapágyazott kerek



2036/TV	Ft	1	020360000
480x267x408 mm	202.300		

2036E

Szerszámkészlet műszerészeknek
és villanszerelőknél kerek szerzámtáskával



2036TET/B (2036/TV+5980ET/B)	Ft	1	020361223
2036EL/B (2036/TV+5980EL/B)	685.300		
	668.100	1	020361218

2037/TV

nagyvastagságú polipropilén húzható
szerzámtartó táska 4 elforduló kerékkel

Rendkívül ütészálló. Repülőgépes szerzámszállításhoz javasolt.
2 kivehető szerzámtartó panel.
Beépített dokumentumtartó zseb.
4 eltávolítható elforduló kerék, amelyek lehetővé teszik a szerzámtáska vízszintes mozgását.
2 szerléktartó tállal szállítva
2 engedélyezett TSA zár kulccsal
Gumiborítású ergonomikus fogantyú



2037/TV	Ft	1	020370000
482x295x478 mm	250.800		

2038/TV

nagyvastagságú polipropilén húzható
szerszámtartó táska

- Rendkívül ütészálló.
- Alumínium tartóprofil
- 2 TSA homologizációval rendelkező kulcsos zár
- 2 kivethető szerszámtartó panel.
- Teleszkópos fogantyú és nagy, golyóscsapágyas kerekek
- 2 ergonomikus, gumival bevont fogantyú (1 oldalsó)
- Tágas alsó rész
- Dokumentum tartó zseb
- 3 szerelékartartó fiók



2038/TV Ft 332.900 1 020380000

430x375x525 mm

2041UC

33 darabos szerszámkészlet "Utility Case"
kofferben



2041UC Ft 129.400 1 020410215

- 55 6x7 - 8x9 - 10x11 - 12x13 - 14x15 - 16x17 mm
- 96/SC9 1,5 - 2 - 2,5 - 3 - 4 - 5 - 6 - 8 - 10 mm
- 111 200 mm
- 1048V 250 mm
- 1128BMX 145 mm
- 1150 180 mm
- 1201E 2,5x50 - 3x75 - 4x100 - 5,5x100 - 6,5x150 mm
- 1202E PH0x60 - PH1x80 - PH2x100 mm
- 1370 300 g
- 1692 3m
- 1771 170 mm
- 1833S 70 Lumen / 140 mm
- 1639NS-N 25m
- 1696 200 mm

535x282x87 mm - 4,5 Kg

2051N

55 darabos szerszámkészlet
hajókarbantartáshoz ütészálló PP-kofferben



2051N Ft 293.800 1 020510215

- 42 7 - 8 - 10 - 12 - 13 - 14 - 17 - 19 mm
- 55AS 3/8x7/16 - 1/2x9/16 - 5/8x11/16"
- 956C □1/2 - 16 - 20,8 mm
- 1048 250 mm
- 1084BM 160 mm
- 1128BMX 145 mm
- 1150BM 180 mm
- 1166BM 160 mm
- 1201E ●3x75 - 4x100 - 5,5x150 - 6,5x150 mm
- 1202E ●PH1x80 - PH2x100 mm
- 1390 Ø 35 mm
- 1490/2 ø max 240 mm
- 96/SC9 ○1,5÷10 mm
- 1737 145 mm
- 1778X
- BMN1436 3,6 x 140 mm
- BMESB1925NE 25 m
- 111 200 mm
- 920A ○ 10 - 12 - 13 - 14 - 17 - 19 mm
- 920AS ○ 7/16 - 1/2 - 9/16 - 11/16 - 7/8"
- 920/22 255 mm - □1/2 - ■1/2
- 920/25 □1/2 - ■1/2
- 920/42 ■1/2
- 920/55 ■1/2

585x393x92 mm - 9 kg

2055HB

24 darabos szerszámkészlet "Home Bag",
szerszámkofferben



2055HB Ft 77.850 1 020550215

- 55 6x7 - 8x9 - 10x11 - 12x13 mm
- 96N/SC9 1,5 - 2 - 2,5 - 3 - 4 - 5 - 6 - 8 - 10 mm
- 1128BMX 145 mm
- 1150 180 mm
- 1048V 250 mm
- 1201E 3x75 - 4x100 - 5,5x100 mm
- 1202E PH0x60 - PH1x80 - PH2x100 mm
- 1370 300 g
- 1692 3m

373x275x70 mm - 3 Kg

2080/V6

Üres szerszámtáska 6 db kivethető tálcával és
állítható válaszfalakkal



2080/V6 mm Ft 15.800 1 020800060

2080/V6-U

kivethető tálca a 2080/V6 táskához



2080/V6-U Ft 1.100 1 020800066

90x60x50 mm

 **Beta**

2080/D10

10 darabos állítható válaszfal szett a 2080/V6 szerszámtáskához



2080/D10	Ft 2.990		1	020800070
----------	-------------	--	---	-----------

2080/V12

szerszámtáska 12 db kivethető tálcával



2080/V12	mm 300x145x330	Ft 24.150		1	020800000
----------	-------------------	--------------	--	---	-----------

2080/V12-...

kivethető tálcák a 2080/V12 táskához



2080/V12-S	Ft 1.470		3	020800013
2080/V12-M	Ft 2.190		2	020800015
2080/V12-L	Ft 3.760		1	020800020

C3

mini szerszámtáska hightech szövetből

Fő jellemzők:

- 1 cipzáros elülső külső zseb
- 2 oldalsó zseb tálcával
- 1 praktikus tépőzárás hátsó zseb
- 1 kivethető belső szerszámtartó panel két oldalt gumipánttal
- USB csatlakozó mobilkészülékek töltéséhez
- Vállszíjjal szállítva



C3	Ft 26.650		1	021030000
----	--------------	--	---	-----------

310x110x320 mm - 890 g

C4 - 2104

Szerszámos táskák High-Tech szövetből

Kivethető belső szerszámpanel

Gumis belső és külső zsebek szerszámok elhelyezésére

Merev, vízhatlan, gumirozott fenéklap

Vállszíjjal szállítva



C4	Ft 43.850		1	021040000
2104VU/0	Ft 196.800		1	021041122

330x260x360 mm - 2,5 kg

C5S

szerszámos hátizsák kopásálló poliészterből

- Dupla pánt felül közepén a stabil, kiegyensúlyozott tartáshoz
- Két nagy elülső zseb
- Két tágas belső zseb és két további tépőzárás pánt
- Négy eszköztartó panelből álló feltekerhető belső táskák
- Állítható megerősített vállpánt
- Maximális teherbírás: 15 kg



C5S	Ft 23.850		1	021050100
-----	--------------	--	---	-----------

310x120x390 mm - 0,9 Kg

C5 - 2105

Szerszámos hátizsák Hightech-textilből



C5	Ft 62.950		1	021050000
2105VU/0	Ft 215.900		1	021051122

400x200x500 mm - 2,5 Kg

C6T - 2106

Húzható szerszámtáska textilből



C6T	Ft		
2106T/VU0	89.400	1	021060010
(C6T+5915VU/0)	242.400	1	021061123

360x200x480 mm - 4,5 kg

C7 - 2107

Szerszámtáska High-Tech-szövetből

2 kivehető szerszámpanel
Notebook zseb
Elöl 2 külső zseb
Kivehető műanyag elválasztók



C7	Ft		
2107VU/2	91.600	1	021070000
(C7+5915VU/2)	246.600	1	021071112
2107VU/3	422.000	1	021071114
(C7+5915VU/3)			

480x165x380 mm - 3,5 kg

C8 - 2108

Húzható szerszámtáska, Hightech-szövet, üres

Teleszkópos fogantyú a szállításhoz
2 belső kivehető szerszámpanel
2 külső zseb
C10S modell ráhelyezhető



C8	Ft		
2108VU/1	103.700	1	021080000
(C8+5915VU/1)	284.000	1	021081022

470x280x380 mm - 4 kg

C8B

hightech szövet szerszámkocsi villanszerelőknek

Merev keret
Teleszkópos fogantyúval
4 kerék
1 kivehető belső szerszámtartó panel
Elülső zseb kártyatartóval
Kettős fenék hőformált tálcával
2 külső oldalzseb
2 kábelbehúzó
A lehajtható fogantyú könnyebb hozzáférést biztosít a szerszámokhoz
Lakattal zárható (a lakat nem tartozék)



C8B	Ft		
	88.600	1	021080300

380x250x430 mm - 4,7 kg

C9 - 2109

Szerszámtáska Hightech-szövetből

- Merev fenéklap
- Belső- és külső zsebek a szerszámok elhelyezésére
- Cípjáras külső zseb a nagyobb biztonság érdekében
- Tépőzáras zseb a személyes tárgyak részére
- Dupla fenéklap
- Dupla szíj vízmérték rögzítéséhez
- Vállszíj az egyszerűbb szállításhoz



C9	Ft		
2109VU/1	50.250	1	021090000
(C9+5915VU/1)	230.600	1	021091022
2109VU/3	380.600	1	021091024
(C9+5915VU/3)			

550x280x320 mm - 2,6 kg

C9/RT

Vállszíj a C9-hez és a C10-hez



C9/RT	Ft		
	6.030	1	021090900

C10 - 2110

Szerszámtáska Hightech-szövetből

Merev struktúra
Dupla fenéklap. A fenéklap eltávolítható a nagyobb hely érdekében
Lehajtható, ill. sréhen állítható fogantyú, a szerszámokhoz könnyebb hozzáférés érdekében
Gumis belső és külső zsebek szerszámok elhelyezésére
Bélés
Tálcák a kis tárgyak elhelyezésére a dupla fenéklapban



C10	Ft		
2110VU/1	63.950	1	021100000
(C10+5915VU/1)	244.300	1	021101031
2110VU/3	394.300	1	021101034
(C10+5915VU/3)			
2110VU/AS	414.800	1	021101036
(C10+5915VU/AS)			

520x220x250 mm - 3,3 kg

C10S - 2110S

Szerszámtáska Hightech-szövetből

Merev fenéklap

Dupla fenéklap. A fenéklap eltávolítható a nagyobb hely érdekében

Lehajtható, ill. sréhen állítható fogantyú, a szerszámokhoz könnyebb hozzáférés érdekében

Gumis belső és külső zsebek szerszámok elhelyezésére

Bélés

Tálcák a kis tárgyak elhelyezésére a dupla fenéklapban



	Ft	📦	🏠
C10S	48.900	1	021100001
2110SVU/1 (C10S+5915VU/1)	229.200	1	021101041
2110SVU/3 (C10S+5915VU/3)	379.300	1	021101044

📏 420x220x250 mm - 🏋️ 2,3 kg

C11 - 2111

Szerszámtáska textilből



	Ft	📦	🏠
C11	36.150	1	021110000
2111VU/1 (C11+5915VU/1)	216.500	1	021111031
2111VU/3 (C11+5915VU/3)	366.500	1	021111034

📏 410x230x250 mm - 🏋️ 2 kg



C12 - 2112

Szerszámtáska High-Tech-szövetből

Kivehető szerszámpanel

Nagy belső és külső zsebek gumiszalaggal szerszámok elhelyezésére

Elöl nyitható zseb, ami megkönnyíti a szerszámok kivételét

Gumizott vízálló fenéklap

C8 teleszkópos fogantyúval is használható



	Ft	📦	🏠
C12	79.850	1	021120000
2112ET/A (C12+5980ET/A)	423.800	1	021121028
2112ET/B (C12+5980ET/B)	562.900	1	021121029
2112VU/5 (C12+5915VU/5)	496.500	1	021121056

📏 500x270x350 mm - 🏋️ 5 kg

C13

húzható szerszámláda
tartós polipropilénből

• Szabadtéri használatra alkalmas

• Útésálló, vegyszerálló

• Lelakatható (a lakat nem tartozék)

• Kettős zár

• Két kerék a szerszámláda könnyebb mozgatásához

• Kivehető, két helyen rögzíthető belső tálca

• Névtábla



	Ft	📦	🏠
C13	126.700	1	021130000

📏 806x350x467 mm - 🏋️ 7,2 kg

C14

4 fiókos polipropilén húzható szerszámtartó táska

• Nagyfokú ütészédelmet biztosító injektált polipropilén szerkezet.

• A burkolattal rendelkező első rész 4 db 470x255 mm, kihúzható fiókot tartalmaz.

1 fiók 30 mm magas

2 fiók 60 mm magas

1 fiók 90 mm magas

• Az első központi zár lehetővé teszi a felső és az első burkolat egyidejű zárását.

• Két oldalfogantyú

• 4 erőteljes hátsó kerék

• Levehető felső tálca

• Fedélbe épített szerszámtartó panel

• 3 db szereléstartó tálcával

• Névtartó azonosító adattábla

• TSA lakattal történő zárásra felkészítve



	Ft	📦	🏠
C14	322.300	1	021140000
2114VU/M (C14+5914VU/M)	704.100	1	021141011

📏 585x390x457 mm - 🏋️ 10 kg

CP15 - 2115

Műanyag szerszám láda kivehető betéttel és tálcák kis tárgyak elhelyezésére

• 1 tálca kis tárgyak elhelyezésére, fedélbe beépítve

• 2 kivehető tálca kis tárgyak elhelyezésére állítható elválasztókkal

• 1 belső betét állítható elválasztókkal



	Ft	📦	🏠
CP15	19.800	1	021150201
2115PVU/1 (CP15+5915VU/1)	200.100	1	021151232
2115PVU/2 (CP15+5915VU/2)	174.800	1	021151234

📏 445x240x250 mm - 🏋️ 2 kg



CP15L - 2115

Műanyag szerszámos láda, hosszú kivitel kivehető betéttel és tálcák kis tárgyak elhelyezésére

- 3 tálcá kis tárgyak elhelyezésére, fedélbe beépítve, állítható elválasztókkal
- 1 belső betét elválasztókkal



	Ft		
CP15L	26.600	1	021150202
2115PL-VU/1 (CP15L+5915VU/1)	206.900	1	021151242
2115PL-VU/3 (CP15L+5915VU/3)	357.000	1	021151245

558x277x270 mm - 2,5 kg

2115PI/BIKE-HOME



	Ft		
2115PI/BIKE-HOME	98.850	1	021150098

- 96BP/SC9
- 3935
- 3969K3
- 42 8-9-10-13-14 mm
- 42SLIM 15 mm
- 1082G 160 mm
- 1150G 180 mm
- 1201E 3x75 - 5,5x150 mm
- 1202E PH0x60 - PH2x100 mm
- 3991

- BMESB1925NE 25 m
- BMM1436 3,6 x 140 mm

558x277x270 mm - 4,3 kg



2115P L-MQ32

32 darabos szigetelt szerszámkészlet hibridautóhoz, puha hőformázott tálcás műanyag kosárban



	Ft		
2115PL-MQ32	463.100	1	021150332

- 920MQ/55A
- 89MQ 10-12 mm
- 850MQ 1/4"
- 860TX/A10 T7-T8-T9-T10-T15-T20-T25-T27-T30-T40
- 920MQ/A 8-10-12-13-14-17-19 mm
- 920MQ/21 125mm
- 920MQ/22 250mm
- 1048MQ250 250mm
- 1150MQ 180mm
- 1164MQ160 160mm
- 1272MQ 4.5X80-6X100mm
- 1274MQ 3X100-4X100-5.5X125
- 1995MQ/G2 G2
- CP15L

C16 - 2116

Szerszámtáska belső rekeszekkel, üres



	Ft		
C16	43.850	1	021160000
2116VU/1 (C16+5915VU/1)	224.200	1	021161102
2116VU/3 (C16+5915VU/3)	374.200	1	021161105

500x260x260 mm - 2,5 kg

CP17 - CP17L - 2117

Szerszámos láda acéllemezről és műanyagból, betéttel



CP17
500x200x220 mm



CP17L
575x245x265 mm

	Ft		
CP17	36.900	1	021170500
2117P-VU/1 (CP17+5915VU/1)	217.200	1	021171042
2117P-VU/3 (CP17+5915VU/3)	367.300	1	021171045
CP17L	52.750	1	021170502
2117L-VU/1 (CP17L+5915VU/1)	233.100	1	021171142
2117PL-VU/3 (CP17L+5915VU/3)	383.100	1	021171145

C18 - 2118

Szerszámosláda acéllemezről



	Ft		
C18	17.350	1	021180001
2118VU/1 (C18+5915VU/1)	197.700	1	021181032

450x200x100 mm - 3 kg



C19 - 2119 - C19L - 2119L

Háromrekeszes szerszámos láda, fémlemez



	Ft	📦	🚚
C19	22.900	1	021190001
2119VU/3 (C19+5915VU/3)	353.300	1	021191025
C19L	29.400	1	021190002
2119L-VU/3 (C19L+5915VU/3)	359.800	1	021191125

C20 - C20L - 2120

Ötrekeszes szerszámos láda fémlemez



	Ft	📦	🚚
C20	32.600	1	021200001
2120VU/2 (C20+5915VU/2)	187.600	1	021201061
2120VU/3 (C20+5915VU/3)	363.000	1	021201063
2120VU/4 (C20+5915VU/4)	470.100	1	021201064
2120VU/AS (C20+5915VU/AS)	383.500	1	021201068
C20L	35.500	1	021200002
2120L-VU/2 (C20L+5915VU/2)	190.500	1	021201161
2120L-VU/3 (C20L+5915VU/3)	365.900	1	021201163
2120L-VU/4 (C20L+5915VU/4)	473.000	1	021201164
2120L-VU/AS (C20L+5915VU/AS)	386.400	1	021201168

C20TSS

Ötrekeszes szerszámos láda rozsdamentes acélból (AISI 304)



	Ft	📦	🚚
C20TSS	105.600	1	021203001

☰: 450x200x210 mm - 🏠 4kg

C22B

Szerszámláda acéllemezből



	Ft	📦	🚚
C22B-O	91.150	1	022000150
C22BM-O	104.800	1	022000160
C22BL-O	141.100	1	022000170

C22B O: 🏠 13 kg
C22BM O: 🏠 20 kg
C22BL O: 🏠 26 kg

C22W

Szerszámláda acéllemezből, belső borítás a szerszámok védelmére



	Ft	📦	🚚
C22W-O	102.900	1	022000269
C22WL-O	133.300	1	022000299

C22W O: 🏠 15 kg
C22WL O: 🏠 28 kg

C22P

szerszámos műhelyláda, lemezből

süllyesztett fogantyúk
emelt csúszótalpak targoncás felemeléshez
felfeszítésbiztos lakatolható kettős zár (lakat nélkül)



	Ft	📦	🚚
C22PM-O	271.200	1	022000240
C22PL-O	420.400	1	022000245

C22PM O: 🏠 39 kg
C22PL O: 🏠 67 kg



C99

A Combo a Beta új moduláris rendszere, amely három különböző robusztus szerszámládával

megkönnyíti a szerszámok biztonságos és rendezett tárolását.

A szerszámládák az oldalt elhelyezkedő mechanizmusnak köszönhetően egyszerűen összepattinthatók.

Az új Beta Combo C99 rendszer kompatibilis a Sortimo® L-BOXX szabványával.

C99

BETA COMBO komplett moduláris rendszer

A szerszámdobozok egyszerűen összekapcsolhatók egy kattintással, a praktikus oldalsó bepattintós mechanizmus segítségével.

Rendszer összeállítás:

- Ultrakompakt összecsupkható szállítókoszi teleszkópos fogantyúval C99P (485x520x1095 mm)
- ABS szerszámdoboz C99V1 (445x358x152 mm)
- ABS szerszámdoboz C99V2 (445x358x254 mm)
- ABS szerszámdoboz, 2 darab kivehető C99V3/2C tálcával (445x358x322 mm)



C99

Ft 232.200 1 099000010

C99V0

COMBO ABS szerszámdoboz átlátszó fedéllel

Az oldalsó bepattintós mechanizmussal a szerszámdobozok egyszerűen összepattinthatók.

Fő jellemzők:

- Az erős átlátszó polikarbonát fedélnek köszönhetően gyorsan felismerhető a tartalma
- Külső méret: 445x358x118 mm
- Max. belső teherbírás: 25 kg
- Lelakatható
- Súly: 2,5 kg

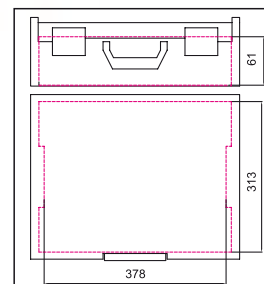

C99V0

Ft 35.450 1 099000202

C99V0-P12

COMBO ABS szerszámdoboz átlátszó fedéllel

Az oldalsó bepattintós mechanizmussal a szerszámdobozok egyszerűen összepattinthatók.

Fő jellemzők:

- Az erős átlátszó polikarbonát fedélnek köszönhetően gyorsan felismerhető a tartalma
- Különösen alkalmas tömegcikkek, így csavarok, anyák, alátétek, szegecsek és tiplik szállítására
- 18 tálcát tartalmaz:
 - 2 piros tábla, 52x52 mm
 - 3 sárga tábla, 104x52 mm
 - 2 kék tábla, 104x104 mm
 - 1 zöld tábla, 104x156 mm
 - 2 narancs tábla, 208x52 mm
 - 2 szürke tábla, 312x71 mm, és 6 állítható válaszfal
- Külső méret: 445x358x118 mm
- Max. belső teherbírás: 25 kg
- Lelaktolható
- Súly: 3,2 kg

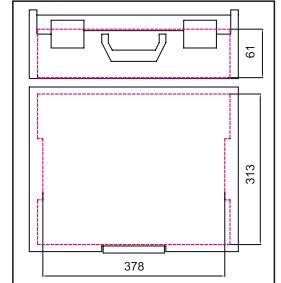

C99V0-P12

Ft 52.050 1 099000200

C99P12-V0

18 darabos szerszámostálca a C99V0 szerszámtáskához

Készlet tartalma:

- 2 piros tábla, 52x52 mm
- 3 sárga tábla, 104x52 mm
- 2 kék tábla, 104x104 mm
- 1 zöld tábla, 104x156 mm
- 2 narancs tábla, 208x52 mm
- 2 szürke tábla, 312x71 mm, és 6 állítható válaszfal



C99P12-V0

Ft 16.600 1 099000499

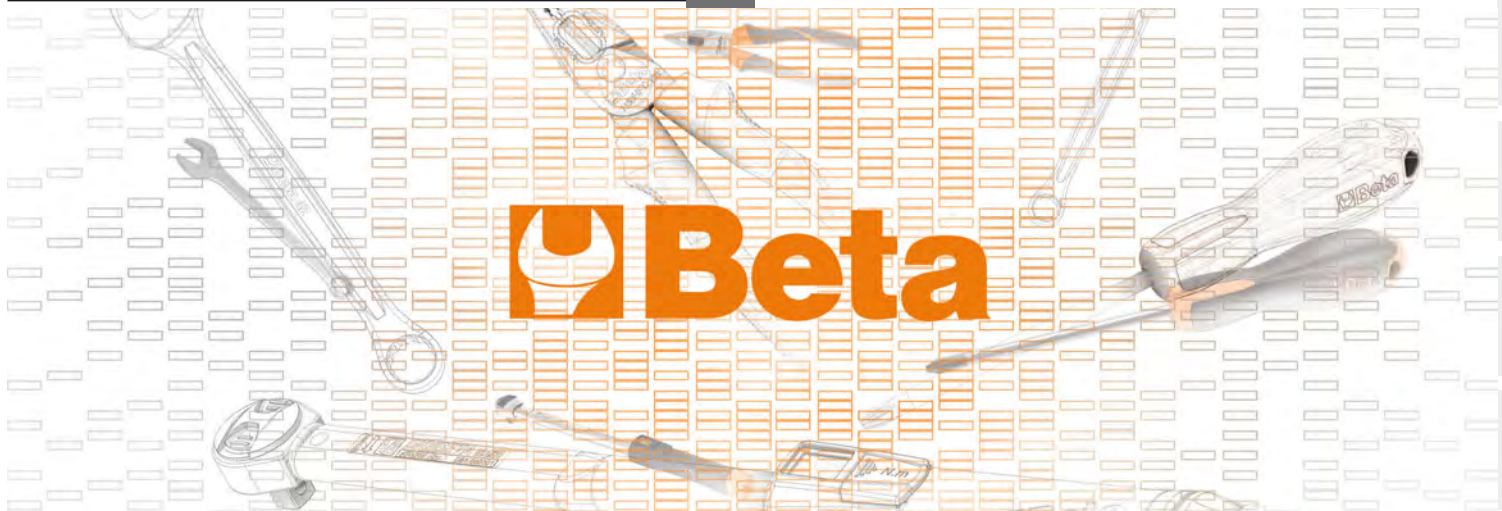

C99V1

COMBO ABS szerszámdoboz

A szerszámdobozok egyszerűen összekapcsolhatók egy kattintással, a praktikus oldalsó bepattintós mechanizmus segítségével.

Főbb jellemzői:

- Külső méretek: 445x358x152 mm
- Max. belső teherbírás: 25 kg
- Lakattal zárható
- Súly: 2,2 kg

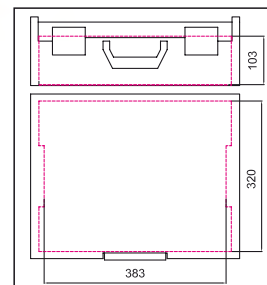

C99V1

Ft 40.000 1 099000250

C99V2

COMBO ABS szerszámdoboz

A szerszámdobozok egyszerűen összekapcsolhatók egy kattintással, a praktikus oldalsó bepattintós mechanizmus segítségével.

Főbb jellemzői:

- Külső méretek: 445x358x254 mm
- Max. belső teherbírás: 25 kg
- Súly: 2,8 kg

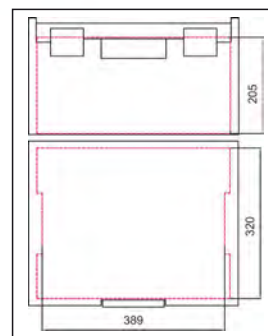

C99V2

Ft 45.000 1 099000350



C99V3/2C

COMBO ABS szerszámdoboz 2 darab kivehető rendezőtálccával

A szerszámdobozok egyszerűen összekapcsolhatók egy kattintással, a praktikus oldalsó bepattintós mechanizmus segítségével.

Főbb jellemzői:

- Külső méretek: 445x358x322 mm
- 2 darab C99C-V3 üres rendezőtálca
- Max. belső teherbírás: 25 kg
- Súly: 5,6 kg

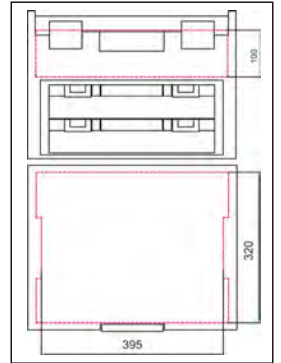

C99V3/2C

Ft 84.250 1 099000450

C99C-V3

COMBO kivehető rendezőtálca

Az átlátszó fedélnek köszönhetően könnyen felismerhető a tartalma. Beépített fogantyú.

Külső méret: 367x316x72 mm

Súly: 0,9 kg

Lehetséges belső kialakítás:

- 7 rekesz C99T-V3 műanyag tálca
- 17 darab C99P-V3 tálca

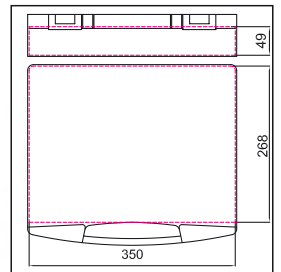

C99C-V3

Ft 13.750 1 099000496

C99P

COMBO összehajtható szállítókosz

Fő jellemzők:

- Ultrakompakt összehajtható szerszámkocsi
- Teleszkópos fogantyú
- Méret nyitott állapotban: 485x520x1095 mm
- Méret zárt állapotban: 485x80x810 mm
- Alap mérete: 485x350 mm
- Két defektvédett kerék, Ø 175 mm
- Hordozópá



C99P

Ft 62.900 1 099000101

C99PC

betét a C99V1 és C99V3/2C szerszámosztáskához

A hőformált tálcákkal együtt szükséges, mivel megakadályozza, hogy a rekeszek tartalma szállítás közben kiessen vagy összekeveredjen.



C99PC

Ft 6.550 1 099000491

C99T

4 rekeszes hőformált tálca a C99V1 és C99V3/2C szerszámtáskához



C99T

Ft 9.380 1 099000492

C99M

szivacsbetét, a COMBO C99VI, C99V2 és C99V3/2C szerszámdobozokhoz

Könnyen alakítható, biztonságos és egyéni szerszámelhelyezést tesz lehetővé

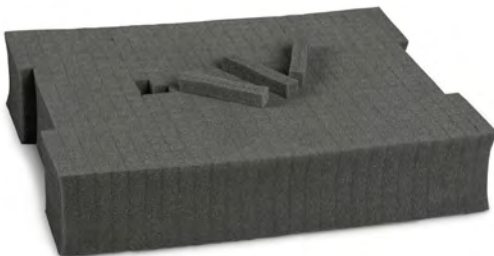

C99M

Ft 16.500 1 099000494

C99T-V3

7 rekeszes hőformált tálca a C99C-V3 szerszámoszládához



C99T-V3

Ft 4.760 1 099000497

C99P-V3

17 darabos szerszámosztálca a C99C-V3 szerszámoszládához

Készlet tartalma:

- 6 piros tálca 52x52 mm
- 2 sárga tálca 104x52 mm
- 3 szürke tálca 78x260 mm és 6 elválasztó



C99P-V3

Ft 13.150 1 099000498

C99PP

szerszámtartó panel COMBO szerszámdobozokhoz

- 6 zseb és 11 szerszámtartó gumipánt
- a panel szerszámdoboz fedelére rögzítéséhez szükséges kampókkal szállítva



306 mm

376 mm

C99PP

Ft 19.250 1 099000489



RSC22

3 fiókos
szerszámosláda

Fő jellemzők:

3 teleszkópos, csapágyazott fiók (588x277 mm):

1 fiók, 50 mm magas

2 fiók, 70 mm magas.

- Központi zár elől.

- Süllyeszthető oldalfogantyúk a könnyebb kezelés érdekében.

19 kg



RSC22-O



RSC22-A



RSC22-R



h	max
50 mm	25 kg
70 mm	25 kg

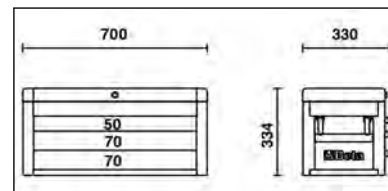
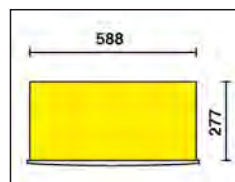

		Ft	1	1
RSC22-O	RAL 2011	180.200	1	022003001
RSC22-R	RAL 3000	180.200	1	022003003
RSC22-A	RAL 7016	180.200	1	022003007

RSC23

5 fiókos
szerszámoszláda

Fő jellemzők:

- 5 teleszkópos, csapágyazott fiók (588x277 mm):
- 2 fiók, 50 mm magas
- 3 fiók, 70 mm magas.
- Központi zár elöl.
- Süllyeszhető oldalfogantyúk a könnyebb kezelés érdekében.

📦 26 kg



RSC23-A



RSC23-R



RSC23-O



h	max
50 mm	25 kg
70 mm	25 kg

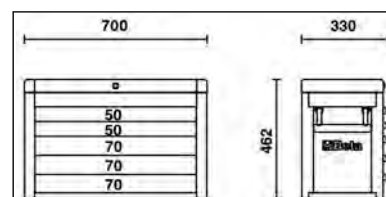
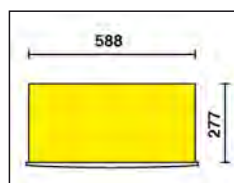

		Ft	📦	🖨️
RSC23-O	RAL 2011	216.400	1	023003001
RSC23-R	RAL 3000	216.400	1	023003003
RSC23-A	RAL 7016	216.400	1	023003007

CD23S

Caddy szállítókosci

Fő jellemzők:

- ABS-sel bevont munkalap, melyre a C22S, C23S, C23SC vagy C23ST modell ráhelyezhető.
- A kocsi rúd leszerelhető és a kocsi alatt tárolható.
- Négy Ø 100 mm kerék: 2 rögzített és 2 forgókerék (egy kerék fékezhető).
- Maximális teherbírás: 250 kg.

📦 14 kg



		Ft	📦	🖨️
CD23S		104.600	1	023000610

RSC23C

8 fiókos
szerszámoszláda

Fő jellemzők:

- 8 teleszkópos, csapágyazott fiók (588x277 mm):
- 4 fiók, 50 mm magas
- 3 fiók, 70 mm magas
- 1 fiók 100 mm magas.
- Központi zár elöl.
- Süllyeszhető oldalfogantyúk a könnyebb kezelés érdekében.

📦 28 kg



RSC23C-A



RSC23C-R



RSC23C-O



h	max
50 mm	25 kg
70 mm	25 kg

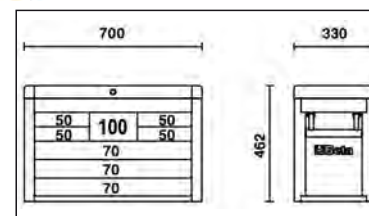
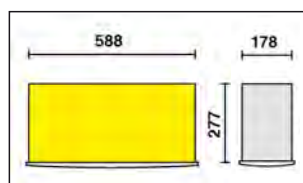

		Ft	📦	🖨️
RSC23C-O	RAL 2011	244.700	1	023003011
RSC23C-R	RAL 3000	244.700	1	023003013
RSC23C-A	RAL 7016	244.700	1	023003017

RSC23T

5 fiókos
szerszámosláda

Fő jellemzők:

5 teleszkópos, csapágyazott fiók (588x367 mm):

5 fiók, 70 mm magas.

• Központi zár elől.

• 4 darab kerék és fogantyú rászerezhető (2300ST/KIT)

36 kg



RSC23T-A



RSC23T-B



RSC23T-O



RSC23T-G



RSC23T-FO

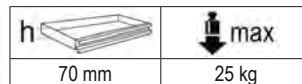

RSC23T-N



RSC23T-R

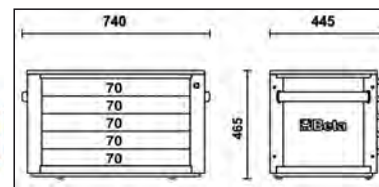

		Ft		
RSC23T-FO	RAL 2011	273.000	1	023003020
RSC23T-O	RAL 2011	273.000	1	023003021
RSC23T-G	RAL 9006	273.000	1	023003022
RSC23T-R	RAL 3000	273.000	1	023003023
RSC23T-B	RAL 5015	273.000	1	023003026
RSC23T-A	RAL 7016	273.000	1	023003027
RSC23T-N	RAL 9005	273.000	1	023003029

2300ST/KIT

1 fogantyú és 4 kerék a C23ST szerszámládahoz

• Négy Ø 125 mm kerék:

2 rögzített és 2 forgókerék (egy kerék fékezhető).

• Teleszkópos fogantyú

6,5 kg

2300ST/KIT		Ft		
		67.950	1	023000950



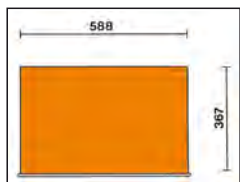

Beta

Beta
RSC24



Választható színek

RSC24-		h 
FO	RAL 2011	RAL 2011
O	RAL 7016	RAL 2011
G	RAL 7016	RAL 9006
R	RAL 7016	RAL 3000
B	RAL 7016	RAL 5015
A	RAL 7016	RAL 7016
N	RAL 9005	RAL 9005

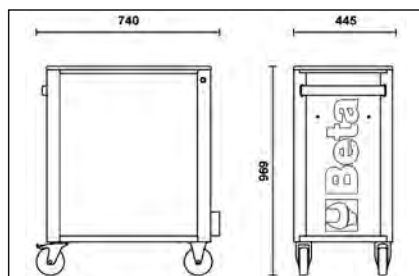

ÚJ MUNKALAP ERŐSEBB ÉS ROBOSZTUSABB KÉNYELMESEBB ÉS PRAKTIKUSABB MODERNEBB



- Teleszkópos, csapágyazott fiókok
- A fiókok habgumival bélelték
- Mindegyik fiókba 4 db ¼-es EVA habszivacs vagy ABS hőformált tálcá helyezhető el
- Új ABS erősítésű munkalap RSC22, RSC23, RSC23C és RSC23T szerszámszekrényhez
- Univerzális munkalap legurulásgátló peremmel és nyolc csavarhúzó tartó lyukkal
- Központi biztonsági zár elől
- Négy Ø 125 mm kerék: 2 rögzített és 2 forgó kerék (egy kerék fékezhető)
- Statikus terhelhetőség: 800 kg

Választható modellek:

- RSC24/5 (5 fiókos)
- RSC24/6 (6 fiókos)
- RSC24/7 (7 fiókos)
- RSC24/8 (8 fiókos)

Választható tartozékok:



RSC24/7

7 fiókos szerszámkoscsi

Fő jellemzők:

- 7 teljesen kivethető, teleszkópos, csapágyazott fiók, 588x367 mm:
- 5 fiók, 70 mm magas
- 1 fiók, 140 mm magas
- 1 fiók, 210 mm magas

63 kg

RSC24/7-FO	RSC24/7-O	RSC24/7-G	RSC24/7-R	RSC24/7-B	RSC24/7-A	RSC24/7-N
312.900	312.900	312.900	312.900	312.900	312.900	312.900
1	1	1	1	1	1	1
024004070	024004071	024004072	024004073	024004076	024004077	024004079



Beta
RSC24



RSC24/7-FO



RSC24/7-A



RSC24/7-B



RSC24/7-G





RSC24/7-N



RSC24/7-R



RSC24/7-O

h 	max 
70 mm	25 kg
140 mm	30 kg
210 mm	30 kg



RSC24/5

5 fiókos szerszámkocsi

Fő jellemzők:

- 5 teljesen kivethető, teleszkópos, csapágyazott fiók, 588x367 mm:
- 2 fiók, 70 mm magas
- 2 fiók, 140 mm magas
- 1 fiók, 280 mm magas

60 kg

	Ft		
RSC24/5-FO	288.300	1	024004050
RSC24/5-O	288.300	1	024004051
RSC24/5-G	288.300	1	024004052
RSC24/5-R	288.300	1	024004053
RSC24/5-B	288.300	1	024004056
RSC24/5-A	288.300	1	024004057
RSC24/5-N	288.300	1	024004059



RSC24/5-O

Beta RSC24



h	max
70 mm	25 kg
140 mm	30 kg
280 mm	35 kg



RSC24/6

6 fiókos szerszámkocsi

Fő jellemzők:

- 6 teljesen kivethető, teleszkópos, csapágyazott fiók, 588x367 mm:
- 4 fiók, 70 mm magas
- 1 fiók, 140 mm magas
- 1 fiók, 280 mm magas

62 kg

	Ft		
RSC24/6-FO	297.600	1	024004060
RSC24/6-O	297.600	1	024004061
RSC24/6-G	297.600	1	024004062
RSC24/6-R	297.600	1	024004063
RSC24/6-B	297.600	1	024004066
RSC24/6-A	297.600	1	024004067
RSC24/6-N	297.600	1	024004069



RSC24/6-O

Beta RSC24



h	max
70 mm	25 kg
140 mm	30 kg
280 mm	35 kg



RSC24/8

8 fiókos szerszámkocsi

Fő jellemzők:

- 8 teljesen kivethető, teleszkópos, csapágyazott fiók, 588x367 mm:
- 6 fiók, 70 mm magas
- 2 fiók, 140 mm magas

66 kg

	Ft		
RSC24/8-FO	345.700	1	024004080
RSC24/8-O	345.700	1	024004081
RSC24/8-G	345.700	1	024004082
RSC24/8-R	345.700	1	024004083
RSC24/8-B	345.700	1	024004086
RSC24/8-A	345.700	1	024004087
RSC24/8-N	345.700	1	024004089



RSC24/8-O

Beta RSC24



h	max
70 mm	25 kg
140 mm	30 kg

RSC24A/6

6 fiókos szerszámkocsi
borulásgátló rendszerrel

Fő jellemzők:

- 6 teljesen kivethető, teleszkópos, csapágyazott fiók, 588x367 mm:
- 4 fiók, 70 mm magas
- 1 fiók, 140 mm magas
- 1 fiók, 280 mm magas

800
kg



RSC24A/6-O

62 kg

	Ft		
RSC24A/6-O	320.400	1	024004161
RSC24A/6-R	320.400	1	024004163
RSC24A/6-A	320.400	1	024004167

Beta
RSC24



RSC24A/6-A



RSC24A/6-R



h	max
70 mm	25 kg
140 mm	30 kg
280 mm	35 kg

RSC24A/7

7 fiókos szerszámkocsi
borulásgátló rendszerrel

Fő jellemzők:

- 7 teljesen kivethető, teleszkópos, csapágyazott fiók, 588x367 mm:
- 5 fiók, 70 mm magas
- 1 fiók, 140 mm magas
- 1 fiók 210 mm magas.

800
kg



RSC24A/7-O

63 kg

	Ft		
RSC24A/7-O	343.000	1	024004171
RSC24A/7-R	343.000	1	024004173
RSC24A/7-A	343.000	1	024004177

Beta
RSC24



RSC24A/7-A



RSC24A/7-R



h	max
70 mm	25 kg
140 mm	30 kg
210 mm	30 kg

RSC24A/8

8 fiókos szerszámkocsi
borulásgátló rendszerrel

Fő jellemzők:

- 8 teljesen kivethető, teleszkópos, csapágyazott fiók, 588x367 mm:
- 6 fiók, 70 mm magas
- 2 fiók, 140 mm magas

800
kg



RSC24A/8-O

66 kg

	Ft		
RSC24A/8-O	369.600	1	024004181
RSC24A/8-R	369.600	1	024004183
RSC24A/8-A	369.600	1	024004187

Beta
RSC24



RSC24A/8-A



RSC24A/8-R



h	max
70 mm	25 kg
140 mm	30 kg

RSC24AXL SZERSZÁMKOCSI



HOSSZÍTOTT KIVITEL: Mindegyik fiókba 6 db ¼-es EVA habszivacs vagy ABS hőformált tálca helyezhető el

BORULÁSGÁTLÓ RENDSZER:
MEGAKADÁLYOZZA TÖBB FIÓK
EGYSZERRE TÖRTÉNŐ KINYITÁSÁT



- Teleszkópos, csapágyazott fiókok
- ABS erősítésű munkalap legurulásgátló peremmel, 8 csavarhúzótartó lyukkal és 6 szerszámotálccával
- Rendkívül ellenálló nejlón előlap beépített címketartóval
- Négy Ø 125 mm kerék: 2 rögzített és 2 forgó kerék (egy kerék fékezhető)
- Statikus terhelhetőség: 1000 kg
- A fiókok habgumival bélelték
- Beépített oldalsó flakontartó
- Központi biztonsági zár elől

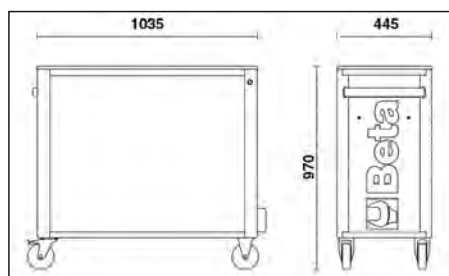

Választható színek:

	RAL 7016	RAL 2011
O	RAL 7016	RAL 2011
G	RAL 7016	RAL 7016
R	RAL 7016	RAL 3000

Választható tartozékok:



2400 RSC24/PD-A



2400 RSC24/PL



2400 RSC24/PC-A

RSC24AXL/7

7 fiókos szerszámokcsi borulásgátló rendszerrel, hosszú modell

Fő jellemzők:

- 7 teljesen kivethető, teleszkópos, csapágyazott fiók, 882x367 mm:
- 5 fiók, 70 mm magas
- 1 fiók, 140 mm magas
- 1 fiók, 210 mm magas



h	max
70 mm	30 kg
140 mm	35 kg
210 mm	35 kg



84 kg

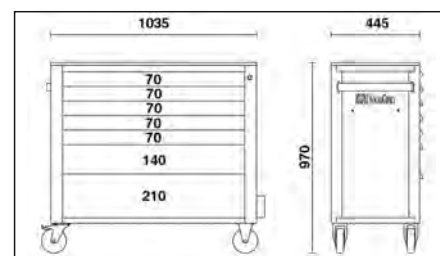
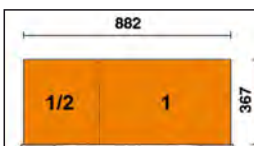

	Ft	↓	↑
RSC24AXL/7-O	435.600	1	024004271
RSC24AXL/7-R	435.600	1	024004273
RSC24AXL/7-A	435.600	1	024004277

RSC24AXL/8

8 fiókos szerszámkocsi
borulásgátló rendszerrel,
hosszú modell

Fő jellemzők:

- 8 teljesen kivethető, teleszkópos, csapágyazott fiók, 882x367 mm:
- 6 fiók, 70 mm magas.
- 2 fiók, 140 mm magas.

88 kg

	Ft	1	024004281
RSC24AXL/8-O	466.900	1	024004281
RSC24AXL/8-R	466.900	1	024004283
RSC24AXL/8-A	466.900	1	024004287

RSC24AXL/9

9 fiókos szerszámkocsi
borulásgátló rendszerrel,
hosszú modell

Fő jellemzők:

- 9 teljesen kivethető, teleszkópos, csapágyazott fiók, 882x367 mm:
- 8 fiók, 70 mm magas
- 1 fiók 140 mm magas.

90 kg

	Ft	1	024004291
RSC24AXL/9-O	496.400	1	024004291
RSC24AXL/9-R	496.400	1	024004293
RSC24AXL/9-A	496.400	1	024004297

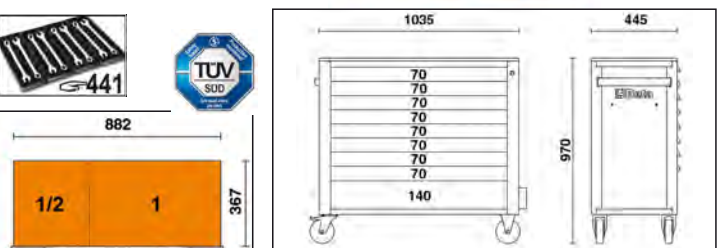
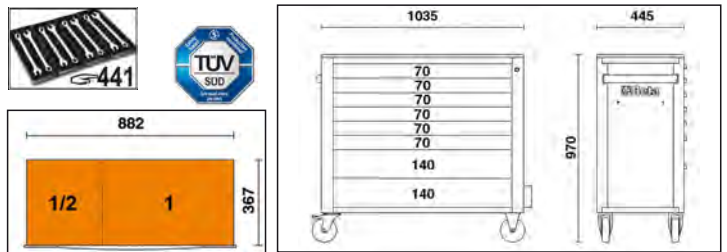

2400 RSC24/PC

papírtekerstartó az RSC24 szerszámkocsihoz

0,3 kg

	Ft	1	024004903
2400 RSC24/PC-A	7.720	1	024004903
2400 RSC24/PC-N	7.720	1	024004904



RAL7016 2400 RSC24/PC-A
RAL9005 2400 RSC24/PC-N



2400 RSC24/PD

dokumentumtartó az RSC24 szerszámkocsihoz

1,2 kg

	Ft	1	024004907
2400 RSC24/PD-A	13.700	1	024004907
2400 RSC24/PD-N	13.700	1	024004908



RAL7016 2400 RSC24/PD-A
RAL9005 2400 RSC24/PD-N



2400 RSC24/PF

perforált szerszámtartó panel konzollal RSC24 szerszámkocsihoz

2,3 kg

	Ft	1	024004902
2400 RSC24/PF	24.500	1	024004902

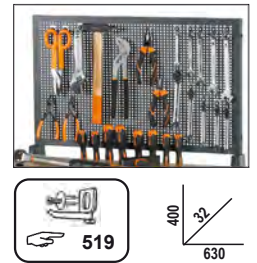

2400 RSC24/PF-

palacktartó az RSC24 szerszámkocsihoz

0,5 kg

	Ft	1	024004905
2400 RSC24/PF-A	9.020	1	024004905
2400 RSC24/PF-N	9.020	1	024004906

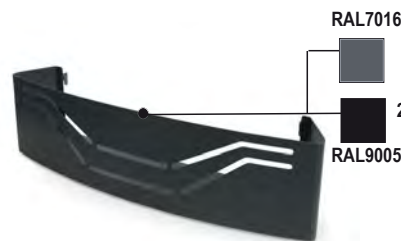

RAL7016 2400S RSC24/PF-A
RAL9005 2400S RSC24/PF-N



2400 RSC24/PL

fa munkalap a RSC24 fiókos szerszámkocsihoz

4,3 kg

	Ft	1	024004901
2400 RSC24/PL	33.900	1	024004901



2400 RSC24/SPC

számítógép konzol az RSC24 fiókos szerszámkocsihoz

- Kivehető fiók
- Az RSC24AXL modellel nem használható

3,1 kg

	Ft	1	024004909
2400 RSC24/SPC	49.250	1	024004909



2400 RSC24/MP

lehajtható polc az RSC24 - RSC24A - RSC51 modellhez

- Kiegészítő munkalapként használható
- Munkalap méretei: 390x440 mm, olaj- és benzinálló gumi borítással védve
- Terhelési kapacitás: 20 kg

📦 3,4 kg



2400 RSC24/MP

Ft 30.000 1 024004900

2499PF

Flakontartó

- Tartozékok a C38, C38A

📦 2,5 kg

	Ft	📦	🏠
2499PF-O	27.550	1	024990210
2499PF-G	27.550	1	024990219
2499PF-R	27.550	1	024990230

2499PF O

2499PF G

2499PF R



2499PF/M

Univerzális mágneses flakontartó

📦 2,2 kg

	Ft	📦	🏠
2499PF/M	25.050	1	024990050



2499PC

papírtekerstartó

- A C25 Tank szerszámkocsikra és C38 szerszámkocsikra szerelhető.

📦 2,2 kg

	Ft	📦	🏠
2499PC	29.200	1	024990090



RSC24L/7

7 fiókos
szerszámkocsi
oldalpolccal

Fő jellemzők:

- 7 teleszkópos, csapágyazott fiók (588x367 mm):
5 fiók, 70 mm magas
1 fiók, 140 mm magas
1 fiók 210 mm magas.
 - A fiókok habgumival béleltek.
 - Négy Ø 125 mm kerék:
 - 2 rögzített és 2 fékezhető forgókerék.
 - Központi zár elől.
 - Statikus terhelhetőség: 1 100 kg.
 - Rétegelt fa munkalap
- furatokkal a satu rögzítéséhez
(A 1599F/100 satut külön kell megrendelni.)
- Oldalrekesz állítható magasságú polccal.
 - Beépített papírtekerstartó.
 - Két hátsó flakontartó.
 - Beépített oldalsó flakontartó

80 kg

		Ft	📦	🚚
RSC24L/7-O	RAL 2011	471.300	1	024004371
RSC24L/7-R	RAL 3000	471.300	1	024004373
RSC24L/7-A	RAL 7016	471.300	1	024004377

Beta RSC24

1100 kg



RSC24L/7-A



RSC24L/7-R



RSC24L/7-O

h	max
70 mm	25 kg
140 mm	30 kg
210 mm	30 kg

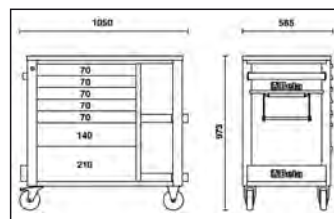
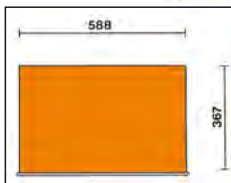

RSC24L-CAB

7 fiókos
szerszámkocsi
szerszámszekrényel

Fő jellemzők:

- 7 teleszkópos, csapágyazott fiók (588x367 mm):
5 fiók, 70 mm magas
1 fiók, 140 mm magas
1 fiók 210 mm magas.
 - A fiókok habgumival béleltek.
 - Négy Ø 125 mm kerék:
 - 2 rögzített és 2 fékezhető forgókerék.
 - Központi zár elől.
 - Oldalsó szerszámszekrény zárható ajtóval és állítható magasságú belső polccal.
 - Statikus terhelhetőség: 1 100 kg.
 - Rétegelt fa munkalap
- furatokkal a satu rögzítéséhez
(A 1599F/100 satut külön kell megrendelni.)
- Beépített papírtekerstartó.
 - Két hátsó flakontartó.
 - Beépített oldalsó flakontartó

82 kg

		Ft	📦	🚚
RSC24L-CAB/O	RAL 2011	487.600	1	024004471
RSC24L-CAB/R	RAL 3000	487.600	1	024004473
RSC24L-CAB/A	RAL 7016	487.600	1	024004477

Beta RSC24

1100 kg



RSC24L-CAB/A



RSC24L-CAB/R



RSC24L-CAB/O

h	max
70 mm	25 kg
140 mm	30 kg
210 mm	30 kg

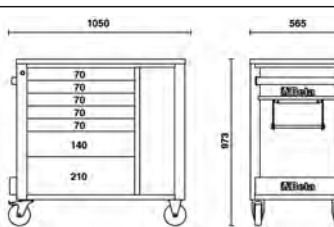
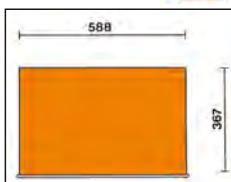

C04TSS-7

7 fiókos szerszámkocsi teljesen rozsdamentes acélból
Nem hagynak nyomot a kerekek.

Főbb jellemzők:

- Hét darab 570 x 410 mm teleszkópos, csapágyazott fiókkal;
- 6 fiók magassága 83 mm;
- 1 fiók magassága 170 mm;
- 4 kerék Ø 125 mm
- 2 rögzített és 2 elfordítható (kettő fékkel)
- Központi zár elől;
- Teljesen rozsdamentes acél szerkezet;
- Kerekek, tartóelemek, csapágyak, fiókbelső és fiókvezetők rozsdamentes acélból
- Alumínium fiókfogantyúk

📦 63 kg

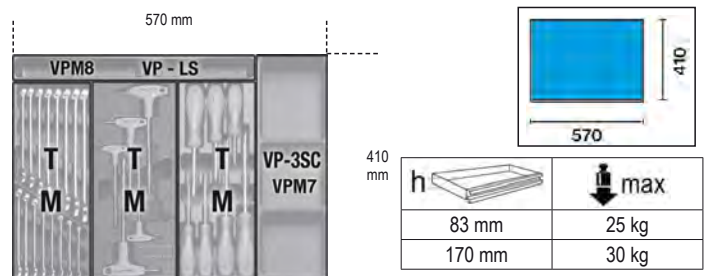

C04TSS/7 Ft 1.028.700 1 024003077 305

C25

Tank polcos szerszámkocsi

Fő jellegzetességek:

- bukófedél
- 1 csúszó tálca
- a szerszámtálca habgumival bélelt
- a polcok olaj- és benzinálló gumival bélelték
- négy 100 mm-es kerék,
- 2 fix és 2 forgó (az egyik fékes)
- biztonsági zár
- hőformált tálca 1/2"-os dugókulcshoz és tartozékhoz, üres (024990104)
- 2499PC papírtekerstartóval kiegészíthető

📦 31,5 kg

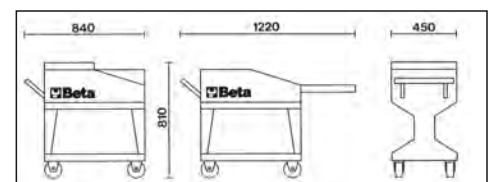

C25 Ft 290.100 1 025000001

C27S

Szerszámkocsi összecsuksukható

Zárható kocsi összecsuksukható vázzal a könnyebb szállítás érdekében

2 teleszkópos fiók, 588x277 mm, mindkét irányban nyitható

Nagy alsó szerszámrekesz 588x277x220 mm

Szerkezet lemezből

2 fix kerék Ø 160 mm és 2 forgó kerék Ø 100 mm (egyik fékes)

termoplasztik munkalap 6 beépített tálcával kis tárgyak elhelyezésére

Központi zár

A fiókban elválasztók és MC hőformált tálcák a szerszám elhelyezésére

20 kg



C27S-O



C27S-G



C27S-R



h	max
70 mm	20 kg

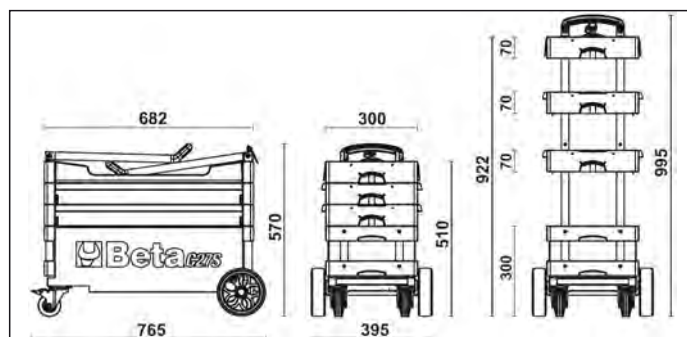
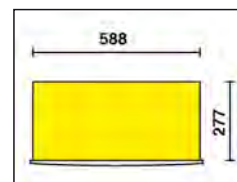

		Ft	📦	🚚
C27S-O	RAL 2011	290.600	1	027000201
C27S-G	RAL 7016	290.600	1	027000202
C27S-R	RAL 3000	290.600	1	027000203

RSC28

SuperTank szerszámkocsi fa munkalappal és 10 fiókkal

Fő jellemzők:

- 10 teleszkópos, csapágyazott fiók (588x367 mm).
- Gyors és biztos fióknyitás és zárás, a fiók elülső része nylon- és üvegszál.
- 5 oldalsó fiók:
 - 4 fiók, 70 mm magas
 - 1 fiók 210 mm magas.
- 5 fiók elől:
 - 4 fiók, 70 mm magas
 - 1 fiók 210 mm magas.
- A fiókok habgumival béleltek.
- Négy Ø 150 mm kerék:
- 2 rögzített és 2 fékezhető forgókerék.
- 2 központi biztonsági zár.
- 3 szerszámfiók elől.
- Rétegzett fa munkalap furatokkal a satu rögzítéséhez (A 1599F/150 satut külön kell megrendelni.)
- Beépített szerszámrekesz.
- Zárható oldalrekesz bukóajtóval.
- Beépített flakontartók.
- 135 mm magas raktér műanyag borítással.
- Statikus terhelhetőség: 1 200 kg.

1200
kg



RSC28-O

130 kg



RSC28-A



RSC28-R



h	max
70 mm	25 kg
210 mm	30 kg

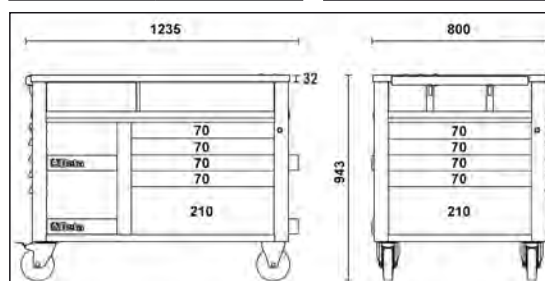
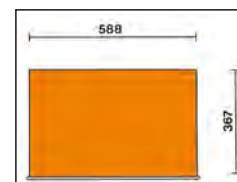

	Ft	1	2
RSC28-O	1.017.400	1	028003001
RSC28-R	1.017.400	1	028003003
RSC28-A	1.017.400	1	028003007

C30M

MaxiTank mobil munkapad

Fő jellemzők:

- 5 teleszkópos, csapágyazott elülső fiók:
- 3 fiók (367x610 mm), 90 mm magas
- 1 fiók (588x610 mm), 90 mm magas
- 1 fiók (588x610 mm), 180 mm magas.
- A fiókok elülső részén alumínium gyorsnyitó rendszer.
- A fiókok habgumival béleltek.
- Hőformált tálcák elhelyezhetők.
- Hidraulikus emelőkar lehetővé teszi a könnyű és praktikus szállítást.
- Négy kerék:
- 2 forgó, elől, Ø 150 mm
- 2 fix, hátul, Ø 170 mm.
- Olajálló gumibetétes munkalap, 1300x800 mm, leeresztő furattal, amely egy kis folyadékgyűjtő tartályhoz csatlakozik.
- Tároló rekesz 720x250x1300 mm, PVC-bevonattal, elől bukóajtóval.
- Központi zár.
- 3 beépített oldalsó flakontartó.
- Beépített papírtekercstartó
- Statikus terhelhetőség: 1 800 kg.
- Multiplex-munkalap (3000 S/PLM) - külön kell megrendelni
- Furatokkal a satu rögzítéséhez 1599F/150(a satu külön kell megrendelni).

1800
kg



200 kg

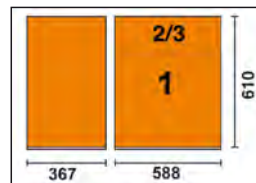

h	max
90 mm	30 kg
180 mm	35 kg

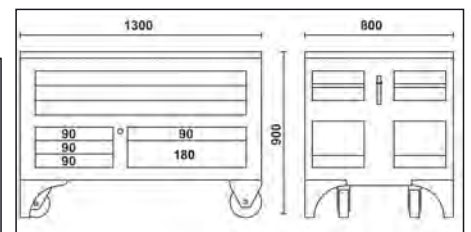

C30M

Ft 1.613.500 1 030000300

3000M/PLM

fa munkalap a C30M-hez
furatokkal a satu rögzítéséhez (1599F/150)

10 kg



1240x740x26 mm

3000M/PLM

Ft 155.700 1 030000350

FUNKCIONÁLIS ÉS STRAPABÍRÓ



- Kihúzható fiókok
- Központi biztonsági zár elől
- Munkalaphoz és fiók elválasztókhöz előkészítve, ezeket külön kell megrendelni
- Statikus terhelhetőség: 1200 kg

Választható modellek:

- C35/6GM (6 fiókos)
- C35/7GM (7 fiókos)
- C35/8GM (8 fiókos)
- C35/9GM (9 fiókos)

Választható tartozékok:

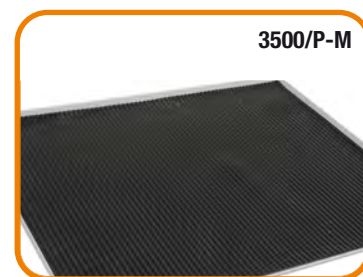

C35/6GM

6 fiókos, ipari, rögzített szerszámszekrény

Fő jellemzők:

- 6 kihúzható fiók (600x447 mm):
 - 2 fiók, 75 mm magas
 - 1 fiók, 100 mm magas
 - 1 fiók, 150 mm magas
 - 1 fiók, 200 mm magas
 - 1 fiók, 300 mm magas
- Központi biztonsági zár elől
- Munkalaphoz és fiók elválasztókhöz előkészítve, ezeket külön kell megrendelni

75 kg



h	↓ max
75 mm	70 kg
100 mm	70 kg
150 mm	70 kg
200 mm	70 kg
300 mm	70 kg

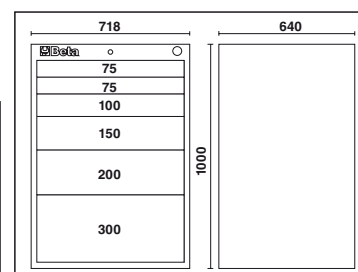
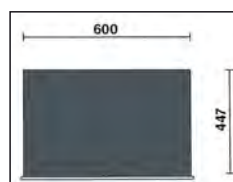

C35/6GM Ft 746.700 1 035000162

C35/7GM

7 fiókos, ipari, rögzített szerszámszekrény

Fő jellemzők:

- 7 kihúzható fiók (600x447 mm):
 - 2 fiók, 75 mm magas
 - 1 fiók, 100 mm magas
 - 3 fiók, 150 mm magas
 - 1 fiók, 200 mm magas
- Központi biztonsági zár elöl
- Munkalaphoz és fiók elválasztókhöz előkészítve, ezeket külön kell megrendelni

82 kg

C35/7GM Ft 780.900 1 035000172



h	max
75 mm	70 kg
100 mm	70 kg
150 mm	70 kg
200 mm	70 kg

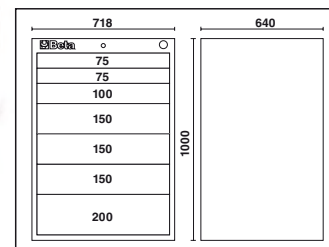
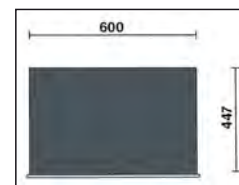

C35/8GM

8 fiókos, ipari, rögzített szerszámszekrény

Fő jellemzők:

- 8 kihúzható fiók (600x447 mm):
 - 4 fiók, 75 mm magas
 - 1 fiók, 100 mm magas
 - 2 fiók, 150 mm magas
 - 1 fiók, 200 mm magas
- Központi biztonsági zár elöl
- Munkalaphoz és fiók elválasztókhöz előkészítve, ezeket külön kell megrendelni

86 kg

C35/8GM Ft 831.200 1 035000182



h	max
75 mm	70 kg
100 mm	70 kg
150 mm	70 kg
200 mm	70 kg

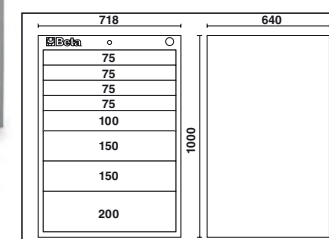

C35/9GM

9 fiókos, ipari, rögzített szerszámszekrény

Fő jellemzők:

- 9 kihúzható fiók (600x447 mm):
 - 6 fiók, 75 mm magas
 - 3 fiók, 150 mm magas
- Központi biztonsági zár elöl
- Munkalaphoz és fiók elválasztókhöz előkészítve, ezeket külön kell megrendelni

91 kg

C35/9GM Ft 871.500 1 035000192



h	max
75 mm	70 kg
150 mm	70 kg

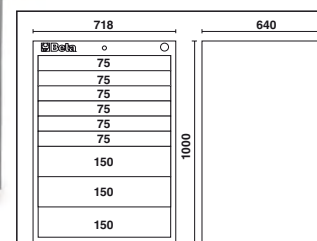

3500/P-M

peremes munkalap a C35 szerszámszekrényhez

3500/P-M 700x600 mm Ft 136.200 1 035000505

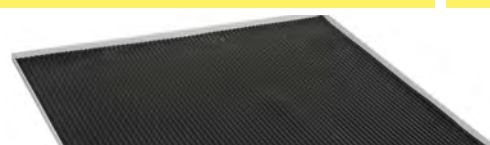

C37 SZERSZÁMKOCSI

PUHA SAROKVÉDŐ ELEMOK (A SÉRÜLÉSMENTES ÜTKÖZÉS ÉRDEKÉBEN)

- Teleszkópos, csapágyazott fiókok
- Többfunkciós rendkívül ellenálló munkalap
- Alumínium gyorskioldó rendszer a fiók teljes hosszában történő nyitási lehetőséggel
- Szerelékartó tálcák és csavarhúzóok elhelyezésére szolgáló furatok
- Négy Ø 125 mm kerék: 2 rögzített és 2 forgó kerék (egy kerék fékezhető)
- Statikus terhelhetőség: 1000 kg
- Sarokvédő elemek a szerszámkocsi teljes magasságában, hogy nekiütözés esetén elkerülhető legyen a műhelyben tartózkodó jármű sérülése.
- A fiókok habgumival bélelték
- Központi biztonsági zár elöl
- Több helyzetbe állítható beépített oldalsó palacktartó és papírtekerstartó

Választható modellek:

- C37/6 (6 fiókos)
- C37/7 (7 fiókos)
- C37/8 (8 fiókos)
- C37A/7 (7 fiókos szerszámkocsi borulásgátló rendszerrel)

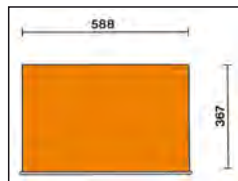

Választható színek:

O	RAL 2011
G	RAL 7016
R	RAL 3000

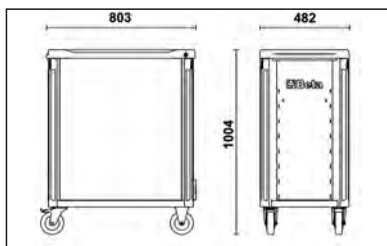

Választható tartozékok:

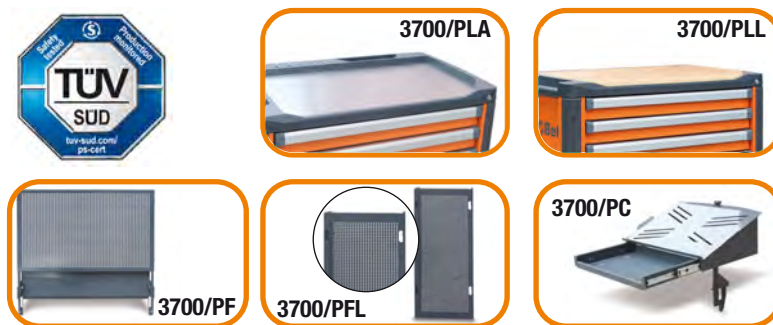

C37/7

7 fiókos szerszámkocsi

Fő jellemzők:

- 7 fiók (588x367 mm), teleszkópos, csapágyazott:
- 5 fiók 75 mm magas
- 1 fiók 150 mm magas
- 1 fiók 225 mm magas

71 kg

1000 kg



C37/7-O



C37/7-G



C37/7-R



	Ft	📦	📄
C37/7-O	486.000	1	037000071
C37/7-G	486.000	1	037000072
C37/7-R	486.000	1	037000073

h	max
75 mm	30 kg
150 mm	35 kg
225 mm	35 kg

C37/6

6 fiókos szerszámkocsi

Fő jellemzők:

6 fiók (588x367 mm), teleszkópos, csapágyazott:

4 fiók 75 mm magas

1 fiók 150 mm magas

1 fiók 305 mm magas

69 kg

	Ft	📦	🏠
C37/6-O	472.900	1	037000061
C37/6-G	472.900	1	037000062
C37/6-R	472.900	1	037000063



C37/6-G



C37/6-R



h	max
75 mm	30 kg
150 mm	35 kg
305 mm	40 kg



C37/8

8 fiókos szerszámkocsi

Fő jellemzők:

8 fiók (588x367 mm), teleszkópos, csapágyazott:

6 fiók 75 mm magas

2 fiók 150 mm magas

73 kg

	Ft	📦	🏠
C37/8-O	508.500	1	037000081
C37/8-G	508.500	1	037000082
C37/8-R	508.500	1	037000083



C37/8-G



C37/8-R



h	max
75 mm	30 kg



C37A/7

7 fiókos szerszámkocsi
borulásgátló rendszerrel

Fő jellemzők:

• 7 fiók (588x367 mm), teleszkópos, csapágyazott:

5 fiók 75 mm magas

1 fiók 150 mm magas

1 fiók 225 mm magas

71 kg

	Ft	📦	🏠
C37A/7-O	521.200	1	037000271
C37A/7-G	521.200	1	037000272
C37A/7-R	521.200	1	037000273



C37A/7-G



C37A/7-R



h	max
75 mm	30 kg
150 mm	35 kg
225 mm	35 kg



3700/PLA

rozsdamentes acél munkalap a C37 fiókos szerszámkocsihoz

📦 2,8 kg

3700/PLA Ft 29.900 1 037000100



3700/PLL

fa munkalap a C27 szerszámkocsihoz

Furatokkal a satu rögzítéséhez (1599P/100, a satut külön kell megrendelni)

📦 3,9 kg

3700/PLL Ft 36.700 1 037000101



672x396x28 mm

3700/PF

perforált panel konzollal a C37 fiókos szerszámkocsihoz

📦 3,2 kg

3700/PF Ft 29.200 1 037000102



626
80
650



3700/PFL

perforált oldalpanel a C37 fiókos szerszámkocsihoz

📦 1,9 kg

3700/PFL Ft 16.150 1 037000104



754
321



3700/PC

számítógép konzol a C37 fiókos szerszámkocsihoz

📦 3,1 kg

3700/PC Ft 40.100 1 037000103

303
309
418



C38

11 fiókos szerszámkocsi

Fő jellegzetességek:

- 11 teleszkópos csapágyazott fiók
- 1 fiók 937x410x122 mm
- 3 fiók 570x410x74 mm
- 2 fiók 570x410x153 mm
- 3 fiók 313x410x74 mm
- 2 fiók 313x410x153 mm
- a fiókok alját habosított gumilap borítja
- statikus terhelhetőség: 1200 kg
- 4 kerék Ø 125 mm
- 2 fix és 2 forgó (mindkettő fékes)
- központi zár
- lemez munkalap gumiborítással
- 2499PC papírtercstartó és 2499PF flakontartó felszerelhető

114 kg

	Ft		
C38-O	758.600	1	038000001
C38-G	758.600	1	038000003
C38-R	758.600	1	038000002



C38-G

C38-R

C38-O



h	max
74 mm	25 kg
153 mm	30 kg

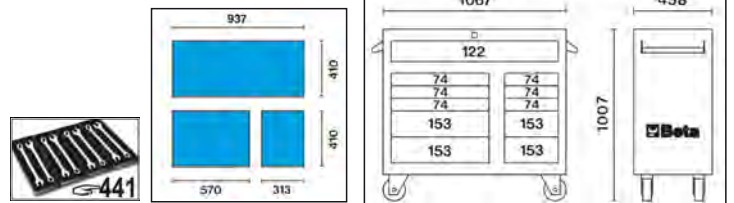

C38L

7 fiókos oldalszekrény

Fő jellemzők:

- 7 teleszkópos, csapágyazott fiók (410x313 mm):
- 5 fiók, 74 mm magas 2 fiók, 153 mm magas.
- A fiókok habgumival béleltek.
- Központi biztonsági zár elől.
- Csúszásmentes alumínium munkalap.
- A C38 szerszámkocsi mindkét oldalára helyezhető.

45 kg

	Ft		
C38L-O	365.400	1	038000081
C38L-G	365.400	1	038000083
C38L-R	365.400	1	038000082

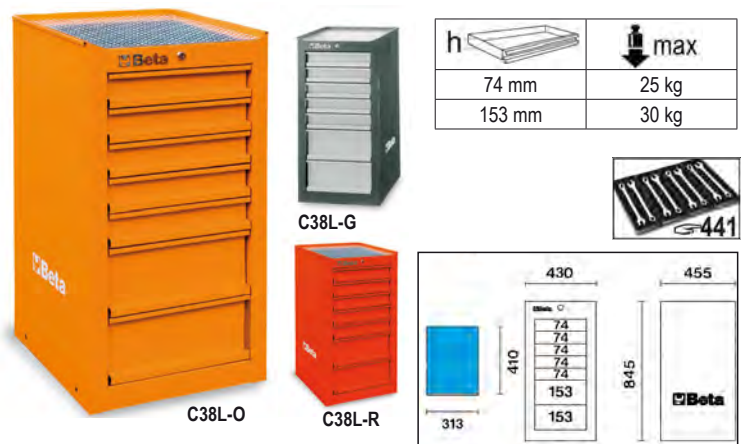

C38L-G

C38L-R

h	max
74 mm	25 kg
153 mm	30 kg

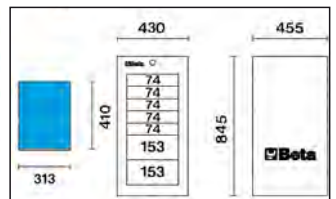

C38LA

oldalszekrény ajtóval és
belső szerszámtartó polccal

Fő jellemzők:

- Zár elől.
- Állítható magasságú belső polc.
- Az ajtószármányban irrattartó.
- Csúszásmentes alumínium munkalap.
- A C38 szerszámkocsi mindkét oldalára helyezhető.

18 kg

	Ft		
C38LA O	140.400	1	038000071
C38LA G	140.400	1	038000073
C38LA R	140.400	1	038000072



C38LA-G

C38LA-R

C38LA-O

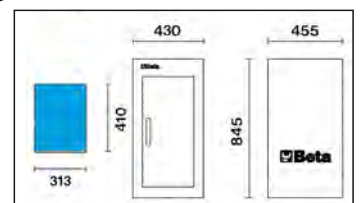

C38C

33 fiókos szerszámkocsi

- 1 db C38 szerszámkocsi
- 2 oldalán C38L szerszámszekrény
- 1 db Top C38T szerszámláda

268 kg



C38C-O



C38C-G



C38C-R



h	max
74 mm	25 kg
153 mm	30 kg

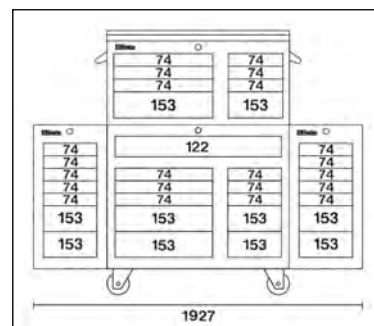
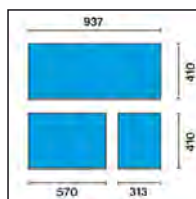

	Ft		
C38C-O	1.965.100	1	038000201
C38C-G	1.965.100	1	038000203
C38C-R	1.965.100	1	038000202

C38T

top 8 fiókos szerszámláda
szerszámrekeszsel

Fő jellemzők:

- 8 teleszkópos, csapágyazott fiók:
- 3 fiók 570x410x74 mm
- 1 fiók 570x410x153 mm
- 3 fiók 313x410x74 mm
- 1 fiók 313x410x153 mm
- Szerszámtartó rekesz.
- A fiókok habgumival bélelték.
- Központi biztonsági zár elől.
- C38 szerszámkocsira helyezhető.

64 kg



C38T-O



C38T-G



C38T-R

h	max
74 mm	25 kg
153 mm	30 kg

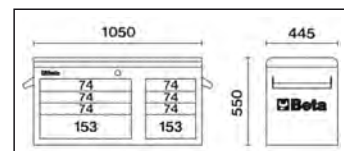
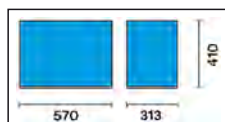

	Ft		
C38T-O	475.700	1	038000091
C38T-G	475.700	1	038000093
C38T-R	475.700	1	038000092

C39 SZERSZÁMKOCSI

A FÜGGŐLEGES ELEMEK ÉS A FIÓKOK ELÜLSŐ RÉSE ALUMÍNÍUM ÖTVÖZETBŐL KÉSZÜLT + TARTÓSSÁG + KÖNNYŰ SÚLY

- Teleszkópos, csapágyazott fiókok
- Hőkezelt munkalap a hordozható C39T szerszámszekrényhez
- Alumínium gyorskioldó rendszer a fiók teljes hosszában történő nyitási lehetőséggel
- Négy Ø 125 mm kerék: 2 rögzített és 2 forgó kerék (egy kerék fékezhető)
- Statikus terhelhetőség: 1200 kg
- A fiókok habgumival bélelték
- Központi biztonsági zár elöl
- Szereléktartó tálcák és csavarhúzóok elhelyezésére szolgáló furatok
- Beépített flakontartók oldalt és a hátsó részen
- Beépített papírtekerstartó

Választható modellek:

- C39/6 (6 fiókos)
- C39/7 (7 fiókos)
- C39/8 (8 fiókos)

Választható színek:

	
O	RAL 2011
G	RAL 7016
R	RAL 3000

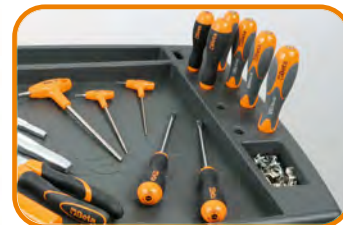
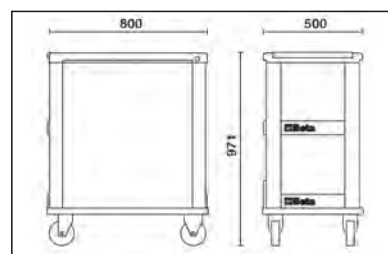
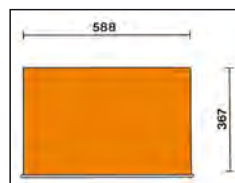

C39/7

7 fiókos szerszámkocsi

Fő jellegzetességek:

- hét teleszkópos, csapágyazott fiók 588x367 mm:
- 5 fiók 70 mm
- 1 fiók 140 mm
- 1 fiók 210 mm

61 kg

1200 kg



h	max
70 mm	30 kg
140 mm	35 kg
210 mm	35 kg



	Ft		
C39-7/O	724.600	1	039000001
C39-7/G	724.600	1	039000002
C39-7/R	724.600	1	039000003

C39/6

6 fiókos szerszámkocsi

Fő jellegzetességek:

- 6 teleszkópos, csapágyazott fiók, 588x367 mm:
- 4 fiók 70 mm
- 1 fiók 140 mm
- 1 fiók 280 mm

59 kg

	Ft	☒	☒
C39-6/O	685.300	1	039000031
C39-6/G	685.300	1	039000032
C39-6/R	685.300	1	039000033



1200 kg

C39-6/O



C39-6/G



C39-6/R



h	max
70 mm	30 kg
140 mm	35 kg
280 mm	40 kg



C39/8

8 fiókos szerszámkocsi

Fő jellegzetességek:

- 8 teleszkópos, csapágyazott fiók, 588x367 mm:
- 6 fiók 70 mm
- 2 fiók 140 mm

64 kg

	Ft	☒	☒
C39-8/O	772.600	1	039000041
C39-8/G	772.600	1	039000042
C39-8/R	772.600	1	039000043



1200 kg

C39-8/O



C39-8/G



C39-8/R



h	max
70 mm	30 kg



C39T

4 fiókos szerszámláda

Fő jellegzetességek:

- 4 teleszkópos csapágyazott fiók, 588x257 mm
- 4 fiók 70 mm
- Elöl központi biztonsági zár.
- Fiók teherbírása: 15 kg
- Merevítő és a fiók előlap alumíniumból.

29 kg

	Ft	☒	☒
C39T-O	463.100	1	039000101
C39T-G	463.100	1	039000102
C39T-R	463.100	1	039000103



C39T-O



C39T-R

C39T-G



29 kg

h	max
70 mm	30 kg

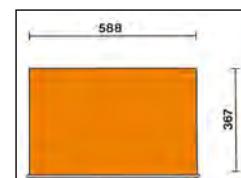
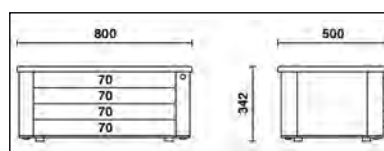

2400-COVER RSC24

nylon takaró a RSC24/RSC24A - C39 fiókos szerszámkocsikhoz

2400-COVER RSC24 Ft 9.540 1 024000910



2400-COVER RSC24AXL

nylon takaró a RSC24A-XL, RSC24L, RSC24L-CAB fiókos szerszámkocsikhoz

2400-COVER RSC24AXL Ft 12.900 1 024000930



3700-COVER C37

Nylon takaró a C37 fiókos szerszámkocsikhoz

3700-COVER C37 Ft 13.200 1 037000930

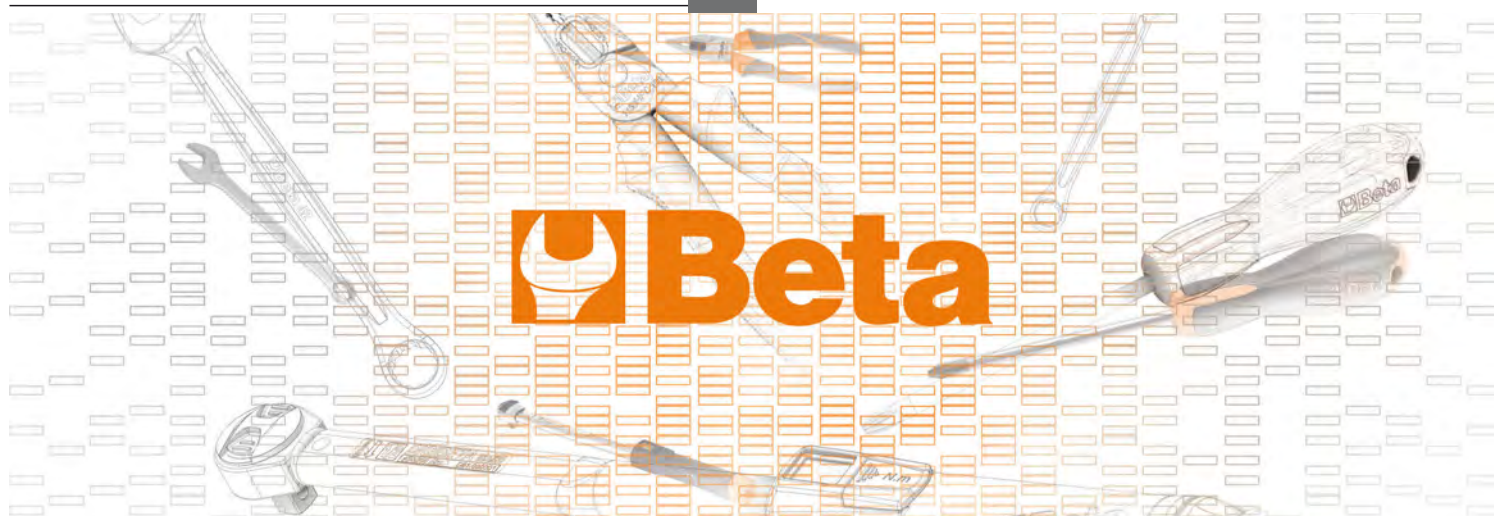

C39SM

Speciális szerszámkocsi Racing SM

Műszaki jellemzők:

- Multiplex munkalap
- 4 kerék Ø 125 mm
- 2 fix és 2 forgó (egyik fékes)
- Statikus teherbírás: 1200 kg

Modul 7 fiókkal

teleszkópos, csapágyazott fiók, 588x367 mm:

- 6 fiók 70 mm
- 1 fiók 240 mm
- A fiókok habgumival bélelték
- Központi zár elől biztonsági zárral
- A fiókokat egyszerre nyitó zárrendszer
- A fiókok előlapja alumínium

Szerviz-modul

- Beépített szeméttartó
- Papírtekerstartó • Egy nagy rakodótér 420x305x270 mm

125 kg

		Ft	1	039390001
C39SM-O	RAL 2011	1.172.900	1	039390001
C39SM-G	RAL 7016	1.172.900	1	039390002
C39SM-R	RAL 3000	1.172.900	1	039390003



C39SM-O



h	max
70 mm	30 kg
240 mm	40 kg

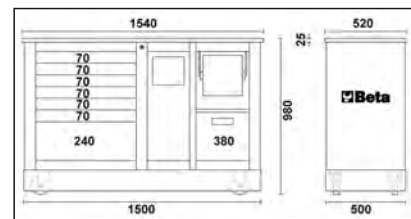
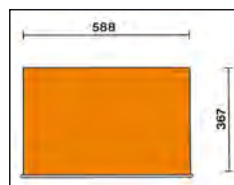

C39MD

Speciális szerszámkocsi Racing MD

Műszaki jellemzők:

- Multiplex munkalap
- 4 kerék Ø 125 mm
- 2 fix és 2 forgó (egyik fékes)
- Statikus teherbírás: 1200 kg

Modul 7 fiókkal

teleszkópos, csapágyazott, 588x367 mm:

- 6 fiók 70 mm
- 1 fiók 240 mm
- A fiókok habgumival bélelték
- Központi zár elől biztonsági zárral
- A fiókokat egyszerre nyitó zárrendszer
- A fiókok előlapja alumínium

Modul 2 fiókkal

teleszkópos, csapágyazott, 588x367x270 mm és 588x367x380 mm

- A fiókok habgumival bélelték
- Központi zár elől biztonsági zárral
- A fiókokat egyszerre nyitó zárrendszer
- A fiókok előlapja alumínium

123 kg

		Ft	1	039390101
C39MD-O	RAL 2011	1.207.900	1	039390101
C39MD-G	RAL 7016	1.207.900	1	039390102
C39MD-R	RAL 3000	1.207.900	1	039390103

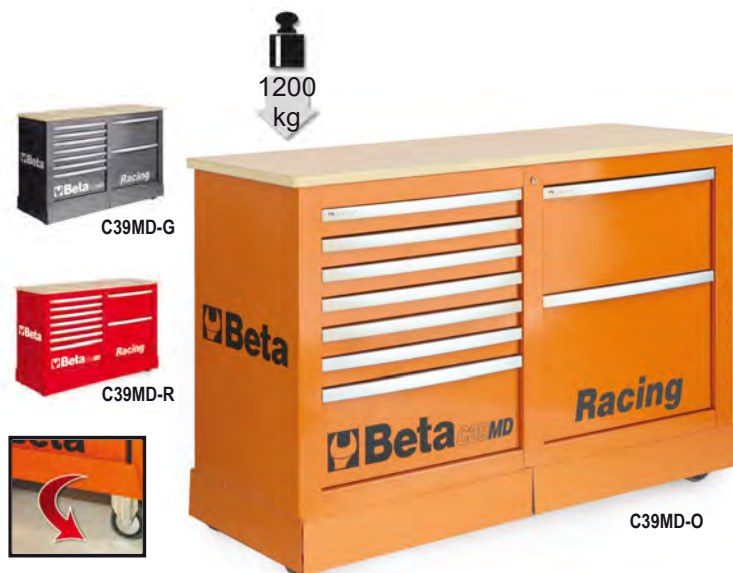

C39MD-G



C39MD-R



h	max
70 mm	30 kg
240 mm	40 kg

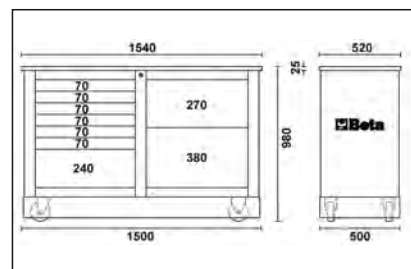
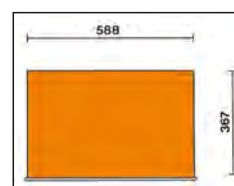

C41S

Két modulós szerszámkocsi

Fő jellegzetességek:

- acéllemezről készült és műanyagborítású: robusztus, könnyű
- 2 elválasztható modul:
 - 1 modul kisláda
 - 1 modul két fiók (1 db 95 mm és 1 db 295 mm magas fiók)
- nagy kerekek (átmérő 160 mm)
- lépcsőn is könnyen szállítható
- az oldalsó központi zár az alsó modul 2 fiókját zárja
- teleszkópos, csapágyazott fiókok dupla zárókapoccsal
- alumínium teleszkópos fogantyú
- a kisládban beépített műanyagrekeszek kis tárgyak elhelyezésére

Javasolt készletek: 5940/SBK és 5915VU/5

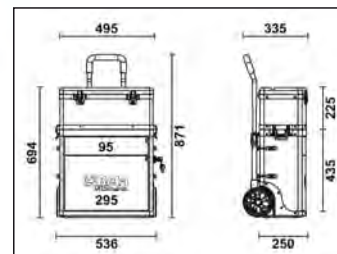
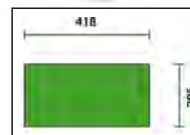

16 kg

C41S	Ft	1	041000001
	220.000		

C41H

Két modulós szerszámkocsi

Fő jellegzetességek:

- acéllemezről készült és műanyagborítású: robusztus, könnyű
- 2 elválasztható modul:
 - 1 felső modul: kisláda
 - 1 alsó modul: 1 db 295 mm magas fiók 1 db 66 mm kihúzható műanyagrekesz 2 db 95 mm magas fiók
- nagy kerekek (átmérő 160 mm)
- lépcsőn is könnyen szállítható
- az oldalsó központi zár az alsó modul 2 fiókját zárja
- teleszkópos, csapágyazott fiókok dupla zárókapoccsal
- alumínium teleszkópos fogantyú
- a kisládban beépített műanyagrekeszek kis tárgyak elhelyezésére

Javasolt készletek: 5941VU/M, 5940/SBK és 5915VU/5

* Kérésre rendelhető színek



C41H-O



C41H-W

C41H-Y

C41H-R

C41H-V

C41H-B

C41H-G

C41H-N

21 kg

		Ft	1	041000002
C41H-O	RAL 2011	226.100	1	041000002
C41H-N	RAL 9005	226.100	1	041000005
C41H-B	RAL 5002	226.100	1	041000006
C41H-R	RAL 3000	226.100	1	041000008
C41H-G	RAL 7016	226.100	1	041000010
C41H-Y	RAL 1023	226.100	1	041000012
C41H-W	RAL 9016	226.100	1	041000021
C41H-V	RAL 6016	226.100	1	041000024

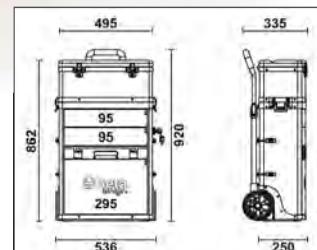
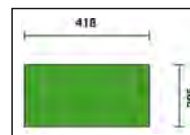

C41H/CE

Kivehető műanyag rekesz kis tárgyak elhelyezésére

1,3 kg

C41H/CE	Ft	1	041000916
	14.000		



C42H

Szerszámkocsi 3 modulal

Fő jellegzetességek:

- Lemezből készült és műanyagborítású:

- robosztus és könnyű

- 3 elválasztható modul:

- 1 felső modul, magasság: 220 mm

- 1 középső modul, magasság: 180 mm

- 1 alsó modul kerékkel, magasság: 330 mm

- Nagy átmérőjű kerekek (ø 160 mm)

- 3 pozícióba állítható teleszkópos fogantyú

- Gyorsan szétválasztható modulok: praktikus és jól kezelhető fogantyú

- a különböző modulokon

- Felső modul belső rekeszel és 3 fedélbe épített rekesz kis tárgyak elhelyezésére

- 2 modulal is használható

Javasolt készletek: 5940/SBK és 5915VU/5

14 kg

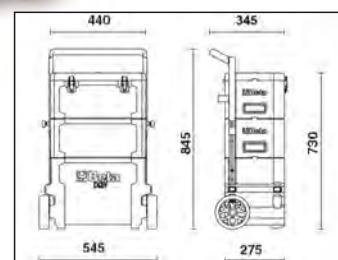

C42H

Ft 162.500 1 042000002

Beta

CX49-G

többfunkciós szerszámkocsi

mobil munkaállásként használható
diagnosztikai eszközök, laptopok, teszterek és akkumulátortöltők számára.

JELLEMZŐK

- Festett fémlemez szerkezet: maximális stabilitás és szilárdság
- Ergonomikus fogantyú
- Kétszintes felső rakodópól
- Kihúzható fiók minibillentyűzethez
- 2 állítható helyzetű középső polc és 1 rögzített alsó polc
- 4 hasznos oldalsó műanyag kábeldob
- 2 praktikus oldaldoboz
- 2 rögzített hátsó kerék, Ø 160 mm
- 2 elforgatható első kerék, Ø 100 mm (egyikük fékkel)
- Súly: 36 kg

CX49 Ft 296.300 1 049000102

1099 mm
460 mm
435 mm



CA49-G

többfunkciós szerszámkocsi ajtóval

mobil munkaállásként használható
diagnosztikai eszközök, laptopok, teszterek és akkumulátortöltők számára.

JELLEMZŐK

- Festett fémlemez szerkezet: maximális stabilitás és szilárdság
- Ergonomikus fogantyú
- Kétszintes felső rakodópól
- Kihúzható fiók minibillentyűzethez
- 1 állítható helyzetű polc és 1 rögzített polc és záróajtó
- 4 hasznos oldalsó műanyag kábeldob
- 1 praktikus oldaldoboz
- 2 rögzített hátsó kerék, Ø 160 mm
- 2 elforgatható első kerék, Ø 100 mm (egyikük fékkel)
- Súly: 36,5 kg

CA49 G Ft 353.000 1 049000112



1099 mm
460 mm
435 mm

4900-COVER C49

nejlon takaró a C49 többfunkciós szerszámkocsihoz

4900-COVER C49 Ft 14.100 1 049000930



C48M

elektromos, platós kézikocsi

Kompakt méretének és sokoldalú felhasználásának köszönhetően a C48M kézikocsi ideális megoldás nehéz terhek (dobozok, tartályok, nagyméretű tárgyak, berendezések) biztonságos szállítására nehezen és hagyományos targoncával nem megközelíthető helyeken.

A motoros rásegítésnek köszönhetően csökken a kézi tehermozgatás jelentette veszélyek, pl. mozgásszervi betegségek kockázata.

24V - 400W motorral, 2x12V 33Ah akkumulátorral és Curtis vezérlőkártyával felszerelt kézikocsi.

Csúszásmentes gumival borított masszív acélból készült plató. A peremen elhelyezkedő csőpanelek meggátolják a szállított tárgyak leesését.

A panelek nagyobb darabok szállítására esetén eltávolíthatók.

A vezérlőpanel felszereltsége:

- indítókulcs
- sebességszabályozó
- oldalsó "pillangó" kapcsoló az irányításhoz
- tolatásjelző csipogó hangjelzés
- akkumulátor töltésjelző
- elektromos fék megszakító gomb
- vészleállító gomb

2 pneumatikus hajtókerék (Ø 260 mm), 2 gumi forgókerék (Ø 150 mm), mágnesfék és differenciálmű.

Külső akkumulátortöltővel szállítva, 220V/50Hz - V/A 24/12

FUNKCIONÁLIS SPECIFIKÁCIÓK

Teherbírás: 400 kg

Sebesség: 4-6 km/h (szabályozható)

Akkumulátor üzemidő: 4 óra

Teljes terheléssel megengedett legnagyobb emelkedő: 6%

100 kg terheléssel megengedett legnagyobb emelkedő: 18%

Biztonsági berendezések:

Elektronikus fék

Hangjelző

Zúzódásvédő

Akkumulátor töltésjelző

Curtis vezérlőkártya

MŰSZAKI ADATOK

Külső méret: 1280x630x1100 mm

Plató hasznos rakfelülete panelekkel: 1180x580 mm

Plató hasznos rakfelülete panelek nélkül: 1260x620 mm

Plató magassága: 320 mm

Akkumulátortartó magassága: 65 mm

Tömeg akkumulátorral: 140 kg

140 kg

C48M

Ft 1.005.200 1 048000230

Beta
BRUTUS

CE

400
kg



1100
630
1280



C48P

összecsukható szerszámkocsi

Fő jellemzők:

- Erősített polipropilénből (PP) készült rakodófelület csúszásgátló bevonattal és TPV betétekkel védett sarkakkal
- Betolható fogantyú a gyors, kompakt tárolásért
- Négy, nyomot nem hagyó kerék, Ø 125 mm: 2 rögzített és 2 fékezhető forgókerék
- Maximális teherbírás: 300 kg.
- Rakodófelület munkaszélessége: 705 mm
- Rakodófelület mélysége: 480 mm
- Rakodófelület magassága: 200 mm



300
kg



11 kg

C48P

Ft 86.000 1 048000030

C51

Kisegítő szerszámkocsi

- 3 csúszásmentes bordás gumival borított munkalap
- Ergonómikus fogantyú
- Két állásban rögzíthető középső munkalap
- 4 kerék Ø 100 mm: 2 fix és 2 forgó kerék (az egyik fékes)
- Maximális terhelhetőség: 240 kg

21 kg

		Ft	1	051000001
C51 O	RAL 2011	112.600	1	051000001
C51 G	RAL 7016	112.600	1	051000002
C51 R	RAL 3000	112.600	1	051000003



RSC51

3 fiókos szerszámkocsi

Fő jellemzők:

- ABS erősítésű, stabil, robusztus munkalap
- Univerzális munkalap legurulásgátló peremmel és nyolc csavarhúzó tartó lyukkal
- 3 teleszkópos, csapágyazott fiók (588x367 mm), 70 mm magas
- A fiókok habgumival bélelték
- Mindegyik fiókba 4 EVA habszivacs vagy ABS hőformált tálcá helyezhető
- Központi biztonsági zár elől
- Praktikus oldalsó csavarhúzó tartó
- Két oldalsó beépített spray flakon tartó
- Nagy alsó polc olaj- és benzinálló gumi borítással
- 4 kerék, Ø 125 mm: 2 rögzített kerék és 2 forgókerék (egy kerék fékezhető)

- Statikus terhelhetőség: 400 kg
- Egyes fiókok teherbírása: 15 kg, egyenletesen elosztva

A következő kiegészítőkkel bővíthető:

- 2400 RSC24/PL fa munkalap
- 2400 RSC24/PF perforált szerszámtartó panel
- 2400 RSC24/SPC számítógép konzol
- 2400 RSC24/MP lehajtható polc
- 2400 RSC24/PC-A papirtekerstartó

38 kg



		Ft	1	051000300
RSC51-FO	RAL 2011	239.500	1	051000300
RSC51-R	RAL 3000	239.500	1	051000303
RSC51-A	RAL 7016	239.500	1	051000307

2400 RSC24/MP

lehajtható polc az RSC24 - RSC24A - RSC51 modellhez

- Kiegészítő munkalapként használható
- Munkalap méretei: 390x440 mm, olaj- és benzinálló gumi borítással védve
- Terhelési kapacitás: 20 kg

3,4 kg

		Ft	1	024004900
2400 RSC24/MP		30.000	1	024004900

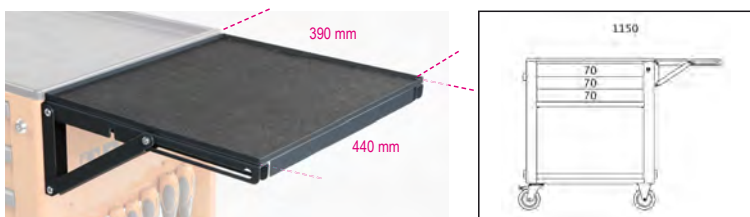

CP51

nagyszilárdságú szerszámkocsi

- 2 gumiszőnyeggel fedett rakodópól
- Ergonomikus fogantyú
- Négy 125 Ø nagyszilárdságú kerék
- 2 rögzített, 2 elfordítható fékkel
- Statikus terhelhetőség: 750 kg. (2 polcon elosztva)

37 kg

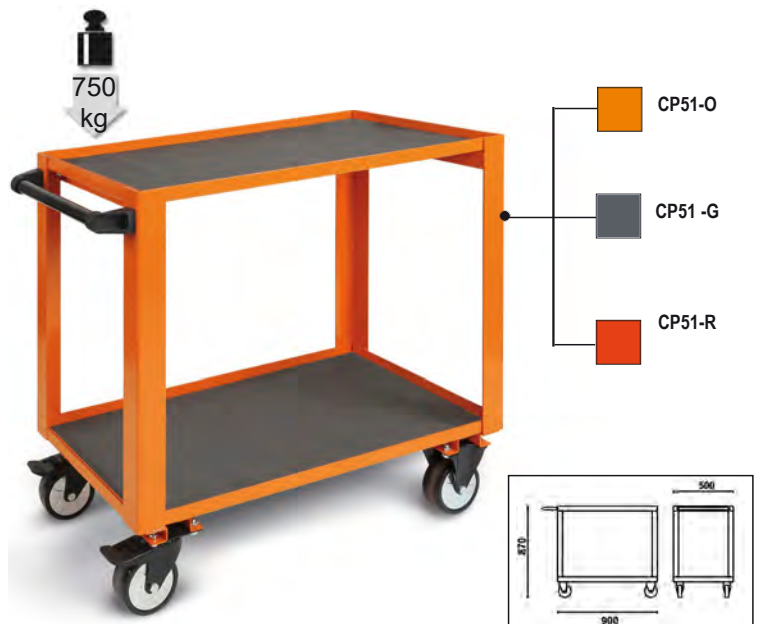

		Ft		
CP51 O	RAL 2011	150.100	1	051000501
CP51 G	RAL 7016	150.100	1	051000502
CP51 R	RAL 3000	150.100	1	051000503

CB52

sebességváltó/erőátvitel tartókocsi
folyadékgyűjtővel

A döntött sík és a lefolyólyukak lehetővé teszik a folyadékok gyűjtését közvetlenül a gyűjtőtálba

A következőket tartalmazza:

- 4 elforduló kerék, kettő fékkel
- szerszámfiók
- 7 literes kihúzható folyadékgyűjtő tálca
- 2 polc

Méreték: 1200x640x870 mm

Súly: 60 Kg

60 kg



		Ft		
CB52		332.300	1	052000201

 **Beta**

C56P O

összecsukható munkapad

Kompakt és könnyen szállítható.
Mindkét oldalán használható 30 mm vastag 800x500mm méretű MDF és horganyzott lemez munkalap.
Gumival védett fogantyú a hatékony szállítás érdekében.
Csúszásgátló burkolattal rendelkező lábak.
Statikus terhelhetőség: 250 kg

18,5 kg

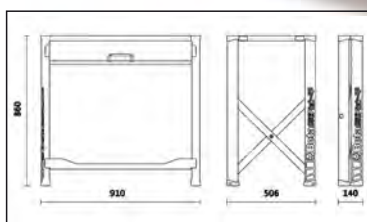

C56P O

Ft 169.800 1 056000011

C56PL O

összecsukható munkapad, könnyű kivitel

Könnyű, kompakt, könnyen szállítható.
Horganyzott lemez munkalap (800x500mm), munkaoldalán olaj- és benzinálló gumiborítással.
Gumival védett fogantyú a hatékony szállítás érdekében.
Csúszásgátló burkolattal rendelkező lábak.
Statikus terhelhetőség: 200 kg

18,5 kg

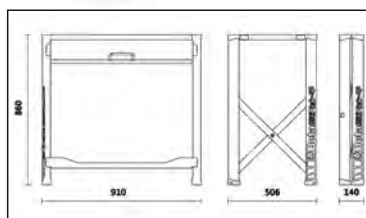

C56PL O

Ft 156.700 1 056000021

C54S

Cargo szerszámszekrények

Ezeknek a szerszámszekrényeknek a tervezése alapos kutatás alapján történt, és ezért a végfelhasználók számára pontos, kényelmes és ésszerű megoldást kínálnak.

Az ajtókhöz illeszkedő két perforált lemezajtó nyitható, ezáltal további tárolóterezhez jutunk.

Fő jellegzetességek:

- 1 fiók egyszerű szerszámelrendezés a felhasználó igényei szerint
- könnyen falra szerelhető két horony segítségével, melyek a szerszámszekrény hátulján található, vagy két csavarral felerősíthető a C50 Team szekrénytartó kocsi
- biztonsági zár a fiók és az ajtók bezárásához
- a VI és VG modelleknek eltérő szerszámtartó készlete van
- hőformált tálca 1/2"-os dugókulcshoz és tartozékhoz, üres

37 kg



C54S-G



C54S-R



C54S-O



519

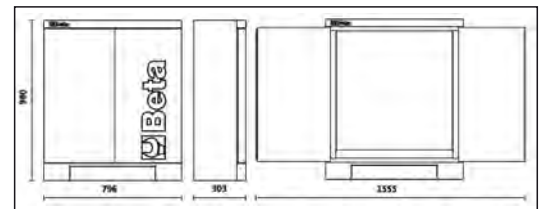

		Ft	☒	☒
C54S-O	RAL 2011	278.400	1	054000301
C54S-G	RAL 7016	278.400	1	054000302
C54S-R	RAL 3000	278.400	1	054000303

Beta

C57SA

MasterCargo munkapad

• Ez a modell szerszámtartó fallal (C57P) és egy fiókos blokkal készült.

A fiókos blokk:

5 fiók teleszkópos és csapágyazott 588x367 mm 3 fiók 90 mm

1 fiók 180 mm

1 fiók 280 mm.

A fiókokban hőformált tálcák

Központi zár

Szerszámtartó fal furattal, hogy

a falra is lehessen szerelni.

Alumíniumredőny, függőlegesen

manőverezhető, biztonsági zárral.

Három kivethető perforált szerszámtartó lemez

Multiplex munkalap,

laminált rétegelt, három furattal,

1599F/150 satu rögzítéséhez

(külön kell megrendelni).



C57SA-O

205 kg



C57SA-G



C57SA-R



519

h	max
90 mm	30 kg
180 mm	40 kg
280 mm	40 kg

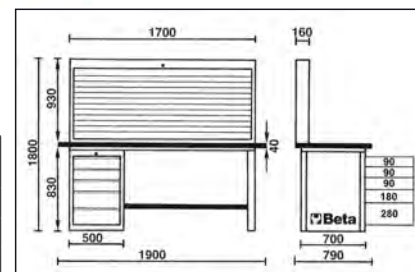

		Ft		
C57SA-O	RAL 2011	1.677.100	1	057001005
C57SA-G	RAL 7016	1.677.100	1	057001205
C57SA-R	RAL 3000	1.677.100	1	057001405

C57SD

MasterCargo munkapad

• Ez a modell egy fiókos blokkal készült

A fiókos blokk:

5 fiók teleszkópos és csapágyazott 588x367 mm 3 fiók 90 mm

1 fiók 180 mm

1 fiók 280 mm.

A fiókokban hőformált tálcák

Központi zár

Multiplex munkalap,

laminált rétegelt, három furattal,

1599F/150 satu rögzítéséhez

(külön kell megrendelni).



C57SD-O



519

h	max
90 mm	30 kg
180 mm	40 kg
280 mm	40 kg



C57SD-G



C57SD-R

158 kg

		Ft		
C57SD-O	RAL 2011	1.102.500	1	057001004
C57SD-G	RAL 7016	1.102.500	1	057001204
C57SD-R	RAL 3000	1.102.500	1	057001404

C57SB

MasterCargo munkapad

• Ez a modell szerszámtartó fallal (C57P) és két fiókos blokkal készült.

A fiókos blokk:

5 fiók teleszkópos és csapágyazott 588x367 mm 3 fiók 90 mm

1 fiók 180 mm

1 fiók 280 mm.

A fiókokban hőformált tálcák

Központi zár

Szerszámtartó fal furattal, hogy

a falra is lehessen szerelni.

Alumíniumredőny, függőlegesen

manőverezhető, biztonsági zárral.

Három kivehető perforált szerszámtartó lemez

Multiplex munkalap,

laminált rétegelt, három furattal,

1599F/150 satu rögzítéséhez

(külön kell megrendelni).



1800
kg

C57S/B-O

243 kg



C57S/B-G



C57S/B-R



h	max
90 mm	30 kg
180 mm	40 kg
280 mm	40 kg

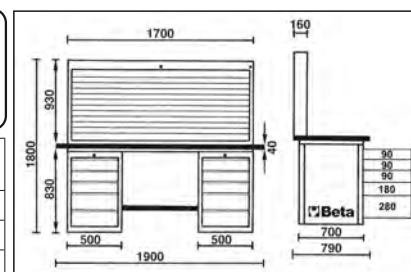

		Ft		
C57S/B-O	RAL 2011	2.058.700	1	057001006
C57S/B-G	RAL 7016	2.058.700	1	057001206
C57S/B-R	RAL 3000	2.058.700	1	057001406

C57SC

MasterCargo munkapad

• Ez a modell két fiókos blokkal készült

A fiókos blokk:

5 fiók teleszkópos és csapágyazott 588x367 mm 3 fiók 90 mm

1 fiók 180 mm

1 fiók 280 mm.

A fiókokban hőformált tálcák

Központi zár

Multiplex munkalap,

laminált rétegelt, három furattal,

1599F/150 satu rögzítéséhez

(külön kell megrendelni).



1800
kg

C57S/C-O



h	max
90 mm	30 kg
180 mm	40 kg
280 mm	40 kg



C57S/C-G



C57S/C-R

196 kg

		Ft		
C57S/C-O	RAL 2011	1.484.100	1	057001003
C57S/C-G	RAL 7016	1.484.100	1	057001203
C57S/C-R	RAL 3000	1.484.100	1	057001403

C57SP

Szerszámtartó fal

Szerszámtartó fal hátulján két furattal, hogy falra is lehessen szerelni. Biztonsági zárral ellátott alumínium redőny, három kivehető perforált szerszámtartó lemez

46 kg

		Ft		
C57SP-O	RAL 2011	574.600	1	057001020
C57SP-G	RAL 7016	574.600	1	057001220
C57SP-R	RAL 3000	574.600	1	057001420



C57SP G

C57SP R

5700LAMP

MasterCargo munkapad-lámpa

- erőteljes fémlemezkeret, amelyet a munkapad lapjához kell lámpatartó 1120 Lumen LED-es szalaggal, 4000K, 14W feszültség: 230V vezeték nélkül szállítva

9 kg

	Ft		
5700LAMP	131.100	1	057000005



C58P

szerszámtartó fal

- Festett alumínium redőny biztonsági zárral.
- Két kivehető lyukacsos szerszámtartó panel.

46,8 kg

		Ft		
C58P-O	RAL 2011	431.400	1	058000221
C58P-G	RAL 7016	431.400	1	058000222
C58P-R	RAL 3000	431.400	1	058000223



C58P-G



C58P-R



C58P-O



PV

Szerszámtartó fal

	LxA mm	Ft		
PV1	1000x920 10,2	74.550	1	088880010
PV1,5	1500x920 14,2	99.350	1	088880015

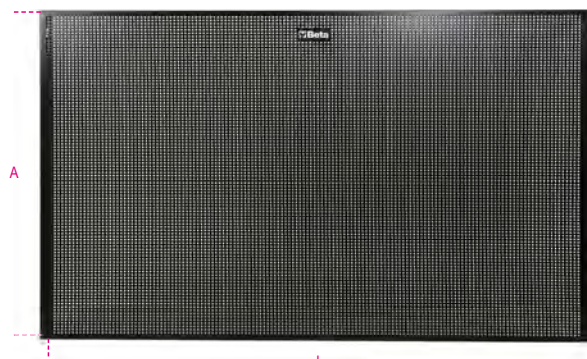

C56W

fa munkalapos munkapad

- Többretegű fa munkalap furatokkal a satu rögzítéséhez (1599F/125, külön kell megrendelni).
- Acélszerkezet 6 tartólábbal
- Statikus terhelhetőség: 1.200 kg
- Hozzárendelhető a munkapadhoz nem rögzíthető C57P falhoz.
- Két fiók, zárral.
- Előkészítve a padlóhoz történő rögzítéshez.

📦 86 kg



		Ft	📦	🖨️
C56W-O	RAL 2011	400.700	1	056000251
C56W-G	RAL 7016	400.700	1	056000252
C56W-R	RAL 3000	400.700	1	056000253

C56B

fa munkalapos munkapad

Fő jellemzők:

- Többretegű fa munkalap furatokkal a satu rögzítéséhez (1599F/125, külön kell megrendelni).
- Acélszerkezet 4 tartólábbal.
- Statikus terhelhetőség: 800 kg.
- Alul tároló rekesz.
- Padlóhoz rögzíthető.

📦 54,5 kg



		Ft	📦	🖨️
C56B-O	RAL 2011	286.700	1	056000401
C56B-G	RAL 7016	286.700	1	056000402
C56B-R	RAL 3000	286.700	1	056000403

C56

Munkapad

- Fém munkalap peremmel
- 6 lábú acélváz
- Statikai terhelés: 1.200 Kg
- C57P szerszámfallal kombinálható, munkaasztalra nem rögzíthető.
- Két fiók, zárral.
- Padlóhoz rögzíthető.

📦 82 kg



		Ft	📦	🖨️
C56-O	RAL 2011	333.800	1	056000201
C56-G	RAL 7016	333.800	1	056000202
C56-R	RAL 3000	333.800	1	056000203

C56M

Munkapad

- fém munkalap, fele alumínium, fele gumiborítású
- alsó lap színfa
- terhelés: kg.800
- C57P szerszámfallal használható
- 3 fiók zárral

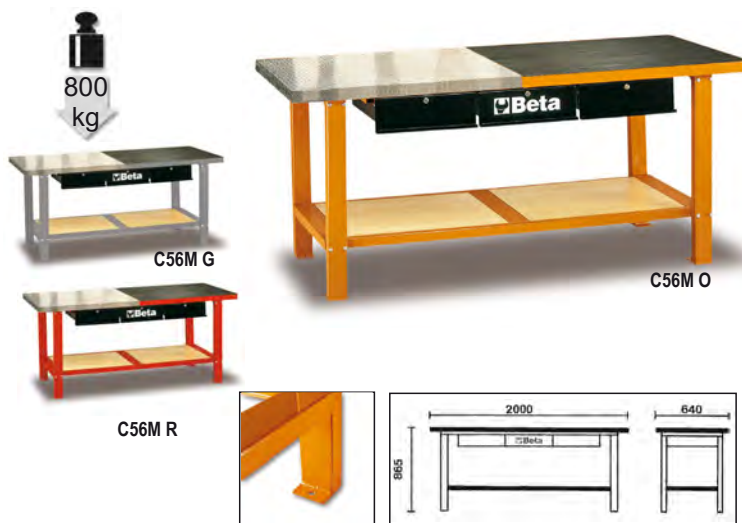

95 kg

		Ft		
C56M O	RAL 2011	489.200	1	056000050
C56M G	RAL 7016	489.200	1	056000053
C56M R	RAL 3000	489.200	1	056000054

C58B

fa munkalapos munkapad

Fő jellemzők:

- Többrétegű fa munkalap furatokkal a satu rögzítéséhez (1599F/125, külön kell megrendelni).
- Acélszerkezet 4 tartólábbal.
- Statikus terhelhetőség: 800 kg.
- Alul tároló rekesz.
- Padlóhoz rögzíthető.

44 kg



		Ft		
C58B-O	RAL 2011	260.800	1	058000401
C58B-G	RAL 7016	260.800	1	058000402
C58B-R	RAL 3000	260.800	1	058000403

C58M

munkapad

- Fém munkalap, csúszásmentes, levehető gumiborítással.
- Polc: kemény fából.
- Statikus terhelhetőség: 800 kg.
- A C58P szerszámartató fallal kombinálható, munkalapra nem szerelhető fel.
- 2 fiók zárral.
- Padlóhoz rögzíthető.
- C58M/PA alumínium munkalap rászerezhető.

65 kg



		Ft		
C58M-O	RAL 2011	315.000	1	058000300
C58M-G	RAL 7016	315.000	1	058000302
C58M-R	RAL 3000	315.000	1	058000303

C58M/PA

Recézett alumínium munkalap
C58M munkapadhoz

4,5 kg



C58M/PA

Ft 134.600 1 058000350

C59A

"Endurance" munkapad egy 6 fiókos blokkal

Fő jellegzetességek:

- Multiplex-munkalap furatokkal a satu rögzítéséhez 1599F/125 (külön kell megrendelni).
- 6 teleszkópos, csapágyazott fiók 588x367 mm:
4 fiók magasság: 70 mm
1 fiók magasság: 140 mm
1 fiók magasság: 280 mm.
- A fiókok habgumival bélelték.
- Erősített nylon fiókperem.
- Hőformált tálcák elhelyezhetők.
- Elöl központi biztonsági zár.
- Alul tároló rekesz
- 2400 RSC24/PC papírtekerstartó és a 2400 RSC24/PF-flakontartó felszerelhető, külön kell megrendelni.

115 kg



C59A O



C59A A



1500 kg

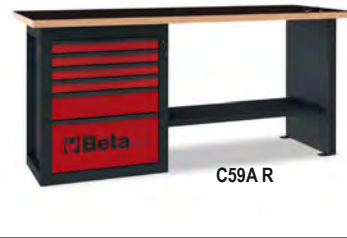

C59A R

h	max
70 mm	25 kg
140 mm	30 kg
280 mm	35 kg

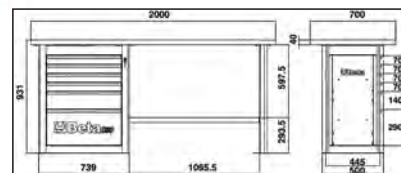

		Ft	1	059000011
C59A-O	RAL 2011	701.300	1	059000011
C59A-A	RAL 7016	701.300	1	059000031
C59A-R	RAL 3000	701.300	1	059000051

Beta

C59B

"Endurance" munkapad két 6 fiókos blokkal

Fő jellegzetességek:

- Multiplex-munkalap furatokkal a satu rögzítéséhez 1599F/125 (külön kell megrendelni).
- 12 fiók, teleszkópos, csapágyazott fiók 588x367 mm:
- 8 fiók magasság: 70 mm
- 2 fiók magasság: 140 mm
- 2 fiók magasság: 280 mm
- A fiókok habgumival bélelték.
- Hőformált tálcák elhelyezhetők.
- Elöl központi biztonsági zár.
- Alul tároló rekesz.
- 2400 RSC24/PC papírtekerstartó és a 2400 RSC24/PF-flakontartó felszerelhető, külön kell megrendelni.

155 kg

		Ft		
C59B-O	RAL 2011	933.800	1	059000012
C59B-R	RAL 3000	933.800	1	059000052
C59B-A	RAL 7016	933.800	1	059000032

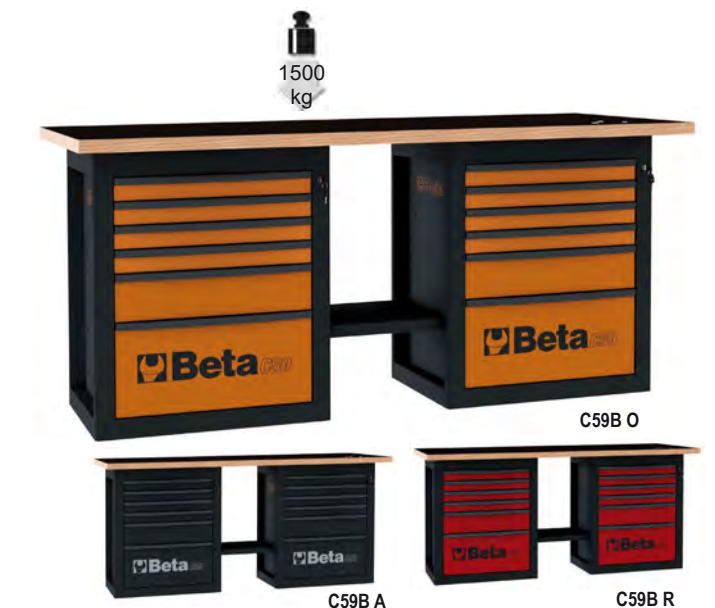

h	max
70 mm	25 kg
140 mm	30 kg
280 mm	35 kg

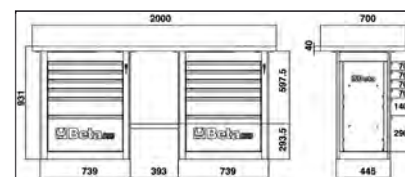

C59C

"Endurance" munkapad egy 6 fiókos blokkal, rövid kivitel

Fő jellegzetességek:

- Multiplex-munkalap furatokkal a satu rögzítéséhez 1599F/125 (külön kell megrendelni).
- 6 fiók, teleszkópos, csapágyazott fiók 588x367 mm
- 4 fiók magasság: 70 mm
- 1 fiók magasság: 140 mm
- 1 fiók magasság: 280 mm
- A fiókok habgumival bélelték.
- Hőformált tálcák elhelyezhetők.
- Elöl központi biztonsági zár.
- Alul tároló rekesz.
- 2400 RSC24/PC papírtekerstartó és a 2400 RSC24/PF-flakontartó felszerelhető, külön kell megrendelni.

105 kg

		Ft		
C59C-O	RAL 2011	635.000	1	059000013
C59C-R	RAL 3000	635.000	1	059000053
C59C-A	RAL 7016	635.000	1	059000033

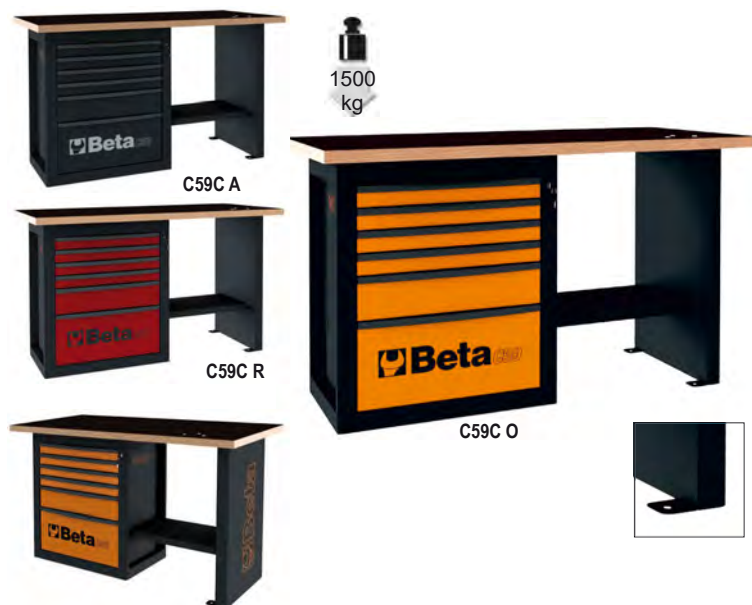

h	max
70 mm	25 kg
140 mm	30 kg
280 mm	35 kg

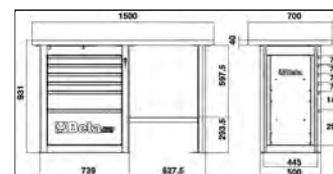

9562T2

munkapad alátétszőnyeg, 200x160 cm

- Védi a padlót az olaj- és benzincseppektől, környezetbarát
- Könnyen tisztítható, csúszásmentes, gumibevonátú alsórésszel



	L cm	Ft		
9562T2	200	66.300	1	095620200



MŰHELYBERENDEZÉSEK



Hogy megfeleljen az egyre inkább a minőség, a design és a személyre szabottság igényével jelentkező piacnak, a Beta Utensili kifejlesztette a "Racing System C55" moduláris műhelyberendezési rendszert, hogy lehetővé tegye Önöknek egy modern és a szükségleteknek mindenben megfelelő munkahelyi környezet létrehozását.

Minőség

A legjobb „Made in Italy“ Beta minőség a műhely berendezéséhez

Szervezettség

Egy észszerűen szervezett munkaállás lehetővé teszi a munkavégzés optimalizálását

Modularitás

A rendelkezésre álló hely és az igények alapján összeállítható műhely



Design

Igényes és lenyűgöző kivitel, hogy a munkahely egy rendezett és kellemes környezetet biztosítson





MADE IN ITALY

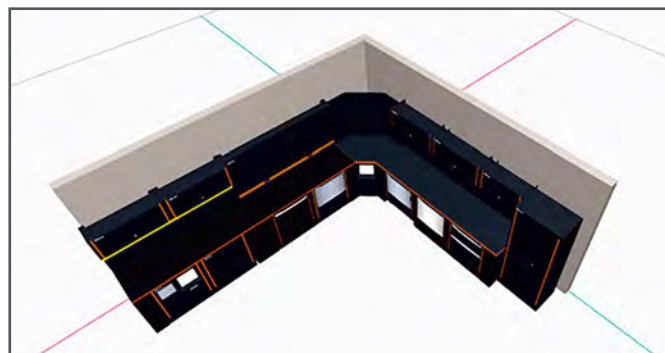

Látogasson el a www.rsc55.com webhelyre és konfigurálja saját műhelyét.



A színeiben tündöklő műhely!

Az RSC55 lehetőséget kínál arra, hogy a munkapadok és a szerszámtartó falak redőnyeit semleges (szürke) színben rendeljük meg, majd személyre szabhatjuk magunknak a 7 különböző színű ragasztószalag (függőleges betétek) segítségével.

- 1. Rendelje meg a modulokat semleges színben**
- 2. Rendelje meg a függőleges betéteket**
Válassza ki a megfelelő színt ízlésének, vagy vállalata arculatának megfelelően.

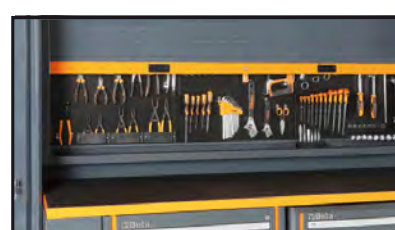

A teljes összeállítás a következőkből áll:

- 1 ajtós szekrény (C55A1)
- 2 ajtós szekrény (C55A2)
- Munkapad (C55BO/2)
- Munkapad csatlakozókkal (C55PRO BO/2)
- 7 fiókos mobil szerszámkocsi (C55C7)
- Rögzített 2 fiókos modul (C55M2)
- Rögzített 7 fiókos modul (C55M7)
- Rögzített szervizmodul (C55MS)
- Polcos fal (C55/2PM)
- Szerszám tartó fal redőnyvel (C55PS-O)

C55AB

műhelyberendezés összeállítás

Az összeállítás a következőkből áll:

- 2 ajtós szekrény (C55A2)
- Munkapad (C55BO/2)
- Rögzített 7 fiókos modul (C55M7)
- Rögzített szervizmodul (C55MS)
- Polcos fal (C55/2PM)

407 kg



C55AB

Ft 3.508.300 1 055000020



C55PB/3

műhelyberendezés összeállítás

Az összeállítás a következőkből áll:

- Munkapad (C55BO/2)
- 8 fiókos szerszámkocsi műhelyberendezéshez (C55C8)
- 2 nagy fiókos rögzített modul (C55M2)
- Redőnyös szerszámtartó fal (C55PS-O)

334 kg



C55PB/3

Ft 2.891.900 1 055000035



C55B/2

2 méteres munkapad műhelyberendezéshez

Ütésbiztos és szénhidrogéneknek ellenálló, karcvédett PVC réteggel bevont, 2050x700 mm munkalap

- Furatok a(z) 1599F/150 satu rögzítéséhez (külön kell megrendelni)
- Állítható magasságú lábak

105 kg

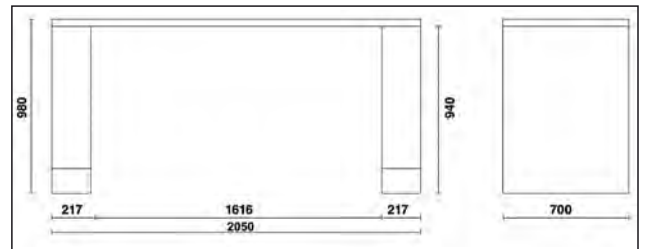
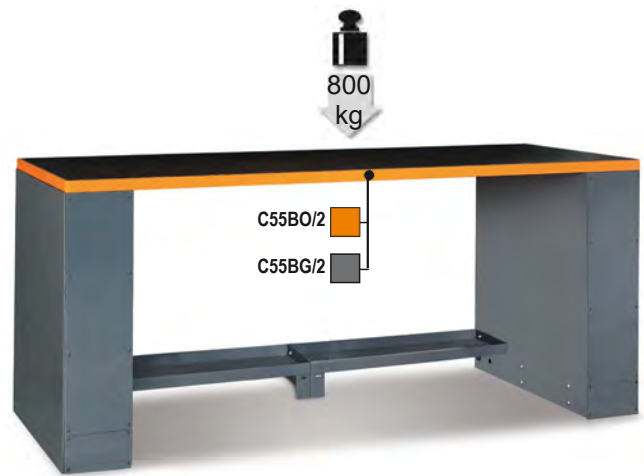

	Ft		
C55BO/2	804.700	1	055000101
C55BG/2	804.700	1	055000111

C55PRO B/2

2 méteres munkapad műhelyberendezés összeállításához

Ütésbiztos és szénhidrogéneknek ellenálló karcvédett PVC réteggel burkolt 2050x700 mm munkalap

Beépített aljzatok és tömlődob:

- Schuko aljzat+16+10A
- EU csatlakozó 10A
- Sűrített levegős csatlakozó Ø 8 mm tömlődobbal. Hosszúság: 10 m.
- Furatokkal a satu rögzítéséhez (1599F/150, külön kell megrendelni)
- Függetlenül állítható talp

110 kg

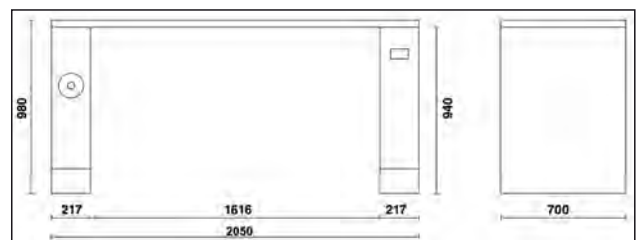
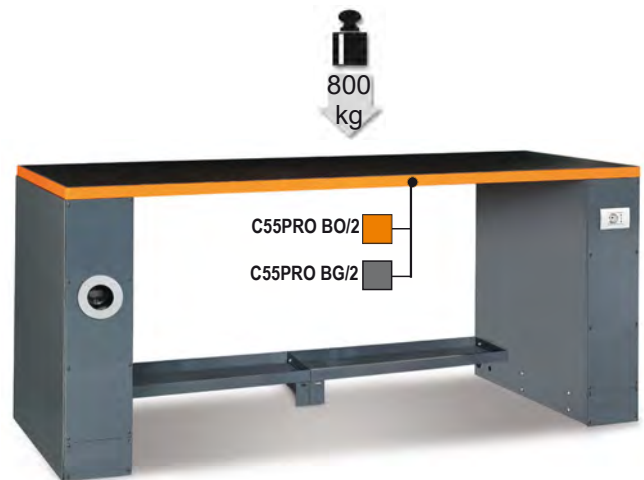

	Ft		
C55PRO BO/2	979.200	1	055000151
C55PRO BG/2	979.200	1	055000171

C55B/2,8

2,8 méteres munkapad műhelyberendezéshez

Ütésbiztos és szénhidrogéneknek ellenálló, karcvédett PVC réteggel bevont, 2850x700 mm munkalap

- Furatok a(z) 1599F/150 satu rögzítéséhez (külön kell megrendelni)
- Állítható magasságú lábak

129 kg

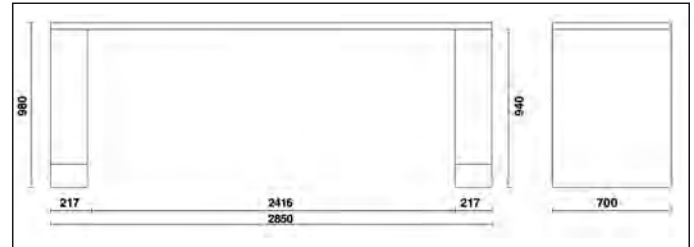
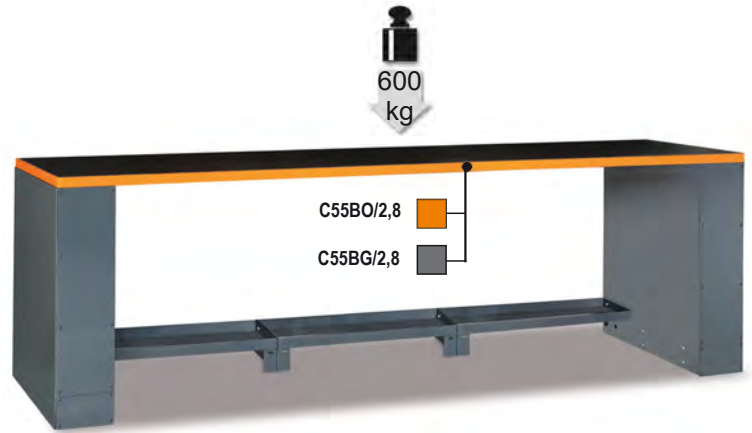

	Ft		
C55BO/2,8	991.300	1	055000261
C55BG/2,8	991.300	1	055000281

C55PRO B/2,8

2,8 méteres munkapad műhelyberendezés összeállításhoz

Ütésbiztos és szénhidrogéneknek ellenálló karcvédett PVC réteggel burkolt 2850x700 mm munkalap

Beépített aljzatok és tömlődob:

- Schuko aljzat+16+10A
- EU csatlakozó 10A
- Sűrített levegős csatlakozó Ø 8 mm tömlődobbal. Hosszúság: 10 m.
- Furatokkal a satu rögzítéséhez (1599F/150, külön kell megrendelni)
- Függsőlegesen állítható talp

134 kg

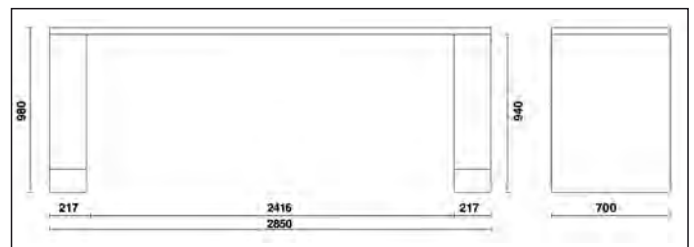
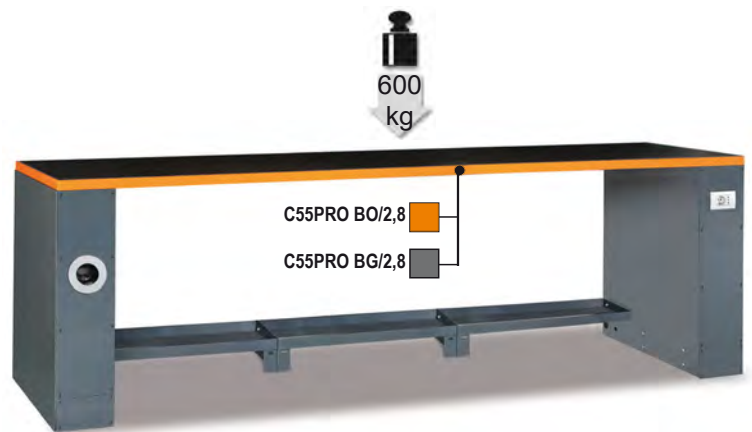

	Ft		
C55PRO BO/2,8	1.165.900	1	055000271
C55PRO BG/2,8	1.165.900	1	055000283

C55B-D4

4 méteres kettős munkapad középső lábbal

4100x700 mm méretű, egy ütésálló és karcálló, szénhidrogéneknek ellenálló PVC réteggel burkolva

- Furatok egy darab 1599F/150 típusú satu elhelyezésére (külön kell megrendelni)
- Állítható magasságú lábak
- Dupla szélességű középső láb (365x750 mm) beépített ajtós tárolórekeszsel

185 kg

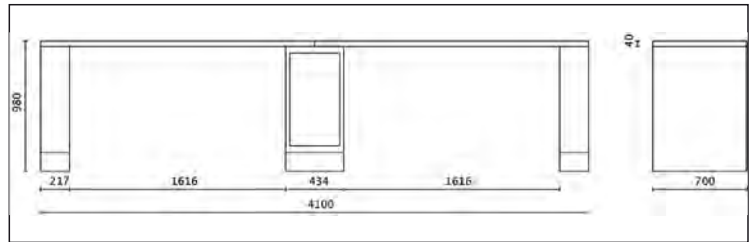
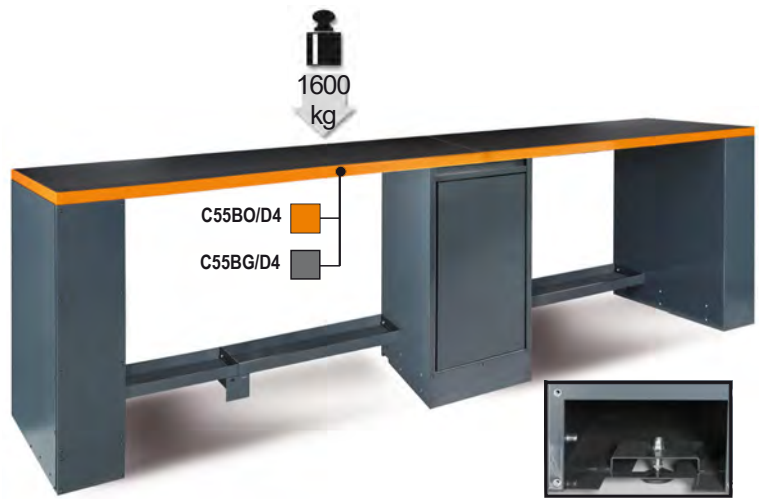

C55BO-D4	1.633.100	1	055000109
C55BG-D4	1.633.100	1	055000119

C55PRO B-D4

4 méteres két munkaállomásos munkapad középső lábbal

Ütésbiztos és szénhidrogéneknek ellenálló karcvédett PVC réteggel burkolt 4100x700 mm munkalap

Beépített aljzatok és kábeldob:

- Schuko aljzat+16+10A
- EU csatlakozó 10A
- Sűrített levegős csatlakozó Ø 8 mm tömlődobbal. Hosszúság: 10 m.
- Furatokkal a satu rögzítéséhez (1599F/150, külön kell megrendelni)
- Függetlenül állítható talp
- Dupla szélességű középső láb (365x750 mm) beépített ajtós tárolórekeszsel

190 kg

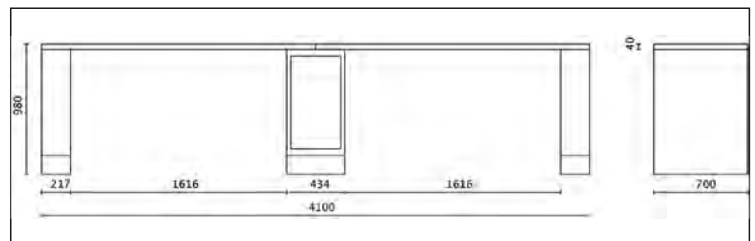
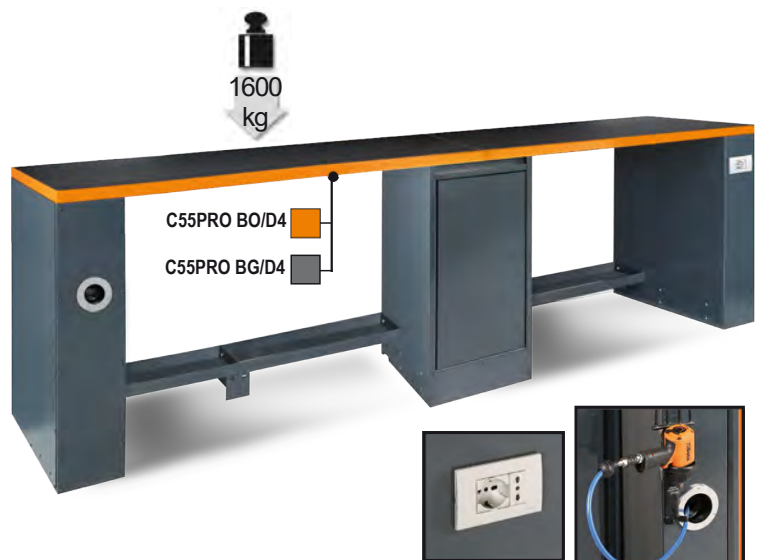

C55PRO-BO-D4	1.807.600	1	055000159
C55PRO-BG-D4	1.807.600	1	055000179

 **Beta**

C55B/G

univerzális láb műhelyberendezés munkapadhoz

- Fügőlegesen állítható talp
- A munkapad mindkét oldalára felszerelhető
- Szemből és oldalról nyitható szerelőnyílás

30 kg

C55B/G Ft 226.300 1 055000096

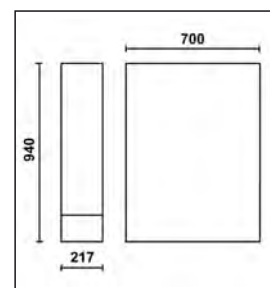

C55B/GAA

univerzális lábazat munkapadhoz beépített tömlődobbal

- Beépített automata tömlődob pneumatikus levegőhöz vagy hideg vízhez, Ø 8 mm
- Tömlő hossz: 10 m
- Fügőlegesen állítható talp
- Szemből és oldalról nyitható szerelőnyílás

35 kg

C55B/GAA Ft 356.000 1 055000099

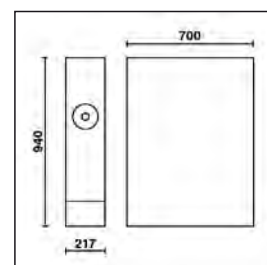

C55B/GDP

Kettős láb műhelyberendezés munkapadhoz

Papírtekerstartó rekesz
Rakodórekesz zárófedéllel
Állítható magasságú lábakkal

45 kg

C55B/GDP Ft 511.800 1 055000292

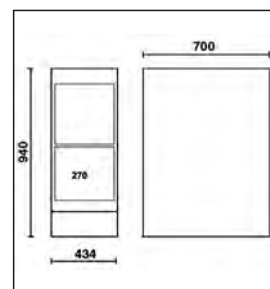

C55B/GDS

kettős láb műhelyberendezés munkapadhoz

Rakodórekesz 365x750 mm, zárófedéllel
Állítható magasságú lábakkal

45 kg

C55B/GDS Ft 476.300 1 055000291

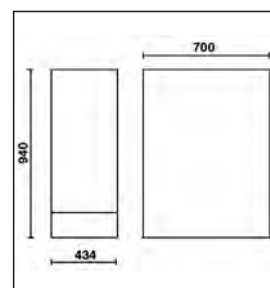

C55B/GE

univerzális láb konnektorral műhelyberendezés munkapadhoz

- Schuko aljzat 16/10A
- EU csatlakozó 10A
- Függetlenül állítható talp
- Szemből és oldalról nyitható szerelőnyílás

📦 30 kg

C55B/GE Ft 271.100 1 055000097

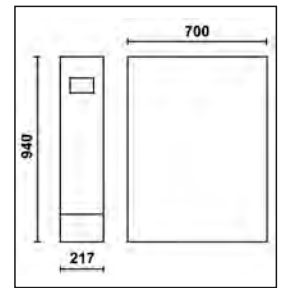

C55B/GAE

univerzális láb elektromos kábeldobbal műhelyberendezés munkapadhoz

- Beépített automata kábeldob Schuko csatlakozóval.
- Kábelhossz: 15 m
- Hővédő kapcsolóval
- Függetlenül állítható talp
- Szemből és oldalról nyitható szerelőnyílás

📦 35 kg

C55B/GAE Ft 384.000 1 055000094

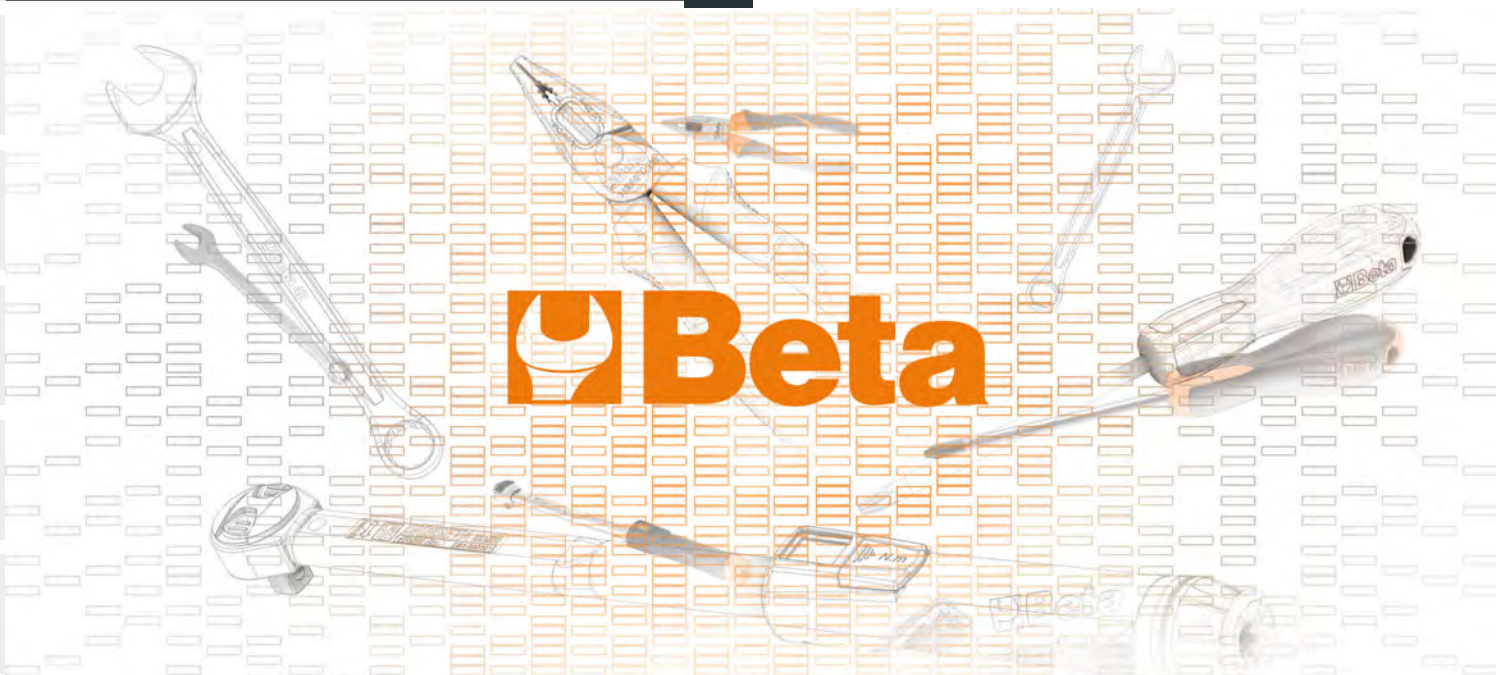
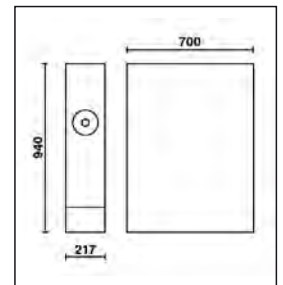

C55/PL-1,024

1 m széles munkalap műhelyberendezés munkapad bővítéséhez

Ütésálló és szénhidrogéneknek ellenálló, karcvédett PVC réteggel burkolt, 1024x700 mm, festett lemez munkalap

21 kg

	Ft		
C55/PLO-1,024	168.200	1	055000130
C55/PLG-1,024	168.200	1	055000131



C55B PT/2

2 méteres munkalap műhelyberendezéshez

Ütésbiztos és szénhidrogéneknek ellenálló, karcvédett PVC réteggel burkolt, 2050x700 mm, festett lemez munkalap
Furatokkal a satu rögzítéséhez (1599P/150, külön kell megrendelni)

43 kg

	Ft		
C55B PT/2	352.100	1	055000106
C55BG PT/2	352.100	1	055000116

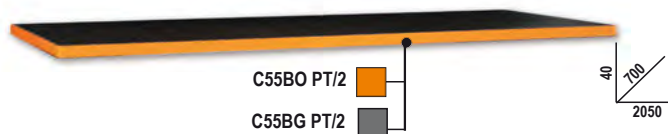



C55B PT/2,8

2,8 méteres munkalap műhelyberendezéshez

Ütésbiztos és szénhidrogéneknek ellenálló, karcvédett PVC réteggel burkolt, 2850x700 mm, festett lemez munkalap
Furatokkal a satu rögzítéséhez (1599P/150, külön kell megrendelni)

61 kg

	Ft		
C55BO PT/2,8	538.700	1	055000266
C55BG PT/2,8	538.700	1	055000286



C55RB

ütésbiztos és szénhidrogéneknek ellenálló, karcvédett PVC burkolat

Munkalapok védelmére.

C55RB/2: 2 m széles munkalaphoz

C55RB/2,8: 2,8 m széles munkalaphoz

C55RB/0,7: 700x700mm méretű munkalaphoz

C55RB/1: 1 m széles munkalaphoz

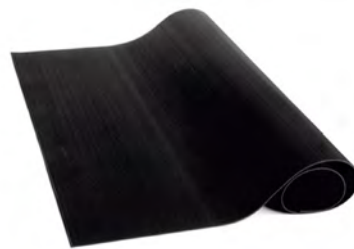



	Ft		
C55RB/2	64.650	1	055000195
C55RB/2,8	87.550	1	055000196
C55RB/0,7	34.600	1	055000199
C55RB/1	48.150	1	055000198

C55B/VS

alsó munkalap konzol műhely munkapadokhoz, 0,8 m széles

Méretetek: 800x230x60 mm

4 kg

	Ft		
C55B/VS	48.400	1	055000095

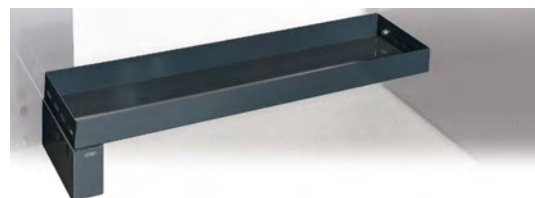

C55C7

7 fiókos szerszámkocsi műhelyberendezéshez

7 fiók 588x367 mm, teleszkópos, csapágyazott

- 4 kerék Ø 100 mm, 2 rögzített (egyik fékkel) és 2 elfordítható
- Alumínium nyitórendszer, a szerszámkocsi teljes hosszában elhelyezve
- A fiókok habgumival bélelték
- Központi zár elöl
- Hőformált tálcák elhelyezési lehetősége

79 kg

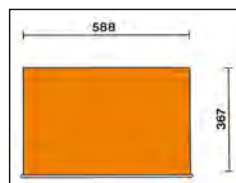

h	max
70 mm	30 kg
245 mm	40 kg

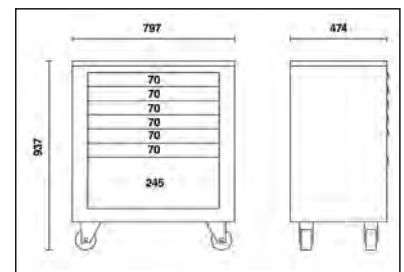

C55C7

Ft 762.200 1 055000201

Beta

C55C8

8 fiókos szerszámkocsi műhelyberendezéshez

8 fiók 588x367 mm, teleszkópos, csapágyazott

- 4 kerék Ø 100 mm, 2 rögzített (egyik fékkel) és 2 elfordítható
- Alumínium nyitórendszer, a szerszámkocsi teljes hosszában elhelyezve
- A fiókok habgumival béleltek
- Központi zár elől
- Hőformált tálcák elhelyezési lehetősége

81 kg



h	max
70 mm	30 kg
175 mm	40 kg

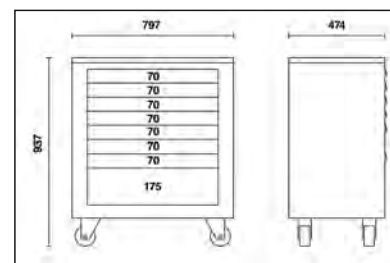
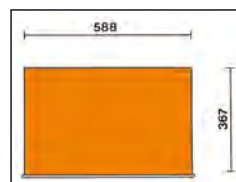

C55C8

Ft 793.100 1 055000206

C55M2

2 fiókos rögzített modul műhelyberendezéshez

2 fiók 588x367 mm, teleszkópos, csapágyazott

- Alumínium nyitórendszer, a fiók teljes hosszában elhelyezve
- A fiókok habgumival béleltek
- Központi zár elől

66 kg



h	max
280 mm	40 kg
385 mm	40 kg

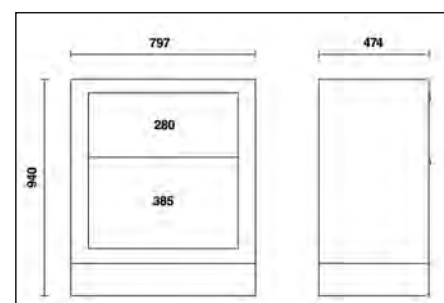
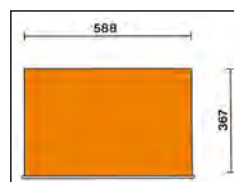

C55M2

Ft 641.900 1 055000202

C55M4

4 fiókos rögzített modul műhelyberendezéshez

4 fiók (588x367 mm), teleszkópos, csapágyazott

- Alumínium nyitórendszer, a szerszámok teljes hosszában elhelyezve
- A fiókok habgumival béleltek
- Központi zár elől

75 kg

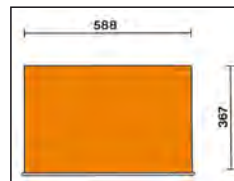

h	max
140 mm	30 kg
245 mm	40 kg

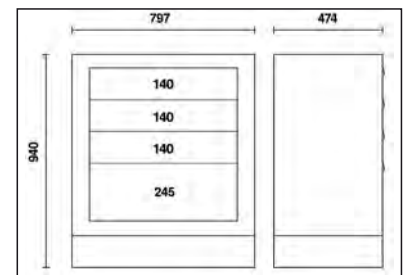

C55M4

Ft 672.700 1 055000212

C55M7

7 fiókos rögzített modul műhelyberendezéshez

7 fiók 588x367 mm, teleszkópos, csapágyazott

- Alumínium nyitórendszer, a fiók teljes hosszában elhelyezve
- A fiókok habgumival béleltek
- Központi zár elől
- Hőformált tálcák elhelyezési lehetősége

78 kg

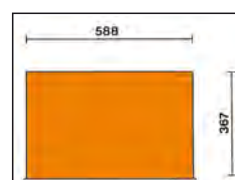

h	max
70 mm	30 kg
245 mm	40 kg

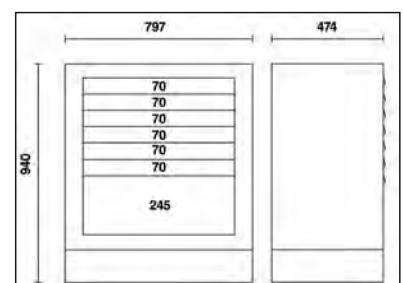

C55M7

Ft 714.000 1 055000203

C55M8

8 fiókos rögzített modul műhelyberendezéshez

8 fiók 588x367 mm, teleszkópos, csapágyazott

- Alumínium nyitórendszer, a fiók teljes hosszában elhelyezve
- A fiókok habgumival bélelték
- Központi zár elöl
- Hőformált tálcák elhelyezési lehetősége

📦 78,9 kg



h	max
70 mm	30 kg
175 mm	40 kg

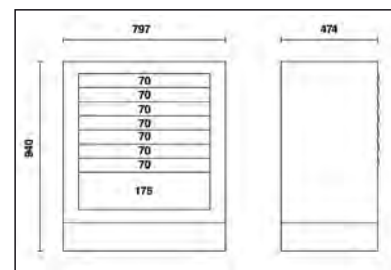
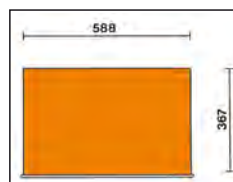

C55M8

Ft 732.500 1 055000207

C55CS

Rögzített szelektív hulladékgyűjtő modul műhelyberendezéshez

- Kihúzható 588x465 méretű hulladékgyűjtő rekesz, golyóscsapágyas teleszkópos vezetőkn- 2 nagy térfogatú kihúzható belső tartály a hulladék szétválasztásához

📦 62 kg

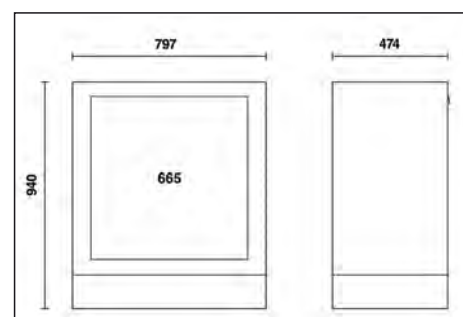

C55CS

Ft 664.700 1 055000208

C55MA

2 ajtós rögzített modul műhelyberendezéshez

- Zárral ellátva
- Magasságában állítható belső polccal

75 kg

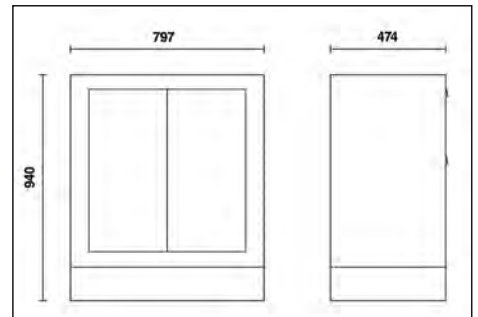

C55MA

Ft 564.200 1 055000205

C55MDO

Rögzített olajelosztó modul műhelyberendezéshez

- 2 tekercselő, 7 m - 1/2" gumicsővel együtt
- 2 digitális literszámlálóval rendelkező pisztoly automatikus cseppvédővel
 - legnagyobb szállítási mennyiség: 35 l/p
 - viszkozitás: 8÷5000 mPas

94 kg

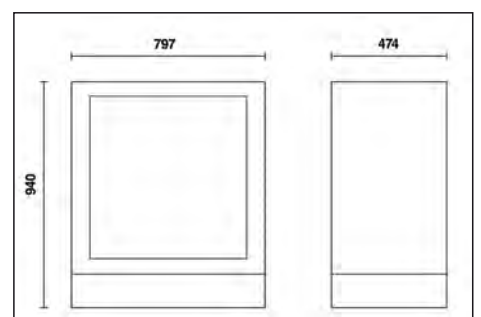

C55MDO

Ft 1.212.700 1 055000210

C55MS

rögzített szervizmodul műhelyberendezéshez

- Beépített hulladékartó
- Üreg a papírtekerstartó számára
- 1 rakodófiók 305x270 mm

📦 75 kg

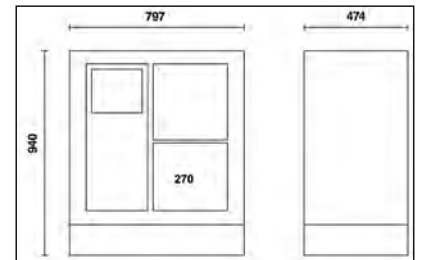

C55MS

Ft 588.000 1 055000204

C55T3

kocsi

- 3 csúszásmentes bordázott gumival fedett munkalap
- Ergonomikus fogantyú
- A központi munkalap kétféleképpen is rögzíthető
- Négy Ø 100 mm (kettő fékezhető)
- Statikus terhelhetőség: 200 kg (3 polc között elosztva)

📦 21 kg

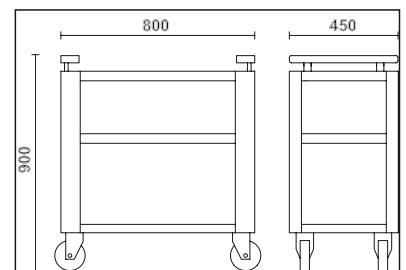

C55T3

Ft 108.600 1 055000219

C55P/MCD

összekötő tartó konzol a panelek toldásához

10 kg

C55P/MCD Ft 59.500 1 055000257



C55P/2MDX-SX

Jobb és bal oldali tartó konzol a végekre

10 kg

C55P/2MDX-SX Ft 102.200 1 055000253



C55PM

1 m széles függesztett szekrény műhelyberendezéshez

• Méretek: 1024x400x300 mm, gázrugós megoldás az ajtó könnyebb nyitásához és zárásához

24 kg

C55PM Ft 366.500 1 055000302

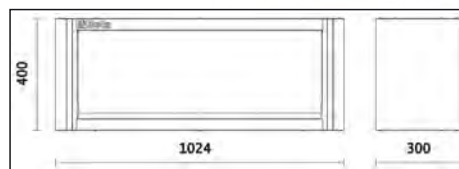

C55PFA-1,0

1 m széles perforált szerszámtartó panel műhelyberendezéshez

Perforált acél szerszámtartó panel
(1024x1020x25 mm)

11 kg

C55PFA-1,0 Ft 128.300 1 055000316

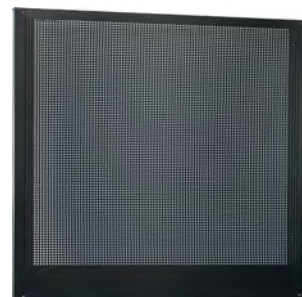

C55/PF

1 méter széles szekrény alatti perforált szerszámtartó panel

• Perforált szerszámtartó panel (1024x620 mm)
az 1,0X0,6 méretű C55PT-hez

6 kg

C55/PF Ft 78.250 1 055000307

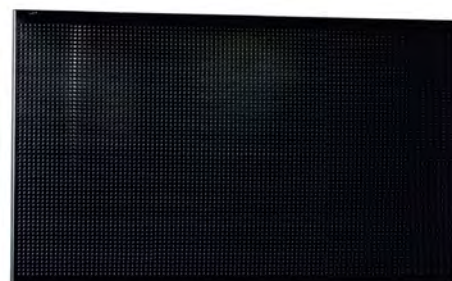

C55PT1,0X0,6

1 m széles panel faliszekrény alá

Méreték: 1024x620x25 mm

8 kg

C55PT1,0X0,6

Ft 71.000 1 055000314



C55PTE-1,0

1 m széles panel faliszekrény alá

Méreték: 1024x620x25 mm

2 elektromos aljzat fogadására (az aljzat nem tartozék)

8 kg

C55PTE-1,0

Ft 84.150 1 055000319



C55/2PM

2 polcos fal műhelyberendezéshez

- 2 db 1024x400x300 mm méretű polc, az ajtók nyitásának és zárásának megkönnyítésére gázrugókkal felszerelve.
- Fali panel 1024x620 mm, C55/PF perforált szerszámtartó panelek számára (külön kell rendelni)
- Önhordó szerkezettel rendelkezik
- 2 méteres munkapadhoz társítható

80 kg

C55/2PM

Ft 1.036.700 1 055000301

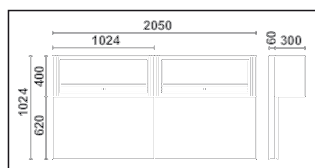

C55PFA-0,8

0,8 m széles perforált szerszámtartó panel

Lyukacsos acél perforált panel
(800x1020x25 mm)

10 kg

C55PFA-0,8 Ft 116.500 1 055000315



C55PM/M0,8

0,8 m széles függesztett szekrény

Méreték: 800x400x300 mm, gázrugós megoldás az ajtó könnyebb nyitásához és zárásához

19 kg

C55PM/M0,8 Ft 346.400 1 055000312

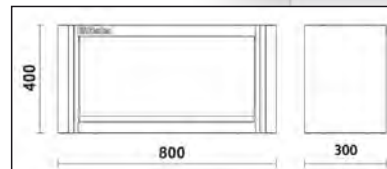

C55PTE-0,8

0,8 m széles panel faliszekrény alá

Méreték: 800x620x25 mm

1 elektromos aljzat fogadására (az aljzat nem tartozék)

6 kg

C55PTE-0,8 Ft 76.200 1 055000318



C55PT0,8X0,6

0,8 m széles panel faliszekrény alá

Méreték: 800x620x25 mm

7,8 kg

C55PT0,8X0,6 Ft 63.200 1 055000313



C55/1PF

perforált szerszámtartó panel műhelyberendezéshez

• Perforált panel 800x620 mm a szerszámok elhelyezéséhez

5 kg

C55/1PF Ft 56.100 1 055000309



C55PS

redőnyös szerszámtartó fal műhelyberendezéshez

- Fügőlegesen mozgatható, zárral rendelkező alumínium redőny
- Levehető perforált panel a szerszámok elhelyezéséhez
- Önördő szerkezettel szállítva
- 50 horgos GPS készlettel
- 2 méteres munkapadhoz társítható

88 kg

C55PS-O	Ft	1	055000250
C55PS-G	652.200	1	055000255

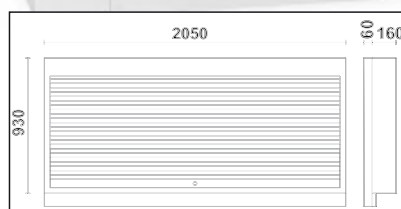

C55PSE

redőnyös szerszámtartó fal
2 elektromos aljzattal

- Fügőlegesen mozgatható, zárral rendelkező alumínium redőny
- Levehető perforált szerszámtartó panel
- Önördő szerkezettel szállítva
- 50 horgos GPS készlettel
- Elektromos aljzat kivágással
- 2 méteres munkapadhoz társítható

88 kg

C55PSE-O	Ft	1	055000258
C55PSE-G	665.600	1	055000260

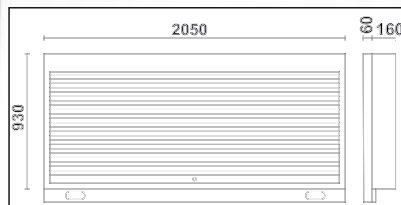

C55AE

2 m széles profil elektromos aljzatok fogadására

Méreték: 2050x25x90mm

2 elektromos aljzat fogadására

1,5 kg

C55AE	Ft	1	055000325
-------	----	---	-----------



C55AC

önálló teljes sarok

Munkalap (700x700 mm) tartólábbal
2 felső szerszámtartó fal 2 rögzítőpolccal (670x160 mm)

📦 66 kg

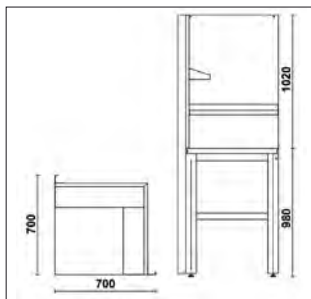

C55AC O

C55AC G



C55AC O	Ft	📦	🖨️
C55AC G	795.700	1	055000360
	795.700	1	055000380

C55KAI

sarok munkalap műhelyberendezés összeállításához, 700x700 méret lábakkal

• Ütésbiztos és szénhidrogéneknek ellenálló,
karcvédett PVC réteggel burkolt, 700x700 mm
festett lemez munkalap

📦 32 kg

C55KAI O

C55KAI G



C55KAI O	Ft	📦	🖨️
C55KAI G	446.700	1	055000365
	446.700	1	055000385

C55KAS

szerszámtartó fal felső sarok

• 2 perforált szerszámtartó panel (700x1020x25 mm)
• 2 rögzítőpolc (670x160 mm)

📦 24 kg



C55KAS	Ft	📦	🖨️
	349.000	1	055000370

C55MP

acél sarokpolc falra

Méretetek: 700x160x80 mm



C55MP	Ft	📦	🖨️
	52.750	1	055000374

C55B/1

munkapad hosszabbító, 1 m széles

- Ütésbiztos és szénhidrogéneknek ellenálló karcvédett PVC réteggel burkolt 1024x700 mm munkalap
- Univerzális láb függőlegesen állítható talppal
- 1 rögzített modul:
- 7 fiók (588x367 mm), teleszkópos, csapágyazott
- Alumínium nyitórendszer, a szerszámok teljes hosszában elhelyezve
- A fiókok habgumival bélelték
- Központi zár elől

127 kg



C55BO/1

C55BG/1



h	max
70 mm	30 kg
245 mm	40 kg

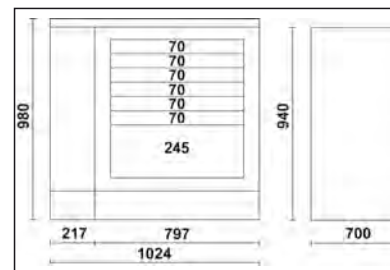
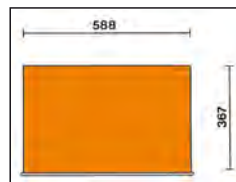

	Ft		
C55BO/1	1.108.500	1	055000090
C55BG/1	1.108.500	1	055000091

C55C

Cargo szekrények, RSC55 rendszer

A Cargo szerszámsekreányeket profi felhasználók bevonásával, alapos kutatás alapján terveztük, ezért a végfelhasználók számára pontos, kényelmes és észszerű megoldást kínálnak.

Az ajtókhöz illeszkedő két perforált lemezajtó nyitható, ezáltal további tárolóterhez jutunk.

Fő jellemzők:

- 1 fiók, teleszkópos, csapágyazott.
- Egyszerű szerszámrendezés a felhasználó igényei szerint.
- Könnyen falra szerelhető a szerszámsekreány hátulján található két horonnyal.
- Biztonsági zár a fiókokhoz és az ajtókhöz.
- Hőformált tálcá 1/2"-os dugókulcshoz és tartozékokhoz, üres.



37 kg

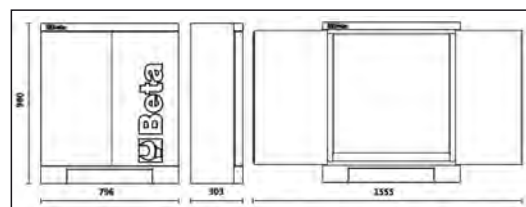

	Ft		
C55C	305.500	1	055000400

C55A1

1 ajtós lemezszekrény műhelyberendezéshez

- 3 db állítható magasságú polc
- Zárral ellátva
- Hasznos belső méretek: 177x42x42 cm

50 kg

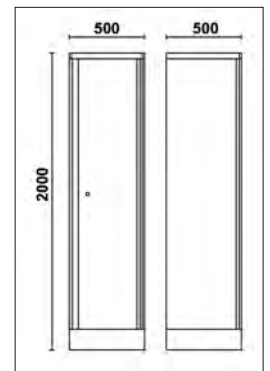
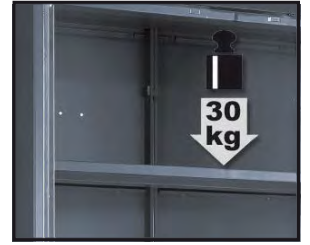

C55A1

Ft 274.600 1 055000411

C55A1/R42

polc a C55A1/C55AT1 szerszámszekrényhez

2,4 kg



C55A1/R42

420x420 mm

Ft 11.650 1 055000461

Beta

C55A2

2 ajtós lemezszekrény műhelyberendezéshez

- 3 db állítható magasságú polc
- Zárral ellátva
- Hasznos belső méretek: 177x70x42 cm

72 kg

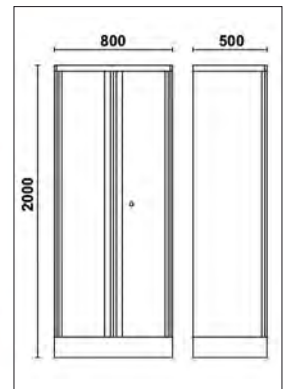
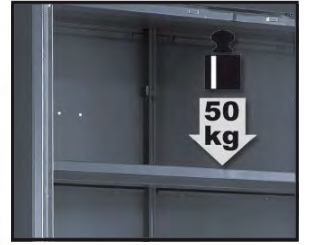

C55A2

Ft 364.900 1 055000412

C55A2/R70

polc a C55A2/C55AT2 szerszámszekrényhez

3,5 kg



C55A2/R70

700x420 mm

Ft 19.150 1 055000462

Beta

C55AT1

lemez szerszámszekrény átlátszó polikarbonát ajtóval
műhelyberendezéshez

- 3 db állítható magasságú polc
- Zárható
- Hasznos belső méret: 1770x420x420 mm

41 kg

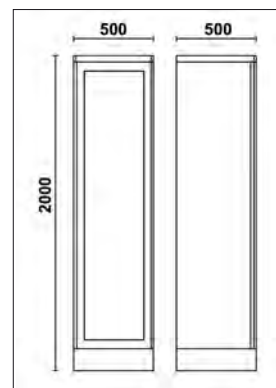

C55AT1 Ft 336.900 1 055000421

C55AT2

lemez szerszámszekrény átlátszó polikarbonát ajtóval
műhelyberendezéshez

- 3 db állítható magasságú polc
- Zárható
- Hasznos belső méret: 1770x700x420 mm

56 kg

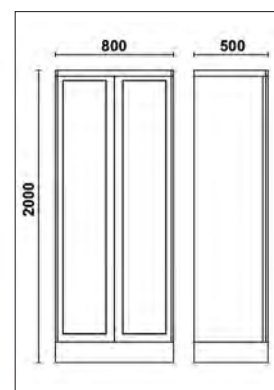

C55AT2 Ft 444.700 1 055000422

C55STR

színes ragasztószalag, 25 m

lehetővé teszi a függőleges betétek színének személyre szabását a C55
műhelyberendezésnél

		Ft	1	055000901
C55STR-O/2011		27.050	1	055000901
C55STR-R/3000		27.050	1	055000903
C55STR-V/6029		27.050	1	055000906
C55STR-W/9016		27.050	1	055000907
C55STR-Y/1023		27.050	1	055000905
C55STR-B/5015		27.050	1	055000904
C55STR-GO/1035		27.050	1	055000909
C55STR-S/9006		27.050	1	055000902



PROFESSZIONÁLIS - ERŐS - RENDSZEREZETT

ÚJ
DESIGN

A C45PRO műhelyberendezéssel a lehető legtöbbet hozhatja ki munkaadománásából. Az új, 2021-es design-nak és a váz technikai fejlesztés: köszönhetően ez a termék is kiváló ár-érték aránnyal dicsekedhet.

A C45PRO moduláris műhelyberendezéssel a rendelkezésre álló helyen tervezett felhasználásnak megfelelő egyedi munkakörnyezetet alakíthat ki előre összeállított kombinációkkal rendelkező egyszerű, rugalmas termék idővel kibővíthető vagy átalakítható. Alternatív megoldásként munkaadomán: teljes mértékben testre szabhatja kezdve a munkalappal - elérhető rozsdá acéllal fedett MDF vagy rétegelt lemez verziókban - melyeket választása s kiegészíthet számos alkatrészsel és tartozékkal.

Alakítson ki az igényeinek megfelelő egyéni munkakörnyezetet. Legy műhelye, garázsá más, mint a többi. Válasszon az előre összeállított kombinációk közül, vagy valósítsa meg elképzeléseit egészen az alapoktól.



A C45 MŰHELYBERENDEZÉS MEGÚJULT KÜLSŐVEL A BETA SZÍNEIBEN POMPÁZIK.

Konfigurálja saját műhelyét

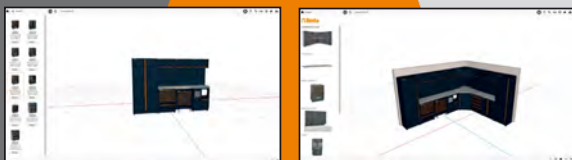

látogasson el a www.beta-tools.com

C45PRO X

C45PRO műhelyberendezés összeállítás

Az összeállítás a következőkből áll:

- Rozsdamentes acéllal fedett MDF munkalap (C45PX/3-2.0MT)
- 7 fiókos rögzített modul (C45PRO M7)
- Rögzített kiszolgáló modul (C45PRO MS)
- 7 fiókos szerszámkocsi (C45PRO C7)
- Kétajtós szerszámos szekrény (C45PRO AS2)
- 3 lyukacsos szerszámtartó panel (C45PRO PF)
- 3 faliszekrény (C45PRO PM)
- 3 széles falikonzol (C45PRO SL)
- 1 keskeny falikonzol (C45PRO SS)

305 kg



C45PRO X

Ft 1.603.200 045000001

2000
405
2955

C45PRO W

C45PRO műhelyberendezés összeállítás

Az összeállítás a következőkből áll:

- Rétegelt lemez munkalap (C45PW/3-2.0MT)
- 7 fiókos rögzített modul (C45PRO M7)
- Rögzített kiszolgáló modul (C45PRO MS)
- 7 fiókos szerszámkocsi (C45PRO C7)
- Kétajtós szerszámos szekrény (C45PRO AS2)
- 3 lyukacsos szerszámtartó panel (C45PRO PF)
- 3 faliszekrény (C45PRO PM)
- 3 széles falikonzol (C45PRO SL)
- 1 keskeny falikonzol (C45PRO SS)

303 kg

C45PRO W Ft 1.560.100 1 045000002

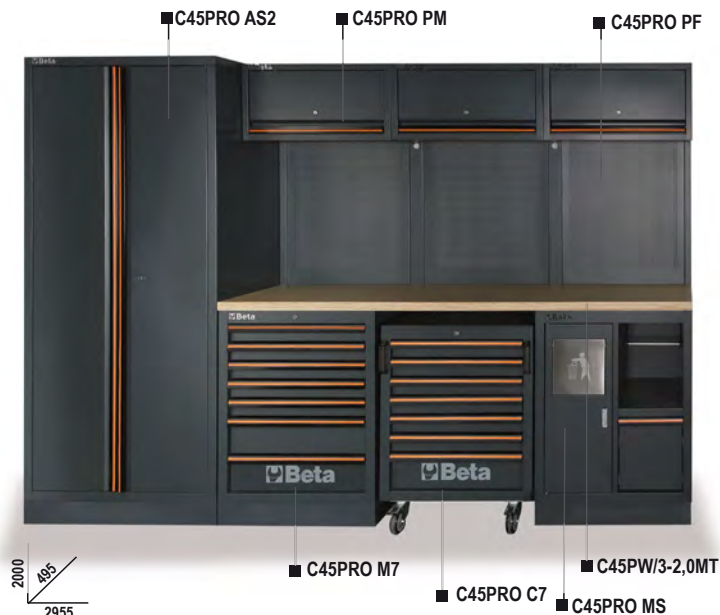

C45PRO AX

C45PRO műhelyberendezés összeállítás

Az összeállítás a következőkből áll:

- Rozsdamentes acéllal fedett MDF munkalap (C45PX/3-2.0MT)
- 7 fiókos rögzített modul (C45PRO M7)
- Rögzített kiszolgáló modul (C45PRO MS)
- Rögzített kétajtós modul (C45PRO MA)
- 3 faliszekrény (C45PRO PM)
- 3 lyukacsos szerszámtartó panel (C45PRO PF)
- 2 széles falikonzol (C45PRO SL)
- 2 keskeny falikonzol (C45PRO SS)

206 kg

C45PRO AX Ft 1.061.300 1 045000003



C45PRO AW

munkapadok C45PRO műhelyberendezés összeállításához

Az összeállítás a következőkből áll:

- Rétegelt lemez munkalap (C45PW/3-2.0MT)
- 2 fiókos rögzített modul (C45PRO MA)
- 7 fiókos rögzített modul (C45PRO M7)
- Rögzített kiszolgáló modul (C45PRO MS)
- 3 faliszekrény (C45PRO PM)
- 3 lyukacsos szerszámtartó panel (C45PRO PF)
- 2 keskeny falikonzol (C45PRO SS)
- 2 széles falikonzol (C45PRO SL)

204 kg

C45PRO AW Ft 1.018.200 1 045000004



C45PRO BX

C45PRO műhelyberendezés összeállítás

Az összeállítás a következőkből áll:

- Rozsdamentes acéllal fedett MDF munkalap (C45PX/2-1.3MT)
- 5 fiókos rögzített modul (C45PRO M5)
- Rögzített kétajtós modul (C45PRO MA)
- Egyajtós szerszámos szekrény (C45PRO AS1)
- 2 faliszekrény (C45PRO PM)
- 2 lyukacsos szerszámtartó panel (C45PRO PF)
- 2 széles falikonzol (C45PRO SL)
- 1 keskeny falikonzol (C45PRO SS)

191 kg

C45PRO BX Ft 965.100 1 045000021

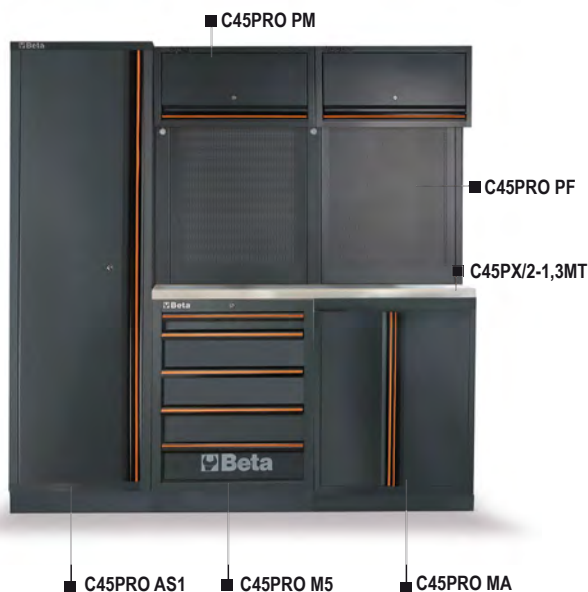

C45PRO BW

C45PRO műhelyberendezés összeállítás

Az összeállítás a következőkből áll:

- Rétegelt lemez munkalap (C45PW/2-1.3MT)
- 5 fiókos rögzített modul (C45PRO M5)
- Rögzített kétajtós modul (C45PRO MA)
- Egyajtós szerszámos szekrény (C45PRO AS1)
- 2 faliszekrény (C45PRO PM)
- 2 lyukacsos szerszámtartó panel (C45PRO PF)
- 2 széles falikonzol (C45PRO SL)
- 1 keskeny falikonzol (C45PRO SS)

190 kg

C45PRO BW Ft 926.400 1 045000022

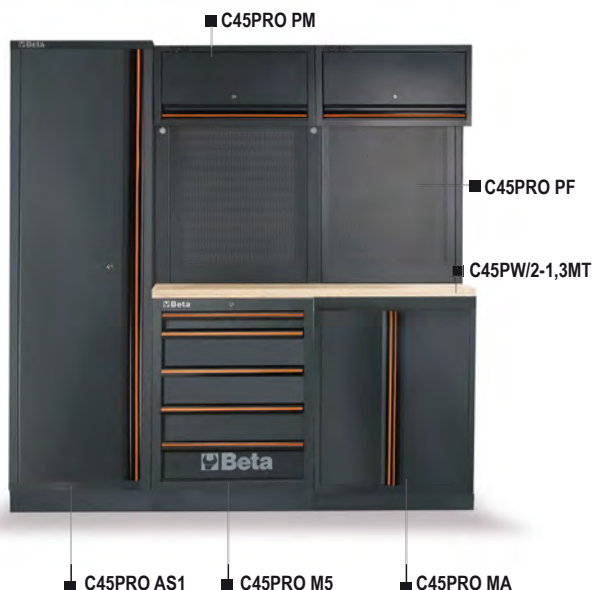

C45PRO DX

C45PRO műhelyberendezés összeállítás

Az összeállítás a következőkből áll:

- 1 rozsdamentes acéllal fedett MDF munkalap (C45PX/3-2,0MT)
- 1 rozsdamentes acéllal fedett MDF munkalap (C45PX/2-1,3MT)
- 1 7 fiókos rögzített modul (C45PRO M7)
- 1 7 fiókos szerszámkocsi (C45PRO C7)
- 1 rögzített kiszolgáló modul (C45PRO MS)
- 1 5 fiókos rögzített modul (C45PRO M5)
- 1 rögzített kétajtós modul (C45PRO MA)
- 1 önálló teljes sarok rozsdamentes acéllal fedett MDF munkalappal (C45PRO CORNER/X)
- 5 lyukacsos szerszámtartó panel (C45PRO PF)
- 5 faliszekrény (C45PRO PM)
- 7 széles falikonzol (C45PRO SL)
- 2 keskeny falikonzol (C45PRO SS)
- 2 egyajtós szekrény (C45PRO AS1)

572,3 kg

C45PRO DX Ft 3.054.800 1 045000031

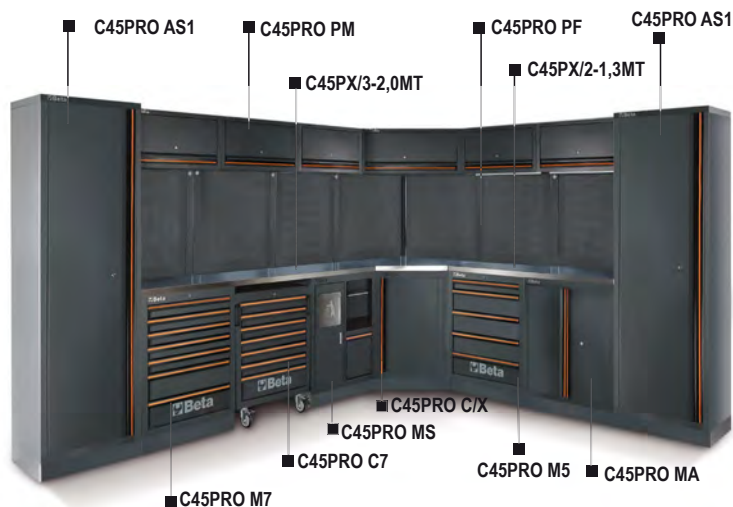

C45PRO DW

C45PRO műhelyberendezés összeállítás

Az összeállítás a következőkből áll:

- 1 rétegelt lemez munkalap (C45PW/3-2.0MT)
- 1 rétegelt lemez munkalap (C45PW/2-1.3MT)
- 1 7 fiókos rögzített modul (C45PRO M7)
- 1 7 fiókos szerszámkocsi (C45PRO C7)
- 1 rögzített kiszolgáló modul (C45PRO MS)
- 1 5 fiókos rögzített modul (C45PRO M5)
- 1 rögzített kétajtós modul (C45PRO MA)
- 1 önálló teljes sarok fa munkalappal (C45PRO CORNER/W)
- 5 lyukacsos szerszámtartó panel (C45PRO PF)
- 5 faliszekrény (C45PRO PM)
- 7 széles falikonzol (C45PRO SL)
- 2 keskeny falikonzol (C45PRO SS)
- 2 egyajtós szekrény (C45PRO AS1)

■ 568,5 kg

C45PRO DW Ft 2.952.700 1 045000032

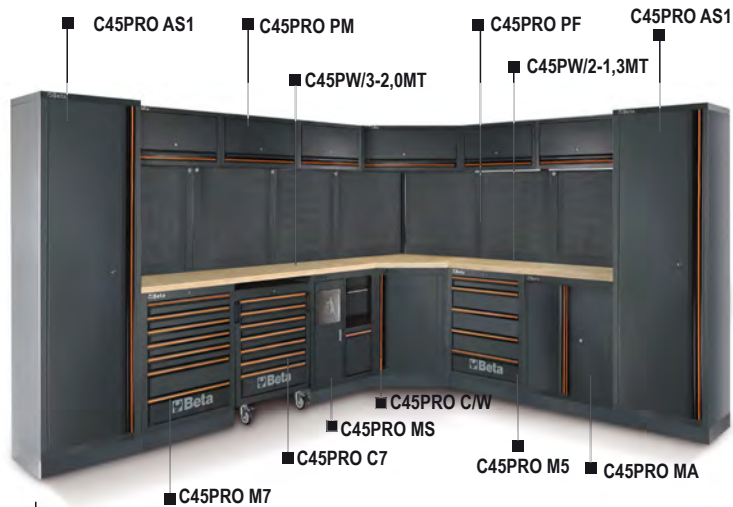

C45PRO EX

C45PRO műhelyberendezés összeállítás

Az összeállítás a következőkből áll:

- 2 lyukacsos szerszámtartó panel (C45PRO PF)
- 2 faliszekrény (C45PRO PM)
- 2 széles falikonzol (C45PRO SL)
- 1 keskeny falikonzol (C45PRO SS)
- 1 egyajtós szekrény (C45PRO AS1)
- 7 fiókos rögzített modul és MDF borítású rozsdamentes acél munkalap (C45PRO M7A/X):
 - 1 fiók, 1248x406 mm
 - 6 fiók, 782x406 mm
 - 5 fiók, 65 mm magas
 - 1 fiók, 145 mm magas
- 1 ajtós, polcos tárolórekesz

■ 174,6 kg

C45PRO EX Ft 1.025.200 1 045000033



C45PRO EW

C45PRO műhelyberendezés összeállítás

Az összeállítás a következőkből áll:

- 2 lyukacsos szerszámtartó panel (C45PRO PF)
- 2 faliszekrény (C45PRO PM)
- 2 széles falikonzol (C45PRO SL)
- 1 keskeny falikonzol (C45PRO SS)
- 1 egyajtós szerszámos szekrény (C45PRO AS1)
- 7 fiókos rögzített modul és rétegelt fa munkalap (C45PRO M7A/W):
 - 1 fiók, 1248x406 mm
 - 6 fiók, 782x406 mm
 - 5 fiók, 65 mm magas
 - 1 fiók, 145 mm magas
- 1 ajtós, polcos tárolórekesz

■ 173,6 kg

C45PRO EW Ft 992.700 1 045000034



C45PRO CX

C45PRO műhelyberendezés összeállítás

Az összeállítás a következőkből áll:

- Rozsdamentes acéllal fedett MDF munkalap (C45PX/2-1.3MT)
- 7 fiókos rögzített modul (C45PRO M7)
- Rögzített kiszolgáló modul (C45PRO MS)
- Egyajtós szekrény (C45PRO AS1)
- 2 faliszekrény (C45PRO PM)
- 2 perforált szerszámtartó panel (C45PRO PF)
- 2 széles falikonzol (C45PRO SL)
- 1 keskeny falikonzol (C45PRO SS)

199 kg

C45PRO CX

Ft 1.029.400 1 045000023



C45PRO CW

C45PRO műhelyberendezés összeállítás

Az összeállítás a következőkből áll:

- Rétegelt lemez munkalap (C45PW/2-1.3MT)
- 7 fiókos rögzített modul (C45PRO M7)
- Rögzített kiszolgáló modul (C45PRO MS)
- Egyajtós szekrény (C45PRO AS1)
- 2 faliszekrény (C45PRO PM)
- 2 lyukacsos szerszámtartó panel (C45PRO PF)
- 2 széles falikonzol (C45PRO SL)
- 1 keskeny falikonzol (C45PRO SS)

198 kg

C45PRO CW

Ft 990.700 1 045000024



C45PRO BPX-1,3

munkapadok C45PRO műhelyberendezés összeállításához

Az összeállítás a következőkből áll:

- Rozsdamentes acéllal fedett MDF lap munkalap (C45PX/2-1.3MT)
- 7 fiókos rögzített modul (C45PRO M7)
- 5 fiókos rögzített modul (C45PRO M5)
- 2 lyukacsos szerszámtartó panel (C45PRO PF)
- 1 széles falikonzol (C45PRO SL)
- 2 keskeny falikonzol (C45PRO SS)

140 kg

C45PRO BPX-1,3

Ft 689.000 1 045000041



C45PRO BPW-1,3

munkapadok C45PRO műhelyberendezés összeállításához

Az összeállítás a következőkből áll:

- Rétegzett lemez munkalap (C45PW/2-1.3MT)
- 7 fiókos rögzített modul (C45PRO M7)
- 5 fiókos rögzített modul (C45PRO M5)
- 2 lyukacsos szerszámtartó panel (C45PRO PF)
- 1 széles falikonzol (C45PRO SL)
- 2 keskeny falikonzol (C45PRO SS)

139 kg

C45PRO BPW-1,3

Ft 650.300 1 045000051



C45PRO BPX-2,0

munkapadok C45PRO műhelyberendezés összeállításához

Az összeállítás a következőkből áll:

- Rozsdamentes acéllal fedett MDF lap munkalap (C45PX/3-2,0MT)
- 7 fiókos rögzített modul (C45PRO M7)
- 5 fiókos rögzített modul (C45PRO M5)
- 3 lyukacsos szerszámtartó panel (C45PRO PF)
- 2 széles falikonzol (C45PRO SL)
- 2 keskeny falikonzol (C45PRO SS)

158 kg

C45PRO BPX-2,0

Ft 778.000 1 045000042



C45PRO BPW-2,0

munkapadok C45PRO műhelyberendezés összeállításához

Az összeállítás a következőkből áll:

- Rétegzett lemez munkalap (C45PW/3-2,0MT)
- 7 fiókos rögzített modul (C45PRO M7)
- 5 fiókos rögzített modul (C45PRO M5)
- 3 lyukacsos szerszámtartó panel (C45PRO PF)
- 2 széles falikonzol (C45PRO SL)
- 2 keskeny falikonzol (C45PRO SS)

156 kg

C45PRO BPW-2,0

Ft 734.900 1 045000052



C45PRO M7A/X

7 fiókos rögzített modul a C45PRO műhelyberendezés összeállításához

- Rozsdamentes acéllal fedett MDF munkalap, 1360 mm hosszú
- 1 teleszkópos, csapágyazott fiók (1248x406 mm)
- 6 teleszkópos, csapágyazott fiók (782x406 mm):
5 fiók, 65 mm magas
1 fiók, 145 mm magas
- A fiókok habgumival bélelték
- Központi zár elől
- Függgőlegesen állítható talp
- Hőformált tálcák elhelyezhetők
- 1 tárolórekesz köztes polccal és ajtóval, belső méretek 504x424x597 mm

81 kg

C45PRO M7A/X Ft 516.400 1 045000161



h	max
65 mm	25 kg
105 mm	40 kg
145 mm	30 kg

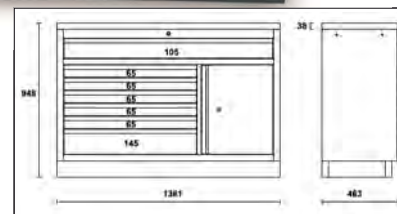

C45PRO M7A/W

7 fiókos rögzített modul a C45PRO műhelyberendezés összeállításához

- Rétegelt fa munkalap, 1360 mm hosszú,
- 1 teleszkópos, csapágyazott fiók (1248x406 mm)
- 6 teleszkópos, csapágyazott fiók (782x406 mm):
5 fiók, 65 mm magas
1 fiók, 145 mm magas
- A fiókok habgumival bélelték
- Központi zár elől
- Függgőlegesen állítható talp
- Hőformált tálcák elhelyezhetők
- 1 tárolórekesz köztes polccal és ajtóval, belső méretek 504x424x597 mm

80 kg

C45PRO M7A/W Ft 483.900 1 045000171



h	max
65 mm	25 kg
105 mm	40 kg
145 mm	30 kg

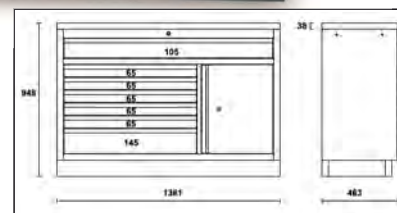

C45PRO MWS/X

7 fiókos szerszámkocsi beépített hulladéktartóval

- Rozsdamentes acéllal fedett MDF munkalap (1680 mm)
- 1 teleszkópos, csapágyazott fiók (1248x406 mm)
- 6 teleszkópos, csapágyazott fiók (782x406 mm):
5 fiók, 65 mm magas
1 fiók, 145 mm magas
- A fiókok habgumival bélelték
- Hőformált tálcák elhelyezhetők
- Tárolórekesz köztes polccal és ajtóval, belső méretek: 504x424x597mm
- Beépített hulladéktartó
- Beépített papírtekerstartó
- 4 robusztus forgókerék, Ø 150 mm (egy fékezhető)
- Központi zár elől

126 kg

C45PRO MWS/X Ft 669.900 1 045000181



h	max
65 mm	25 kg
105 mm	40 kg
145 mm	30 kg

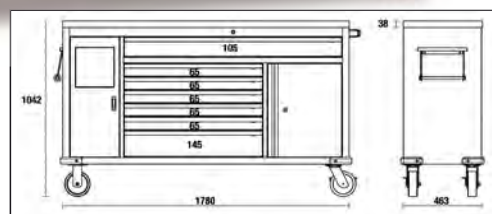

C45PRO MWS/W

7 fiókos szerszámkocsi beépített hulladékartóval

- Rétegelt lemez munkalap (1680 mm)
- 1 teleszkópos, csapágyazott fiók (1248x406 mm)
- 6 teleszkópos, csapágyazott fiók (782x406 mm):
5 fiók, 65 mm magas
1 fiók, 145 mm magas
- A fiókok habgumival bélelték
- Hőformált tálcák elhelyezhetők
- Tárolórekesz köztes polccal és ajtóval, belső méretek: 504x424x597mm
- Beépített hulladékartó
- Beépített papírtekercstartó
- 4 robusztus forgókerék, Ø 150 mm (egy fékezhető)
- Központi zár elöl

122 kg

C45PRO MWS/W Ft 652.900 1 045000191



h	max
65 mm	25 kg
105 mm	40 kg
145 mm	30 kg

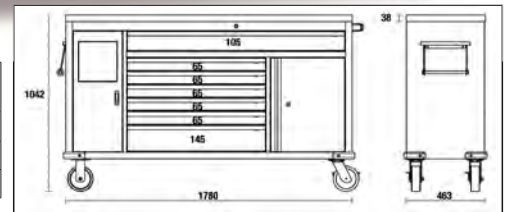

C45PX/1-0,7MT

rozsdamentes acéllal fedett MDF lap munkalap, 680x463 mm, a C45PRO műhelyberendezés összeállítás munkapadjához

- Vastagság: 38 mm

6 kg

C45PX/1-0,7MT Ft 65.900 1 045000101



C45PW/1-0,7MT

rétegelt fa munkalap, 680x463 mm, a C45PRO műhelyberendezés összeállítás munkapadjához

- Vastagság: 38 mm

6 kg

C45PW/1-0,7MT Ft 38.800 1 045000111



C45PX/2-1,3MT

rozsdamentes acéllal fedett MDF lap munkalap, 1360x463 mm, a C45PRO műhelyberendezés összeállítás munkapadjához

- Vastagság: 38 mm

21 kg

C45PX/2-1,3MT Ft 104.500 1 045000103



C45PW/2-1,3MT

rétegelt fa munkalap, 1360x463 mm, a C45PRO műhelyberendezés összeállítás munkapadjához

- Vastagság: 38 mm

20 kg

C45PW/2-1,3MT Ft 65.850 1 045000113



C45PX/3-2,0MT

rozsdamentes acéllal fedett MDF lap munkalap, 2040x463 mm, a C45PRO műhelyberendezés összeállítás munkapadjához

• Vastagság: 38 mm

31,8 kg

C45PX/3-2,0MT Ft 141.900 1 045000110



C45PW/3-2,0MT

rétegelt fa munkalap, 2040x463 mm, munkapadhoz, a C45PRO műhelyberendezés összeállításához

• Vastagság: 38 mm

30 kg

C45PW/3-2,0MT Ft 98.850 1 045000120



C45PRO C5

5 fiókos szerszámkocsi a C45PRO műhelyberendezés összeállításához

- 5 teleszkópos, csapágyazott fiók (532x406 mm)
- 4 forgókerék, Ø 100 mm (egy fékezhető)
- A fiókok habgumival bélelték
- Központi zár elöl
- Hőformált tálcák elhelyezhetők
- Keretbe épített fogantyúk a könnyebb kezelhetőség érdekében

46 kg

C45PRO C5 Ft 303.400 1 045000225

h	max
65 mm	25 kg
145 mm	30 kg

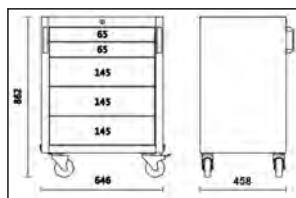
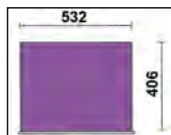

C45PRO C7

7 fiókos szerszámkocsi a C45PRO műhelyberendezés összeállításához

- 7 teleszkópos, csapágyazott fiók (532x406 mm)
- 4 forgókerék, Ø 100 mm (két fékezhető)
- A fiókok habgumival bélelték
- Központi zár elöl
- Hőformált tálcák elhelyezhetők
- Keretbe épített fogantyúk a könnyebb kezelésért

50 kg

C45PRO C7 Ft 257.200 1 045000227

h	max
65 mm	25 kg
145 mm	30 kg

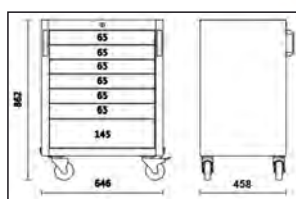
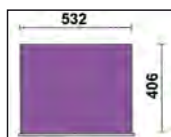

C45PRO M4

4 fiókos rögzített modul a C45PRO műhelyberendezés összeállításához

- 4 teleszkópos, csapágyazott fiók (566x406 mm)
- A fiókok habgumival bélelték
- Központi zár elöl
- Függetlenül állítható talp
- Hőformált tálcák elhelyezhetők

📦 45,7 kg

h	max
65 mm	25 kg
145 mm	30 kg
225 mm	30 kg

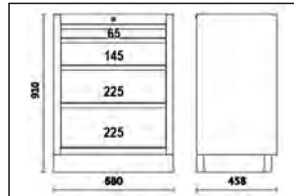
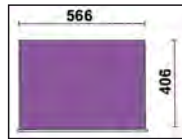

C45PRO M4

Ft 213.500 1 045000234

C45PRO M5

5 fiókos rögzített modul a C45PRO műhelyberendezés összeállításához

- 5 teleszkópos, csapágyazott fiók (566x406 mm)
- A fiókok habgumival bélelték
- Központi zár elöl
- Függetlenül állítható talp
- Hőformált tálcák elhelyezhetők

📦 49,3 kg

h	max
65 mm	25 kg
145 mm	30 kg

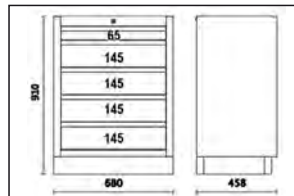
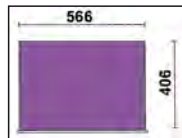

C45PRO M5

Ft 226.800 1 045000235

C45PRO M7

7 fiókos rögzített modul a C45PRO műhelyberendezés összeállításához

- 7 teleszkópos, csapágyazott fiók (566x406 mm)
- A fiókok habgumival bélelték
- Központi zár elöl
- Függetlenül állítható talp
- Hőformált tálcák elhelyezhetők

📦 54,3 kg

h	max
65 mm	25 kg
145 mm	30 kg

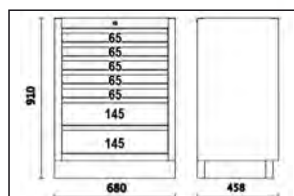

C45PRO M7



Ft 247.900 1 045000237

C45PRO M8

8 fiókos rögzített modul a C45PRO műhelyberendezés összeállításához

- 8 teleszkópos, csapágyazott fiók (566x406 mm)
- A fiókok habgumival bélelték
- Központi zár elöl
- Függetlenül állítható talp
- Hőformált tálcák elhelyezhetők

📦 56,5 kg

h		 max
65 mm		25 kg
145 mm		30 kg

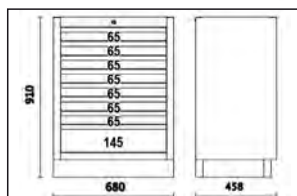
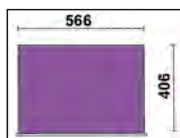

C45PRO M8

Ft  1  045000238

C45PRO MS

rögzített kiszolgáló modul a C45PRO műhelyberendezés összeállításához

- Beépített szemétkosár
- Papírtekercs tartó
- Függetlenül állítható talp

📦 37 kg

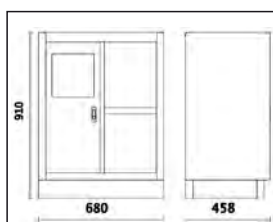

C45PRO MS

Ft  1  045000239

C45PRO RD

rögzített szelektív hulladéktároló modul a C45PRO műhelyberendezés összeállításához

Ideális megoldás szelektív hulladékgyűjtéshez (üveg, papír, műanyag...)

- Robosztus fémelem keret négy szelektív tároló felnyíló tetővel
- Mindegyik tároló tartalmaz:
 - egy-egy kivethető műanyag szemetest, űrtartalom: 25 l
 - 4 forgókerék, Ø 60 mm
- 4 színes ragasztószalag készlettel szállítva
- Függetlenül állítható talp

📦 80 kg

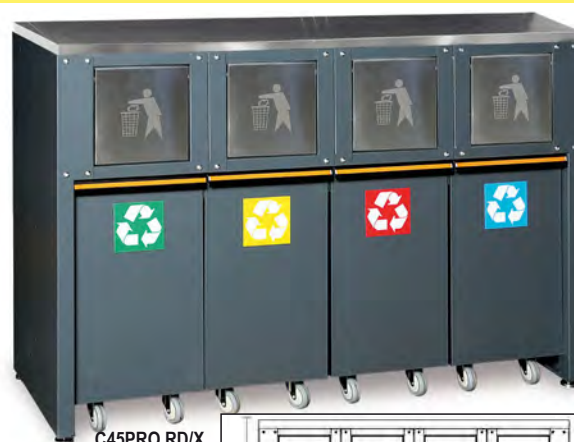





C45PRO RD/X

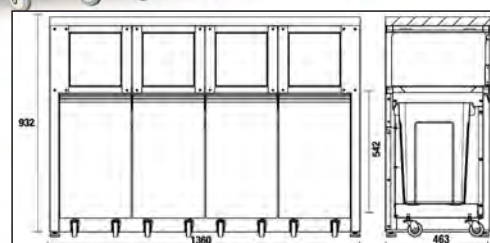

C45PRO RD/W



C45PRO RD/X Ft  1  045000241
 C45PRO RD/W Ft  1  045000240

C45PRO MA

kétajtós rögzített modul a C45PRO műhelyberendezés összeállításához

- Zárható
- Állítható magasságú belső polc
- Belső méret: 670x420 mm
- Fügőlegesen állítható talp

📦 29,4 kg

C45PRO MA Ft 125.000 1 045000232

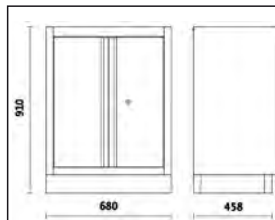

C45PRO M3A

3 fiókos, 2 ajtós rögzített modul a C45PRO műhelyberendezés összeállításához

- 3 teleszkópos, csapágyazott fiók (566x406 mm)
- A fiókok habgumival bélelték
- Hőformált tálcák elhelyezhetők
- Központi zár elöl
- Kétajtós, zárható, polcos tárolórekesz (belső méret: 670x440 mm)
- Fügőlegesen állítható talp

📦 40 kg

C45PRO M3A Ft 266.400 1 045000231

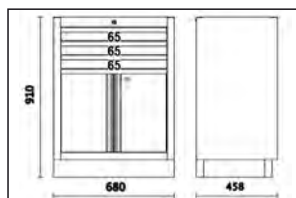
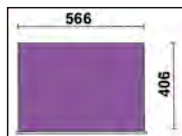
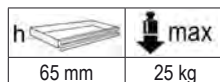

C45PRO ML

rögzített modul beépített mosdóval a C45PRO műhelyberendezés összeállításához

Műszaki jellemzők:

- Rozsdamentes acél mosdótál.
- Tartozékok:
 - 1 keverő csaptelep
 - 1 lefolyó
 - 1 dugó
 - 1 lefolyósűrő
 - 1 szappanadagoló

Rögzített zárható kétajtós modul:

- Belső méret: 600x603x416 mm
- Fügőlegesen állítható talp

📦 44 kg

C45PRO ML Ft 344.400 1 045000233

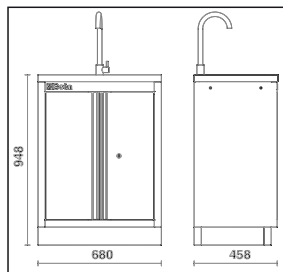

C45PRO ACT

3 fiókos rögzített modul 2 beépített dobbal a C45PRO műhelyberendezés összeállításához

- 3 teleszkópos, csapágyazott fiók (566x406 mm)
- A fiókok habgumival bélelték
- Központi zár elöl
- Függőlegesen állítható talp

Tartozékok:

47 kg

C45PRO ACT

Ft 340.100 1 045000247

h	max
65 mm	25 kg
145 mm	30 kg

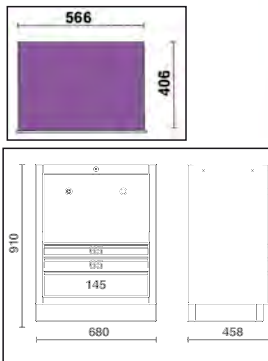

C45PRO TC

3 fiókos rögzített, dobtárolós modul a C45PRO műhelyberendezés összeállításához, üres

- 3 teleszkópos, csapágyazott fiók (566x406 mm)
- A fiókok habgumival bélelték
- Központi zár elöl
- Függőlegesen állítható talp

- Az alábbi dobpárokkal rendelhető:
 - 2 sűrített levegő vagy hidegvíz tömlődob, 8 mm, hossz 10 m 1900S modell, 8x10
- Az alábbi kábeldob párokkal rendelhető: 1843 15-H05, 1844 10-H05, 1844 15-H05, 1844 15-H07, 1845 12-H05, 1846 10-H05, 1846 10-H07 és 1846 15-H05
- 1 sűrített levegő vagy hidegvíz tömlődob, 8 mm, hossz 10 m 1900S modell, 8x10 és 1 kábeldob a fenti modellek közül

38 kg

C45PRO TC

Ft 198.700 1 045000249

h	max
65 mm	25 kg
145 mm	30 kg

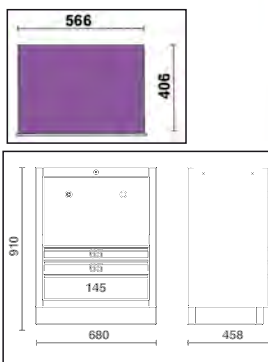

C45PRO T3

3 szintes szerszámkocsi a C45PRO műhelyberendezés

- A középső polc kétféleképpen is rögzíthető
- 4 forgókerék, Ø 100 mm (kettő fékezhető)
- Statikus terhelhetőség: 200 kg (3 polc között elosztva)

19,2 kg

C45PRO T3

Ft 142.300 1 045000250

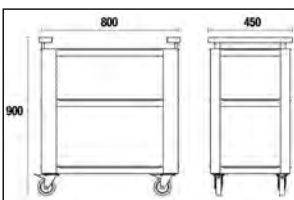

C45PRO SS

vékony oldalfal konzolok a C45PRO műhelyberendezés összeállításához

• Méret: 1420x32.5x30 mm

📦 1,5 kg



C45PRO SS Ft 9.470 1 045000333

C45PRO SL

széles oldalfal konzolok a C45PRO műhelyberendezés összeállításához

• Méret: 1420x65x30 mm

📦 2 kg



C45PRO SL Ft 12.350 1 045000366

C45PRO PAS

fali szerszámtartó rendszer a C45PRO műhelyberendezés

- Függgőlegesen mozgatható, zárral rendelkező alumínium redőny
- Két levehető, perforált szerszámtartó panel
- 1,3 méteres munkapadhoz társítható

📦 48,8 kg

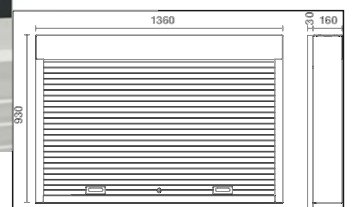

C45PRO PAS Ft 347.500 1 045000290

C45PRO PF

lyukacsos szerszámtartó panel C45PRO műhelyberendezés összeállításához

• Méret: 1052x614.5x24 mm

📦 5,3 kg



C45PRO PF Ft 39.250 1 045000313

C45PRO PFE

lyukacsos szerszámtartó panel C45PRO műhelyberendezés összeállításához

- Méret: 1052x614,5x24 mm
- Egy elektromos aljzattal bővíthető (az aljzat nem tartozék)

5,3 kg



C45PRO PFE

Ft 37.200 1 045000312

C45PRO CORNER/X

önálló teljes sarok a C45PRO műhelyberendezés összeállításához

- Fali sarokpolc gázrugókkal a könnyebb ajtónyitásért és zárásért
- 2 lyukacsos szerszámtartó panel (1052x860)
- Rozsdamentes acél sarok munkalap (860x860 mm)
- Alsó sarok modul nagy tárolórekeszsel
- Függetlenül állítható talp

94 kg

C45PRO CORNER/X

Ft 660.700 1 045000401

C45PRO CORNER/W

önálló teljes sarok a C45PRO műhelyberendezés összeállításához

- Zárható fali sarokpolc gázrugókkal a könnyebb ajtónyitásért és zárásért
- 2 lyukacsos szerszámtartó panel (1052x860 mm)
- Rétegzett fa munkalap, 860x860 mm,
- Alsó sarok modul nagy tárolórekeszsel
- Függetlenül állítható talp

93 kg

C45PRO CORNER/W

Ft 640.300 1 045000411



C45PRO CAI/X

alsó sarok modul a C45PRO műhelyberendezéshez

- Rozsdamentes acéllal fedett MDF sarok munkalap, 860x860 mm
- Rögzített sarok modul nagy tárolórecesszel
- Függgőlegesen állítható talp

62 kg

C45PRO CAI/X Ft 364.500 1 045000412



C45PRO CAI/W

alsó sarok modul a C45PRO műhelyberendezéshez

- Rétegzelt fa munkalap, 860x860 mm,
- Rögzített sarok modul nagy tárolórecesszel
- Függgőlegesen állítható talp

56 kg

C45PRO CAI/W Ft 344.100 1 045000402



C45PRO PM

faliszekrény a C45PRO műhelyberendezés összeállításához

- Szélesség: 680 mm
- Gázrugós megoldás az ajtó könnyebb nyitásához és zárásához
- Zárható

10 kg

C45PRO PM Ft 72.300 1 045000302

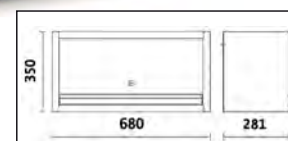

C45PRO PML

Széles faliszekrény a C45PRO műhelyberendezés összeállításához

- Faliszekrény szélessége: 1360 mm
- Gázrugós megoldás az ajtó könnyebb nyitásához és zárásához
- Zárható

18 kg

C45PRO PML Ft 159.600 1 045000303

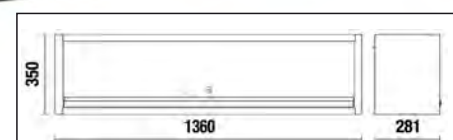

C45PRO AS1

egyajtós lemez szerszámszekrény C45PRO műhelyberendezés összeállításhoz,
konzolos

- 4 db kivehető, állítható magasságú polc
- Zárható
- Belső méret: 590x430 mm
- Függőlegesen állítható talp

📦 57,5 kg

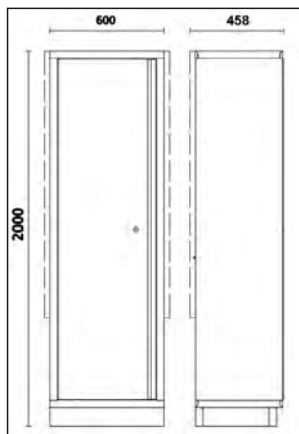

C45PRO AS1 Ft 263.900 1 045000451

C45PRO AS2

kétajtós lemez szerszámszekrény C45PRO műhelyberendezés összeállításhoz,
konzolos

- 4 db kivehető, állítható magasságú polc
- Zárható
- Belső méret: 910x430 mm
- Függőlegesen állítható talp

📦 80 kg

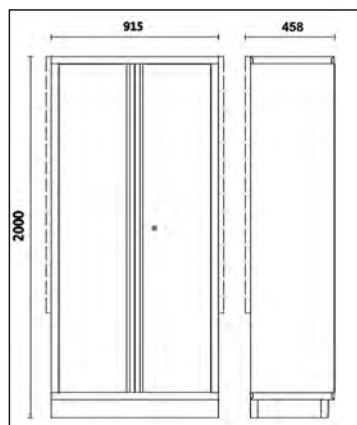

C45PRO AS2 Ft 419.200 1 045000481

C45STR

színes ragasztószalag a C45PRO műhelyberendezés összeállításhoz

- lehetővé teszi a C45PRO műhelyberendezés összeállítás vízszintes és függőleges elemeinek színekódolását



	L m	Ft	📦	🏷️
C45STR-O/2011	30	22.650	1	045000911
C45STR-G/9006	25	22.650	1	045000912
C45STR-R/3000	25	22.650	1	045000913
C45STR-B/5015	25	22.650	1	045000914
C45STR-Y/1023	25	22.650	1	045000915
C45STR-V/6029	25	22.650	1	045000916

TARTOZÉKOK RSC55 - C45PRO

C45LMP

LED lámpa C45PRO - RSC55
műhelyberendezés összeállításához

- Hossz: 630 mm
- Ragasztóval könnyen rögzíthető a faliszekrény alá
- KI/BE kapcsoló
- 570 lumen



307 g

C45LMP Ft 39.350 1 045000320

PM/5C

5-tálcás műanyag szerszámtároló
tartóval

- Tálca belső méretei: 95x120 mm
- C45PRO és RSC55 szerszámtartó falrendszerrel együtt használható

1,8 kg



PM/5C Ft 36.650 1 088880450

PM/6C

6-tálcás műanyag szerszámtároló
tartóval

- Tálca belső méretei: 80x60 mm
- C45PRO és RSC55 szerszámtartó falrendszerrel együtt használható

970 g



PM/6C Ft 28.400 1 088880440

CP

fali palacktartó acélállvány

- Fali szerszámtároló panelekkel együtt használható



CP Ft 38.950 1 088880470

SPC

számítógép falikonzol

- Az RSC55 és C45PRO fali szerszámtartó rendszerhez
- Méret: 398x243x138 mm



SPC Ft 30.950 1 088880480

SZERSZÁMKÉSZLETEK

ÖMLESZTETT SZERSZÁMOK

akasztók nélkül

akasztókkal

SZERSZÁMTÁLCÁK

puha, habszivacs

kemény, hőformált

RSC24A/6	RSC24/7	RSC24A/7	RSC24A/8
RSC24A/6	RSC24L/7	RSC24L-CAB	RSC24A/8
C37/6	C37/7	C37A/7	C39/7
C39/6	C39/7	C39/8	C37/8

Darab

				RSC22	RSC23	RSC23C	RSC23T	RSC24/5	RSC24/6	RSC24/7	RSC24A/7	RSC24/8	RSC24A/8	RSC24AXL/9	C25	C27S	RSC28	C30M	
akasztók nélkül	5902MT	Földmunkagépekhez	106	☐ 477	☐ 477	☐ 477													
	5902MT/AS	Földmunkagépekhez	99	☐ 478	☐ 478	☐ 478													
	5902VI	Ipari karbantartáshoz	107	☐ 443	☐ 443		☐ 443								☐ 443	☐ 443			
	5904VG/3	Autójavításhoz	132					☐ 481	☐ 481	☐ 481	☐ 481								
	5905VG/1	Autójavításhoz	94												☐ 484				
	5905VG/2	Autójavításhoz	118												☐ 485				
	5910VI/3	Ipari karbantartáshoz	297															☐ 447	
	5954VG	Autójavításhoz	138																
	5954VI	Ipari karbantartáshoz	133																
	5957U-P	Általános karbantartáshoz	133																
	5957VG	Autójavításhoz	174																
5957VI	Ipari karbantartáshoz	162																	
5958U	Általános karbantartáshoz	85																	
puha, habszivacs	5904VG/2M	Autójavításhoz	170				☐ 479	☐ 479	☐ 479	☐ 479	☐ 479	☐ 479	☐ 479					☐ 479	
	5904VU/1M	Általános karbantartáshoz	90				☐ 452	☐ 452	☐ 452	☐ 452	☐ 452	☐ 452	☐ 452					☐ 452	
	5904VU/2M	Általános karbantartáshoz	144				☐ 453	☐ 453	☐ 453	☐ 453	☐ 453	☐ 453	☐ 453					☐ 453	
	5927VU/M	Általános karbantartáshoz	108	☐ 463	☐ 463	☐ 463										☐ 463			
	5935ET/1MB	Elektrotechnika	96																
	5935VG/1MB	Autójavításhoz	98																
	5935VI/2MB	Ipari karbantartáshoz	133																
	5945VUM	Általános karbantartáshoz	231																
	5988H/7M	Motorkerékpárok és kerékpárok javítása	333										☐ 469	☐ 469				☐ 469	
	5988L/4M	Autójavításhoz	273					☐ 470	☐ 470	☐ 470	☐ 470	☐ 470	☐ 470						
	5988U6/M	Általános karbantartáshoz	214								☐ 471	☐ 471	☐ 471					☐ 471	
	5988U/7M	Általános karbantartáshoz	215				☐ 459	☐ 459	☐ 459	☐ 459	☐ 459	☐ 459	☐ 459					☐ 459	
	5988VHB-MQ	Elektrotechnikai	66				☐ 475	☐ 475	☐ 475	☐ 475	☐ 475	☐ 475	☐ 475					☐ 475	
	kemény, hőformált	5904VI/1T	Ipari karbantartáshoz	98				☐ 443	☐ 443	☐ 443	☐ 443	☐ 443	☐ 443	☐ 443					☐ 443
		5904VI/2T	Ipari karbantartáshoz	153				☐ 444			☐ 444	☐ 444	☐ 444	☐ 444					☐ 444
		5904VI/3T	Ipari karbantartáshoz	142									☐ 445	☐ 445					☐ 445
		5904VG/2T	Autójavításhoz	99				☐ 480	☐ 480	☐ 480	☐ 480	☐ 480	☐ 480	☐ 480					☐ 480
		5904VG/3T	Autójavításhoz	102				☐ 482	☐ 482	☐ 482	☐ 482	☐ 482	☐ 482	☐ 482					☐ 482
		5904VG/5T	Autójavításhoz	153				☐ 483		☐ 483	☐ 483	☐ 483	☐ 483	☐ 483					☐ 483
		5904VU/2T	Általános karbantartáshoz	104				☐ 454	☐ 454	☐ 454	☐ 454	☐ 454	☐ 454	☐ 454					☐ 454
		5904VU/3T	Általános karbantartáshoz	146				☐ 455	☐ 455	☐ 455	☐ 455	☐ 455	☐ 455	☐ 455					☐ 455
		5904VU/4T	Általános karbantartáshoz	197				☐ 456	☐ 456	☐ 456	☐ 456	☐ 456	☐ 456	☐ 456					
		5908VG/2T	Autójavításhoz	214															☐ 486
		5908VI/2T	Ipari karbantartáshoz	232									☐ 446	☐ 446					☐ 446
		5908VU/2T	Általános karbantartáshoz	161				☐ 457		☐ 457	☐ 457	☐ 457	☐ 457	☐ 457					☐ 457
		5910VG/3T	Autójavításhoz	202															☐ 487
		5910VI/3T	Ipari karbantartáshoz	261															☐ 448
		5938U/2T	Általános karbantartáshoz	210															

SZERSZÁMKÉSZLETEK

ÖMLESZTETT SZERSZÁMOK

akasztók nélkül

akasztókkal

SZERSZÁMTÁLCÁK

puha, habzivacs

kemény, hőformált

		Darab	C35	C38	C39MD C39SM	C39T	C45PRO	RSC51	C54S RSC55C	RSC55	RSC55PS RSC55PSE	C57SA C57SD	C57SB C57SP	C58P C45PRO PAS	C59A C59C	C59B
akasztók nélkül	5902MT	Földmunkagépekhez	106			☐ 477										
	5902MT/AS	Földmunkagépekhez	99			☐ 478										
	5902VI	Ipari karbantartáshoz	107													
	5904VG/3	Autójavításhoz	132							☐ 482					☐ 482	☐ 482
	5905VG/1	Autójavításhoz	94													
	5905VG/2	Autójavításhoz	118													
	5910VI/3	Ipari karbantartáshoz	297													
	5954VG	Autójavításhoz	138						☐ 491							
	5954VI	Ipari karbantartáshoz	133						☐ 451	☐ 451						
	5957U-P	Általános karbantartáshoz	133								☐ 465	☐ 465				
5957VG	Autójavításhoz	174								☐ 492	☐ 492					
5957VI	Ipari karbantartáshoz	162									☐ 450					
5958U	Általános karbantartáshoz	85				☐ 466			☐ 466	☐ 466			☐ 466			
puha, habzivacs	5904VG/2M	Autójavításhoz	170		☐ 479	☐ 479				☐ 479					☐ 479	☐ 479
	5904VU/1M	Általános karbantartáshoz	90		☐ 452	☐ 452		☐ 452		☐ 452					☐ 452	☐ 452
	5904VU/2M	Általános karbantartáshoz	144		☐ 453	☐ 453				☐ 453					☐ 453	☐ 453
	5927VU/M	Általános karbantartáshoz	108													
	5935ET/1MB	Elektrotechnika	96	☐ 472												
	5935VG/1MB	Autójavításhoz	98	☐ 488												
	5935VI/2MB	Ipari karbantartáshoz	133	☐ 449												
	5945VUM	Általános karbantartáshoz	231		☐ 490		☐ 490									
	5988H/7M	Motorkerékpárok és kerékpárok javítása	333								☐ 469					☐ 469
	5988L/4M	Autójavításhoz	273		☐ 470	☐ 470					☐ 470				☐ 470	☐ 470
	5988U6/M	Általános karbantartáshoz	214		☐ 471						☐ 471					☐ 471
	5988U/7M	Általános karbantartáshoz	215		☐ 459						☐ 459				☐ 459	☐ 459
	5988VHB-MQ	Elektrotechnikai	66		☐ 475	☐ 475		☐ 475			☐ 475				☐ 475	☐ 475
	5904VI/1T	Ipari karbantartáshoz	98		☐ 443	☐ 443		☐ 443			☐ 443				☐ 443	☐ 443
	5904VI/2T	Ipari karbantartáshoz	153		☐ 444						☐ 444				☐ 444	☐ 444
	5904VI/3T	Ipari karbantartáshoz	142		☐ 445						☐ 445					☐ 445
	5904VG/2T	Autójavításhoz	99		☐ 480	☐ 480		☐ 480			☐ 480				☐ 480	☐ 480
	5904VG/3T	Autójavításhoz	102		☐ 482	☐ 482					☐ 482				☐ 482	☐ 482
	5904VG/5T	Autójavításhoz	153		☐ 483						☐ 483				☐ 483	☐ 483
	5904VU/2T	Általános karbantartáshoz	104		☐ 454	☐ 454					☐ 454				☐ 454	☐ 454
5904VU/3T	Általános karbantartáshoz	146		☐ 455	☐ 455					☐ 455				☐ 455	☐ 455	
5904VU/4T	Általános karbantartáshoz	197		☐ 456	☐ 456					☐ 456				☐ 456	☐ 456	
5908VG/2T	Autójavításhoz	214														
5908VI/2T	Ipari karbantartáshoz	232													☐ 446	
5908VU/2T	Általános karbantartáshoz	161		☐ 457						☐ 457				☐ 457	☐ 457	
5910VG/3T	Autójavításhoz	202														
5910VI/3T	Ipari karbantartáshoz	261														
5938U/2T	Általános karbantartáshoz	210		☐ 464												

5902VI

107 darabos szerszámkészlet

► Ipari karbantartás

Mennyiség/megnevezés

- 6 hosszú kiütő Ø 2 - 3 - 4 - 5 - 6 - 8 mm
- 1 pontozó Ø 3 mm
- 1 erősített laposvágó 200 mm
- 26 csillag-villáskulcsok 6÷32 mm
- 12 villáskulcs 6x7 - 8x9 - 10x11 - 12x13 - 14x15 - 16x17 - 18x19 - 20x22 - 21x23 - 24x26 - 25x28 - 30x32 mm
- 9 imbuszkulcs Ø 1,5 - 2 - 2,5 - 3 - 4 - 5 - 6 - 8 - 10 mm
- 1 Állítható villáskulcs 300 mm
- 13 1/2" - os hatlapú dugókulcs Ø 10÷22 mm
- 1 1/2"-os toldó 125 mm
- 1 1/2"-os toldó 255 mm
- 1 1/2"-os csukló
- 1 1/2"-os csúszkás T-hajtószár
- 1 1/2"-os irányváltós racsnit
- 1 vízpumpafogó 250 mm
- 1 Egyenes pófájú önzáró fogó 240 mm
- 1 erősített oldalcsípőfogó, kétkomponensű markolat ipari kivitel 160 mm
- 1 áttételes egyenes lemezolló 250 mm
- 1 műszerész olló
- 1 robusztus kombinált fogó kétkomponensű markolat ipari kivitel 180 mm
- 1 egyenes extra hosszú félkerékcsőrű fogó, kétkomponensű markolat ipari kivitel 160 mm
- 8 csavarhúzó hasítottfejű csavarokhoz ● 2,5x50 - 3x75 - 3,5x100 - 4x125 - 5,5x125 - 6,5x150 - 8x200 - 10x200 mm
- 4 Phillips®-csavarhúzó ● PH0x60 - PH1x80 - PH2x100 - PH3x150 mm
- 1 lakatos kalapács 500 g
- 1 ütéselnyelő műanyag kalapács Ø 40 mm
- 1 rajztű
- 1 fékes mérőszalag 5 m
- 1 Hézagmérő
- 5 5 darabos egyengető reszelő készlet markolattal 200 mm
- 1 fűrész
- 1 Olajozó fémkanna 300 cc
- 1 dekorkés
- 1 Mágneses flexibilis lámpa, intenzív fényű LED-ekkel, robusztus eloxált alumíniumból, 500 lumen

Beta-sz.

- 31
- 32
- 35
- 42/S26
- 55/S12
- 96N/SC9
- 111E
- 920A/SB13
- 920/21
- 920/22
- 920/25
- 920/42
- 920/55
- 1048N
- 1052
- 1084GBM
- 1122
- 1128BMX
- 1150GBM
- 1166GBM
- 1260
- 1262
- 1370
- 1392
- 1688A
- 1692
- 1708/20
- 1719BMA...S5
- 1726BM
- 1751N
- 1771BM
- 1837F

Ft



5902VI 601.200 059021060

Készletársítási javaslat RSC22 - RSC23 - RSC23T - C25 - C27S

5904VI/1T

98 darabos szerszámkészlet ABS hőformált tálcában

► Ipari karbantartás

Mennyiség/megnevezés

- 19 1/2"-os hatlapú dugókulcs Ø 10÷24 - 26 - 27 - 30 - 32 mm
- 5 1/2"-os imbusz dugókulcs Ø 5 - 6 - 8 - 10 - 12 mm
- 1 1/2"-os toldó 125 mm
- 1 1/2"-os toldó 255 mm
- 1 1/2"-os csukló
- 1 1/2"-os csúszkás T-hajtószár
- 1 1/2"-os irányváltós racsnit
- 16 csillag-villáskulcsok 6÷21 mm
- 5 csillag-villáskulcsok 22-24-27-30-32 mm
- 1 vízpumpafogó 250 mm
- 1 Egyenes pófájú önzáró fogó 240 mm
- 1 Erősített oldalcsípőfogó 160 mm
- 1 kombinált fogó 180 mm
- 1 Egyenes extra hosszú félkerékcsőrű fogó 160 mm
- 1 egyenes belső Seeger-fogó 180 mm
- 1 hajlított belső Seeger - fogó 170 mm
- 1 egyenes külső Seeger-fogó 175 mm
- 1 hajlított külső Seeger - fogó 175 mm
- 2 erősített laposvágó 100 - 200 mm
- 5 reszelő 200 mm
- 1 lakatos kalapács 300 g
- 1 műanyag kalapács Ø 35 mm
- 8 villáskulcsok 6x7 - 8x9 - 10x11 - 12x13 - 14x15 - 16x17 - 18x19 - 20x22 mm
- 9 imbuszkulcsok Ø 1,5 - 2 - 2,5 - 3 - 4 - 5 - 6 - 8 - 10 mm
- 4 csavarhúzó hasítottfejű csavarokhoz ● 3x75 - 4x100 - 5,5x150 - 6,5x150 mm
- 3 Phillips®-csavarhúzó ● PH0x60 - PH1x80 - PH2x100 mm
- 6 T-szárú imbuszkulcsok Ø 2,5 - 3 - 4 - 5 - 6 - 8 mm

Beta-sz.

TR

- 920A T80
- 920ME T80
- 920/21 T80
- 920/22 T80
- 920/25 T80
- 920/42 T80
- 920/55 T80
- 42 T05
- 42 T06
- 1048N T153
- 1052 T153
- 1084 T138
- 1150 T138
- 1166 T138
- 1032 T145
- 1034 T145
- 1036 T145
- 1038 T145
- 35 T234
- 1719BMA8/S5 T236
- 1370 T234
- 1390 T234
- 55 T33
- 96/SC9 T33
- 1260 T208
- 1262 T208
- 951 T68

Ft



5904VI/1T 519.300 059041161

Készletársítási javaslat RSC51 - RSC23T - RSC24 - RSC24L/7 - RSC24L-CAB
RSC24A - RSC24AXL - RSC28 - C37 - C39 6 - 7 - 8 fiókkal - C39MD - C39SM - C39T - RSC50 - RSC55 - C59

5904VI/2T

153 darabos szerszámkészlet ABS hőformált tálcában

► Ipari karbantartás

Mennyiség/megnevezés

- 16 csillag-villáskulcs 6÷21 mm
- 5 csillag-villáskulcs 22 - 24 - 27 - 30 - 32 mm
- 5 hosszú kiütő Ø 2 - 3 - 4 - 5 - 6 mm
- 1 pontozó Ø 4 mm
- 12 villáskulcs 6x7 - 8x9 - 10x11 - 12x13 - 14x15 - 16x17
18x19 - 20x22 - 21x23 - 24x26 - 27x29 - 30x32 mm
- 9 imbuszkulcs Ø 1,5 - 2 - 2,5 - 3 - 4 - 5 - 6 - 8 - 10 mm
- 7 hajlított csillagkulcs 6÷29 mm
- 19 1/2"-os hatlapú dugókulcs Ø 10÷24 - 26 - 27 - 30 - 32 mm
- 1 1/2"-os toldó 125 mm
- 1 1/2"-os toldó 255 mm
- 1 1/2"-os csukló
- 1 1/2"-os csúszkás T-hajtósár
- 1 1/2"-os irányváltós racsni
- 13 1/4"-os hatlapú dugókulcs Ø 4÷14 mm
- 6 1/4"-os imbusz-dugókulcs Ø 2,5÷8 mm
- 1 1/4"-os toldó 50 mm
- 1 1/4"-os toldó 150 mm
- 1 1/4"-os csukló
- 1 1/4"-os hajtósár
- 1 1/4"-os csúszkás T-hajtósár
- 1 1/2"-os irányváltós racsni
- 9 csavarhúzó hasítottfejű csavarokhoz ● 3x75 - 3x100 - 4x100 - 4x150 - 5,5x100 - 5,5x150 -
6,5x150 - 8x150 - 10x200 mm
- 2 Lapos törpe csavarhúzó ● 4x30 - 6,5x30 mm
- 7 Phillips®-csavarhúzó ● PH0x60 - PH0x100 - PH1x80 - PH1x120 - PH2x100 - PH2x150 -
PH3x150 mm
- 2 Csavarhúzó Phillips® - csavarokhoz, extra rövid penge ● PH1x30 - PH2x30 mm
- 1 vízpumpafogó 250 mm
- 1 Egyenes pófájú önzáró fogó 240 mm
- 1 Erősített oldalcsípőfogó 160 mm
- 1 Egyenes extra hosszú félkerécsőrű fogó ● 160 mm
- 1 kombinált fogó = 180 mm
- 1 egyenes belső Seeger-fogó ○ 180 mm
- 1 hajlított belső Seeger - fogó ○ 170 mm
- 1 egyenes külső Seeger-fogó ● 175 mm
- 1 hajlított külső Seeger - fogó ● 175 mm
- 6 T-szárú imbuszkulcs Ø 2,5 - 3 - 4 - 5 - 6 - 8 mm
- 5 reszelő 200 mm
- 2 erősített laposvágó 100 - 200 mm
- 1 lakatos kalapács 300 g
- 1 műanyag kalapács Ø 35 mm
- 1 Popszegecshúzó
- 100 alumínium popszegecs 2,9x6 mm
- 100 alumínium popszegecs 3,2x8 mm
- 100 alumínium popszegecs 3,8x10 mm
- 100 alumínium popszegecs 4x12 mm
- 100 alumínium popszegecs 4,8x12 mm
- 1 fékes mérőszalag
- 1 Mini fűrész
- 1 Olajozó műanyag flakon
- 1 dekorkés

Beta-sz.	TR
42	T05
42	T06
31	T31
32	T31
55	T31
96N/SC9	T31
90	T40
920A	T83
920/21	T83
920/22	T83
920/25	T83
920/42	T83
920/55	T83
900	T91
900ME	T91
900/20	T91
900/21	T91
900/25	T91
900BG/30	T91
900/42	T91
900/55	T91
1260	T167
1260N	T167
1262	T168
1262N	T168
1048N	T153
1052	T153
1084	T138
1166	T138
1150	T138
1032	T145
1034	T145
1036	T145
1038	T145
951	T68
1719BMA8/S5	T236
35	T234
1370	T234
1390	T234
1741B	T281
1741RV...K	T281
1741RV...K	T281
1741RV...K	T281
1741RV...K	T281
1741RV...K	T281
1692	T289
1725CR	T289
1755	T289
1771	T289



T05 T06 T31



T40 T83 T91



T167 T168



T153 T138 T145 T68



T236 T234 T281 T289

Ft

5904VI/2T

736.900 059041164

Készletlétszámjavaslat RSC23T - RSC24 7 - 8 fiókkal - RSC24A 7 - 8 fiókkal - RSC24AXL - RSC24L/7 - RSC24L-CAB - RSC28 - C37 7 - 8 fiókkal - C39 7 - 8 fiókkal - C39MD - C39SM - C59 - RSC50 - RSC55

5904VI/3T

142 darabos szerszámkészlet ABS hőformált tálcában

► Ipari karbantartás

Mennyiség/megnevezés

- 16 csillag-villáskulcs 6+21 mm
- 5 csillag-villáskulcs 22 - 24 - 27 - 30 - 32 mm
- 5 hosszú kiütő Ø 2 - 3 - 4 - 5 - 6 mm
- 1 pontozó Ø 4 mm
- 12 villáskulcs 6x7 - 8x9 - 10x11 - 12x13 - 14x15 - 16x17 - 18x19 - 20x22 - 21x23 - 24x26 - 27x29 - 30x32 mm
- 9 imbuszkulcs 1,5 - 2 - 2,5 - 3 - 4 - 5 - 6 - 8 - 10 mm
- 9 csavarhúzó hasítottfejű csavarokhoz ● 3x75 - 3,5x100 - 4x100 - 4x150 - 5,5x100 - 5,5x150 - 6,5x150 - 8x150 - 10x200 mm
- 2 Lapos törpe csavarhúzó ● 4x30 - 6,5x30 mm
- 6 Phillips®-csavarhúzó ● PH0x60 - PH0x100 - PH1x80 - PH1x120 - PH2x100 - PH2x150 mm
- 7 Imbusz csavarhúzó Torx®-csavarokhoz ● T6-T7-T8-T9-T10-T15-T20
- 5 1/2"-os imbusz dugókulcs ○ 5 - 6 - 8 - 10 - 12 mm
- 1 1/2"-os toldó 125 mm
- 1 1/2"-os toldó 255 mm
- 1 1/2"-os csukló
- 1 1/2"-os csúszkás T-hajtósár
- 1 1/2"-os irányváltós racsni ⊗
- 19 1/2"-os hatlapú dugókulcs ○ 10+24 - 26 - 27 - 30 - 32 mm
- 8 Erősített tizenkétszögű csókulcs 6x7 - 8x9 - 10x11 - 12x13 - 14x15 - 16x17 - 18x19 - 20x22 mm
- 1 hajtósár
- 1 hajtósár
- 6 T-szerű imbuszkulcs ○ 2,5 - 3 - 4 - 5 - 6 - 8 mm
- 1 kombinált fogó = 180 mm
- 1 Egyenes extra hosszú félkerékcsőrű fogó ● 160 mm
- 1 Erősített oldalcsípőfogó ⊥ 160 mm
- 1 vízpumpafogó 250 mm
- 1 Egyenes pófajú önzáró fogó 240 mm
- 1 egyenes belső Seeger-fogó ○ 180 mm
- 1 hajlított belső Seeger - fogó ○ 170 mm
- 1 egyenes külső Seeger-fogó ● 175 mm
- 1 hajlított külső Seeger - fogó ● 175 mm
- 1 egyenes belső Seeger-fogó ○ 140 mm
- 1 hajlított belső Seeger - fogó ○ 225 mm
- 1 egyenes külső Seeger-fogó ● 140 mm
- 1 hajlított külső Seeger - fogó ● 225 mm
- 1 lakatos kalapács 400 g
- 1 műanyag kalapács Ø 35 mm
- 1 reszelő 200 mm
- 1 reszelő 200 mm
- 1 reszelő 200 mm
- 1 tolómérő
- 1 Rugalmas skálás vonalzó 300 mm
- 1 5 m
- 1 Popszegecs húzó 250 mm
- 100 alumínium popszegecs 2,9x6 mm
- 100 alumínium popszegecs 3,2x8 mm
- 100 alumínium popszegecs 3,8x10 mm
- 100 alumínium popszegecs 4x12 mm
- 100 alumínium popszegecs 4,8x12 mm
- 1 bádogos lemezolló 250 mm
- 1 Egyenes élű műszerész olló
- 1 fűrész
- (5) fűrészlap
- 1 Olajozó műanyag anna 200 cc hőformált szerszámtartó

Beta-sz.	TR
42	T05
42	T06
31	T31
32	T31
55	T31
96N/SC9	T31
1260	T167
1260N	T167
1262	T202
1267TX	T205
920ME	T80
920/21	T80
920/22	T80
920/25	T80
920/42	T80
920/55	T80
920A	T80
930	T73
940/1	T73
940/2	T73
951	T68
1150BM	T137
1166BM	T137
1084BM	T137
1048N	T153
1052	T153
1032	T145
1034	T145
1036	T145
1038	T145
1032	T146
1034	T146
1036	T146
1038	T146
1370	T231
1390	T231
1719BMA8/T	T231
1719BMA8/P	T231
1719BMA8/M	T231
1651DGT	T297
1682	T297
1691BM	T297
1741B	T281
1741RV..K	T281
1741RV..K	T281
1741RV..K	T281
1741RV..K	T281
1741RV..K	T281
1112	T285
1128BM	T285
1726	T285
1728BM	T285
1753	T285
VP6	VP6



T05 T06 T31



T167 T202 T205



T80 T73 T68



T137 T153 T145 T146



T231 T297 T281



T285 VP6

Ft

5904VI/3T 873.300 059041168

Készletválasztási javaslat RSC24 8 fiókkal - RSC24A 8 fiókkal - C37 8 fiókkal - C39 8 fiókkal
RSC24AXL 8 fiókkal - RSC28 - C39MD - C39SM - RSC50 - RSC55 - C59B

5908VI/2T

232 darabos szerszámkészlet ABS hőformált tálcában

► Ipari karbantartás

Mennyiség/megnevezés

- 5 1/2"-os imbusz dugókulcs \odot 5 - 6 - 8 - 10 - 12 mm
- 1 1/2"-os toldó 125 mm
- 1 1/2"-os toldó 255 mm
- 1 1/2"-os csukló
- 1 1/2"-os csúszkás T-hajtószár
- 1 1/2"-os irányváltós racsni \oplus
- 19 1/2"-os hatlapú dugókulcs \odot 10+24 - 26 - 27 - 30 - 32 mm
- 16 csillag-villáskulcs 6+21 mm
- 5 csillag-villáskulcs 22 - 24 - 27 - 30 - 32 mm
- 13 1/4"-os hatlapú dugókulcs \odot 4+14 mm
- 6 1/4"-os imbusz-dugókulcs \odot 2,5 - 3 - 4 - 5 - 6 - 8 mm
- 1 1/4"-os toldó 50 mm
- 1 1/4"-os toldó 150 mm
- 1 1/4"-os hajtószár
- 1 1/4"-os csukló
- 1 1/4"-os csúszkás T-hajtószár
- 1 1/2"-os irányváltós racsni \oplus
- 6 T-szerű imbuszkulcs \odot 2,5 - 3 - 4 - 5 - 6 - 8 mm
- 7 hajlított csillagkulcs 6x7-8x9-10x11-12x13-14x15-16x17-18x19 mm
- 5 hajlított csillagkulcs 20x22 - 21x23 - 24x26 - 25x28 - 27x29 mm
- 7 csavarhúzó hasítottfejű csavarokhoz \bullet 2,5x50 - 3x75 - 3,5x100 - 4x125 - 5,5x100 - 5,5x150 - 6,5x150 mm
- 6 Phillips®-csavarhúzó \oplus PH0x60 - PH0x100 - PH1x80 - PH1x120 - PH2x100 - PH2x150 mm
- 3 csavarhúzó hasítottfejű csavarokhoz \bullet 8x200 - 10x150 - 10x200 mm
- 2 Lapos törpe csavarhúzó \bullet 4x30 - 6,5x30 mm
- 2 Phillips®-csavarhúzó \oplus PH3x150 - PH4x200 mm
- 2 Csavarhúzó Phillips® - csavarokhoz, extra rövid penge \oplus PH1x30 - PH2x30 mm
- 2 erősített laposvágó 100 - 200 mm
- 1 lakatos kalapács 300 g
- 1 műanyag kalapács \varnothing 35 mm
- 1 Popszegecshúzó 250 mm
- 100 alumínium popszegecs 2,9x6 mm
- 100 alumínium popszegecs 3,2x8 mm
- 100 alumínium popszegecs 3,8x10 mm
- 100 alumínium popszegecs 4x12 mm
- 100 alumínium popszegecs 4,8x12 mm
- 1 vízpumpafogó 250 mm
- 1 Egyenes pófájú önzáró fogó 240 mm
- 5 darabos egyengető reszelő készlet markolattal 200 mm
- 1 egyenes belső Seeger-fogó \odot 180 mm
- 1 hajlított belső Seeger - fogó \odot 170 mm
- 1 egyenes külső Seeger-fogó \bullet 175 mm
- 1 hajlított külső Seeger - fogó \bullet 175 mm
- 1 kombinált fogó \equiv 180 mm
- 1 Egyenes extra hosszú félkerékcserő fogó \bullet 160 mm
- 1 Erősített oldalcsípőfogó ∇ 160 mm
- 5 hosszú kiütő \varnothing 2 - 3 - 4 - 5 - 6 mm
- 1 pontozó \varnothing 4 mm
- 12 villáskulcs 6x7 - 8x9 - 10x11 - 12x13 - 14x15 - 16x17 - 18x19 - 20x22 - 21x23 - 24x26 - 27x29 - 30x32 mm
- 9 imbuszkulcs \odot 1,5 - 2 - 2,5 - 3 - 4 - 5 - 6 - 8 - 10 mm
- 1 bádogos lemezolló 250 mm
- 1 Egyenes élű műszerész olló
- 1 fűrész
- 5 fűrészlap
- 1 Olajozó műanyag anna 200 cc
- 1 hőformált szerszámtartó
- 1 menetfúró hajtóvas M3+M12
- 1 menetfúró hajtóvas M5+M21
- 1 racsni hajtóvas 2,0+5,0 mm (M3+M8)
- 1 racsni hajtóvas 4,6+8,0 mm (M5+M12)
- 1 menetmetsző hajtóvas 25,4 mm
- 1 menetmetsző hajtóvas 38,1 mm
- 1 Menetsablon 0,25+6 W 62+4x1"
- 26 menetfúró M3 - 4 - 5 - 6 - 7 - 8 - 9 - 10 - 12 - 14 - 16 - 18 - 20
- 14 finom menetfúró M6x0,75 - M8x1 - M10x1,25
- M12x1,5 - M14x1,5 - M16x1,5 - M18x1,5
- 7 menetmetsző M3 - 4 - 5 - 6 - 7 - 8 - 9
- 6 menetmetsző M10 - 12 - 14 - 16 - 18 - 20
- 2 finom menetmetsző M6x0,75 - M8x0,75
- 5 finom menetmetsző M10x1,25 - M12x1,5 - M14x1,5 - M16x1,5 - M18x1,5

Beta-sz.	TR
920ME	T80
920/21	T80
920/22	T80
920/25	T80
920/42	T80
920/55	T80
920A	T80
42	T05
42	T06
900	T91
900ME	T91
900/20	T91
900/21	T91
900BG/30	T91
900/25	T91
900/42	T91
900/55	T91
951	T68
90	T40
90	T41
1260	T199
1262	T202
1260	T201
1260N	T201
1262	T204
1262N	T204
35	T234
1370	T234
1390	T234
1741B	T281
1741RV...K	T281
1741RV...K	T281
1741RV...K	T281
1741RV...K	T281
1741RV...K	T281
1048N	T153
1052	T153
1719BMA...S5	T236
1032	T145
1034	T145
1036	T145
1038	T145
1150BM	T137
1166BM	T137
1084BM	T137
31	T31
32	T31
55	T31
96N/SC9	T31
1112	T285
1128BM	T285
1726	T285
1728BM	T285
1753	T285
VP5	VP5
435/1,5	T273
435/3	T273
436/1	T273
436/2	T273
444/1	T273
444/2	T273
1707	T273
430	T270
433	T270
440	T270
440A	T270
441	T270
441A	T270



T80 T05 T06



T91 T68 T40 T41



T199 T202 T201 T204



T234 T281 T153 T236



T145 T137 T31



T285 VP5



T273 T270

Ft

5908VI/2T 1.142.800 059081105

Készletlétartási javaslat RSC28 - RSC24/8 - RSC24A/8 - RSC24AXL 8-9 fiókkal - C37/8 - C39/8 - C59B

5910VI/3

297 darabos szerszámkészlet



► Ipari karbantartás

Mennyiség/megnevezés	Beta-sz.
6 6 darabos kiütőkészlet tartós poliészterből készült összetekkerhető tokban Ø 2 - 3 - 4 - 5 - 6 - 8 mm	31/B6N
1 pontozó Ø 4 mm	32
2 erősített laposvágó 125 - 250 mm	35
1 erősített keresztvágó 200 mm	37
30 csillag-villáskulcs 6-7-8-9-10-11-12-13-14-15-16-17-18-19-20-21-22-23-24-25-26-27-28-29-30-32-35-36-38-41 mm	42
14 villáskulcs 6x7 - 8x9 - 10x11 - 12x13 - 14x15 - 16x17 - 18x19 - 20x22 - 21x23 - 24x26 - 25x28 - 27x29 - 30x32 - 36x41 mm	55
13 hajlított csillagkulcs 6x7+30x32 mm	90
14 imbuszkulcs Ø 1,5 - 2 - 2,5 - 3 - 4 - 5 - 6 - 8 - 10 - 12 - 13 - 14 - 17 - 19 mm	96N
1 Állítható villáskulcs 250 mm	111E
1 Amerikai csőfogó 300 mm	362
25 Rövid csigafúró hengeres szárral 1+13x0,5 mm	412/SP25
37 HSS menetfúró és menetmetsző készlet	447/C37
1 kioldó nyomatékkulcs irányváltós racsnival @ 1/2", 40+200 Nm	666N/20
1 1/2"-os csuklós T-hajtószár	920/40
4 1/2"-os imbusz dugókulcs Ø 10-12-14-17 mm	920ME
25 20 dugókulcs és 5 tartozék fémdobozban	920A/C20X
17 12 dugókulcs és 5 tartozék 3/4"	928A/C12
12 tizenkétszögű pipakulcs 8 - 10 - 11 - 13 - 14 - 17 - 19 - 22 - 24 - 27 - 30 - 32 mm	932
14 T-szárú imbuszkulcs 2+14 mm	951/S14
5 csuklós T - imbuszkulcs Ø 3 - 4 - 5 - 6 - 8 mm	953
3 egyenes belső Seeger-fogó Ø 180 - 225 - 300 mm	1032
3 hajlított belső Seeger - fogó Ø 170 - 210 - 290 mm	1034
3 egyenes külső Seeger-fogó Ø 140x1,3 - 175 - 225 mm	1036
3 hajlított külső Seeger - fogó Ø 135x1,3 - 175 - 220 mm	1038
2 vízpumpafogó 250 - 300 mm	1048N
1 kettős állítású önzáró fogó	1051
1 erősített oldalcsípőfogó, kétkomponensű markolat ipari kivitel 160 mm	1084GBM
1 áttételes homlokcsípőfogó 180 mm	1092V
1 bádogos lemezolló 300 mm	1112
1 Bádogos olló amerikai modell 250 mm	1114
1 műszerész olló	1128BMX
1 robusztus kombinált fogó kétkomponensű markolat ipari kivitel 180 mm	1150GBM
1 egyenes extra hosszú félkerékcsőrű fogó, kétkomponensű markolat ipari kivitel 160 mm	1166GBM
1 hajlított extra hosszú félkerékcsőrű fogó, kétkomponensű markolat ipari kivitel 160 mm	1168GBM
9 csavarhúzó hasítottfejű csavarokhoz ● 2,5x50 - 3x75 - 3,5x150 - 4x125 - 5,5x125 - 6,5x150 - 8x200 - 10x200 - 12x250 mm	1260
2 Lapos törpe csavarhúzó ● 4x30 - 6,5x30 mm	1260N
5 Phillips®-csavarhúzó ● PH0x100 - PH1x120 - PH2x150 - PH3x150 - PH4x200 mm	1262
2 Csavarhúzó Phillips® - csavarokhoz, extra rövid penge ● PH1x30 - PH2x30 mm	1262N
7 Imbusz csavarhúzó Torx®-csavarokhoz ○ T6 - T8 - T10 - T15 - T20 - T25 - T30	1267TX
2 lakatos kalapács 300 - 600 g	1370
2 műanyag kalapács Ø 35 - 60 mm	1390
5 Törtcsavarkiszedő M3+M18	1430/S5
1 Kétkörmös univerzális csapáglehúzó 23+70 mm	1500N/1
1 Kétkörmös univerzális csapáglehúzó 23+100 mm	1500N/2
1 tolómérő	1650
1 fémvonalzó 300 mm	1683
1 rajztű	1688A
1 fékes mérőszalag 5 m	1692
1 Hézagmérő	1708/13
1 flexibilis mágneses csavarkiszedő 1,8 kg	1712E/2
5 reszelő 200 mm	1719BMA8/S5
1 fűrész	1726BM
1 Popszegecshúzó	1741B
1 Olajozó fémkanna 200 cc	1751N

Ft

5910VI/3 2.452.400 059101044

A C30M munkapadhoz ajánlott készlet

5910VI/3T

261 darabos szerszámkészlet ABS hőformált tálcában

► Ipari karbantartás

Mennyiség/megnevezés

- 16 csillag-villáskulcs 6÷21 mm
- 5 csillag-villáskulcs 22 - 24 - 27 - 30 - 32 mm
- 5 hosszú kiütő Ø 2 - 3 - 4 - 5 - 6 mm
- 1 pontozó Ø 4 mm
- 13 villáskulcs 6x7 - 8x9 - 10x11 - 12x13 - 14x15 - 16x17
18x19 - 20x22 - 21x23 - 24x26 - 27x29 - 30x32 mm
- 9 imbuszkulcs Ø 1,5 - 2 - 2,5 - 3 - 4 - 5 - 6 - 8 - 10 mm
- 5 hajlított csillagkulcs 20x22 - 21x23 - 24x26 - 25x28 - 27x29 mm
- 7 hajlított csillagkulcs 6x7 - 8x9 - 10x11 - 12x13 - 14x15 - 16x17
18x19 mm
- 5 1/2"-os imbusz dugókulcs Ø 5 - 6 - 8 - 10 - 12 mm
- 1 1/2"-os toldó 125 mm
- 1 1/2"-os toldó 255 mm
- 1 1/2"-os csukló
- 1 1/2"-os csúszkás T-hajtószár
- 1 1/2"-os irányváltós racsnit
- 19 1/2"-os hatlapú dugókulcs Ø 10÷24 - 26 - 27 - 30 - 32 mm
- 9 csavarhúzó hasítottfejű csavarokhoz ● 3x75 - 3x100 - 4x100 - 4x150 - 5,5x100 - 5,5x150 -
6,5x150 - 8x150 - 10x200 mm
- 2 Lapos törpe csavarhúzó ● 4x30 - 6,5x30 mm
- 7 Phillips®-csavarhúzó ● PH0x60 - PH0x100 - PH1x80 - PH1x120 - PH2x100 - PH2x150 -
PH3x150 mm
- 2 Csavarhúzó Phillips® - csavarokhoz, extra rövid penge ● PH1x30 - PH2x30 mm
- 4 imbuszkulcs Ø 13-14-17-19 mm
- 1 bádogos lemezolló 250 mm
- 1 Egyenes élű műszerész olló
- 1 fűrész
- (5) fűrészlap
- 1 Olajozó műanyag anna 200 cc
- 1 kombinált fogó ■ 180 mm
- 1 Egyenes extra hosszú félkerécsőrű fogó ● 160 mm
- 1 Erősített oldalcsípőfogó † 160 mm
- 1 egyenes belső Seeger-fogó ○ 180 mm
- 1 hajlított belső Seeger - fogó ○ 170 mm
- 1 egyenes külső Seeger-fogó ● 175mm
- 1 hajlított külső Seeger - fogó ● 175mm
- 2 erősített laposvágó 100 - 200 mm
- 1 lakatos kalapács 300 g
- 1 műanyag kalapács Ø 35 mm
- 1 reszelő 200 mm
- 4 csillag-villáskulcs 35-36-38-41 mm
- 1 villáskulcs 36x41 mm
- 1 Állítható villáskulcs 250 mm
- 1 Amerikai csőfogó 300 mm
- 25 Rövid csigafűrő hengeres szárral
- 37 HSS menetfűrő és menetmetsző készlet
- 1 kioldó nyomatékulcs irányváltós racsnival ⊗ 200 Nm
- 17 12 dugókulcs és 5 tartozék 3/4"
- 14 T-szerű imbuszkulcs
- 5 csuklós T - imbuszkulcs Ø 3-4-5-6-8 mm
- 1 egyenes belső Seeger-fogó ○ 300 mm
- 1 hajlított belső Seeger - fogó ○ 290 mm
- 1 egyenes külső Seeger-fogó ● 225 mm
- 1 hajlított külső Seeger - fogó ● 220 mm
- 1 vízpumpafogó 300 mm
- 1 kettős állítású önzáró fogó
- 1 áttételes homlokcsípőfogó † 180 mm
- 1 lakatos kalapács 600 g
- 1 műanyag kalapács 60 mm
- 5 Törtcsavarkiszedő M3-M18
- 1 Kétkörmös univerzális csapágylehúzó
- 1 tolómérő
- 1 fémvonalzó
- 1 rajztű
- 1 fékes mérőszalag 5 m
- 1 Hézagmérő
- 1 flexibilis mágneses csavarkiszedő

Beta-sz.	TR
42	T05
42	T06
31	T31
32	T31
55	T31
96N/SC9	T31
90	T41
90	T40
920ME	T80
920/21	T80
920/22	T80
920/25	T80
920/42	T80
920/55	T80
920A	T80
1260	T167
1260N	T167
1262	T168
1262N	T168
96N	T168
1112	T285
1128BM	T285
1726	T285
1728BM	T285
1753	T285
1150BM	T137
1166BM	T137
1084BM	T137
1032	T145
1034	T145
1036	T145
1038	T145
35	T234
1370	T234
1390	T234
1719BMA8/S5	T236
42	
55	
111E	
362	
412/SP25	
447/C37	
666N/20	
928A/C12	
951/S14	
953	
1032	
1034	
1036	
1038	
1048N	
1051	
1092V	
1370	
1390	
1430/S5	
1500/3	
1650	
1683	
1688	
1692	
1708/13	
1712E/2	



T05 T06 T31



T40 T41 T80



T167 T168 +96N



T137 T145 T234 T236



T285

Ft

5910VI/3T 2.049.300 059101063

A C30M munkapadhoz ajánlott készlet

5935VI/2MB

133 darabos szerszámkészlet a C35 szerszámszekrényhez habszivacs tálcában

► Ipari karbantartás

Mennyiség/megnevezés

- 21 csillag-villáskulcs 6-7-8-9-10-11-12-13-14-15-16-17-18-19-20-21-22-24-27-30-32 mm
- 8 villáskulcs 6x7-8x9-10x11-12x13-14x15
16x17-18x19-20x22 mm
- 1 vízpumpafofó 250 mm
- 19 1/2"-os hatlapú dugókulcs ⦿ 10-11-12-13-14-15-16-17-18-19-20-21-22-23-24-26-27-30-32 mm
- 1 1/2" Gömbvégű toldó 125 mm
- 1 1/2" Gömbvégű toldó 150 mm
- 1 1/2"-os csukló
- 1 1/2"-os csúszkás T-hajtószár
- 1 1/2"-os irányváltós racsnit ⦿
- 1 Állítható villáskulcs 250 mm
- 1 Egyenes pofájú önzáró fogó 240 mm
- 1 Erősített oldalcsipőfogó 160 mm
- 1 kombinált fogó 180 mm
- 1 Egyenes extra hosszú félkerékcsőrű fogó 160 mm
- 1 egyenes belső Seeger-fogó 180 mm
- 1 hajlított belső Seeger - fogó 170 mm
- 1 egyenes külső Seeger-fogó 175 mm
- 1 hajlított külső Seeger - fogó 175 mm
- 13 1/4"-os hatlapú dugókulcs ⦿ 4-4,5-5-5,5-6-7-8-9-10-11-12-13-14 mm
- 1 1/4" - os toldó 50 mm
- 1 1/4" - os toldó 150 mm
- 1 1/4"-os csukló
- 1 1/4"-os hajtószár
- 1 1/2"-os irányváltós racsnit ⦿
- 1 1/4"-os csúszkás T-hajtószár
- 7 csavarhúzó hasítottfejú csavarokhoz
● 2,5x50-3x75-3,5x100-4x100-5,5x125-6,5x150-8x200 mm
- 2 Lapos törpe csavarhúzó ● 4x30-6,5x30 mm
- 7 Phillips®-csavarhúzó ⦿ PH0x60-PH0x100-PH1x80-PH1x120
PH2x100-PH2x150-PH3x150 mm
- 2 Csavarhúzó Phillips® - csavarokhoz, extra rövid penge ⦿ PH1x30-PH2x30 mm
- 1 Fáziskereső ● 4x30-6,5x30 mm
- 9 Hajlított gömbfejú imbuszkulcs ⦿
- 6 T-szárú imbuszkulcs ⦿ 2,5-3-4-5-6-8 mm
- 5 hosszú kiütő Ø 2-3-4-5-6 mm
- 1 pontozó Ø 4 mm
- 1 erősített laposvágó 200 mm
- 1 bádogos lemezolló 250 mm
- 1 műszerész olló
- 1 lakatos kalapács 500 g
- 1 műanyag kalapács Ø 45 mm
- 1 szögletes egyengető reszelő markolattal 200 mm
- 1 háromszög egyengető reszelő markolattal 200 mm
- 1 lapos egyengető reszelő markolattal 200 mm
- 1 félkerék egyengető reszelő markolattal 200 mm
- 1 kerek egyengető reszelő markolattal 200 mm
- 1 fűrész 440 mm

Beta-sz.	TR
42	MB12
55	MB12
1048N	MB12
920A	MB37
920AN/125	MB37
920AN/250	MB37
920/25	MB37
920/42	MB37
920/55	MB37
111E	MB37
1052	MB37
1084BM	MB37
1150BM	MB37
1166BM	MB37
1032	MB37
1034	MB37
1036	MB37
1038	MB37
900	MB37
900/20	MB37
900/21	MB37
900/25	MB37
900B/30	MB37
900/55	MB37
900/42	MB37
1260	MB44
1260N	MB44
1262	MB44
1262N	MB44
1253	MB44
96BPC/SC9	MB44
951	MB44
31	MB55
32	MB55
35	MB55
1112	MB55
1128BMX	MB55
1370	MB55
1390	MB55
1719BMA...Q	MB55
1719BMA...T	MB55
1719BMA...P	MB55
1719BMA...M	MB55
1719BMA...R	MB55
1726	MB55

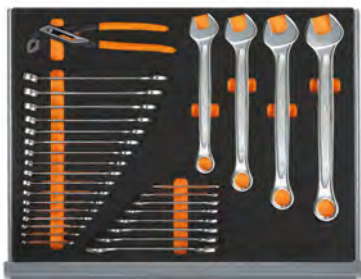

MB12



MB37



MB44



MB55

Ft

5935VI/2MB

816.900 059351316

Készletlétét javaslat C35



5957VI

162 darabos szerszámkészlet

► Ipari karbantartás

Mennyiség/megnevezés

Beta-sz.

6	hosszú kiütő Ø 2 - 3 - 4 - 5 - 6 - 8 mm	31/SP6
2	kiütő, 1 pontozó, 3 hidegvágó	38/SP6
18	csillag-villáskulcs 6-7-8-10-11-12-13-14-15-16-17-19-21-22-24-27-30-32 mm	42
12	villáskulcs 6x7 + 30x32 mm	55/S12X
8	T - szárú imbuszkulcs műanyag markolattal	96T/S8
2	2,5 - 3 - 4 - 5 - 6 - 8 - 10 mm	
8	8 részes hajlítot Torx® imbuszkulcs szerszám készlet ☉ T9 - T10 - T15 - T20 - T25 - T27 - T30 - T40	97TX/SC8
1	Allítható villáskulcs 250 mm	111E
13	1/2"-os tizenkétszögű dugókulcs Ø 10+22 mm	920B/SB13
8	1/2"-os tizenkétszögű dugókulcs Ø 23+32 mm	920B/SB8
4	1/2" - os csavarhúzó dugókulcs ● 1,2x6,5 - 1,2x8 - 1,6x9 - 2x12 mm	920LP
3	1/2" - os Phillips® csavarhúzó dugókulcs ☉ PH2 - 3 - 4	920PH
1	1/2"-os toldó 125 mm	920/21
1	1/2"-os toldó 255 mm	920/22
1	1/2"-os csukló	920/25
1	1/2"-os csúszkás T-hajtószár	920/42
1	1/2"-os irányváltós racsní ☉	920/55
1	egyenes feszítővas	963
2	egyenes belső Seeger-fogó Ø 140 - 180 mm	1032
2	hajlítot belső Seeger - fogó Ø 130 - 170 mm	1034
2	egyenes külső Seeger-fogó ● 140 - 175 mm	1036
2	hajlítot külső Seeger - fogó ● 135 - 175 mm	1038
1	vízpumpa fogó 250 mm	1048N
1	kettős állítású önzáró fogó	1051
1	Erősített oldalcsipőfogó ☉ 160 mm	1084BM
1	áttételes homlokcsipőfogó ☉ 180 mm	1092V
1	bádogos lemezolló 250 mm	1112
1	Bádogos olló amerikai modell 250 mm	1114
1	műszerész olló	1128BMX
1	kombinált fogó ≡ 180 mm	1150BM
1	Egyenes extra hosszú félkerekcsőrű fogó ● 160 mm	1166BM
1	Hajlítot extra hosszú félkerekcsőrű fogó ● 160 mm	1168BM
7	csavarhúzó hasítottfejű csavarokhoz ● 2,5x50 - 3x75 - 4x100	1260
5,5x125 - 6,5x150 - 8x200 - 10x200 mm		
4	Phillips®-csavarhúzó ☉ PH0x60 - PH1x80 - PH2x100 - PH3x150 mm	1262
3	lakatos kalapács 300 - 600 - 1000 g	1370
1	műanyag kalapács Ø 35 mm	1390
1	fékes mérőszalag 5 m	1692
1	flexibilis mágneses csavarkiszedő 1,8 kg	1712E/2
1	kétélű hántoló 200 mm	1717A
1	háromélű hántoló 200 mm	1717B
5	reszelő 200 mm	1719BMA8/S5
1	fűrész	1725
1	pumpás fém olajozó kanna 200 cc	1751
1	erősített laposvágó 200 mm	35
1	erősített keresztvágó 200 mm	37
11	tizenkétszögű pipakulcs 8 - 10 - 11	932
12 - 13 - 14 - 16 - 17 - 19 - 22 - 24 mm		
1	Egyenes pofájú önzáró fogó 240 mm	1052
1	Egyenes pofájú önzáró fogó 280 mm	1060
1	Egyenes pofájú önzáró fogó 290 mm	1062
1	ütésselnyelő műanyag kalapács Ø 50 mm	1392
1	Kétkörmös univerzális csapágylehúzó 25+130 mm	1500N/2
1	tolómérő	1650
1	fémvonalzó 300 mm	1683
1	rajztű	1688A
1	Hézagmérő	1708/13
1	blankoló kés	1777BM
1	dekorkés 170 mm	1771BM
1	Oldalcsipőfogó ☉ 160 mm	1082BM

Ft



5957VI

1.264.400 059571005

Készletlétársítási javaslat C57SA - C57SB - C57SP

5954VI

133 darabos szerszámkészlet

► Ipari karbantartás

Mennyiség/megnevezés



Beta-sz.

5	hosszú kiütő Ø 2-3-4-5-6 mm	31
1	pontozó Ø 4 mm	32
2	erősített laposvágó 200-250 mm	35
18	csillag-villáskulcs 6+14 - 16 - 17 - 18 - 19 - 21 - 22 - 24 - 27 - 30 mm	42
12	villáskulcs 6x7 - 8x9 - 10x11 - 12x13 - 14x15 - 16x17 18x19 - 20x22 - 21x23 - 24x26 - 27x29 - 30x32 mm	55
12	imbuszkulcs Ø 2+10 mm	96/SC12
1	Állítható villáskulcs 250 mm	111E
1	svéd csőfogó 320 mm	374
20	1/2"-os hatlapú dugókulcs Ø 10+24 - 26 - 27 - 28 - 30 - 32 mm	920A
6	1/2"-os imbusz dugókulcs Ø 5 - 6 - 8 - 10 - 12 - 14 mm	920ME
1	1/2"-os toldó 125 mm	920/21
1	1/2"-os toldó 255 mm	920/22
1	1/2"-os csukló	920/25
1	1/2"-os csuklós T-hajtószer	920/40
1	1/2"-os csúszkás T-hajtószer	920/42
1	1/2"-os irányváltós racsnit	920/55
6	T-szerű imbuszkulcs Ø 2,5 - 3 - 4 - 5 - 6 - 8 mm	951
2	egyenes belső Seeger-fogó Ø 140 - 180 mm	1032
1	hajlított belső Seeger - fogó Ø 170 mm	1034
2	egyenes külső Seeger-fogó Ø 140x1,3 - 175 mm	1036
1	hajlított külső Seeger - fogó Ø 175 mm	1038
1	vízpumpafogó 250 mm	1048N
1	Egyenes pofájú önzáró fogó 240 mm	1052
1	Erősített oldalcsípőfogó 160 mm	1084BM
1	áttételes homlokcsípőfogó 180 mm	1092V
1	bádogos lemezolló 250 mm	1112
1	műszerész olló	1128BMX
1	kombinált fogó 180 mm	1150BM
1	Egyenes extra hosszú félkerekcsőrű fogó Ø 160 mm	1166BM
1	Fáziskereső	1253
2	csavarhúzó hasítottfejú csavarokhoz Ø 8x150 - 10x200 mm	1260
2	Lapos törpe csavarhúzó Ø 4x30 - 6,5x30 mm	1260N
2	Phillips®-csavarhúzó PH3x150 - PH4x200 mm	1262
2	Csavarhúzó Phillips® - csavarokhoz, extra rövid penge PH1x30 - PH2x30 mm	1262N
8	csavarhúzókészlet	1263/D8
2	lakatos kalapács 300 - 500 g	1370
1	műanyag kalapács Ø 45 mm	1390
1	fékes mérőszalag 5 m	1692
1	flexibilis mágneses csavarkiszedő 0,5 kg	1712E/1
5	reszelő 200 mm	1719BMA8/S5
1	fűrész	1726BM
1	pumpás műanyag olajozó kanna 250 cc	1754

Ft



5954VI

847.600 059541053

Készletársítási javaslat C54S-C55C

5904VU/1M

90 darabos szerszámkészlet habszivacs tálcában

► Univerzális alkalmazás

Mennyiség/megnevezés

- 16 csillag-villáskulcs 6÷21 mm
- 8 villáskulcs 6x7 - 8x9 - 10x11 - 12x13 - 14x15 - 16x17
18x19 - 20x22 mm
- 9 imbuszkulcs \odot 1,5 - 2 - 2,5 - 3 - 4 - 5 - 6 - 8 - 10 mm
- 6 Imbusz csavarhúzó Torx®-csavarokhoz \odot T8-T10-T15-T20-T25-T30
- 3 csavarhúzó hasítottfejű csavarokhoz \bullet 3x75-4x100-6,5x150 mm
- 3 Phillips®-csavarhúzó \oplus PH0x60-PH1x80-PH2x100 mm
- 8 T - szárú imbuszkulcs műanyag markolattal \odot 2-2,5-3-4-5-6-7-8 mm
- 1 1/2" Gömbvégű toldó 125 mm
- 1 1/2" Gömbvégű toldó 250 mm
- 1 1/2"-os csukló
- 1 1/2"-os csúszkás T-hajtószár
- 1 1/2"-os irányváltós racsni \oplus
- 19 1/2"-os hatlapú dugókulcs \odot 10÷24 - 26 - 27 - 30 - 32 mm
- 1 Erősített oldalcsipőfogó \ddagger 160 mm
- 1 kombinált fogó \equiv 180 mm
- 1 Egyenes extra hosszú félkerékcsőrű fogó \bullet 160 mm
- 1 vízpumpafogó 250 mm
- 1 Egyenes pófajú önzáró fogó 240 mm
- 2 erősített laposvágó 100 - 200 mm
- 1 lakatos kalapács 300 g
- 1 műanyag kalapács \emptyset 35 mm
- 1 egyenes belső Seeger-fogó \odot 180 mm
- 1 hajlított belső Seeger - fogó \odot 170 mm
- 1 egyenes külső Seeger-fogó \bullet 175 mm
- 1 hajlított külső Seeger - fogó \bullet 175 mm

Beta-sz.	TR
42	M05
55	M33
96/SC9	M33
1267TX	M204
1260	M201
1262	M201
96T	M50
920AN/125	M83
920AN/250	M83
920/25	M83
920/42	M83
920/55	M83
920A	M83
1084	M137
1150	M137
1166	M137
1048N	M153
1052	M153
35	M234
1370	M234
1390	M234
1032	M145
1034	M145
1036	M145
1038	M145



M05 M33 M204 M201



M50 M83



M137 M153 M234 M145

Ft



5904VU/1M

470.100 059041201

Készletársítási javaslat RSC51 - RSC23T - RSC24 - RSC24A - RSC24AXL - RSC24L/7 - RSC24L-CAB - RSC28
C37 - C39 - C39T - C39SM - C39MD - RSC50 - RSC55 - C59

5904VU/2M

144 darabos szerszámkészlet habszivacs tálcában

► Univerzális alkalmazás

Mennyiség/megnevezés

- 16 csillag-villáskulcs 6÷21 mm
- 8 villáskulcs 6x7 - 8x9 - 10x11 - 12x13 - 14x15 - 16x17 - 18x19 - 20x22 mm
- 9 imbuszkulcs \odot 1,5 - 2 - 2,5 - 3 - 4 - 5 - 6 - 8 - 10 mm
- 3 csavarhúzó hasítottfejű csavarokhoz \bullet 3x75-4x100-6,5x150 mm
- 3 Phillips®-csavarhúzó \oplus PH0x60-PH1x80-PH2x100 mm
- 6 Imbusz csavarhúzó Torx®-csavarokhoz \odot T8-T10-T15-T20-T25-T30
- 8 T - szárú imbuszkulcs műanyag markolattal \odot 2-2,5-3-4-5-6-7-8 mm
- 1 1/2" Gömbvégű toldó 125 mm
- 1 1/2" Gömbvégű toldó 250 mm
- 1 1/2"-os csukló
- 1 1/2"-os csúszkás T-hajtószár
- 1 1/2"-os irányváltós racsnit \oplus
- 19 1/2"-os hatlapú dugókulcs \odot 10÷24 - 26 - 27 - 30 - 32 mm
- 1 Erősített oldalcsipőfogó \perp 160 mm
- 1 kombinált fogó \equiv 180 mm
- 1 Egyenes extra hosszú félkerekcsőrű fogó \bullet 160 mm
- 1 vízpumpafogó 250 mm
- 1 Egyenes pófájú önzáró fogó 240 mm
- 2 erősített laposvágó 100 - 200 mm
- 1 Lakatos kalapács német modell műanyag nyéllel 300 g
- 1 Kalapács cserélhető Nylon-végekkel, fanyéllel \varnothing 35 mm
- 1 egyenes belső Seeger-fogó \odot 180 mm
- 1 hajlított belső Seeger - fogó \odot 170 mm
- 1 egyenes külső Seeger-fogó \bullet 175 mm
- 1 hajlított külső Seeger - fogó \bullet 175 mm
- 1 szivacsbetét
- 1 fékes mérőszalag 5 m
- 1 Mini fűrész
- 1 Olajozó műanyag flakon 30 cc
- 1 dekorkés
- 5 Színes csavarhúzóbetét hasítottfejű csavarokhoz \bullet 0,5x3 - 0,6x4,5 - 0,8x5,5 - 1x5,5 - 1,2x6,5 mm
- 8 Színes hatszögű csavarhúzóbetét \odot 2 - 2,5 - 3 - 4 - 5 - 6 - 8 - 10 mm
- 5 Színes csavarhúzóbetét Phillips®-csavarokhoz \oplus PH0 - PH1 - PH2 - PH3 - PH4
- 4 Színes csavarhúzóbetét Pozidriv®- és Supadriv®-csavarokhoz \oplus PZ1 - PZ2 - PZ3 - PZ4
- 11 Színes csavarhúzóbetét Torx®-csavarokhoz \odot T6-T7-T8-T9-T10-T15-T20-T25-T27-T30-T40
- 8 Színes csavarhúzóbetét Tamper Resistant Torx®-csavarokhoz \oplus T9-T10-T15-T20-T25-T27-T30-T40
- 1 Betéttartó nyéllel 230 mm
- 1 Irányváltós racsnit, betéttartóval 100 mm
- 5 reszelő 200 mm
- 1 Adapter dugókulcshoz
- 1 Mágneses betéttartó



M05 M33 M204 M201



M50 M83



M137 M153 M237 M145



VPM3 M289 M85 M236

Beta-sz.	TR
42	M05
55	M33
96/SC9	M33
1260	M201
1262	M201
1267TX	M204
96T	M50
920AN/125	M83
920AN/250	M83
920/25	M83
920/42	M83
920/55	M83
920A	M83
1084	M137
1150	M137
1166	M137
1048N	M153
1052	M153
35	M237
1370T	M237
1390N	M237
1032	M145
1034	M145
1036	M145
1038	M145
VPM3	VPM3
1692	M289
1725CR	M289
1755	M289
1771	M289
860LP	M85
860PE	M85
860PH	M85
860PZ	M85
860TX	M85
860RTX	M85
851SR	M85
860/55	M85
1719BMA8/S5	M236
8920	M85
882P	M85

Ft

5904VU/2M

614.700 059041212

Készletértéslési javaslat RSC23T - RSC24 - RSC24A - RSC24AXL - RSC24L/7 - RSC24L-CAB
RSC28 - C37 - C39 - C39SM - C39MD - C39T - RSC50 - RSC55 - C59

5904VU/2T

104 darabos szerszámkészlet ABS hőformált tálcában

► Univerzális alkalmazás

Mennyiség/megnevezés

- 7 csavarhúzó hasítottfejű csavarokhoz ● 2,5x50 - 3x75 - 3,5x100 - 4x125
5,5x100 - 5,5x150 - 6,5x150 mm
- 6 Phillips®-csavarhúzó ● PH0x60 - PH0x100 - PH1x80 - PH1x120 - PH2x100 - PH2x150 mm
- 19 1/2"-os hatlapú dugókulcs ○ 10-11-12-13-14-15-16-17-18-19
20-21-22-23-24-26-27-30-32 mm
- 1 1/2"-os toldó 125 mm
- 1 1/2"-os toldó 255 mm
- 1 1/2"-os csukló
- 1 1/2"-os csúszkás T-hajtószer 305 mm
- 1 1/2"-os irányváltós racsnis ⊗
- 1 egyenes belső Seeger-fogó ○ 180 mm
- 1 hajlított belső Seeger - fogó ○ 170 mm
- 1 egyenes külső Seeger-fogó ● 175 mm
- 1 hajlított külső Seeger - fogó ● 175 mm
- 1 vízpumpafogó 250 mm
- 1 Egyenes pófájú önzáró fogó 240 mm
- 1 Erősített oldalcsípőfogó † 160 mm
- 1 kombinált fogó = 180 mm
- 1 Egyenes extra hosszú félkerekcsőrű fogó ● 160 mm
- 2 erősített laposvágó 100-200 mm
- 1 lakatos kalapács 300 g
- 1 műanyag kalapács Ø 35 mm
- 6 T-szerű imbuszkulcs ○ 2,5-3-4-5-6-8 mm
- 8 villáskulcs 6x7-8x9-10x11-12x13-14x15
16x17-18x19-20x22 mm
- 9 imbuszkulcs ○ 1,5÷10 mm
- 16 csillag-villáskulcs 6-7-8-9-10-11-12-13-14-15-16-17
18-19-20-21 mm
- 5 csillag-villáskulcs 22-24-27-30-32 mm
- 1 műszerész olló
- 1 univerzális olló
- 1 szögletes egyengető reszelő markolattal 200 mm
- 1 lapos egyengető reszelő markolattal 200 mm
- 1 háromszög egyengető reszelő markolattal 200 mm
- 1 félkerek egyengető reszelő markolattal 200 mm
- 1 kerek egyengető reszelő markolattal 200 mm
- 1 fűrész
- 1 fűrészlap
- 1 dekorációs 170 mm
- 1 185 mm

Beta-sz.	TR
1260	T199
1262	T202
920A	T83
920/21	T83
920/22	T83
920/25	T83
920/42	T83
920/55	T83
1032	T145
1034	T145
1036	T145
1038	T145
1048N	T153
1052	T153
1084	T138
1150	T138
1166	T138
35	T234
1370	T234
1390	T234
951	T68
55	T33
96/SC9	T33
42	T05
42	T06
1128BMX	T284
1130BMX	T284
1719BMA...Q	T284
1719BMA...P	T284
1719BMA...T	T284
1719BMA...M	T284
1719BMA...R	T284
1726BM	T284
1728BM	T284
1771BM	T284
1778	T284



T199 T202 T83



T145 T153 T138 T234



T68 T33 T05 T06



T284

Ft

5904VU/2T

573.300 059041070

Készletlétszámjavaslat RSC23T - RSC24 - RSC24A - RSC24AXL - RSC24L/7 - RSC24L-CAB - RSC28 - C37 - C39 - C39SM - C39MD - C39T - RSC50 - RSC55 - C59

5904VU/3T

146 darabos szerszámkészlet ABS hőformált tálcában

► Univerzális alkalmazás

Mennyiség/megnevezés

- 16 csillag-villáskulcs 6+21 mm
- 5 csillag-villáskulcs 22 - 24 - 27 - 30 - 32 mm
- 5 hosszú kiűtő Ø 2 - 3 - 4 - 5 - 6 mm
- 1 pontozó Ø 4 mm
- 12 villáskulcs 6x7 - 8x9 - 10x11 - 12x13 - 14x15 - 16x17 - 18x19 - 20x22 - 21x23 - 24x26 - 27x29 - 30x32 mm
- 9 imbuszkulcs Ø 1,5 - 2 - 2,5 - 3 - 4 - 5 - 6 - 8 - 10 mm
- 6 T - szárú imbuszkulcs műanyag markolattal Ø 2 - 2,5 - 3 - 4 - 5 - 6 mm
- 6 Imbusz csavarhúzókészlet Torx®-csavarokhoz ⚙ T10-T15-T20-T25-T27-T30
- 5 1/2"-os imbusz dugókulcs Ø 5 - 6 - 8 - 10 - 12 mm
- 1 1/2"-os toldó 125 mm
- 1 1/2"-os toldó 255 mm
- 1 1/2"-os csukló
- 1 1/2"-os csúszkás T-hajtószár
- 1 1/2"-os irányváltós racsnit
- 19 1/2"-os hatlapú dugókulcs Ø 10+24 - 26 - 27 - 30 - 32 mm
- 13 1/4"-os hatlapú dugókulcs Ø 4-4,5-5-5,5-6-7-8-9-10-11-12-13-14 mm
- 6 1/4"-os imbusz-dugókulcs Ø 2,5-3-4-5-6-8 mm
- 1 1/4"-os toldó 50 mm
- 1 1/4"-os toldó 150 mm
- 1 1/4"-os csukló
- 1 1/4"-os hajtószár
- 1 1/4"-os csúszkás T-hajtószár 115 mm
- 1 1/2"-os irányváltós racsnit
- 1 egyenes belső Seeger-fogó ⚙ 180 mm
- 1 hajlított belső Seeger - fogó ⚙ 170 mm
- 1 egyenes külső Seeger-fogó ● 175 mm
- 1 hajlított külső Seeger - fogó ● 175 mm
- 1 kombinált fogó = 180 mm
- 1 Egyenes extra hosszú félkerékcsőrű fogó ● 160 mm
- 1 Erősített oldalcsípőfogó ⚡ 160 mm
- 1 vízpumpafogó 250 mm
- 1 Egyenes pófajú önzáró fogó 240 mm
- 4 csavarhúzó hasítottfejű csavarokhoz ● 3x75 - 4x100 - 5,5x150 - 6,5x150 mm
- 3 Csavarhúzó Pozidriv®-Supadriv®-csavarokhoz ⚙ PZ0 - PZ1 - PZ2
- 7 Imbusz csavarhúzó Torx®-csavarokhoz ⚙ T6-T7-T8-T9-T10-T15-T20
- 2 erősített laposvágó 100 - 200 mm
- 1 lakatos kalapács 300 g
- 1 műanyag kalapács Ø 35 mm
- 5 reszelő 200 mm

Beta-sz.	TR
42	T05
42	T06
31	T31
32	T31
55	T31
96N/SC9	T31
96T	T52
97TTX	T55
920ME	T80
920/21	T80
920/22	T80
920/25	T80
920/42	T80
920/55	T80
920A	T80
900	T91
900ME	T91
900/20	T91
900/21	T91
900/25	T91
900BG/30	T91
900/42	T91
900/55	T91
1032	T145
1034	T145
1036	T145
1038	T145
1150	T138
1166	T138
1084	T138
1048N	T153
1052	T153
1260	T198
1269PZ	T198
1267TX	T205
35	T234
1370	T234
1390	T234
1719BMA8/S5	T236



T05 T06 T31



T52 T55 T80



T91 T145 T138 T153



T198 T205 T234 T236

Ft

5904VU/3T 677.300 059041203

Készletlátsási javaslat RSC24 - RSC24A - RSC24AXL - RSC24L/7 - RSC24L-CAB - C37
- C39 - C39T - C39SM - C39MD - RSC50 - RSC55 - C59

5904VU/4T

197 darabos szerszámkészlet ABS hőformált tálcában

► Univerzális alkalmazás

Mennyiség/megnevezés

- 1 kiütő Ø 4 mm
- 1 hosszú kiütő Ø 4 mm
- 1 pontozó Ø 4 mm
- 54 52 hatszögű csavarhúzóbetét, 10 mm és 2 tartozék
- 17 csillag-villáskulcs 6-7-8-10-11-12-13-14-16-17-18-19-21-22-24-27-30 mm
- 7 hajlítót csillagkulcs 6x7-8x9-10x11-12x13-14x15-16x17-18x19 mm
- 19 1/2"-os hatlapú dugókulcs ⦿ 10-11-12-13-14-15-16-17-18-19-20-21-22-23-24-26-27-30-32 mm
- 1 1/2"-os toldó 125 mm
- 1 1/2"-os toldó 250 mm
- 1 1/2"-os csukló
- 1 1/2"-os csúszkás T-hajtószár 305 mm
- 1 1/2"-os irányváltós racsnit ⦿
- 13 1/4"-os hatlapú dugókulcs ⦿ 4-4,5-5-5,5-6-7-8-9-10-11-12-13-14 mm
- 6 1/4"-os imbusz-dugókulcs ⦿ 2,5-3-4-5-6-8 mm
- 1 1/4"-os toldó 50 mm
- 1 1/4"-os toldó 150 mm
- 1 1/4"-os csukló
- 1 1/4"-os hajtószár
- 1 1/4"-os csúszkás T-hajtószár 115 mm
- 1 1/2"-os irányváltós racsnit ⦿
- 1 Oldalsípőfogó ⚡ 160 mm
- 1 kombinált fogó = 180 mm
- 1 vízpumpa fogó 250 mm
- 7 csavarhúzó hasítottfejű csavarokhoz ● 2,5x50 - 3x75 - 3,5x100 - 4x125 - 5,5x100 - 5,5x150 - 6,5x150 mm
- 6 csavarhúzó keresztfejű Phillips® csavarokhoz ⊕ PH0x60 - PH1x80 - PH1x120 - PH2x100 - PH2x150 - PH3x150 mm
- 7 imbusz-csavarhúzó Torx®-csavarokhoz ⊕ T6-T7-T8-T9-T10-T15-T20
- 2 erősített laposvágó 100-200 mm
- 1 lakatos kalapács 300 g
- 1 műanyag kalapács Ø 35 mm
- 7 hajlítót gömbfejű imbusz kulcs, barnított ⦿ 2,5-3-4-5-6-8-10 mm
- 1 imbusz kulcs ⦿ 12 mm
- 31 30 csavarhúzóbetét és mágneses gyorslazítású betéttartó, műanyag dobozban ● ○ ⊕ ⊕ ⊕ ⊕
- 1 behajító betéttartó adapter

Beta-sz.	TR
30	
31	
32	
867/C52	
42	T01
90	T40
920A	T83
920/21	T83
920/22	T83
920/25	T83
920/42	T83
920/55	T83
900	T91
900ME	T91
900/20	T91
900/21	T91
900/25	T91
900BG/30	T91
900/42	T91
900/55	T91
1082	T156
1150	T156
1048	T156
1201E	T211
1202E	T213
1207E/TX	T216
35	T234
1370	T234
1390	T234
96BP	T259
96N	T259
860MIX/A31	T259
895/1	T259



T01

T83

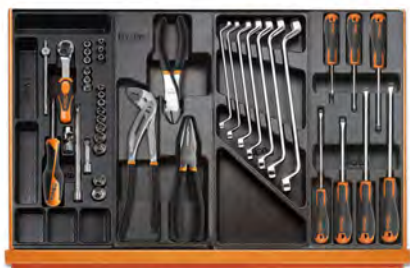

T91

T156

T40

T211



T213

T216

T234

T259

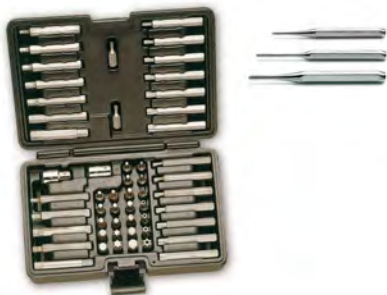

Ft

5904VU/4T

528.700 059241100

A készletet a következő elemekhez ajánljuk: RSC23T - RSC24 - RSC24A - RSC24AXL - RSC24L/7 - RSC24L-CAB - C37 - C39 - C39T - C39SM - C39MD - RSC50 - RSC55 - C59

5908VU/2T

161 darabos szerszámkészlet ABS hőformált tálcában

► Univerzális alkalmazás

Mennyiség/megnevezés

- 16 csillag-villáskulcs 6+21 mm
- 5 csillag-villáskulcs 22 - 24 - 27 - 30 - 32 mm
- 5 hosszú kiütő Ø 2 - 3 - 4 - 5 - 6 mm
- 1 pontozó Ø 4 mm
- 12 villáskulcs 6x7 - 8x9 - 10x11 - 12x13 - 14x15 - 16x17 - 18x19 - 20x22 - 21x23 - 24x26 - 27x29 - 30x32 mm
- 9 imbuszkulcs Ø 1,5 - 2 - 2,5 - 3 - 4 - 5 - 6 - 8 - 10 mm
- 7 hajlított csillagkulcs 6x7-8x9-10x11-12x13-14x15-16x17-18x19 mm
- 6 T - szárú imbuszkulcs műanyag markolattal Ø 2-2,5-3-4-5-6 mm
- 6 Imbusz csavarhúzókészlet Torx®-csavarokhoz ⚙ T10-T15-T20-T25-T27-T30
- 19 1/2"-os hatlapú dugókulcs Ø 10-11-12-13-14-15-16-17-18-19-20-21-22-23-24-26-27-30-32 mm
- 5 1/2"-os imbusz dugókulcs Ø 5-6-8-10-12 mm
- 1 1/2" Gömbvégű toldó 125 mm
- 1 1/2" Gömbvégű toldó 250 mm
- 1 1/2"-os csukló
- 1 1/2"-os csúszkás T-hajtószár 305 mm
- 1 1/2"-os irányváltós racsnit ⚙
- 13 1/4"-os hatlapú dugókulcs Ø 4-4,5-5-5,5-6-7-8-9-10-11-12-13-14 mm
- 6 1/4"-os imbusz-dugókulcs Ø 2,5-3-4-5-6-8 mm
- 1 1/4" - os toldó 50 mm
- 1 1/4" - os toldó 150 mm
- 1 1/4"-os csukló
- 1 1/4"-os hajtószár
- 1 1/4"-os csúszkás T-hajtószár 115 mm
- 1 1/2"-os irányváltós racsnit ⚙
- 1 Erősített oldalcsipőfogó 160 mm
- 1 kombinált fogó 180 mm
- 1 Egyenes extra hosszú félkerékcsőrű fogó ● 160 mm
- 1 egyenes belső Seeger-fogó ○ 180 mm
- 1 hajlított belső Seeger - fogó ○ 170 mm
- 1 egyenes külső Seeger-fogó ● 175 mm
- 1 hajlított külső Seeger - fogó ● 175 mm
- 1 vízpumpafogó 250 mm
- 1 Egyenes pofájú önzáró fogó 240 mm
- 7 Csavarhúzó Phillips®-csavarokhoz ● 2,5x50-3x75-3,5x100-4x125-5,5x100-5,5x150-6,5x150 mm
- 3 Csavarhúzó Phillips®-csavarokhoz ● 8x150-8x200-10x200 mm
- 2 Csavarhúzó hasítottfejú csavarokhoz, extra rövid penge ● 4x30-6,5x30 mm
- 6 Csavarhúzó Phillips®-csavarokhoz ⚙ PH0x60-PH0x100-PH1x80-PH1x120 PH2x100-PH2x150 mm
- 2 Csavarhúzó Phillips®-csavarokhoz ⚙ PH3x150-PH4x200 mm
- 2 Csavarhúzó Phillips®-csavarokhoz, extra rövid penge ⚙ PH1x30-PH2x30 mm
- 2 erősített laposvágó 100-200 mm
- 1 lakatos kalapács 300 g
- 1 műanyag kalapács Ø 35 mm
- 1 szögletes egyengető reszelő markolattal 200 mm
- 1 háromszög egyengető reszelő markolattal 200 mm
- 1 lapos egyengető reszelő markolattal 200 mm
- 1 félkerék egyengető reszelő markolattal 200 mm
- 1 kerek egyengető reszelő markolattal 200 mm
- 1 hőformált műanyag tálcá, üres

Beta-sz.	TR
42	T05
42	T06
31	T31
32	T31
55	T31
96N/SC9	T31
90	T40
96T	T52
97TTX	T55
920A	T82
920ME	T82
920AN/125	T82
920AN/250	T82
920/25	T82
920/42	T82
920/55	T82
900	T91
900ME	T91
900/20	T91
900/21	T91
900/25	T91
900BG/30	T91
900/42	T91
900/55	T91
1084	T138
1150	T138
1166	T138
1032	T145
1034	T145
1036	T145
1038	T145
1048N	T153
1052	T153
1290	T170
1290	T171
1290N	T171
1292	T172
1292	T173
1292N	T173
35	T234
1370	T234
1390	T234
1719BMA...Q	T236
1719BMA...T	T236
1719BMA...P	T236
1719BMA...M	T236
1719BMA...R	T236
VP4	

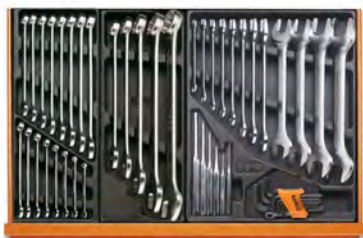

T05 T06 T31



T40 T52 T55 T91



T82 T138 T153



T145 T170 T171 T172



T173 T234 T236 VP4

Ft

5908VU/2T

765.400 059081136

A készletet a következő elemekhez ajánljuk: RSC23T - 6-7-8 fiókos RSC24 - RSC24A - RSC24AXL - RSC24L/7 - RSC24L-CAB - RSC28, 6-7-8 fiókos C37 - 6-7-8 fiókos C39 - C39MD - C39SM - C59 - RSC50 - RSC55

5914VU/M

109 szerszámból álló autójavító készlet a C14 húzható szerszámtáskához habszivacs tálcában

► Univerzális alkalmazás

Mennyiség/megnevezés

- 31 30 csavarhúzóbetét és mágneses gyorslezítésű betéttartó, műanyag dobozban ● ○ ⊕ ⊗ ⊕
- 1 behajtó betéttartó adapter
- 13 1/4"-os hatlapú dugókulcs ○ 4-4,5-5,5-6-7-8-9-10-11-12-13-14 mm
- 1 1/4" - os toldó 150 mm
- 1 1/4"-os csukló
- 1 1/4"-os hajtószár
- 1 1/4"-os csúszkás T-hajtószár
- 1 1/2"-os irányváltós racsnit ⊕
- 16 1/2"-os hatlapú dugókulcs ○ 10-11-12-13-14-15-16-17-18-19-21-22-24-27-30-32 mm
- 1 1/2"-os csukló
- 1 1/2" Gömbvégű toldó
- 1 1/2"-os csúszkás T-hajtószár
- 1 1/2"-os irányváltós racsnit ⊕
- 16 csillag-villáskulcs 6-7-8-9-10-11-12-13-14-15-16-17-18-19-21-22 mm
- 9 imbuszkulcs ○
- 1 Állítható villáskulcs 250 mm
- 1 műszerész olló
- 1 fékes mérőszalag 5 mt
- 1 dekorkés
- 1 vízpumpafogó 250 mm
- 1 Oldalsípőfogó 160 mm
- 1 kombinált fogó 180 mm
- 1 Egyenes extra hosszú félkerekcsőrű fogó ● 160 mm
- 3 csavarhúzó hasítottfejű csavarokhoz ● 3,5x100-5,5x125-6,5x150 mm
- 3 Phillips®-csavarhúzó ⊕ PH0x60-PH1x80-PH2x100 mm

Beta-sz.	TR
860MIX/A31	MCT1
895/1	MCT1
900	MCT1
900/...	MCT1
900/25	MCT1
900BG/30C	MCT1
900/42	MCT1
900/55	MCT1
920A	MCT1
920/25	MCT1
920AN/125	MCT1
920/42	MCT1
920/55	MCT1
42	MCT2
96/SC9	MCT2
111E	MCT2
1128BMX	MCT2
1692/5	MCT2
1771	MCT2
1048N	MCT3
1082BM	MCT3
1150BM	MCT3
1166BM	MCT3
1260	MCT3
1262	MCT3



MC T1



MC T2



MC T3

Ft

5914VU/M

381.800 059140112

Készletlétszámjavaslat C14

5988U/7M

215 darabos szerszámkészlet EVA habszivacs tálcában

► Univerzális alkalmazás

Mennyiség/megnevezés

Beta-sz. TR



M01



M100

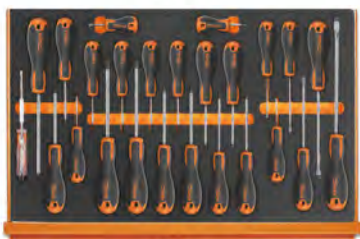

M213



M33 M86 M136 M234

- 22 csillag-villáskulcs 6-7-8-9-10-11-12-13-14-15-16-17-18-19-20-21-22-24-27-30-32-36 mm
- 8 villáskulcs 6x7-8x9-10x11-12x13-14x15-16x17-18x19-20x22 mm
- 9 imbuszkulcs \odot 1,5+10 mm
- 7 Hatszögű csavarhúzóbetétek \odot 4-5-6-7-8-10-12 mm
- 7 Hatszögű csavarhúzóbetétek \odot 4-5-6-7-8-10-12 mm
- 5 Csavarhúzóbetétek XZN®-csavarhoz \odot 5-6-8-10-12 mm
- 5 Csavarhúzóbetétek XZN®-csavarhoz \odot 5-6-8-10-12 mm
- 7 Csavarhúzóbetétek Torx®-csavarhoz \odot T20-T25-T30-T40-T45-T50-T55
- 6 Csavarhúzóbetétek Torx®-csavarhoz \odot T25-T30-T40-T45-T50-T55
- 7 Csavarhúzóbetétek Tamper Resistant Torx®-csavarhoz \odot T20-T25-T30-T40-T45-T50-T55
- 1 Betéttartó a 867-es betétekhez
- 1 Betéttartó a 867-es betétekhez
- 1 behajtó betéttartó adapter
- 1 behajtó betéttartó adapter
- 1 behajtó betéttartó adapter
- 13 1/4"-os hatlapú dugókulcs \odot 4-4,5-5-5,5-6-7-8-9-10-11-12-13-14 mm
- 9 \odot 5-6-7-8-9-10-11-12-13 mm
- 5 1/4"-os imbusz-dugókulcs \odot 3-4-5-6-7 mm
- 4 csavarhúzó-dugókulcs hasítottfejű csavarokhoz, krómozott, barnított hegy \bullet 0,8x4-1x5,5-1,2x6,5-1,2x8 mm
- 4 csavarhúzó-dugókulcs Phillips®-csavarokhoz, krómozott, barnított hegy \oplus PH1-PH2-PH3-PH4
- 7 1/4"-os Torx®-imbusz dugókulcs, krómozott, fekete hegyek \odot T10-T15-T20-T25-T27-T30-T40
- 1 1/4" - os toldó 50 mm
- 1 1/4" - os toldó 100 mm
- 1 1/4" - os toldó 150 mm
- 1 1/4"-os csukló
- 1 1/4"-os hajtószár
- 1 1/4"-os csúszkás T-hajtószár
- 1 1/2"-os irányváltós racsnit \oplus
- 21 1/2"-os hatlapú dugókulcs \odot 8-10-11-12-13-14-15-16-17-18-19-20-21-22-23-24-26-27-28-30-32 mm
- 1 szűkítő közbetét 1/2" és 3/8"
- 1 1/2"-os csukló
- 1 1/2" Gömbvégű toldó 125 mm
- 1 1/2" Gömbvégű toldó 250 mm
- 1 1/2"-os csúszkás T-hajtószár
- 1 1/2"-os irányváltós racsnit \oplus
- 8 1/2"-os Torx®-dugókulcs \odot 10-12-14-16-18-20-22-24 mm
- 11 hatlapú dugókulcs \odot 10-12-13-14-15-16-17-18-19-21-22
- 1 Erősített oldalcsípőfogó \approx 160 mm
- 1 kombinált fogó \approx 180 mm
- 1 Egyenes extra hosszú félkerékcsőrű fogó \bullet 160 mm
- 6 csavarhúzó hasítottfejű csavarokhoz \bullet 2,5x50-3x75-4x100-5,5x125-6,5x150-8x200 mm
- 1 csavarhúzó hasítottfejű csavarokhoz, extra rövid \bullet 4x30 mm
- 4 csavarhúzó keresztfejű Phillips® csavarokhoz \oplus PH0x60-PH1x80-PH2x100-PH3x150 mm
- 1 csavarhúzó keresztfejű Phillips® csavarokhoz, extra rövid \oplus PH1X30 mm
- 12 imbusz-csavarhúzó Torx®-csavarokhoz \odot T6-T7-T8-T9-T10-T15-T20-T25-T27-T30-T40-T45
- 1 Fáziskereső \bullet
- 2 erősített laposvágó 100-200 mm
- 1 lakatos kalapács 300 g
- 1 műanyag kalapács \varnothing 35 mm

Beta-sz.	TR
42	M01
55	M33
96/SC9	M33
867PE	M86
867PEL	M86
867XZN	M86
867XZNL	M86
867TX	M86
867TXL	M86
867RTX	M86
867/1	M86
867/2	M86
895/1	M100
895/3	M100
895/6	M100
900	M100
900L	M100
900ME	M100
900LP	M100
900PH	M100
900TX	M100
900/20	M100
900/20L	M100
900/21	M100
900/25	M100
900B/30	M100
900/42	M100
900/55	M100
920A	M100
920/15	M100
920/25	M100
920AN/125	M100
920AN/250	M100
920/42	M100
920/55	M100
920FTX	M100
920AL	M100
1084BM	M136
1150BM	M136
1166BM	M136
1201E	M213
1201EN	M213
1202E	M213
1202EN	M213
1207E/TX	M213
1253	M213
35	M234
1370	M234
1390	M234

Ft

5988U/7M

731.400 059881019

A készletet a következő elemekhez ajánljuk: RSC23T - RSC24 - RSC24A - RSC24A-XL - RSC24L - RSC24L/CAB - RSC28 - C37 - C39 - C39SM - C39MD - RSC50 - RSC55 - C59



5915VU/0

35 darabos szerszámkészlet

► Univerzális alkalmazás

Mennyiség/megnevezés

- 1 pontozó 4 mm
- 1 erősített laposvágó 125 mm
- 8 villáskulcs 6x7-8x9-10x11-12x13-14x15-16x17-18x19-20x22 mm
- 7 hatlapfejű külső kulcs \odot 1,5-2-2,5-3-4-5-6 mm
- 1 Állítható villáskulcs 150 mm
- 1 vízpumpafogó 250 mm
- 1 oldalcsípőfogó, csúszásmentes kétrétegű PVC bevonatú markolat ipari kivitel ∇ 160 mm
- 1 műszerész olló
- 1 robusztus kombinált fogó csúszásmentes kétrétegű PVC bevonatú markolat ipari kivitel \equiv 180 mm
- 1 egyenes extra hosszú félkerekcsőrű fogó, csúszásmentes kétrétegű PVC bevonatú markolat ipari kivitel \bullet 160 mm
- 4 csavarhúzó hasítottfejű csavarokhoz \bullet 3x75-4x100-5,5x100-6,5x150 mm
- 3 csavarhúzó keresztfejű Phillips® csavarokhoz \oplus PH0x60-PH1x80-PH2x100 mm
- 1 lakatos kalapács 300 g
- 1 fékes mérőszalag 3 m
- 1 dekorkés 18 mm
- 1 autós elsősegély kés
- 1 LED zseblámpa intenzív fényerővel, robusztus eloxált alumíniumból, 500 lumenig

Beta-sz.
32
35
55
96/BGS7
111E
1048N
1082G
1128BMX
1150G
1166G
1201E
1202E
1370
1692/3
1771
1778SOS
1833S

Ft

5915VU/0 153.000 059151021

Készletársítási javaslat C4 - C5 - C5S - C6T



5915VU/1

45 darabos szerszámkészlet

► Univerzális alkalmazás

Mennyiség/megnevezés

- 2 kiütő \varnothing 2-3 mm
- 1 pontozó \varnothing 4 mm
- 2 laposvágó 125-150 mm
- 1 keresztvágó 150 mm
- 14 csillag-villáskulcs 6+14 - 17 - 19 - 21 - 22 - 24 mm
- 9 imbuszkulcs \odot 1,5 - 2 - 2,5 - 3 - 4 - 5 - 6 - 8 - 10 mm
- 1 Állítható villáskulcs 250 mm
- 1 vízpumpafogó 250 mm
- 1 oldalcsípőfogó, csúszásmentes kétrétegű PVC bevonatú markolat ipari kivitel ∇ 160 mm
- 1 műszerész olló
- 1 robusztus kombinált fogó csúszásmentes kétrétegű PVC bevonatú markolat ipari kivitel \equiv 180 mm
- 1 egyenes extra hosszú félkerekcsőrű fogó, csúszásmentes kétrétegű PVC bevonatú markolat ipari kivitel \bullet 160 mm
- 4 csavarhúzó hasítottfejű csavarokhoz \bullet 3x75 - 4x100 - 5,5x100 - 6,5x150 mm
- 3 csavarhúzó keresztfejű Phillips® csavarokhoz \oplus PH0x60 - PH1x80 - PH2x100 mm
- 1 lakatos kalapács 300 g
- 1 fékes mérőszalag 5 m
- 1 dekorkés

Beta-sz.
30
32
34
36
42
96/SC9
111E
1048N
1082G
1128BMX
1150G
1166G
1201E
1202E
1370
1692
1771

Ft

5915VU/1 180.300 059151024

Készletársítási javaslat C8 - C9 - C10 - C10S - C11 - CP15 - CP15L - C16 - CP17 - CP17L - C18



5915VU/2

49 darabos szerszámkészlet

► Univerzális alkalmazás

Mennyiség/megnevezés

- 8 villáskulcs, krómozott 6x7 - 8x9 - 10x11 - 12x13 - 14x15
16x17 - 18x19 - 20x22 mm
- 9 imbuszkulcs \odot 1,5 - 2 - 2,5 - 3 - 4 - 5 - 6 - 8 - 10 mm
- 13 1/4"-os hatlapú dugókulcs \odot 4 - 4,5 - 5 - 5,5 - 6 - 7 - 8 - 9 - 10 - 11 - 12 - 13 - 14 mm
- 1 1/4" - os toldó 150 mm
- 1 1/4"-os csukló
- 1 1/4"-os hajtószár
- 1 1/4"-os csúszkás T-hajtószár
- 1 1/2"-os irányváltós racsnit \oplus
- 1 vízpumpafogó 250 mm
- 1 műszerész olló
- 1 robusztus kombinált fogó csúszásmentes kétrétegű PVC bevonatú markolat ipari kivitel \equiv 180 mm
- 4 csavarhúzó hasítottfejű csavarokhoz \bullet 3x75 - 4x100 - 5,5x150 - 6,5x150 mm
- 3 csavarhúzó keresztfejű Phillips® csavarokhoz \oplus PH0x60 - PH1x80 - PH2x100 mm
- 1 lakatos kalapács 300 g
- 1 fékes mérőszalag 3 m
- 1 Olajozó műanyag flakon 30 cc
- 1 dekorkés 18 mm

Beta-sz.
55/B8N
96/SC9
900
900/21
900/25
900BG/30
900/42
900/55
1048N
1128BMX
1150G
1201E
1202E
1370
1692
1755
1771

Ft

5915VU/2 155.000 059151027

Készletlétszámi javaslat C7 - CP15 - C20 - C20L



5915VU/3

74 darabos szerszámkészlet

► Univerzális

Mennyiség/megnevezés

- 1 hosszú kiütő \varnothing 4 mm
- 1 pontozó \varnothing 4 mm
- 1 laposvágó 150 mm
- 14 csillag-villáskulcs 6-7-8-10-11-12-13-14-15-16-17-19-22-24 mm
- 9 imbuszkulcs \odot 1,5-10 mm
- 3 T - szárú imbuszkulcs műanyag markolattal \odot 4 - 5 - 6 mm
- 1 Állítható villáskulcs 250 mm
- 13 1/2"-os hatlapú dugókulcs \odot 8-17 - 19 - 22 - 24 mm
- 1 1/2"-os toldó 125 mm
- 1 1/2"-os toldó 255 mm
- 1 1/2"-os csukló
- 1 1/2"-os csúszkás T-hajtószár
- 1 1/2"-os irányváltós racsnit \oplus
- 8 könnyített hatlapú csókulcs 6x7 - 8x9 - 10x11 - 12x13 - 14x15 - 16x17 - 18x19 - 20x22 mm
- 2 hajtószár
- 1 Vízpumpafogó, állítható 250 mm
- 1 Egyenes pófájú önzáró fogó 240 mm
- 1 erősített oldalcsípőfogó, csúszásmentes kétrétegű PVC bevonatú markolat ipari kivitel \leq 160 mm
- 1 műszerész olló
- 1 robusztus kombinált fogó csúszásmentes kétrétegű PVC bevonatú markolat ipari kivitel \equiv 180 mm
- 1 egyenes extra hosszú félkerescsőrű fogó, csúszásmentes kétrétegű PVC bevonatú markolat ipari kivitel \bullet 160 mm
- 4 csavarhúzó hasítottfejű csavarokhoz \bullet 3x75 - 4x100 - 5,5x150 - 6,5x150 mm
- 3 csavarhúzó keresztfejű Phillips® csavarokhoz \oplus PH0x60 - PH1x80 - PH2x100 mm
- 1 lakatos kalapács 400 g
- 1 fékes mérőszalag 5 m
- 1 fűrész
- 1 Olajozó műanyag flakon 150 cc
- 1 dekorkés

Beta-sz.
31
32
34
42
96/SC9
96T
111E
920A
920/21
920/22
920/25
920/42
920/55
935
940
1048VN
1052
1084G
1128BMX
1150G
1166G
1201E
1202E
1370
1692
1726
1755
1771

Ft

5915VU/3 330.400 059151028

Készletlétszámi javaslat C7 - C9 - C10 - C10S - C11 - CP15L - C16 - CP17 - CP17L - C19 - C19L - C20 - C20L



5915VU/4

80 darabos szerszámkészlet

► Univerzális alkalmazás

Mennyiség/megnevezés

- 1 hosszú kiütő Ø 4 mm
- 1 pontozó Ø 4 mm
- 1 laposvágó 150 mm
- 15 csillag-villáskulcs 6-7-8-9-10-11-12-13-14-15-16-17-19-22-24 mm
- 9 imbuszkulcs Ø 1,5+10 mm
- 1 Állítható villáskulcs 250 mm
- 13 1/2"-os hatlapú dugókulcs Ø 8+17 - 19 - 22 - 24 mm
- 1 1/2"-os toldó 255 mm
- 1 1/2"-os csukló
- 1 1/2"-os csúszkás T-hajtósár
- 1 1/2"-os irányváltós racsni ⊗
- 17 tizenkétszögű pipakulcs 6+22 mm
- 1 vízpumpafogó 250 mm
- 1 Egyenes pófájú önzáró fogó 240 mm
- 1 erősített oldalcsípőfogó, kétkomponensű markolat ipari kivitel $\nless 160$ mm
- 1 műszerész olló
- 1 robusztus kombinált fogó kétkomponensű markolat ipari kivitel $\nless 180$ mm
- 1 egyenes extra hosszú félkerekcsőrű fogó, kétkomponensű markolat ipari kivitel ● 160 mm
- 4 csavarhúzó hasítottfejű csavarokhoz ● 3x75 - 4x100 - 5,5x150 - 6,5x150 mm
- 3 csavarhúzó keresztfejű Phillips® csavarokhoz ⊕ PH0x60 - PH1x80 - PH2x100 mm
- 1 francia lakatos kalapács 32 mm
- 1 fékes mérőszalag 5 m
- 1 fűrész
- 1 Olajozó műanyag flakon 150 cc
- 1 dekorkés

Beta-sz.

- 31
- 32
- 34
- 42
- 96/SC9
- 111E
- 920A
- 920/22
- 920/25
- 920/42
- 920/55
- 932/S17
- 1048N
- 1052
- 1084GBM
- 1128BMX
- 1150GBM
- 1166GBM
- 1201E
- 1202E
- 1370F
- 1692
- 1726
- 1755
- 1771

Ft

5915VU/4 437.500 059151045

Készletársítási javaslat C20 - C20L



5915VU/5

111 darabos szerszámkészlet

► Univerzális

Mennyiség/megnevezés

- 1 hosszú kiütő Ø 4 mm
- 1 pontozó Ø 4 mm
- 1 laposvágó 150 mm
- 17 csillag-villáskulcs 6-7-8-9-10-11-12-13-14-15-16-17-18-19-20-21-22 mm
- 8 villáskulcs 6x7-8x9-10x11-12x13-14x15-16x17-18x19-20x22 mm
- 9 Hajlított gömbfejű imbuszkulcs Ø
- 1 Állítható villáskulcs 250 mm
- 39 11 hatlapú dugókulcs, 20 csavarhúzóbetét és 8 betéttartó
- 13 11 dugókulcs és 2 tartozék fémdobozban
- 1 vízpumpafogó 250 mm
- 1 Egyenes pófájú önzáró fogó 240 mm
- 1 oldalcsípőfogó, csúszásmentes kétrétegű PVC bevonatú markolat ipari kivitel $\nless 160$ mm
- 1 Rabszék-fogó, lakkozott 220 mm
- 1 műszerész olló
- 1 robusztus kombinált fogó csúszásmentes kétrétegű PVC bevonatú markolat ipari kivitel $\nless 180$ mm
- 1 egyenes extra hosszú félkerekcsőrű fogó, csúszásmentes kétrétegű PVC bevonatú markolat ipari kivitel ● 160 mm
- 4 csavarhúzó hasítottfejű csavarokhoz ● 3x75 - 4x100 - 5,5x100 - 6,5x150 mm
- 3 csavarhúzó keresztfejű Phillips® csavarokhoz ⊕ PH0x60 - PH1x80 - PH2x100 mm
- 1 lakatos kalapács 300 g
- 1 műanyag kalapács Ø 35 mm
- 1 fékes mérőszalag 3 m
- 1 reszelő
- 1 fűrész 440 mm
- 1 dekorkés 18 mm
- 1 LED lámpa, robusztus eloxált alumíniumból

Beta-sz.

- 31
- 32
- 34
- 42
- 55/S8
- 96BPC/SC9
- 111E
- 900/C11
- 920A/C11
- 1048N
- 1052
- 1082G
- 1098
- 1128BMX
- 1150G
- 1166G
- 1201E
- 1202E
- 1370
- 1390
- 1692/3
- 1719BMA8/M
- 1726
- 1771BM
- 1833XS/2

Ft

5915VU/5 416.600 059151046

Készletársítási javaslat C12 - C41S - C41H - C42S - C42H

5915VU/AS

68 darabos szerszámkészlet

► Univerzális

Mennyiség/megnevezés

- 1 hosszú kiütő Ø 4 mm
- 1 pontozó Ø 4 mm
- 1 laposvágó 150 mm
- 13 csillag-villáskulcs 1/4 - 5/16 - 3/8 - 7/16 - 1/2 - 9/16 - 5/8 - 11/16 - 3/4 - 13/16 - 7/8 - 15/16 - 1"
- 8 hajlított csillagkulcs 1/4"+1"
- 9 ○ 3/64"+3/8"
- 1 Állítható villáskulcs 250 mm
- 11 1/2" - os tizenkétszögű dugókulcs ○ 3/8 - 7/16 - 1/2 - 9/16 - 5/8 - 11/16 - 3/4 - 13/16 - 7/8 - 15/16 - 1"
- 1 1/2"-os toldó 125 mm
- 1 1/2"-os toldó 255 mm
- 1 1/2"-os csukló
- 1 1/2"-os csúszkás T-hajtószer
- 1 1/2"-os irányváltós racsnit
- 1 vízpumpafogó 250 mm
- 1 Egyenes pófájú önzáró fogó 240 mm
- 1 erősített oldalcsipőfogó, kétkomponensű markolat ipari kivitel ≤ 160 mm
- 1 műszerész olló
- 1 robusztus kombinált fogó kétkomponensű markolat ipari kivitel = 180 mm
- 1 egyenes extra hosszú félkerécsőrű fogó, kétkomponensű markolat ipari kivitel ● 160 mm
- 4 csavarhúzó hasítottfejjű csavarokhoz ● 3x75 - 4x100 - 5,5x150 - 6,5x150 mm
- 3 csavarhúzó keresztfejjű Phillips® csavarokhoz ⊕ PH0x60 - PH1x80 - PH2x100 mm
- 1 lakatos kalapács 300 g
- 1 fékes mérőszalag 5 m
- 1 fűrés
- 1 Olajozó műanyag flakon 150 cc
- 1 dekorkés

Beta-sz.

- 31
- 32
- 34
- 42AS
- 90AS/8
- 96AS/SC9
- 111E
- 920AS
- 920/21
- 920/22
- 920/25
- 920/42
- 920/55
- 1048N
- 1052
- 1084GBM
- 1128BMX
- 1150GBM
- 1166GBM
- 1201E
- 1202E
- 1370
- 1692
- 1726
- 1755
- 1771

Ft



5915VU/AS

350.900 059151032

Készletársítási javaslat C10 - C20 - C20L



5927VU/M

108 darabos szerszámkészlet habzivacs tálcában

► Univerzális alkalmazás

Mennyiség/megnevezés

- 16 csillag-villáskulcs 6-7-8-9-10-11-12-13-14-15-16-17-18-19-21-22 mm
- 1 Erősített oldalcsipőfogó ≤ 160 mm
- 9 imbusz kulcs ○ 1,5-2-2,5-3-4-5-6-8-10 mm
- 1 kombinált fogó = 180 mm
- 1 Egyenes extra hosszú félkerécsőrű fogó ● 160 mm
- 3 csavarhúzó hasítottfejjű csavarokhoz ● 3,5x100-5,5x150-6,5x150 mm
- 3 csavarhúzó keresztfejjű Phillips® csavarokhoz ⊕ PH0x3x60-PH1x4,5x80-PH2x6x100 mm
- 31 30 csavarhúzóbetét és mágneses gyorslazítású betéttartó, műanyag dobozban ● ○ ⊕ ⊕ ⊕ ⊕
- 1 vízpumpafogó 250 mm
- 1 lakatos kalapács 300 mm
- 1 pontozó 4 mm
- 1 keresztvágó 4 mm
- 13 1/4"-os hatlapú dugókulcs ○ 4-4,5-5-5,5-6-7-8-9-10-11-12-13-14 mm
- 1 1/4" - os toldó 150 mm
- 1 1/4"-os csukló
- 1 1/4"-os hajtószer
- 1 1/4"-os csúszkás T-hajtószer
- 1 1/2"-os irányváltós racsnit
- 16 1/2"-os hatlapú dugókulcs ○ 10-11-12-13-14-15-16-17-18-19-21-22-24-27-30-32 mm
- 1 1/2"-os csukló
- 1 1/2" Gömbvégű toldó 125 mm
- 1 1/4"-os csúszkás T-hajtószer
- 1 1/2"-os irányváltós racsnit
- 1 behajtó betéttartó adapter

Beta-sz.

- 42 MC10
- 1084BM MC10
- 96SC9 MC10
- 1150BM MC10
- 1166BM MC10
- 1201E MC10
- 1202E MC10
- 860MIX/A31 MC20
- 1048N MC20
- 1370 MC20
- 32 MC20
- 36 MC20
- 900 MC20
- 900/21 MC20
- 900/25 MC20
- 900BG/30C MC20
- 900/42 MC20
- 900/55 MC20
- 920A MC20
- 920/25 MC20
- 920AN/125 MC20
- 900/42 MC20
- 920/55 MC20
- 895/1 MC20

Ft



5927VU/M

346.100 059271021

Készletársítási javaslat RSC22 - C27S - RSC23 - RSC23C



MC10



MC20

VP-LS

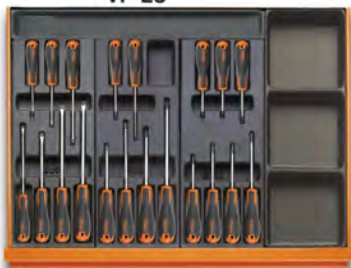
T211 T213 T216 VP3-SC
VP-LS

T145 T153 T137 VP3-SC

VP-LD



T85

VP-LD



T234 T289

VP-LS

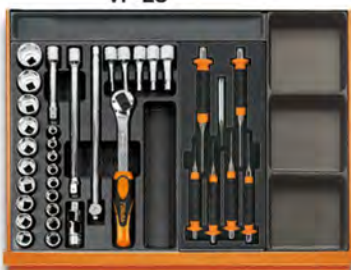

T80 T239 VP3-SC

VP-LS

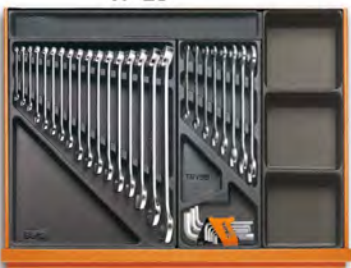

T01 T33 VP3-SC

VP-LD



T68 T236

VP-LD



T50

5938U/2T

210 darabos szerszámkészlet ABS hőformált tálcában

► Univerzális alkalmazás

Mennyiség/megnevezés

- 7 csavarhúzó hasítottfejű csavarokhoz ● 2,5x50 - 3x75 - 3,5x100 - 4x125
5,5x100 - 5,5x150 - 6,5x150 mm
- 6 csavarhúzó keresztfejű Phillips® csavarokhoz ⊕ PH0x60-PH1x80-PH1x120-PH2x100-
PH2x150-PH3x150 mm
- 7 imbusz-csavarhúzó Torx®-csavarokhoz ⊕ T6-T7-T8-T9-T10-T15-T20
- 1 egyenes belső Seeger-fogó ⊙ 180 mm
- 1 hajlított belső Seeger - fogó ⊙ 170 mm
- 1 egyenes külső Seeger-fogó ● 175 mm
- 1 hajlított külső Seeger - fogó ● 175 mm
- 1 vízpumpafogó 250 mm
- 1 Egyenes pofájú önzáró fogó 240 mm
- 1 Erősített oldalcsípőfogó ⚡ 160 mm
- 1 kombinált fogó = 180 mm
- 1 Egyenes extra hosszú félkerécsőrű fogó ● 160 mm
- 1 Betéttartókulcs átváltós racsnival 1/4x5/16
- 13 1/4"-os hatlapú dugókulcs ⊙ 4-4,5-5-5,5-6-7-8-9-10-11-12-13-14 mm
- 1 1/2"-os irányváltós racsni ⊕ 125 mm
- 1 1/4"-os csúszkás T-hajtószár 115 mm
- 1 1/4"-os hajtószár 176 mm
- 1 1/4"-os csukló 41 mm
- 1 1/4" - os toldó 150 mm
- 1 Betéttartó nyéllel 230 mm
- 5 Speciális csavarhúzóbetétek beállító csavarokhoz ⊕ 4-6-8-10-12 mm
- 8 1/4"-os Torq-Set® csavarhúzó betét ⊕ 0-1-2-3-4-5-6-8 mm
- 6 1/4"-os Tri-Wing® csavarhúzó betét ⊕ 1-2-3-4-5-6 mm
- 8 Tamper Resistant Torx® csavarhúzóbetétek ⊕ T9-T10-T15-T20-T25-T27-T30-T40
- 11 Torx®-behajtó betét ⊕ T6-T7-T8-T9-T10-T15-T20-T25-T27-T30-T40
- 3 csavarhúzóbetétek Pozidriv®-Supadriv® csavarokhoz ⊕ PZ1 - PZ2 - PZ3
- 4 Csavarhúzóbetétek Phillips®-csavarokhoz ⊕ PH0 - PH1 - PH2 - PH3
- 8 Imbusz-csavarhúzóbetétek ⊙ 2 - 2,5 - 3 - 4 - 5 - 6 - 8 - 10 mm
- 7 Csavarhúzóbetétek hasítottfejű csavarokhoz
● 0,5x3 - 0,6x4,5 - 0,8x5,5 - 1x5,5 - 1,2x6,5 - 1,2x8 - 1,6x8 mm
- 2 erősített laposvágó 100 - 200 mm
- 1 lakatos kalapács 300 g
- 1 műanyag kalapács Ø 35 mm
- 1 fékes mérőszalag 5 m
- 1 Mini fűrész
- 1 Olajozó műanyag flakon
- 1 dekorkés
- 19 1/2"-os hatlapú dugókulcs ⊙ 10 - 11 - 12+19 - 20 - 21 - 22 - 23 - 24 - 26 - 27 - 30 - 32 mm
- 5 1/2"-os imbusz dugókulcs ⊙ 5 - 6 - 8 - 10 - 12 mm
- 1 1/2"-os toldó 125 mm
- 1 1/2"-os toldó 255 mm
- 1 1/2"-os csukló
- 1 1/2"-os csúszkás T-hajtószár
- 1 1/2"-os irányváltós racsni ⊕
- 1 pontozó Ø 4 mm
- 6 Kiütő nyéllel 2-3-4-5-6-8 mm
- 17 csillag-villáskulcs 6-7-8-10-11-12-13-14-16-17-18-19-21-22-24-27-30 mm
- 8 villáskulcs 6x7 - 8x9 - 10x11 - 12x13 - 14x15 - 16x17 - 18x19 - 20x22 mm
- 9 imbuszkulcs ⊙
- 6 T-szárú imbuszkulcs ⊙ 2,5 - 3 - 4 - 5 - 6 - 8 mm
- 5 reszelő 200 mm
- 11 T - szárú imbuszkulcs műanyag markolattal ⊙ 2 - 2,5 - 3 - 3,5 - 4 - 4,5 - 5 - 6 mm
- 4 Hőformált műanyag tálca
- 4 Hőformált műanyag tálca
- 4 Hőformált műanyag tálca

Beta-sz.	TR
1201E	T211
1202E	T213
1207E/TX	T216
1032	T145
1034	T145
1036	T145
1038	T145
1048N	T153
1052	T153
1084BM	T137
1150BM	T137
1166BM	T137
194	T85
900	T85
900/55	T85
900/42	T85
900BG/30	T85
900/25	T85
900/21	T85
851SR	T85
861SP	T85
861TQS	T85
861TRW	T85
861RTX	T85
861TX	T85
861PZ	T85
861PH	T85
861PE	T85
861LP	T85
35	T234
1370	T234
1390	T234
1692	T289
1725SCR	T289
1755	T289
1771	T289
920A	T80
920ME	T80
920/21	T80
920/22	T80
920/25	T80
920/42	T80
920/55	T80
32	T239
31BM	T239
42	T01
55	T33
96/SC9	T33
951	T68
1719BMA8/S5	T236
96T	T50
VP-3SC	VP-3SC
VP-LS	VP-LS
VP-LD	VP-LD

Ft



848.800 059381062

5938U/2T

Készletjártsási javaslat C38



5957U-P

133 darabos szerszámkészlet

► Ipari karbantartás

Mennyiség/megnevezés

Mennyiség/megnevezés	Beta-sz.
6 hosszú kiütő 2 ÷ 8 mm	31/SP6
6 2 kiütő, 1 pontozó, 3 hidegvágó	38/SP6
17 csillag-villáskulcsok 6÷22 - 24 - 27 - 30 - 32 mm	42/S17X
12 villáskulcs 6x7 ÷ 30x32 mm	55/S12X
8 T - szárú imbuszkulcs műanyag markolattal 2 ÷ 10 mm	96T/S8
8 8 részes hajlított Torx® imbuszkulcs szerszám készlet ☉ T9 ÷ T40	97TX/SC8
1 Állítható villáskulcs 250 mm	111E
13 1/2" - os hatlapú dugókulcs ☉ 10 ÷ 22 mm	920A/SB13
8 1/2" - os hatlapú dugókulcs ☉ 23 ÷ 32 mm	920A/SB8
7 csavarhúzó-dugókulcs készlet Phillips®-csavarokhoz krómozott, barnított fej ●	920LH/SB7
☉ 1,2x65 - 1,2x8 - 1,6x9 - 2x12mm - PH1-PH2-PH3	
1 egyenes belső Seeger-fogó ☉ 180 mm	1032
1 hajlított belső Seeger - fogó ☉ 170 mm	1034
1 egyenes külső Seeger-fogó ● 175 mm	1036
1 hajlított külső Seeger - fogó ● 175 mm	1038
1 vízpumpafogó 250 mm	1048N
1 Egyenes pófajú önzáró fogó 240 mm	1052
1 bádogos lemezolló 250 mm	1112
1 műszerész olló	1128BMX
8 csavarhúzókészlet 2,5x50 - 3x75 - 4x100 - 5,5x125 - 6,5x150 - PH0 - PH1 - PH2	1263/D8
2 lakatos kalapács 300 - 600 g	1370
1 műanyag kalapács 35	1390
1 fékes mérőszalag 5 m	1692/5
1 flexibilis mágneses csavarkiszedő	1712E/2
1 kétélű hántoló 200 mm	1717A
1 háromélű hántoló 200 mm	1717B
5 reszelő 200 mm	1719BMA8/S5
1 Olajozó fémkanna 200 cc	1751N
1 dekorkés	1771BM
1 1/2"-os toldó 125 mm	920/21
1 1/2"-os toldó 250 mm	920/22
1 1/2"-os csukló	920/25
1 1/2"-os csúszkás T-hajtószerű	920/42
1 1/2"-os irányváltós racsnit ☉	920/55
1 egyenes feszítővas	963
1 Oldalsípőfogó ☉ 160 mm	1082BM
1 Erősített oldalsípőfogó ☉ 160 mm	1084BM
1 áttételes homlokcsípőfogó ☉ 180 mm	1092V
1 kombinált fogó ☉ 180 mm	1150BM
1 Egyenes extra hosszú félkerékcsőrű fogó ● 160 mm	1166BM
1 Hajlított extra hosszú félkerékcsőrű fogó ● 160 mm	1168BM
2 csavarhúzó hasítottfejú csavarokhoz ● 8x200 - 10x200 mm	1260
1 Phillips®-csavarhúzó ☉ PH3 8x150mm	1262
1 tolmérő	1650
1 fűrész 420 mm	1725

Ft

5957U-P 906.400 059571004

Készletársítási javaslat C57S A - C57S B - C57SP - RSC50 PS - RSC50 - C55PS - C55PSE - RSC55



5958U

85 darabos szerszámkészlet

► Univerzális alkalmazás

Mennyiség/megnevezés

Mennyiség/megnevezés	Beta-sz.
17 csillag-villáskulcs 6÷22 mm	42
12 imbuszkulcs 2÷10 mm	96N/SC12
13 1/2" - os hatlapú dugókulcs 10÷22 mm	920A/SB13
8 1/2" - os hatlapú dugókulcs 23÷32 mm	920A/SB8
1 1/2"-os toldó 125 mm	920/21
1 1/2"-os toldó 255 mm	920/22
1 1/2"-os csukló	920/25
1 1/2"-os csúszkás T-hajtószer	920/42
1 1/2"-os irányváltós racsni	920/55
1 egyenes belső Seeger-fogó 180 mm	1032
1 egyenes külső Seeger-fogó 175 mm	1036
1 vízpumpafogó 250 mm	1048N
1 Egyenes pófájú önzáró fogó 240 mm	1052
1 Erősített oldalcsipőfogó 160 mm	1084BM
1 műszerész olló	1128BMX
1 kombinált fogó 180 mm	1150BM
1 Egyenes extra hosszú félkerekcsőrű fogó 160 mm	1166BM
7 csavarhúzó hasítottfejű csavarokhoz 3x75 - 3,5x100 - 4x125 5,5x150 - 6,5x150 - 8x200 - 10x200 mm	1260
4 Csavarhúzó Phillips®-csavarokhoz PH0x60 - PH1x80 PH2x100 - PH3x150 mm	1262/S4
1 lakatos kalapács 300 g	1370
1 műanyag kalapács Ø 35 mm	1390
1 fékes mérőszalag 5 m	1692
5 darabos egyengető reszelő készlet markolattal 200 mm	1719BMA...S5
1 fűrész	1725
1 pumpás műanyag olajozó kanna 150 cc	1754
1 dekorkés	1771

Ft



5958U

450.300 059581008

Készletlétsírási javaslat C58P - C45PRO - RSC50 - RSC55



5990V1

44 darabos szerszámkészlet a COMBO C99V1 szerszámdobozhoz EVA habszivacs tálcában

► Univerzális alkalmazás

Mennyiség/megnevezés

- 9 Hajlított gömbfejű imbuszkulcs ○
- 1 dekorkés 18 mm
- 1 vízpumpafogó 250 mm
- 6 2 kiütőből, 1 pontozóból, 2 laposvágóból és 1 keresztvágóból álló készlet összetekkerhető poliészter tokban
- 3 csavarhúzó hasítottfejű csavarokhoz ● 3,5x100-5,5x125-6,5x150 mm
- 3 Phillips®-csavarhúzó ● PH0x60-PH1x80-PH2x100 mm
- 1 műszerész olló
- 16 csillag-villáskulcs 6-7-8-9-10-11-12-13-14-15-16-17-18-19-21-22 mm
- 1 fékes mérőszalag 5 mt
- 1 lakatos kalapács 300 g
- 1 Oldalsípófogó, kétkomponensű markolat ipari kivitel ≡ 160 mm
- 1 robusztus kombinált fogó kétkomponensű markolat ipari kivitel ≡ 180 mm

Beta-sz.

- 96BPC/SC9
- 1771
- 1048N
- 38/B6N
- 1260
- 1262
- 1128BMX
- 42
- 1692/5
- 1370
- 1082GBM
- 1150GBM

Ft

5990V1 216.100 059900001

A készletet a C99V1 termékkel együtt ajánljuk



5990V3

116 darabos szerszámkészlet a COMBO C99V3/2C szerszámdobozhoz EVA habszivacs tálcában

► Autójavító

Mennyiség/megnevezés

- 5 T - szárú imbuszkulcs műanyag markolattal
- 1 Állítható villáskulcs 250 mm
- 1 1/4"-os hajtószár
- 1 Fáziskereső ●
- 1 zseb vízmérték V-formájú mérőfelülettel mágneses
- 1 LED lámpa, robusztus eloxált alumíniumból
- 31 csavarhúzóbetét és mágneses gyorslazítású betéttartó, műanyag dobozban ● ○ + + + +
- 1 behajító betéttartó adapter
- 12 1/4"-os hatlapú dugókulcs ○ 4-4,5-5-5,5-6-7-8-9-10-11-12-13 mm
- 1 1/4" - os toldó 50 mm
- 1 1/4" - os toldó 100 mm
- 1 1/4"-os csúszkás T-hajtószár
- 1 1/4" irányváltós racsnit, 72 fogas mechanizmus ⊕
- 38 Bimateriál-műszerész csavarhúzó 36 cserélhető 4 mm-es bit-tel és mágneses hosszabbítóval
- 1 műanyag kalapács Ø 35mm
- 1 1/4"-os csukló
- 13 1/2"-os hatlapú dugókulcs ○ 10-11-12-13-14-15-16-17-18-19-20-21-22 mm
- 1 1/2"-os toldó 125 mm
- 1 1/2"-os toldó 255 mm
- 1 1/2"-os csukló
- 1 1/2"-os csúszkás T-hajtószár
- 1 1/2"-os irányváltós racsnit ⊕

Beta-sz.

- 96T/S5P
- 111E
- 900BG/30
- 1253
- 1695XS
- 1833XS/2
- 860MIX/A31
- 895
- 900
- 900/20
- 900/20L
- 900/42
- 900/55Z
- 1256/C36-2
- 1390
- 900/25
- 920A
- 920/21
- 920/22
- 920/25
- 920/42
- 920/55

Ft

5990V3 306.700 059900003

A készletet a C99V3/2C termékkel együtt ajánljuk

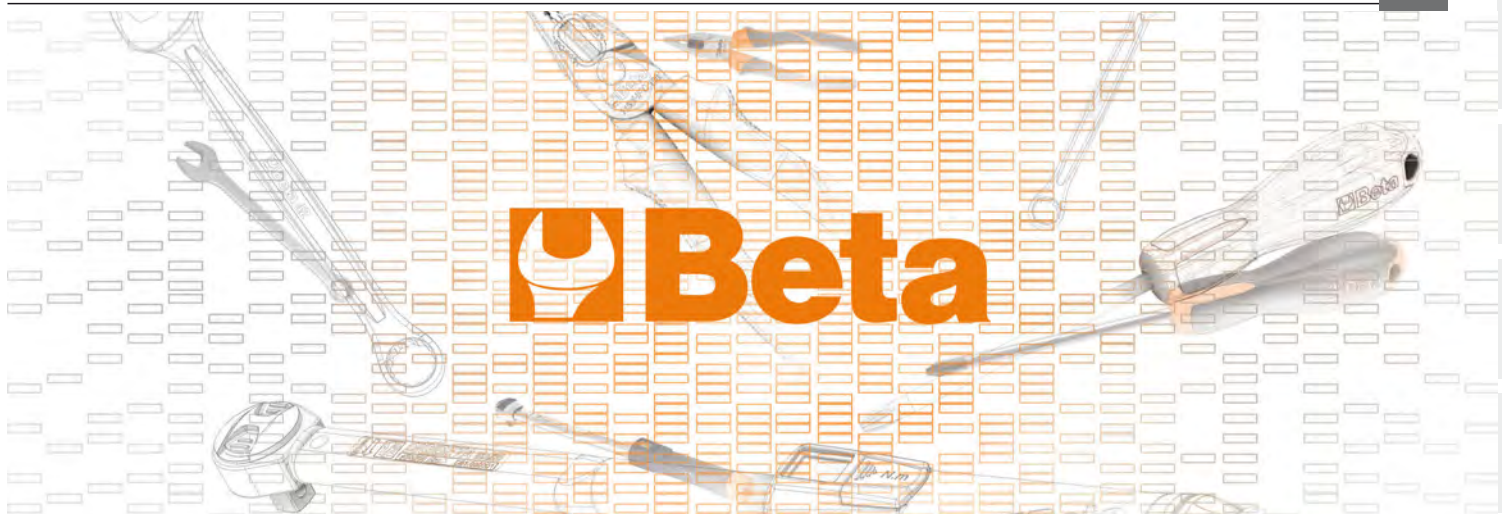



5980U/BIKE

kioldó nyomatékulcs kétirányú racsnival jobb és bal oldali meghúzáshoz, pontosság $\pm 6\%$ 2+10 Nm

► Kerékpárjavítás

Mennyiség/megnevezés	Beta-sz.
5 csillag-villáskulcs 8-9-10-13-14 mm	42
9 hajlított gömbfejú imbuszkulcs, bamított \odot 1,5-2-2,5-3-4-5-6-8-10 mm	96BP/SC9
8 T - szárú imbuszkulcs műanyag markolattal 2-2,5-3-4-5-6-8-10 mm	96T/S8
8 Imbusz csavarhúzókészlet Torx®-csavarokhoz \odot T8-T10-T15-T20-T25-T27-T30-T40	97TTX/S8
1 Széles nyílású állítható villáskulcs, krómozott, rövid sorozat 170 mm	111CM
1 Csővágó réz és könnyűfém csövekhez	334
1 kioldó nyomatékulcs kétirányú racsnival jobb és bal oldali meghúzáshoz meghúzási pontosság $\pm 6\%$ 2+10 Nm	605E
13 \odot 4-4,5-5-5,5-6-7-8-9-10-11-12-13-14 mm	900/SB13
1 1/4" - os toldó	900/21
1 1/4"-os csukló	900/25
1 1/2"-os irányváltós racsni \oplus	900/55
1 oldalcsípőfogó, csúszásmentes kétrétegű PVC bevonatú markolat ipari kivitel ∇ 160 mm	1082G
1 Egyenes élű műszerész olló 145 mm	1128BM
1 robusztus kombinált fogó csúszásmentes kétrétegű PVC bevonatú markolat ipari kivitel \equiv 180 mm	1150G
1 egyenes extra hosszú félkeresőrű fogó, csúszásmentes kétrétegű PVC bevonatú markolat ipari kivitel \bullet 180 mm	1166G
7 3x75-4x125-5,5x150-6,5x150-PH0x60-PH1x80-PH2x100 mm	1203E/D
1 lakatos kalapács 300 g	1370
1 műanyag kalapács \emptyset 35 mm	1390
1 tolómérő 150 mm	1650
1 fékes mérőszalag 3 m	1692/3
1 lapos egyengető reszelő markolattal 200 mm	1719BMA...P
1 félkerek egyengető reszelő markolattal 200 mm	1719BMA...M
1 kerek egyengető reszelő markolattal 200 mm	1719BMA...R
1 fűrész 300 mm	1725
1 dekorkés	1771
1 lánckopás jelző 120 mm	3935
1 patentszem fogó 170 mm	3937
7 darabos egyszerű kúpos kulcs készlet 13-14-15-16-17-18-19 mm	3952/S7
1 pedálkulcs 15 mm	3953
1 fekete küllőhúzó kulcs 3,2 mm \square	3961 3,2
1 zöld küllőhúzó kulcs 3,3 mm \square	3961 3,3
1 piros küllőhúzó kulcs 3,5 mm \square 3	3961 3,5
1 professzionális küllőhúzó kulcs 3,2 - 4,0 mm \square 3,2 - 4,0 mm	3961U
1 fogaskerék leszedő láncos kulcs 289 mm	3967
1 gumiszerelő vas 200 mm	3969
3 db gumiszerelő, műanyag 113 mm	3969K3
1 tárcsafék betét hátrahúzó kar 222 mm	3991
1 kulcs féktárcsa egyenesbe állításához 234 mm	3992

Ft



5980U/BIKE

543.000 059801040

A C16 - CP17 - CP17L - C20L szerszámokcsikhoz ajánlott készlet

5988H/7M

333 darabos szerszámkészlet habszivacs tálcában

► Autójavító

Mennyiség/megnevezés

- 13 Hatlapú dugókulcs, hosszított kivitel ○ 8-9-10-11-12-13-14-15-16-17-19-21-22 mm
- 16 Hatlapú dugókulcs ○ 10-12-13-14-15-16-17-18-19-21-22-23-24-27-30-32 mm
- 7 1/2"-os Torx®-dugókulcs ○ E12-E14-E16-E18-E20-E22-E24
- 10 1/2"-os színes hatszögű csavarhúzóbetét ○ 5-6-6L-7-8-8L-10-10L-12-12L mm
- 13 1/2"-os Torx®-imbusz-dugókulcs ○ T20-T25-T27-T30-T30L-T40-T40L-T45-T50-T50L-T55-T60-T60L
- 8 1/2"-os XZN®-profilú imbusz-dugókulcs, krómzott, barnított fej ○ 5-6-6L-8-8L-10-10L-12L mm
- 18 csillag-viláskulcs 6-7-8-9-10-11-12-13-14-15-16-17-18-19-21-22-24-27 mm
- 7 hajlított csillagkulcs 6x7-8x9-10x11-12x13-14x15-16x17-18x19 mm
- 1 Adapter gyorscsatlakozóval 1/4" 10 mm-es racsnikulcsához
- 1 Adapter gyorscsatlakozóval 3/8" 13 mm-es racsnikulcsához
- 1 Adapter gyorscsatlakozóval 1/2" 19 mm-es racsnikulcsához
- 12 Csillag-viláskulcs irányváltós racsival 8-9-10-11-12-13-14-15-16-17-18-19 mm
- 9 Hajlított gömbfejű imbuszkulcs ○ 1,5-2-2,5-3-4-5-6-8-10 mm
- 1 behajtott betéttartó adapter ○ 1/4-□1/4
- 1 behajtott betéttartó adapter ○ 1/4-□3/8
- 1 behajtott betéttartó adapter ○ 5/16-□1/2
- 13 1/4"-os hatlapú dugókulcs ○ 4-4,5-5-5,5-6-7-8-9-10-11-12-13-14 mm
- 9 ○ 5-6-7-8-9-10-11-12-13 mm
- 4 csavarhúzó-dugókulcs hasítottfejű csavarokhoz, krómzott, barnított hegy ● 0,8x4-1x5,5-1,2x6,5-1,2x8 mm
- 5 1/4"-os imbusz-dugókulcs ○ 3-4-5-6-7 mm
- 4 csavarhúzó-dugókulcs Phillips®-csavarokhoz, krómzott, barnított hegy ● PH1-PH2-PH3-PH4
- 7 1/4"-os Torx®-imbusz dugókulcs, krómzott, fekete hegyek ○ T10-T15-T20-T25-T27-T30-T40
- 1 Bővítő közbetét 1/4" - 3/8" □1/4-■3/8
- 3 1/4" - os toldó 50-100-150 mm
- 1 1/4"-os csukló
- 1 1/4"-os csúszkás T-hajtószer
- 1 1/2"-os irányváltós racsni ⊗
- 1 1/4"-os hajtószer
- 17 Hatlapú dugókulcs 3/8" ○ 6-7-8-9-10-11-12-13-14-15-16-17-18-19-20-21-22 mm
- 1 Szűkítő közbetét 3/8" és 1/4" □3/8-■1/4
- 1 Szűkítő közbetét, belső 1/2", külső 3/8" □3/8-■1/2
- 1 Toldó - 3/8" 125 mm
- 1 Toldó - 3/8" 250 mm
- 1 Csukló 3/8"
- 1 Csúszkás T - hajtószer 3/8"
- 1 3/8" irányváltós racsni ⊗
- 21 1/2"-os hatlapú dugókulcs ○ 8-10-11-12-13-4-15-16-17-18-19-20-21-22-23-24-26-27-28-30-32 mm
- 2 1/2" Gömbvégű toldó 125-250 mm
- 1 szűkítő közbetét 1/2" és 3/8" □1/2-■3/8
- 1 1/2"-os csukló
- 1 1/2"-os csúszkás T-hajtószer
- 1 1/2"-os irányváltós racsni ⊗
- 3 3/8" - os gyertya - dugókulcs ○ 16-17,8-20,8 mm
- 31 30 csavarhúzóbetét és mágneses gyorslazítású betéttartó, műanyag dobozban ● ○ ⊕ ⊙ ⊕
- 1 vízpumpafogó 250 mm
- 1 Oldalsípofogó ≡ 160 mm
- 1 kombinált fogó ≡ 180 mm
- 1 Extra hosszú laposfogó ≡ 160 mm
- 5 Csavarhúzó Phillips®-csavarokhoz ● 3x75-4x100-5,5x100-6,5x150-8x150 mm
- 1 Csavarhúzó hasítottfejű csavarokhoz, extra rövid penge ● 6,5x30 mm
- 3 Csavarhúzó Phillips®-csavarokhoz ⊕ PH1-PH2-PH3
- 1 Csavarhúzó Phillips®-csavarokhoz, extra rövid penge ⊕ PH2
- 4 Imbusz csavarhúzókészlet Torx®-csavarokhoz ○ T20-T25-T27-T30
- 6 hosszú kiűtő 2-3-4-5-6-8 mm
- 1 pontozó 4 mm
- 3 laposvágó 125-150-75 mm
- 1 keresztvágó 125 mm
- 2 lakatos kalapács 500-1000 g
- 1 flexibilis teleszkópos mágneses csavarkiszdedő
- 1 műanyag kalapács Ø 35 mm
- 1 fékes mérőszalag 5 m
- 1 egyenes belső Seeger-fogó ○ 180 mm
- 1 hajlított belső Seeger - fogó ○ 170 mm
- 1 egyenes külső Seeger-fogó ● 175 mm
- 1 hajlított külső Seeger - fogó ● 175 mm
- 1 Behajtható pengéjű kábelblankoló kés ● 140 mm
- 1 elektronikai oldalsípofogó ≡ 125 mm
- 4 csavarhúzó ● 2,0-2,5-3,0-3,5 mm
- 2 Phillips® műszerész csavarhúzó ⊕ 0-00
- 9 Imbusz csavarhúzókészlet Torx®-csavarokhoz ○ T10-T15-T20-T25-T27-T30-T40-T45-T50
- 1 Egyenes pófajú önzáró fogó 240 mm
- 1 állítható hosszúcsőrű önzárófogó 175 mm
- 1 Tömlőzáró fogó
- 1 tolómérő
- 1 tolómérő
- 1 tolómérő
- 1 Hézagmérő
- 1 Hántoló tömitéshez
- 7 Kettős csuklós dugókulcs 6x7-8x9-10x11-12x13-14x15-16x17-18x19 mm
- 1 1/2"-os csuklós hajtószer, krómzott
- 1 szerelővas 450 mm
- 1 teleszkópos vizsgáló tükör 670 mm
- 1 reszelő 200 mm
- 1 reszelő 200 mm
- 1 reszelő 200 mm
- 1 reszelő 200 mm
- 1 Acél drótkefe

Beta-sz.	TR
910AL	M125
920AL	M125
920FTX	M125
920PE	M125
920TX	M125
920XZN	M125
42	M25
90	M25
123Q1/4	M25
123Q3/8	M25
123Q1/2	M25
142	M25
96BPC/SC9	M105
895/1	M105
895/3	M105
895/6	M105
900	M105
900L	M105
900LP	M105
900ME	M105
900PH	M105
900TX	M105
900/16	M105
900/...	M105
900/25	M105
900/42	M105
900/55	M105
900BG/30	M105
910A	M105
910/15	M105
910/16	M105
910/21	M105
910/22	M105
910/25	M105
910/42	M105
910/55	M105
920A	M105
920AN	M105
920/15	M105
920/25	M105
920/42	M105
920/55	M105
956E	M105
860MX/A31	M166
1048N	M166
1082BM	M166
1150BM	M166
1162BM	M166
1290	M166
1290N	M166
1292	M166
1292N	M166
1297TX	M166
31	M231
32	M231
34	M231
36	M231
1370	M231
1712TF	M231
1390	M231
1692	M125
1032	M62
1034	M62
1036	M62
1038	M62
1177BM	M62
1188BM	M62
1257LP	M62
1257PH	M62
977TX	M62
1052	M78
1058	M78
1481PL/A	M78
1481PL/B	M78
1481PL/C	M78
1650	M78
1708/20	M78
1716P	M78
80	M78
920/36A	M78
965	M78
1715	M231
1719BMA8/M	M231
1719BMA8/P	M231
1719BMA8/Q	M231
1719BMA8/R	M231
1719BMA8/T	M231
1737NX	M231

Ft

5988H/7M 1.781.800 059881087

RSC24/8 - RSC24A/8 - RSC24A-XL - C37/8 - C39/8 -RSC28 - C59B - RSC50 C8 - RSC50 M8 - C55C8 - C55M8 szerszámokcikkhoz ajánlott készlet

M78

5988L/4M

273 darabos szerszámkészlet EVA habszivacs tálcában

► Autójavító

Mennyiség/megnevezés

- 13 1/4"-os hatlapú dugókulcs \odot 4-4,5-5-5,5-6-7-8-9-10-11-12-13-14 mm
 9 \odot 5-6-7-8-9-10-11-12-13 mm
 9 Hajlítot gőmbfejű imbuszkulcs \odot 1,5-2-2,5-3-4-5-6-8-10 mm
 1 behajtó betéttartó adapter
 1 behajtó betéttartó adapter
 1 behajtó betéttartó adapter
 5 1/4"-os imbusz-dugókulcs \odot 3-4-5-6-7 mm
 4 csavarhúzó-dugókulcs hasítottfejű csavarokhoz, krómozott, barnított hegy \bullet 0,8x4-1x5,5-1,2x6,5-2x8 mm
 4 csavarhúzó-dugókulcs Phillips®-csavarokhoz, krómozott, barnított hegy \oplus PH1-PH2-PH3-PH4
 7 1/4"-os Torx®-imbusz dugókulcs, krómozott, fekete hegyek \odot T10-T15-T20-T25-T27-T30-T40
 1 Bővítő közbetét 1/4" - 3/8" \square 1/4 - \blacksquare 3/8
 3 1/4" - os toldó 50-100-150 mm
 1 1/4"-os csukló
 1 1/4"-os hajtószár
 1 1/4"-os csúszkás T-hajtószár
 1 1/2"-os irányváltós racsni \oplus
 17 Hatlapú dugókulcs 3/8" \odot 6-7-8-9-10-11-12-13-14-15-16-17-18-19-20-21-22 mm
 1 Szűkítő közbetét 3/8" és 1/4" \square 3/8 - \blacksquare 1/4
 1 Szűkítő közbetét, belső 1/2", külső 3/8" \square 3/8 - \blacksquare 1/2
 1 Toldó - 3/8" 125 mm
 1 Toldó - 3/8" 250 mm
 1 Csukló 3/8"
 1 Csúszkás T - hajtószár 3/8"
 1 3/8" irányváltós racsni \oplus
 17 1/2"-os hatlapú dugókulcs \odot 8-10-11-12-13-14-15-16-17-18-19-20-21-22-23-24-26-27-28-30-32 mm
 1 szűkítő közbetét 1/2" és 3/8" \square 1/2 - \blacksquare 3/8
 1 Csukló 3/8"
 2 1/2" Gőmbvégű toldó 125 - 250 mm
 1 1/2"-os csúszkás T-hajtószár
 1 1/2"-os irányváltós racsni \oplus
 3 3/8" - os gyertya - dugókulcs \odot 16-17,8-20,8 mm
 13 Hatlapú dugókulcs, hosszított kivitel \odot 8-9-10-11-12-13-14-15-16-17-19-21-22 mm
 10 1/2"-os színes hatszögű csavarhúzóbetét \odot 5-6-6L-7-8-8L-10-10L-12-12L mm
 7 1/2"-os Torx®-dugókulcs \odot E12-E14-E16-E18-E20-E22-E24
 13 1/2"-os Torx®-imbusz-dugókulcs \odot T20-T25-T27-T30-T30L-T40-T40L-T45-T50-T50L-T55-T60-T60L
 8 1/2"-os XZN®-profilú imbusz-dugókulcs, krómozott, barnított fej \odot 5-6-6L-8-8L-10-10L-12L mm
 16 hatlapú dugókulcs \odot 10-12-13-14-15-16-17-18-19-21-22-23-24-27-30-32 mm
 1 fékes mérőszalag 5 m
 18 csillag-villáskulcs 6-7-8-9-10-11-12-13-14-15-16-17-18-19-21-22-24-27 mm
 7 hajlítot csillagkulcs 6x7-8x9-10x11-12x13-14x15-16x17-18x19 mm
 1 Adapter gyorscsatlakozóval 1/4" 10 mm-es racsnikulcschoz
 1 Adapter gyorscsatlakozóval 3/8" 13 mm-es racsnikulcschoz
 1 Adapter gyorscsatlakozóval 1/2" 19 mm-es racsnikulcschoz
 12 Csillag-villáskulcs irányváltós racsni 8-9-10-11-12-13-14-15-16-17-18-19 mm
 31 30 csavarhúzóbetét és mágneses gyorslazítású betéttartó, műanyag dobozban \bullet \odot \oplus \oplus \oplus
 1 vízpumpafogó 250 mm
 1 Oldalsípőfogó \ddagger 160 mm
 1 kombinált fogó \equiv 180 mm
 1 Extra hosszú laposfogó \equiv 160 mm
 5 Csavarhúzó Phillips®-csavarokhoz \bullet 3x75-4x100-5,5x100-6,5x150-8x150 mm
 1 Csavarhúzó hasítottfejű csavarokhoz, extra rövid penge \bullet 6,5x30 mm
 3 Csavarhúzó Phillips®-csavarokhoz \oplus 4,5x80-6x100-8x150 mm
 1 Csavarhúzó Phillips®-csavarokhoz, extra rövid penge \oplus 6x30 mm
 4 Imbusz csavarhúzókészlet Torx®-csavarokhoz \odot T20-T25-T27-T30

Beta-sz.	TR
900	M105
900L	M105
96BPC/SC9	M105
895/1	M105
895/3	M105
895/6	M105
900ME	M105
900LP	M105
900PH	M105
900TX	M105
900/16	M105
900/...	M105
900/25	M105
900BG/30	M105
900/42	M105
900/55	M105
910A	M105
910/15	M105
910/16	M105
910/21	M105
910/22	M105
910/25	M105
910/42	M105
910/55	M105
920A	M105
920/15	M105
910/25	M105
920AN	M105
920/42	M105
920/55	M105
956E	M105
910AL	M125
920PE	M125
920FTX	M125
920TX	M125
920XZN	M125
920AL	M125
1692/5	M125
42	M25
90	M25
123Q1/4	M25
123Q3/8	M25
123Q1/2	M25
142	M25
860MIX/A31	M166
1048N	M166
1082BM	M166
1150BM	M166
1162BM	M166
1290	M166
1290N	M166
1292	M166
1292N	M166
1297TX	M166



M105



M125



M25



M166

Ft

5988L/4M

1.200.700 059881088

A készletet a következő elemekhez ajánljuk: RSC24 - RSC24A - RSC24A-XL - RSC24L - RSC24L/CAB - C37 - C39 - C39T - C39SM - C39MD - RSC50 - RSC55 - C59

5988U6/M

214 darabos szerszámkészlet habszivacs tálcában

► Univerzális alkalmazás

Mennyiség/megnevezés

- 22 csillag-villáskulcs 6-7-8-9-10-11-12-13-14-15-16-17-18-19-20-21-22-24-27-30-32-36 mm
 11 villáskulcs 6x7-8x9-10x11-12x13-14x15-16x17-18x19-20x22-21x23-24x27-30x32 mm
 11 hajlított csillagkulcs 6x7-8x9-10x11-12x13-14x15-16x17-18x19-20x22-21x23-24x27-30x32 mm
 9 Hajlított gömbfejű imbuszkulcs \odot 1,5-2-2,5-3-4-5-6-8-10 mm
 6 csavarhúzó hasítottfejű csavarokhoz \bullet 2,5x50-3x75-4x100-5,5x125-6,5x150-8x200 mm
 1 csavarhúzó hasítottfejű csavarokhoz, extra rövid \bullet 4x30 mm
 4 csavarhúzó keresztfejű Phillips® csavarokhoz \oplus PH0x60-PH1x80-PH2x100-PH3x150 mm
 1 csavarhúzó keresztfejű Phillips® csavarokhoz, extra rövid \oplus PH1x30 mm
 12 imbusz-csavarhúzó Torx®-csavarokhoz \odot T6-T7-T8-T9-T10-T15-T20-T25-T27-T30-T40-T45
 1 Fáziskereső \bullet
 3 kiütő \varnothing 2-3-4 mm
 6 hosszú kiütő \varnothing 2-3-4-5-6-8 mm
 1 pontozó \varnothing 4 mm
 1 laposvágó 150 mm
 2 erősített laposvágó 200-250 mm
 1 keresztvágó 125 mm
 1 lakatos kalapács 500 g
 1 műanyag kalapács \varnothing 35 mm
 1 fékes mérőszalag 3 m
 1 flexibilis teleszkópos mágneses csavarkiszedő
 1 szögletes egyengető reszelő markolattal 200 mm
 1 háromszög egyengető reszelő markolattal 200 mm
 1 lapos egyengető reszelő markolattal 200 mm
 1 félkerek egyengető reszelő markolattal 200 mm
 1 kerek egyengető reszelő markolattal 200 mm
 1 Acél drótkéfe
 1 dekorkés 18 mm
 1 egyenes belső Seeger-fogó \odot 180 mm
 1 hajlított belső Seeger - fogó \odot 170 mm
 1 egyenes külső Seeger-fogó \bullet 175 mm
 1 hajlított külső Seeger - fogó \bullet 175 mm
 1 vízpumpafogó 250 mm
 1 Egyenes pófájú önzáró fogó 240 mm
 1 Oldalcspifogó \ddagger 160 mm
 1 Rabsz-fogó, lakkozott 220 mm
 1 bádogos lemezolló 250 mm
 1 Egyenes élű műszerész olló
 1 kombinált fogó \equiv 180 mm
 1 Egyenes extra hosszú félkerekcsőrű fogó \bullet 160 mm
 1 Hajlított extra hosszú félkerekcsőrű fogó \bullet 160 mm
 1 behajtó betéttartó adapter
 1 behajtó betéttartó adapter
 1 behajtó betéttartó adapter
 13 1/4"-os hatlapú dugókulcs \odot 4-4,5-5-5,5-6-7-8-9-10-11-12-13-14 mm
 9 \odot 5-6-7-8-9-10-11-12-13 mm
 5 1/4"-os imbusz-dugókulcs \odot 3-4-5-6-7 mm
 4 csavarhúzó-dugókulcs hasítottfejű csavarokhoz, krómzott, barnított hegy \bullet 0,8x4-1x5,5-1,2x6,5-1,2x8 mm
 4 csavarhúzó-dugókulcs Phillips®-csavarokhoz, krómzott, barnított hegy \oplus PH1-PH2-PH3-PH4
 7 1/4"-os Torx®-imbusz dugókulcs, krómzott, fekete hegyek \odot T10-T15-T20-T25-T27-T30-T40
 1 1/4" - os toldó 50 mm
 1 1/4" - os toldó 100 mm
 1 1/4" - os toldó 150 mm
 1 1/4"-os csukló
 1 1/4"-os hajtószár
 1 1/4"-os csúszkás T-hajtószár
 1 1/2"-os irányváltós racsni \oplus
 21 1/2"-os hatlapú dugókulcs \odot 8-10-11-12-13-14-15-16-17-18-19-20-21-22-23-24-26-27-28-30-32 mm
 1 szűkítő közbetét 1/2" és 3/8" 125 mm
 1 1/2"-os csukló 250 mm
 1 1/2" Gömbvégű toldó
 1 1/2" Gömbvégű toldó
 1 1/2"-os csúszkás T-hajtószár
 1 1/2"-os irányváltós racsni \oplus
 8 1/2"-os Torx®-dugókulcs \odot 10-12-14-16-18-20-22-24 mm
 11 hatlapú dugókulcs \odot 10-12-13-14-15-16-17-18-19-21-22 mm

Beta-sz.	TR
42	M01
55	M30
90	M30
96BPC/SC9	M30
1201E	M213
1201EN	M213
1202E	M213
1202EN	M213
1207E/TX	M213
1253	M213
30	M230
31	M230
32	M230
34	M230
35	M230
36	M230
1370	M230
1390	M230
1692	M230
1712TF	M230
1719BMA...Q	M230
1719BMA...T	M230
1719BMA...P	M230
1719BMA...M	M230
1719BMA...R	M230
1737NX	M230
1771	M230
1032	M129
1034	M129
1036	M129
1038	M129
1048N	M129
1052	M129
1082BM	M129
1098	M129
1112	M129
1128BM	M129
1150BM	M129
1166BM	M129
1168BM	M129
895/1	M100
895/3	M100
895/6	M100
900	M100
900L	M100
900ME	M100
900LP	M100
900PH	M100
900TX	M100
900/20	M100
900/20L	M100
900/21	M100
900/25	M100
900BG/30	M100
900/42	M100
900/55	M100
920A	M100
920/15	M100
920/25	M100
920AN/125	M100
920AN/250	M100
920/42	M100
920/55	M100
920FTX	M100
920AL	M100



M01



M30

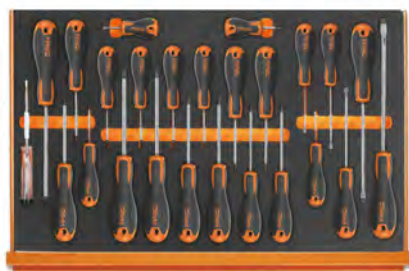

M213



M230



M129



M100

Ft

5988U6/M 1.036.600 059881430

Készletértéslési javaslat RSC24 8 fiókkal - RSC24/A 8 fiókkal - C37 8 fiókkal - C39 8 fiókkal
 RSC24A-XL - RSC28 - C39SM - C39MO - C59B - RSC50 - RSC55

5935ET/1MB

95 darabos szerszámkészlet a C35 szerszámszekrényhez habszivacs tálcában

► Elektrotechnikai karbantartás

Mennyiség/megnevezés

- 1 Egyenes pófájú önzáró fogó 240 mm
- 1 lakatos kalapács 500 g
- 1 műanyag kalapács Ø 35 mm
- 1 szögletes egyengető reszelő markolattal 200 mm
- 1 lapos egyengető reszelő markolattal 200 mm
- 1 háromszög egyengető reszelő markolattal 200 mm
- 1 félkerek egyengető reszelő markolattal 200 mm
- 1 kerek egyengető reszelő markolattal 200 mm
- 1 erősített laposvágó 200 mm
- 1 egyenes belső Seeger-fogó Ⓞ 180 mm
- 1 hajlított belső Seeger - fogó Ⓞ 170 mm
- 1 egyenes külső Seeger-fogó ● 175 mm
- 1 hajlított külső Seeger - fogó ● 175 mm
- 1 Erősített oldalcsipőfogó † 160 mm
- 1 kombinált fogó = 180 mm
- 1 Egyenes extra hosszú félkerekcsőrű fogó ● 160 mm
- 9 Hajlított gömbfejű imbuszkulcs ○
- 1 normál csavartartó csavarhúzó ⊕
- 1 Phillips® - csavartartó csavarhúzó ⊕
- 1 Fáziskereső ●
- 6 Hosszú dugókulcs - csavarhúzó ○ 5,5-6-7-8-10-13 mm
- 4 Phillips® - csavarhúzó 1000V ⊕ PH0x60-PH1x80-PH2x100-PH3x150 mm
- 6 1000 V - os szigetelt csavarhúzó ● 2,5x75-3x100-4x100-5,5x125-6x150-8x175 mm
- 31 30 csavarhúzóbetét és mágneses gyorslazítású betéttartó, műanyag dobozban ● ○ ⊕ ⊕ ⊕ ⊕
- 1 VDE-mágneses betéttartó bimateriál-nyéllel Ⓜ
- 8 villáskulcs 6x7-8x9-10x11-12x13-14x15
16x17-18x19-20x22 mm
- 1 Vízpumpafogó, stifttel állítható, szigetelt, 1000V 250 mm
- 1 Oldalcsipőfogó 1000V † 140 mm
- 1 Egyenes élű műszerész olló
- 1 Szigetelt nyelű kábelvágó 230 mm
- 1 Kábelcsupaszoló fogó † 160 mm
- 1 Kombinált fogó 1000V = 180 mm
- 1 Egyenes félkerekcsőrű fogó, extra hosszú 1000V ● 160 mm
- 1 hajlított félkerekcsőrű fogó, extra hosszú, krómzott ● 160 mm
- 1 Állítható villáskulcs 1000V 250 mm
- 1 Kábelkés élvédővel 1000V
- 1 Hajlított csapos csipesz lekerekített fogazott hegygel 1000V
- 1 saruzófogó

Beta-sz.	TR
1052	MB65
1370	MB65
1390	MB65
1719BMA...Q	MB65
1719BMA...P	MB65
1719BMA...T	MB65
1719BMA...M	MB65
1719BMA...R	MB65
35	MB65
1032	MB65
1034	MB65
1036	MB65
1038	MB65
1084BM	MB65
1150BM	MB65
1166BM	MB65
96BPC/SC9	MB63
1250	MB63
1251	MB63
1253	MB63
943MQ	MB63
1272MQ	MB63
1274MQ	MB63
860MX/A31	MB63
850MQ	MB63
55	MB64
1048MQ	MB64
1082MQ	MB64
1128BSX	MB64
1132MQ	MB64
1142MQ	MB64
1150MQ	MB64
1166MQ	MB64
1168MQ	MB64
110MQ	MB64
1777MQ	MB64
993MQ	MB64
1602	MB64



MB65



MB64

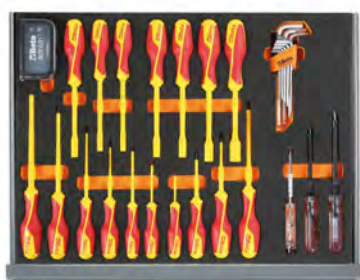

MB63

Ft

5935ET/1MB

662.400 059351332

Készletársítási javaslat C35

5980ET/A

70 darabos szerszámkészlet

► Elektrotechnika

Mennyiség/megnevezés	Beta-sz.
1 pontozó Ø 4 mm	32
1 erősített laposvágó 150 mm	35
8 villáskulcs, krómozott 6x7 - 8x9 - 10x11 - 12x13 - 14x15 - 16x17 - 18x19 - 20x22 mm	55/B8N
8 darabos hatszögű imbuszkulcskészlet, hosszított kivitel Ø 2+10 mm	96LC/SC8
1 Állítható villáskulcs 200 mm	111E
1 VDE-mágneses betéttartó bimateriál-nyéllel	850MQ
10 10 csavarhúzóbetét és mágneses betéttartó, műanyag dobozban	860MIX/A10
1 Vízpumpafogó, stifttel állítható, szigetelt, 1000V 250 mm	1048MQ
1 Oldalsípófogó 160 mm	1082BM
1 Egyenes élű műszerész olló	1128BSX
1 kábelvágó 170 mm	1132BM
1 kombinált fogó 180 mm	1150BM
1 Egyenes extra hosszú félkerékcserő fogó 160 mm	1166BM
1 Hajlított extra hosszú félkerékcserő fogó 160 mm	1168BM
1 normál csavartartó csavarhúzó 4x125 mm	1250
1 Phillips® - csavartartó csavarhúzó PH1x125 mm	1251
1 Fáziskereső	1253
5 csavarhúzó hasítottfejú csavarokhoz 2,5x75 - 3,5x100 - 5,5x125 - 6,5x150 mm	1201E
1 csavarhúzó hasítottfejú csavarokhoz, extra rövid 4x30 mm	1201EN
4 csavarhúzó keresztfejú Phillips® csavarokhoz PH0x60 - PH1x120 - PH2x150 - PH3x150 mm	1202E
1 csavarhúzó keresztfejú Phillips® csavarokhoz, extra rövid PH2x30 mm	1202EN
4 Phillips® - csavarhúzó 1000V PH0x60 - PH1x80 - PH2x100 - PH3x150 mm	1272MQ
5 1000 V - os szigetelt csavarhúzó 5,5x125 - 3x100 - 4x100 - 6,5x150 - 8x175 mm	1274MQ
1 Oldalvágó, krómozott	1343
1 lakatos kalapács 300 g	1370
1 műanyag kalapács Ø 35 mm	1390
1 saruzófogó	1602
1 25 m	BMESB1925NE
1 fékes mérőszalag 5 m	1692
1 félkerék egyengető reszelő markolattal 200 mm	1719BMA...M
1 kerék egyengető reszelő markolattal 200 mm	1719BMA...R
1 fűrész	1725
1 blankoló kés	1777BM



Ft

5980ET/A

343.900 059801083

Készletársítási javaslat C12 - 2028VV - 2032TV - 2032VV

5980ET/B

64 darabos szerszámkészlet

► Elektrotechnika

Mennyiség/megnevezés

- 3 hosszú kiütő Ø 2 - 3 - 4 mm
- 1 pontozó Ø 4 mm
- 1 laposvágó 150 mm
- 8 villáskulcs, krómozott 6x7 - 8x9 - 10x11 - 12x13 - 14x15 - 16x17 - 18x19 - 20x22 mm
- 9 Hajlított gömbfejű imbuszkulcs ○ 1,5 - 2 - 2,5 - 3 - 4 - 5 - 6 - 8 - 10 mm
- 1 Sorjázó 150 mm
- 6 Hosszú dugókulcs csavarhúzó 1000V ○ 5,5 - 6 - 7 - 8 - 10 - 13 mm
- 1 Vízpumpafogó, stífttel állítható, szigetelt, 1000V 250 mm
- 1 Oldalcspifogó 1000V ⚡ 160 mm
- 1 Egyenes élű műszerész olló
- 1 Szigetelt nyelű kábelvágó 230 mm
- 1 Kábelcsupaszoló fogó ⚡ 160 mm
- 1 Kombinált fogó 1000V = 180 mm
- 1 Egyenes félkeresőrű fogó, extra hosszú 1000V ● 160 mm
- 1 Fáziskereső ●
- 3 Phillips® - csavarhúzó 1000V ⊕ PH0x60 - PH1x80 - PH2x100 mm
- 4 1000 V - os szigetelt csavarhúzó ● 3x100 - 4x100 - 5,5x125 - 6,5x150 mm
- 1 lakatos kalapács 300 g
- 1 műanyag kalapács Ø 35 mm
- 1 saruzófogó
- 1 Rugalmas skálás vonalzó 250 mm
- 1 rajztű 250 mm
- 1 fékes mérőszalag 5 m
- 1 Vízmérték alumíniumból 200 mm
- 1 Villanszerelő laposvéső 10x200 mm
- 1 Csapózsínór
- 1 Flexibilis négyzet alakú vizsgálótűkör 600 mm
- 1 reszelő 200 mm
- 1 reszelő 200 mm
- 1 rugó beakasztó
- 1 fűrész
- 1 ecset
- 1 Kábelkötégető fogó
- 1 Olajozó műanyag flakon 80 cc
- 100 műanyag kábelkötégető szalag, fekete UV-álló 3,6x200 mm
- 100 műanyag kábelkötégető szalag, fekete UV-álló 4,8x300 mm
- 1 dekorkés
- 1 forrasztópáka 30 W
- 1 LED lámpa, robusztus eloxált alumíniumból

Beta-sz.
31
32
34
55/BN
96BPC/SC9
345SB
943MQ/S6
1048MQ
1082MQ
1128BSX
1132MQ
1142MQ
1150MQ
1166MQ
1253
1272MQ
1274MQ
1370
1390
1602
1682
1688
1692
1696
1701NE3
1705
1715FL/A
1719BMA8/M
1719BMA8/R
1723
1726BM
1738
1743
1755
1748N
1748N
1771BM
1814M
1833XS/2

Ft

5980ET/B

483.000 059801084

Készletlétszámsítási javaslat C12 - 2029/VV - 2033P/VV - 2036TV

5980MQ

46 darabos szerszámkészlet

► Elektrotechnika

Mennyiség/megnevezés

- 7 Egyoldalas villáskulcs 1000V 10 - 12 - 13 - 14 - 17 - 19 - 22 mm
- 1 Állítható villáskulcs 1000V 250 mm
- 6 Hosszú dugókulcs - csavarhúzó ○ 5,5 - 6 - 7 - 8 - 10 - 13 mm
- 4 T-szárú imbuszkulcs ○ 4 - 5 - 6 - 8 mm
- 1 Hajlított csapos csipesz lekerekített fogazott hegygel 1000V
- 1 Vízpumpafogó, stífttel állítható, szigetelt, 1000V 250 mm
- 1 Oldalcspifogó 1000V ⚡ 160 mm
- 1 Műszerészolló
- 1 Kábelcsupaszoló fogó ⚡ 160 mm
- 1 Kombinált fogó 1000V = 180 mm
- 1 Hajlított extra hosszú laposfogó = 160 mm
- 1 Egyenes félkeresőrű fogó, extra hosszú 1000V ● 160 mm
- 1 Fáziskereső ●
- 4 Phillips® - csavarhúzó 1000V ⊕ PH0x60 - PH1x80 - PH2x100 - PH3x150 mm
- 5 1000 V - os szigetelt csavarhúzó ● 3x100 - 4x100 - 5,5x125 - 6,5x150 - 8x175 mm
- 1 lakatos kalapács 300 g
- 1 műanyag kalapács Ø 35 mm
- 1 fékes mérőszalag 5 m
- 1 200 mm
- 1 Fűrész 1000V
- 2 Kábelkés élvédővel 1000V
- 1 forrasztópáka 30 W
- 1 LED zseblámpa intenzív fényerővel, robusztus eloxált alumíniumból, 500 lumenig
- 1 Kombinált feszültségvizsgáló műszer

Beta-sz.
52MQ
110MQ
943MQ
951MQ
993MQ
1048MQ
1082MQ
1128MQ
1142MQ
1150MQ
1164MQ
1166MQ
1253
1272MQ
1274MQ
1370
1390
1692
1701NE/3
1725MQ
1777MQ
1814M
1833S
1847P

Ft

5980MQ

659.000 059801257

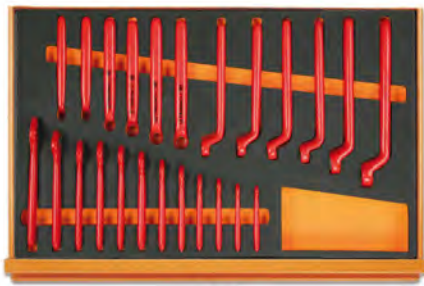

M49



M108



M161

5988 VHB-MQ

66 darabos szerszámkészlet EVA habszivacs tálcában

► Elektrotechnikai karbantartás

Mennyiség/megnevezés

- 12 Egyoldalas villáskulcs 1000V 7-8-10-11-12-13-14-15-16-17-19-22 mm
- 12 Egyoldalas csillagkulcs 7-8-10-11-12-13-14-15-16-17-19-22 mm
- 4 3/8"-os imbusz-dugókulcs \odot 4-5-6-8 mm
- 11 tizenkétszögű dugókulcs \odot 7-8-10-11-12-13-14-15-16-17-19 mm
- 6 dugókulcs Torx® csavarokhoz \odot T15-T20-T25-T27-T30-T40
- 2 Dugókulcs XZN® csavarokhoz \odot 8-10 mm
- 1 3/8"-os toldó 125 mm
- 1 3/8"-os toldó 250 mm
- 1 3/8"-os T-hajtószár
- 1 3/8" irányváltós racsnit
- 1 Műszerészolló
- 1 Vízpumpafogó, stífttel állítható, szigetelt, 1000V 250 mm
- 1 Oldalcsipőfogó 1000V ∇ 160 mm
- 1 Kombinált fogó 1000V \equiv 180 mm
- 1 Egyenes laposfogó, extra hosszú, krómozott \equiv 160 mm
- 1 Hajlított extra hosszú laposfogó \equiv 160 mm
- 4 Phillips® - csavarhúzó 1000V \oplus PH0x60 - PH1x80 - PH2x100 - PH3x150 mm
- 4 1000 V - os szigetelt csavarhúzó \bullet 2,5x75 - 3x100 - 4x100 - 5,5x125 mm
- 1 Kábelkés

Beta-sz.	TR
52MQ	M49
89MQ	M49
910MQ/PE	M108
910MQ/B	M108
910MQ/TX	M108
910MQ/XZN	M108
910MQ/21	M108
910MQ/22	M108
910MQ/T	M108
910MQ/55	M108
1128MQ	M161
1048MQ	M161
1082MQ	M161
1150MQ	M161
1162MQ	M161
1164MQ	M161
1272MQ	M161
1274MQ	M161
1777MQ/U	M161

Ft

5988 VHB-MQ 1.132.500 059880300

A készletet a következő elemekhez ajánljuk: RSC51 - RSC23T - RSC24 - RSC24A - RSC24A-XL - RSC24L - RSC24L/CAB RSC28 - C37 - C39 - C39SM - C39MD - C39T - RSC55 - RSC50 - C59

5980EL/A

57 darabos szerszámkészlet

► Elektronika

Mennyiség/megnevezés

- 13 4+14 mm
- 9 imbuszkulcs \odot 1,5+10 mm
- 1 hajlított fogazott csipesz 130 mm
- 1 egyenes végű csapos csipesz 150 mm
- 1 keresztcsipesz 155 mm
- 1 műszerész olló
- 1 kábelcsupaszoló fogó ∇ 160 mm
- 1 Egyenes extra hosszú félkerekcsőrű fogó \bullet 160 mm
- 1 hosszú elektronikai lapos fogó \equiv
- 1 Elektronikai hajlított félkerekcsőrű fogó, hosszított kivitel, polírozott \bullet
- 1 elektronikai kombinált fogó \bullet
- 1 elektronikai oldalcsipőfogó, keskeny ζ
- 1 elektronikai oldalcsipőfogó ζ
- 1 normál csavartartó csavarhúzó \bullet 4x125 mm
- 1 Phillips® - csavartartó csavarhúzó \oplus PH0x125 mm
- 8 csavarhúzó
- 1 lakatos kalapács 200 g
- 1 fékes mérőszalag 5 m
- 1 teleszkópos vizsgáló tükör
- 3 Túreszelők
- 1 rugó beakasztó
- 1 ecset
- 1 Olajbefecskendező
- 1 dekorkés
- 1 önzáró fogó lekerekített, recézett pófával, rozsdamentes acélból
- 1 forrasztópáka 25 W
- 1 ónszippantó
- 1 LED lámpa, robusztus eloxált alumíniumból

Beta-sz.
73/B13N
96N/SC9
991
992
998
1128BMX
1142BM
1166BM
1172BM
1178BM/P
1178BM
1185BM
1188BM
1250
1251
1257LPH/S8
1370
1692
1715
1720/S3
1723
1738
1756
1771
1002
1814M
1830T
1833XS/2

Ft

5980EL/A 336.500 059801081

Készletársítási javaslat 2032TV - 2028/WV - 2033P/VV

5980EL/B

98 darabos szerszámkészlet

► Elektronika

Mennyiség/megnevezés

Beta-sz.

13	4÷14 mm	73/B13N
9	imbuszkulcs \odot 1,5÷10 mm	96/SC9
8	Hajlított Torx® - imbuszkulcs \odot T9 - T10 - T15 - T20 - T25 - T27 - T30 - T40	97TX/BG8
1	Állítható villáskulcs 150 mm	111E
18	13 hatlapú dugókulcs és 5 tartozék, 1/4"	900/C13-5
1	Egyenes csipesz lekerekített hegygel 130 mm	990
1	hajlított fogazott csipesz 130 mm	991
1	Hegyes végű egyenes csipesz 120 mm	999A
1	műszerész olló	1128BMX
1	Automata vágó - és csupaszozó fogó 170 mm	1149F
1	kombinált fogó \equiv 180 mm	1150BM
1	hosszú elektronikai lapos fogó \equiv 140 mm	1172BM
1	Behajtható pengéjű kábelblankoló kés \bullet 140 mm	1177BM
1	Elektronikai hajlított félkerekcsőrű fogó, hosszított kivitel, polírozott \bullet 140 mm	1178BM/P
1	Speciális elektronikai oldalcsípőfogó, lekerekített pófával ζ 120 mm	1184BM
1	Speciális elektronikai oldalcsípőfogó, keskeny nyújtott pófával ζ 120 mm	1186BM
1	Speciális elektronikai homlokcsípőfogó, ferde vágóéllel ζ	1191BM
8	csavarhúzó	1257LPH/S8
1	Fáziskereső \bullet	1253
1	Csavarhúzó hasítottfejű csavarokhoz, extra rövid penge \bullet 6,5x30 mm	1290N
3	Csavarhúzó Phillips®-csavarokhoz \oplus PH0x60 - PH1x80 - PH2x100 mm	1292
2	Csavarhúzó Phillips®-csavarokhoz, extra rövid penge \oplus PH1x30 - PH2x30 mm	1292N
5	Csavarhúzó hernyócsavarokhoz \bullet 2,5x60 - 3x75 - 4x100 - 5x125 - 6,5x150 mm	1294
1	lakatos kalapács 200 g	1370
1	Rugalmas skálás vonalzó 150 mm	1682
1	rajztű 220 mm	1688
1	fékes mérőszalag 5 m	1692
1	teleszkópos vizsgáló tükör 670 mm	1715
1	Tűreszelők \bullet	1720R
1	Tűreszelők \blacktriangle	1720T
1	Tűreszelők \blacksquare	1720P
1	rugó beakasztó	1723
1	ecset	1738
1	Olajbefecskendező	1756
1	dekorkés	1771BM
1	blankoló kés	1777BM
1	önzáró fogó lekerekített, recézett pófával, rozsdamentes acélból	1002
1	forrasztópáka 25W	1814M
1	ónszippantó	1830T
1	LED lámpa, robusztus eloxált alumíniumból	1833XS/2



Ft



5980EL/B

465.800 059801082

Készletlátsítási javaslat 2029/VV - 2033P/VV - 2036TV

5980ID

35 darabos szerszámkészlet

► Víz- és gázszerelés

Mennyiség/megnevezés

- 1 laposvágó 150 mm
- 1 erősített laposvágó 200 mm
- 12 villáskulcs 6x7 - 8x9 - 10x11 - 12x13 - 14x15 - 16x17 - 18x19 - 20x22 - 21x23 - 24x27 - 25x28 - 30x32 mm
- 1 Állítható villáskulcs 250 mm
- 1 Csővágó réz és könnyűfém csövekhez Ø 3+30 mm
- 1 svéd csőfogó 320 mm
- 1 Egyenes pófájú önzáró fogó 240 mm
- 1 bádogos lemezolló 300 mm
- 1 műszerész olló
- 1 robusztus kombinált fogó kétkomponensű markolat ipari kivitel = 180 mm
- 4 csavarhúzó hasítottfejű csavarokhoz ● 3x75 - 4x100 - 5,5x150 - 8x150 mm
- 2 csavarhúzó keresztfejű Phillips® csavarokhoz ⊕ PH1x80 - PH2x100 mm
- 1 lakatos kalapács 300 g
- 1 Colstok 2 m
- 1 fékes mérőszalag 5 m
- 1 Vízmérték alumíniumból 200 mm
- 1 félkerek egyengető reszelő markolattal 200 mm
- 1 fűrés
- 1 Acél drótkefe
- 1 vízpumpafogó 250 mm

Beta-sz.

- 34
- 35
- 55/S12X
- 111E
- 334
- 374
- 1052
- 1112
- 1128BMX
- 1150GBM
- 1201E
- 1202E
- 1370
- 1690F
- 1692
- 1696
- 1719BMA...M
- 1725
- 1737NX
- 1048N

Ft



5980ID

222.500 059801085

Készletlétvási javaslat 2009N/VV

5902MT

106 darabos szerszámkészlet mezőgazdasági, építő és földmunka gépekhez

► Földmunkagépekhez

Mennyiség/megnevezés

- 2 kiütő Ø 3 - 4 mm
- 2 hosszú kiütő Ø 6 - 8 mm
- 1 pontozó Ø 4 mm
- 2 erősített laposvágó 150 - 200 mm
- 18 csillag-villáskulcs 6+14 - 17 - 19 - 22 - 24 - 27 - 30 - 32 - 36 - 41 mm
- 10 hajlított csillagkulcs 6x7 - 8x9 - 10x11 - 12x13 - 14x15 - 16x17 - 18x19 - 20x22 - 24x27 - 30x32 mm
- 10 imbuszkulcs ○ 1,5+12 mm
- 17 1/2"-os hatlapú dugókulcs ○ 10+22 - 24 - 27 - 30 - 32 mm
- 1 1/2"-os toldó 125 mm
- 1 1/2"-os toldó 255 mm
- 1 1/2"-os csukló
- 1 1/2"-os csúszkás T-hajtósár
- 1 1/2"-os átnyomós irányváltós racsnit
- 11 3/4"-os hatlapú dugókulcs ○ 22 - 24 - 27 - 30 - 32 - 36 - 41 - 46 - 50 - 55 - 60 mm
- 1 3/4"-os toldó 200 mm
- 1 3/4"-os csuklós hajtósár
- 1 3/4"-os csúszkás T - hajtósár
- 1 3/4"-os irányváltós racsnit
- 1 szerelővas
- 1 vízpumpafogó 250 mm
- 1 ívelt pófájú önzáró fogó
- 1 erősített oldalcsípőfogó, kétkomponensű markolat ipari kivitel 160 mm
- 1 műszerész olló
- 1 robusztus kombinált fogó kétkomponensű markolat ipari kivitel = 180 mm
- 1 egyenes extra hosszú félkerekcsőrű fogó, kétkomponensű markolat ipari kivitel ● 160 mm
- 4 Lapos csavarhúzó, hatlapfejű szárvégzördéssel ● 6,5x150 - 8x175 - 10x200 - 12x250 mm
- 3 Csavarhúzó Phillips® - csavarokhoz, hatszögű penge, ⊕ PH2x150 - PH3x175 - PH4x200 mm
- 1 amerikai gömbfejű kalapács 900 g
- 1 műanyag kalapács Ø 35 mm
- 1 Hézagmérő
- 1 háromélű hántoló 200 mm
- 5 5 darabos egyengető reszelő készlet markolattal 200 mm
- 1 fűrés

Beta-sz.

- 30
- 31
- 32
- 35
- 42
- 90
- 96N/B10
- 920A
- 920/21
- 920/22
- 920/25
- 920/42
- 920/50
- 928A
- 928/21
- 928/36A
- 928/42
- 928/55
- 964
- 1048N
- 1055
- 1084GBM
- 1128BMX
- 1150GBM
- 1166GBM
- 1260E
- 1262E
- 1377
- 1390
- 1708/20
- 1717B
- 1719BMA...S5
- 1725

Ft



5902MT

747.800 059021053

Készletlétvási javaslat RSC22 - RSC23 - RSC23C - C39T

5902MT/AS

99 darabos földmunkagépekhez (CATERPILLAR)

► Földmunkagépekhez

Mennyiség/megnevezés

Beta-sz.

2	kiütő Ø 3 - 4 mm	30
2	hosszú kiütő Ø 6 - 8 mm	31
1	pontozó Ø 4 mm	32
2	erősített laposvágó 150 - 200 mm	35
20	csillag-villáskulcs 1/4+1.1/2"	42AS
6	hajlított csillagkulcs 1/4x5/16 - 3/8x7/16 - 1/2x9/16 5/8x3/4 - 11/16x13/16 - 7/8x15/16"	90AS
11	imbuszkulcs Ø 3/64+3/8"	96AS/B11
10	1/2" - os tizenkétszögű dugókulcs Ø 7/16 - 1/2 - 9/16 5/8 - 11/16 - 3/4 - 13/16 - 7/8 - 15/16 - 1"	920AS
1	1/2"-os toldó 125 mm	920/21
1	1/2"-os toldó 255 mm	920/22
1	1/2"-os csukló	920/25
1	1/2"-os csúszkás T-hajtószer	920/42
1	1/2"-os átnyomós irányváltós racsnit	920/50
12	Hatlapú dugókulcs 1/4" ○ □ 3/4", 7/8 - 15/16 - 1 - 1.1/16 - 1.1/8 - 1.1/4 - 1.5/16 1.1/2 - 1.5/8 - 1.11/16 - 1.7/8 - 2"	928AS
1	3/4" - os toldó 200 mm	928/21
1	3/4"-os csuklós hajtószer	928/36A
1	3/4" - os csúszkás T - hajtószer	928/42
1	3/4" - os irányváltós racsnit	928/55
1	szereelővas	964
1	vízpumpa fogó 250 mm	1048N
1	ívelt pófajú önzáró fogó	1055
1	erősített oldalcsipőfogó, kétkomponensű markolat ipari kivitel 160 mm	1084GBM
1	műszerész olló	1128BMX
1	robustus kombinált fogó kétkomponensű markolat ipari kivitel 180 mm	1150GBM
1	egyenes extra hosszú félkerekcsőrű fogó, kétkomponensű markolat ipari kivitel 160 mm	1166GBM
4	Lapos csavarhúzó, hatlapfejű szárvégződésel ● 6,5x150 - 8x175 - 10x200 - 12x250 mm	1260E
3	Csavarhúzó Phillips® - csavarokhoz, hatszögű penge, ● PH2x150 - PH3x175 - PH4x200 mm	1262E
1	amerikai gömbfejű kalapács 900 g	1377
1	műanyag kalapács Ø 35 mm	1390
1	Hézagmérő 150 - 200 mm	1708/20
1	háromélű hántoló 200 mm	1717B
5	5 darabos egyengető reszelő készlet markolattal 200 mm	1719BMA...S5
1	fűrész	1725



Ft



5902MT/AS

780.000 059021054

Készletársítási javaslat RSC22 - RSC23 - RSC23C - C39T

5904VG/2M

170 darabos szerszámkészlet habszivacs tálcában

► Autójavító

Mennyiség/megnevezés

- 16 csillag-villáskulcs 6+21 mm
- 5 csillag-villáskulcs 22 - 24 - 27 - 30 - 32 mm
- 8 T - szárú imbuszkulcs műanyag markolattal \odot 2-2,5-3-4-5-6-7-8 mm
- 5 Imbusz csavarhúzókészlet Torx®-csavarokhoz \odot T10-T15-T20-T25-T30
- 7 Hatszögű csavarhúzóbetétek \odot 4-5-6-7-8-10-12 mm
- 7 Hatszögű csavarhúzóbetétek \odot 4-5-6-7-8-10-12 mm
- 5 Csavarhúzóbetétek XZN®-csavarhoz \odot 5-6-8-10-12 mm
- 5 Csavarhúzóbetétek XZN®-csavarhoz \odot 5-6-8-10-12 mm
- 7 Csavarhúzóbetétek Torx®-csavarhoz \odot T20-T25-T30-T40-T45-T50-T55
- 6 Csavarhúzóbetétek Torx®-csavarhoz \odot T25-T30-T40-T45-T50-T55
- 7 Csavarhúzóbetétek Tamper Resistant Torx®-csavarhoz \odot T20-T25-T30-T40-T45-T50-T55
- 1 Betéttartó a 867-es betétekhez
- 1 Betéttartó a 867-es betétekhez
- 5 csavarhúzó hasítottfejű csavarokhoz \bullet 3x75 - 3,5x100 - 4x125 - 5,5x150 - 6,5x150 mm
- 3 Phillips®-csavarhúzó \oplus PH0x60 - PH1x80 - PH2x100 mm
- 1 Lapos törpe csavarhúzó \bullet 4x30 mm
- 1 Csavarhúzó Phillips® - csavarokhoz, extra rövid penge \oplus PH1x30 mm
- 5 Színes csavarhúzóbetét hasítottfejű csavarokhoz \bullet 0,5x3 - 0,6x4,5 - 0,8x5,5 - 1x5,5 - 1,2x6,5 mm
- 8 Színes hatszögű csavarhúzóbetét \odot 2 - 2,5 - 3 - 4 - 5 - 6 - 8 - 10 mm
- 5 Színes csavarhúzóbetét Phillips®-csavarokhoz \oplus PH0 - PH1 - PH2 - PH3 - PH4
- 4 Színes csavarhúzóbetét Pozidriv®- és Supadriv®-csavarokhoz \oplus PZ1 - PZ2 - PZ3 - PZ4
- 11 Színes csavarhúzóbetét Torx®-csavarokhoz \odot T6-T7-T8-T9-T10-T15-T20-T25-T27-T30-T40
- 8 Színes csavarhúzóbetét Tamper Resistant Torx®-csavarokhoz \odot T9-T10-T15-T20-T25-T27-T30-T40
- 1 Betéttartó nyellel 230 mm
- 1 Irányváltós racsni, betéttartóval 100 mm
- 1 Mágneses betéttartó 80 mm
- 1 Adapter dugókulcshoz \blacksquare 1/4 - \square 1/4
- 2 erősített laposvágó 100 - 200 mm
- 1 lakatos kalapács 300 g
- 1 műanyag kalapács \varnothing 35 mm
- 1 1/2" Gömbvégű toldó 125 mm
- 1 1/2" Gömbvégű toldó 250 mm
- 1 1/2"-os csukló
- 1 1/2"-os csúszkás T-hajtószer
- 1 1/2"-os irányváltós racsni \odot
- 19 1/2"-os hatlapú dugókulcs \odot 10+24 - 26 - 27 - 30 - 32 mm
- 1 kombinált fogó \equiv 180 mm
- 1 Egyenes extra hosszú félkerecsőrű fogó \bullet 160 mm
- 1 Erősített oldalcsípőfogó \nlessgtr 160 mm
- 1 egyenes belső Seeger-fogó \odot 180 mm
- 1 hajlított belső Seeger - fogó \odot 170 mm
- 1 egyenes külső Seeger-fogó \bullet 175 mm
- 1 hajlított külső Seeger - fogó \bullet 175 mm

Beta-sz.	TR
42	M05
42	M06
96T	M50
97TTX	M55
867PE	M86
867PE/L	M86
867XZN	M86
867XZNL	M86
867TX	M86
867TXL	M86
867RTX	M86
867/1	M86
867/2	M86
1260	M208
1262	M208
1260N	M208
1262N	M208
860LP	M85
860PE	M85
860PH	M85
860PZ	M85
860TX	M85
860RTX	M85
851SR	M85
860/55	M85
882P	M85
892/0	M85
35	M234
1370	M234
1390	M234
920AN/125	M83
920AN/250	M83
920/25	M83
920/42	M83
920/55	M83
920A	M83
1150BM	M136
1166BM	M136
1084BM	M136
1032	M145
1034	M145
1036	M145
1038	M145



M05 M06 VPM3



M50 M55 M86



M208 M85 M234



M83 M136 M145

Ft



5904VG/2M

597.800 059041198

Készletlétjárás javaslat RSC24 - RSC24A - RSC24A-XL - C37 - C39

RSC24L - RSC24L/CAB - C59 - C39T - C39SM - C39MD - RSC23T - RSC28 - RSC50 - RSC55

5904VG/2T

99 darabos szerszámkészlet ABS hőformált tálcában

► Autójavító

Mennyiség/megnevezés

- 16 csillag-villáskulcs 6÷21 mm
- 5 csillag-villáskulcs 22 - 24 - 27 - 30 - 32 mm
- 19 1/2"-os hatlapú dugókulcs \odot 10÷24 - 26 - 27 - 30 - 32 mm
- 5 1/2"-os imbusz dugókulcs \odot 5 - 6 - 8 - 10 - 12 mm
- 1 1/2"-os toldó 125 mm
- 1 1/2"-os toldó 255 mm
- 1 1/2"-os csukló
- 1 1/2"-os csúszkás T-hajtószer
- 1 1/2"-os irányváltós racsnit \otimes
- 1 vízpumpafogó 250 mm
- 1 Egyenes pofájú önzáró fogó 240 mm
- 1 Erősített oldalcsípőfogó ∇ 160 mm
- 1 Egyenes extra hosszú félkerekcsőrű fogó \bullet 160 mm
- 1 kombinált fogó \equiv 180 mm
- 1 egyenes belső Seeger-fogó \odot 180 mm
- 1 egyenes külső Seeger-fogó \bullet 175 mm
- 1 hajlított belső Seeger - fogó \odot 170 mm
- 1 hajlított külső Seeger - fogó \bullet 175 mm
- 2 erősített laposvágó 100 - 200 mm
- 1 lakatos kalapács 300 g
- 1 műanyag kalapács \emptyset 35 mm
- 4 csavarhúzó hasítottfejű csavarokhoz \bullet 3x75 - 4x100 - 5,5x150 - 6,5x150 mm
- 3 Phillips®-csavarhúzó \oplus PH0x60 - PH1x80 - PH2x100 mm
- 8 villáskulcs 6x7 - 8x9 - 10x11 - 12x13 - 14x15 - 16x17 - 18x19 - 20x22 mm
- 9 imbusz kulcs \odot 1,5 - 2 - 2,5 - 3 - 4 - 5 - 6 - 8 - 10 mm
- 6 T - szárú imbusz kulcs műanyag markolattal \odot 2 - 2,5 - 3 - 4 - 5 - 6 mm
- 6 Imbusz csavarhúzókészlet Torx®-csavarokhoz \odot T10 - T15 - T20 - T25 - T27 - T30

Beta-sz.	TR
42	T05
42	T06
920A	T80
920ME	T80
920/21	T80
920/22	T80
920/25	T80
920/42	T80
920/55	T80
1048N	T153
1052	T153
1084	T138
1166	T138
1150	T138
1032	T145
1036	T145
1034	T145
1038	T145
35	T234
1370	T234
1390	T234
1260	T208
1262	T208
55	T33
96/SC9	T33
96T	T52
97TTX	T55



T05 T06 T80



T153 T138 T145 T234



T208 T33 T52 T55

Ft

5904VG/2T

498.000 059041191

Készletlétszám javaslata: RSC51 - RSC24 - RSC24A - RSC24A-XL - C37 - C39
RSC23T - C39T - RSC24L - RSC24L/CAB - C59 - RSC28 - C39SM - C39MD - RSC50 - RSC55

5904VG/3

132 darabos szerszámkészlet

► Autójavítás

Mennyiség/megnevezés

Beta-sz.

6	6 darabos kiütőkészlet tartós poliészterből készült összetekkerhető tokban Ø 2÷8 mm	31/B6N
1	pontozó Ø 5 mm	32
1	erősített laposvágó 200 mm	35
17	csillag-villáskulcs 6÷22 mm	42
8	villáskulcs 6x7 - 8x9 - 10x11 - 12x13 - 14x15 - 16x17 - 18x19 - 20x22 mm	55
9	imbuszkulcs Ø 1,5 - 2 - 2,5 - 3 - 4 - 5 - 6 - 8 - 10 mm	96N/SC9
11	T - szárú imbuszkulcs műanyag markolattal Ø 2÷10 mm	96T/SP11
13	Torx® imbuszkulcs Ø T6÷T50	97TX/B13
1	Állítható villáskulcs 300 mm	111E
13	1/2" - os hatlapú dugókulcs Ø 10÷22 mm	920A/SB13
1	1/2"-os toldó 125 mm	920/21
1	1/2"-os toldó 255 mm	920/22
1	1/2"-os csukló	920/25
1	1/2"-os csúszkás T-hajtószerű	920/42
1	1/2"-os átnyomós irányváltós racsnit	920/50
6	csuklós T - kulcs Ø 8 - 10 - 12 - 13 - 17 - 19 mm	952
1	szereelővas 450 mm	965
2	egyenes belső Seeger-fogó Ø 180 - 225 mm	1032
2	hajlított belső Seeger - fogó Ø 170 - 210 mm	1034
2	egyenes külső Seeger-fogó Ø 175 - 225 mm	1036
2	hajlított külső Seeger - fogó Ø 175 - 220 mm	1038
1	vízpumpa-fogó 250 mm	1048N
1	Egyenes pófajú önzáró fogó 240 mm	1057A
1	erősített oldalcsípőfogó, kétkomponensű markolat ipari kivitel 200 mm	1084GBM
1	áttételes homlokcsípőfogó 200 mm	1092V
1	bádogos lemezolló 250 mm	1112
1	műszerész olló	1128BMX
1	robosztus kombinált fogó kétkomponensű markolat ipari kivitel 180 mm	1150GBM
4	csavarhúzó hasítottfejű csavarokhoz	1260
	● 3x75 - 4x100 - 5,5x125 - 6,5x150 mm	
1	Lapos törpe csavarhúzó ● 6,5x30 mm	1260N
2	Lapos csavarhúzó, hatlapfejű szárvégzöldéssel ● 8x175 - 10x200 mm	1260E
3	Phillips®-csavarhúzó ● PH0x100 - PH1x120 - PH2x100 mm	1262
1	Csavarhúzó Phillips® - csavarokhoz, extra rövid penge ● PH2x30 mm	1262N
1	Csavarhúzó Phillips® - csavarokhoz, hatszögű penge, ● PH3x175mm	1262E
1	Csavarhúzó Phillips® - csavarokhoz, hosszú penge ● PH2x400 mm	1262L
1	Csavarhúzó hernyócsavarokhoz, hosszú penge ● 6,5x400 mm	1264L
1	lakatos kalapács 500 g	1370
1	műanyag kalapács Ø 45 mm	1390
1	fémzalagos olajsűrűsítő	1491
1	Hézagmérő	1708/20
5	5 darabos egyengető reszelő készlet markolattal 200 mm	1719BMA...S5
1	fűrész	1726BM
1	Olajozó fémkanna 200 cc	1751N



Ft



5904VG/3

851.700 059041062

Készletárrésztartási javaslat RSC24 - RSC24A - RSC24A-XL - C37 - C39 7 - 8 fiókkal
RSC24L - RSC24L/CAB - C59 - RSC50 - RSC55

5904VG/3T

102 darabos szerszámkészlet ABS hőformált tálcában

► Autójavító

Mennyiség/megnevezés

	Beta-sz.	TR
21 csillag-villáskulcs 6-7-8-9-10-11-12-13-14-15-16-17 18-19-20-21-22-24-27-30-32 mm	42	T05-T06
8 villáskulcs 6x7-8x9-10x11-12x13-14x15 16x17-18x19-20x22 mm	55	T33
9 imbuszkulcs \odot 1,5÷10 mm	96/SC9	T33
6 T - szárú imbuszkulcs műanyag markolattal \odot 2-2,5-3-4-5-6 mm	96T	T52
8 csuklós T - kulcs \odot 7-8-10-12-13-14-17-19 mm	952	T63
19 1/2"-os hatlapú dugókulcs \odot 10-11-12-13-14-15-16-17-18-19 20-21-22-23-24-26-27-30-32 mm	920A	T83
1 1/2"-os toldó 125 mm	920/21	T83
1 1/2"-os toldó 255 mm	920/22	T83
1 1/2"-os csukló	920/25	T83
1 1/2"-os csúszkás T-hajtószár 305 mm	920/42	T83
1 1/2"-os irányváltós racsnit \otimes	920/55	T83
1 Erősített oldalcsípőfogó \ddagger 160 mm	1084BM	T137
1 kombinált fogó \equiv 180 mm	1150BM	T137
1 Egyenes extra hosszú félkerekcsőrű fogó \bullet 160 mm	1166BM	T137
1 egyenes belső Seeger-fogó \odot 180 mm	1032	T145
1 hajlított belső Seeger - fogó \odot 170 mm	1034	T145
1 egyenes külső Seeger-fogó \bullet 175 mm	1036	T145
1 hajlított külső Seeger - fogó \bullet 175 mm	1038	T145
1 Egyenes pófajú önzáró fogó 240 mm	1052	T153
1 vízpumpafogó 250 mm	1048N	T153
7 csavarhúzó hasítottfejű csavarokhoz \bullet 2,5x50 -3x75 - 3,5x100 - 4x125 -5,5x100 - 5,5x150 - 6,5x150 mm	1260	T199
6 Phillips®-csavarhúzó \oplus PH0x60 - PH0x100 - PH1x80 PH1x120 - PH2x100 - PH2x150 mm	1262	T202
2 erősített laposvágó 100-200 mm	35	T234
1 lakatos kalapács 300 g	1370	T234
1 műanyag kalapács \varnothing 35 mm	1390	T234
1 hőformált szerszámtartó	VP5	



T199 T202 T83



T145 T153 T137 T234



T52 T33 T05 T06



T63 VP5

Ft

5904VG/3T

592.300 059041510

Készletlétszámjavaslat RSC24 - RSC24A - RSC24A-XL - C37 - C39
RSC24L - RSC24L/CAB - C59 - C23ST - C39T - C28 - C39SM - C39MD - RSC50 - RSC55

5904VG/5T

153 darabos szerszámkészlet ABS hőformált tálcában

► Autójavító

Mennyiség/megnevezés

- 5 1/2"-os imbusz dugókulcs \odot 5 - 6 - 8 - 10 - 12 mm
- 1 1/2"-os toldó 125 mm
- 1 1/2"-os toldó 255 mm
- 1 1/2"-os csukló
- 1 1/2"-os csúszkás T-hajtószár
- 1 1/2"-os irányváltós racsnit \otimes
- 19 1/2"-os hatlapú dugókulcs \odot 10+24 - 26 - 27 - 30 - 32 mm
- 16 csillag-villáskulcs 6+21 mm
- 5 csillag-villáskulcs 22 - 24 - 27 - 30 - 32 mm
- 8 csuklós T - kulcs \odot 7 - 8 - 10 - 12 - 13 - 14 - 17 - 19 mm
- 1 hőformált szerszámtartó
- 1 egyenes belső Seeger-fogó \odot 180 mm
- 1 hajlított belső Seeger - fogó \odot 170 mm
- 1 egyenes külső Seeger-fogó \bullet 175 mm
- 1 hajlított külső Seeger - fogó \bullet 175 mm
- 7 Csavarhúzó Phillips®-csavarokhoz \bullet 2,5x50 - 3x75 - 3,5x100 - 4x125 - 5,5x100 - 5,5x150 - 6,5x150 mm
- 5 Imbusz csavarhúzókészlet Torx®-csavarokhoz \odot T25 - T27 - T30 - T40 - T45
- 6 T - szárú imbuszkulcs műanyag markolattal \odot 2 - 2,5 - 3 - 4 - 5 - 6 mm
- 8 villáskulcs 6x7 - 8x9 - 10x11 - 12x13 - 14x15 - 16x17 - 18x19 - 20x22 mm
- 9 imbuszkulcs \odot 1,5 - 2 - 2,5 - 3 - 4 - 5 - 6 - 8 - 10 mm
- 3 Csavarhúzó Phillips®-csavarokhoz \bullet 8x150 - 8x200 - 10x200 mm
- 2 Csavarhúzó hasítottfejű csavarokhoz, extra rövid penge \bullet 4x30 - 6,5x30 mm
- 6 Csavarhúzó Phillips®-csavarokhoz \oplus PH0x60 - PH0x100 - PH1x80 - PH1x120 - PH2x100 - PH2x150 mm
- 2 Csavarhúzó Phillips®-csavarokhoz \oplus PH3x150 - PH4x200 mm
- 2 Csavarhúzó Phillips®-csavarokhoz, extra rövid penge \oplus PH1x30 - PH2x30 mm
- 2 erősített laposvágó 100 - 200 mm
- 1 lakatos kalapács 300 g
- 1 műanyag kalapács \varnothing 35 mm
- 1 kombinált fogó \equiv 180 mm
- 1 Egyenes extra hosszú félkerékcsőrű fogó \bullet 160 mm
- 1 Erősített oldalcsípőfogó \llcorner 160 mm
- 6 Torx®-behajtó betét \odot T6+T15
- 8 Torx®-behajtó betét \odot T20+T55
- 1 behajtó betéttartó adapter
- 1 behajtó betéttartó adapter
- 6 1/4"-os Torx®-dugókulcs \odot E4+E10
- 7 1/2"-os Torx®-dugókulcs \odot E12+E24
- 3 1/2"-os Torx®-imbusz-dugókulcs \odot T55L - T60 - T70L
- 1 vízpumpafogó 250 mm
- 1 Egyenes pofájú önzáró fogó 240 mm

Beta-sz.	TR
920ME	T80
920/21	T80
920/22	T80
920/25	T80
920/42	T80
920/55	T80
920A	T80
42	T05
42	T06
952	T63
VP6	VP6
1032	T145
1034	T145
1036	T145
1038	T145
1290	T170
1297TX	T176
96T	T52
55	T33
96N/SC9	T33
1290	T171
1290N	T171
1292	T172
1292	T173
1292N	T173
35	T234
1370	T234
1390	T234
1150BM	T137
1166BM	T137
1084BM	T137
861TX	T112
866TX	T112
895/1	T112
895/6	T112
900FTX	T112
920FTX	T112
920TX	T112
1048N	T153
1052	T153



T80 T05 T06



T63 VP6



T145 T170 T176 T52



T33 T171 T172 T173



T234 T137 T112 T153

Ft

5904VG/5T

788.900 059041196

Készletlétvási javaslat RSC24 7 - 8 fiókkal - RSC24A 7 - 8 fiókkal - RSC24A-XL - C37 7 - 8 fiókkal - C39 7 - 8 fiókkal
RSC24L - RSC24L/CAB - C59 - RSC23T - RSC28 - C39MD - C39SM - RSC50 - RSC55

5905VG/1

94 darabos szerszámkészlet

► Autójavítás

Mennyiség/megnevezés

Beta-sz.

1	kiütő Ø 4 mm	30
6	6 darabos kiütőkészlet tartós poliészterből készült összetekkerhető tokban Ø 2 - 3 - 4 - 5 - 6 - 8 mm	31/B6N
1	pontozó Ø 4 mm	32
1	laposvágó 150 mm	34
1	keresztvágó 150 mm	36
17	csillag-villáskulcs 6÷22 mm	42
10	imbuszkulcs Ø 1,5÷12 mm	96/B10
1	Állítható villáskulcs skálával, foszfátzott 300 mm	111EN
12	Hosszú dugókulcs-csavarhúzó Ø 4÷14 mm	943BX
1	szerezővas 450 mm	965
1	vízpumpa fogó 250 mm	1048N
1	Egyenes pófájú önzáró fogó 240 mm	1052
1	állítható hegesztő fogó alumínium pófával 280 mm	1060AL
1	erősített oldalcsípőfogó, kétkomponensű markolat ipari kivitel 160 mm	1084GBM
1	Rabitz-fogó műanyaggal bevont nyéllal 250 mm	1098PL
1	átteteles egyenes lemezolló	1122
1	műszerész olló	1128BMX
1	robosztus kombinált fogó kétkomponensű markolat ipari kivitel 180 mm	1150GBM
1	csavarhúzó Dzus® fejű csavarokhoz	1201E/DZ
4	csavarhúzó hasítottfejű csavarokhoz 3x75 - 4x100 - 5,5x150 - 6,5x150 mm	1260
1	Lapos törpe csavarhúzó 4x30 mm	1260N
2	Lapos csavarhúzó, hatlapfejű szárvégzöldéssel 10x175 - 12x200 mm	1260E
3	Phillips®-csavarhúzó PH0x60 - PH1x80 - PH2x100 mm	1262
1	Csavarhúzó Phillips® - csavarokhoz, extra rövid penge PH1x30 mm	1262N
1	Csavarhúzó Phillips® - csavarokhoz, hatszögű penge, PH3x175 mm	1262E
7	Imbusz csavarhúzó Torx®-csavarokhoz T6 - T8 - T10 - T15 - T20 - T25 - T30	1267TX
1	hajlított egyengető idom 1350 g	1303
1	egyengető idom	1305
1	sarok egyengető idom	1306
1	univerzális idom	1310
1	kanálvas	1314
1	kanálvas	1326
1	erősített kanálvas	1327
1	hosszú kettős kanálvas	1330
1	karosszéria reszelő	1338A
1	extra laposvágó	1342PM
1	karosszéria kalapács	1345
1	rovátkás karosszéria kalapács Ø 40 mm	1357Z/45
1	lakatos kalapács 300 g	1370
1	műanyag kalapács Ø 35 mm	1390
1	fékes mérőszalag 5 m	1692



Ft



5905VG/1

788.200 059051058

Készletlátsítási javaslat C25

5905VG/2

118 darabos szerszámkészlet

► Autójavítás

Mennyiség/megnevezés

Beta-sz.



6	2 kiütőből, 1 pontozóból, 2 laposvágóból és 1 keresztvágóból álló készlet összetekkerhető poliészter tokban	38/B6N
13	csillag-villáskulcs 6+14 - 17 - 19 - 22 - 24 mm	42
13	villáskulcs 6x7 - 8x9 - 10x11 - 12x13 - 14x15 - 16x17 - 18x19 - 20x22 - 21x23 - 24x26 - 25x28 - 27x29 - 30x32 mm	55
3	önindítókulcs 11x13 - 14x17 - 19x22 mm	83
10	imbuszkulcs \odot 1,5+12 mm	96N/B10
6	Imbusz csavarhúzókészlet Torx®-csavarokhoz \odot T10 - T15 - T20 - T25 - T30 - T40	97TTX
2	1/2" - os gépi dugókulcs \odot 17 - 19 mm	720
20	1/2"-os hatlapú dugókulcs \odot 10+24 - 26 - 27 - 28 - 30 - 32 mm	920A
1	1/2"-os toldó 125 mm	920/21
1	1/2"-os toldó 255 mm	920/22
1	1/2"-os csukló	920/25
1	1/2"-os csúszkás T-hajtószár	920/42
1	1/2"-os irányváltós racsnit \oplus	920/55
8	csuklós T - kulcs \odot 7 - 8 - 10 - 11 - 13 - 14 - 17 - 19 mm	952
1	hosszú csuklós T - szárú gyertyakulcs	959
1	keresztkulcs \odot 17x19x22x \blacksquare 1/2"	979
1	egyenes belső Seeger-fogó \odot 180 mm	1032
1	hajlítot belső Seeger - fogó \odot 170 mm	1034
1	egyenes külső Seeger-fogó \bullet 175 mm	1036
1	hajlítot külső Seeger - fogó \bullet 175 mm	1038
1	vízpumpafogó 250 mm	1048N
1	Egyenes pófájú önzáró fogó 240 mm	1052
1	erősített oldalcsípőfogó, kétkomponensű markolat ipari kivitel \ddagger 160 mm	1084GBM
1	átteteles egyenes lemezolló 250 mm	1122
1	műszerész olló	1128BMX
1	robosztus kombinált fogó kétkomponensű markolat ipari kivitel \equiv 180 mm	1150GBM
1	egyenes extra hosszú félkerekesőrű fogó, kétkomponensű markolat ipari kivitel \bullet 160 mm	1166GBM
8	csavarhúzó hasítottfejú csavarokhoz \bullet 2,5x50 - 3x75 - 3,5x100 - 4x125 - 5,5x125 - 6,5x150 - 8x200 - 10x200 mm	1260
2	Lapos csavarhúzó, hatlapfejú szárvégzöldéssel \bullet 10x200 - 12x250 mm	1260E
1	Lapos törpe csavarhúzó \bullet 6,5x30 mm	1260N
4	Phillips®-csavarhúzó \oplus PH0x60 - PH1x80 - PH2x100 - PH3x150 mm	1262
1	lakatos kalapács 400 g	1370
1	műanyag kalapács \varnothing 35 mm	1390
1	fémzalagos olajsűrűleszedő	1491
1	mérőműszer 3+48 V	1498

Ft



5905VG/2

706.100 059051044

Készletársítási javaslat C25

5908VG/2T

214 darabos szerszámkészlet ABS hőformált tálcában

► Autójavító

Mennyiség/megnevezés

- 16 csillag-villáskulcs 6÷21 mm
- 5 csillag-villáskulcs 22 - 24 - 27 - 30 - 32 mm
- 5 hosszú kiütő Ø 2 - 3 - 4 - 5 - 6 mm
- 1 pontozó Ø 4 mm
- 12 villáskulcs 6x7 - 8x9 - 10x11 - 12x13 - 14x15 - 16x17
18x19 - 20x22 - 21x23 - 24x26 - 27x29 - 30x32 mm
- 9 imbuszkulcs ○ 1,5 - 2 - 2,5 - 3 - 4 - 5 - 6 - 8 - 10 mm
- 5 1/2"-os imbusz dugókulcs ○ 5 - 6 - 8 - 10 - 12 mm
- 1 1/2"-os toldó 125 mm
- 1 1/2"-os toldó 255 mm
- 1 1/2"-os csukló
- 1 1/2"-os csúszkás T-hajtószár
- 1 1/2"-os irányváltós racsnit ⊕
- 19 1/2"-os hatlapú dugókulcs ○ 10÷24 - 26 - 27 - 30 - 32 mm
- 1 egyenes belső Seeger-fogó ○ 180 mm
- 1 hajlított belső Seeger - fogó ○ 170 mm
- 1 egyenes külső Seeger-fogó ● 175 mm
- 1 hajlított külső Seeger - fogó ● 175 mm
- 1 egyenes belső Seeger-fogó ○ 140 mm
- 1 egyenes belső Seeger-fogó ○ 225 mm
- 1 egyenes külső Seeger-fogó ● 140 mm
- 1 egyenes külső Seeger-fogó ● 225 mm
- 9 csavarhúzó hasítottfejű csavarokhoz ● 3x75 - 3x100 - 4x100 - 4x150 - 5,5x100 - 5,5x150 -
6,5x150 - 8x150 - 10x200 mm
- 2 Lapos törpe csavarhúzó ● 4x30 - 6,5x30 mm
- 7 Phillips®-csavarhúzó ⊕ PH0x60 - PH0x100 - PH1x80 - PH1x120 - PH2x100 - PH2x150
-PH3x150 mm
- 2 Csavarhúzó Phillips® - csavarokhoz, extra rövid penge ⊕ PH1x30 - PH2x30 mm
- 8 csuklós T - kulcs ○ 7 - 8 - 10 - 12 - 13 - 14 - 17 - 19 mm
- 2 Csavarhúzó Phillips® - csavarokhoz, hosszú penge ⊕ PH1x400 - PH2x400 mm
- 3 Csavarhúzó hernyócsavarokhoz, hosszú penge ● 3x300 - 4x400 - 5x400 mm
- 6 Imbusz csavarhúzókészlet Torx®-csavarokhoz ⊕ T10-T15-T20-T25-T27-T30
- 12 1/2" - os gépi dugókulcs ○ 10-13-17-18-19-21-22-24-27-30-32 mm
- 1 1/2"-os toldó 125 mm
- 3 ○ 17-19-21
- 5 1/2"-os színes hatszögű csavarhúzóbetét ○ 5L - 6L - 7L - 8L - 10L
- 4 1/2"-os Torx®-imbusz-dugókulcs ⊕ T40L - T45L - T55L - T70L
- 3 1/2"-os XZN®-profilú imbusz-dugókulcs, krómzott, barnított fej ○ M6L - M8L - M12L
- 5 reszelő 200 mm
- 1 fémszalagos olajsűrűsítő 110 mm
- 1 Olajleeresztő dugókulcs-betét, négyszög ■ 10 mm
- 7 Olajleeresztő dugókulcs-betét, külső hatszög ○ 8-9-10-11-12-14-17 mm
- 4 Olajleeresztő dugókulcs-betét, külső négyszög ○ 8-9,5-12-13 mm
- 1 Olajleeresztő dugókulcs-betét, külső háromszög Δ
- 1 Olajleeresztő dugókulcs-betét XZN®-csavarokhoz ○
- 1 Olajleeresztő kulcs
- 2 erősített laposvágó 100 - 200 mm
- 1 lakatos kalapács 300 g
- 1 műanyag kalapács Ø 35 mm
- 1 vízpumpafogó 250 mm
- 1 Egyenes pofájú önzáró fogó 240 mm
- 1 kombinált fogó ■ 180 mm
- 1 Egyenes extra hosszú félkerekcsőrű fogó ● 160 mm
- 1 Erősített oldalcsípőfogó † 160 mm
- 11 3/4" - os hatlapú dugókulcs ○ 22-24-27-30-32-34-36-38-41-46-50 mm
- 1 3/4" - os toldó 200 mm
- 1 3/4" - os toldó 380 mm
- 1 3/4" - os csúszkás T - hajtószár 450 mm
- 1 3/4" - os irányváltós racsnit ⊕
- 1 hőformált szerszámtartó
- 4 imbuszkulcs ○ 13-14-17-19 mm
- 1 Állítható villáskulcs 300 mm
- 1 szerelővas
- 1 bádogos lemezolló 250 mm
- 1 műszerész olló
- 1 lakatos kalapács 1000 g
- 1 Hézagmérő
- 1
- 1 teleszkópos vizsgáló tűkőr
- 1 háromélű hántoló 200 mm
- 1 fűrész 440 mm
- 1 Acél drótkéfe
- 1 Olajozó fémkanna 200 cl
- 1 dekorkés

Beta-sz.	TR
42	T05
42	T06
31	T31
32	T31
55	T31
96N/SC9	T31
920ME	T80
920/21	T80
920/22	T80
920/25	T80
920/42	T80
920/55	T80
920A	T80
1032	T145
1034	T145
1036	T145
1038	T145
1032	T146
1032	T146
1036	T146
1036	T146
1260	T167
1260N	T167
1262	T168
1262N	T168
952	T63
1264L	T209
1262L	T209
97TTX	T55
720	T111
720/21	T111
720LC	T111
920PE	T113
920TX	T113
920XZN	T113
1719BMA8/S5	T236
1491	T264
1494	T264
1494E	T264
1494Q	T264
1494T	T264
1494XZN	T264
1496C	T264
35	T234
1370	T234
1390	T234
1048N	T153
1052	T153
1150	T138
1166	T138
1084	T138
928A	T105
928/21	T106
928/22	T106
928/42	T106
928/55	T106
VP6	VP6
96N	VP6
111E	VP6
965	VP6
1112	VP6
1128BMX	VP6
1370	VP6
1708/20	VP6
1712	VP6
1715	VP6
1717B	VP6
1726	VP6
1737NX	VP6
1751N	VP6
1771	VP6

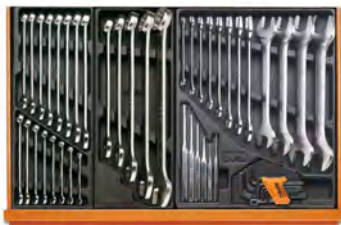

T05 T06 T31



T80 T145 T146



T167 T168
+96N +1771



T63 T209



T55 T111 T113 T236



T264 T234 T153 T138



T105 T106 VP6



Ft

5908VG/2T

1.331.900 059081017

Készletlétszámi javaslat RSC28

5910VG/3T

202 darabos szerszámkészlet ABS hőformált tálcában

► Autójavító

Mennyiség/megnevezés

- 16 csillag-villáskulcs 6+21 mm
- 5 csillag-villáskulcs 22 - 24 - 27 - 30 - 32 mm
- 6 Kettős csuklós dugókulcs 8x9 - 10x11 - 12x13 - 14x15 - 16x17 - 18x19 mm
- 1 fémszalagos olajsűrűszedő 110 mm
- 1 Olajleeresztő dugókulcs-betét, négyszög ■ 10 mm
- 7 Olajleeresztő dugókulcs-betét, külső hatszög ○ 8-9-10-11-12-14-17 mm
- 4 Olajleeresztő dugókulcs-betét, külső négyszög ○ 8-9,5-12-13 mm
- 1 Olajleeresztő dugókulcs-betét, külső háromszög Δ
- 1 Olajleeresztő dugókulcs-betét XZN®-csavarokhoz ○
- 1 Olajleeresztő kulcs
- 5 1/2"-os imbusz dugókulcs ○ 5 - 6 - 8 - 10 - 12 mm
- 1 1/2"-os toldó 125 mm
- 1 1/2"-os toldó 255 mm
- 1 1/2"-os csukló
- 1 1/2"-os csúszkás T-hajtószár
- 1 1/2"-os irányváltós racsnival ⊗
- 19 1/2"-os hatlapú dugókulcs ○ 10+24 - 26 - 27 - 30 - 32 mm
- 1 egyenes belső Seeger-fogó ○ 180 mm
- 1 hajlított belső Seeger - fogó ○ 170 mm
- 1 egyenes külső Seeger-fogó ● 175 mm
- 1 hajlított külső Seeger - fogó ● 175 mm
- 1 egyenes belső Seeger-fogó ○ 140 mm
- 1 hajlított belső Seeger - fogó ○ 225 mm
- 1 egyenes külső Seeger-fogó ● 140 mm
- 1 hajlított külső Seeger - fogó ● 225 mm
- 6 Imbusz csavarhúzókészlet Torx®-csavarokhoz ⊕ T10-T15-T20-T25-T27-T30
- 12 Csuklós racsnis csillag-villáskulcs 8 - 9 - 10 - 11 - 12 - 13 - 14 - 15 - 16 - 17 - 18 - 19 mm
- 1 kombinált fogó ≡ 180 mm
- 1 Egyenes extra hosszú félkerekcsőrű fogó ● 160 mm
- 1 Erősített oldalcsípőfogó ⚡ 160 mm
- 1 Vízpumpafogó fogasléces stífttel állítható 240 mm
- 1 Egyenes profájú önzáró fogó 240 mm
- 8 csuklós T - kulcs ○ 7 - 8 - 10 - 12 - 13 - 14 - 17 - 19 mm
- 9 csavarhúzó hasítottfejű csavarokhoz ● 3x75 - 3,5x100 - 4x100 - 4x150 - 5,5x100 - 5,5x150 - 6,5x150 - 8x150 - 10x200 mm
- 2 Lapos törpe csavarhúzó ● 4x30 - 6,5x30 mm
- 6 darabos kiütőkészlet tartós poliészterből készült összetekkerhető tokban
- 7 Phillips®-csavarhúzó ⊕ PH0x60 - PH0x100 - PH1x80 - PH1x120 - PH2x100 - PH2x150 - PH3x150 mm
- 2 Csavarhúzó Phillips® - csavarokhoz, extra rövid penge ⊕ PH1x30 - PH2x30 mm
- 1 Állítható villáskulcs 250 mm
- 1 1/2"-os csuklós T-hajtószár
- 6 T-szárú imbuszkulcs ○ 2,5-3-4-5-6-8 mm
- 4 csuklós T - imbuszkulcs ○ 4-5-6-8 mm
- 2 lakatos kalapács 300-500 g
- 2 Csavarhúzó Phillips® - csavarokhoz, hosszú penge ⊕ PH1x400 - PH2x400 mm
- 3 Csavarhúzó hernyócsavarokhoz, hosszú penge ● 3x300 - 4x400 - 5x400 mm
- 9 Hajlított gömbfejű imbuszkulcs ○
- 1 kioldó nyomatékkulcs irányváltós racsnival ⊗ 8 ÷ 60 Nm
- 1 kioldó nyomatékkulcs irányváltós racsnival ⊗ 60 ÷ 330 Nm
- 12 Gépi dugókulcs
- 1 Szűkítő közbetét, belső 1/2", külső 3/8"
- 1 12 dugókulcs és 5 tartozék 3/4"
- 3 Széles és hajlított állítható fejjel
- 1 ütéselnyelő műanyag kalapács Ø 50 mm
- 1 Irányváltós ütvecsavarbehajtó, jobbos-balos, plattírozott anyagból □

Beta-sz.	TR
42	T05
42	T06
80	T79
1491	T264
1494	T264
1494E	T264
1494Q	T264
1494T	T264
1494XZN	T264
1496C	T264
920ME	T80
920/21	T80
920/22	T80
920/25	T80
920/42	T80
920/55	T80
920A	T80
1032	T145
1034	T145
1036	T145
1038	T145
1032	T146
1034	T146
1036	T146
1038	T146
97TTX	T55
142SN	T46
1150BM	T137
1166BM	T137
1084BM	T137
1047	T151
1057A	T151
952	T63
1260	T167
1260N	T167
31/B6N	T168
1262	T168
1262N	T168
111E	T59
920/40	T59
951	T59
953	T59
1370	T59
1262L	T209
1264L	T209
96BPC/SC9	T209
666N/5	T209
666N/30	T209
720C/12	T209
910/16	T209
928A/C12	T209
966C/3	T209
1392	T209
1927P	T209

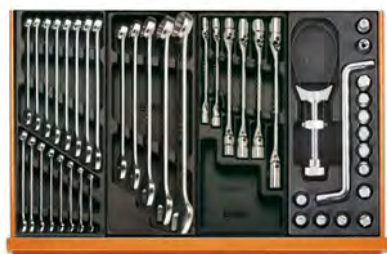

T05 T06 T79 T264

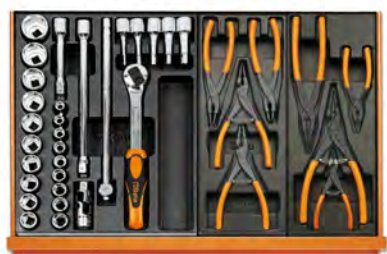

T80 T145 T146



T55 T46 T137 T151

T63



T167 T168 + 96BPC/SC9 + 31/B6N

T59



T209



Ft

5910VG/3T

1.915.100 059101068

A C30M munkapadhoz ajánlott készlet

5935VG/1MB

98 darabos szerszámkészlet a C35 szerszámszekrényhez habszivacs tálcában

► Autójavító

Mennyiség/megnevezés

- 21 csillag-villáskulcs 6-7-8-9-10-11-12-13-14-15-16-17-18-19-20-21-22-24-27-30-32 mm
- 8 villáskulcs 6x7-8x9-10x11-12x13-14x15
- 16x17-18x19-20x22 mm
- 1 vízpumpafofó 250 mm
- 4 csavarhúzó hasítottfejú csavarokhoz ● 3x75-4x100-5x125-6,5x150 mm
- 3 Phillips®-csavarhúzó ● PH0x60-PH1x80--PH2x100 mm
- 6 Imbusz csavarhúzó Torx®-csavarokhoz ● T8-T10-T15-T20-T25-T30
- 9 Hajlítót gömbfejú imbuszkulcs ○
- 6 T - szárú imbuszkulcs műanyag markolattal ○ 2-2,5-3-4-5-6
- 1 Egyenes pófájú önzáró fogó 240 mm
- 19 1/2"-os hatlapú dugókulcs ○ 10-11-12-13-14-15-16-17-18-19-20-21-22-23-24-26-27-30-32 mm
- 1 1/2"-os toldó 125 mm
- 1 1/2"-os toldó 250 mm
- 1 1/2"-os csukló
- 1 1/2"-os csúszkás T-hajtószár
- 1 1/2"-os irányváltós racsnival
- 5 1/2"-os színes hatszögű csavarhúzóbetét ○ 5-6-8-10-12 mm
- 1 egyenes belső Seeger-fogó ○ 180 mm
- 1 hajlított belső Seeger - fogó ○ 170 mm
- 1 egyenes külső Seeger-fogó ● 175 mm
- 1 hajlított külső Seeger - fogó ● 175 mm
- 1 erősített laposvágó 200 mm
- 1 Erősített oldalcsípőfogó ♣ 160 mm
- 1 kombinált fogó = 180 mm
- 1 Egyenes extra hosszú félkerekcsőrű fogó ● 160 mm
- 1 lakatos kalapács 500 g
- 1 műanyag kalapács 35 mm

Beta-sz.	TR
42	MB12
55	MB12
1048N	MB12
1260	MB46
1262	MB46
1267TX	MB46
96BPC/SC9	MB46
96T	MB46
1052	MB46
920A	MB39
920/21	MB39
920/22	MB39
920/25	MB39
920/42	MB39
920/55	MB39
920PE	MB39
1032	MB39
1034	MB39
1036	MB39
1038	MB39
35	MB39
1084BM	MB39
1150BM	MB39
1166BM	MB39
1370	MB39
1390	MB39



MB12



MB39



MB46

Ft

5935VG/1MB 584.200 059351321

Készletértékelési javaslat C35

5940SBK

125 darabos szerszámkészlet

► Motorjavítás

Mennyiség/megnevezés

- 1 kiütő Ø 2 mm
- 1 pontozó Ø 4 mm
- 1 laposvágó 125 mm
- 10 csillag-villáskulcs 6 - 7 - 8 - 10 - 11 - 12 - 13 - 14 - 17 - 19 mm
- 6 villáskulcs 6x7 - 8x9 - 10x11 - 12x13 - 14x15 - 16x17 mm
- 9 imbuszkulcs ○ 1,5 - 2 - 2,5 - 3 - 4 - 5 - 6 - 8 - 10 mm
- 1 kioldó nyomatékkulcs irányváltós racsnival ● 3/8", 8+60 Nm
- 54 52 hatszögű csavarhúzóbetét, 10 mm és 2 tartozék
- 17 12 dugókulcs és 5 tartozék
- 1 Szűkítő közbetét, belső 1/2", külső 3/8"
- 2 Gyertya-dugókulcs ○ 14 - 16 mm
- 1 Extra hosszú félkerekcsőrű műszerészfogó ● 283 mm
- 2 egyenes belső Seeger-fogó ○ 140 - 180 mm
- 1 egyenes külső Seeger-fogó ● 140x1,3 mm
- 1 oldalcsípőfogó, csúszásmentes kétrétegű PVC bevonatú markolat ipari kivitel ♣ 160 mm
- 1 Egyenes élű műszerész olló
- 1 robusztus kombinált fogó csúszásmentes kétrétegű PVC bevonatú markolat ipari kivitel = 180 mm
- 1 csavarhúzó Dzus® fejú csavarokhoz ●
- 4 csavarhúzó hasítottfejú csavarokhoz ● 3x75 - 4x100 - 5,5x100 - 6,5x150 mm
- 3 csavarhúzó keresztfejú Phillips® csavarokhoz ● PH0x60 - PH1x80 - PH2x100 mm
- 1 Fáziskereső ●
- 1 lakatos kalapács 300 g
- 1 fémszalagos olajsűrűleszedő
- 1 Hézagmérő
- 1 Mini fűrész
- 1 sárgaréz drótkefe
- 1 pumpás műanyag olajozó kanna 250 cc

Beta-sz.	TR
30	
32	
34	
42	
55	
96/SC9	
666N/5	
867/C52	
920A/C12X	
910/16	
956C	
1009L/A	
1032	
1036	
1082G	
1128BM	
1150G	
1201E/DZ	
1201E	
1202E	
1254	
1370	
1491	
1708/13	
1725CR	
1737	
1754	

Ft

5940SBK 448.200 059401082

A C41S - C41H - C42S - C42H - C42S - C41S szerszámkocsikhoz ajánlott készlet

5941VU/M

64 szerszámból álló autójavító készlet a C41H húzható szerszámkocsihoz habszivacs tálcában

► Univerzális alkalmazás

Mennyiség/megnevezés

- 16 csillag-villáskulcs 6-7-8-9-10-11-12-13-14-15-16-17-18-19-21-22 mm
- 9 imbuszkulcs ○
- 1 fékes mérőszalag 5 m
- 19 1/2"-os hatlapú dugókulcs ○ 10-11-12-13-14-15-16-17-18-19-20-21-22-23-24-26-27-30-32 mm
- 1 1/2"-os csukló
- 1 1/2"-os csúszkás T-hajtószár
- 1 1/2"-os irányváltós racsnit ⊗
- 2 1/2" Gömbvégű toldó 125-250 mm
- 1 Állítható villáskulcs 250 mm
- 1 vízpumpafogó 250 mm
- 1 Oldalsípőfogó, kétkomponensű markolat ipari kivitel ≡ 160 mm
- 1 műszerész olló 145 mm
- 1 robusztus kombinált fogó kétkomponensű markolat ipari kivitel ≡ 180 mm
- 1 egyenes extra hosszú félkerekcsőrű fogó, kétkomponensű markolat ipari kivitel ● 160 mm
- 3 csavarhúzó hasítottfejú csavarokhoz ● 3,5x100-5,5x125-6,5x150 mm
- 3 Phillips®-csavarhúzó ⊕ PH0-PH1-PH2
- 1 lakatos kalapács 300 g
- 1 dekorkés 18 mm

Beta-sz.	TR
42	MC12
96/SC9	MC12
1692/5	MC12
920A	MC21
920/25	MC21
920/42	MC21
920/55	MC21
920AN	MC21
111E	
1048N	
1082GBM	
1128BMX	
1150GBM	
1166GBM	
1260	
1262	
1370	
1771	



MC21



MC12



Ft



5941VU/M

289.300 059411002

A C41 szerszámkocsihoz ajánlott készlet

Beta

5945VUM

231 darabos szerszámkészlet EVA habszivacs tálcában

► Univerzális alkalmazás

Mennyiség/megnevezés

- 21 csillag-villáskulcs 6-7-8-9-10-11-12-13-14-15-16-17-18-19-20-21-22-24-27-30-32 mm
 9 Hajlított gömbfejű imbuszkulcs \odot 1,5-2-2,5-3-4-5-6-8-10 mm
 8 T - szárú imbuszkulcs műanyag markolattal \odot 2-2,5-3-4-5-6-7-8 mm
 1 lakatos kalapács 300 g
 1 műanyag kalapács \emptyset 35
 2 erősített laposvágó 100-200 mm
 5 reszelő 200 mm
 1 behajtó betéttartó adapter \odot 1/4 - \square 1/4
 1 behajtó betéttartó adapter \odot 1/4 - \square 3/8
 1 behajtó betéttartó adapter \odot 5/16 - \square 1/2
 13 1/4"-os hatlapú dugókulcs \odot 4-4,5-5-5,5-6-7-8-9-10-11-12-13-14 mm
 9 \odot 5-6-7-8-9-10-11-12-13 mm
 5 1/4"-os imbusz-dugókulcs \odot 3-4-5-6-7 mm
 4 csavarhúzó-dugókulcs hasítottfejű csavarokhoz, krómozott, barnított hegy \bullet 0,8x4-1x5,5x1,2x6,5-1,2x8 mm
 4 csavarhúzó-dugókulcs Phillips®-csavarokhoz, krómozott, barnított hegy \oplus PH1-PH2-PH3-PH4
 7 1/4"-os Torx®-imbusz dugókulcs, krómozott, fekete hegyek \odot T10-T15-T20-T25-T27-T30-T40
 1 Bővítő közbetét 1/4" - 3/8" \square 1/4 - \blacksquare 3/8
 1 1/4" - os toldó 50 mm
 1 1/4" - os toldó 100 mm
 1 1/4" - os toldó 150 mm
 1 1/4"-os csukló
 1 1/4"-os hajtószár 176 mm
 1 1/4"-os csúszkás T-hajtószár 115 mm
 1 1/2"-os irányváltós racsní \oplus 125 mm
 17 Hatlapú dugókulcs 3/8" \odot 6-7-8-9-10-11-12-13-14-15-16-17-18-19-20-21-22 mm
 1 Szűkítő közbetét 3/8" és 1/4" \square 3/8 - \blacksquare 1/4
 1 Szűkítő közbetét, belső 1/2", külső 3/8" \square 3/8 - \blacksquare 1/2
 1 Toldó - 3/8" 125 mm
 1 Toldó - 3/8" 250
 1 Csukló 3/8"
 1 Csúszkás T - hajtószár 3/8" 210 mm
 1 3/8" irányváltós racsní \oplus 200 mm
 21 1/2"-os hatlapú dugókulcs \odot 8-10-11-12-13-14-15-16-17-18-19-20-21-22-23-24-26-27-28-30-32 mm
 1 szűkítő közbetét 1/2" és 3/8" \square 1/2 - \blacksquare 3/8
 1 1/2"-os csukló
 1 1/2" Gömbvégű toldó 125 mm
 1 1/2" Gömbvégű toldó 250 mm
 1 1/2"-os csúszkás T-hajtószár 305 mm
 1 1/2"-os irányváltós racsní \oplus 275 mm
 3 3/8" - os gyertya - dugókulcs \odot 16 mm (5/8")-17,8 (11/16")-20,8 (13/16")
 5 Imbusz csavarhúzókészlet Torx®-csavarokhoz \odot T10-T15-T20-T25-T30
 1 Erősített oldalcsipőfogó \ddagger 160 mm
 1 kombinált fogó \equiv 180 mm
 1 Egyenes extra hosszú félkerékcsőrű fogó \bullet 160 mm
 1 egyenes belső Seeger-fogó \odot 19+60 mm
 1 hajlított belső Seeger - fogó \odot 19+60 mm
 1 egyenes külső Seeger-fogó \bullet 19+60 mm
 1 hajlított külső Seeger - fogó \bullet 19+60 mm
 1 vízpumpafogó 250 mm
 1 Egyenes pófajú önzáró fogó 240 mm
 38 Bimateriál-műszerész csavarhúzó 36 cserélhető 4 mm-es bit-tel és mágneses hosszabbítóval
 6 csavarhúzó hasítottfejű csavarokhoz \bullet 04x2,5x50-0,5x3x75-0,8x4x100-1,0x5,5x125-1,2x6,5x150-1,2x8x200 mm
 1 csavarhúzó hasítottfejű csavarokhoz, extra rövid \bullet 0,8x4x30 mm
 4 csavarhúzó keresztfejű Phillips® csavarokhoz \oplus PH0x60-PH1x80PH2x100PH3x150 mm
 1 csavarhúzó keresztfejű Phillips® csavarokhoz, extra rövid \oplus PH1x30 mm
 12 imbusz-csavarhúzó Torx®-csavarokhoz \odot T06-T07-T08-T09-T10-T15-T20-T25-T27-T30-T40-T45
 1 Fáziskereső \bullet 0,5x3,5x100 mm

Beta-sz.	TR
	42
96BPC/SC9	MM11
	96T
	1370
	1390
	35
1719BMA8/S5	MM61
	895/1
	895/3
	895/6
	900
	900L
	900ME
	900LP
	900PH
	900TX
	900/16
	900/20
	900/20L
	900/21
	900/25
900BG/30	MM105
	900/42
	900/55
	910A
	910/15
	910/16
	910/21
	910/22
	910/25
	910/42
	910/55
	920A
	920/15
	920/25
	920AN
	920AN
	920/42
	920/55
	956E
	97TTX
	1084BM
	1150BM
	1166BM
	1032
	1034
	1036
	1038
	1048N
	1052
1256/C36-2	MM140
	1201E
	1201EN
	1202E
	1202EN
	1207E/TX
	1253



MM11



MM61



MM105



MM140

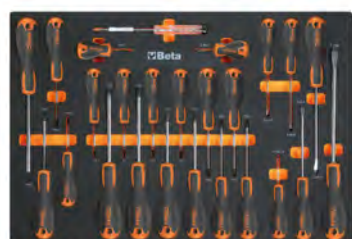

MM210

Ft

5945VU/M

919.000 059451001

A készletet a C45 termékkel együtt ajánljuk

5954VG

138 darabos szerszámkészlet

► Autójavítás

Mennyiség/megnevezés

Mennyiség/megnevezés	Beta-sz.
5 hosszú kiütő Ø 2-3-4-5-6 mm	31
1 pontozó Ø 4 mm	32
1 laposvágó 125 mm	34
18 csillag-villáskulcs 6+22 - 24 mm	42
8 villáskulcs 6x7 - 8x9 - 10x11 - 12x13 - 14x15 - 16x17 - 18x19 - 20x22 mm	55
3 hajlított csillagkulcs 12x13 - 14x15 - 17x19 mm	90
13 imbuszkulcs Ø 2+10 - 12 mm	96
4 1/2" - os gépi dugókulcs Ø 17 - 19 - 21 - 22 mm	720
20 1/2"-os hatlapú dugókulcs Ø 10-11-12-13-14-15-16-17-18-19-20-21-22-23-24-26-27-28-30-32 mm	920A
1 1/2"-os toldó	920/21
1 1/2"-os toldó	920/22
1 1/2"-os csukló	920/25
1 1/2"-os csúszkás T-hajtószár	920/42
1 1/2"-os irányváltós racsnit	920/55
3 Hosszú dugókulcs-csavarhúzó Ø 8 - 10 - 13 mm	943BX
10 csuklós T - kulcs Ø 6 - 7 - 8 - 10 - 11 - 12 - 13 - 14 - 17 - 19 mm	952
3 Gyertya-dugókulcs Ø 16 - 17,8 - 20,8 mm	956C
1 szerelővas	964
1 egyenes belső Seeger-fogó	1032
1 hajlított belső Seeger - fogó	1034
1 egyenes külső Seeger-fogó	1036
1 hajlított külső Seeger - fogó	1038
1 vízpumpa-fogó 250 mm	1048N
1 Egyenes pofájú önzáró fogó 240 mm	1052
1 állítható hosszúcsőrű önzárófogó 175 mm	1058
1 Oldalsípőfogó 160 mm	1082BM
1 műszerész olló	1128BMX
1 kombinált fogó 180 mm	1150BM
1 Egyenes extra hosszú félkerékcőrű fogó 160 mm	1166BM
1 Fáziskereső 6+24V	1254
1 csavarhúzó hasítottfejú csavarokhoz 8 x 200 mm	1260
1 Lapos törpe csavarhúzó 6,5x30 mm	1260N
1 Phillips®-csavarhúzó 8 x 150 mm	1262
1 Csavarhúzó Phillips® - csavarokhoz, extra rövid penge PH2x30 mm	1262N
5 Imbusz csavarhúzó Torx®-csavarokhoz T8 - T10 - T15 - T20 - T25	1267TX
8 csavarhúzókészlet	1263/D8
1 lakatos kalapács 300 g	1370
1 ütéselnyelő műanyag kalapács Ø 35 mm	1392
1 fékrugófogó 210 mm	1470
1 saruzófogó	1603
1 fékes mérőszalag 5 m	1692
1 Hézagmérő	1708/20
1 flexibilis mágneses csavarkiszedő 1,8 kg	1712E/2
6 Túreszelők 160 mm	1720/B6
1 pumpás műanyag olajozó kanna 150 cc	1754



Ft



5954VG

828.700 059541054

Készletársítási javaslat C54VG

5957VG

174 darabos szerszámkészlet

► Autójavítás

Mennyiség/megnevezés

Beta-sz.

6	hosszú kiütő Ø 2 - 3 - 4 - 5 - 6 - 8 mm	31/SP6
6	2 kiütő, 1 pontozó, 3 hidegvágó	38/SP6
17	csillag-villáskulcs 6-7-8-10-11-12-13-14-15-16-17 19-21-22-24-27-30 mm	42
12	villáskulcs 6x7 + 30x32 mm	55/S12X
8	T - szárú imbuszkulcs műanyag markolattal 2 + 10 mm	96T/S8
1	imbuszkulcs Ø 2,5 + 12 mm	96N/G7
8	8 részes hajlítot Torx® imbuszkulcs szerszám készlet T9 + T40	97TX/SC8
5	XZN®-profilú imbuszkulcs, nikkelezett Ø M5 + M12	98XZN/B5
1	Állítható villáskulcs 250 mm	111E
1	kioldó nyomatékkulcs irányváltós racsnival ⊕ 1/2", 40+200 Nm	666N/20
13	1/2" - os hatlapú dugókulcs Ø 10+22 mm	920A/SB13
8	1/2" - os hatlapú dugókulcs Ø 23+32 mm	920A/SB8
4	1/2" - os csavarhúzó dugókulcs ● 1,2x6,5 - 1,2x8 - 1,6x9 - 2x12 mm	920LP
3	1/2" - os Phillips® csavarhúzó dugókulcs ⊕ PH2 - 3 - 4	920PH
1	1/2"-os toldó 125 mm	920/21
1	1/2"-os toldó 255 mm	920/22
1	1/2"-os csukló	920/25
1	1/2"-os csúszkás T-hajtószár	920/42
1	1/2"-os irányváltós racsnit ⊕	920/55
2	1/2" - os gépi dugókulcs Ø 17 - 19 mm	720
10	csuklós T - kulcs Ø 7 - 8 - 10 - 11 - 12 - 13 - 14 - 15 - 17 - 19 mm	952
3	hosszú csuklós T - szárú gyertyakulcs 14 - 16 - 20,8 mm	959
1	egyenes feszítővas	963
1	keresztkulcs ○ ■ 1/2" - 17 - 19 - 22 mm	979
2	egyenes belső Seeger-fogó ○ 140 - 180 mm	1032
2	hajlítot belső Seeger - fogó ○ 130 - 170 mm	1034
2	egyenes külső Seeger-fogó ● 140x1,3 - 175 mm	1036
2	hajlítot külső Seeger - fogó ● 135x1,3 - 175 mm	1038
1	vízpumpafofó 250 mm	1048N
1	Egyenes pofájú önzáró fogó 240 mm	1052
1	Oldalcspőfófogó † 160 mm	1082BM
1	Erősített oldalcspőfófogó † 160 mm	1084BM
1	áttételes homlokspőfófogó † 180 mm	1092V
1	bádogos lemezolló 250 mm	1112
1	műszerész olló	1128BMX
1	kombinált fogó = 180 mm	1150BM
1	Egyenes extra hosszú félkerekcsőrű fogó ● 160 mm	1166BM
1	Hajlítot extra hosszú félkerekcsőrű fogó ● 200 mm	1168BM
2	csavarhúzó hasítottfejű csavarokhoz ● 8x200 - 10x200 mm	1260
1	Phillips®-csavarhúzó ⊕ PH3x150 mm	1262
8	csavarhúzókészlet	1263/D8
2	lakatos kalapács 300 - 600 g	1370
1	műanyag kalapács Ø 35 mm	1390
11	M5+M16 mm	1433/C11
1	fémszalagos olajsűrűsítő	1491
1	mérőműszer	1498
1	fékes mérőszalag 5 m	1692
1	Hézagmérő	1708/20
1	flexibilis mágneses csavarkiszedő 1,8 kg	1712E/2
1	kétélű hántoló 200 mm	1717A
1	háromélű hántoló 200 mm	1717B
5	reszelő 200 mm	1719BMA8/S5
1	fűrész	1725
1	pumpás fém olajozó kanna 200 cc	1751
1	dekorkés	1771
1	tolómérő	1650

Ft



5957VG

1.436.600 059571007

A C57SA - C57SB - C57SP - RSC50 PS - C55PS - C55PSE munkapadokhoz ajánlott készlet

HABSZIVACS TÁLCÁK M-SZÉRIA



RSC23T
RSC24
RSC24A
RSC24AXL
RSC24L/7
RSC24L-CAB
RSC28
C30M
C37
C37A
C39
C39T
C39MD
C39SM
RSC51
C57S
C59
RSC55

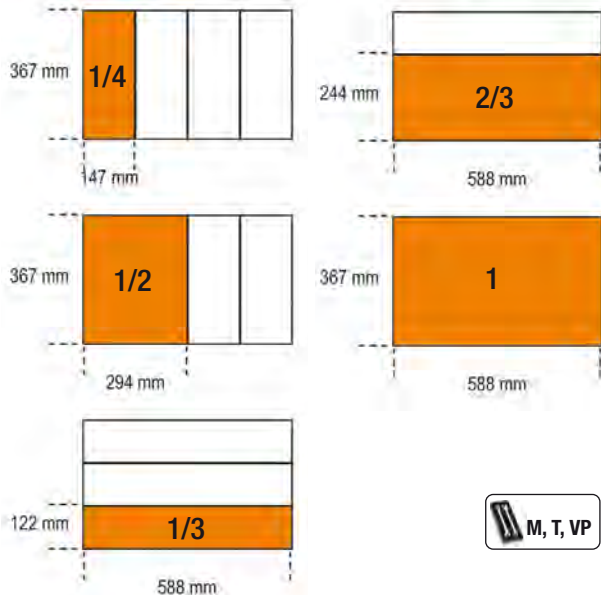

493÷503
508÷518



M01



42 6-7-8-9-10-11-12-13-14-15-16-17-18-19-20-21-22-24-27-30-32-36 mm

4,5 kg

	Ft	1	024500001
M01	141.700	1	024500001
MV10	25.100	1	024510010

M02



42 6-7-8-9-10-11-12-13-14-15-16-17-18-19-20-21-22-23-24-25-26-27-28-29-30-32 mm

6,3 kg

	Ft	1	024500002
M02	158.900	1	024500002
MV02	25.100	1	024510002

M05



42 6-7-8-9-10-11-12-13-14-15-16-17-18-19-20-21 mm

1,5 kg

	Ft	1	024500005
M05	67.800	1	024500005
MV15	13.000	1	024510015

M06



42 22-24-27-30-32 mm

2,1 kg

	Ft	1	024500006
M06	47.300	1	024500006
MV16	17.450	1	024510016

M13



42SLIM 8-10-11-12-13-14-15-16-17-18-19 mm

1,2 kg

	Ft	1	024500013
M13	51.200	1	024500013
MV13	13.000	1	024510013

M25



42 6-7-8-9-10-11-12-13-14-15-16-17-18-19-21-22-24-27 mm
90 6x7-8x9-10x11-12x13-14x15-16x17-18x19 mm
123Q1/4
123Q3/8
123Q1/2
142 8-9-10-11-12-13-14-15-16-17-18-19 mm

5,1 kg

	Ft	1	024500025
M25	250.300	1	024500025
MV25	25.100	1	024510873

M30



55 6x7-8x9-10x11-12x13-14x15-16x17-18x19-20x22-21x23-24x27-30x32 mm
90 6x7-8x9-10x11-12x13-14x15-16x17-18x19-20x22-21x23-24x27-30x32 mm
96BPC/SC9 1,5-2-2,5-3-4-5-6-8-10 mm

4,2 kg

	Ft	1	024500030
M30	141.700	1	024500030
MV30	25.100	1	024510030

Beta

M31



42AS 1/4-9/32-5/16-3/8-7/16-1/2-9/16-19/32-5/8-11/16-3/4-13/16-7/8-15/16-1-1.1/16-1.1/8-1.1/4
96BP/AS-SC9 1/16-3/32-1/8-5/32-3/16-7/32-1/4-5/16-3/8

4,5 kg



	Ft		
M31	143.600	1	024500031
MV31	25.100	1	024510031

M33



55 6x7-8x9-10x11
12x13-14x15
16x17-18x19
20x22 mm
96/SC9 1,5+10 mm

1,1 kg



	Ft		
M33	32.600	1	024500033
MV33	13.000	1	024510033

M38



55 21x23-24x26
27x29-30x32 mm

1,7 kg



	Ft		
M38	26.500	1	024500038
MV38	17.450	1	024510038

M39



31 2-3-4-5-6-8 mm
32 4 mm
55 6x7-8x9-10x11-12x13-14x15-16x17-18x19-20x22-21x23-24x26-25x28-27x29-30x32 mm
96/SC12 2-2,5-3-3,5-4-4,5-5-6-7-8-9-10 mm
96 12-14-17-19 mm

5,7 kg



	Ft		
M39	121.400	1	024500039
MV39	25.100	1	024510039

M40



90 6x7-8x9-10x11
12x13-14x15
16x17-18x19 mm

810 g



	Ft		
M40	33.150	1	024500040
MV40	13.000	1	024510040

M44



141 8-9-10-11-12
13-14-15-16
17-18-19 mm

1,3 kg



	Ft		
M44	107.100	1	024500044
MV44	13.000	1	024510044

M45



142 8-9-10-11-12
13-14-15-16
17-18-19 mm

1,3 kg



	Ft		
M45	122.200	1	024500045
MV45	13.000	1	024510045

M46



142SN 8-9-10-11-12
13-14-15-16
17-18-19 mm

1,4 kg



	Ft		
M46	143.900	1	024500046
MV46	13.000	1	024510046

M49

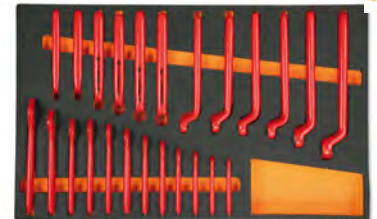

52MQ 7-8-10-11-12-13-14-15-16-17-19-22 mm
89MQ 7-8-10-11-12-13-14-15-16-17-19-22 mm

3,3 kg



	Ft		
M49	440.800	1	024500049
MV49	25.100	1	024510049

M50



96T 2-2,5-3-4-5
6-7-8 mm

1,1 kg



	Ft		
M50	48.050	1	024500050
MV50	17.450	1	024510051

M52



○ 96T 2,5-3-4-5-6 mm



330 g



	Ft		
M52	27.900	1	024500052
MV52	13.000	1	024510052

M53



○ 96TBP 2,5-3-4-5-6 mm



350 g



	Ft		
M53	29.650	1	024500053
MV52	13.000	1	024510052

M55



○ 97TTX T10-T15-T20-T25-T30



330 g



	Ft		
M55	30.750	1	024500055
MV55	13.000	1	024510055

Beta

Quality Tools

M60



○ 96T 2-2,5-3-4-5-6-7-8-10 mm
 ○ 97BTX/SC8 T9-T10-T15-T20-T25-T27-T30-T40
 ○ 944BX 5-6-7-8-10-13 mm



1,9 Kg



	Ft		
M60	145.900	1	024500060
MV60	25.100	1	024510060

M62



97TTX T10-T15-T20-T25-T27-T30-T40-T45-T50
 1032 180 mm
 1034 170 mm
 1036 175 mm
 1038 175 mm
 1177BM 140 mm
 1188BM 125 mm
 1257LP 2-2,5-3-3,5 mm
 1257PH 0-00



2,3 Kg



	Ft		
M62	165.700	1	024500875
MV62	25.100	1	024510875

M63



○ 952 7-8-10-12-13-14-17-19 mm



3,4 Kg



	Ft		
M63	127.600	1	024500063
MV63	25.100	1	024510063

M65

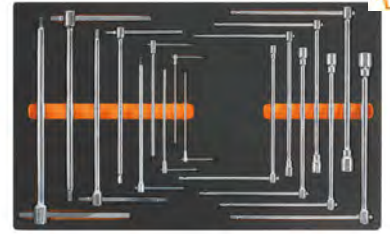

950 8-10-12-13-14-17-19 mm
 951 2,5-3-4-5-6-8-10-12-14 mm



3,6 Kg



	Ft		
M65	202.900	1	024500065
MV65	25.100	1	024510065

M67

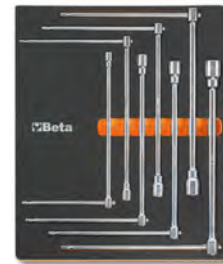

○ 950 7-8-10-12-13-17 mm



1,8 kg



	Ft		
M67	78.100	1	024500067
MV67	18.700	1	024510067

M69



○ 951 2,5-3-4-5-6-8-10-12-14 mm



1,8 kg



	Ft		
M69	113.400	1	024500069
MV69	17.450	1	024510069

M75



○ 933 7-8-9-10-11-12-13-14-15-16-17-18-19-21-22-24 mm



5,5 kg



	Ft		
M75	173.700	1	024500075
MV75	25.100	1	024510075



M78

17



80 6x7-8x9-10x11-12x13-14x15-16x17-18x19 mm

920/36A
965 450 mm
1052 240 mm
1058 175 mm
1481PL/A
1481PL/B
1481PL/C
1650 150 mm
1708/20
1716P

4,4 kg

M78	Ft 263.600	1	024500878
MV77	25.100	1	024510876

M79

6



80 8x9 -10x11-12x13 -14x15 16x17-18x19 mm

1,3 kg

M79	Ft 115.600	1	024500079
MV79	13.000	1	024510079

M82

29



○ 920A 10-11-12-13-14
15-16-17-18-19
20-21-22-23-24
26-27-30-32 mm
○ 920ME 5-6-8-10-12 mm
920AN/125 125 mm
920AN/250 250 mm
920/25
920/42 305 mm
⊕ 920/55

4,1 kg

M82	Ft 135.600	1	024500082
MV82	17.450	1	024510082

M83

24



○ 920A 10-11-12-13-14
15-16-17-18-19
20-21-22-23-24
26-27-30-32 mm
920AN/125 125 mm
920AN/250 250 mm
920/25 255 mm
920/42 305 mm
⊕ 920/55

3,7 kg

M83	Ft 111.000	1	024500083
MV83	17.450	1	024510083

M85

45



851SR 230 mm
● 860LP 0,5x3 - 0,6x4,5
- 0,8x5,5 - 1x5,5 -
1,2x6,5 mm
○ 860PE 2 - 2,5 - 3 - 4 - 5 - 6 - 8
- 10 mm
⊕ 860PH PH0 - PH1 - PH2 -
PH3 - PH4
⊕ 860PZ PZ1 - PZ2 - PZ3 - PZ4
⊕ 860TX T6-T7-T8-T9-T10-T15-
T20-T25-T27-T30-T40
⊕ 860RTX T9-T10-T15-T20-T25-
T27-T30-T40
860/55 100 mm
882P 80 mm
892 ■ 1/4 - □ 1/4

450 g

M85	Ft 75.250	1	024500085
MV85	13.000	1	024510085

M86

46



○ 867PE 4-5-6-7-8-10-12 mm
○ 867PE/L 4-5-6-7-8-10-12 mm
○ 867XZN 5-6-8-10-12 mm
○ 867XZN/L 5-6-8-10-12 mm
⊕ 867TX T20-T25-T30-T40-
T45-T50-T55
⊕ 867TX/L T25-T30-T40-T45-
T50-T55
⊕ 867RTX T20-T25-T30-T40-
T45-T50-T55
867/1
867/2

1,4 kg

M86	Ft 52.200	1	024500086
MV86	13.000	1	024510086

M91

25



○ 900 4-4,5-5,5-6-7-8-9-
10-11-12-13-14 mm
○ 900ME 2,5-3-4-5-6-8 mm
900/20 50 mm
900/21 150 mm
900/25 □ 1/4 - ■ 1/4
900BG/30
900/42
⊕ 900/55

560 g

M91	Ft 74.100	1	024500091
MV90	13.000	1	024510090

M92

22



○ 910A 6-7-8-9-10-11-12-13-
14-15-16-17-18-19-20-
21-22 mm
910/21 125 mm
910/22 250 mm
910/25
910/42
⊕ 910/55

1,5 kg

M92	Ft 92.800	1	024500092
MV92	13.000	1	024510092

M94

26



○ 900AS/L 3/16-7/32-1/4-9/32-
5/16-11/32-3/8-7/16-
1/2-9/16
○ 900AS 3/16-7/32-5/32-1/4-
9/32-5/16-11/32-3/8-
7/16-1/2-9/16
900AN 50-100mm
900/25
⊕ 900/55
900/42

930 g

M94	Ft 84.150	1	024500094
MV94	13.000	1	024510094

M96

22



○ 920A/AS 3/8-7/16-1/2-9/16-
19/32-5/8-11/16-3/4-
25/32-13/16-7/8-
15/16-1-1-1/16-1-1/18-
1-3/16-1-1/4
920/25
920AN 125-250mm
920/42
⊕ 920/55

3,8 kg

M96	Ft 113.000	1	024500096
MV96	17.450	1	024510096

M100

98



- 895/1
- 895/3
- 895/6
- 900 4-4, 5-5, 5-5, 6-7, 8-9, 10-11, 12-13, 14 mm
- 900L 5-6-7-8-9-10-11-12-13 mm
- 900ME 3-4-5-6-7 mm
- 900LP 0,8x4-1x5,5-1,2x6,5-1,2x8 mm
- ⊕ 900PH PH1-PH2-PH3-PH4
- ⊕ 900TX T10-T15-T20-T25-T27-T30-T40
- 900/20 50 mm
- 900/20L 100 mm
- 900/21 150 mm
- 900/25
- 900BG/30
- 900/42
- ⊕ 900/55
- 920A 8-10-11-12-13-14-15-16-17-18-19-20
21-22-23-24-26-27-28-30-32 mm
- 920/15
- 920/25
- 920AN/125 125 mm
- 920AN/250 250 mm
- 920/42
- ⊕ 920/55
- 920FTX 10-12-14-16-18-20-22-24 mm
- 920AL 10-12-13-14-15-16-17-18-19-21-22

6,7 Kg

14" 12"



	Ft		
M100	360.400	1	024500100
MV100	25.100	1	024510100

M105

116



- 900 4-4, 5-5, 5-5, 6-7, 8-9, 10-11, 12-13, 14 mm
- 900L 5-6-7-8-9-10-11-12-13 mm
- 96BPC/SC9 1,5-2-2,5-3-4-5-6-8-10 mm
- 895/1
- 895/3
- 895/6
- 900ME 3-4-5-6-7 mm
- 900LP 0,8x4-1x5,5-1,2x6,5-1,2x8 mm
- ⊕ 900PH PH1-PH2-PH3-PH4
- ⊕ 900TX T10-T15-T20-T25-T27-T30-T40
- 900/16 □ 1/4 - ■ 3/8
- 900/... 50-100-150 mm
- 900/25
- 900BG/30
- 900/42
- ⊕ 900/55
- 910A 6-7-8-9-10-11-12-13-14-15-16-17-18-19-
20-21-22 mm
- 910/15 □ 3/8 - ■ 1/4
- 910/16 □ 3/8 - ■ 1/2
- 910/21 125 mm
- 910/22 250 mm
- 910/25
- 910/42
- ⊕ 910/55
- 920A 8-10-11-12-13-14-15-16-17-18-19-20-21-
22-23-24-26-27-28-30-32 mm
- 920/15 □ 1/2 - ■ 3/8
- 920/25
- 920AN 125 - 250 mm
- 920/42
- ⊕ 920/55
- 956E 16-17,8-20,8 mm

7,7 kg

14" 38" 12"



	Ft		
M105	430.900	1	024500871
MV105	25.100	1	024510871

M108

27



- 910MQ/PE 4-5-6-8 mm
- 910MQ/B 7-8-10-11-12-13-14-15-16-17-19 mm
- ⊕ 910MQ/TX T15-T20-T25-T27-T30-T40
- 910MQ/XZN 8-10 mm
- 910MQ/21 125 mm
- 910MQ/22 250 mm
- 910MQ/T
- 910MQ/55

2,7 kg



	Ft		
M108	508.800	1	024500108
MV108	25.100	1	024510108

M110

36



- ⊕ 850MQ
- ⊕ 860TX/A10
- 920MQ/A 8-9-10-11-12-13-14-15-16-17-18-19-20
mm
- 920MQ/PE 5-6-8-10-12 mm
- 920MQ/21 125 mm
- 920MQ/22 250 mm
- 920MQ/55A
- 943MQ 6-7-8-10 mm

3,1 kg



	Ft		
M110	489.800	1	024500110
MV110	25.100	1	024510110

M112

32



- ⊕ 861TX ● 1/4-T6+T15
- ⊕ 866TX ● 5/16-T20+T55
- 895/1 ○ 1/4x□1/4
- 895/6 ○ 5/16x□1/2
- ⊕ 900FTX □ 1/4-E4+E10
- ⊕ 920FTX □ 1/2-E12+E24
- ⊕ 920TX □ 1/2-T55L-T60-T70L

1,3 kg

14" 12"



	Ft		
M112	90.100	1	024500112
MV112	13.000	1	024510112

M115

54



- ⊕ 666N/20 40+200 Nm
- 920A 13-14-15-16-17-18-19-20-21-22-24-26-
27-30-32 mm
- 920FTX 12-14-16-18-20-22-24 mm
- 920PE 6-7-8-8L-10-10L-12-12L-14-14L
- ⊕ 920TX T20-T25-T27-T30-T40-T45-T50-T55-T60-
T20L-T25L-T27L-T30L-T40L-T45L-T50L
- 920/21 125 mm
- 920/22 255 mm
- 920/25
- 920/42 305 mm
- ⊕ 920/55

7,8 Kg

12"



	Ft		
M115	342.200	1	024500115
MV115	25.100	1	024510115



M120

75



- 920A 10-11-12-13-14-15-16-17-18-19-20-21-22-24-26-27-30-32 mm
- 920AN/125 125 mm
- 920AN/250 250 mm
- 920/25
- 920/42
- 920AL 10-12-13-14-15-16-17-18-19-22-24-27-30-32 mm
- ⊗ 920FTX 10-12-14-16-18-20-22-24 mm
- ⊗ 920/55
- 920PE 5-5L-6-6L-7-7L-8-8L-10-10L-12-12L-14-14L
- ⊗ 920TX T20-T25-T27-T30-T40-T45-T50-T55-T60-T20L-T25L-T27L-T30L-T40L-T45L-T50L

6,9 Kg

12"



	Ft	
M120	361.700	1 024500120
MV120	25.100	1 024510120

M121

46



- 920BP 5L-6L-8L-10L-5XL-6XL-8XL mm
- ⊗ 920TX T20-T25-T27-T30-T40L-T45L-T50L-T55L-T60L-T70L
- 920XZN 4-5-6-6L-8-8L-10-10L-12-12L-14-14L-16-18 mm
- ⊗ 920ES 7-9-10-11-12L-14L-16L-7XL-9XL-10XL-11XL-12XL-14XL-16XL mm
- 920/36A

6,3 Kg

12"



	Ft	
M121	328.000	1 024500121
MV121	25.100	1 024510121

M125

68



- 910AL 8-9-10-11-12-13-14-15-16-17-19-21-22 mm
- 920PE 5-6-6L-7-8-8L-10-10L-12-12L mm
- ⊗ 920FTX E12-E14-E16-E18-E20-E22-E24
- ⊗ 920TX T20-T25-T27-T30-T30L-T40-T40L-T45-T50-T50L-T55-T60-T60L
- 920XZN 5-6-6L-8-8L-10-10L-12L mm
- 920AL 10-12-13-14-15-16-17-18-19-21-22-23-24-27-30-32 mm
- 1692/5 5 m

7,9 kg

38" 12"



	Ft	
M125	352.600	1 024500872
MV125	25.100	1 024510872

M126

26



- 928A 19-21-22-24-26-27-28-30-32-34-35-36-38-41-46 mm
- 928ME 14-17-19-22 mm
- 928/15 □ 3/4 - ■ 1/2
- 928/16 □ 3/4 - ■ 1
- 928/21 200 mm
- 928/22 380 mm
- 928/25 450 mm
- 928/42
- ⊗ 928/55

12,4 kg

34"



	Ft	
M126	307.700	1 024500126
MV126	25.100	1 024510126

M127

23



- 728 19-21-22-24-27-30-32-33-34-35-36-38-40-41-46
- ⊗ 728FTX 20-22-24 mm
- 728/15 □ 3/4 - ■ 1/2
- 728/16 □ 3/4 - ■ 1
- 728/21 175 mm
- 728/22 250 mm
- 728/25

12,5 kg

34"



	Ft	
M127	198.700	1 024500127
MV127	25.100	1 024510127

M128

50



- 720 10-11-12-13-14-15-16-17-18-19-21-22-24-27-30-32 mm
- 720L 10-11-12-13-14-15-16-17-18-19-21-22-24-27-30-32 mm
- ⊗ 720TX T30-T40-T45-T50-T55
- 720ME 5-6-8-10-12-14-17-19 mm
- 720LC 17-19-21 mm
- 720/21 125 mm
- 720/25

8,9 kg

12"



	Ft	
M128	200.400	1 024500128
MV128	25.100	1 024510128

M129

13



- 1032 180 mm
- 1034 170 mm
- 1036 175 mm
- 1038 175 mm
- 1048N 250 mm
- 1052 240 mm
- ⊗ 1082BM 160 mm
- 1098 220 mm
- 1112 250 mm
- 1128BM
- 1150BM 180 mm
- 1166BM 160 mm
- 1168BM 160 mm

3,4 Kg

Ft



	Ft	
M129	168.100	1 024500129
MV138	24.700	1 024510138

M133

3



- ⊗ 1082G 160 mm
- 1150G 180 mm
- 1166G 160 mm

650 g

Ft



	Ft	
M133	29.300	1 024500133
MV133	13.000	1 024510133

M134

3



- ⊗ 1082GBM 160 mm
- 1150GBM 180 mm
- 1166GBM 160 mm

750 g

Ft



	Ft	
M134	37.950	1 024500134
MV134	13.000	1 024510134

M135



- 1082MQ 160 mm
- 1150MQ 180 mm
- 1166MQ 160 mm

750 g



	Ft		
M135	60.300	1	024500135
MV135	13.000	1	024510135

M136



- 1084BM 160 mm
- 1150BM 180 mm
- 1166BM 160 mm

750 g



	Ft		
M136	40.550	1	024500136
MV131	13.000	1	024510131

M137



- 1084 160 mm
- 1150 180 mm
- 1166 160 mm

650 g



	Ft		
M137	32.550	1	024500137
MV132	13.000	1	024510132

M145



- 1032 180 mm
- 1034 170 mm
- 1036 175 mm
- 1038 175 mm

640 g



	Ft		
M145	48.950	1	024500145
MV145	13.000	1	024510145

M153



- 1048N 250 mm
- 1052 240 mm

1 kg



	Ft		
M153	38.300	1	024500153
MV154	13.000	1	024510154

M161



- 1128MQ
- 1048MQ 250 mm
- 1082MQ 160 mm
- 1150MQ 180 mm
- 1162MQ 160 mm
- 1164MQ 160 mm
- 1272MQ PH0x60 - PH1x80 - PH2x100 - PH3x150 mm
- 1274MQ 2,5x75 - 3x100 - 4x100 - 5,5x125 mm
- 1777MQ/U

3,0 kg



	Ft		
M161	183.000	1	024500161
MV161	25.100	1	024510161

M162

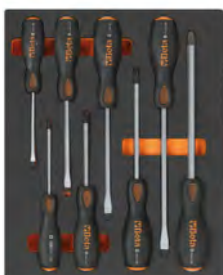

- 1241 5,5x100-6,5x125-8x150-10x200 mm
- 1242 PH1x100-PH2x100-PH3x150-PH4x200 mm

1,4 kg



	Ft		
M162	45.550	1	024500162
MV162	17.450	1	024510162

Beta

Quality Tools

M166



- 860MIX/A31

- 1048N 250 mm
- 1082BM 160 mm
- 1150BM 180 mm
- 1162BM 160 mm
- 1290 3x75-4x100-5,5x100-6,5x150-8x150 mm
- 1290N 6,5x30 mm
- 1292 4,5x80-6x100-8x150 mm
- 1292N 6x30 mm
- 1297TX T20-T25-T27-T30

2,9 kg



	Ft		
M166	166.800	1	024500879
MV880	26.900	1	024510880

M170



- 1290 2,5x50
- 3x75
- 3,5x100
- 4x125
- 5,5x100
- 5,5x150
- 6,5x150 mm

500 g



	Ft		
M170	24.050	1	024500170
MV170	13.000	1	024510170

M172



- 1292 PH0x60
- PH0x100
- PH1x80
- PH1x120
- PH2x100
- PH2x150 mm

450 g



	Ft		
M172	22.100	1	024500172
MV172	13.000	1	024510172



M174



● 1297TX T8-T10-T15-T20-T25-T30

450 g



M174	Ft 32.500	1 024500174
MV174	13.000	1 024510174

M180



● 1290 3x75
4x100
5,5x150
6,5x150 mm
⊕ 1292 PH0x60
PH1x80
PH2x100 mm

500 g



M180	Ft 25.050	1 024500180
MV180	13.000	1 024510180

M195



● 1260 2,5x50-3x75-4x100-5,5x125-6,5x150-8x200 mm
● 1260N 4x30 mm
⊕ 1262 PH0x60-PH1x80-PH2x100-PH3x150 mm
⊕ 1262N PH1X30 mm
● 1267TX T6-T7-T8-T9-T10-T15-T20-T25-T27-T30-T40-T45
● 1253 3,5x100 mm

2,3 kg



M195	Ft 108.200	1 024500195
MV195	25.100	1 024510195

M201



● 1260 3x75-4x100-6,5x150 mm
⊕ 1262 PH0x60-PH1x80-PH2x100 mm

500 g



M201	Ft 28.200	1 024500201
MV201	13.000	1 024510201

M204



● 1267TX T8-T10-T15-T20-T25-T30

450 g



M204	Ft 25.200	1 024500204
MV204	13.000	1 024510204

M208



● 1260 3x75
3,5x100
4x125
5,5x150
6,5x150 mm
⊕ 1262 PH0x60
PH1x80
PH2x100 mm
● 1260N 4x30 mm
⊕ 1262N PH1x30 mm

750 g



M208	Ft 28.250	1 024500208
MV208	17.450	1 024510208

M209



● 1260N 4x30 mm
● 1264 2,5x60 - 3x100 - 4x125 - 5x150 - 6,5x150 mm
⊕ 1262 PH0x60 - PH1x80 - PH2x100 mm
⊕ 1262N PH1x30 mm

820 g



M209	Ft 28.100	1 024500209
MV208	17.450	1 024510208

M213

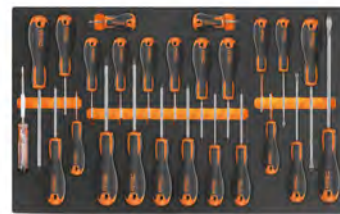

● 1201E 2,5x50-3x75-4x100-5,5x125-6,5x150-8x200 mm
● 1201EN 4x30 mm
⊕ 1202E PH0x60-PH1x80-PH2x100-PH3x150 mm
⊕ 1202EN PH1X30 mm
● 1207E/TX T6-T7-T8-T9-T10-T15-T20-T25-T27-T30-T40-T45
● 1253 3,5x100 mm

1,8 Kg



M213	Ft 66.550	1 024500213
MV210	25.100	1 024510210

M214



● 1201E 2,5x50-3x75-3,5x100-4x125-5,5x100-5,5x150-6,5x150 mm

500 g



M214	Ft 14.900	1 024500214
MV211	13.000	1 024510211

M216



⊕ 1202E PH0x60-PH1x80-PH1x120-PH2x100-PH2x150-PH3x150 mm

450 g



M216	Ft 15.750	1 024500216
MV212	13.000	1 024510212

M217



● 1207E/TX T6-T7-T8-T9-T10-T15-T20

500 g



M217	Ft 15.750	1 024500217
MV215	13.000	1 024510215



M218



- 1201E 3x75
4x100
5,5x150
6,5x150 mm
- ⊕ 1202E PH0x60
PH1x80
PH2x100 mm

500 g



	Ft		
M218	15.600	1	024500218
MV220	13.000	1	024510220

M219



- ⊕ 1202E 3x60 - 4,5x80 - 6x100 mm
- 1204E 3x75 - 4x100 - 5x150 - 6,5x150 mm

590 g



	Ft		
M219	16.150	1	024500219
MV220	13.000	1	024510220

M222



- ⊕ 1272MQ PH0x60 mm
- ⊕ 1272MQF PH1x80 - PH2x100 mm
- 1274MQF 3,5x100 - 4,5x100 - 5,5x125 - 6,5x150 mm

540 g



	Ft		
M222	44.200	1	024500222
MV222	13.000	1	024510222

M226



- 1274MQ 3x100
4x100
5,5x125
6,5x150 mm
- ⊕ 1272MQ PH0x60
PH1x80
PH2x100 mm

500 g



	Ft		
M226	32.350	1	024500226
MV226	13.000	1	024510226

M227



- 944BX 6-7-8-10-13 mm

420 g



	Ft		
M227	47.150	1	024500227
MV227	13.000	1	024510227

M230



- 30 Ø 2-3-4 mm
- 31 Ø 2-3-4-5-6-8 mm
- 32 Ø 4 mm
- 34 150 mm
- 35 200-250 mm
- 36 125 mm
- 1370 500 g
- 1390 Ø 35 mm
- 1692 3 m
- 1712TF
- 1719BMA/Q 200 mm
- ▲ 1719BMA/T 200 mm
- 1719BMA/P 200 mm
- ▶ 1719BMA/M 200 mm
- 1719BMA/R 200 mm
- 1737NX
- 1771 18 mm

3,2 Kg



	Ft		
M230	158.200	1	024500230
MV230	25.100	1	024510230



M231



- 31 2-3-4-5-6-8 mm
- 32 4 mm
- 34 125-150-175 mm
- 36 125 mm
- 1370 500-1000 g
- 1390 Ø 35 mm
- 1712TF 590 mm
- 1715 670 mm
- 1719BMA8/Q 200 mm
- ▲ 1719BMA8/T 200 mm
- 1719BMA8/P 200 mm
- ▶ 1719BMA8/M 200 mm
- 1719BMA8/R 200 mm
- 1737NX

4,7 kg



	Ft		
M231	151.800	1	024500877
MV231	25.100	1	024510877

M234



- 35 100-200 mm
- 1370 300 g
- 1390 Ø 35 mm

1,3 kg



	Ft		
M234	37.450	1	024500234
MV232	13.000	1	024510232

M236



- 1719BMA/Q 200 mm
- ▲ 1719BMA/T 200 mm
- 1719BMA/P 200 mm
- ▶ 1719BMA/M 200 mm
- 1719BMA/R 200 mm

870 g



	Ft		
M236	36.950	1	024500236
MV236	13.000	1	024510236

M237



35 100-200 mm
1370T 300 mm
1390N Ø 35 mm

1,3 kg



	Ft		
M237	40.550	1	024500237
MV232	13.000	1	024510232

M240



31BM Ø 2-3-4-5-6-8 mm
32 Ø 4 mm

850 g



	Ft		
M240	49.750	1	024500240
MV240	13.000	1	024510240

M264



1491 Ø 65+110 mm
■ 1494 ■ 10 mm
○ 1494E ○ 8-9-10-11-12-14-17 mm
○ 1494Q ○ 8-9,5-12-13 mm
△ 1494T △ 9,5
○ 1494XZN ○ 16
1496C ■ 8x ■ 10 mm

2,1 kg



	Ft		
M264	84.700	1	024500264
MV264	13.000	1	024510264

M284



1128BMX
1130BMX
■ 1719BMA...Q 200 mm
▲ 1719BMA...P 200 mm
▶ 1719BMA...M 200 mm
● 1719BMA...R 200 mm
1726BM 400 mm
1728BM (5)
1771BM 170 mm
1778V18 185 mm

2,4 Kg



	Ft		
M284	91.650	1	024500284
MV284	25.100	1	024510284

M285



1112 250 mm
1128BM
1726 440 mm
1728BM (5)
1753 200 cc

1,5 kg



	Ft		
M285	46.550	1	024500285
MV285	25.100	1	024510285

M289



1692 5 m
1725CR
1755 30 cc
1771

500 g



	Ft		
M289	18.950	1	024500289
MV289	13.000	1	024510289

M292



111E 250 mm
1128BMX
1692/5 5 m
1771 170 mm

500 g



	Ft		
M292	44.700	1	024500292
MV293	12.850	1	024510293

M295



1650
1682 L=300 mm
1707
1708/20

450 g



	Ft		
M295	43.300	1	024500295
MV295	13.000	1	024510295

M305



1927B
○ 720 12-13-14-15-16-17
18-19-21-22
24-27 mm
720/21

4,2 kg



	Ft		
M305	137.200	1	024500305
MV305	17.450	1	024510305

M310



1927CD
○ 720 12-13-14-15-16-17
18-19-21-22
24-27 mm
720/21

4,0 kg



	Ft		
M310	230.900	1	024500310
MV310	17.450	1	024510310

Beta

M400



- 3932U
- 3935 120 mm
- 3937 170 mm
- 3952 13-14-15-16-17-18-19 mm
- 3961 3,2
- 3961 3,3
- 3961 3,5
- 3961U 3,2 - 4,0 mm
- 3969 200 mm (x2)
- 3969K3 113 mm
- 3973/1
- 3973/2
- 3973/3
- 3973/3
- 3973/4
- 3984/1 Ø35 mm
- 3984/2 Ø22,8 mm
- 3984/3 Ø23,5 mm
- 3984/4 Ø23 mm
- 3991 222 mm
- 3992 234 mm

3,1 kg



	Ft		
M400	196.900	1	024500400
MV400	24.700	1	024510400

M401



- 3921 440 mm
- 3948
- 3953
- 3955 30x32 - 32x36 mm
- 3967 289 mm
- 3971

2,7 kg



	Ft		
M401	135.400	1	024500401
MV401	24.700	1	024510401

RSC22 RSC23 RSC23C C27S		503 518
C41S C41H		503

MC10



- 42 6-7-8-9-10-11-12
13-14-15-16-17
18-19-21-22 mm
- 96/SC9 1,5-2-2,5-3-4-5-6-8-10 mm
- ≡ 1084BM 160 mm
- ≡ 1150G 180 mm
- 1166G 160 mm
- 1201E 3,5x100-5,5x150-6,5x150 mm
- ⊕ 1202E PH0x60-PH1x80-PH2x100 mm

3,5 kg



	Ft		
MC10	132.000	1	027500011
MVC10	17.450	1	027510010

MC12



- 42 6-7-8-9-10-11-12-13-14-15-16-17-18-19-21-22 mm
- 96/SC9 1,5-2-2,5-3-4-5-6-8-10 mm
- 1692/5 5 m

2,2 kg



	Ft		
MC12	84.050	1	041500012
MVC11	17.450	1	041510011

MC20



- 860MIX/A31
- 895/1
- 1048N 250 mm
- 1370 300 g
- 32 Ø 4 mm
- 36 Ø 4 mm
- 900 4-4,5-5-5,5-6-7-8-9-10-11-12-13-14 mm
- 900/21 150 mm
- 900/25
- 900BG/30C
- 900/42
- 900/55
- 920A 10-11-12-13-14-15-16-17-18-19-21-22-24-27-30-32 mm
- 920/25
- 920AN/125 125 mm
- 920/42
- 920/55

6 kg



	Ft		
MC20	214.100	1	027500020
MVC20	18.700	1	027510021

MC21



- 920A 10-11-12-13-14-15-16-17-18-19-20-21-22-23-24-26-27-30-32 mm
- 920/25
- 920/42
- 920/55
- 920AN 125-250 mm

4,3 kg



	Ft		
MC21	111.000	1	041500021
MVC21	17.450	1	041510021



C35

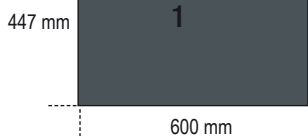

504÷506



MB12

30



- 42 6-7-8-9-10-11-12-13-14-15-16-17-18-19-20-21-22-24-27-30-32 mm
- 55 6x7-8x9-10x11
12x13-14x15
16x17-18x19
20x22 mm
- 1048N 250 mm

	Ft		
MB12	207.600	1	024504212
MBV13	72.050	1	024524213

MB38

80



- 96T 2-2,5-3-4-5-6-7-8 mm
- 851SR 230 mm
- 860LP 0,5x3 - 0,6x4,5 - 0,8x5,5 - 1x5,5 - 1,2x6,5 mm
- 860PE 2 - 2,5 - 3 - 4 - 5 - 6 - 8 - 10 mm
- ⊕ 860PH PH0 - PH1 - PH2 - PH3 - PH4
- ⊕ 860PZ PZ1 - PZ2 - PZ3 - PZ4
- ⊕ 860RTX T9-T10-T15-T20-T25-T27-T30-T40
- ⊕ 860TX T6-T7-T8-T9-T10-T15-T20-T25-T27-T30-T40
- 860/55 100 mm
- 882P
- 892/0
- 920/21 125 mm
- 920/22 255 mm
- 920/25
- 920/42
- ⊕ 920/55
- ⊕ 1084BM 160 mm
- ≡ 1150BM 180 mm
- 1166BM 160 mm

	Ft		
MB38	280.200	1	024504238
MBV35	68.250	1	024524235

MB39

39



- 920A 10-11-12-13-14-15-16-17-18-19-20-21-22-23-24-26-27-30-32 mm
- 920/21 125 mm
- 920/22 255 mm
- 920/25
- 920/42
- ⊕ 920/55
- 920PE 5-6-8-10-12 mm
- 1032 180 mm
- 1034 170 mm
- 1036 175 mm
- 1038 175 mm
- 35 200 mm
- ⊕ 1084BM 160 mm
- ≡ 1150BM 180 mm
- 1166BM 160 mm
- 1370 500 g
- 1390 35 mm

	Ft		
MB39	259.600	1	024504239
MBV36	68.250	1	024524236

MB37

52



- 920A 10-11-12-13-14-15-16-17-18-19-20-21-22-23-24-26-27-30-32 mm
- 920/21 125 mm
- 920/22 150 mm
- 920/25
- 920/42
- ⊕ 920/55
- 111E 250 mm
- 1052 240 mm
- ⊕ 1084BM 160 mm
- ≡ 1150BM 180 mm
- 1166BM 160 mm
- 1032 180 mm
- 1034 170 mm
- 1036 175 mm
- 1038 175 mm
- 900 4,4,5,5,5,6,7,8,9-10-11-12-13-14 mm
- 900/20 50 mm
- 900/21 150 mm
- 900/25
- 900BG/30
- ⊕ 900/55
- 900/42

	Ft		
MB37	324.900	1	024504237
MBV40	72.050	1	024524240



MB44

34



- 1260 2,5x50-3x75-3,5x100-4x100-5,5x125-6,5x150-8x200 mm
- 1260N 4x30-6,5x30 mm
- ⊕ 1262 PH0x60-PH0x100-PH1x80-PH1x120-PH2x100-PH2x150-PH3x150 mm
- ⊕ 1262N PH1x30-PH2x30 mm
- 1253
- 96BPC/SC9
- 951 2,5-3-4-5-6-8 mm

	Ft		
MB44	140.000	1	024504244
MBV44	68.250	1	024524244

MB45

29



- 1260 2,5x50-3x75-3,5x100-4x100-5,5x100-5x125-6,5x150 mm
- ⊕ 1262 PH0x60-PH0x100-PH1x80-PH1x120-PH2x100-PH2x150 mm
- ⊗ 1267TX T8-T10-T15-T20-T25-T30
- 1052 240 mm
- 96BPC/SC9

2,8 kg



	Ft		
MB45	100.100	1	024504245
MBV45	68.250	1	024524245

MB46

29



- 1260 3x75-4x100-5,5x125-6,5x150 mm
- ⊕ 1262 PH0x60-PH1x80-PH2x100 mm
- ⊗ 1267TX T8-T10-T15-T20-T25-T30
- 96BPC/SC9
- 96T 2-2,5-3-4-5-6
- 1052 240 mm

2,8 kg



	Ft		
MB46	117.000	1	024504246
MBV46	68.250	1	024524246

MB47

48



- 1260 3x75-4x100-5,5x125-6,5x150 mm
- ⊕ 1262 PH0x60-PH1x80-PH2x100 mm
- 1260N 4x30 mm
- ⊕ 1262N PH1x30 mm
- 96T 2,5-3-4-5-6-8 mm
- 96BPC/SC9
- 920A 10-11-12-13-14-15-16-17-18-19-20-21-22-23-24-26-27-30-32 mm
- 920/21 125 mm
- 920/22 250 mm
- 920/25
- 920/42
- ⊗ 920/55

5,6 kg

12"



	Ft		
MB47	214.900	1	024504247
MBV47	68.250	1	024524247

MB56

15



- 1719BMA/Q 200 mm
- ▲ 1719BMA/T 200 mm
- 1719BMA/P 200 mm
- ▶ 1719BMA/M 200 mm
- 1719BMA/R 200 mm
- 1032 180 mm
- 1034 170 mm
- 1036 175 mm
- 1038 175 mm
- 1370T 300 g
- 1390N Ø 35 mm
- 35 200 mm
- 1692 5 mt
- 1725CR 260 mm
- 1771 18 mm

3,7 kg



	Ft		
MB56	142.400	1	024504256
MBV56	68.250	1	024524256

MB58

17



- 31 Ø 2-3-4-5-6 mm
- 32 Ø 4 mm
- 35 200 mm
- 1112 250 mm
- 1128BMX
- 1370 500 g
- 1390 Ø 45 mm
- 1719BMA...Q 200 mm
- ▲ 1719BMA...T 200 mm
- 1719BMA...P 200 mm
- ▶ 1719BMA...M 200 mm
- 1719BMA...R 200 mm
- 1726 440 mm

4,5 kg



	Ft		
MB58	144.500	1	024504258
MBV55	68.250	1	024524255



MB59

15



- 1719BMA...Q 200 mm
- ▲ 1719BMA...T 200 mm
- 1719BMA...P 200 mm
- ▶ 1719BMA...M 200 mm
- 1719BMA...R 200 mm
- 31 Ø 4-6 mm
- 32 Ø 4 mm
- 35 125-200 mm
- 1370 300 g
- 1390 Ø 35 mm
- 1692 5 mt
- 1725 420 mm
- 1833XS/2

3,4 kg



	Ft		
MB59	118.000	1	024504259
MBV57	68.250	1	024524257

MB65

16



- 1719BMA...Q 200 mm
- 1719BMA...P 200 mm
- 1719BMA...T 200 mm
- 1719BMA...M 200 mm
- 1719BMA...R 200 mm
- 35 200 mm
- 1032 180 mm
- 1034 170 mm
- 1036 175 mm
- 1038 175 mm
- 1052 240 mm
- ⚡ 1084BM 160 mm
- 1150BM 180 mm
- 1166BM 160 mm
- 1370 500 g
- 1390 Ø 35 mm

4,8 kg



	Ft		
MB65	181.500	1	024504265
MBV61	68.250	1	024524261

MB63

60

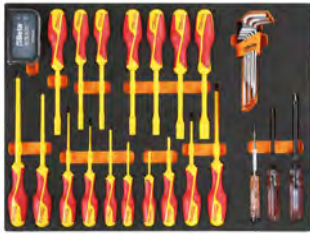

- 96BPC/SC9
- 1250 4x125 mm
- ⊕ 1251 PH1x125 mm
- 1253
- 943MQ 5,5-6-7-8-10-13 mm
- ⊕ 1272MQ PH0x60-PH1x80-PH2x100-PH3x150 mm
- 1274MQ 2,5x75-3x100-4x100-5,5x125-6,5x150-8x175 mm
- 860LP 0,5x3 - 0,6x4 - 0,8x5,5
1,0x5,5 - 1,2x6,5 mm
- 860PE 2 - 2,5 - 3 - 4 - 5 - 6
8 - 10 mm
- ⊕ 860PH PH0 - PH1 - PH2 - PH3 - PH4
- ⊕ 860PZ PZ1 - PZ2 - PZ3 - PZ4
- ⊕ 860RTX T9 - T10 - T15 - T20
T25 - T27 - T30 - T40
- 882MSR 50 ○ 1/4 ● 1/4
- 850MQ

3,2 kg

	Ft	
MB63	173.000	1 024504263
MBV63	68.250	1 024524263

MB64

20



- 55 6x7-8x9-10x11
12x13-14x15
16x17-18x19
20x22 mm
- 1048MQ 250 mm
- 1082MQ 140 mm
- 1128BSX
- 1132MQ 230 mm
- 1142MQ 160 mm
- 1150MQ 180 mm
- 1166MQ 160 mm
- 1168MQ 160 mm
- 110MQ 250 mm
- 1777MQ
- 993MQ
- 1602

4,1 kg

	Ft	
MB64	307.900	1 024504264
MBV62	68.250	1 024524262

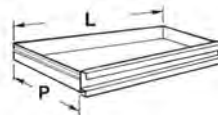

C45PRO

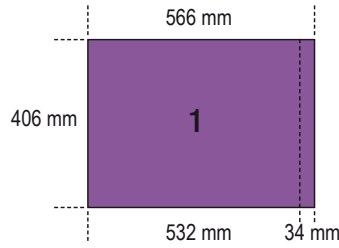

506

MM11

30



- 42 6-7-8-9-10-11-12-13-14-15-16-17-18-19-20-21-22-24-27-30-32 mm
- 96BPC/SC9 1,5-2-2,5-3-4-5-6-8-10 mm

4,5 kg

	Ft	
MM11	134.800	1 024580011
MMV10	25.100	1 024590010

MM61

17

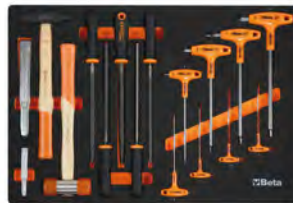

- 96T 2-2,5-3-4-5-6-7-8 mm
- 1390 Ø 35
- 1370 300 g
- 35 100-200 mm
- 1719BMA8/S5 200 mm

2,9 kg

	Ft	
MM61	122.400	1 024580061
MMV61	25.100	1 024590061

MM63

8



- 952 7-8-10-12-13-14-17-19 mm

3,4 kg

	Ft	
MM63	138.500	1 024580063
MMV63	25.100	1 024590063

MM105

107



- 895/1 ○ 1/4 □ 1/4
- 895/3 ○ 1/4 □ 3/8
- 895/6 ○ 5/16 □ 1/2
- 900 4-4,5-5-5,5-6-7-8-9-10-11-12-13-14 mm
- 900L 5-6-7-8-9-10-11-12-13 mm
- 900ME 3-4-5-6-7 mm
- 900LP 0,8x4-1x5,5-1,2x6,5-1,2x8
- ⊕ 900PH PH1-PH2-PH3-PH4
- ⊕ 900TX T10-T15-T20-T25-T27-T30-T40
- 900/16
- 900/... 50-100-150 mm
- 900/25
- 900BG/30 176 mm
- 900/42 115 mm
- 900/55 125 mm
- 910A 6-7-8-9-10-11-12-13-14-15-16-17-18-19-20-21-22 mm
- 910/15 □ 3/8 ■ 1/4
- 910/16 □ 3/8 ■ 1/2
- 910/21 125 mm
- 910/22 250 mm
- 910/25
- 910/42 210 mm
- 910/55 200 mm
- 920A 8-10-11-12-13-14-15-16-17-18-19-20-21-22-23-24-26-27-28-30-32 mm
- 1/2 ■ 3/8
- 920/15
- 920/25
- 920AN 125-250 mm
- 920/42 305 mm
- 920/55 275 mm
- 956E 16 mm (5/8")-17,8 (11/16")-20,8 (13/16")

7,2 kg

	Ft	
MM105	413.400	1 024580105
MMV105	25.100	1 024590105



MM140

52



- 97TTX T10-T15-T20-T25-T30
- 1084BM 160 mm
- 1150BM 180 mm
- 1166BM 160 mm
- 1032 180 mm
- 1034 170 mm
- 1036 175 mm
- 1038 175 mm
- 1048N 250 mm
- 1052 240 mm
- 1256/C36-2

2,2 kg



	Ft	1	024580141
MM140	181.900	1	024580141
MMV142	26.350	1	024590142

MM210

25



- 1201E 2,5x50-3x75-4x100-5,5x125-6,5x150-8x200 mm
- 1201EN 4x30 mm
- 1202E PH0x60-PH1x80-PH2x100-PH3x150 mm
- 1202EN PH1x30 mm
- 1207E/TX T6-T7-T8-T9-T10-T15-T20-T25-T27-T30-T40-T45
- 1253

2,1 kg



	Ft	1	024580211
MM210	66.550	1	024580211
MMV210	25.100	1	024590210



MM400

29



- 3932U
- 3935 120 mm
- 3937 170 mm
- 3952 13-14-15-16-17-18-19 mm

- 3961 3,2
- 3961 3,3
- 3961 3,5
- 3961U 3,2 - 4,0 mm
- 3969 200 mm (x2)
- 3969K3 113 mm

- 3973/1
- 3973/2
- 3973/3
- 3973/4
- 3984/1
- 3984/2
- 3984/3
- 3984/4
- 3991 222 mm
- 3992 234 mm

3,1 kg



	Ft	1	024580400
MM400	198.500	1	024580400
MMV400	26.350	1	024590400

MM401

7



- 3921 440 mm
- 3948
- 3953
- 3955 30x32 mm - 32x36 mm
- 3967 289 mm
- 3971

2,7 kg



	Ft	1	024580401
MM401	137.100	1	024580401
MMV401	26.350	1	024590401



VPM0 Szivacsbetét



VPM0	Ft	1	088870350
	10.300	1	088870350

VPM3 Szivacsbetét

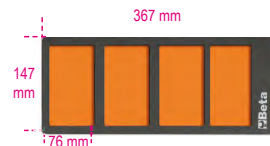

VPM3	Ft	1	088870353
	10.300	1	088870353

VPM7

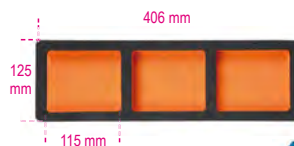

VPM7	Ft	1	088870356
	11.950	1	088870356

VPM8



VPM8	Ft	1	088870357
	9.200	1	088870357

VPM9



VPM9	Ft	1	088870358
	8.740	1	088870358

VPM7-C

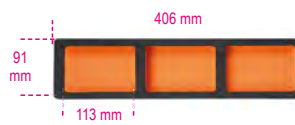

VPM7-C	Ft	1	088870360
	13.400	1	088870360

Kemény hőformált tálcák T-széria



Szerszámkészletek hőformált tálcákon
fiókos szerzámtárolókhöz,
valamint az összes típusú tárolóhoz.

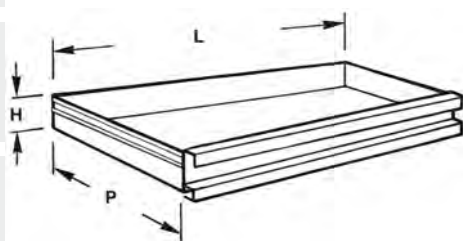

H	LxP
mm	mm
70	588x367

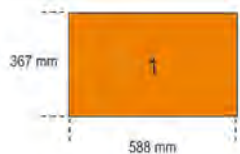
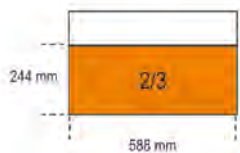
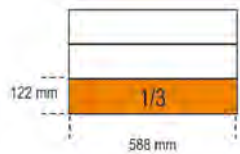
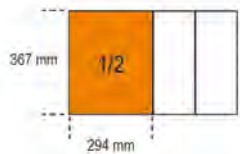
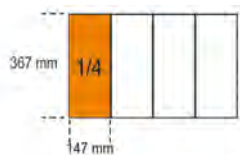

T01



42 6-7-8-10-11-12-13
14-16-17-18-19-21
22-24-27-30 mm

2,7 kg

	Ft	
T01	86.050	1 024240001
TV10	12.800	1 024000400

T05



42 6-7-8-9-10-11-12
13-14-15-16-17
18-19-20-21 mm

1,5 kg

	Ft	
T05	65.350	1 024240005
TV15	9.520	1 024000445

T06



42 22-24-27-30-32 mm

2,1 kg

	Ft	
T06	45.600	1 024240006
TV16	9.520	1 024000446

T13



42SLIM 8-10-11-12
13-14-15-16-17
18-19 mm

1,5 kg

	Ft	
T13	49.350	1 024240013
TV13	9.520	1 024249913

T18



42MP 6-7-8-9-10-11-12
13-14-15-16-17
18-19-20-21 mm

1,5 kg

	Ft	
T18	92.500	1 024240018
TV15	9.520	1 024000445

T19



42MP 22-24-27-30-32 mm

2,1 kg

	Ft	
T19	61.400	1 024240019
TV16	9.520	1 024000446

T22



42AS 5/16-3/8-7/16-1/2
9/16-5/8-11/16-3/4
96AS/BG7 3/32-1/8-5/32-3/16
1/4-5/16-3/8

1 kg

	Ft	
T22	52.950	1 024240022
TV20	9.520	1 024000488

T23



42INOX 8-10-11-12-13-14-15-
17-19 mm
96BPINOX 2,5-3-4-5-6-8-10 mm

1 kg

	Ft	
T23	91.550	1 024240023
TV23	9.520	1 024249906

T31



31 Ø 2-3-4-5-6 mm
 32 Ø 4 mm
 55 6x7-8x9-10x11
 12x13-14x15
 16x17-18x19
 20x22-21x23
 24x26-27x29
 30x32 mm
 ○ 96N/SC9 1,5+10 mm

3 kg



	Ft		
T31	77.500	1	024240031
TV30	12.800	1	024000401

T33



55 6x7-8x9-10x11
 12x13-14x15
 16x17-18x19
 20x22 mm
 ○ 96/SC9 1,5+10 mm

1 kg



	Ft		
T33	31.450	1	024240033
TV20	9.520	1	024000488

T34



55MP 6x7-8x9-10x11
 12x13-14x15
 16x17-18x19
 20x22 mm
 ○ 96/SC9 1,5+10 mm

1 kg



	Ft		
T34	39.500	1	024240034
TV20	9.520	1	024000488

T40



90 6x7-8x9-10x11
 12x13-14x15
 16x17-18x19 mm

810 g



	Ft		
T40	31.950	1	024240040
TV40	9.520	1	024000456

T41



90 20x22-21x23
 24x26-25x28
 27x29 mm

1,5 kg



	Ft		
T41	57.300	1	024240041
TV41	9.520	1	024000457

T45



142 8-9-10-11-12
 13-14-15-16
 17-18-19 mm

1,3 kg



	Ft		
T45	118.400	1	024240045
TV45	9.520	1	024000498

T46



142SN 8-9-10-11-12
 13-14-15-16
 17-18-19 mm

1,5 kg



	Ft		
T46	140.400	1	024240046
TV46	9.520	1	024000499

T48



○ 96BPC/SC9 1,5+10 mm
 142C 8-9-10-11-12
 13-14-15-16
 17-18-19 mm

1,4 kg



	Ft		
T48	101.300	1	024240048
TV47	9.520	1	024000763

T50



○ 96T 2-2,5-3-3,5-4-4,5
 5-6-7-8-10 mm

1,3 kg



	Ft		
T50	65.800	1	024240050
TV50	12.800	1	024000764

T52



○ 96T 2-2,5-3-4-5-6 mm

350 g



	Ft		
T52	31.850	1	024240052
TV52	9.520	1	024000765

T53



○ 96BTP 2,5-3-4-5-6 mm

300 g



	Ft		
T53	28.600	1	024240053
TV52	9.520	1	024000765

T55



○ 97TTX T10-T15-T20
 T25-T27-T30

330 g



	Ft		
T55	36.350	1	024240055
TV55	9.520	1	024000766

T57



96TINOX 2,5-3-4-5-6 mm



350 g

T57	Ft 30.550	1 024240057
TV57	9.520	1 024249907

T59



- 111E 250 mm
- 920/40 1/2
- 951 2,5-3-4-5-6-8 mm
- 953 4-5-6-8 mm
- 1370 300 - 500 g

4,7 kg

T59	Ft 168.100	1 024240059
TV60	20.200	1 024000420

T63



952 7-8-10-12-13-14-17-19 mm

3,8 kg

T63	Ft 124.200	1 024240063
TV63	16.450	1 024000471

T64



- 952FTX E10-E12-E14
- 953TX T25-T27-T30-T40-T45

3,8 kg

T64	Ft 155.700	1 024240064
TV63	16.450	1 024000471

T65



953 3-3,5-4-5-6-7-8-10 mm

2,8 kg

T65	Ft 122.000	1 024240065
TV63	16.450	1 024000471

T68



951 2,5-3-4-5-6-8 mm

590 g

T68	Ft 53.850	1 024240068
TV68	9.520	1 024000470

T73



- 930 6x7-8x9-10x11-12x13-14x15-16x17-18x19-20x22 mm
- 940/1
- 940/2

1,3 kg

T73	Ft 81.550	1 024240073
TV73	9.520	1 024000418

T75



- 933 7-8-9-10-11-12-13-14-15-16-17-18-19-21-22-24 mm

4,2 kg

T75	Ft 169.000	1 024240075
TV75	20.200	1 024000422

T76



- 932 7-8-9-10-11-12-13-14-15-16-17-18-19-21-22-24 mm

4,2 kg

T76	Ft 169.000	1 024240076
TV75	20.200	1 024000422

T77



- 933 6-7-8-10-11-12-13-14-17-19 mm

1,4 kg

T77	Ft 84.350	1 024240077
TV77	9.520	1 024000474

T79



- 80 8x9-10x11-12x13-14x15-16x17-18x19 mm

1,3 kg

T79	Ft 111.500	1 024240079
TV79	9.520	1 024000490

T80

29



- 920A 10-11-12-13-14
15-16-17-18-19
20-21-22-23-24
26-27-30-32 mm
- 920ME 5-6-8-10-12 mm
- 920/21 125 mm
- 920/22 255 mm
- 920/25
- 920/42 305 mm
- 920/55

4,1 kg

12"



	Ft	1	2
T80	125.500	1	024240080
TV80	12.800	1	024000403

T81

29



- 920B 10-11-12-13-14
15-16-17-18-19
20-21-22-23-24
26-27-30-32 mm
- 920ME 5-6-8-10-12 mm
- 920/21 125 mm
- 920/22 255 mm
- 920/25
- 920/42 305 mm
- 920/55

4,1 kg

12"



	Ft	1	2
T81	125.500	1	024240081
TV80	12.800	1	024000403

T82

29



- 920A 10-11-12-13-14
15-16-17-18-19
20-21-22-23-24
26-27-30-32 mm
- 920ME 5-6-8-10-12 mm
- 920AN/125 125 mm
- 920AN/250 250 mm
- 920/25
- 920/42 305 mm
- 920/55

4,1 kg

12"



	Ft	1	2
T82	130.800	1	024240082
TV80	12.800	1	024000403

T83

24



- 920A 10-11-12-13-14
15-16-17-18-19
20-21-22-23-24
26-27-30-32 mm
- 920/21 125 mm
- 920/22 255 mm
- 920/25
- 920/42 305 mm
- 920/55

3,6 kg

12"



	Ft	1	2
T83	101.800	1	024240083
TV83	12.800	1	024000402

T85

81



- 861LP 0,5x3 - 0,6x4,5 - 0,8x5,5 - 1x5,5 - 1,2x6,5 - 1,2x8 - 1,6x8 mm
- 861PE 2 - 2,5 - 3 - 4 - 5 - 6 - 8 - 10 mm
- ⊕ 861PH PH0 - PH1 - PH2 - PH3
- ⊕ 861PZ PZ1 - PZ2 - PZ3
- ⊕ 861TX T6-T7-T8-T9-T10-T15-T20-T25-T27-T30-T40
- ⊕ 861RTX T9-T10-T15-T20-T25-T27-T30-T40
- ⊕ 861TRW 1-2-3-4-5-6 mm
- ⊕ 861TQS 0-1-2-3-4-5-6-8-10 mm
- ⊕ 861SP 4-6-8-10-12 mm
- 851SR 230 mm
- 900 4-4,5-5-5,5-6-7-8-9
10-11-12-13-14 mm
- 900/21 150 mm
- 900/25 41 mm
- 900BG/30 176 mm
- 900/42 115 mm
- 900/55 125 mm
- 194 1/4x5/16

1,0 kg

14"



	Ft	1	2
T85	126.200	1	024240085
TV85	12.800	1	024000747

T91

25



- 900 4-4,5-5-5,5-6
7-8-9-10-11
12-13-14 mm
- 900ME 2,5-3-4-5-6-8 mm
- 900/20 50 mm
- 900/21 150 mm
- 900/25
- 900BG/30
- 900/42 115 mm
- 900/55

560 g

14"



	Ft	1	2
T91	71.450	1	024240091
TV90	9.520	1	024000447

T92

22



- 910A 6-7-8-9-10-11-12-13
14-15-16-17-18-19
20-21-22 mm
- 910/21 125 mm
- 910/22 250 mm
- 910/25
- 910/42 210 mm
- 910/55

1,5 kg

38"



	Ft	1	2
T92	89.500	1	024240092
TV92	9.520	1	024000458

T99

16



- 920INOX-A 10-12-13-14-15-16-17
18-19-21-22-24-27
30-32 mm

● 920/55INOX



2,7 kg

12"



	Ft	1	2
T99	361.200	1	024240099
TV99	9.520	1	024249908

T100

16



- 920A 10-12-13-14-15
16-17-18-19-21
22-24 mm
- 920/21 125 mm
- 920/25
- 920/42 305 mm
- 920/55

2,1 kg

12"



	Ft	1	2
T100	76.250	1	024240100
TV100	9.520	1	024000495

T101

16



- 920B 10-12-13-14-15
16-17-18-19-21
22-24 mm
- 920/21 125 mm
- 920/25
- 920/42 305 mm
- 920/55

2,1 kg

12"



	Ft	1	2
T101	76.250	1	024240101
TV100	9.520	1	024000495

T102

16



- 920AS 3/8-7/16-1/2
9/16-5/8-11/16
3/4-13/16-7/8
15/16-1-1.1/16
- 920/21 125 mm
- 920/25
- 920/42 305 mm
- 920/55

2,1 kg

12"



	Ft	1	2
T102	80.900	1	024240102
TV100	9.520	1	024000495

T103



- 900L 6-7-8-9-10-11-12 mm
- 920AL 13-14-16-17-18-19-21-22-24-27 mm

1,1 kg

14" 12"



	Ft		
T103	77.000	1	024240103
TV103	9.520	1	024000748

T105



- 928A 22-24-27-30-32-34-36-38-41-46-50 mm

4,9 kg

34"



	Ft		
T105	76.350	1	024240105
TV105	9.660	1	024000484

T106



- 928/21 200 mm
- 928/22 380 mm
- 928/42 450 mm
- 928/55

4,5 kg

34"



	Ft		
T106	121.100	1	024240106
TV106	9.660	1	024000485

T111



- 720 10-13-15-17-18-19-21-22-24-27-30-32 mm
- 720LC 17-19-21 mm
- 720/21 125 mm

2,7 kg

12"



	Ft		
T111	54.950	1	024240111
TV111	9.020	1	024000476

T112



- 861TX ● 1/4-T6+T15
- 866TX ● 5/16-T20+T55
- 895/1 ○ 1/4x□1/4
- 895/6 ○ 5/16x□1/2
- 900FTX □ 1/4-E4+E10
- 920FTX □ 1/2-E12+E24
- 920TX □ 1/2-T55L-T60-T70L

1,3 kg

14" 12"



	Ft		
T112	86.900	1	024240112
TV112	9.520	1	024000480

T113



- 920PE 5L-6L-7L-8L-10L
- 920TX T40L-T45L T55L-T70L
- 920XZN M6L-M8L-M12L

1,5 kg

12"



	Ft		
T113	68.300	1	024240113
TV113	9.520	1	024000489

T121



666N/20 40 - 200 Nm

1,4 kg

12"



	Ft		
T121	94.050	1	024240121
TV121	9.940	1	024000767

T123



- 1082G 160 mm
- 1150G 180 mm
- 1166G 160 mm

550 g



	Ft		
T123	28.250	1	024240123
TV135	9.520	1	024000762

T124



- 1082GBM 160 mm
- 1150GBM 180 mm
- 1166GBM 160 mm

640 g



	Ft		
T124	36.600	1	024240124
TV135	9.520	1	024000762

T135



- 1082MQ 160 mm
- 1150MQ 180 mm
- 1166MQ 160 mm

△ 1000 V

750 g



	Ft		
T135	58.150	1	024240135
TV135	9.520	1	024000762

T136



- 1048MQ 250 mm
- 1777MQ/U

△ 1000 V

700 g



	Ft		
T136	42.200	1	024240136
TV136	9.520	1	024000438

T137



- 1084BM 160 mm
- 1150BM 180 mm
- 1166BM 160 mm

750 g



	Ft		
T137	39.100	1	024240137
TV130	9.520	1	024000451

T138



- 1084 160 mm
- 1150 180 mm
- 1166 160 mm

650 g



	Ft	Hand	Computer
T138	31.400	1	024240138
TV130	9.520	1	024000451

T140



- 1032 140x0,9 - 180 mm
- 1034 170 mm
- 1036 140x1,3 - 175 mm
- 1038 175 mm
- 1084 160 mm
- 1128BM

1,1 kg



	Ft	Hand	Computer
T140	88.300	1	024240140
TV140	12.800	1	024000405

T144



- 1048N 250 mm
- 1052 240 mm
- 1112 250 mm
- 1150 180 mm

1,8 kg



	Ft	Hand	Computer
T144	49.900	1	024240144
TV143	12.800	1	024000409

T145



- 1032 180 mm
- 1034 170 mm
- 1036 175 mm
- 1038 175 mm

640 g



	Ft	Hand	Computer
T145	47.200	1	024240145
TV145	9.520	1	024000448

T146



- 1032 140x0,9 mm
- 1032 225 mm
- 1036 140x1,3 mm
- 1036 225 mm

700 g



	Ft	Hand	Computer
T146	49.600	1	024240146
TV146	9.520	1	024000449

T151



- 1047 240 mm
- 1057A 240 mm

1,3 kg



	Ft	Hand	Computer
T151	41.900	1	024240151
TV150	9.520	1	024000462

T153



- 1048N 250 mm
- 1052 240 mm

1,1 kg



	Ft	Hand	Computer
T153	27.450	1	024240153
TV150	9.520	1	024000462

T156



- 1082 160 mm
- 1150 180 mm
- 1048N 250 mm

1 kg



	Ft	Hand	Computer
T156	34.400	1	024240156
TV148	9.520	1	024000500

T157



- 1082BM 160 mm
- 1150BM 180 mm
- 1048BM 250 mm

1,1 kg



	Ft	Hand	Computer
T157	45.250	1	024240157
TV148	9.520	1	024000500

T160



- 1290 3x75
- 3x100
- 4x100
- 4x150
- 5,5x100
- 5,5x150
- 6,5x150
- 8x150
- 10x200 mm
- 1290N 4x30
- 6,5x30 mm

1,3 kg



	Ft	Hand	Computer
T160	43.350	1	024240160
TV160	12.800	1	024000706

T161



- 1292 PH0x60
- PH0x100
- PH1x80
- PH1x120
- PH2x100
- PH2x150
- PH3x150 mm
- 1292N PH1x30
- PH2x30 mm

1 kg



	Ft	Hand	Computer
T161	33.850	1	024240161
TV161	12.800	1	024000707

T164



- 952 8-10-13-17-19mm
- 959 16mm (5/8") - 20,8mm (13/16")
- 1260 3x75-4x100-5,5x100-6,5x150-10x200mm
- 1262 PH0x60-PH1x80-PH2x100-PH3x150mm

5 kg



	Ft	Hand	Computer
T164	173.100	1	024240164
TV61	19.700	1	024000721

T167



- 1260 3x75
3x100
4x100
4x150
5.5x100
5.5x150
6.5x150
8x150
10x200 mm
- 1260N 4x30
6.5x30 mm

1,3 kg



T167	Ft 34.600	1	024240167
TV160	Ft 12.800	1	024000706

T168



- 1262 PH0x60
PH0x100
PH1x80
PH1x120
PH2x100
PH2x150
PH3x150 mm
- 1262N PH1x30
PH2x30 mm

1 kg



T168	Ft 27.950	1	024240168
TV161	Ft 12.800	1	024000707

T170



- 1290 2.5x50
3x75
3.5x100
4x125
5.5x100
5.5x150
6.5x150 mm

450 g



T170	Ft 23.200	1	024240170
TV170	Ft 9.520	1	024000741

T171



- 1290 8x150
8x200
10x200 mm
- 1290N 4x30
6.5x30 mm

750 g



T171	Ft 25.750	1	024240171
TV171	Ft 9.520	1	024000742

T172



- 1292 PH0x60
PH0x100
PH1x80
PH1x120
PH2x100
PH2x150 mm

450 g



T172	Ft 21.300	1	024240172
TV172	Ft 9.520	1	024000743

T173



- 1292 PH3x150
PH4x200 mm
- 1292N PH1x30
PH2x30 mm

560 g



T173	Ft 20.950	1	024240173
TV173	Ft 9.520	1	024000744

T175



- 1297TX T6-T7-T8-T9
T10-T15-T20

410 g



T175	Ft 33.850	1	024240175
TV175	Ft 9.520	1	024000760

T176



- 1297TX T25-T27-T30
T40-T45

640 g



T176	Ft 30.650	1	024240176
TV176	Ft 9.520	1	024000761

T177



- 1298RTX T9-T10-T15
T20-T25-T27
T30-T40

680 g



T177	Ft 47.250	1	024240177
TV177	Ft 9.520	1	024000759

T180



- 1290 3x75
4x100
5.5x150
6.5x150 mm
- 1292 PH0x60
PH1x80
PH2x100 mm

480 g



T180	Ft 24.150	1	024240180
TV180	Ft 9.520	1	024000701

T183



- 1292L PH1x400-PH2x400 mm
- 1294L 3x300-4x400-5x400 mm

580 g



T183	Ft 32.850	1	024240183
TV183	Ft 9.940	1	024000497

T198



- 1260 3x75
4x100
5.5x150
6.5x150 mm
- 1269PZ P20 - P21 - P22

490 g



T198	Ft 20.650	1	024240198
TV180	Ft 9.520	1	024000701

T199



- 1260 2,5x50
3x75
3,5x100
4x125
5,5x100
5,5x150
6,5x150 mm

490 g



	Ft		
T199	18.500	1	024240199
TV170	9.520	1	024000741

T201



- 1260 8x200
10x150
10x200 mm
- 1260N 4x30
6,5x30 mm

680 g



	Ft		
T201	20.350	1	024240201
TV171	9.520	1	024000742

T202



- ⊕ 1262 PH0x60
PH0x100
PH1x80
PH1x120
PH2x100
PH2x150 mm

490 g



	Ft		
T202	17.350	1	024240202
TV172	9.520	1	024000743

T204



- ⊕ 1262 PH3x150
PH4x200 mm
- ⊕ 1262N PH1x30
PH2x30 mm

610 g



	Ft		
T204	17.000	1	024240204
TV173	9.520	1	024000744

T205



- ⊖ 1267TX T6-T7-T8-T9
T10-T15-T20

460 g



	Ft		
T205	25.150	1	024240205
TV175	9.520	1	024000760

T206



- ⊖ 1267TX T25-T27-T30
T40-T45

710 g



	Ft		
T206	25.100	1	024240206
TV176	9.520	1	024000761

T207



- ⊖ 1268RTX T9-T10-T15
T20-T25-T27-T30

760 g



	Ft		
T207	30.750	1	024240207
TV207	9.520	1	024000758

T208



- 1260 3x75
4x100
5,5x150
6,5x150 mm
- ⊕ 1262 PH0x60
PH1x80
PH2x100 mm

530 g



	Ft		
T208	19.650	1	024240208
TV180	9.520	1	024000701

T209



- ⊕ 1262L PH1x400-PH2x400 mm
- 1264L 3x300-4x400-5x400 mm

580 g



	Ft		
T209	25.050	1	024240209
TV183	9.940	1	024000497

T211



- 1201E 2,5x50
3x75
3,5x100
4x125
5,5x100
5,5x150
6,5x150 mm

490 g



	Ft		
T211	14.400	1	024240211
TV170	9.520	1	024000741

T213



- ⊕ 1202E PH0x60
PH1x80
PH1x120
PH2x100
PH2x150
PH3x150 mm

490 g



	Ft		
T213	15.200	1	024240213
TV212	9.520	1	024000440

T216



- ⊖ 1207E/TX T6-T7-T8-T9
T10-T15-T20

410 g



	Ft		
T216	15.200	1	024240216
TV175	9.520	1	024000760

T221



- 1201E 3x75
4x100
5.5x150
6.5x150 mm
- ⊕ 1202E PH0x60
PH1x80
PH2x100 mm

530 g



T221	Ft 15.050	1	024240221
TV180	9.520	1	024000701

T226

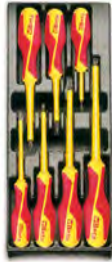

- 1274MQ 3x100
4x100
5.5x125
6.5x150 mm
- ⊕ 1272MQ PH0x60
PH1x80
PH2x100 mm

1000 V

460 g



T226	Ft 31.200	1	024240226
TV180	9.520	1	024000701

T227



- 944BX 5-6-7-8-10-13 mm

490 g



T227	Ft 52.400	1	024240227
TV227	9.520	1	024000705

T228



- 1290INOX 3x75 - 4x100 -
5.5x150 - 6.5x150 mm
- ⊕ 1292INOX PH0x60 - PH1x80 -
PH2x100 mm



480 g



T228	Ft 27.650	1	024240228
TV180	9.520	1	024000701

T231



- 1370 400 g
- 1390 Ø 35 mm
- ▲ 1719BMA/T 200 mm
- 1719BMA/P 200 mm
- 1719BMA/M 200 mm

1,7 kg



T231	Ft 43.750	1	024240231
TV230	12.800	1	024000411

T233



- 35 100-200 mm
- 1370F 32 mm
- 1390 Ø 35 mm

1,3 kg



T233	Ft 40.750	1	024240233
TV232	9.520	1	024000452

T234



- 35 100-200 mm
- 1370 300 g
- 1390 Ø 35 mm

1,3 kg



T234	Ft 36.100	1	024240234
TV232	9.520	1	024000452

T236



- 1719BMA/Q 200 mm
- ▲ 1719BMA/T 200 mm
- 1719BMA/P 200 mm
- 1719BMA/M 200 mm
- 1719BMA/R 200 mm

870 g



T236	Ft 35.650	1	024240236
TV235	9.520	1	024000453

T239



- 31BM Ø 2-3-4-5-6-8 mm
- 32 Ø 4 mm

850 g



T239	Ft 48.000	1	024240239
TV239	9.520	1	024000439

T241



- 1500N/1
- 1500N/3
- 1516/1

4,2 kg



T241	Ft 115.500	1	024240241
TV241	12.800	1	024000414

T250

Automotive



- 34 150 mm
- 83/S3 11x13-14x17
19x22 mm
- 1458 175 mm
- 1491
- 1603
- 1708/13 0,05+1 mm

1430 g



T250	Ft 100.400	1	024240250
TV250	12.800	1	024000408

T256

Automotive



- 956E 16 mm (5/8) - 20,8 mm (13/16)
- 956L 16 mm (5/8) - 20,8 mm (13/16)
- 959 16 mm (5/8) - 20,8 mm (13/16)
- 1164 200 mm
- 1708/20 0,05+1 mm

3,2 kg



T256	Ft 163.000	1	024240256
TV255	16.450	1	024000467

T259



- 96BP 2,5-3-4-5
6-8-10 mm
- 96N 12 mm
- 860MIX/A31
-
- +
- +
- +
- 895/1

2,1 kg



	Ft		
T259	57.550	1	024240259
TV263	9.520	1	024000492

T264



- 1491 Ø 65+110 mm
- 1494 ■ 10 mm
- 1494E ○ 8-9-10-11-12-14-17 mm
- 1494Q ○ 8-9,5-12-13 mm
- △ 1494T △ 9,5
- 1494XZN ○ 16
- 1496C ■ 8x ■ 10 mm

2,1 kg



	Ft		
T264	81.700	1	024240264
TV264	9.520	1	024000466

T270



- 430 M3 - 4 - 5 - 6 - 7 - 8 - 9
10 - 12 - 14 - 16 - 18 - 20
- 433 M6x0,75 - M8x1 - M10x1,25
M12x1,5 - M14x1,5
M16x1,5 - M18x1,5
- 440 M3 - 4 - 5 - 6 - 7 - 8 - 9
- 440A M10 - 12 - 14 - 16 - 18 - 20
- 441 M6x0,75 - M8x1,0
- 441A M10x1,25 - M12x1,5
M14x1,5 - M16x1,5
M18x1,5

4,3 kg



	Ft		
T270	181.200	1	024240270
TV270	12.800	1	024000481

T273



- 435/1,5 M3+M12
- 435/3 M5+M21
- 436/1 □ 2,0+5,0 mm (M3+M8)
- 436/2 □ 4,6+8 mm (M5+M12)
- 444/1 Ø 25,4 mm
- 444/2 Ø 38,1 mm
- 1707 W 62+4x1"

2,1 kg



	Ft		
T273	91.900	1	024240273
TV272	12.800	1	024000482

T281



- 1741B 250 mm
- 1741RV2,9K 2,9x6 mm (100)
- 1741RV3,2K 3,2x8 mm (100)
- 1741RV3,8K 3,8x10 mm (100)
- 1741RV4K 4x12 mm (100)

1,4 kg



	Ft		
T281	30.750	1	024240281
TV280	9.520	1	024000478

T285



- 1112 250 mm
- 1128BM -
- 1726 400 mm
- 1728BM (5 pezzi)
- 1753 200 cc

1,5 kg



	Ft		
T285	45.300	1	024240285
TV285	16.450	1	024000487

T284



- 1128BMX
- 1130BMX
- 1719BMA...Q 200 mm
- ▲ 1719BMA...T 200 mm
- 1719BMA...P 200 mm
- ▶ 1719BMA...M 200 mm
- 1719BMA...R 200 mm
- 1726BM 400 mm
- 1728BM
- 1771BM 170 mm
- 1778V18 185 mm

3,3 kg



	Ft		
T284	97.150	1	024240284
TV286	20.200	1	024249904

T289



- 1692 5 m
- 1725CR -
- 1755 30 cc
- 1771 -

500 g



	Ft		
T289	18.250	1	024240289
TV290	9.520	1	024000455

T291



- 1479RB/1
- 1479RB/2
- 1479RB/3

600 g



	Ft		
T291	38.450	1	024240291
TV291	9.520	1	024000472



T297



1651DGTB
1682
1691BM

490 g



	Ft		
T297	57.400	1	024240297
TV296	9.520	1	024000749

VP1-VP2

Hőformált műanyag tálcák az összes RSC22, RSC23, RSC23C szerszámládához

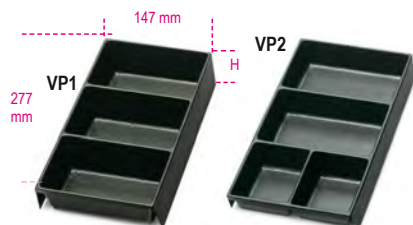

	H mm	Ft		
VP1	50	5.190	1	088880351
VP2	35	5.190	1	088880352

VP3-VP4

Hőformált műanyag tálcák az összes fiókos, típusú szerszámtárolóhoz

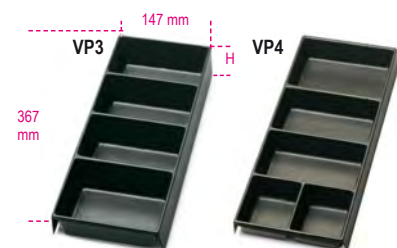

	H mm	Ft		
VP3	50	5.460	1	088880353
VP4	35	5.460	1	088880354

VP5

Hőformált műanyag tálcák



	Ft		
VP5	6.320	1	088880355



VP6

Hőformált műanyag tálcák

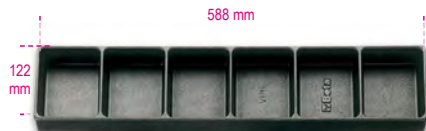

	Ft		
VP6	6.300	1	088880359

VP-3SC

Hőformált műanyag tálcák kis tárgyak elhelyezésére a C38 szerszámkocsihoz +C04TSS-7

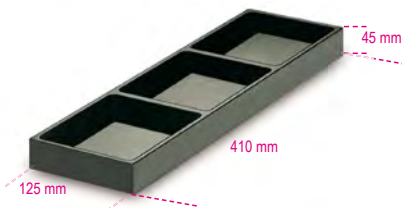

	H mm	Ft		
VP-3SC	45	6.830	1	088880356

VP-LS

Hőformált műanyag tálcák kis tárgyak elhelyezésére a C38 szerszámkocsihoz +C04TSS-7



	H mm	Ft		
VP-LS	45	4.640	1	088880357

VP-LD

Hőformált műanyag tálcák kis tárgyak elhelyezésére a C38 szerszámkocsihoz



	H mm	Ft		
VP-LD	45	4.380	1	088880358

8889P1

párhuzamos fiókelválasztó a RSC22, RSC23, RSC23C és C27S fiókjaihoz fiókméret 588x277 mm

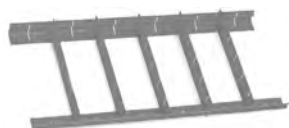

	h	Ft		
8889P1/5	50 mm	13.400	1	088890005
8889P1/7	70 mm	13.750	1	088890007

8889C1

keresztirányú fiókelválasztó a RSC22, RSC23, RSC23C és C27S fiókjaihoz fiókméret 588x277 mm



	h	Ft		
8889C1/5	50 mm	17.950	1	088890015
8889C1/7	70 mm	18.300	1	088890017

8889P2

párhuzamos fiókelválasztó szabványos, 588x367 mm fiókhoz



	h	Ft		
8889P2/7	70 mm	16.000	1	088890107

8889C2

keresztirányú fiókelválasztó szabványos, 588x367 mm fiókhoz



	h	Ft		
8889C2	70 mm	20.550	1	088890117

8889P3

fiókméret 882x367 mm



	h	Ft		
8889P3	70 mm	25.600	1	088890207

8889C3

882x367 mm fiókhoz



	h	Ft		
8889C3	70 mm	31.300	1	088890217

8889P4

párhuzamos fiókelválasztó a C41 húzható szerszámkocsihoz
fiókméret 418x205 mm



	h	Ft		
8889P4	70 mm	10.700	1	088890307

8889I4

keresztirányú fiókelválasztó a C41 húzható szerszámkocsihoz
fiókméret 418x205 mm



	h	Ft		
8889C4	70 mm	13.000	1	088890317

8889PS

párhuzamos fiókelválasztó a C38 - C45PRO M4/M5/M7/M8 fiókjaihoz
bal oldali fiók, méret 570x410 mm



	h	Ft		
8889PS/7	70 mm	19.150	1	088890407

8889CS

keresztirányú fiókelválasztó a C38 - C45PRO M4/M5/M7/M8 fiókjaihoz
bal oldali fiók, méret 570x410 mm

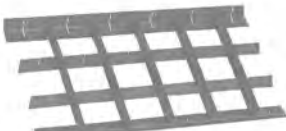

	h	Ft		
8889CS/7	70 mm	23.300	1	088890417

8889PD

párhuzamos fiókelválasztó a C38 fiókjaihoz
jobb oldali fiók, méret 313x410 mm



	h	Ft		
8889PD/7	70 mm	10.200	1	088890427

8889CD

keresztirányú fiókelválasztó a C38 fiókjaihoz
jobb oldali fiók, méret 313x410 mm



	h	Ft		
8889CD/7	70 mm	14.050	1	088890437

8889C6

keresztirányú fiókelválasztó a C35 fiókjaihoz
fiókméret 600x447 mm



	h	Ft		
8889C6/7,5	75 mm	13.050	1	088890475
8889C6/10	100 mm	12.750	1	088890480
8889C6/15	150 mm	17.100	1	088890485
8889C6/20	200 mm	26.700	1	088890490

SB

Dugókulcs tartó sínek



	L	Ft		
SB1	210 mm	1.480	10	088880201
SB2	280	1.640	10	088880202
SB3	360	1.750	10	088880203

PM 1/2-Q5

mágneses dugókulcs tartó

12"



	Ft		
PM 1/2-Q5	16.900	1	088880233

MB

Dugókulcs-csipegetők



		Ft		
MB0	1/4	400	50	088880210
MB1	3/8	400	50	088880211
MB2	1/2	400	50	088880212

KIT/GPS

40 mm akasztó tiplivel és csavarral

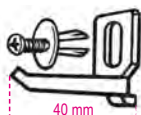

	Ft		
KIT/GPS	760	50	088880119

VE1

tiplis csavarral

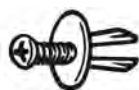

	Ft		
VE1	270	20	088880120

GM

rugós szerszámtartó VE1 tiplis csavarral



Ø	Ft		
6,5 mm	2.110	5	088880250
9,5	2.180	5	088880251
13	2.190	5	088880252
16	3.170	5	088880253
19	3.230	5	088880254
25	2.980	5	088880255

S55/8

villáskulcstartó

• 3 darab VE1 tiplis csavarral szállítva

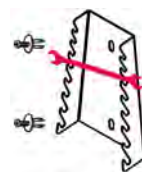

	Ft		
S55/8	8.730	1	088880420

S55/8
55/S8
55AS/8
55MP/S8

S55/12

villáskulcstartó

• 3 darab VE1 tiplis csavarral szállítva

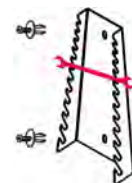

	Ft		
S55/12	11.500	1	088880421

S55/12
55/S12
55/S12X
55AS/12
55MP/S12

ST2P

fogó tartó

• 3 darab VE1 tiplis csavarral szállítva

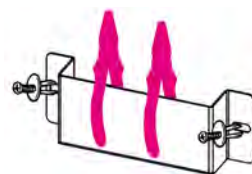

	Ft		
ST2P	9.840	1	088880422

TSPP

műanyag szerszámtartó

• 3 darab VE1 tiplis csavarral szállítva



	Ft		
TSPP	2.180	1	088880402

S952/10

T-kulcs tartó

• 3 darab VE1 tiplis csavarral szállítva

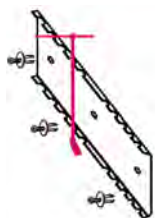

S952/10 Ft 10.800 1 088880423

S1719BM

reszelőtartó

• 3 darab VE1 tiplis csavarral szállítva



S1719BM Ft 6.320 1 088880404

1719BMA: Q-T-P-M-R
1719BMD: Q-T-P-M-R
1719BMX: Q-T-P-M-R

SGN

csavarhúzó tartó

• 3 darab VE1 tiplis csavarral szállítva



SGN Ft 3.160 1 088880405

1290N-1292N-1299N/PZ
1260N-1262N-1269N/PZ
1201EN-1202EN-1209EN/PZ

CB/2

hőformált tálca 1/2"-os dugókulcshoz és tartozékokhoz, üres

• csak a C54S szerszámszekrényhez

12"



CB/2 Ft 9.850 1 088880411

920A/920B
10+24+26-27
28-30-32 mm
920/21-920/22-920/25-
920/42-920/55

S42/17

csillag-villáskulcs tartó

• 3 darab VE1 tiplis csavarral szállítva



S42/17 Ft 11.750 1 088880428

42/S17
42MP/S17
42/S17X
42AS/17
142/S17

S951/6

T-szárú imbuszkulcs tartó

• 3 darab VE1 tiplis csavarral szállítva

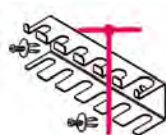

S951/6 Ft 7.260 1 088880429
951/S6
951AS/S6X
951TX/S6

SPG11 - S1203/8

csavarhúzó tartó

• 3 darab VE1 tiplis csavarral szállítva

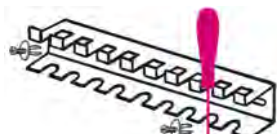

SPG11 Ft 7.430 1 088880910
n.8 Ø = 7 mm
n.2 Ø = 10 mm
n.1 Ø = 12 mm

S1203/8 8.180 1 088880430
1203E/S8
1263/D8
1293/S8

S96T/8

imbuszkulcs tartó

• 3 darab VE1 tiplis csavarral szállítva



S96T/8 Ft 7.070 1 088880431
96T/AS8
96T/S8
97TTX/S8

96T/SPV

imbuszkulcs tartó

• 3 darab VE1 tiplis csavarral szállítva

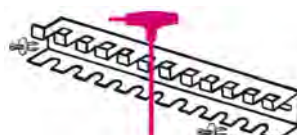

96T/SPV Ft 11.350 1 000960958
96T/S11
97TTX/S11

Beta



Beta CHEMICALS

A biztonságos rögzítéshez nem mindig elég meghúzni a csavart. A felületek megtisztítása, kenése és tömítése is szükségessé válhat.

A Beta vegyiárak között megtalálhatók a mechanikus részek karbantartását, tisztítását és kenését szolgáló anaerob menettömítők, cianoakrilát ragasztók és aeroszolos palackok.

Anaerob termékek

Az anaerob termékek kitöltik a fémszerkezetek apró felszíni egyenetlenségeit, s ezzel lehetővé teszik a mechanikai feszültség teljes érintkező felületen való eloszlását. Oxigén hiányában megkeményednek és a víz, gáz, olaj, üzemanyag és ipari folyadékok ellen tökéletes tömítést biztosítanak a kötések és menetek számára.

A különböző igények kielégítésére három ellenállási osztályban (alacsony, közepes, nagy) és többféle kiszérlésben kapható.

Szilikon tömítő

- Tartós, rugalmas tömítés.
- Tömítőgyűrű helyett.
- Az adagolóval könnyen (egy rétegben), pontosan és egyenletesen vihető fel a termék.
- A légköri nedvességgel reakcióba lépve polimerizálódva rugalmas és tartós tömítést hoz létre.

Pillanatragasztó

Etil-cianoakrilát alapú pillanatragasztó strukturális kötésekhöz, többféle anyaghoz.

Aeroszokok

Szórópalackos termékek széles skálája kötések oldásához, zsírzáshoz, kenéshez, tisztításhoz, galvanizáláshoz és fertőtlenítéshez.

Folyadékok

Mechanikus alkatrészekon és fém tárgyakon kialakult lerakódások és rozsda eltávolítására. Ideális az 1895 típusú ultrahangos mosótállal való együttes használatra.

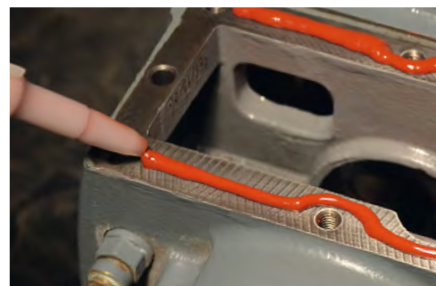

FIGYELEM!

A Beta Chemicals termékei a következő országokban forgalmazhatók: Ausztria, Andorra, Belgium, Cseh Köztársaság, Dominikai Köztársaság, Egyesült Arab Emírségek, Egyesült Királyság, Franciaország, Hollandia, Írország, Kínai Népköztársaság, Lengyelország, Magyarország, Monacói Hercegség, Olaszország, Portugália, Réunion, San Marino, Spanyolország, Svájc, Szlovákia, Szlovénia, Új-Kaledónia.

9803H

Menetragasztó – nagy szilárdságú

Tartós rögzítés, azokhoz az alkatrészekhez ideális, amelyek nem kell szétszerelni, vagy passzívált fémfelületekhez, mint a réz, alumínium, rozsdamentes acél, stb.
Nem teszi lehetővé a kéziszerszámokkal történő szétszerelést.



Hőmérséklettartomány (°C)	-50/+150
Maximális hézatképződés (mm)	0,25
Száradási/kötési idő (percek)	10/15
Gyakorlati kötési idő (óra)	3-6
Viszkózitás (mPa.s) 25°C	800/1200
Oldónyomaték ISO-10964	35-45 Nm
Uralkodó nyomaték ISO-10964	30-40 Nm

ml		Ft		
20	palack	2.900	12	098030002
50	palack	4.490	4	098030005
250	palack	11.600	4	098030025
20	palack		12	098032002
50	palack		4	098032005
250	palack		4	098032025

9802M

Menetragasztó – közepes szilárdságú

A rendszeres karbantartásnak kitett alkatrészekhez, csapágyakhoz és perselyekhez ideális.
Lehetővé teszi a kéziszerszámokkal történő szétszerelést.



Hőmérséklettartomány (°C)	-50/+150
Maximális hézatképződés (mm)	0,15
Száradási/kötési idő (percek)	10/15
Gyakorlati kötési idő (óra)	3-6
Viszkózitás (mPa.s) 25°C	500/800
Oldónyomaték ISO-10964	22-30 Nm
Uralkodó nyomaték ISO-10964	20-25 Nm

ml		Ft		
20	palack	2.900	12	098020002
50	palack	4.490	4	098020005
250	palack	11.600	4	098020025
20	palack		12	098022002
50	palack		4	098022005
250	palack		4	098022025

9801L

Menetragasztó – alacsony szilárdságú

Ideális szabályozócsavarok és az olyan könnyűfém ötvözetek rögzítéséhez, amelyek könnyen megsérülhetnek a szétszerelés során.
Könnyebb szétszerelés.



Hőmérséklettartomány (°C)	-50/+150
Maximális hézatképződés (mm)	0,10
Száradási/kötési idő (percek)	10/15
Gyakorlati kötési idő (óra)	3-6
Viszkózitás (mPa.s) 25°C	500/800
Oldónyomaték ISO-10964	6-10 Nm
Uralkodó nyomaték ISO-10964	4-8 Nm

ml		Ft		
20	palack	2.900	12	098010002
50	palack	4.490	4	098010005
250	palack	11.600	4	098010025
20	palack		12	098012002
50	palack		4	098012005
250	palack		4	098012025

9813H

Menetítő – nagy ellenállású

Tartós rögzítés, olyan csecssavarak tömítéséhez ideális, amelyeket nem kell szétszerelni, vagy passzívált fémfelületekhez, mint a réz, alumínium, rozsdamentes acél, stb.
Nem teszi lehetővé a kéziszerszámokkal történő szétszerelést.



Hőmérséklettartomány (°C)	-50/+200
Maximális hézatképződés (mm)	0,15
Száradási/kötési idő (percek)	10/15
Gyakorlati kötési idő (óra)	3-6
Viszkózitás (mPa.s) 25°C	40.000/80.000
Oldónyomaték ISO-10964	35-45 Nm
Uralkodó nyomaték ISO-10964	25-35 Nm

ml		Ft		
20	palack	2.820	12	098130002
50	összecsukható palack	4.960	6	098130305
50	tubus	4.740	4	098130505
250	tubus	11.400	4	098130525
20	palack		12	098132002
50	összecsukható palack		6	098132305
50	tubus		4	098132505
250	tubus		4	098132525

9812M

Menetítő – közepes ellenállású

A rendszeres karbantartásnak kitett alkatrészekhez ideális.
Lehetővé teszi a kéziszerszámokkal történő szétszerelést.



Hőmérséklettartomány (°C)	-50/+150
Maximális hézatképződés (mm)	0,35
Száradási/kötési idő (percek)	12/18
Gyakorlati kötési idő (óra)	3-6
Viszkózitás (mPa.s) 25°C	20.000/40.000
Oldónyomaték ISO-10964	27-35 Nm
Uralkodó nyomaték ISO-10964	20-30 Nm

ml		Ft		
20	palack	2.820	12	098120002
50	összecsukható palack	4.960	6	098120305
50	tubus	4.740	4	098120505
250	tubus	11.400	4	098120525
20	palack		12	098122002
50	összecsukható palack		6	098122305
50	tubus		4	098122505
250	tubus		4	098122525

9811L

Menetítő – alacsony ellenállású

Kis csatlakozókhöz vagy finom menetekhez ideális.
Könnyebb szétszerelés.



Hőmérséklettartomány (°C)	-50/+150
Maximális hézatképződés (mm)	0,20
Száradási/kötési idő (percek)	10/15
Gyakorlati kötési idő (óra)	3-6
Viszkózitás (mPa.s) 25°C	10.000/20.000
Oldónyomaték ISO-10964	6-10 Nm
Uralkodó nyomaték ISO-10964	4-8 Nm

ml		Ft		
20	palack	2.820	12	098110002
50	összecsukható palack	4.960	6	098110305
50	tubus	4.740	4	098110505
250	tubus	11.400	4	098110525
20	palack		12	098112002
50	összecsukható palack		6	098112305
50	tubus		4	098112505
250	tubus		4	098112525

9823H

Folyékony tömítőanyag – nagy ellenállású

Felületek tartós tömítéséhez ideális. Tartós alkalmazás csapágyfészek vagy kopott alkatrészek helyreállításához is ajánlott.
Nem teszi lehetővé a kéziszerszámokkal történő szétszerelést.



Hőmérséklettartomány (°C)	-50/+150
Maximális hézatképződés (mm)	0,35
Száradási/kötési idő (percek)	10/16
Gyakorlati kötési idő (óra)	3-6
Viszkozitás (mPa.s) 25°C	100.000/200.000
Oldónyomaték ISO-10964	35-45 Nm
Uralkodó nyomaték ISO-10964	20-30 Nm

ml		Ft		
20	palack	2.820	12	098230002
50	összecsukható palack	4.960	6	098230305
50	tubus	4.740	4	098230505
250	tubus	11.400	4	098230525
20	palack		12	098232002
50	összecsukható palack		6	098232305
50	tubus		4	098232505
250	tubus		4	098232525

9822M

Folyékony tömítőanyag – közepes ellenállású

A rendszeres karbantartást igénylő alkatrészekhez ideális. Lehetővé teszi a kéziszerszámokkal történő szétszerelést.



Hőmérséklettartomány (°C)	-50/+150
Maximális hézatképződés (mm)	0,35
Száradási/kötési idő (percek)	10/15
Gyakorlati kötési idő (óra)	3-6
Viszkozitás (mPa.s) 25°C	40.000/70.000
Oldónyomaték ISO-10964	25-35 Nm
Uralkodó nyomaték ISO-10964	20-30 Nm

ml		Ft		
20	palack	2.820	12	098220002
50	összecsukható palack	4.960	6	098220305
50	tubus	4.740	4	098220505
250	tubus	11.400	4	098220525
20	palack		12	098222002
50	összecsukható palack		6	098222305
50	tubus		4	098222505
250	tubus		4	098222525

9821L

Folyékony tömítőanyag – alacsony ellenállású

A rendszeres karbantartást igénylő alkatrészek felületének tömítéséhez ideális.
Védi a meneteket a korróziótól és a korróziós bemaradásoktól.
Könnyebb szétszerelés.



Hőmérséklettartomány (°C)	-50/+150
Maximális hézatképződés (mm)	0,35
Száradási/kötési idő (percek)	20/30
Gyakorlati kötési idő (óra)	3-6
Viszkozitás (mPa.s) 25°C	60.000/90.000
Oldónyomaték ISO-10964	7-11 Nm
Uralkodó nyomaték ISO-10964	4-9 Nm

ml		Ft		
20	palack	2.820	12	098210002
50	összecsukható palack	4.960	6	098210305
50	tubus	4.740	4	098210505
250	tubus	11.400	4	098210525
20	palack		12	098212002
50	összecsukható palack		6	098212305
50	tubus		4	098212505
250	tubus		4	098212525

9833H

Rögzítőanyag – nagy ellenállású

Azokhoz az alkatrészekhez ideális, amelyeket nem kell szétszerelni.
Alkalmazható a már beszerelt eszközök rögzítéséhez, ahol nehéz a szétszerelés.
Nem teszi lehetővé a kéziszerszámokkal történő szétszerelést.



Hőmérséklettartomány (°C)	-50/+180
Maximális hézatképződés (mm)	0,15
Száradási/kötési idő (percek)	10/15
Gyakorlati kötési idő (óra)	3-6
Viszkozitás (mPa.s) 25°C	400/700
Oldónyomaték ISO-10964	35-45 Nm
Uralkodó nyomaték ISO-10964	30-40 Nm

ml		Ft		
20	palack	2.860	12	098330002
50	palack	4.470	4	098330005
250	palack	11.550	4	098330025
20	palack		12	098332002
50	palack		4	098332005
250	palack		4	098332025

9832M

Rögzítőanyag – közepes ellenállású

A rendszeres karbantartást igénylő alkatrészekhez ideális. Lehetővé teszi a kéziszerszámokkal történő szétszerelést.



Hőmérséklettartomány (°C)	-50/+180
Maximális hézatképződés (mm)	0,25
Száradási/kötési idő (percek)	12/20
Gyakorlati kötési idő (óra)	3-6
Viszkozitás (mPa.s) 25°C	2000/4000
Oldónyomaték ISO-10964	25-35 Nm
Uralkodó nyomaték ISO-10964	18-28 Nm

ml		Ft		
20	palack	2.860	12	098320002
50	palack	4.470	4	098320005
250	palack	11.550	4	098320025
20	palack		12	098322002
50	palack		4	098322005
250	palack		4	098322025

9831L

Rögzítőanyag – alacsony ellenállású

A rendszeres karbantartást igénylő kis méretű alkatrészekhez ideális.
Könnyebb szétszerelés.



Hőmérséklettartomány (°C)	-50/+150
Maximális hézatképződés (mm)	0,10
Száradási/kötési idő (percek)	10/15
Gyakorlati kötési idő (óra)	3-6
Viszkozitás (mPa.s) 25°C	500/800
Oldónyomaték ISO-10964	6-10 Nm
Uralkodó nyomaték ISO-10964	4-8 Nm

ml		Ft		
20	palack	2.860	12	098310002
50	palack	4.470	4	098310005
250	palack	11.550	4	098310025
20	palack		12	098312002
50	palack		4	098312005
250	palack		4	098312025



9841N

fekete ecetsavas szilikon tömítő, magas hőmérséklettel szembeni ellenállás, kényelmes, túlnyomásos adagoló

Akár 240 °C-ig hőálló.

Tartós, rugalmas tömítés. Tömítőgyűrű helyett.

Az adagolóval könnyen, pontosan és egyenletesen vihető fel a termék.

A légköri nedvességgel reakcióba lépve polimerizálódva rugalmas és tartós tömítést hoz létre.

Ideális olajteknők, olajpumpák, házak, sebességváltók, a motor nagy nyomásnak nem kitett részeinek, valamint magas hőmérséklettel szembeni ellenállást igénylő alkalmazások tömítésére. Nem porózus felületen, így üvegen, bevont fán, kerámián és lakkon alkalmazható. Nem alkalmas PE, PP, PC, PMMA, PTFE, puha műanyag, neoprén és bitumen felületeken. Nem festhető.



ml	Ft		
200	8.030	12	098410120
200		12	098412120

9841R

piros ecetsavas szilikon tömítő, magas hőmérséklettel szembeni ellenállás, kényelmes, túlnyomásos adagoló

Akár 300 °C-ig hőálló.

Tartós, rugalmas tömítés. Tömítőgyűrű helyett.

Az adagolóval könnyen, pontosan és egyenletesen vihető fel a termék.

A légköri nedvességgel reakcióba lépve polimerizálódva rugalmas és tartós tömítést hoz létre.

Ideális kemence- és kazánajtók, lemezek, fűtési rendszerek, kimenetek, termosztátok, szivattyúk, fűtőcsövek, a motor nagy nyomásnak nem kitett részeinek, valamint magas hőmérséklettel szembeni ellenállást igénylő alkalmazások tömítésére. Nem porózus felületen, így üvegen, bevont fán, kerámián és lakkon alkalmazható. Nem alkalmas PE, PP, PC, PMMA, PTFE, puha műanyag, neoprén és bitumen felületeken. Nem festhető.



ml	Ft		
200	7.510	12	098410020
200		12	098412020

9851

Pillanatragasztó
strukturális kötésekhöz

etil-cianoakrilát alapú

anyagok széles skálájának, mint a fém, műanyag, bőr, fa és sok egyéb, egynemű vagy egymással kombinált anyag típus ragasztására;
gyors kötés.



Hőmérséklet (°C) -55/+82
Viszkozitás (mPa.s) 25 °C 80-120

g		Ft		
5	tubus	1.580	24	098510500
20	palack	2.860	12	098510002
50	palack	5.670	10	098510005
5	tubus		24	098512500
20	palack		12	098512002
50	palack		10	098512005

9710 - LUBRIBETA universal

7-in-1 többcélú oldó-kenőanyag

1. Lazítás
 2. Kenés
 3. Tisztítás, zsírtalanítás
 4. Rozsdásodás gátlás
 5. Elektromos csatlakozók oxidáció mentesítése
 6. Vízálló
 7. Fagyálló
- Silicone-free.



ml	Ft		
400		12	097100040
400	2.490	12	097101040
400		12	097102040

9712 - Ultra Sblock

Lazító kenőanyag kiemelkedő penetrációval

Kenés, oxidáció mentesítés, vízhatlanítás.

Ideális rozsdá feloldásához az anyaktól, csavaroktól, menetekről és fogaskerekekről.



ml	Ft		
400		12	097120040
400	1.730	12	097121040
400		12	097122040

9720 - Multi Grease

Többcélú kenőzsír

Különösen hasznos a láncok, fogaskerekek és mozgó fém alkatrészek kenésére. Ellenáll a sűrűdésnek és az időjárásnak. Kiválóan tapad. Nem csepeg.



ml	Ft		
400		12	097200040
400	2.000	12	097201040
400		12	097202040

9722 - Lithium Grease

Fehér lítium zsír

Lítiumbázisú kenőzsír, titán- és cinkoxid szappanok hozzáadásával. Ideális fogaskerekek, csapágycsuklók kenéséhez. Speciálisan a tengeri alkalmazásokhoz kifejlesztve. Rendkívül ellenálló a víz, a tengeri só, az időjárás és a magas hőmérséklet (150 ° C-ig) ellen. Nem csepeg.



ml	Ft		
400		12	097220040
400	2.280	12	097221040
400		12	097222040



9724 - PTFE Grease

PTFE-bázisú zsír

Különösen alkalmas az ipari láncok és a nagy nyomás és alacsony fordulatszám melletti mechanikai mozgásokhoz. Alkalmas műanyagokra és gumira. Teljesen szintelen. Vízálló és ellenálló az oxidációval szemben.



ml	Ft	🚗	🏠
400		12	097240040
400	2.600	12	097241040
400		12	097242040

9726 - Copper Grease

Réz zsír

Alkalmas a magas hőmérsékleten működő (akár 1000 ° C) csuklók, csavarok, fogaskerekek, hajt tengelyek és egyéb fém alkatrészek kenésére. Védő, kopásgátló. Megakadályozza az oxidációt. Nem csepeg.



ml	Ft	🚗	🏠
400		12	097260040
400	3.000	12	097261040
400		12	097262040

9729 - Silic Spray

Szilikon spray

Alkalmas műanyag, gumi és fém alkatrészek kenésére. Védi a korróziótól. Alkalmazható leválasztásra, antisztatikus, vízálló. Fa, műanyag és gumi polírozására is használható. Oldószermentes.



ml	Ft	🚗	🏠
400		12	097290040
400	1.630	12	097291040
400		12	097292040

9738 - Cutting Oil

Kenőanyag

Kiemelkedő kenés és védelem. Maráshoz, fúráshoz, menetmetszéshez, valamint kézi és automatikus gépi megmunkáláshoz ajánlott. Magas oxidációállóság. Vizzel lemosható. Oldószert nem tartalmaz.



ml	Ft	🚗	🏠
400		12	097380040
400	2.090	12	097381040
400		12	097382040

9740 - Brake Cleaner

Féktisztító spray

Ideális féktárcsák és fékbetétek, vagy a motorok tisztításához. Maradék nélkül eltávolítja a zsírt és a kátrányt. Gyorsan elpárolog, nem károsítja a műanyagokat és a gumit.



ml	Ft	🚗	🏠
500		12	097400050
500	1.840	12	097401050
500		12	097402050

9741 - Multi Cleaner

többcélú tisztítószer/zsírtalanító

Zsír, olaj, kátrány, szilikon és ragasztó oldására alkalmas tisztító- és zsírtalanító szer. Alkalmas fém, kemény műanyag, kerámia, acél és alumínium felület tisztítására. Nem tartalmaz olajmaradékot.



ml	Ft	🚗	🏠
400		12	097410040
400	2.090	12	097411040
400		12	097412040

9742 - Contact Cleaner

Elektromos és elektronikus kontakt spray

Eltávolítja a zsírt és a szennyeződést, olajos maradék nélkül. Gyorsan elpárolog. Nem károsítja a műanyagokat és a gumit.



ml	Ft	🚗	🏠
400		12	097420040
400	1.740	12	097421040
400		12	097422040

9743 - SURFACE CLEANER

tisztítóhab

Tisztítóhab mindenféle felületre, szerszámhoz és anyaghoz. Kvaterner ammóniumsó alapú tisztítószer aktív habréteget képez a felületen eltávolítva a koszt és zsírt. Megszünteti a rossz szagokat. Nincs szükség öblítésre. Nem csíráltató.



ml	Ft	🚗	🏠
500		12	097430050
500	4.330	12	097431050
500		12	097432050

9745 - Carb Cleaner

Karburátor és fojtószelepház tisztító spray

A karburátorok, szívócsatornák és fojtószelepházak belső és külső tisztítására. Teljesen eltávolítja a széntartalmú lerakódásokat és a szennyeződéseket. Nem hagy olajos maradékot.



ml	Ft	🚗	🏠
400		12	097450040
400	1.850	12	097451040
400		12	097452040

9746 - Clima Cleaner

léghűtő tisztító

Ipari, háztartási és gépjármű léghűtő berendezések tisztításához. A kiváló habképződésnek és a mellékelt csőnek köszönhetően hatékonyan eltávolítja a koszt, lerakódást és megszünteti a kellemetlen szagokat a légszűrőben, kellemes illatot hagyva maga után.



ml	Ft	🚚	🏠
400		12	097460040
400	3.550	12	097461040
400		12	097462040

9749 - Air Spray

levegő spray

Sűrített levegős spray. Ideális a hézagokban, szerelvényeken, elektromos részekben, billentyűzeten és általában a kényes berendezéseken megtelepedett por eltávolítására. A csövet az aeroszolos palackra rögzítve a nehezen megközelíthető részek is könnyen elérhetővé válnak.



ml	Ft	🚚	🏠
400		12	097490040
400	2.260	12	097491040
400		12	097492040

9752 - Zinc 98%

Tiszta horgany

Magas fedőképesség, ideális a fémrészek galvanizálásánál. Nagyfokú tapadás, egy nagyon világos, rugalmas fóliát képez, hasonlóan a tűzi horganyzáshoz. Különösen ellenálló az oxidációnak, kopásnak és időjárásnak. Átfesthető. Nem csepeg.



ml	Ft	🚚	🏠
400		12	097520040
400	2.150	12	097521040
400		12	097522040

9755 - Welding Spray

fröccsenésgátló hegesztő spray

Szilikonmentes fröccsenésgátló hegesztő spray. Meggátolja a salakképződést, így a hegesztés könnyebb és gyorsabb. A hegesztendő felületek és a hegesztőpisztoly védelmére egyaránt használható. Lehetővé teszi a hegesztést követő felületkezelést, pl. festés, galvanizálás, krómozás végzését. Nem füstöl. Könnyen eltávolítható. Klórmentes.



ml	Ft	🚚	🏠
400		12	097550040
400	2.240	12	097551040
400		12	097552040

9765 - Deicer Spray

jégoldó spray

Jégoldó és jégmentesítő spray az ablakokon kialakult jég eltávolításához. Befagyott zárakhoz és mechanikus részekhez is ideális. Akár -40 °C-ig hatékony. Nem zsíros, nem maszatol. Nem károsítja a kezelt felületet, gumit és műanyagot.



ml	Ft	🚚	🏠
400		12	097650040
400	3.700	12	097651040
400		12	097652040

9775 - Water Stop

impregnáló spray

Impregnáló, víztaszító spray textil és bőr anyagokhoz. Ideális lábbelik, dzsekik és egyéb ruhadarabok impregnálására. A kezelt anyag továbbra is jól szellőző marad. Foltálló tulajdonságának köszönhetően az anyagokat könnyebb mosni. Fokozottan gyűrődés- és kopásálló.



ml	Ft	🚚	🏠
400		12	097750040
400	4.020	12	097751040
400		12	097752040

9881U

Ipari lúgos tisztítószer ultrahangos mosóberendezéshez

Ipari lúgos tisztítószer koncentrátum, vízalapú. Ultrahangos tisztításhoz és egyéb tisztító eljárásokhoz. Alkatrészek és általában fém darabok (befecskendező, karburátor, szelep, stb.) pontos és hatékony tisztításához. Eltávolítja az olajat, zsírt, kenőanyagokat, ragasztó-, gyanta- és viaszmaradékot. Alumínium darabok tisztítására is alkalmas.



Lt	Ft	🚚	🏠
1	9.720	1	098810010
1		1	098812010

9882R

Szelektív rozsdaeltávolító folyadék

Vízalapú szelektív rozsdaeltávolító folyadék vas, acél, rozsdamentes acél, öntöttvas és krómozott felületekre. Eltávolítja az oxidált felületet az alatta lévő fémréteg károsítása nélkül.

Hígítás: tisztán vagy maximum 1:1 arányban hígítva használható.

Minimum felhasználási hőmérséklet: 15 °C.

Hatóidő: 30 perctől 24/48 óráig (vastag rozsdá). Biológiailag legombló és 100%-ban vízben oldható.



Lt	Ft	🚚	🏠
1	11.100	1	098820010
1		1	098822010



Több mint 500, termékkóddal ellátott, az ipari és professzionális vágási és csiszolási igényeknek megfelelően tervezett és kifejlesztett cikket tartalmazó, Olaszországban gyártott merev és rugalmas csiszolótermék.

A Beta Utensili a Beta Abrasives projekttel megerősíti célkitűzését, hogy a szakemberek számára az AbraBeta gyártási szaktudására alapozva páratlan műszaki színvonalú teljes körű termékcsaláddal szolgáljon.

KEMÉNY VÁGÓ- ÉS CSISZOLÓKORONGOK





Az új termékcsalád fő kategóriáját a kemény korongok alkotják, a Beta Utensili ezekhez a legjobb anyagokat és megoldásokat választotta.

A vágó- és csiszolókorongok a megfelelő célszerszámokkal, sarokcsiszolóktól kezdve a telepített berendezésekig a leggyorsabb és legsokoldalúbb megoldást kívánják a szakemberek számára.

KORONG FORMÁK

 **T42**
süllyesztett agyú vágókorong

 **T41**
egyenes vágókorong

 **T27**
süllyesztett agyú csiszolókorong

TOP
— LINE —

Minőség kompromisszumok nélkül: a legigényesebb felhasználók számára

PREMIUM
— LINE —

Nagy teljesítményt biztosító kiváló minőség versenyképes áron, a legjobb ár/minőség arány.

TANÚSÍTVÁNY



A korongokon elhelyezett PIKTOGRAMOK



Viseljen védőszemüveget



Viseljen védőkesztyűt



Csak vágásra. Nem csiszolókorong.



Viseljen fülvédőt



Viseljen védőruházatot



Ne használja a korongot, ha sérült



Viseljen porvédő maszkot



Olvassa el a használati utasítást



Vas-, kén- és klórmentes ($\leq 0,1\%$)

Termék minőségmegőrzési ideje

Termék minőségmegőrzési ideje: gyártás időpontjától számított 3 év. A korong közepén lévő fém tárcsára gravírozott "V01" a lejárat negyedévét jelöli. Példa: A "V07/2022" jelöléssel ellátott korong 2019. III. negyedévében készült és 2022. III. negyedévéig használható.



	Negyedév
V01	jan.-márc.
V04	ápr.-jún.
V07	júl.-szept.
V10	okt.-dec.



CSAPOS DÖRZSKORONGOK

A csapos, lamellás korong rugalmas lamelláival pontos, homogén eredmény érhető el szabálytalan formákon és felületeken.



CSAPOS DÖRZSKORONGOK

A csapos lamellás korong rugalmas lamelláival pontos, homogén eredmény érhető el szabálytalan formákon és felületeken.



LAMELLÁS KORONGOK

A csiszoló tárcsák egy hordozó felületre ragasztott csiszolóvászon lamellákból állnak, melyek kiváló választást jelentenek nagyoláshoz és simításhoz. Összességében a csiszolókorongoknál gyorsabb leválasztást, homogénebb felületet, gyengébb vibrációt, alacsonyabb zajszintet és működési hőmérsékletet biztosítanak. Különböző szemcseméretű és különböző csiszolóanyagokkal készült vászonzó, két különböző hordozóanyaggal kaphatók.

Formák

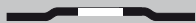

Lapos

A megmunkálandó felülethez képest maximum 15°-os szögben használandó; lapos felületek és élek megmunkálásához ajánlott.

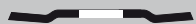

Kúpos

A megmunkálandó felülethez képest 15°-25° között használandó; megkönnyíti az egyenetlen felületek megmunkálását. Nagyobb érintkezési felületet biztosít a korong és a munkadarab között. A lamellák teljes kopásig használhatók.



Minőség kompromisszumok nélkül: a legigényesebb felhasználók számára.



Nagy teljesítményt biztosító kiváló minőség versenyképes áron, a legjobb ár/minőség arány.



FURATOS CSISZOLÓHENGEREK

A lamellás csiszolóhengerek a lamellák rugalmassága miatt a szabálytalan élek, kontúrok és felületek megmunkálására ajánlottak.



HENGEREK SZATINÁLÓ GÉPEKHEZ

A Beta szatináló gépekhez való korongjai (vagy hengerei) bármilyen anyag finiseléséhez a legjobb megoldást jelentik.

Szemcsefinomság/kidolgozás finomsága	
C	Durva
M	Közepes
F	Finom
VF	Nagyon finom
UF	Ultra finom



RADIÁLIS CSISZOLÓKORONGOK ÉS FIBERTÁRCSÁK

A kiváló polírozó hatású speciális nemszőtt korongok gyors, pontos munkavégzést tesznek lehetővé.



VÉGTELENÍTETT SZALAGOK

Csiszolóvászonzó és papírból vagy nemszőtt anyagból készült kiváló minőségű végtelenített szalagok széles skálája különböző felhasználásokra.

További információkat a Beta weboldalán található vágó- és csiszolótermék katalógusban talál: www.beta-tools.com

11001

süllyesztett agyú
acél vágókorongok

A30S EN 12413



A30S

	Ø mm	S mm	F mm	max. rpm	Ft		
11001	115	3,2	22,23	13300	485	10	110010118
11001	125	3,2	22,23	12200	510	10	110010128
11001	230	3,2	22,23	6600	1.110	10	110010233

11001H

süllyesztett agyú
acél vágókorongok

KEMÉNY
A30T EN 12413



A30T

	Ø mm	S mm	F mm	max. rpm	Ft		
11001H	230	3,2	22,23	6600	1.110	10	110010733

11003

egyenes
acél vágókorongok

A30T EN 12413



A30T

	Ø mm	S mm	F mm	max. rpm	Ft		
11003	115	2,5	22,23	13300	440	10	110030117
11003	125	2,5	22,23	12200	455	10	110030127
11003	180	2,5	22,23	8500	910	10	110030182
11003	230	2,5	22,23	6600	1.050	10	110030232

11011

süllyesztett agyú
acél csiszolókorongok

A24N EN 12413



A24N

	Ø mm	S mm	F mm	max. rpm	Ft		
11011	115	6,5	22,23	13300	655	10	110110115
11011	125	6,5	22,23	12200	710	10	110110125
11011	180	6,5	22,23	8500	1.520	10	110110180
11011	230	6,5	22,23	6600	2.090	10	110110230

11011H

süllyesztett agyú
acél csiszolókorongok

KEMÉNY
A24R EN 12413



A24R

	Ø mm	S mm	F mm	max. rpm	Ft		
11011H	115	6,5	22,23	13300	655	10	110110615
11011H	125	6,5	22,23	12200	710	10	110110625
11011H	180	6,5	22,23	8500	1.520	10	110110680
11011H	230	6,5	22,23	6600	2.050	10	110110730

11018

egyenes ultravékony
acél vágókorongok

60 m/s
A46N EN 12413



A46N

	Ø mm	S mm	F mm	max. rpm	Ft		
11018	300	2,5	25,40	4010	1.990	10	110180030
11018	350	3,0	25,40	3440	2.870	10	110180035
11018	400	3,2	25,40	3010	3.590	10	110180040

11019

egyenes ultravékony
acél vágókorongok

80 m/s

A24N EN 12413



A24N

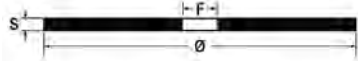

	Ø	S	F	max.	Ft		
	mm	mm	mm	rpm			
11019	300	3,8	25,40	5100	2.160	10	110190030
11019	350	4,2	25,40	4400	3.510	10	110190035
11019	400	4,5	25,40	3800	4.270	10	110190040

11021

süllyesztett agyú acél és rozsdamentes acél
vágókorongok

A30Q EN 12413



A30Q



	Ø	S	F	max.	Ft		
	mm	mm	mm	rpm			
11021	115	3,2	22,23	13300	485	10	110210118
11021	125	3,2	22,23	12200	520	10	110210128
11021	180	3,2	22,23	8500	1.000	10	110210183
11021	230	3,2	22,23	6600	1.100	10	110210233

11023

süllyesztett agyú acél és rozsdamentes acél
csiszolókorongok

A24Q EN 12413



A24Q



	Ø	S	F	max.	Ft		
	mm	mm	mm	rpm			
11023	115	6,5	22,23	13300	675	10	110230115
11023	125	6,5	22,23	12200	735	10	110230125
11023	230	6,5	22,23	6600	2.230	10	110230230

11024

Süllyesztett agyú, vékony, acél és rozsdamentes acél
vágókorongok

TOP LINE

A46U EN 12413



TOP
LINE

A46U

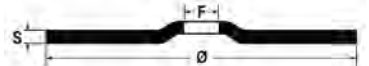

	Ø	S	F	max.	Ft		
	mm	mm	mm	rpm			
11024	230	2,0	22,23	6600	1.380	10	110240230

11031+11038

egyenes, vékony, acél és rozsdamentes acél
vágókorongok

TOP LINE

Ø 65 mm

A46U EN 12413



TOP
LINE

A46U

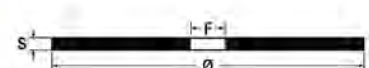

	Ø	S	F	max.	Ft		
	mm	mm	mm	rpm			
11031	65	1,0	6,00	24000	425	25	110310006
11031	65	1,0	10,00	24000	425	25	110310010
11031	65	1,6	10,00	24000	425	25	110310020

	Ø	S	F	max.	Ft		
	mm	mm	mm	rpm			
11032	76	1,0	6,00	20200	425	25	110320006
11032	76	1,0	10,00	20200	425	25	110320010
11032	76	1,6	10,00	20200	425	25	110320020

	Ø	S	F	max.	Ft		
	mm	mm	mm	rpm			
11034	115	1,0	22,23	13300	585	25	110340022
11034	115	1,2	22,23	13300	585	25	110340042
11034	115	1,6	22,23	13300	585	25	110340062

	Ø	S	F	max.	Ft		
	mm	mm	mm	rpm			
11035	125	1,0	22,23	12200	660	25	110350022
11035	125	1,2	22,23	12200	635	25	110350042
11035	125	1,6	22,23	12200	660	25	110350062

	Ø	S	F	max.	Ft		
	mm	mm	mm	rpm			
11037	180	2,0	22,23	8500	1.050	10	110370022

	Ø	S	F	max.	Ft		
	mm	mm	mm	rpm			
11038	230	2,0	22,23	6600	1.260	10	110380022

11040

Süllyesztett agyú, vékony, acél és rozsdamentes acél vágókorongok

PREMIUM LINE

A36Q EN 12413



A36Q

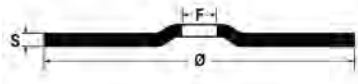

	Ø	S	F	max.			
	mm	mm	mm	rpm	Ft		
11040	230	2,0	22,23	6600	1.010	10	110400230

11045-11046

egyenes, vékony, acél és rozsdamentes acél vágókorongok

PREMIUM LINE

Ø 115 mm

A46Q EN 12413



A46Q



	Ø	S	F	max.			
	mm	mm	mm	rpm	Ft		
11045	115	1,0	22,23	13300	480	25	110450010
11045	115	1,2	22,23	13300	480	25	110450012
11045	115	1,6	22,23	13300	480	25	110450016

	Ø	S	F	max.			
	mm	mm	mm	rpm	Ft		
11046	125	1,0	22,23	12200	505	25	110460010
11046	125	1,2	22,23	12200	505	25	110460012
11046	125	1,6	22,23	12200	505	25	110460016

11048-11049

egyenes, vékony, acél és rozsdamentes acél vágókorongok

Ø 180 mm

A36Q EN 12413



A36Q



	Ø	S	F	max.			
	mm	mm	mm	rpm	Ft		
11048	180	2,0	22,23	8500	740	10	110480019

	Ø	S	F	max.			
	mm	mm	mm	rpm	Ft		
11049	230	2,0	22,23	6600	1.000	10	110490019

11050

acél csiszolókorongok, cirkónium csiszolóanyag, süllyesztett agyú

ZA24R - EN 12413



ZA24R

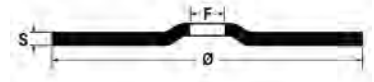

	Ø	S	F	max.			
	mm	mm	mm	rpm	Ft		
11050	115	6,5	22,23	13300	1.120	10	110500115
11050	125	6,5	22,23	12200	1.450	10	110500125
11050	230	7,0	22,23	6600	3.350	10	110500230

11069

süllyesztett agyú kő és márvány vágókorongok

C30S EN 12413



C30S



	Ø	S	F	max.			
	mm	mm	mm	rpm	Ft		
11069	115	3,2	22,23	13300	505	10	110690115
11069	125	3,2	22,23	12200	535	10	110690125
11069	230	3,2	22,23	6600	1.190	10	110690230

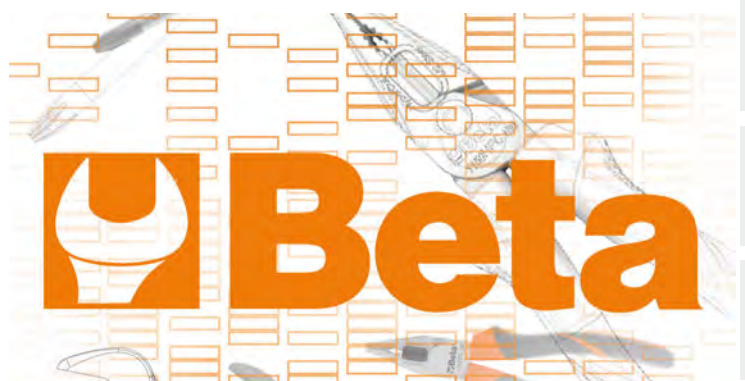

11100

csapos dörzskorongok,
rózsaszín korundszemcsés,
hengeres

szár Ø 3 x 37 mm

EN 12413

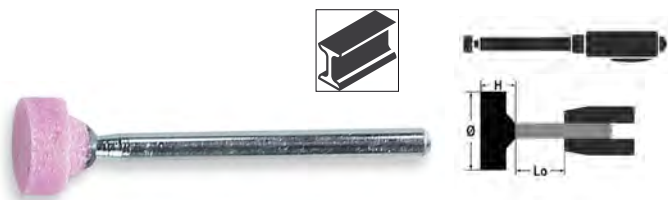

	Ø mm	h mm	max. rpm Lo=13 mm		Ft		
11100	4	8	130.000	AR60P5V	275	25	111000004
11100	6	10	93.100	AR60P5V	275	25	111000006
11100	8	12	64.500	AR60P5V	275	25	111000008
11100	10	10	60.100	AR60P5V	275	25	111000011
11100	10	12	52.700	AR60P5V	275	25	111000012
11100	12	15	37.300	AR60P5V	295	25	111000013

11101

csapos dörzskorongok,
rózsaszín korundszemcsés,
hengeres

szár Ø 6 x 40 mm

EN 12413



	Ø mm	h mm	max. rpm Lo=13 mm		Ft		
11101	4	8	130.000	AR60P5V	320	25	111010004
11101	5	10	130.000	AR60P5V	320	25	111010005
11101	6	10	130.000	AR60P5V	320	25	111010006
11101	8	10	119.300	AR60P5V	320	25	111010008
11101	10	10	95.400	AR60P5V	320	25	111010010
11101	10	15	95.400	AR60P5V	320	25	111010011
11101	10	20	86.600	AR60P5V	360	25	111010012
11101	10	25	72.700	AR60P5V	395	25	111010013
11101	10	32	58.700	AR60P5V	410	25	111010014
11101	12	10	79.500	AR60P5V	295	25	111010015
11101	12	15	79.500	AR60P5V	295	25	111010016
11101	12	20	79.500	AR60P5V	340	25	111010017
11101	15	3	63.600	AR60P5V	295	25	111010018
11101	15	15	63.600	AR60P5V	320	25	111010019
11101	16	20	59.600	AR46P5V	370	25	111010020
11101	16	25	56.900	AR46P5V	395	25	111010021
11101	16	32	45.100	AR46P5V	430	25	111010022
11101	20	4	47.700	AR60P5V	295	25	111010023
11101	20	15	47.700	AR46P5V	320	25	111010024
11101	20	20	47.700	AR46P5V	395	25	111010025
11101	20	25	46.100	AR46P5V	410	25	111010026
11101	20	30	38.900	AR46P5V	455	25	111010027
11101	20	40	29.000	AR46P5V	555	25	111010028
11101	25	10	38.100	AR60P5V	320	25	111010030
11101	25	25	37.200	AR36/46P5V	455	25	111010031
11101	25	40	23.300	AR36/46P5V	655	10	111010032
11101	30	10	31.800	AR60P5V	370	25	111010034
11101	30	30	26.200	AR36/46P5V	535	25	111010035
11101	30	40	19.500	AR36/46P5V	715	10	111010036
11101	32	20	29.800	AR36P5V	500	25	111010037
11101	32	32	23.100	AR36P5V	680	10	111010038
11101	40	10	23.800	AR36/46P5V	535	25	111010041
11101	40	20	23.800	AR36P5V	715	10	111010042
11101	40	25	23.400	AR36P5V	750	10	111010043
11101	40	30	19.700	AR36P5V	825	10	111010044
11101	40	40	14.700	AR36P5V	1.010	10	111010045
11101	50	15	19.000	AR36P5V	785	10	111010051
11101	50	25	18.800	AR36P5V	960	10	111010052
11101	60	10	15.900	AR36P5V	875	10	111010060

11102

csapos dörzskorongok,
rózsaszín korundszemcsés,
hengeres

szár Ø 6 x 80 mm

EN 12413

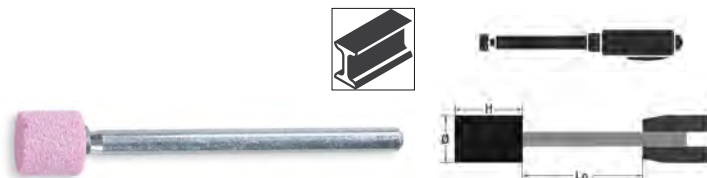

	Ø mm	h mm	max. rpm Lo=13 mm		Ft		
11102	8	20	100.500	AR60P5V	425	25	111020008
11102	10	15	95.400	AR60P5V	405	25	111020010
11102	10	30	62.200	AR60P5V	495	25	111020020
11102	12	15	79.500	AR60P5V	410	25	111020022
11102	15	15	63.600	AR60P5V	430	25	111020035
11102	15	30	51.000	AR46P5V	540	25	111020040
11102	20	30	38.900	AR46P5V	540	25	111020060

11105

csapos dörzskorongok,
rózsaszín korundszemcsés,
hengeres/háromszögletű

szár Ø 6 x 40 mm

EN 12413



	Ø mm	h mm	max. rpm Lo=13 mm		Ft		
11105	20	65	16.200	AR36/46P5V	1.040	25	111050020

11106

csapos dörzskorongok,
rózsaszín korundszemcsés,
trapéz alakú

szár Ø 3 x 37 mm

EN 12413

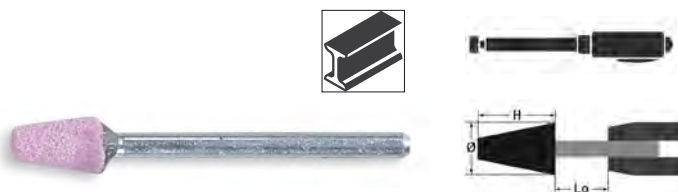

	Ø mm	h mm	max. rpm Lo=13 mm		Ft		
11106	6	10	93.100	AR60P5V	370	25	111060006

11107

csapos dörzskorongok,
rózsaszín korundszemcsés,
trapéz alakú

szár Ø 6 x 40 mm

EN 12413

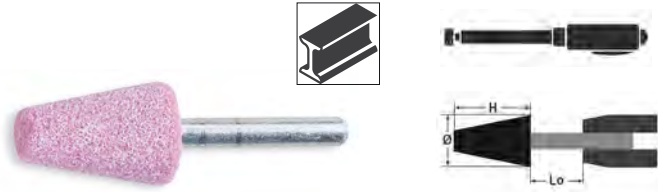

	Ø mm	h mm	max. rpm Lo=13 mm		Ft		
11107	12	20	79.500	AR60P5V	410	25	111070012
11107	15	25	60.400	AR46P5V	495	25	111070015
11107	20	30	38.900	AR46P5V	555	25	111070020
11107	25	40	23.300	AR36/46P5V	825	10	111070025

11110

csapos dörzskorongok,
rózsaszín korundszemcsés,
kerekített, kúp alakú

szár Ø 3 x 37 mm

EN 12413

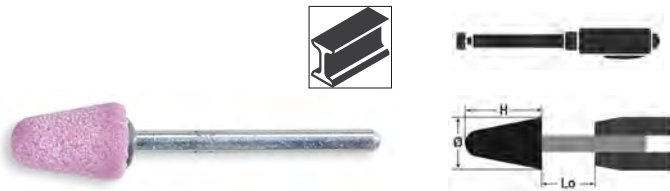

	Ø mm	h mm	max. rpm Lo=13 mm		Ft		
11110	10	15	44.300	AR60P5V	370	25	111100010

11111

csapos dörzskorongok,
rózsaszín korundszemcsés,
kerekített, kúp alakú

szár Ø 6 x 40 mm

EN 12413

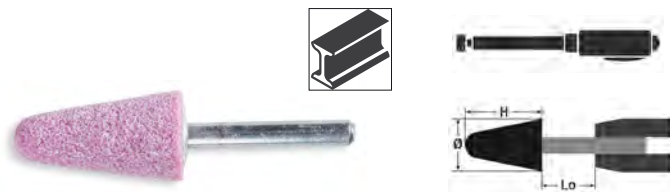

	Ø mm	h mm	max. rpm Lo=13 mm		Ft		
11111	10	20	86.600	AR60P5V	425	25	111110010
11111	15	30	51.000	AR46P5V	540	25	111110015
11111	16	45	31.400	AR46P5V	750	25	111110016
11111	20	28	41.500	AR46P5V	555	25	111110020
11111	20	40	29.000	AR46P5V	715	25	111110021
11111	30	50	15.100	AR36/46P5V	1.040	10	111110030

11115

csapos dörzskorongok,
rózsaszín korundszemcsés,
csúcsíves

szár Ø 3 x 37 mm

EN 12413

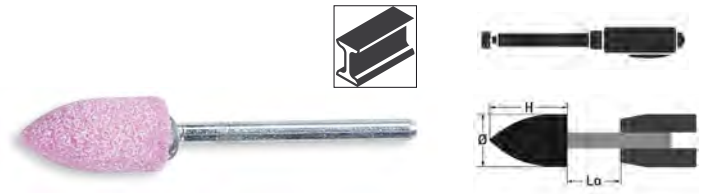

	Ø mm	h mm	max. rpm Lo=13 mm		Ft		
11115	10	20	34.700	AR60P5V	395	25	111150010

11116

csapos dörzskorongok,
rózsaszín korundszemcsés,
csúcsíves

szár Ø 6 x 40 mm

EN 12413

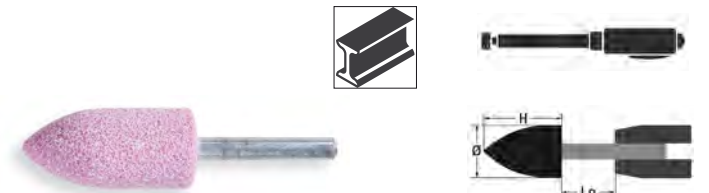

	Ø mm	h mm	max. rpm Lo=13 mm		Ft		
11116	10	20	86.600	AR60P5V	425	25	111160010
11116	18	30	43.000	AR46P5V	555	25	111160018
11116	20	50	22.500	AR36/46P5V	875	25	111160020
11116	22	70	13.400	AR36/46P5V	1.340	10	111160022

11120

csapos dörzskorongok,
rózsaszín korundszemcsés,
hengeres/csúcsos

szár Ø 3 x 37 mm

EN 12413

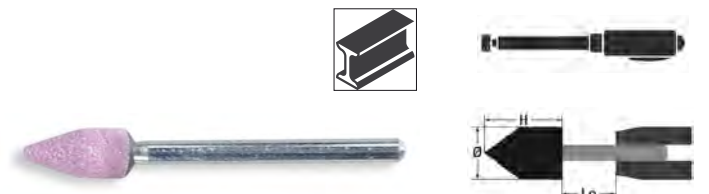

	Ø mm	h mm	max. rpm Lo=13 mm		Ft		
11120	6	13	77.800	AR60P5V	370	25	111200006



11121

csapos dörzskorongok,
rózsaszín korundszemcsés,
hengeres/csúcsos

szár Ø 6 x 40 mm

EN 12413

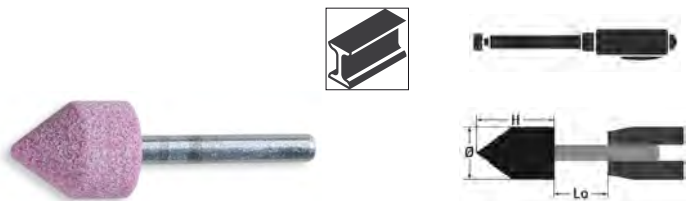

	Ø mm	h mm	max. rpm Lo=13 mm		Ft		
11121	6	25	100.700	AR60P5V	555	25	111210007
11121	12	20	79.500	AR60P5V	410	25	111210012
11121	20	25	46.100	AR46P5V	515	25	111210020
11121	25	25	37.200	AR36/46P5V	555	25	111210025
11121	30	30	26.200	AR36/46P5V	675	25	111210030

11125

csapos dörzskorongok,
rózsaszín korundszemcsés,
kerekített, henger alakú

szár Ø 6 x 40 mm

EN 12413

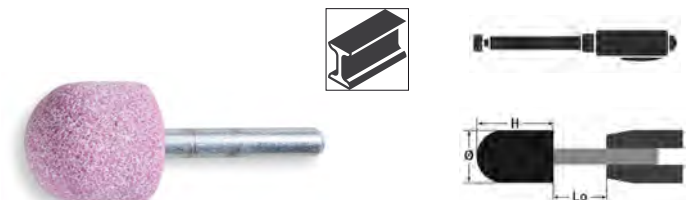

	Ø mm	h mm	max. rpm Lo=13 mm		Ft		
11125	6	20	117.700	AR60P5V	460	25	111250006
11125	25	25	37.200	AR36/46P5V	555	25	111250025
11125	30	50	15.100	AR36/46P5V	1.040	10	111250030
11125	40	40	14.700	AR36P5V	1.260	10	111250040

11130

csapos dörzskorongok,
rózsaszín korundszemcsés,
gömbölyű

szár Ø 3 x 37 mm

EN 12413

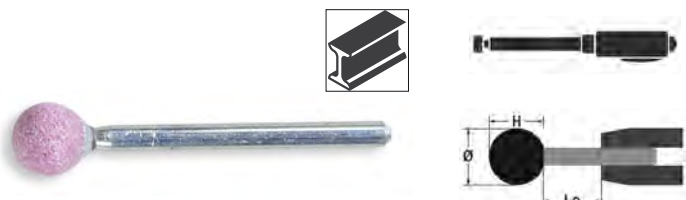

	Ø mm	h mm	max. rpm Lo=13 mm		Ft		
11130	6	6	124.900	AR60P5V	370	25	111300006
11130	8	8	84.800	AR60P5V	370	25	111300008
11130	10	10	60.100	AR60P5V	370	25	111300010

11131

csapos dörzskorongok,
rózsaszín korundszemcsés,
gömbölyű

szár Ø 6 x 40 mm

EN 12413

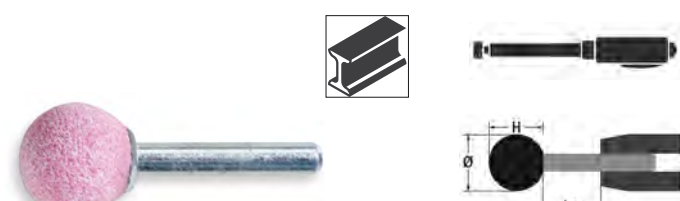

	Ø mm	h mm	max. rpm Lo=13 mm		Ft		
11131	10	10	95.400	AR60P5V	395	25	111310010
11131	15	15	63.600	AR60P5V	410	25	111310015
11131	20	20	47.700	AR46P5V	495	25	111310020
11131	25	25	37.200	AR36/46P5V	555	25	111310025
11131	30	30	26.200	AR36/46P5V	675	25	111310030

11132

csapos dörzskorongok,
rózsaszín korundszemcsés,
gömbölyű

szár Ø 6 x 80 mm

EN 12413

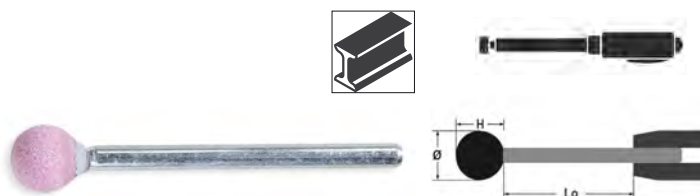

	Ø mm	h mm	max. rpm Lo=13 mm		Ft		
11132	10	10	95.400	AR60P5V	460	25	111320010
11132	15	15	63.600	AR60P5V	515	25	111320015
11132	20	20	47.700	AR46P5V	605	25	111320020

11135

csapos dörzskorongok,
rózsaszín korundszemcsés,
korong alakú

szár Ø 6 x 40 mm

EN 12413

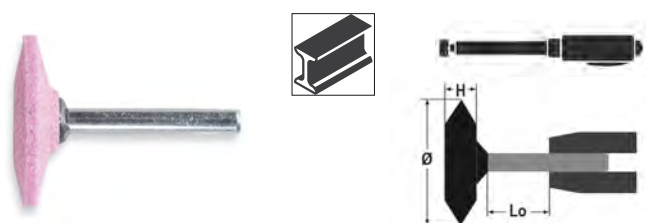

	Ø mm	h mm	max. rpm Lo=13 mm		Ft		
11135	30	6	31.800	AR60P5V	455	25	111350030
11135	40	10	23.800	AR36/46P5V	680	25	111350040

11140

csapos dörzskorongok,
szürke/rózsaszín korundszemcsés,
hengeres

szár Ø 6 x 40 mm

EN 12413



	Ø mm	h mm	max. rpm Lo=13 mm		Ft		
11140	20	30	38.900	A/AR24R5V	455	25	111400020
11140	25	25	37.200	A/AR24R5V	455	25	111400025
11140	30	30	26.200	A/AR24R5V	535	25	111400030
11140	50	10	19.000	A/AR24R5V	715	10	111400050

11141

csapos dörzskorongok,
szürke/rózsaszín korundszemcsés,
hengeres

szár Ø 6 x 80 mm

EN 12413

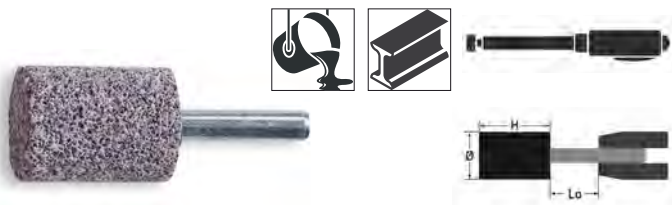

	Ø mm	h mm	max. rpm Lo=13 mm		Ft		
11141	20	40	46.800	A/AR24R5V	630	25	111410020
11141	30	40	31.800	A/AR24R5V	755	10	111410030
11141	40	40	23.800	A/AR24R5V	1.090	10	111410040

11145

csapos dörzskorongok,
szürke/rózsaszín korundszemcsés,
csúcsíves

szár Ø 6 x 40 mm

EN 12413

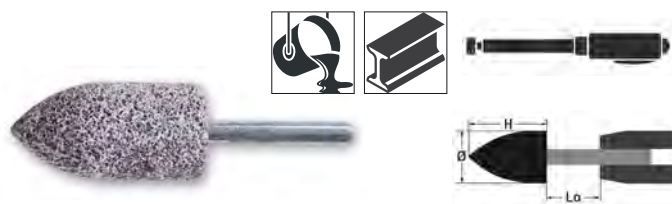

	Ø mm	h mm	max. rpm Lo=13 mm		Ft		
11145	20	30	38.900	A/AR24R5V	555	25	111450020
11145	25	50	18.100	A/AR24R5V	1.010	10	111450025

11200A-11200B

csiszolótárcsák cirkónium csiszolóvászonnal,
műanyag csiszolótalp, egylamellás kivitel

Egyenes
PREMIUM LINE

Ø 115 mm

EN 13743

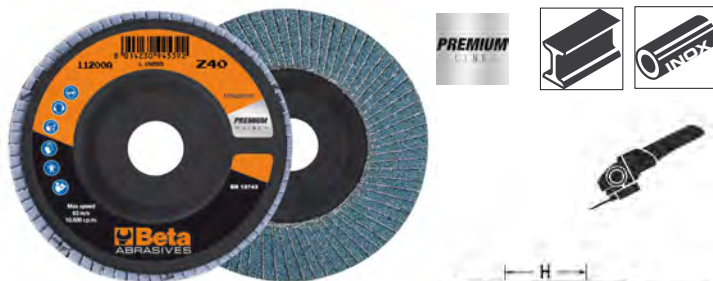

	Ø mm	P	F mm		Ft		
11200A	115	40	22,23		810	10	112000004
11200A	115	60	22,23		810	10	112000006
11200A	115	80	22,23		810	10	112000008
11200A	115	120	22,23		810	10	112000012

	Ø mm	P	F mm		Ft		
11200B	125	40	22,23		970	10	112000104
11200B	125	60	22,23		970	10	112000106
11200B	125	80	22,23		970	10	112000108

11202A-11202C

csiszolótárcsák cirkónium csiszolóvászonnal,
műanyag csiszolótalp, dupla lamellás kivitel

Egyenes
PREMIUM LINE

Ø 115 mm

EN 13743

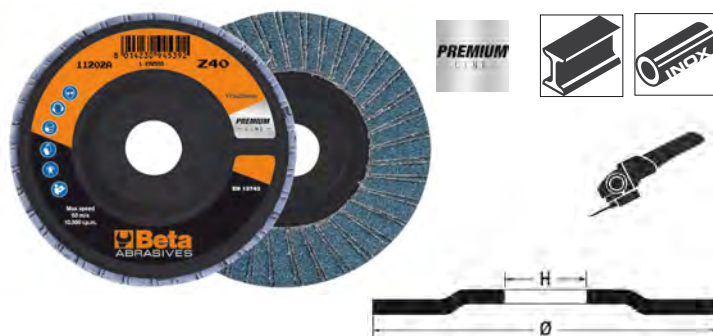

	Ø mm	P	F mm		Ft		
11202A	115	40	22,23		810	10	112020004
11202A	115	60	22,23		810	10	112020006
11202A	115	80	22,23		810	10	112020008
11202A	115	120	22,23		810	10	112020012

	Ø mm	P	F mm		Ft		
11202B	125	40	22,23		970	10	112020104
11202B	125	60	22,23		970	10	112020106
11202B	125	80	22,23		970	10	112020108

	Ø mm	P	F mm		Ft		
11202C	180	40	22,23		2.080	10	112020204
11202C	180	60	22,23		2.080	10	112020206

11204A÷11204C

csiszolótarcsák cirkónium csiszolóvászonnal,
üvegszál csiszolótalp, egylamellás kivitel

Egyenes
PREMIUM LINE
Ø 115 mm
EN 13743

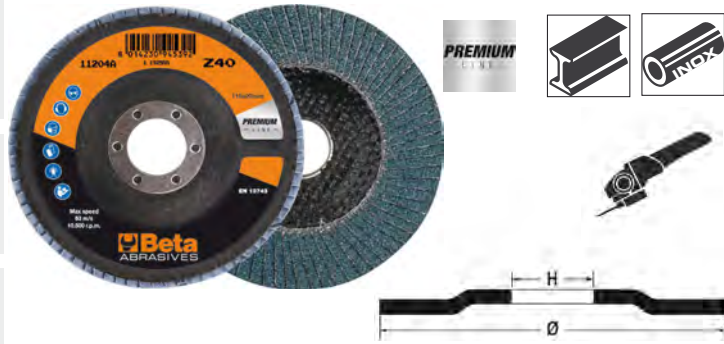

	Ø mm	P	F mm	Ft		
11204A	115	40	22,23	765	10	112040004
11204A	115	60	22,23	765	10	112040006
11204A	115	80	22,23	765	10	112040008
11204A	115	120	22,23	765	10	112040012

	Ø mm	P	F mm	Ft		
11204B	125	40	22,23	945	10	112040104
11204B	125	60	22,23	945	10	112040106
11204B	125	80	22,23	945	10	112040108

	Ø mm	P	F mm	Ft		
11204C	180	40	22,23	2.040	10	112040204
11204C	180	60	22,23	2.040	10	112040206

11208A-11208B

csiszolótarcsák cirkónium csiszolóvászonnal,
üvegszál csiszolótalp, dupla lamellás kivitel

Egyenes
PREMIUM LINE
Ø 115 mm
EN 13743

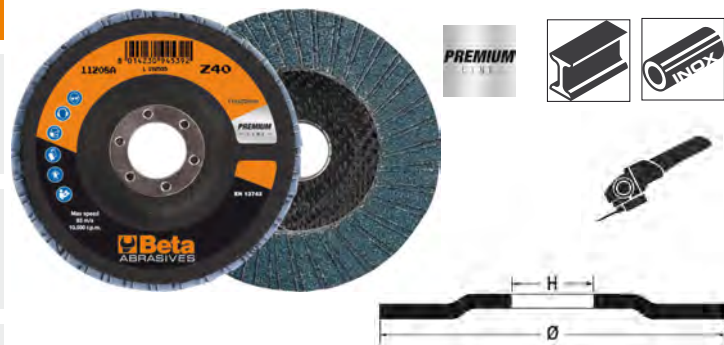

	Ø mm	P	F mm	Ft		
11208A	115	40	22,23	765	10	112080004
11208A	115	60	22,23	765	10	112080006

	Ø mm	P	F mm	Ft		
11208B	125	40	22,23	945	10	112080104
11208B	125	60	22,23	945	10	112080106

	Ø mm	P	F mm	Ft		
11208B	125	40	22,23	945	10	112080104
11208B	125	60	22,23	945	10	112080106

11210A÷11210C

csiszolótarcsák cirkónium csiszolóvászonnal,
üvegszál csiszolótalp, egylamellás kivitel

Kúpos
PREMIUM LINE
Ø 115 mm
EN 13743



	Ø mm	P	F mm	Ft		
11210A	115	40	22,23	765	10	112100004
11210A	115	60	22,23	765	10	112100006
11210A	115	80	22,23	765	10	112100008
11210A	115	120	22,23	765	10	112100012

	Ø mm	P	F mm	Ft		
11210B	125	40	22,23	945	10	112100104
11210B	125	60	22,23	945	10	112100106
11210B	125	80	22,23	945	10	112100108

	Ø mm	P	F mm	Ft		
11210C	180	40	22,23	2.040	10	112100204
11210C	180	60	22,23	2.040	10	112100206

11212A - 11212B

csiszolótarcsák cirkónium csiszolóvászonnal,
műanyag csiszolótalp, egylamellás kivitel

Egyenes
TOP LINE
Ø 115 mm
EN 13743

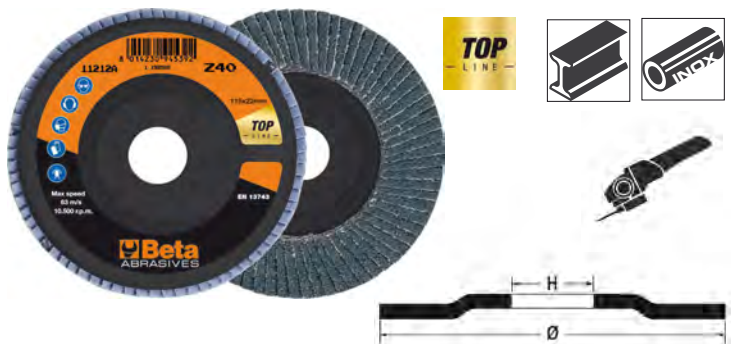

	Ø mm	P	F mm	Ft		
11212A	115	40	22,23	990	10	112120004
11212A	115	60	22,23	990	10	112120006
11212A	115	80	22,23	990	10	112120008
11212A	115	120	22,23	990	10	112120012

	Ø mm	P	F mm	Ft		
11212B	125	40	22,23	1.220	10	112120104
11212B	125	60	22,23	1.220	10	112120106
11212B	125	80	22,23	1.220	10	112120108

11214A÷11214C

csiszolótárcsák cirkónium csiszolóvászonnal,
műanyag csiszolótalp, dupla lamellás kivitel

Egyenes
TOP LINE
Ø 115 mm
EN 13743

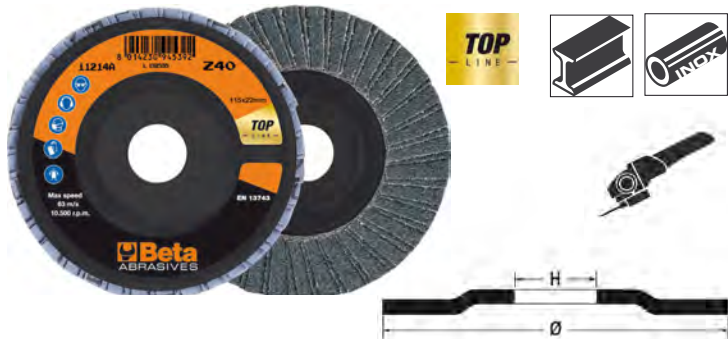

	Ø mm	P	F mm	Ft		
11214A	115	40	22,23	990	10	112140004
11214A	115	60	22,23	990	10	112140006
11214A	115	80	22,23	990	10	112140008
11214A	115	120	22,23	990	10	112140012

	Ø mm	P	F mm	Ft		
11214B	125	40	22,23	1.220	10	112140104
11214B	125	60	22,23	1.220	10	112140106
11214B	125	80	22,23	1.220	10	112140108

	Ø mm	P	F mm	Ft		
11214C	180	40	22,23	2.510	10	112140204
11214C	180	60	22,23	2.510	10	112140206

11216A÷11216C

csiszolótárcsák cirkónium csiszolóvászonnal,
üvegszál csiszolótalp, egylamellás kivitel

Egyenes
TOP LINE
Ø 115 mm
EN 13743



	Ø mm	P	F mm	Ft		
11216A	115	40	22,23	990	10	112160004
11216A	115	60	22,23	990	10	112160006
11216A	115	80	22,23	990	10	112160008
11216A	115	120	22,23	990	10	112160012

	Ø mm	P	F mm	Ft		
11216B	125	40	22,23	1.210	10	112160104
11216B	125	60	22,23	1.210	10	112160106
11216B	125	80	22,23	1.210	10	112160108

	Ø mm	P	F mm	Ft		
11216C	180	40	22,23	2.470	10	112160204
11216C	180	60	22,23	2.470	10	112160206

11218A-11218B

csiszolótárcsák cirkónium csiszolóvászonnal,
üvegszál csiszolótalp, dupla lamellás kivitel

Egyenes
TOP LINE
Ø 115 mm
EN 13743



	Ø mm	P	F mm	Ft		
11218A	115	40	22,23	990	10	112180004
11218A	115	60	22,23	990	10	112180006

	Ø mm	P	F mm	Ft		
11218B	125	40	22,23	1.210	10	112180104
11218B	125	60	22,23	1.210	10	112180106

11220A÷11220C

csiszolótárcsák cirkónium csiszolóvászonnal,
üvegszál csiszolótalp, egylamellás kivitel

Kúpos
TOP LINE
Ø 115 mm
EN 13743



	Ø mm	P	F mm	Ft		
11220A	115	40	22,23	990	10	112200004
11220A	115	60	22,23	990	10	112200006
11220A	115	80	22,23	990	10	112200008
11220A	115	120	22,23	990	10	112200012

	Ø mm	P	F mm	Ft		
11220B	125	40	22,23	1.210	10	112200104
11220B	125	60	22,23	1.210	10	112200106
11220B	125	80	22,23	1.210	10	112200108

	Ø mm	P	F mm	Ft		
11220C	180	40	22,23	2.470	10	112200204
11220C	180	60	22,23	2.470	10	112200206

11222

csiszolótarcsák cirkónium csiszolóvászonnal,
üvegszál csiszolótalp, dupla lamellás kivitel

Kúpos
TOP LINE
Ø 115 mm
EN 13743

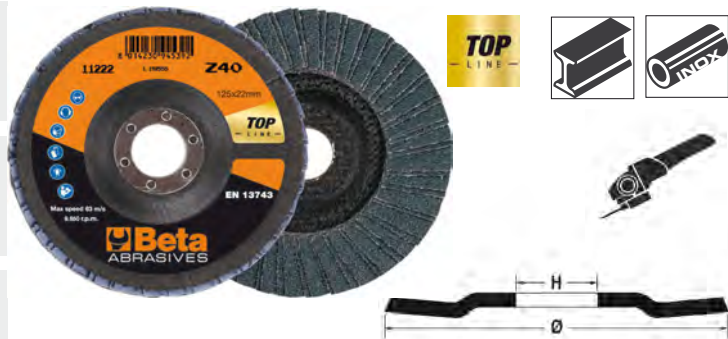

	Ø mm	P	F mm	Ft		
11222B	125	40	22,23	1.210	10	112220104
11222B	125	60	22,23	1.210	10	112220106
11222B	125	80	22,23	1.210	10	112220108

11230A-11230B

csiszolótarcsák korund csiszolóvászonnal,
műanyag csiszolótalp, egylamellás kivitel

Egyenes
PREMIUM LINE
Ø 115 mm
EN 13743



	Ø mm	P	F mm	Ft		
11230A	115	40	22,23	755	10	112300004
11230A	115	60	22,23	755	10	112300006
11230A	115	80	22,23	755	10	112300008
11230A	115	120	22,23	755	10	112300012
11230B	125	40	22,23	920	10	112300104
11230B	125	60	22,23	920	10	112300106

Beta

11232A

csiszolótarcsák korund csiszolóvászonnal,
műanyag csiszolótalp, dupla lamellás kivitel

Egyenes
PREMIUM LINE
Ø 115 mm
EN 13743

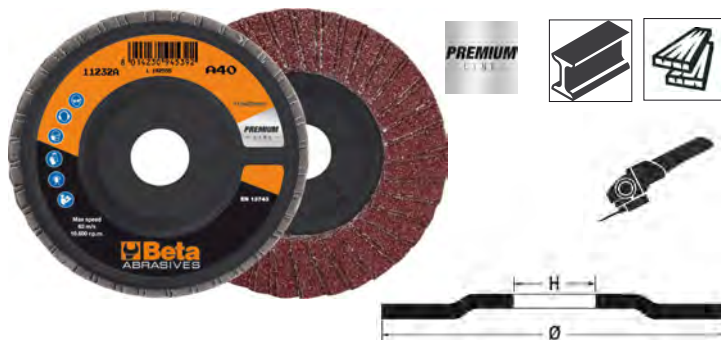

	Ø mm	P	F mm	Ft		
11232A	115	40	22,23	755	10	112320004
11232A	115	60	22,23	755	10	112320006
11232A	115	80	22,23	755	10	112320008
11232A	115	120	22,23	755	10	112320012

11234A-11234B

csiszolótarcsák korund csiszolóvászonnal,
üvegszál csiszolótalp, egylamellás kivitel

Egyenes
TOP LINE
Ø 115 mm
EN 13743



	Ø mm	P	F mm	Ft		
11234A	115	40	22,23	1.330	10	112340004
11234A	115	60	22,23	880	10	112340006
11234A	115	80	22,23	880	10	112340008
11234A	115	120	22,23	880	10	112340012
11234B	125	40	22,23	1.120	10	112340104
11234B	125	60	22,23	1.120	10	112340106

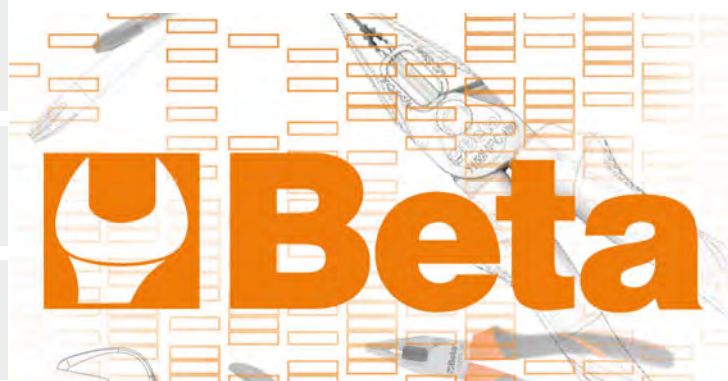

11240A-11240B

csiszoló tárcsák kerámia bevonatú cirkónium csiszolóvászonnal, műanyag csiszolótalp, egylamellás kivitel

Egyenes
Ø 115 mm
EN 13743

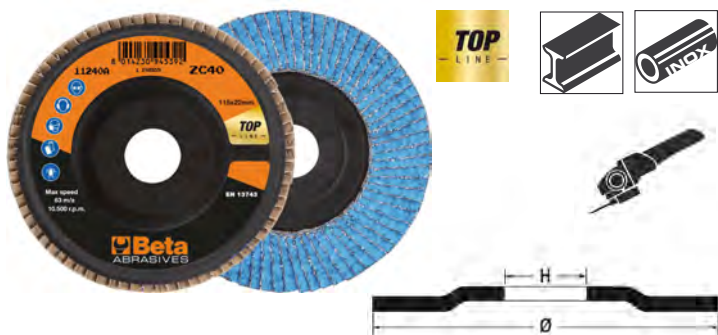

	Ø mm	P	F mm	Ft		
11240A	115	40	22,23	1.470	10	112400004
11240A	115	60	22,23	1.470	10	112400006

	Ø mm	P	F mm	Ft		
11240B	125	40	22,23	1.820	10	112400104
11240B	125	60	22,23	1.820	10	112400106

11242A-11242B

csiszoló tárcsák kerámia bevonatú cirkónium csiszolóvászonnal, üvegszál csiszolótalp, egylamellás kivitel

Egyenes
Ø 115 mm
EN 13743



	Ø mm	P	F mm	Ft		
11242A	115	40	22,23	1.460	10	112420004
11242A	115	60	22,23	1.460	10	112420006

	Ø mm	P	F mm	Ft		
11242B	125	40	22,23	1.740	10	112420104
11242B	125	60	22,23	1.740	10	112420106

11246A

csiszoló tárcsák kerámia bevonatú csiszolóvászonnal, műanyag csiszolótalp, egylamellás kivitel

Egyenes
Ø 115 mm
EN 13743



	Ø mm	P	F mm	Ft		
11246A	115	40	22,23	1.840	10	112460004
11246A	115	60	22,23	1.840	10	112460006

11248A-11248B

csiszoló tárcsák kerámia bevonatú csiszolóvászonnal, üvegszál csiszolótalp, egylamellás kivitel

Egyenes
Ø 115 mm
EN 13743



	Ø mm	P	F mm	Ft		
11248A	115	40	22,23	1.800	10	112480004
11248A	115	60	22,23	1.800	10	112480006

	Ø mm	P	F mm	Ft		
11248B	125	40	22,23	2.260	10	112480104
11248B	125	60	22,23	2.260	10	112480106

11259

filc csiszoló tárcsák, üvegszál csiszolótalp, egylamellás kivitel

Egyenes



	Ø mm	F mm	Ft		
11259	115	22,23	2.930	10	112590115
11259	125	22,23	3.360	10	112590125

Beta

11260÷11268

csapos lamellás korongok,
korund csiszolóvásznon lamellák

szár Ø 3 mm

EN 13743



	Ø mm	h mm	S mm	P	Ft		
11260	10	10	3	60	1.400	10	112600010
11260	15	15	3	60	1.130	10	112600015

	Ø mm	h mm	S mm	P	Ft		
11263	30	10	6	60	725	10	112630006
11263	30	15	6	60	725	10	112630016
11263	30	15	6	80	725	10	112630018
11263	30	20	6	40	750	10	112630024
11263	30	20	6	60	790	10	112630026
11263	30	20	6	80	790	10	112630028
11263	30	20	6	120	790	10	112630032

	Ø mm	h mm	S mm	P	Ft		
11264	40	15	6	60	760	10	112640006
11264	40	15	6	80	760	10	112640008
11264	40	15	6	120	760	10	112640012
11264	40	20	6	40	830	10	112640014
11264	40	20	6	60	825	10	112640016
11264	40	30	6	40	955	10	112640024
11264	40	30	6	60	955	10	112640026

	Ø mm	h mm	S mm	P	Ft		
11265	50	20	6	60	980	10	112650006
11265	50	20	6	80	980	10	112650008
11265	50	30	6	40	1.080	10	112650014
11265	50	30	6	60	1.080	10	112650016
11265	50	30	6	80	1.080	10	112650018
11265	50	30	6	120	1.170	10	112650022

	Ø mm	h mm	S mm	P	Ft		
11266	60	20	6	40	1.160	10	112660004
11266	60	20	6	60	1.160	10	112660006
11266	60	30	6	40	1.290	10	112660014
11266	60	30	6	60	1.290	10	112660016
11266	60	30	6	80	1.290	10	112660018
11266	60	30	6	120	1.390	10	112660022
11266	60	40	6	60	1.480	10	112660026
11266	60	40	6	80	1.480	10	112660028

	Ø mm	h mm	S mm	P	Ft		
11268	80	30	6	60	1.790	10	112680006
11268	80	30	6	80	1.790	10	112680008



11271A÷11271C

nemszított dörzskorong, csapos,
korund és műszálas anyag

Ø 40 mm

szár Ø 6 mm



	Ø mm	h mm	S mm	P	Ft		
11271A	40	20	6	C	1.870	10	112710001
11271A	40	20	6	M	1.870	10	112710002
11271A	40	20	6	F	1.870	10	112710003
11271A	40	20	6	VF	1.870	10	112710004

	Ø mm	h mm	S mm	P	Ft		
11271B	60	30	6	C	2.060	10	112710011
11271B	60	30	6	M	2.060	10	112710012
11271B	60	30	6	F	2.060	10	112710013
11271B	60	30	6	VF	2.060	10	112710014

	Ø mm	h mm	S mm	P	Ft		
11271C	80	50	6	C	2.320	10	112710021
11271C	80	50	6	M	2.320	10	112710022
11271C	80	50	6	F	2.320	10	112710023
11271C	80	50	6	VF	2.320	10	112710024

11276A÷11276C

lamellás/nemszított csapos korongok,
felváltva csiszolóvásznon és korundos műszál lamellák

Ø 40 mm

szár Ø 6 mm



	Ø mm	h mm	S mm	P	Ft		
11276A	40	20	6	M/60	2.110	10	112760006
11276A	40	20	6	M/80	2.110	10	112760008
11276A	40	20	6	M/120	2.110	10	112760012

	Ø mm	h mm	S mm	P	Ft		
11276B	60	30	6	M/60	2.210	10	112760016
11276B	60	30	6	M/80	2.210	10	112760018
11276B	60	30	6	M/120	2.210	10	112760022

	Ø mm	h mm	S mm	P	Ft		
11276C	80	50	6	M/60	2.630	10	112760036
11276C	80	50	6	M/80	2.630	10	112760038
11276C	80	50	6	M/120	2.630	10	112760042



11300A÷11300G

korondos csiszológépek, furatos

Ø 165 x 30 mm

EN 13743

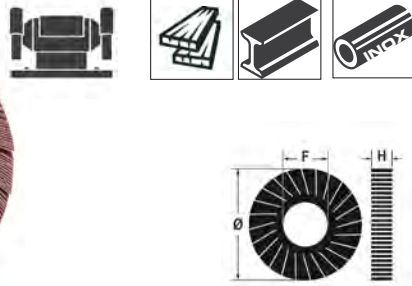

	Ø mm	H mm	P	F mm	Ft		
11300A	165	30	40	54	7.710	3	113000004
11300A	165	30	60	54	7.860	3	113000006
11300A	165	30	80	54	8.160	3	113000008
11300A	165	30	120	54	9.180	3	113000012
11300A	165	30	180	54	9.580	3	113000018
11300A	165	30	220	54	10.000	3	113000022
<hr/>							
	Ø mm	H mm	P	F mm	Ft		
11300B	165	50	40	54	10.650	2	113000104
11300B	165	50	60	54	11.250	2	113000106
11300B	165	50	80	54	11.600	2	113000108
11300B	165	50	120	54	12.550	2	113000112
11300B	165	50	180	54	14.050	2	113000118
11300B	165	50	220	54	15.000	2	113000122
<hr/>							
	Ø mm	H mm	P	F mm	Ft		
11300C	200	30	40	54	9.250	3	113000204
11300C	200	30	60	54	9.690	3	113000206
11300C	200	30	80	54	10.500	3	113000208
11300C	200	30	120	54	11.050	3	113000212
11300C	200	30	180	54	12.000	3	113000218
<hr/>							
	Ø mm	H mm	P	F mm	Ft		
11300D	200	50	40	54	12.650	2	113000304
11300D	200	50	60	54	13.900	2	113000306
11300D	200	50	80	54	14.800	2	113000308
11300D	200	50	120	54	16.400	2	113000312
11300D	200	50	180	54	17.800	2	113000318
11300D	200	50	220	54	19.200	2	113000322
<hr/>							
	Ø mm	H mm	P	F mm	Ft		
11300E	250	30	40	100	16.350	3	113000404
11300E	250	30	60	100	17.350	3	113000406
11300E	250	30	80	100	17.800	3	113000408
11300E	250	30	120	100	18.850	3	113000412
<hr/>							
	Ø mm	H mm	P	F mm	Ft		
11300F	250	50	40	100	23.650	2	113000504
11300F	250	50	60	100	24.000	2	113000506
11300F	250	50	80	100	24.600	2	113000508
11300F	250	50	120	100	25.650	2	113000512
11300F	250	50	180	100	30.150	2	113000518
11300F	250	50	220	100	33.050	2	113000522
<hr/>							
	Ø mm	H mm	P	F mm	Ft		
11300G	300	50	40	100	31.550	2	113000604
11300G	300	50	60	100	33.050	2	113000606
11300G	300	50	80	100	33.950	2	113000608

11320

nemszött furatos csiszológépek,
korund és műszálas anyag

Ø 200 x 50 mm

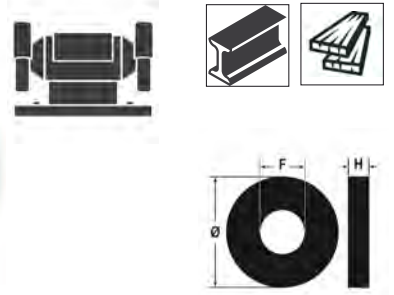

	Ø mm	H mm	P	F mm	Ft		
11320	200	50	C	76,2	9.580	2	113200006
11320	200	50	M	76,2	9.580	2	113200008
11320	200	50	F	76,2	9.580	2	113200012
11320	200	50	VF	76,2	9.580	2	113200024

11411

korondos dörzskorongok szatináló gépekhez

Ø 100 x 100 mm

EN 13743

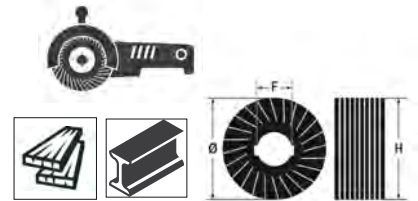

	Ø mm	H mm	P	F mm	Ft		
11411	100	100	40	19,1	8.040	2	114110004
11411	100	100	60	19,1	8.900	2	114110006
11411	100	100	80	19,1	9.260	2	114110008
11411	100	100	120	19,1	9.550	2	114110012
11411	100	100	240	19,1	9.610	2	114110024

11415B

nemszött lamellák
korund műszállal szatináló gépekhez

Ø 100 x 100 mm

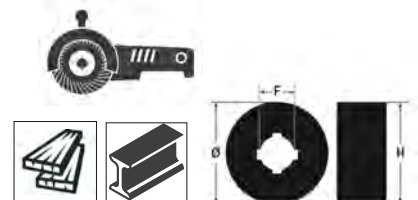

	Ø mm	H mm	P	F mm	Ft		
11415B	100	100	C	19,1	6.830	2	114150106
11415B	100	100	M	19,1	6.830	2	114150108
11415B	100	100	F	19,1	6.830	2	114150112
11415B	100	100	VF	19,1	6.830	2	114150124

11420B

lamellás/nemszött korongok szatináló gépekhez,
felváltva csiszolóvászon és korundos műszál

Ø 100 x 100 mm

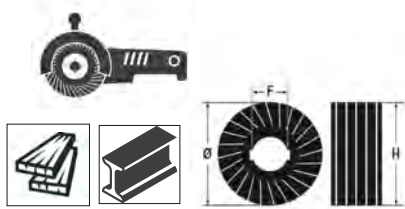

	Ø mm	H mm	P	F mm	Ft		
11420B	100	100	C/60	19,1	7.350	2	114200106
11420B	100	100	M/80	19,1	7.350	2	114200108
11420B	100	100	F/120	19,1	7.350	2	114200112
11420B	100	100	VF/240	19,1	7.350	2	114200124

11431

nemszött radiális csiszolókorongok,
korundos műszál

Ø 115 mm

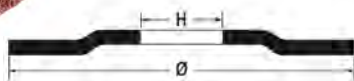

	Ø mm	P	F mm	Ft		
11431	115	C	22,23	4.270	4	114310006
11431	115	M	22,23	4.270	4	114310008
11431	115	F	22,23	4.270	4	114310012
11431	115	VF	22,23	4.270	4	114310024

11435

lamellás/nemszött radiális csiszolókorongok,
felváltva csiszolóvászon és korundos műszál

Ø 115 mm

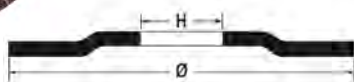

	Ø mm	P	F mm	Ft		
11435	115	M/80	22,23	5.010	4	114350008
11435	115	M/120	22,23	5.010	4	114350012
11435	115	F/150	22,23	5.010	4	114350015
11435	115	F/180	22,23	5.010	4	114350018

11440A÷11440C

cirkónium szövetes fibertárcsák

Ø 115 mm

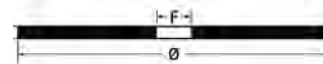

	Ø mm	P	F mm	Ft		
11440A	115	24	22	365	25	114400024
11440A	115	36	22	365	25	114400036
11440A	115	60	22	335	25	114400060
11440A	115	120	22	335	25	114400120

	Ø mm	P	F mm	Ft		
11440B	125	24	22	435	25	114400224
11440B	125	36	22	435	25	114400236
11440B	125	60	22	400	25	114400260
11440B	125	120	22	400	25	114400320

	Ø mm	P	F mm	Ft		
11440C	180	24	22	675	25	114400424
11440C	180	36	22	675	25	114400436
11440C	180	60	22	640	25	114400460
11440C	180	120	22	640	25	114400520

11450A÷11450C

korund szövetes fibertárcsák

Ø 115 mm



	Ø mm	P	F mm	Ft		
11450A	115	24	22	260	25	114500024
11450A	115	36	22	260	25	114500036
11450A	115	60	22	250	25	114500060
11450A	115	120	22	250	25	114500120

	Ø mm	P	F mm	Ft		
11450B	125	24	22	300	25	114500224
11450B	125	36	22	300	25	114500236
11450B	125	60	22	300	25	114500260
11450B	125	120	22	300	25	114500320

	Ø mm	P	F mm	Ft		
11450C	180	24	22	435	25	114500424
11450C	180	36	22	435	25	114500436
11450C	180	60	22	420	25	114500460
11450C	180	120	22	420	25	114500520

11488PF

rögzítőbetét fibertárcsákhoz M14 gyűrűsanyával



	Ø mm	Ft		
11488P	115	2.060	1	114880115
11488P	125	2.230	1	114880125
11488P	180	3.420	1	114880180

11491-11493-11495

korund csiszolóvászna végtelenített szalagok

h 38 mm x 50 m



	H mm	L m	P	Ft		
11491	38	50	40	14.200	1	114910004
11491	38	50	60	13.950	1	114910006
11491	38	50	80	13.450	1	114910008
11491	38	50	100	13.450	1	114910010
11491	38	50	120	13.450	1	114910012
11491	38	50	150	13.450	1	114910015
11491	38	50	180	13.450	1	114910018
11491	38	50	220	13.450	1	114910022
11491	38	50	240	13.450	1	114910024
11491	38	50	320	13.450	1	114910032
11491	38	50	400	13.450	1	114910040

	H mm	L m	P	Ft		
11493	50	50	40	22.500	1	114930004
11493	50	50	60	20.200	1	114930006
11493	50	50	80	20.150	1	114930008
11493	50	50	100	19.150	1	114930010
11493	50	50	120	19.150	1	114930012
11493	50	50	150	19.150	1	114930015
11493	50	50	180	19.150	1	114930018
11493	50	50	220	19.150	1	114930022
11493	50	50	240	19.150	1	114930024
11493	50	50	320	19.150	1	114930032
11493	50	50	400	19.150	1	114930040

	H mm	L m	P	Ft		
11495	120	25	40	26.400	1	114950004
11495	120	25	60	25.750	1	114950006
11495	120	25	80	24.850	1	114950008
11495	120	25	100	24.250	1	114950010
11495	120	25	120	24.250	1	114950012
11495	120	25	180	24.250	1	114950018
11495	120	25	240	24.250	1	114950024
11495	120	25	400	24.250	1	114950040

11498

nemszőtt végtelenített szalag
korondos műszállal

h 100 mm x 10 m



	H mm	L m	P	Ft		
11498	100	10	M	11.900	1	114980008
11498	100	10	F	9.520	1	114980012
11498	100	10	VF	9.520	1	114980015
* 11498	100	10	UF	10.300	1	114980018



SARUZÓFOGÓ KÁBELSARUKHOZ

		Kábelcsatlakozás	Vágási mélység	Range (mm ²)	Felhasználás
1601/PC					Telefon- és adatátviteli kábelcsatlakozáshoz 4P/6P/8P
1602				0,75-6	Szigetelt kábelcsatlakozáshoz, könnyített kivitel
1602A				0-6	Szigetelt kábelcsatlakozáshoz, standard modell
1603				1,25-5,5	Nem szigetelt kábelcsatlakozáshoz, könnyített kivitel
1603A				0-8	Nem szigetelt zárt kábelcsatlakozáshoz, standard modell
1603B				0-8	Nem szigetelt nyitott kábelcsatlakozáshoz, standard modell
1606/2				0,14-10	Nagy teherbírású, henger alakú kábelcsatlakozáshoz
1606A				0,5-6 6-16	Henger alakú kábelcsatlakozáshoz
1606T				0,1-10	Henger alakú kábelcsatlakozáshoz, 4 oldalas krimpelés
1607				6,48 5,41 1,69	Nagy teherbírású, BNC koaxiális kábelcsatlakozáshoz RG 58, RG 59, RG 62, RG 71
1608				0,5-6	Szigetelt kábelcsatlakozáshoz, nyomásszabályozóval
1608A				0,75-6	Nagy teherbírású, szigetelt kábelcsatlakozáshoz
1609				0,5-2,5	Nem szigetelt kábelcsatlakozáshoz
1609A				0,5-6	Nagy teherbírású, nem szigetelt kábelcsatlakozáshoz
1609B				10-120	Nem szigetelt kábelcsatlakozáshoz



1601/PC

Saruzófogó telefonkábelcsatlakozáshoz



RJ11-RJ12-RJ45

Ft 25.100

2 016010011

1602

Saruzófogó szigetelt kábelcsatlakozáshoz, könnyített kivitel, műanyag szárral

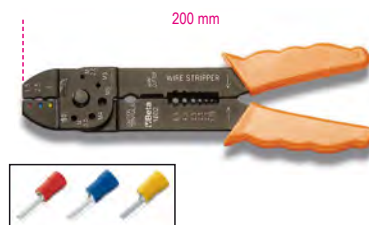

mm²
0,75-6

Ft 6.280

5 016020001

1602/C9

Könnyített saruzófogó 450 kábelcsatlakozással



1602/C9

Ft 42.950

1 016020045

1602

BM00180	R/6,3	n. 1
BM00280	B/6,3	50
BM00380	G/6,3	50
BM00191	R/6,3	50
BM00291	B/6,3	50
BM00392	G/6,3	50
BM00160	R/1,6	50
BM00260	B/2,3	50
BM00360	G/3,6	50

420x350x35 mm - 1,5 kg

1602A

Saruzófógó szigetelt kábelcsatlakozókhoz, standard modell, krómozott, műanyag szárral

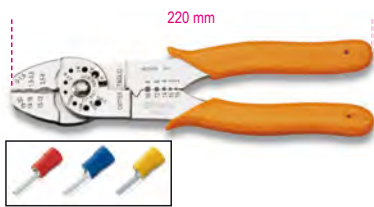

$\frac{mm^2}{mm^2}$	Ft	$\frac{mm^2}{mm^2}$	Ft
0÷6	22.950	2	016020005

1603

Saruzófógó nem szigetelt kábelcsatlakozókhoz, könnyített kivitel, műanyag szárral

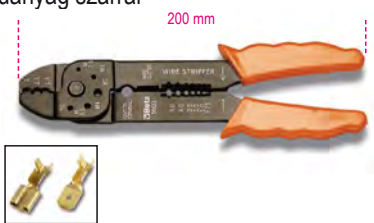

$\frac{mm^2}{mm^2}$	Ft	$\frac{mm^2}{mm^2}$	Ft
1,25÷5,5	6.280	5	016030001

1603A

Saruzófógó nem szigetelt kábelcsatlakozókhoz, önzáró modell

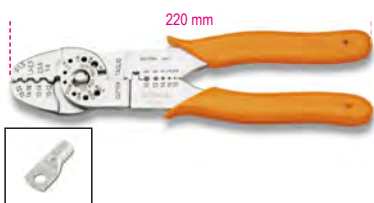

$\frac{mm^2}{mm^2}$	Ft	$\frac{mm^2}{mm^2}$	Ft
0÷8	22.950	2	016030005

1603B

Saruzófógó nem szigetelt kábelcsatlakozókhoz, nyitott modell, standard modell, krómozott, műanyag szárral

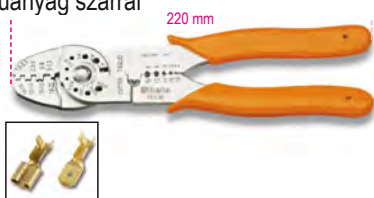

$\frac{mm^2}{mm^2}$	Ft	$\frac{mm^2}{mm^2}$	Ft
0÷8	22.500	2	016030010

1606/2

Áttételes saruzófógó szigetelt kábelcsatlakozókhoz



$\frac{mm^2}{mm^2}$	L	A	B	Ft	$\frac{mm^2}{mm^2}$	Ft
0,14÷10	175	65	20	153.000	1	016060002

1606A

Önzáró saruzófógó gyűrűs kábelcsatlakozókhoz



$\frac{mm^2}{mm^2}$	Ft	$\frac{mm^2}{mm^2}$	Ft
1606A6 0,5÷6	36.900	1	016060010
1606A16 6÷16	36.900	1	016060016

1606A/C9

Saruzófógó kábelcsatlakozókhoz 450 kábelcsatlakozóval, 0,5 mm²-6 mm²



$\frac{mm^2}{mm^2}$	Ft	$\frac{mm^2}{mm^2}$	Ft
1606A/C9	59.600	1	016060045

1606A6	n.	1
BM00601	W/0,5	50
BM00604	N/1,5	100
BM00506	B/2,5	100
BM00508	G/4	100
BM00610	Y/6	100

420x350x35 mm - 2,5 kg



1606T

saruzófógó cső csatlakozókhoz, 4 oldalú krimpelés

csökkentett erőfeszítés a karnál



$\frac{mm^2}{mm^2}$	L	A	B	Ft	$\frac{mm^2}{mm^2}$	Ft
0,1÷10	173	61	13	150.500	1	016060005

1607

Áttételes saruzófógó szigetelt kábelcsatlakozókhoz (RG 58, RG 59, RG 62, RG 71)



$\frac{mm^2}{mm^2}$	L	A	B	Ft	$\frac{mm^2}{mm^2}$	Ft
1607	220	73	19	118.600	1	016070001

1608

Saruzófógó szigetelt kábelcsatlakozókhoz, nyomásszabályzóval

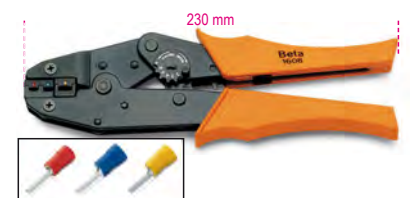

$\frac{mm^2}{mm^2}$	Ft	$\frac{mm^2}{mm^2}$	Ft
0,5÷6	50.950	1	016080001



1608/C9

Önzáró saruzófogó 450
kábelcsatlakozással, fémdobozban



1608/C9 Ft 87.600 1 016080045

1608		n.
BM00180	R/6,3	50
BM00280	B/6,3	50
BM00380	G/6,3	50
BM00191	R/6,3	50
BM00291	B/6,3	50
BM00392	G/6,3	50
BM00160	R/1,6	50
BM00260	B/2,3	50
BM00360	G/3,6	50

420x350x35 mm - 2 kg

1608A

Áttételes saruzófogó szigetelt
kábelcsatlakozáshoz



mm² 0,75÷6 Ft 93.200 1 016080005

Beta

1609

Automata saruzófogó
nem szigetelt kábelcsatlakozáshoz,
professzionális használatra



mm² 0,5÷2,5 Ft 46.700 1 016090001

1609A

Áttételes saruzófogó nem szigetelt
kábelcsatlakozáshoz csekély erőáfordítással



mm² 0,5÷6 Ft 181.400 1 016090005

1609B

Saruzófogó nem szigetelt kábelcsatlakozáshoz

Matricaméret:
10 mm -120 mm²



L mm 600 mm² 10÷120 Ft 123.200 1 016090101

1609C/C5

Saruzófogó kábelcsatlakozáshoz 5 matricával

Hatszögű crimpelő
25 mm²-240 mm²



mm² 50÷240 Ft 798.800 1 016090210

500x300x110 mm - 4 kg

1609M

Matricák a 1609C modellhez

Hatszögű crimpelő



	mm ²	Ft	n.
1609M/16	10-16	28.250	1 016090221
1609M/35	25-35	28.250	1 016090223
1609M/70	50-70	28.250	1 016090225
1609M/120	95-120	28.250	1 016090227
1609M/150	150	28.250	1 016090229
1609M/185	185	28.250	1 016090231
1609M/240	240	28.250	1 016090233

1639S

Nylon behúzószalag

Cserélhető fejek



L m 10 Ø mm 4 Ft 8.140 1 016390010



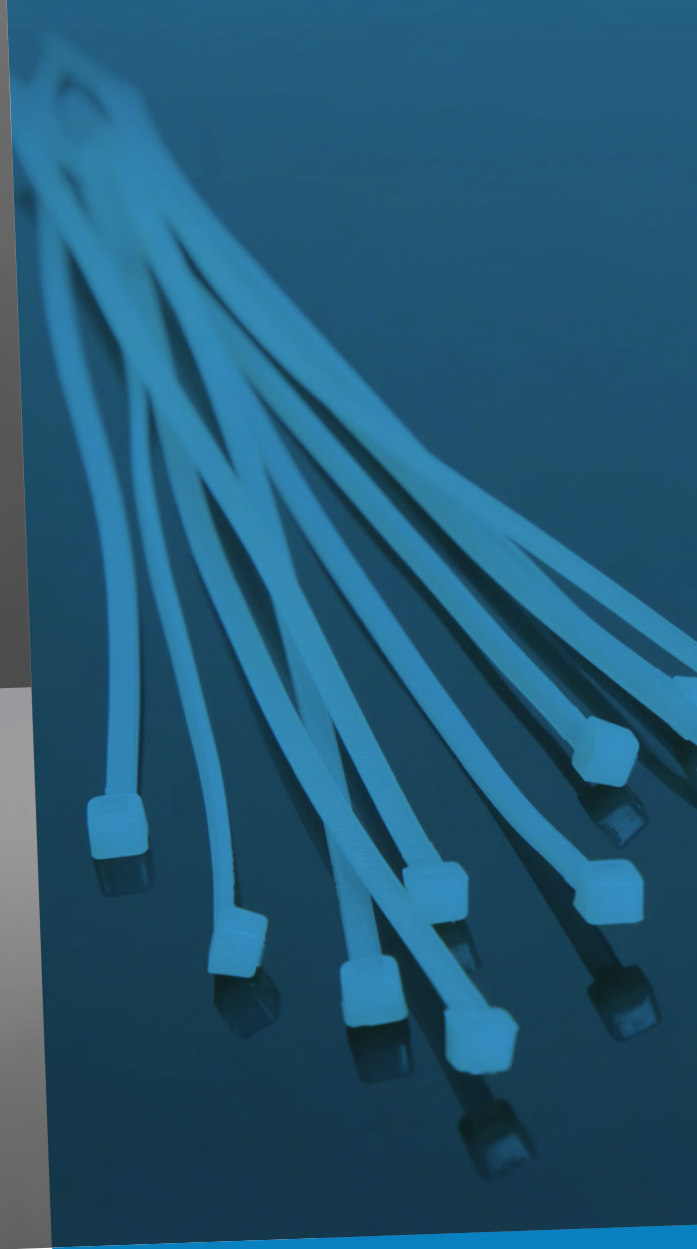
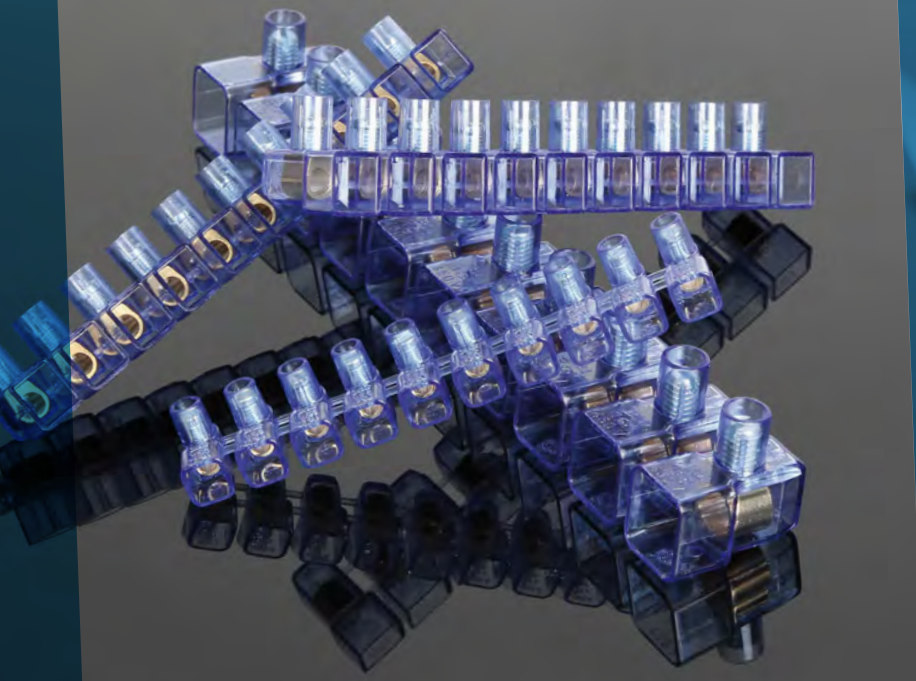

BM MÁRKANÉVEN KAPHATÓ TERMÉKEINK: KÁBELSARUK, KÁBELKÖTEGELŐK, SORKAPCSOK, SZIGETELŐSZALAGOK

A BM Csoport 1958 óta foglalkozik csatlakozóelemek és villamos rendszerekben alkalmazott termékek tervezésével, gyártásával és forgalmazásával.

A minőség, munkabiztonság és megbízhatóság mindig is a BM alapértékeihez tartozott. Ezek az értékek és a kiválóságra való törekvés tették lehetővé a társaság fejlődését, hogy lépésről lépésre a villamossági anyagok piacának kiemelt szereplőjévé váljon.

A BM Csoportot 2018-ban vásárolta meg a Beta Utensili. Ez a rész a Beta termékpalettáját kiegészítő, BM márkánév alatt forgalmazott speciális termékválasztékot mutatja be.

TANÚSÍTOTT MINŐSÉG



1610-B szigetelt gyűrűs kábelcsatlakozó

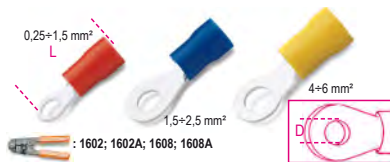

D mm	mm²	L mm	Ft	csomag	BM
4	0,25-1,5	20,6	2.290	100	BM00119
5	0,25-1,5	21,8	3.200	100	BM00125
5	1,5-2,5	22,4	3.550	100	BM00225
6	1,5-2,5	26	3.820	100	BM00231
8	1,5-2,5	29,8	4.800	100	BM00237
6	4-6	29,1	5.900	50	BM00331
8	4-6	34,5	8.030	50	BM00337

- Kérjük, a rendelésben ne a csomagok, hanem a kábelcsatlakozók számát adja meg
- Az árak 100 darabra vonatkoznak

1614-P szigetelt érvéghüvely



D mm	mm²	L mm	Ft	csomag	BM
1,9	0,25-1,5	19	2.680	100	BM00151
1,9	1,5-2,5	19	3.530	100	BM00251
2,7	4-6	28	6.380	50	BM00350

- Kérjük, a rendelésben ne a csomagok, hanem a kábelcsatlakozók számát adja meg
- Az árak 100 darabra vonatkoznak

1616-SM szigetelt hengeres kábelcsatlakozó



D mm	mm²	L mm	Ft	csomag	BM
4	0,25-1,5	21	3.460	100	BM00130

- Kérjük, a rendelésben ne a csomagok, hanem a kábelcsatlakozók számát adja meg
- Az árak 100 darabra vonatkoznak

1618-SF szigetelt hengeres hüvely



D mm	mm²	L mm	Ft	csomag	BM
3,8	0,25-1,5	23,5	4.360	100	BM00140

- Kérjük, a rendelésben ne a csomagok, hanem a kábelcsatlakozók számát adja meg
- Az árak 100 darabra vonatkoznak

1620-M szigetelt gyorskötésű kábelcsatlakozó

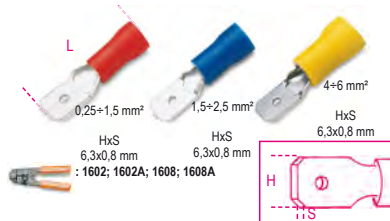

HxS mm	mm²	L mm	Ft	csomag	BM
6,3x0,8	0,25-1,5	21	3.640	100	BM00180
6,3x0,8	1,5-2,5	21	3.810	100	BM00280
6,3x0,8	4-6	24,5	4.250	50	BM00380

- Kérjük, a rendelésben ne a csomagok, hanem a kábelcsatlakozók számát adja meg
- Az árak 100 darabra vonatkoznak

1622-F szigetelt gyorskötésű hüvely

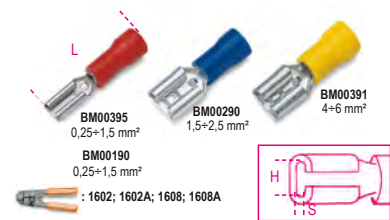

HxS mm	mm²	L mm	Ft	csomag	BM
6,3x0,8	0,25-1,5	20,7	3.550	100	BM00190
2,8x0,5	0,25-1,5	18,5	3.010	100	BM00395
6,3x0,8	1,5-2,5	20,7	3.500	100	BM00290
6,3x0,8	4-6	24,5	4.960	50	BM00391

- Kérjük, a rendelésben ne a csomagok, hanem a kábelcsatlakozók számát adja meg
- Az árak 100 darabra vonatkoznak

1624-FI szigetelt gyorskötésű hüvely



HxS mm	mm²	L mm	Ft	csomag	BM
6,3x0,8	0,25-1,5	22	3.810	100	BM00191
6,3x0,8	1,5-2,5	22	3.900	50	BM00291
6,3x0,8	4-6	25	5.120	50	BM00392

- Kérjük, a rendelésben ne a csomagok, hanem a kábelcsatlakozók számát adja meg
- Az árak 100 darabra vonatkoznak

1628-C szigetelt kábelcsatlakozók

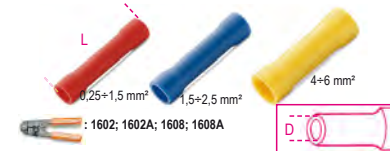

D mm	mm²	L mm	Ft	csomag	BM
1,8	0,25-1,5	25	2.850	100	BM00160
2,5	1,5-2,5	26,5	3.700	100	BM00260
3,7	4-6	27	5.710	50	BM00360

- Kérjük, a rendelésben ne a csomagok, hanem a kábelcsatlakozók számát adja meg
- Az árak 100 darabra vonatkoznak

1630-CR gyorscsatlakozók



mm²	L mm	Ft	csomag	BM
0,25-1	15,3	3.090	500	BM00110
1,25-2,5	15,9	3.100	500	BM00210

- Kérjük, a rendelésben ne a csomagok, hanem a kábelcsatlakozók számát adja meg
- Az árak 100 darabra vonatkoznak

1632-TS kábelcsatlakozó



mm²	L mm	Ft	csomag	BM
0,5	14	605	500	BM00601
0,75	14	605	500	BM00602
1	14	605	500	BM00603
1,5	14	605	500	BM00604
2,5	14	805	250	BM00506
4	17	1.170	200	BM00508
6	20	1.550	100	BM00610
0,5	14	405	500	BM00501
0,75	14	405	500	BM00502
1	14	405	500	BM00503
1,5	14	405	500	BM00504
6	20	1.370	100	BM00510

- Kérjük, a rendelésben ne a csomagok, hanem a kábelcsatlakozók számát adja meg
- Az árak 100 darabra vonatkoznak

1634-TD kétutas kábelcsatlakozó



mm²	L mm	Ft	csomag	BM
2x0,5	15	1.170	200	BM00651
2x0,75	15	1.120	200	BM00652
2x1	15	1.120	200	BM00654
2x1,5	16	1.060	200	BM00656
2x2,5	18,5	1.330	100	BM00558
2x4	23	3.220	100	BM00560
2x6	26	4.360	50	BM00661
2X0,5	15	1.040	200	BM00551
2X0,75	15	1.040	200	BM00552
2X1	15	1.050	200	BM00554
2X1,5	16	1.110	200	BM00556
2X6	26	4.910	50	BM00561

- Kérjük, a rendelésben ne a csomagok, hanem a kábelcsatlakozók számát adja meg
- Az árak 100 darabra vonatkoznak





1635-D

többszörös polipropilén sorkapocs, 12 pólusú

Szigetelő borítás: természetes polipropilén (PP)

Vezető: sárgaréz

Rögzítőcsavar: galvanizált acél

Önkioltás: EN 60335-1: 2002+A2:2006 (30.2.3. bek.), EN 60695-

2-10 850 °C-on, EN 60695-2-11

Üzemi hőmérséklet: max. 85°C

Védelmi fokozat: IP20

Referencia szabvány: EN 60998-1: 2004, EN 60998-2-1: 2004,

EN 60335-1: 2002 + A2: 2006 (30.2.3. bek.), IEC/EN 60695-2-11

CE



mm ²	L mm	L1 mm	mm ²	Ft	☎	🏠
16	93,7	14,7	2,5	390	50	BM9200
20,5	116,5	17,2	4	430	50	BM9201
23,5	139,5	20,1	6	625	50	BM9202
25,3	175,5	22,5	16	1.110	25	BM9203
35,2	228	33,5	25	3.010	10	BM9204

1635-S

zárt végű sorkapocs, szabadon álló csatlakozókhoz

Szigetelő borítás: átlátszó polikarbonát UL94 V0

Vezető: réz

Csavar: horganyzott acél

Lángállóság: EN60695-2-10 a 850°C, EN 60335-1:2002

+A2:2006, EN60695-2-11

Működési hőmérséklet: max. 85 °C

Védelmi fokozat: IP20

Referencia szabványok: EN60998-1: EN60998-2-1:2004

CE



mm ²	L mm	L1 mm	S mm	mm ²	N	Ft	☎	🏠
1.5	15	7.5	14.5	1.5	2	280	10	BM991
					1 2÷3			
					0.75 2÷4			
2.5	17.5	9	18.2	2.5	2	300	10	BM992
					1.5 2÷3			
					1 2÷4			
4	21	10.3	20	4	2	385	10	BM9924
					2.5 2÷3			
					1.5 2÷4			
6	22.5	11.8	23	6	2	445	10	BM993
					4 2÷3			
					2.5 2÷4			
10	26	14.7	26	10	2	1.030	10	BM994
					6 2÷3			
					4 2÷4			
16	31.8	18.8	32.2	16	2	2.150	10	BM995
					10 2÷3			
					6 2÷4			

1635-S

CE



mm ²	L mm	L1 mm	S mm	mm ²	N	Ft	☎	🏠
25	36.3	22.5	41.9	25	2	990	25	BM9960
					16 2÷3			
					10 2÷4			
35	43.5	26.1	49.4	35	2	1.270	25	BM9961
					25 2÷3			
					16 2÷4			



1748-BV2

műanyag kabelkötegelő szalag, natúr

Anyag: poliamid PA 6.6

Lángállóság: osztály: UL 94-V2

Működési hőmérséklet-tartomány: -40 °C + 85 °C

Legkisebb szerelési hőmérséklet: -10 °C

Vegyszerállóság: Bázisoknak, olajoknak, zsíroknak, klórid

tartalmú oldószereknek jól ellenáll. Savakkal szemben

korlátozottan ellenáll. Fenollokkal szemben nem ellenálló

Referencia szabványok: EN 62275:2015-02

Besorolás: type 1 (EN); type 21 (UL)

CE



A mm	L mm	Ø MAX mm	F MAX N	Ft	☎	🏠
2.5	80	14	80	305	100	BMB0824
2.5	100	20.5	80	295	100	BMB1025
2.5	120	27	80	430	100	BMB1225
2.5	160	40	80	610	100	BMB1625
2.5	200	52.5	80	665	100	BMB2025
3.6	140	33	180	750	100	BMB1436
3.6	200	52.5	180	1.020	100	BMB2036
3.6	300	106	180	1.440	100	BMB2936
3.6	370	105	180	2.030	100	BMB3736
4.6	120	24	220	970	100	BMB1248
4.6	160	36	220	1.020	100	BMB1648
4.8	188	46	220	1.290	100	BMB1948
4.8	200	50	220	1.260	100	BMB2048
4.8	250	65	220	1.810	100	BMB2548
4.8	300	81	220	1.890	100	BMB3048
4.8	370	103.5	220	2.360	100	BMB3748
4.8	390	110	220	2.930	100	BMB3948
4.8	430	122.5	220	3.670	100	BMB4348
4.8	530	160	220	6.110	100	BMB5348
7.6	150	24	550	3.040	100	BMB1576
7.6	200	51	550	3.160	100	BMB2076
7.6	300	83	550	3.900	100	BMB2976
7.6	370	103.5	550	4.740	100	BMB3776
7.6	450	130.5	550	7.280	100	BMB4576
7.6	540	159	550	9.240	100	BMB5476
7.6	750	226	550	16.700	100	BMB7576
8.8	550	163.5	800	9.870	100	BMB5390
8.8	710	195	800	13.250	100	BMB7190
8.8	780	235.5	800	14.800	100	BMB7890
9.0	430	130.5	800	7.810	100	BMB4390
9.0	810	245	800	16.650	100	BMB8190
9.0	1020	295	800	24.850	100	BMB1090
9.0	1220	375.5	800	29.500	100	BMB1290
9.0	1530	460	800	39.250	100	BMB1590

- Kérjük, a rendelésben ne a csomagok, hanem a

kabelkötegelő szalagok számát adja meg

- Az árak 100 darabra vonatkoznak



1748V

műanyag kabelkötegelő szalag, zöld

Anyag: poiamid PA 6.6

Lángállóság: osztály: UL 94-V2

Működési hőmérséklet tartomány: -40°C ÷ +85°C

Legkisebb szerelési hőmérséklet: -10°C

Vegyszerállóság: bázisoknak, olajoknak, zsíroknak, klórid

tartalmú oldószereknek jól ellenáll. Savakkal szemben

korlátozottan ellenáll. Fenollokkal szemben nem ellenálló

Referencia szabvány: EN 62275:2015-02

Besorolás: type 1 (EN); type 21 (UL)

CE



A mm	L mm	Ø MAX mm	F MAX N	Ft	☎	🏠
2.5	100	20.5	80	340	100	BMV1025
3.6	140	33	180	905	100	BMV1436
4.8	200	50	220	1.520	100	BMV2048
4.8	300	81	220	2.260	100	BMV3048

- Kérjük, a rendelésben ne a csomagok, hanem a

kabelkötegelő szalagok számát adja meg

- Az árak 100 darabra vonatkoznak.

1748N

műanyag kabelkötegelő szalag, fekete

UV-álló

Anyag: poliamid PA 6.6 + korom

Lángállóság: osztály: UL 94-V2

Működési hőmérséklet-tartomány: -40 °C + 85 °C

Legkisebb szerelési hőmérséklet: -10 °C

Vegyszerállóság: Bázisoknak, olajoknak, zsíroknak, klórid

tartalmú oldószereknek jól ellenáll. Savakkal szemben

korlátozottan ellenáll. Fenollokkal szemben nem ellenálló

Referencia szabványok: EN 62275:2015-02

Besorolás: type 1 (EN)

CE



A mm	L mm	Ø mm	F MAX N	Ft	☎	🏠
2.5	80	14	80	305	100	BMN0824
2.5	100	20.5	80	295	100	BMN1025
2.5	120	27	80	430	100	BMN1225
2.5	160	40	80	610	100	BMN1625
2.5	200	52.5	80	665	100	BMN2025
3.6	140	33	180	750	100	BMN1436
3.6	200	52.5	180	1.020	100	BMN2036
3.6	300	106	180	1.440	100	BMN2936
3.6	370	105	180	2.080	100	BMN3736
4.6	120	24	220	970	100	BMN1248
4.6	160	36	220	1.040	100	BMN1648
4.8	188	46	220	1.310	100	BMN1948
4.8	200	50	220	1.260	100	BMN2048
4.8	250	65	220	1.810	100	BMN2548
4.8	300	81	220	1.890	100	BMN3048
4.8	370	103.5	220	2.360	100	BMN3748
4.8	390	110	220	2.930	100	BMN3948
4.8	430	122.5	220	3.670	100	BMN4348
4.8	530	160	220	6.110	100	BMN5348
7.6	150	24	550	3.040	100	BMN1576
7.6	200	51	550	3.160	100	BMN2076
7.6	300	83	550	3.900	100	BMN2976
7.6	370	103.5	550	4.660	100	BMN3776
7.6	450	130.5	550	7.280	100	BMN4576
7.6	540	159	550	9.240	100	BMN5476
7.6	750	226	550	16.700	100	BMN7576
8.8	550	163.5	800	9.870	100	BMN5390
8.8	710	195	800	13.200	100	BMN7190
8.8	780	235.5	800	14.750	100	BMN7890
9.0	430	130.5	800	7.810	100	BMN4390
9.0	810	245	800	16.450	100	BMN8190
9.0	1020	295	800	25.050	100	BMN1090
9.0	1220	375.5	800	29.500	100	BMN1290
9.0	1530	460	800	39.250	100	BMN1590

- Kérjük, a rendelésben ne a csomagok, hanem a

kabelkötegelő szalagok számát adja meg

- Az árak 100 darabra vonatkoznak

1748-UL

műanyag kábelkötegelő szalag, nehéz terhekhez, fekete

UV- és ütésálló

Anyag: poliamid PA 6.6 + korom

Lángállósági osztály: UL 94-V2

Működési hőmérséklet-tartomány: -40 °C ÷ +85 °C

Legkisebb szerelési hőmérséklet: -10 °C

Vegyszerállóság: Bázisoknak, olajoknak, zsíroknak, klorid tartalmú oldószereknek jól ellenáll. Savakkal szemben korlátozottan ellenálló. Fenollokkal szemben nem ellenálló

Referencia szabvány: EN 62275:2015-02

Besorolás: type 1 (EN); type 21 (UL)

CE



A	L	Ø MAX	F MAX	Ft	📦	🏠
mm	mm	mm	N			
12.4	230	57	1200	7.900	100	BMN2412
12.4	480	136.5	1200	14.000	100	BMN4912
12.4	730	216.1	1200	18.350	100	BMN7412
12.4	880	263.9	1200	23.650	100	BMN8912
12.4	1000	305	1200	27.350	100	BMN1012

- Kérjük, a rendelésben ne a csomagok, hanem a kábelkötegelő szalagok számát adja meg
- Az árak 100 darabra vonatkoznak.

1748-N2D

műanyag kábelkötegelő szalag, fekete, UV-álló

Anyag: poliamid PA 6.6 + korom

Lángállósági osztály: UL 94-V2

Működési hőmérséklet-tartomány: -40 °C ÷ +85 °C

Legkisebb szerelési hőmérséklet: -10 °C

Vegyszerállóság: Bázisoknak, olajoknak, zsíroknak, klorid tartalmú oldószereknek jól ellenáll. Savakkal szemben korlátozottan ellenálló. Fenollokkal szemben nem ellenálló

Referencia szabvány: EN 62275:2015-02

Besorolás: type 1 (EN)

CE



A	L	Ø MAX	F MAX	Ft	📦	🏠
mm	mm	mm	N			
9.0	180	40	400	4.390	100	BMN1890
9.0	265	62	540	6.310	100	BMN2690
9.0	360	93	540	8.920	100	BMN3690

- Kérjük, a rendelésben ne a csomagok, hanem a kábelkötegelő szalagok számát adja meg
- Az árak 100 darabra vonatkoznak.

Beta

1748-BV0

önkioltó műanyag kábelkötegelő szalag, fehér

Anyag: poliamid PA 6.6

Lángállósági osztály: UL 94-V0

Működési hőmérséklet-tartomány: -40 °C ÷ +85 °C

Legkisebb szerelési hőmérséklet: -10 °C

Vegyszerállóság: Bázisoknak, olajoknak, zsíroknak, klorid tartalmú oldószereknek jól ellenáll. Savakkal szemben korlátozottan ellenálló. Fenollokkal szemben nem ellenálló

Referencia szabványok: EN 62275:2015-02

Besorolás: type 1 (EN)

CE V0

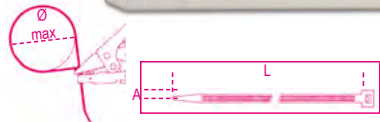

A	L	Ø MAX	F MAX	Ft	📦	🏠
mm	mm	mm	N			
2.5	100	20.5	80	455	100	BMB1025V0
3.6	150	36.0	180	955	100	BMB1536V0
3.6	200	52.5	180	1.430	100	BMB2036V0
4.8	200	49.5	230	1.620	100	BMB2048V0
4.8	300	81.0	230	2.430	100	BMB3048V0
4.8	370	106.7	230	3.420	100	BMB3848V0
7.6	370	106.7	540	6.540	100	BMB3876V0

- Kérjük, a rendelésben ne a csomagok, hanem a kábelkötegelő szalagok számát adja meg
- Az árak 100 darabra vonatkoznak

1748-BX

műanyag kábelkötegelő szalag, kék, fémdetektorral érzékelhető

Anyag: poliamid PA 6.6 + fémpor

Lángállósági osztály: UL 94-V2

Működési hőmérséklet-tartomány: -40 °C ÷ +85 °C

Legkisebb szerelési hőmérséklet: -10 °C

Vegyszerállóság: Bázisoknak, olajoknak, zsíroknak, klorid tartalmú oldószereknek jól ellenáll. Savakkal szemben korlátozottan ellenálló. Fenollokkal szemben nem ellenálló

Referencia szabványok: EN 62275:2015-02

Besorolás: type 1 (EN)

CE



A	L	Ø MAX	F MAX	Ft	📦	🏠
mm	mm	mm	N			
2.5	100	20.5	80	550	100	BMBX1025
3.6	150	36.0	180	1.230	100	BMBX1536
3.6	200	52.5	180	1.750	100	BMBX2036
4.8	200	49.5	230	2.240	100	BMBX2048
4.8	300	81.0	230	3.360	100	BMBX3048
4.8	370	106.7	230	4.770	100	BMBX3848
7.6	370	106.7	540	8.790	100	BMBX3876

- Kérjük, a rendelésben ne a csomagok, hanem a kábelkötegelő szalagok számát adja meg
- Az árak 100 darabra vonatkoznak

1748-BL

acélfogas műanyag kábelkötegelő szalag, natúr

Anyag: poliamid PA 6.6 + acél

Lángállósági osztály: UL 94-V2

Működési hőmérséklet-tartomány: -40 °C ÷ +85 °C

Legkisebb szerelési hőmérséklet: -10 °C

Vegyszerállóság: Bázisoknak, olajoknak, zsíroknak, klorid tartalmú oldószereknek jól ellenáll. Savakkal szemben korlátozottan ellenálló. Fenollokkal szemben nem ellenálló

Referencia szabványok: EN 62275:2015-02

Besorolás: type 1 (EN)

CE

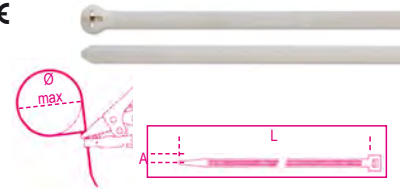

A	L	Ø MAX	F MAX	Ft	📦	🏠
mm	mm	mm	N			
2.5	100	20.5	180	1.320	100	BMBL1025
2.5	200	52.5	180	1.760	100	BMBL2025
3.6	140	33.0	250	2.410	100	BMBL1436
4.8	200	49.5	360	3.150	100	BMBL2048
4.8	300	81.0	360	4.240	100	BMBL3048
4.8	370	103.5	360	5.050	100	BMBL3748
7.6	370	103.5	780	9.030	100	BMBL3776

- Kérjük, a rendelésben ne a csomagok, hanem a kábelkötegelő szalagok számát adja meg
- Az árak 100 darabra vonatkoznak

1748-NL

acélfogas műanyag kábelkötegelő szalag, fekete, UV-álló

Anyag: poliamid PA 6.6 + acél + szénfekete

Lángállósági osztály: UL 94-V2

Működési hőmérséklet-tartomány: -40 °C ÷ +85 °C

Legkisebb szerelési hőmérséklet: -10 °C

Vegyszerállóság: Bázisoknak, olajoknak, zsíroknak, klorid tartalmú oldószereknek jól ellenáll. Savakkal szemben korlátozottan ellenálló. Fenollokkal szemben nem ellenálló

Referencia szabványok: EN 62275:2015-02

Besorolás: type 1 (EN)

CE



A	L	Ø MAX	F MAX	Ft	📦	🏠
mm	mm	mm	N			
2.5	100	20.5	180	1.320	100	BMNL1025
2.5	200	52.5	180	1.760	100	BMNL2025
3.6	140	33.0	250	2.170	100	BMNL1436
4.8	200	49.5	360	3.150	100	BMNL2048
4.8	300	81.0	360	4.280	100	BMNL3048
4.8	370	103.5	360	5.080	100	BMNL3748
7.6	370	103.5	780	8.860	100	BMNL3776

- Kérjük, a rendelésben ne a csomagok, hanem a kábelkötegelő szalagok számát adja meg
- Az árak 100 darabra vonatkoznak

Beta

Beta

1748-BR

újrahasználatos műanyag kábelkötegelő szalag, natúr

Anyag: poliamid PA 6.6
Lángállósági osztály: UL 94-V2
Működési hőmérséklet-tartomány: -40 °C + +85 °C
Legkisebb szerelési hőmérséklet: -10 °C
Vegyszerállóság: Bázisoknak, olajoknak, zsiroknak, klorid tartalmú oldószereknek jól ellenáll. Savakkal szemben korlátozottan ellenáll. Fenolokkal szemben nem ellenáll
Referencia szabványok: EN 62275:2015-02
Besorolás: type 1 (EN); type 21 (UL)

CE

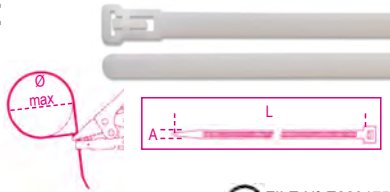

UL FILE N° E223175

A	L	Ø MAX	F MAX	Ft		
mm	mm	mm	N			
7.6	150	40	230	2.580	100	BMBR1576
7.6	200	55	230	2.810	100	BMBR2076
7.6	300	82	230	4.600	100	BMBR3076

- Kérjük, a rendelésben ne a csomagok, hanem a kábelkötegelő szalagok számát adja meg
- Az árak 100 darabra vonatkoznak

1748-BH

gyűrűs műanyag kábelkötegelő szalag, natúr

Anyag: poliamid PA 6.6
Lángállósági osztály: UL 94-V2
Működési hőmérséklet-tartomány: -40 °C + +85 °C
Legkisebb szerelési hőmérséklet: -10 °C
Vegyszerállóság: Bázisoknak, olajoknak, zsiroknak, klorid tartalmú oldószereknek jól ellenáll. Savakkal szemben korlátozottan ellenáll. Fenolokkal szemben nem ellenáll
Referencia szabványok: EN 62275:2015-02
Besorolás: type 1 (EN); type 21 (UL)

CE

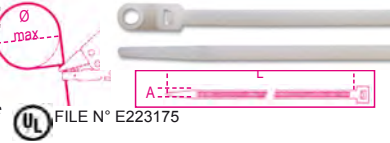

UL FILE N° E223175

A	L	Ø MAX	F MAX	Ft		
mm	mm	mm	N			
2.5	110	19.0	80	790	100	BMBH1125
4.8	200	49.8	230	1.570	100	BMBH2048
7.6	305	78.7	550	4.890	100	BMBH3076

- Kérjük, a rendelésben ne a csomagok, hanem a kábelkötegelő szalagok számát adja meg
- Az árak 100 darabra vonatkoznak

1748-BP

befűzős műanyag kábelkötegelő szalag, natúr

Anyag: poliamid PA 6.6
Lángállósági osztály: UL 94-V2
Működési hőmérséklet-tartomány: -40 °C + +85 °C
Legkisebb szerelési hőmérséklet: -10 °C
Vegyszerállóság: Bázisoknak, olajoknak, zsiroknak, klorid tartalmú oldószereknek jól ellenáll. Savakkal szemben korlátozottan ellenáll. Fenolokkal szemben nem ellenáll
Referencia szabványok: EN 62275:2015-02
Besorolás: type 1 (EN); type 21 (UL)

CE

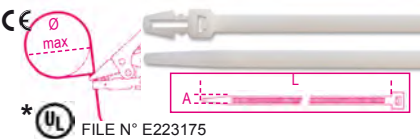

UL FILE N° E223175

A	L	Ø MAX	F MAX	Ft		
mm	mm	mm	N			
3.6	155	37.9	180	1.330	100	BMBP1536
4.8	200	50.8	230	2.380	100	BMBP2048

- Kérjük, a rendelésben ne a csomagok, hanem a kábelkötegelő szalagok számát adja meg
- Az árak 100 darabra vonatkoznak

1748-BT

keresztben feliratozható kábelkötegelő szalag, 25x8mm, natúr

Anyag: poliamid PA 6.6
Lángállósági osztály: UL 94-V2
Működési hőmérséklet-tartomány: -40 °C + +85 °C
Legkisebb szerelési hőmérséklet: -10 °C
Vegyszerállóság: Bázisoknak, olajoknak, zsiroknak, klorid tartalmú oldószereknek jól ellenáll. Savakkal szemben korlátozottan ellenáll. Fenolokkal szemben nem ellenáll
Referencia szabványok: EN 62275:2015-02
Besorolás: type 1 (EN); type 21 (UL)

CE

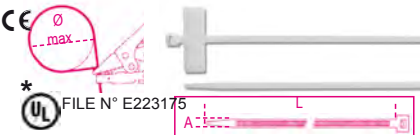

UL FILE N° E223175

A	L	Ø MAX	F MAX	Ft		
mm	mm	mm	N			
2.5	100	22.0	80	1.040	100	BMBT21025
2.5	200	53.5	80	1.670	100	BMBT22025

- Kérjük, a rendelésben ne a csomagok, hanem a kábelkötegelő szalagok számát adja meg
- Az árak 100 darabra vonatkoznak

1748-BT2

hosszában feliratozható kábelkötegelő szalag, 13x27mm, natúr

Anyag: poliamid PA 6.6
Lángállósági osztály: UL 94-V2
Működési hőmérséklet-tartomány: -40 °C + +85 °C
Legkisebb szerelési hőmérséklet: -10 °C
Vegyszerállóság: Bázisoknak, olajoknak, zsiroknak, klorid tartalmú oldószereknek jól ellenáll. Savakkal szemben korlátozottan ellenáll. Fenolokkal szemben nem ellenáll
Referencia szabványok: EN 62275:2015-02
Besorolás: type 1 (EN)

CE



UL FILE N° E223175

A	L	Ø MAX	F MAX	Ft		
mm	mm	mm	N			
4.8	190	51	230	1.890	100	BMBT12248

- Kérjük, a rendelésben ne a csomagok, hanem a kábelkötegelő szalagok számát adja meg
- Az árak 100 darabra vonatkoznak

1748-BT3

külön feliratozható kábelkötegelő szalag, 20x9mm, natúr

Anyag: poliamid PA 6.6
Lángállósági osztály: UL 94-V2
Működési hőmérséklet-tartomány: -40 °C + +85 °C
Legkisebb szerelési hőmérséklet: -10 °C
Vegyszerállóság: Bázisoknak, olajoknak, zsiroknak, klorid tartalmú oldószereknek jól ellenáll. Savakkal szemben korlátozottan ellenáll. Fenolokkal szemben nem ellenáll
Referencia szabványok: EN 62275:2015-02
Besorolás: type 1 (EN)

CE

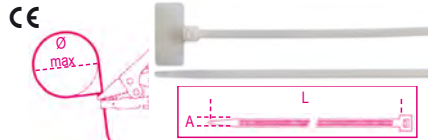

A	L	Ø MAX	F MAX	Ft		
mm	mm	mm	N			
2.5	110	22	80	1.090	100	BMBT11125

- Kérjük, a rendelésben ne a csomagok, hanem a kábelkötegelő szalagok számát adja meg
- Az árak 100 darabra vonatkoznak

1748-BA1

kábelkötegelő talp

Anyag: poliamid PA 6.6
Lángállósági osztály: UL 94-V2
Működési hőmérséklet-tartomány: -40 °C + +85 °C
Legkisebb szerelési hőmérséklet: -10 °C
Vegyszerállóság: Bázisoknak, olajoknak, zsiroknak, klorid tartalmú oldószereknek jól ellenáll. Savakkal szemben korlátozottan ellenáll. Fenolokkal szemben nem ellenáll



SxDxH	Ø	F	Ft		
mm	mm	mm			
15.2x9.4x6.8	3.3	3.6	1.330	100	BMB0905
22x16.2x10.8	5.2	9	3.010	100	BMB0906

- Kérjük, a rendelésben ne a csomagok, hanem a kábelkötegelő szalagok számát adja meg
- Az árak 100 darabra vonatkoznak

1748-NA1

kábelkötegelő talp

Anyag: poliamid PA 6.6
Lángállósági osztály: UL 94-V2
Működési hőmérséklet-tartomány: -40 °C + +85 °C
Legkisebb szerelési hőmérséklet: -10 °C
Vegyszerállóság: Bázisoknak, olajoknak, zsiroknak, klorid tartalmú oldószereknek jól ellenáll. Savakkal szemben korlátozottan ellenáll. Fenolokkal szemben nem ellenáll



SxDxH	Ø	F	Ft		
mm	mm	mm			
15.2x9.4x6.8	3.3	3.6	1.440	100	BMN0905
22x16.2x10.8	5.2	9	2.450	100	BMN0906

- Kérjük, a rendelésben ne a csomagok, hanem a kábelkötegelő szalagok számát adja meg
- Az árak 100 darabra vonatkoznak



1748-BA2

kábelkötegelő talp - kétirányról fűzhető

Anyag: poliamid PA 6.6

Lángállósági osztály: UL 94-V2

Működési hőmérséklet-tartomány: -40 °C ÷ +85 °C

Legkisebb szerelési hőmérséklet: -10 °C

Vegyszerállóság: Bázisoknak, olajoknak, zsíroknak, klorid tartalmú oldószereknek jól ellenáll. Savakkal szemben korlátozottan ellenálló. Fenollokkal szemben nem ellenálló

CE

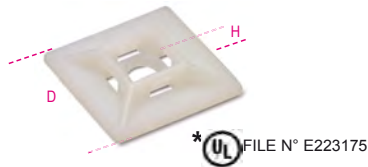

SxDxH mm	F mm	Ft		
19x19x5.4	3.6	1.720	100	BMB0901
* 28x28x7	4.8	2.500	100	BMB0902
* 28x28x5.8	4.8	2.450	100	BMB0903

1748-NA2

kábelkötegelő talp - kétirányról fűzhető
UV-álló

Anyag: poliamid PA 6.6

Lángállósági osztály: UL 94-V2

Működési hőmérséklet-tartomány: -40 °C ÷ +85 °C

Legkisebb szerelési hőmérséklet: -10 °C

Vegyszerállóság: Bázisoknak, olajoknak, zsíroknak, klorid tartalmú oldószereknek jól ellenáll. Savakkal szemben korlátozottan ellenálló. Fenollokkal szemben nem ellenálló

CE



SxDxH mm	F mm	Ft		
19x19x5.4	3.6	1.780	100	BMN0901
* 28x28x7	4.8	2.500	100	BMN0902
* 28x28x5.8	4.8	2.210	100	BMN0903

- Kérjük, a rendelésben ne a csomagok, hanem a kábelkötegelő szalagok számát adja meg
- Az árak 100 darabra vonatkoznak

1748-S

önzáró rozsdamentes acél kábelkötegelő szalag

Anyag: rozsdamentes acél AISI 304

Záró mechanizmus: fémgolyó

Lángállósági osztály: nem gyúlékony

Légtechnikai besorolás: AH-1

Kiváló UV ellenállás

Működési hőmérséklet-tartomány: -60 °C ÷ +300 °C

Legkisebb szerelési hőmérséklet: -60 °C

Vegyszerállóság: kiváló

Referencia szabványok: EN 62275:2015-02

Besorolás: type 2 (EN); type 2 (UL)

CE

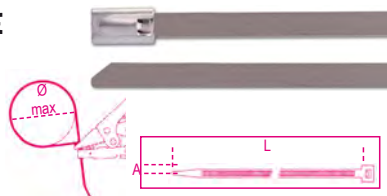

A mm	L mm	ØMAX mm	Trazione N	Ft		
4.6	125	38	890	10.500	100	BMS1345
4.6	200	61.9	890	10.800	100	BMS2045
7.9	200	61.9	1500	11.350	100	BMS2079
4.6	290	90.6	890	11.150	100	BMS3045
7.9	300	90.6	1500	13.250	100	BMS3079
4.6	360	112.8	890	12.200	100	BMS3745
7.9	360	112.8	1500	15.250	100	BMS3779
7.9	520	163.8	1500	18.850	100	BMS5079
4.6	520	163.8	890	13.900	100	BMS5245
4.6	680	214.8	890	15.050	100	BMS6845
7.9	680	214.8	1500	23.200	100	BMS6879
4.6	840	265.7	890	16.250	100	BMS8445
7.9	840	265.7	1500	27.000	100	BMS8479

1748-SC

önzáró rozsdamentes acél kábelkötegelő szalag

fekete poliészter bevonatú

Anyag: rozsdamentes acél AISI 304 + poliészter

Záró mechanizmus: fémgolyó

Lángállósági osztály: nem gyúlékony

Légtechnikai besorolás: AH-1

Kiváló UV ellenállás

Működési hőmérséklet-tartomány: -60 °C ÷ +300 °C

Legkisebb szerelési hőmérséklet: -60 °C

Vegyszerállóság: kiváló

Referencia szabványok: EN 62275:2015-02

Besorolás: type 2 (EN); type 2 (UL)

CE

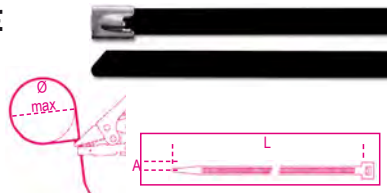

A mm	L mm	ØMAX mm	Trazione N	Ft		
4.6	125	38	450	13.650	100	BMSC1345
4.6	200	61.9	450	15.900	100	BMSC2045
7.9	200	61.9	800	16.000	100	BMSC2079
4.6	290	90.6	450	17.700	100	BMSC3045
7.9	300	90.6	800	19.000	100	BMSC3079
4.6	360	112.8	450	19.400	100	BMSC3745
7.9	360	112.8	800	21.400	100	BMSC3779
7.9	520	163.8	800	26.650	100	BMSC5079
4.6	520	163.8	450	20.100	100	BMSC5245
4.6	680	214.8	450	22.550	100	BMSC6845
7.9	680	214.8	800	30.400	100	BMSC6879
4.6	840	265.7	450	23.800	100	BMSC8445
7.9	840	265.7	800	36.950	100	BMSC8479

1748-BV

Tépfózas kábelkötegelő szalag, fehér

Anyag: polietilén-poliamid (PE-PA)

Működési hőmérséklet tartomány: -20 °C ÷ +60 °C

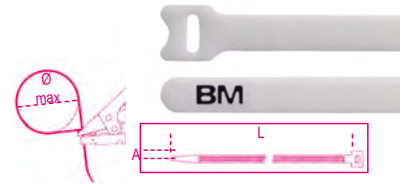

A mm	L mm	Ø MAX mm	F MAX N	Ft		
12,7	229	55	180	33.500	10	BMBV2312
19	229	55	220	38.450	10	BMBV2319

- Kérjük, a rendelésben ne a csomagok, hanem a kábelkötegelő szalagok számát adja meg
- Az árak 100 darabra vonatkoznak.

1748-NV

Tépfózas kábelkötegelő szalag, fekete

Anyag: polietilén-poliamid (PE-PA)

Működési hőmérséklet tartomány: -20 °C ÷ +60 °C

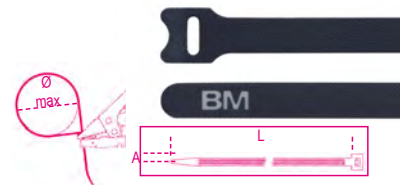

A mm	L mm	Ø MAX mm	F MAX N	Ft		
12,7	229	55	180	50.300	10	BMNV2312

- Kérjük, a rendelésben ne a csomagok, hanem a kábelkötegelő szalagok számát adja meg
- Az árak 100 darabra vonatkoznak.

1743

Kábelkötegelő fogó



	Ft		
1743	22.500	1	017430001

1743T

Kábelkötegelő fogó

• Alkalmos vékony kábelek vágására is
(3x1.5mm²; 1x17mm²)



	Ft		
1743T	12.850	1	017430100

Beta

Beta

Quality Tools

1748-N

kábelkötöző szerszám 2,5-4,8 mm széles műanyag kábelkötegelő szalaghoz
A beállított húzóerő elérésekor automatikusan levág.
Húzóerő szabályozóval.

Anyag: polimer és üvegszál test, fém belső részek

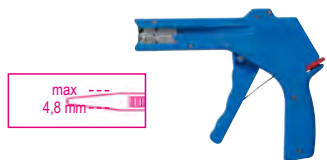

max.
4,8 mm

Ft 14.000 1 BM1100

1748-N

1748-ST

automata kábelkötegelő, 4,6-9 mm széles rozsdamentes acél kábelkötegelő szalagokhoz,
automatikus feszítéssel és vágásszabályozással



Ft 44.750 1 BM1105

1748-ST

1638M

vékony falú zsugorcso dobozban

Zsugorodási arány: 2:1

Anyag: polietilén

Működési hőmérséklet tartomány: -55°C ÷ +125°C

Zsugorodási hőmérséklet: +70°C ÷ +110°C

Maximum VRMS: 600V

A hüvely önkilóttási foka: lángálló VW-1 (UL 1581)

Halogénmentes



Ø1 Ø2

L mm	Ø1 mm	Ø2 mm	Ft	csomagolás	BM kód
1,6	12	2,0+0,-0,30,85	4.320	1	BMGBS016MNE
2,4	11	3,00+0,-0,31,25	4.320	1	BMGBS024MNE
3,2	11	3,5+0,-0,4 1,5	4.320	1	BMGBS032MNE
4,8	10	5,5+0,-0,4 2,5	4.320	1	BMGBS048MNE
6,4	9	6,5+0,-0,4 3	4.320	1	BMGBS064MNE
9,5	7	9,5+0,-0,5 4,5	4.320	1	BMGBS095MNE
12,7	6	13,5+0,-0,5 6,5	4.320	1	BMGBS127MNE
19	5	21+0,-0,5 10	4.410	1	BMGBS190MNE
25,4	3,5	26,0+0,-0,5 12,5	4.490	1	BMGBS254MNE

Beta
Quality Tools

1639ESB

PVC szigetelőszalag

Működési hőmérséklet-tartomány: 0-90°C

Szakítószilárdság: 28N/cm, ami 18,6 N/mm²-nek felel meg

Nyúlás: 200%

Tapadás acélhoz: 2,2N/cm

Öntapadás: 2 N/cm

Dielektromos (átütési) szilárdság: 45kV/mm

Gyúlékonyság: lángálló

Referencia szabvány: IEC 60454-2

Besorolás: CEI EN 60454-3-1-5/F-PVCP/90



S mm	A mm	L m	Ft	csomagolás	BM kód
0.15	15	10	200	10	BMESB1510BI
0.15	15	10	200	10	BMESB1510BL
0.15	15	10	200	10	BMESB1510GI
0.15	15	10	200	10	BMESB1510GR
0.15	15	10	205	10	BMESB1510GV
0.15	15	10	200	10	BMESB1510MA
0.15	15	10	200	10	BMESB1510NE
0.15	15	10	200	10	BMESB1510RO
0.15	15	10	200	10	BMESB1510VE
0.15	15	25	470	10	BMESB1525BI
0.15	15	25	470	10	BMESB1525BL
0.15	15	25	470	10	BMESB1525GI
0.15	15	25	470	10	BMESB1525GR
0.15	15	25	470	10	BMESB1525MA
0.15	15	25	470	10	BMESB1525NE
0.15	15	25	470	10	BMESB1525RO
0.15	15	25	470	10	BMESB1525VE
0.15	19	25	520	10	BMESB1925BI
0.15	19	25	520	10	BMESB1925BL
0.15	19	25	520	10	BMESB1925GI
0.15	19	25	520	10	BMESB1925GR
0.15	19	25	520	10	BMESB1925MA
0.15	19	25	520	10	BMESB1925NE
0.15	19	25	520	10	BMESB1925RO
0.15	19	25	520	10	BMESB1925VE
0.15	25	25	740	8	BMESB2525BI
0.15	25	25	740	8	BMESB2525BL
0.15	25	25	740	8	BMESB2525GI
0.15	25	25	740	8	BMESB2525GR
0.15	25	25	745	8	BMESB2525GV
0.15	25	25	740	8	BMESB2525MA
0.15	25	25	740	8	BMESB2525NE
0.15	25	25	740	8	BMESB2525RO
0.15	25	25	740	8	BMESB2525VE
0.15	50	25	1.270	4	BMESB5025NE

1639ESC

PVC szigetelőszalag

Működési hőmérséklet-tartomány: 0-80°C

Szakítószilárdság: 28N/cm, ami 18,6 N/mm²-nek felel meg

Nyúlás: 200%

Tapadás acélhoz: 2,2N/cm

Öntapadás: 2,2 N/cm

Dielektromos (átütési) szilárdság: 38kV/mm

Gyúlékonyság: lángálló

Referencia szabvány: ASTM-D-1000 ; UL510

Besorolás: CEI EN 60454-3-1-5/F-PVCP/90



S mm 0.18 A mm 19 L m 20 Ft 600 csomagolás 10 BMESC1920NE

1639ETA

PVC szigetelőszalag extrém hőmérsékletre

Működési hőmérséklet-tartomány: -18 ÷ +105 °C

Szakítószilárdság: 35N/cm, ami 19,4 N/mm²-nek felel meg

Nyúlás: 300%

Tapadás acélhoz: 3,1N/cm

Öntapadás: 2,7 N/cm

Dielektromos (átütési) szilárdság: 55,5kV/mm

Gyúlékonyság: lángálló

Referencia szabvány: ASTM-D-1000 ; UL510

Besorolás: CEI EN 60454-3-1-5/F-PVCP/90



S mm 0.18 A mm 19 L m 20 Ft 1.780 csomagolás 1 BMETA1920NE

1639EAB

EPR önvulkanizáló szigetelőszalag

Működési hőmérséklet-tartomány: -40 ÷ +90 °C

Szakítószilárdság: 2,4 N/mm²

Nyúlás: 750%

Dielektromos (átütési) szilárdság: 29,5kV/mm

Gyúlékonyság: lángálló

Referencia szabvány: ASTM-D-4388; ASTM-D-4325

Nedvességgel, korrózióval és vegyszerekkel szemben kiválóan ellenálló.



S mm 0.76 A mm 19 L m 9 Ft 4.170 csomagolás 1 BMEAB1909NE





BLISTER-VÁLASZTÉK (ÁRUHÁZI POLCCSOMAGOLÁS)

Saját üzletének belső rendszeréhez ajánljuk

- Jobb áttekinthetőség
- Hatékony bemutatás
- Vonalkód



Blister (tartó):

- nagy szakítószilárdságú PVC
- 4 méret a bemutató hely optimális kihasználása
- Rugalmas gumi rögzítés

42K



mm	Ft		
5,5x5,5	2.670	5	000429505
6x6	2.680	5	000429506
7x7	2.700	5	000429507
8x8	2.760	5	000429508
9x9	2.840	5	000429509
10x10	3.150	5	000429510
11x11	3.330	5	000429511
12x12	3.420	5	000429512
13x13	3.460	5	000429513
14x14	3.730	5	000429514
15x15	4.090	5	000429515
16x16	4.320	5	000429516
17x17	4.640	5	000429517
18x18	4.920	5	000429518
19x19	5.130	5	000429519
20x20	5.510	3	000429520
21x21	5.980	3	000429521
22x22	6.190	3	000429522
23x23	6.680	3	000429523
24x24	7.300	3	000429524
25x25	7.450	2	000429525
26x26	7.900	2	000429526
27x27	8.680	2	000429527
28x28	8.820	2	000429528
29x29	9.620	2	000429529
30x30	10.100	2	000429530
32x32	11.450	2	000429532

55K



mm	Ft		
6x7	1.740	5	000559012
8x9	1.840	5	000559021
10x11	1.960	5	000559030
10x12	2.560	5	000559033
10x13	2.760	5	000559035
12x13	2.200	5	000559042
12x14	2.890	5	000559045
13x17	3.450	5	000559051
14x15	2.770	5	000559054
14x17	3.720	5	000559057
16x17	3.160	5	000559060
17x19	4.130	2	000559063
18x19	3.730	2	000559066
19x22	4.760	2	000559069
20x22	4.230	2	000559075
21x23	4.640	2	000559078
22x24	5.130	2	000559081
24x26	5.310	2	000559087
24x27	5.750	2	000559090
25x28	6.040	2	000559096
27x29	6.930	2	000559099
27x30	7.800	2	000559102
30x32	7.610	2	000559108

90K



mm	Ft		
6x7	2.890	5	000909006
8x9	3.190	5	000909012
10x11	3.620	5	000909018
12x13	4.000	5	000909027
14x15	4.930	5	000909033
16x17	5.500	5	000909039
18x19	6.510	5	000909045
20x22	7.540	3	000909051
21x23	8.630	2	000909057
24x26	10.400	2	000909063
24x27	10.450	2	000909067

mm	Ft		
25x28	13.500	2	000909070
27x29	14.800	2	000909073
30x32	15.850	2	000909080

93K



mm	Ft		
21x22	16.200	3	000939021

94K



mm	Ft		
8x10	6.950	2	000949008
9x11	7.170	2	000949009
10x11	7.470	2	000949010
11x13	7.690	2	000949011
12x14	8.280	2	000949012
13x15	8.280	2	000949013
14x15	9.790	2	000949014
14x17	10.100	2	000949015
17x19	10.350	2	000949017
19x22	11.100	2	000949019
22x24	13.700	2	000949022
24x27	14.550	2	000949024
30x32	18.700	2	000949030

96/SC9



	Ft		
96/SC9	8.190	1	000960374

1,5-2-2,5-3-4-5-6-8-10 mm

96/ST6K



	Ft		
96/ST6K	5.380	3	000969370

2,5-3-4-5-6-8 mm

96N/ST6K



	Ft		
96N/ST6K	3.660	3	000969640

2,5-3-4-5-6-8 mm

96BPA/SC9



	Ft		
96BPA/SC9	19.200	1	000961974

1,5-2-2,5-3-4-5-6-8-10 mm

96BP-CL/SC9



	Ft		
96BP-CL/SC9	22.300	1	000961619

1,5-2-2,5-3-4-5-6-8-10 mm

96BPC/SC9



	Ft		
96BPC/SC9	17.550	1	000960354

1,5-2-2,5-3-4-5-6-8-10 mm

96C/AS



"	Ft		
1/16	695	20	000961702
3/32	965	20	000961706
1/8	1.020	20	000961710
5/32	1.190	20	000961714
3/16	1.350	20	000961716
7/32	1.510	20	000961718
1/4	1.680	20	000961720
5/16	1.880	10	000961724
3/8	2.250	10	000961728

96LBP/SC9



	Ft		
96LBP/SC9	20.100	1	000961354

1,5-2-2,5-3-4-5-6-8-10 mm

96/BGS7



96/BGS7	Ft	1	000960367
1,5-2-2,5-3-4-5-6 mm			

96/BG7



96/BG7	Ft	1	000960368
2,5-3-4-5-6-8-10 mm			

96TK



mm	Ft	1	000969934
2	4.770	5	000969934
2,5	4.770	5	000969935
3	4.880	5	000969936
4	5.040	5	000969938
5	5.140	5	000969940
6	5.940	5	000969941
8	7.460	3	000969943
10	8.470	3	000969945

97BTX/SC8



97BTX/SC8	Ft	1	000970164
T9-T10-T15-T20-T25-T27-T30-T40			

97BTXL/SC8



97BTXL/SC8	Ft	1	000970364
T9-T10-T15-T20-T25-T27-T30-T40			

111E



L mm	Ft	1	001110110
100	9.210	3	001110110
150	9.570	3	001110115
200	11.700	3	001110120
250	14.150	3	001110125
300	18.800	3	001110130
380	36.850	3	001110138
450	61.300	2	001110145
600	84.850	1	001110160

111EN



L mm	Ft	1	001110410
100	8.430	3	001110410
150	8.820	3	001110415
200	10.300	3	001110420
250	12.750	3	001110425
300	17.200	3	001110430
380	34.000	3	001110438
450	57.950	2	001110445

111ER

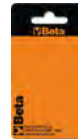

L mm	Ft	1	001110520
200	15.300	3	001110520
250	18.800	3	001110525
300	30.100	2	001110530



123/K4



123/K4	Ft	1	001230504
123Q1/4 123Q3/8 123Q1/2 123E1/4			

142K



mm	Ft	1	001429006
6	7.070	3	001429006
7	7.070	3	001429007
8	7.200	3	001429008
9	7.660	3	001429009
10	8.000	3	001429010
11	8.090	3	001429011
12	8.350	3	001429012
13	9.090	3	001429013
14	9.390	2	001429014
15	9.970	2	001429015
16	10.750	2	001429016
17	10.950	2	001429017
18	11.850	2	001429018
19	12.150	2	001429019
21	15.900	1	001429021
22	16.400	1	001429022
24	19.200	1	001429024

192/S2

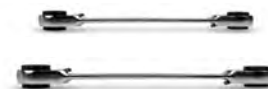

192/S2	Ft	1	001920070
8x10/12x13 mm 16x17/18x19 mm			

195K



mm	Ft	1	001959010
8x10	8.000	2	001959010
12x13	9.260	2	001959013
14x15	9.740	2	001959015
16x18	11.300	2	001959018
17x19	11.550	2	001959019

374K



374K	Ft	1	003749024
L mm 240			

850MQ



L	Ft	1	008500910
mm 233	9.420		

855P



L1	Ft	1	008550010
mm 240	29.350		

860/58K



L	Ft	1	008609884
mm 126	30.850		

860LP



SxA	Ft	5	
mm 0,5x3	770		008600005
0,6x4,5	770		008600010
0,8x5,5	770		008600015
1x5,5	770		008600020
1,2x6,5	770		008600025

860PH



PH	Ft	5	
0	770		008600220
1	770		008600225
2	770		008600230
3	770		008600245
4	1.110		008600250

860PZ



PZ	Ft	5	
1	770		008600320
2	770		008600325
3	770		008600330
4	1.110		008600335

860PE



mm	Ft	5	
2	825		008600101
2,5	825		008600102
3	825		008600103
4	825		008600104
5	825		008600105
6	825		008600106
8	1.030		008600108
10	1.030		008600110

860TX



mm	Ft	5	
T6	1.030		008600704
T7	1.030		008600705
T8	1.030		008600710
T9	1.030		008600715
T10	820		008600720
T15	820		008600725
T20	820		008600730
T25	820		008600735
T27	820		008600740
T30	820		008600745
T40	820		008600750

860RTX



mm	Ft	5	
T9	1.110		008600550
T10	1.110		008600555
T15	1.110		008600560
T20	1.110		008600565
T25	1.110		008600570
T27	1.110		008600575
T30	1.110		008600580
T40	1.110		008600585

860/C27



860/C27	Ft	1	008600880
	35.300		

860MIX/A10



860MIX/A10	Ft	1	008600900
	14.550		

860TX/A10



860TX/A10	Ft	1	008600970
	15.650		

860MIX/A31



860MIX/A31	Ft	1	008600902
	34.750		

862F/A7



862F/A7	Ft	1	008620950
	20.400		

900K



mm	Ft	10	
4	1.080		009009040
4,5	1.080		009009045
5	1.080		009009050
5,5	1.080		009009055
6	1.080		009009060
7	1.080		009009070
8	1.080		009009080
9	1.080		009009090
10	1.080		009009100
11	1.080		009009110
12	1.080		009009120
13	1.090		009009130
14	1.100		009009140

900/20LK



L	Ft	5	009009819
mm 100	3.560		

900/25K

1/4"



L	Ft	5	009009830
mm 41	6.990		

900BG/30K

1/4"



L	Ft	5	009009834
mm 128	3.470		

900/55K

3/8"

1/4"



L	Ft	5	009009870
mm 125	18.900		

900/55ZK

3/8"

1/4"



L	Ft	3	009009882
mm 125	18.900		

900/58K

1/4"



L	Ft	2	009009884
mm 126	28.750		

910AK

3/8"



mm	Ft	5	009109006
6	2.170		
7	2.170		
8	2.170		
9	2.170		
10	2.170		
11	2.170		
12	2.300		
13	2.300		
14	2.300		
15	2.300		
16	2.490		
17	2.490		
18	2.490		
19	2.490		
20	2.630		
21	2.630		
22	2.690		

910/21K

3/8"



L	Ft	5	009109822
mm 125	4.850		

910/25K

3/8"



L	Ft	5	009109830
mm 54,6	8.380		

910/55K

7/8"

3/8"



L	Ft	3	009109882
mm 200	20.700		

910/58K

3/8"



L	Ft	1	009109884
mm 222	31.350		

920AK

1/2"



mm	Ft	10	009209010
10	1.680		
11	1.680		
12	1.680		
13	1.870		
14	1.870		
15	1.870		
16	2.020		
17	2.020		
18	2.020		
19	2.020		
20	2.310		
21	2.310		
22	2.310		
23	2.520		
24	2.520		
25	2.520		
26	2.550		
27	2.550		
28	2.550		
29	2.750		
30	2.750		
32	2.870		

920/21K

1/2"



L	Ft	5	009209822
mm 125	6.510		

920/25K

1/2"



L	Ft	5	009209830
mm 75	10.350		

920/55K

7/8"

1/2"



L	Ft	3	009209882
mm 275	24.650		

920/58K

1/2"



L	Ft	1	009209926
mm 281	36.950		

935K



mm	Ft	5	009359105
6x7	3.180		
8x9	3.440		
10x11	3.750		
12x13	4.280		
14x15	5.040		
16x17	5.450		
18x19	6.510		
20x22	7.860		

937K



mm	Ft	5	009379006
6x6	3.400		
7x7	3.540		
8x8	3.700		
9x9	3.900		
10x10	4.100		
11x11	4.320		
12x12	4.690		
13x13	4.880		
14x14	5.300		
15x15	5.960		
16x16	6.460		
17x17	6.670		
18x18	6.910		
19x19	7.140		
20x20	8.070		
21x21	8.890		
22x22	9.340		

943BXX



mm	Ft			Code
5,5	6.790	5		009439005
6	6.790	5		009439006
7	7.290	5		009439007
8	7.290	5		009439008
10	7.800	3		009439010
13	8.340	3		009439013

951K



mm	Ft			Code
2	7.500	5		009519521
2,5	7.500	5		009519525
3	7.500	5		009519530
3,5	7.740	5		009519535
4	7.740	5		009519540
4,5	8.480	5		009519545
5	8.480	5		009519550
6	9.800	5		009519560
8	10.600	5		009519580
10	13.200	5		009519610

1032K



L mm	Ft			Code
140x0,9	10.050	5		010329013
140x1,3	9.800	5		010329014
180	10.600	5		010329017

1033K



L mm	Ft			Code
140x0,9	11.300	5		010339013
140x1,3	11.000	5		010339014
180	11.550	5		010339017

1034K



L mm	Ft			Code
130x0,9	11.300	5		010349013
130x1,3	11.000	5		010349014
170	11.550	5		010349017

1036K



L mm	Ft			Code
140x0,9	11.150	5		010369013
140x1,3	10.550	5		010369014
175	11.000	5		010369017

1037K



L mm	Ft			Code
140x0,9	12.050	5		010379013
140x1,3	11.550	5		010379014
175	12.050	5		010379017

1038K



L mm	Ft			Code
135x0,9	12.050	5		010389013
135x1,3	11.550	5		010389014
175	12.050	5		010389017

1044K



L mm	Ft			Code
250	13.150	5		010449250

1044FK



L mm	Ft			Code
250	10.450	5		010449015



1048NK

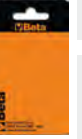

L mm	Ft			Code
175	11.950	3		010489910
250	12.950	5		010489915

1048V NK

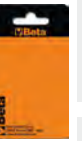

L mm	Ft			Code
175	10.600	3		010489111
250	12.150	5		010489116

1052K

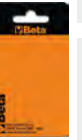

L mm	Ft			Code
140	11.250	3		010529014
190	12.600	3		010529019
240	13.350	3		010529024

1082K

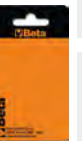

L mm	Ft			Code
140	10.450	5		010829004
160	11.200	5		010829006

1082GK

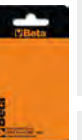

L mm	Ft			Code
140	9.560	5		010829064
160	10.350	5		010829066



1082BMK



L	Ft		
mm 140	13.000	3	010829034
160	14.400	3	010829036

1082GBMK



L	Ft		
mm 140	12.450	3	010829264
160	14.000	3	010829266

1084K



L	Ft		
mm 160	12.200	3	010849006

1084GK



L	Ft		
mm 160	11.200	5	010849066

1084BMK



L	Ft		
mm 160	15.150	3	010849036

1084GBMK

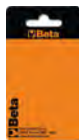

L	Ft		
mm 160	17.500	3	010849266

1088K



L	Ft		
mm 160	14.800	2	010889006

1088BMK



L	Ft		
mm 160	18.050	2	010889036

1096K



L	Ft		
mm 200	9.640	5	010969020

1098K



L	Ft		
mm 190	8.240	5	010989190
220	9.320	5	010989220

1098PLK



L	Ft		
mm 220	9.960	5	010989320

1112K



L	Ft		
mm 200	10.450	2	011129020

1122K



L	Ft		
mm 250	14.400	2	011229020

1123K



L	Ft		
mm 250	14.400	2	011239020

1124K



L	Ft		
mm 250	14.400	2	011249020

1128BAX



L	Ft		
mm 150	12.550	5	011280088

1128BMX



L	Ft		
mm 147	8.240	5	011280051

1128BSX



L mm	Ft	Hand	Part No.
148	11.900	5	011280061

1128FX



L mm	Ft	Hand	Part No.
145	12.400	5	011280090

1128FXS



L mm	Ft	Hand	Part No.
145	11.950	5	011280095

1129BMK



L mm	Ft	Hand	Part No.
145	7.040	5	011299000

1130BMX



L mm	Ft	Hand	Part No.
185	7.840	1	011300002

1132K



L mm	Ft	Hand	Part No.
170	20.000	2	011329107

1132BMK



L mm	Ft	Hand	Part No.
170	24.800	2	011329137

1142BMK



L mm	Ft	Hand	Part No.
160	16.400	3	011429036

1144T



L mm	Ft	Hand	Part No.
112	9.260	1	011440060

1149F



L mm	Ft	Hand	Part No.
175	7.010	1	011490010

1150K



L mm	Ft	Hand	Part No.
160	8.110	5	011509046
180	8.830	5	011509048
200	9.600	5	011509050
220	10.500	2	011509052

1150GK



L mm	Ft	Hand	Part No.
160	7.750	5	011509066
180	8.920	5	011509068
200	9.140	5	011509070
220	9.890	2	011509072

1150BMK



L mm	Ft	Hand	Part No.
160	10.050	3	011509146
180	11.100	3	011509148
200	12.200	3	011509150
220	13.050	2	011509152

1150GBMK



L mm	Ft	Hand	Part No.
160	9.670	3	011509266
180	10.900	3	011509268
200	11.550	3	011509270
220	12.500	2	011509272

1162K



L mm	Ft	Hand	Part No.
160	9.060	5	011629006
200	10.350	5	011629010

1162GK



L mm	Ft	Hand	Part No.
160	7.800	5	011629066
200	9.780	5	011629070

1162BMK

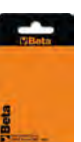

L mm	Ft	Hand	Part No.
160	11.300	3	011629036
200	13.000	3	011629040

1162GBMK



L mm	Ft	W	PC
160	10.150	3	011629266
200	12.300	3	011629270

1164K



L mm	Ft	W	PC
160	9.710	5	011649006
200	11.250	5	011649010

1164BMK



L mm	Ft	W	PC
160	12.200	3	011649036
200	14.200	3	011649040

1166K



L mm	Ft	W	PC
160	9.060	5	011669006
200	10.350	5	011669010

1166GK



L mm	Ft	W	PC
160	7.800	5	011669066
200	9.780	5	011669070

1166BMK



L mm	Ft	W	PC
160	11.300	3	011669036
200	13.000	3	011669040

1166GBMK



L mm	Ft	W	PC
160	10.150	3	011669266
200	12.300	3	011669270

1168K



L mm	Ft	W	PC
160	9.710	5	011689006
200	11.250	5	011689010

1168GK



L mm	Ft	W	PC
160	8.530	5	011689066
200	10.250	5	011689070

1168BMK



L mm	Ft	W	PC
160	12.200	3	011689036
200	14.200	3	011689040

1168GBMK



L mm	Ft	W	PC
160	11.100	3	011689266
200	12.450	3	011689270

1201E/K



SxAxL mm	Ft	W	PC
0,4x2,5x50	1.540	5	012019203
0,4x2,5x75	1.680	5	012019206
0,5x3x75	1.700	5	012019209
0,5x3x100	1.750	5	012019212
0,6x3,5x75	1.730	5	012019218
0,6x3,5x100	1.770	5	012019221
0,8x4x100	1.780	5	012019230
0,8x4x125	1.780	5	012019233
0,8x4x150	1.900	5	012019236
1,0x5,5x100	2.110	5	012019239
1,0x5,5x125	2.180	5	012019240
1,0x5,5x150	2.280	5	012019242
1,2x6,5x100	2.450	5	012019248
1,2x6,5x125	2.550	5	012019250
1,2x6,5x150	2.620	5	012019251
1,2x8x150	3.480	3	012019257
1,2x8x200	3.710	3	012019260
1,6x10x200	4.150	3	012019266

1201EN/K



SxAxL mm	Ft	W	PC
0,8x4x30	2.340	3	012019303
1,2x6,5x30	2.490	3	012019306

1202E/K



PHxDxL mm	Ft	W	PC
0x3x60	1.540	5	012029203
0x3x100	1.750	5	012029206
1x4,5x80	2.040	5	012029209
1x4,5x120	2.240	5	012029212
2x6x100	2.450	5	012029218
2x6x150	2.660	5	012029221
3x8x150	3.620	3	012029224
4x9,5x200	4.280	3	012029227

1202EN/K



PHxDxL mm	Ft	W	PC
1x4,5x30	2.340	3	012029303
2x6x30	2.490	3	012029306

1204E/K



SxDxL mm	Ft	W	PC
0,4x2,5x60	1.620	5	012049103
0,6x3x75	1.660	5	012049106
0,5x3x100	1.740	5	012049109
0,8x4x100	1.780	5	012049112
0,8x4x125	1.940	5	012049115
1,0x5x125	2.290	5	012049118
1,0x5x150	2.580	5	012049121
1,2x6,5x150	2.880	5	012049124



1207E TX/K



	Ft		
T5	1.770	5	012079105
T6	1.770	5	012079106
T7	1.810	5	012079107
T8	1.860	5	012079108
T9	1.920	5	012079109
T10	2.360	5	012079110
T15	2.390	5	012079115
T20	2.450	5	012079120
T25	2.490	5	012079125
T27	2.720	5	012079127
T30	2.780	5	012079130
T40	3.820	2	012079140
T45	3.900	2	012079145

1208E RTX/K



	Ft		
T9	1.910	5	012089109
T10	2.430	5	012089110
T15	2.490	5	012089115
T20	2.550	5	012089120
T25	2.580	5	012089125
T27	2.870	5	012089127
T30	2.910	5	012089130
T40	3.940	2	012089140

1209E PZ/K



PZ	Ft		
0	1.610	5	012099200
1	2.150	5	012099203
2	2.610	5	012099206
3	3.840	3	012099209
4	4.420	3	012099212

1209EN-PZ/K



	Ft		
1	2.340	3	012099303
2	2.490	3	012099306

1253

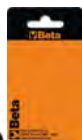

SxAxL mm	Ft		
0,5x3,5x100	3.240	5	012530001

1254



SxAxL mm	Ft		
0,5x3x44	3.460	5	012540001

1260K



SxAxL mm	Ft		
0,4x2,5x50	1.920	5	012609003
0,4x2,5x75	1.970	5	012609006
0,5x3x75	2.000	5	012609009
0,5x3x100	2.060	5	012609012
0,6x3,5x75	2.140	5	012609018
0,6x3,5x100	2.180	5	012609021
0,8x4x100	2.350	5	012609030
0,8x4x125	2.430	5	012609033
0,8x4x150	2.520	5	012609036
1x5,5x100	2.690	5	012609039
1x5,5x150	3.010	5	012609042
1,5x6,5x100	3.280	5	012609048
1,2x6,5x150	3.520	5	012609051
1,2x8x150	4.320	3	012609057
1,2x8x200	4.470	3	012609060
1,6x10x200	5.480	3	012609066

1260NK



SxAxL mm	Ft		
0,8x4x30	2.510	5	012609103
1,2x6,5x30	2.720	5	012609106

1260EK



SxAxL mm	Ft		
1,2x6,5x150	4.660	3	012609156
1,2x8x175	5.700	3	012609157
1,6x10x200	6.710	2	012609159
2x12x250	7.730	2	012609162

1262K



PHxDxL mm	Ft		
0x3x60	1.990	5	012629003
0x3x100	2.140	5	012629006
1x4,5x80	2.690	5	012629009
1x4,5x120	2.880	5	012629012
2x6x100	3.290	5	012629018
2x6x150	3.620	5	012629021
3x8x150	4.880	3	012629024
4x10x200	6.160	3	012629027

1262NK



PHxDxL mm	Ft		
1x4,5x30	2.510	5	012629103
2x6x30	2.780	5	012629106

1262EK



PHxDxL mm	Ft		
2x6x150	4.600	3	012629153
3x8x175	5.660	3	012629156
4x10x200	6.750	3	012629159

1264K



SxDxL mm	Ft		
0,5x2,5x60	1.940	5	012649003
0,6x3x75	2.020	5	012649006
0,6x3x100	2.080	5	012649009
0,8x4x100	2.430	5	012649012
0,8x4x125	2.490	5	012649015
1x5x125	2.710	5	012649018
1x5x150	2.970	5	012649021
1,2x6,5x150	3.520	5	012649024

1267TKK



	Ft		
T5	2.910	5	012679005
T6	3.030	5	012679006
T7	3.120	5	012679007
T8	3.240	5	012679008
T9	3.420	5	012679009
T10	3.570	5	012679010
T15	3.790	5	012679015
T20	3.950	5	012679020
T25	4.200	5	012679025
T27	4.400	5	012679027
T30	4.570	5	012679030
T40	5.220	2	012679040
T45	5.680	2	012679045

1268RTKX



⊕	Ft	⚙️	📦
T9	3.700	3	012689009
T10	3.840	3	012689010
T15	3.950	3	012689015
T20	4.190	3	012689020
T25	4.350	3	012689025
T27	4.670	3	012689027
T30	4.790	3	012689030
T40	5.380	2	012689040

1269PZK



PZ	Ft	⚙️	📦
0	2.310	5	012699000
1	2.970	5	012699001
2	3.660	5	012699002
3	5.190	3	012699003
4	6.640	3	012699004

1269N/PZK



PZ	Ft	⚙️	📦
1	2.430	5	012699011
2	2.750	5	012699012

1290K



SxAxL mm	Ft	⚙️	📦
0,4x2,5x50	2.390	5	012909003
0,4x2,5x75	2.450	5	012909006
0,5x3x75	2.500	10	012909009
0,5x3x100	2.640	10	012909012
0,6x3,5x75	2.850	10	012909018
0,6x3,5x100	2.940	10	012909021
0,8x4x100	2.920	10	012909030
0,8x4x125	3.030	10	012909033
0,8x4x150	3.180	10	012909036
1x5,5x100	3.280	10	012909039
1x5,5x150	3.730	10	012909042
1,2x6,5x100	4.080	10	012909048
1,2x6,5x150	4.360	10	012909051
1,2x8x150	5.440	3	012909057
1,2x8x200	5.750	3	012909060
1,6x10x200	6.860	3	012909066

1290NK



SxAxL mm	Ft	⚙️	📦
0,8x4x30	3.130	5	012909103
1,2x6,5x30	3.500	5	012909106

1290K/INOX



SxAxL mm	Ft	⚙️	📦
0,4x2,5x50	2.940	4	012909403
0,5x3x75	3.130	4	012909409
0,8x4x100	3.390	4	012909430
1,0x5,5x150	4.340	4	012909442
1,2x6,5x150	4.720	4	012909451

1292K



PHxDxL mm	Ft	⚙️	📦
0x3x60	2.310	10	012929003
0x3x100	2.620	5	012929006
1x4,5x80	3.160	10	012929009
1x4,5x120	3.500	10	012929012
2x6x100	4.190	10	012929018
2x6x150	4.630	10	012929021
3x8x150	5.790	3	012929024
4x10x200	8.060	3	012929027

1292NK



PHxDxL mm	Ft	⚙️	📦
1x4,5x30	3.000	5	012929103
2x6x30	3.260	5	012929106

1292K/INOX



PHxDxL mm	Ft	⚙️	📦
0x3x60	2.980	4	012929403
1x4,5x80	3.610	4	012929409
2x6x100	4.340	4	012929418

1294K



SxDxL mm	Ft	⚙️	📦
0,5x2,5x60	2.220	5	012949003
0,6x3x75	2.320	5	012949006
0,8x4x100	2.930	5	012949012
1x5x125	3.550	5	012949018

1298RTKX



⊕	Ft	⚙️	📦
T9	5.020	5	012989009
T10	5.140	5	012989010
T15	5.440	5	012989015
T20	5.500	5	012989020
T25	5.570	5	012989025
T27	5.940	5	012989027
T30	6.160	5	012989030
T40	6.520	2	012989040

1299PZK



PZ	Ft	⚙️	📦
0	3.180	5	012999000
1	3.850	5	012999003
2	5.380	5	012999006

1299N/PZK



PZ	Ft	⚙️	📦
1	3.760	5	012999021
2	4.150	5	012999024

1472VW



L mm	Ft	⚙️	📦
200	18.950	1	014720051

Beta
Quality Tools

1473P



A Max mm	Ft	⚡	📦
53	12.750	1	014730020

1497BS



L mm	Ft	⚡	📦
230	9.670	1	014970190

1497SS



L mm	Ft	⚡	📦
245	8.790	1	014970195

1497RC



1497RC	Ft	⚡	📦
	30.650	1	014970351

1600Q 8

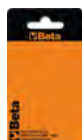

1600Q 8	Ft	⚡	📦
	13.250	1	016000008

1600Q 10



1600Q 8	Ft	⚡	📦
	13.250	1	016000008

1603K



mm ² 0-8	Ft	⚡	📦
	6.530	5	016039001

1603BK



mm ² 0-8	Ft	⚡	📦
	23.400	2	016039010

1651DGTB

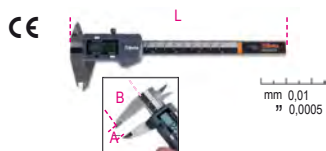

A Max mm	Ft	⚡	📦
150	44.200	1	016510211
200	57.600	1	016510212
300	75.300	1	016510213

1651DGTB/IP



A Max mm	Ft	⚡	📦
150	79.750	1	016510711

1691BM



L m	Ft	⚡	📦
5	6.590	1	016910205
8	9.530	1	016910208
10	11.450	1	016910210



1691MG



L m	Ft	⚡	📦
5	8.090	1	016910405
8	11.200	1	016910408
10	12.400	1	016910410

1692



L m	Ft	⚡	📦
2	3.140	5	016920052
3	3.930	5	016920053
5	5.620	5	016920055
8	8.200	5	016920058

1693



H mm	Ft	⚡	📦
100	57.350	1	016930020

1729CG



L mm	Ft	⚡	📦
310	9.230	2	017290200

1729DM 450

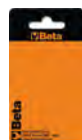

L mm	Ft	⚡	📦
450	10.600	4	017290450



1741U



200 mm

Ø mm	2,4	3	3,2	4	4,8
Aluminium	•	•	•	•	•
Acél	•	•	•	•	•
Nemesacél	•	•	•	•	•



1741U Ft 17.250 1 017410450

1741B



250 mm

Ø mm	2,4	3,2	4	4,8	5
Aluminium	•	•	•	•	•
Acél	•	•	•	•	•
Rozsdamentes acél	•	•	•		



1741B Ft 15.850 1 017410000

1760K

CE



180 mm

CAT III-1000V



1760K Ft 14.800 1 017600140

1762K



Ø mm	Ft		
2-2,5-3	12.400	2	017629001
3,5-4-4,5			

1771



170 mm



1771 Ft 3.820 10 017710000

1770BM



L mm 140 Ft 5.160 10 017700050



1771BM



L mm 170 Ft 7.560 10 017710050



1771HD



L mm 190 Ft 10.400 5 017710100



1772R



L mm 125 Ft 7.030 5 017720006



1773A



L mm 180 Ft 7.380 10 017730000



1777BMT



L mm 170 Ft 10.850 5 017770050



1777T



L mm 160 Ft 10.450 5 017770030



1778MT



L mm 180 Ft 48.100 1 017780055



1783



L mm 215 Ft 5.910 5 017830021
240 Ft 6.940 5 017830024



1820



L=1,25 m

230V Shuko

1820 30 Ft 17.800 1 018200003

30W L = 210mm 20.400 1 018200006

1820 60 60W L = 220mm 28.600 1 018200008

1820 80 80W L = 260mm



1822



230V
Shuko
L=1,25 m



1822 120	Ft	1	018220012
120W	44.700		
LxA = 250x125 mm			
1822 180	Ft	1	018220018
180W	47.300		
LxA = 250x125mm			
1822 320	Ft	1	018220032
320W	57.950		
LxA = 250x140mm			

1833S



L	Ft	1	018330002
mm	13.950		
150			

1833M

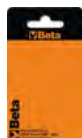

L	Ft	1	018330003
mm	17.400		
162			

1833L



L	Ft	1	018330004
mm	26.900		
196			

1833XL



L	Ft	1	018330005
mm	33.700		
300			

1833L/USB



L	Ft	1	018330054
mm	44.700		
240			

1834RR



1834RR	Ft	1	018340520
	20.400		

1836AW



1836AW	Ft	1	018360051
	27.250		

1836B



1836B	Ft	1	018360200
	50.150		



1837F



L	Ft	1	018370050
mm	33.200		
460			

1837F/USB



L	Ft	1	018370060
mm	48.950		
460			

1838COB



1838COB	Ft	1	018380010
	35.850		

1838P

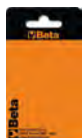

1838P	Ft	1	018380005
	30.850		

1838POCKET



CE
L mm 98 Ft 26.200 1 018380080

1838SLIM



CE
L mm 307 Ft 22.650 1 018380221

1838SW



CE
L mm 260 Ft 37.400 1 018380142

1839BRW



CE
L mm 101 Ft 31.550 1 018390002

1860M



L max mm 30 Ft 30.000 1 018600301

1875SP/K3



1875SP/K3 Ft 8.060 1 018750010

1949F2



g 125 Ft 6.450 1 019490028

6888B1/4

bliszter tartó 1/4" dugókulcsokhoz



6888B1/4 Ft 245 50 068880900

6888B3/8

bliszter tartó 3/8" dugókulcsokhoz



6888B3/8 Ft 300 50 068880910

6888B1/2

bliszter tartó 1/2" dugókulcsokhoz



6888B1/2 Ft 300 50 068880920

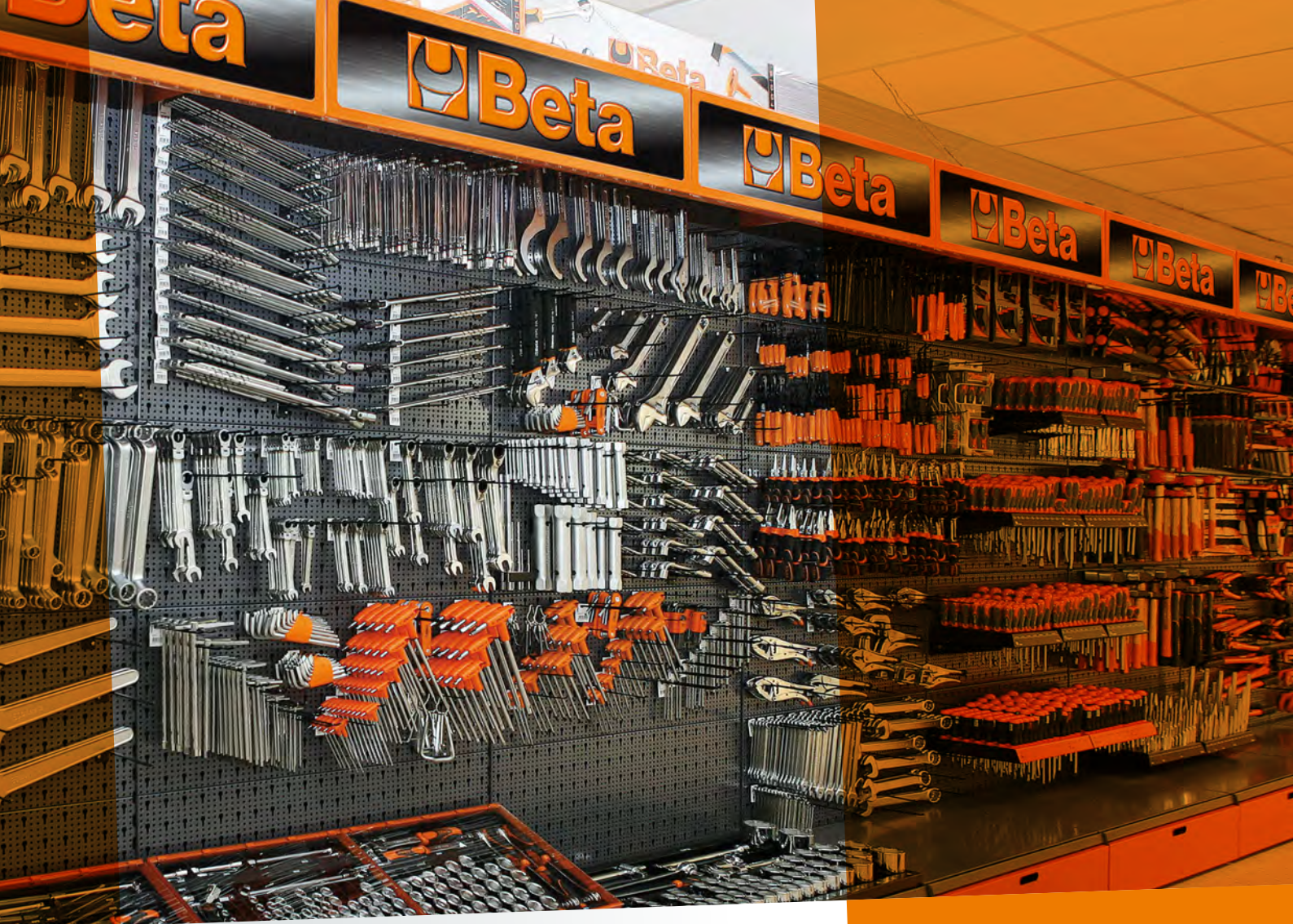

**ÁLLVÁNYOK ÁRUHÁZAKBA,
BEMUTATÓTERMEKBE**

Beta
SHOP
in Shop

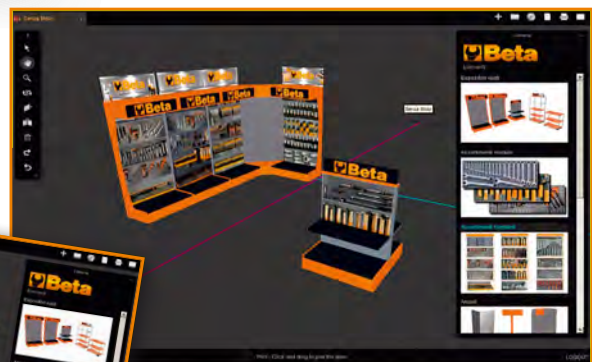

**SZERKESSEZSE MEG EGYEDI BETA
BEMUTATÓFALÁT**

www.beta-tools.com/planner3d/

38/DS1

Fali állvány 75 ütőszerszámmal



495x260x332 mm

Állvány
szerszámmal
38/DS1 Ft 283.300 1 000380701

n.		
5	30	Ø 2 - 3 - 4 - 5 - 6 mm
5	31	Ø 2 - 3 - 4 - 5 - 6 - 8 - 10 mm
5	32	Ø 3 - 4 - 5 mm

Állvány
üres
38/DVS1 Ft 42.550 1 000380751

38/DS2

Fali állvány 65 ütőszerszámmal

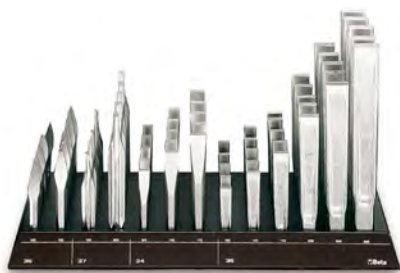

495x260x332 mm

Állvány
szerszámmal
38/DS2 Ft 528.900 1 000380702

n.		
5	34	125 - 150 - 175 mm
5	35	100 - 125 - 150 - 200 - 250 - 300 mm
5	36	125 - 150 mm
5	37	150 - 200 mm

Állvány
üres
38/DVS2 Ft 42.550 1 000380752

942BX/DG

Fali állvány 43 hatlapú dugókulcs-
csavarhúzóval, rövid kivitel



330x260x332 mm

Állvány
szerszámmal
942BX/DG Ft 282.200 1 009420701

n.		
3	942BX	5 - 5,5 mm
6		6 - 7 mm
5		8 - 9 - 10 mm
2		11 mm
3		12 mm
5		13 mm

Állvány
üres
942BX/DVG Ft 36.550 1 009420751

943BK/DG

Fali állvány 43 hatlapú dugókulcs-
csavarhúzóval, hosszított kivitel



330x260x332 mm

Állvány
szerszámmal
943BK/DG Ft 304.100 1 009430701

n.		
3	943BK	5 - 5,5 mm
6		6 - 7 mm
5		8 - 9 - 10 mm
2		11 mm
3		12 mm
5		13 mm

Állvány
üres
943BK/DVG Ft 36.550 1 009430751

944BX/DG

Fali állvány 43 hatlapú dugókulcs-
csavarhúzóval, hosszított kivitel



330x260x332 mm

Állvány
szerszámmal
944BX/DG Ft 354.600 1 009440701

n.		
3	944BX	5 - 5,5 mm
6		6 - 7 mm
5		8 - 9 - 10 mm
2		11 mm
3		12 mm
5		13 mm

Állvány
üres
944BX/DVG Ft 36.550 1 009440751

943MQ/BG

Fali állvány 30 hatlapú dugókulcs-
csavarhúzóval



△ 1000 V ⊕

330x260x332 mm

Állvány
szerszámmal
943MQ/BG Ft 240.700 1 009430281

n.		
5	943MQ	5,5 - 6 - 7 - 8 - 10 - 13 mm

Állvány
üres
943BG-MQ/DV Ft 37.100 1 009430285

1203/E1P

Fali bemutató állvány
82 csavarhúzóval



495x260x310 mm

Állvány
szerszámmal Ft 1 012031301

	n.
● 1201 0,4x2,5x50 - 0,5x3x75 - 0,6x3,5x100 0,8x4x100 - 0,8x4x125 mm 1,0x5,5x100 - 1,0x5,5x150 - 1,2x6,5x150 mm 1,2x8x150 mm	7 6 5
⊕ 1202 PH0x3x60 mm PH1x4,5x80 - PH2x6x100 mm PH3x8x150 mm	7 6 5

Állvány
üres Ft 1 012031351

1203/E4P

Fali bemutató állvány
85 csavarhúzóval



495x260x310 mm

Állvány
szerszámmal Ft 1 012031304

	n.
● 1201 0,4x2,5x50 - 0,5x3x75 - 0,8x4x125 mm 1,0x5,5x100 - 1,0x5,5x150 - 1,2x6,5x150 mm	7 6
● 1204 0,4x2,5x60 - 0,5x3x100 - 0,8x4x100 mm 1,0x5x125 mm	7 6
⊕ 1209PZ PZ0x3x60 mm PZ1x4,5x80 - PZ2x6x100 mm	7 6

Állvány
üres Ft 1 012031354

1203/E5P

Fali bemutató állvány
82 csavarhúzóval



495x260x310 mm

Állvány
szerszámmal Ft 1 012031305

	n.
⊕ 1202 PH0x3x60 mm PH1x4,5x80 - PH1x4,5x120 PH2x6x100 - PH2x6x150 mm PH3x8x150 mm	7 6 5
● 1204 0,4x2,5x60 - 0,5x3x100 - 0,8x4x100 mm 1,0x5x125 mm	7 6
⊕ 1209PZ PZ0x3x60 mm PZ1x4,5x80 - PZ2x6x100 mm	7 6

Állvány
üres Ft 1 012031355

1203/E10P

Fali bemutató állvány
80 csavarhúzóval



495x260x310 mm

Állvány
szerszámmal Ft 1 012031310

	n.
⊖ 1207TX T6 T7 T8 T9 - T10 - T15 - T20 - T25 T27 - T30	4 3 7 6 3
⊕ 1208RTX T9 - T10 T15 - T20 - T25 T27 - T30	3 6 3

Állvány
üres Ft 1 012031360

1263/E78

Fali állvány 78 csavarhúzóval



495x260x310 mm

Állvány
szerszámmal Ft 1 012630510

● 1260 2,5x75-3x75-3,5x100 mm 4x100-4x125-5,5x100-5,5x150-6,5x150 mm 8x150 mm	7 6 4
⊕ 1262 PH0x60 mm PH1x80-PH2x100 mm PH3x150	7 6 4

Állvány
üres Ft 1 012630511

1263/E74

fali bemutató állvány
74 csavarhúzóval



495x260x310 mm

Állvány
szerszámmal Ft 1 012630540

● 1264 2,5x60 mm 3x75 mm 3x100 - 4x100 mm 4x125 - 5x150 mm 5x125 - 6,5x150 mm	7 3 4 2 4
⊕ 1262 PH 8x150 PH 3x60 - 3x100 mm PH 4,5x80 - 4,5x120 mm PH 6x100 mm PH 6x150 mm	3 7 6 10 5

Állvány
üres Ft 1 012630541

1263/E85

Fali állvány
85 csavarhúzóval



495x260x377 mm

Állvány
szerszámmal
1263/E85 Ft 228.200 1 012630550

		n.
● 1260	2,5x50 mm	7
	2,5x75 mm	6
	3x75 - 3x100 - 3,5x100 mm	7
	4x100 - 4x125 - 5,5x125	6
	5,5x150 - 6,5x150 mm	6
● 1260E	8x150 mm	4
	10x200 mm	3
	12x250 mm	2
	4x30 - 6,5x30 mm	6

Állvány
üres
1263/EV85 Ft 43.600 1 012630551

1263/E70

Fali állvány
70 csavarhúzóval



495x260x327 mm

Állvány
szerszámmal
1263/E70 Ft 227.300 1 012630560

		n.
⊕ 1262	PH0x60 - PH0x100 mm	7
	PH1x80 - PH1x120 mm	6
	PH2x100 mm	9
	PH2x150 - PH3x150 mm	5
	PH4x200 mm	4
⊕ 1262E	PH2x150 mm	5
	PH3x175 mm	4
⊕ 1262N	PH1x30 - PH2x30 mm	6

Állvány
üres
1263/EV70 Ft 43.600 1 012630561

1263/E50

Fali állvány
50 csavarhúzóval



330x260x269 mm

Állvány
szerszámmal
1263/E50 Ft 118.800 1 012630570

		n.
● 1264	2,5x60 - 3x75 - 3x100 mm	7
	4x100 - 4x125 - 5x125 - 5x150 mm	6
	6,5x150 mm	5

Állvány
üres
1263/EV50 Ft 37.150 1 012630571

1263/E62

Fali állvány
62 csavarhúzóval



495x260x257 mm

Állvány
szerszámmal
1263/E62 Ft 222.500 1 012630590

		n.
⊕ 1267TX	T5	5
	T6	6
	T7	5
	T8	6
	T9	5
	T10 - T15 - T20	6
	T25	5
	T27 - T30	4
	T40 - T45	2

Állvány
üres
1263/EV62 Ft 43.600 1 012630591

1263/E39

Fali állvány
39 csavarhúzóval



330x260x257 mm

Állvány
szerszámmal
1263/E39 Ft 157.700 1 012630595

		n.
⊕ 1268RTX	T9x60 - T10x80 - T15x80	6
	T20x100 - T25x100 mm	4
	T27x115 mm	3
	T30x115 mm	2
	T40x130 mm	2

Állvány
üres
1263/EV39 Ft 37.150 1 012630596

1263/E40

Fali állvány
40 csavarhúzóval



330x260x327 mm

Állvány
szerszámmal
1263/E40 Ft 137.000 1 012630580

		n.
⊕ 1269	PZ0x60 mm	7
	PZ1x80 mm	6
	PZ2x100 - PZ3x150 - PZ4x200 mm	5
⊕ 1269N	PZ1x30 - PZ2x30 mm	6

Állvány
üres
1263/EV40 Ft 37.150 1 012630581

1273MQ/E1

Fali állvány 40 csavarhúzóval



±1000 V

330x260x332 mm

Állvány
szerszámmal
1273MQ/E1 Ft 178.900 1 012730312

	n.
➕ 1272MQ PH0x60 - PH1x80 mm	5
PH2x100 mm	3
PH3x150 mm	2
● 1274MQ 3x100 - 4x100 - 5,5x125 - 6,5x150 mm	5
8x175 mm	3
10x200 mm	2

Állvány
üres
1273BG-MQ/DV Ft 37.250 1 012730651

1273MQ/E4

fali bemutató állvány
43 csavarhúzóval



±1000 V

330x260x332 mm

Állvány
szerszámmal
1273MQ/E4 Ft 233.500 1 012730315

➕ 1272MQF 4,5x80 - 6x100 mm	3
● 1274MQF 3,5x100 - 4,5x100 - 5,5x125 - 6,5x150 mm	3
➕ 1275MQ/C 4,5x80 - 6x100 mm	5
➕ 1276MQ/C 4,5x80 - 6x100 mm	5
➕ 1279MQ/F 4,5x80 mm	3
6x100 mm	2

Állvány
üres
1273BG-MQ/DV4 Ft 40.850 1 012730655

1293BX/DA

Fali állvány 90 csavarhúzóval



495x260x332 mm

Állvány
szerszámmal
1293BX/DA Ft 303.900 1 012930701

	n.
● 1290 3x75 - 3,5x100 - 4x100 - 4x125	7
5,5x100 - 5,5x150 mm	6
6,5x150 mm	3
8x150 mm	2
10x200 mm	3
● 1290N 4x30 - 6,5x30 mm	3
➕ 1292 PH0x60 - PH1x80 mm	7
PH2x100 mm	6
PH3x150 mm	5
➕ 1292N PH1x30 - PH2x30 mm	3

Állvány
üres
1293BX/DVA Ft 43.800 1 012930751

1293BX/DD

Fali állvány 48 csavarhúzóval



330x260x332 mm

Állvány
szerszámmal
1293BX/DD Ft 141.600 1 012930704

	n.
● 1294 2,5x60 - 3x75 - 3x100 - 4x100	7
4x150 - 5x125 mm	6
6,5x150 mm	6

Állvány
üres
1293BX/DVD Ft 37.500 1 012930754

1293BX/DE

Fali állvány 42 csavarhúzóval



330x260x332 mm

Állvány
szerszámmal
1293BX/DE Ft 214.200 1 012930705

	n.
➕ 1299PZ PZ0x60 - PZ1x80 mm	7
PZ2x100 mm	6
PZ3x150 - PZ4x200 mm	5
➕ 1299N/PZ PZ1x30 - PZ2x30 mm	6

Állvány
üres
1293BX/DVE Ft 37.500 1 012930755

1293BX/DF

Fali állvány 59 csavarhúzóval



330x260x332 mm

Állvány
szerszámmal
1293BX/DF Ft 286.100 1 012930706

	n.
● 1297TX T6 - T8 - T10 - T15 - T20 - T25	7
T27 - T30	6
T40	5

Állvány
üres
1293BX/DVF Ft 37.500 1 012930756

C68

Beta bemutató állvány, 5 üres panellel



1000x560x2200 mm

		Ft		
C68/1	1 m	712.200	1	068000001
C68/2	2 m	1.239.300	1	068000002
C68/3	3 m	1.766.300	1	068000003
C68/4	4 m	2.293.400	1	068000004
C68/5	5 m	2.820.500	1	068000005
C68/6	6 m	3.347.600	1	068000006
C68/7	7 m	3.874.600	1	068000007
C68/8	8 m	4.401.700	1	068000008
C68/9	9 m	4.928.800	1	068000009
C68/10	10 m	5.455.800	1	068000010

C68N

Beta bemutatóállvány, üres



1000x560x2200 mm

		Ft		
C68N/1	1 m	615.200	1	068000031
C68N/2	2 m	1.142.300	1	068000032
C68N/3	3 m	1.669.400	1	068000033
C68N/4	4 m	2.196.400	1	068000034
C68N/5	5 m	2.723.500	1	068000035
C68N/6	6 m	3.250.600	1	068000036
C68N/7	7 m	3.777.700	1	068000037
C68N/8	8 m	4.304.700	1	068000038
C68N/9	9 m	4.831.800	1	068000039
C68N/10	10 m	5.358.900	1	068000040

C68 G

Bemutató gondola



1000x1120x1600 mm

		Ft		
C68G/1	1 m	677.200	1	068000051
C68G/2	2 m	1.250.900	1	068000052
C68G/3	3 m	1.824.500	1	068000053
C68G/4	4 m	2.398.200	1	068000054

C88 R/1

Robur bemutató állvány, 5 üres panellel



1000x560x2200 mm

		Ft		
C88R/1	1 m	712.200	1	088000001

C88NR/1

Robur bemutatóállvány, üres



1000x560x2200 mm

		Ft		
C88NR/1	1 m	615.200	1	088000031

C88VE

kiállító tálca C88 falhoz

a 8120 cikkszámú láncetekercsek elhelyezésére alkalmas



		Ft		
C88VE		96.800	1	088000120

C88SE

bemutató állvány oldalhegesztett lánc tekercsekhez



		Ft		
C88SE		237.300	1	088000130

1700x600x600 mm



6888

Szerszámtartók a C60 - C61 - C68 - C88 típusú bemutató állványhoz

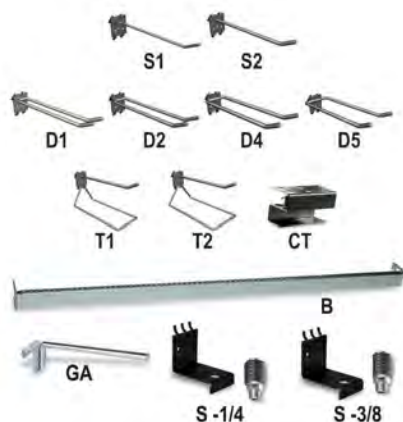

	Ft		
6888S1	1.820	10	068880011
6888S2	1.860	10	068880012
6888D1	2.850	5	068880021
6888D2	2.850	5	068880022
6888D4	2.950	5	068880024
6888D5	2.950	5	068880025
6888T1	4.050	5	068880031
6888T2	4.050	5	068880032
6888CT	6.250	1	068880044
6888B	25.450	1	068880100
6888GA	9.470	3	068880120
6888S-1/4	14.650	1	068880605
6888S-3/8	14.700	1	068880610

6800 VE

Vitrin a C68 és C68 R/1 bemutató állványhoz

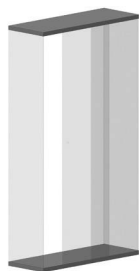

	Ft		
6800VE/1	1 m	378.400	1 068000401
6800VE/2	2 m	575.900	1 068000402
6800VE/3	3 m	773.400	1 068000403
6800VE/4	4 m	970.900	1 068000404
6800VE/5	5 m	1.168.500	1 068000405



	Ft		
6800AE	87.500	1	068000145
6800AI	177.600	1	068000140
6800AD/P	241.200	1	068000143

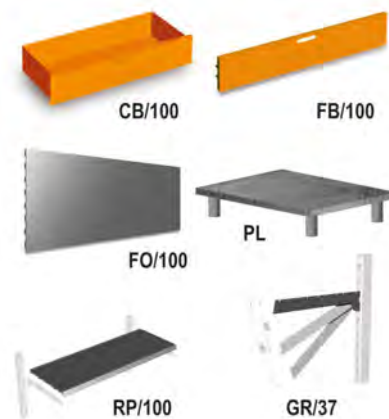

	Ft		
6800CB/100	91.400	1	068000104
6800FB/100	33.650	1	068000109
6800FO/100	24.550	1	068000108
6800PL	100.200	1	068000137
6800RP/100	30.750	1	068000150
6800GR/37	13.400	1	068000159



	Ft		
6800PM/40	31.600	1	068000171
6800PM/80	44.150	1	068000172

6600 M/14

154 darabos szerszámkészlet, akasztókkal, panel nélkül



	Ft		
6600 M/14	781.400	1	066000014

6600 M/22

108 darab szerszám, akasztókkal, panel nélkül



	Ft		
6600 M/22	519.600	1	066000022

6600 M/27

25 darab szerszám, akasztókkal, panel nélkül



	Ft		
6600 M/27	402.600	1	066000027

6600 M/29

173 darabos szerszámkészlet, akasztókkal, panel nélkül

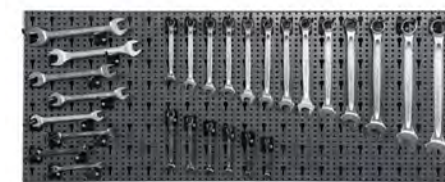

	Ft		
6600 M/29	693.300	1	066000029

6600 M/33

37 darab szerszám, akasztókkal, panel nélkül



	Ft		
6600 M/33	686.400	1	066000033

6600 M/40

100 darab szerszám
akasztókkal, panel nélkül



6600 M/40 Ft 1.024.000 1 066000040

6600 M/42

65 szerszámból álló készlet
akasztókkal, panel nélkül



6600 M/42 Ft 663.500 1 066000042

6600 M/44

48 darabos szerszámkészlet,
akasztókkal, panel nélkül



6600 M/44 Ft 562.900 1 066000044

6600 M/47

65 darab szerszám
akasztókkal, panel nélkül



6600 M/47 Ft 616.700 1 066000047

6600 M/51

257 darab szerszám
akasztókkal, panel nélkül



6600 M/51 Ft 1.094.000 1 066000051

6600 M/52

176 darab szerszám
akasztókkal, panel nélkül



6600 M/52 Ft 714.600 1 066000052

6600 M/58

150 darab szerszám
akasztókkal, panel nélkül



6600 M/58 Ft 772.700 1 066000058

6600 M/59

220 darabos szerszámkészlet
akasztókkal, panel nélkül



6600 M/59 Ft 824.800 1 066000059

6600 M/61

71 darab szerszám
akasztókkal, panel nélkül

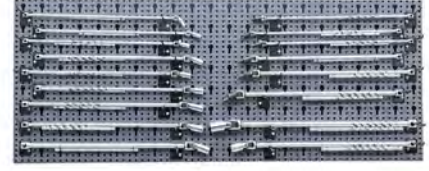

6600 M/61 Ft 966.200 1 066000061

6600 M/62

28 darabos szerszámkészlet
akasztókkal, panel nélkül



6600 M/62 Ft 227.800 1 066000062

6600 M/63

110 darab szerszám
akasztókkal, panel nélkül

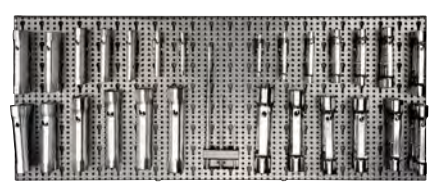

6600 M/63 Ft 912.900 1 066000063

6600 M/73

68 darab szerszám
akasztókkal, panel nélkül

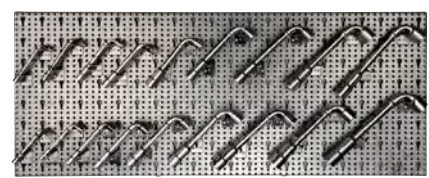

6600 M/73 Ft 594.100 1 066000073

6600 M/112

329 darab szerszám akasztókkal, panel nélkül



6600 M/112 Ft 795.900 1 066000112

6600 M/116

306 darab szerszám akasztókkal, panel nélkül



6600 M/116 Ft 743.500 1 066000116

6600 M/120

163 darab szerszám akasztókkal, panel nélkül



6600 M/120 Ft 522.000 1 066000120

6600 M/125

133 darab szerszám akasztókkal, panel nélkül



6600 M/125 Ft 460.800 1 066000125

6600 M/126

58 darab szerszám akasztókkal, panel nélkül



6600 M/126 Ft 237.700 1 066000126

6600 M/131

92 darab szerszám akasztókkal, panel nélkül



6600 M/131 Ft 831.200 1 066000131

6600 M/174

13 darab szerszám akasztókkal, panel nélkül



6600 M/174 Ft 1.454.400 1 066000174

6600 M/175

12 darabos szerszámkészlet akasztókkal, panel nélkül



6600 M/175 Ft 987.700 1 066000175

6600 M/217

74 darabos szerszámkészlet akasztókkal, panel nélkül



6600 M/217 Ft 972.300 1 066000217

6600 M/218

58 darabos szerszámkészlet akasztókkal, panel nélkül

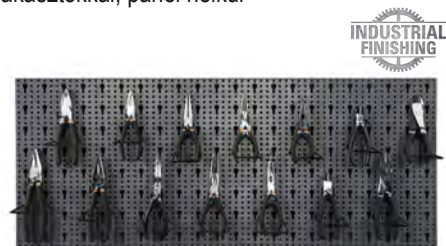

6600 M/218 Ft 527.500 1 066000218

6600 M/222

74 darabos szerszámkészlet akasztókkal, panel nélkül



6600 M/222 Ft 776.500 1 066000222

6600 M/223

58 darabos szerszámkészlet akasztókkal, panel nélkül

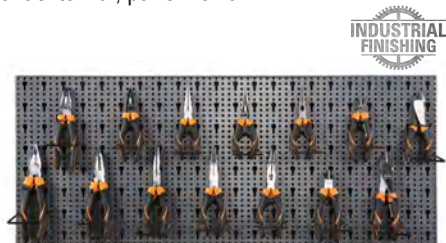

6600 M/223 Ft 697.700 1 066000223

INDUSTRIAL FINISHING

INDUSTRIAL FINISHING

6600 M/230

78 darabos szerszámkészlet akasztókkal, panel nélkül



6600 M/230 Ft 940.600 1 066000230

6600 M/236

31 darabos szerszámkészlet akasztókkal, panel nélkül



6600 M/236 Ft 541.400 1 066000236

6600 M/241

43 darabos szerszámkészlet akasztókkal, panel nélkül



6600 M/241 Ft 456.600 1 066000241

6600 M/242

91 darabos szerszámkészlet akasztókkal, panel nélkül



6600 M/242 Ft 1.035.700 1 066000242

6600 M/253

60 darabos szerszámkészlet akasztókkal, panel nélkül



6600 M/253 Ft 737.100 1 066000253

6600 M/311

114 darabos szerszámkészlet akasztókkal, panel nélkül



6600 M/311 Ft 388.800 1 066000311

6600 M/315

149 darabos szerszámkészlet akasztókkal, panel nélkül



6600 M/315 Ft 641.800 1 066000315

6600 M/320

98 darabos szerszámkészlet akasztókkal, panel nélkül



6600 M/320 Ft 670.500 1 066000320

6600 M/326

155 darabos szerszámkészlet akasztókkal, panel nélkül



6600 M/326 Ft 455.500 1 066000326

6600 M/327

101 darabos szerszámkészlet akasztókkal, panel nélkül



6600 M/327 Ft 380.200 1 066000327

6600 M/330

110 darabos szerszámkészlet akasztókkal, panel nélkül



6600 M/330 Ft 306.000 1 066000330

6600 M/371

162 darabos szerszámkészlet akasztókkal, panel nélkül



6600 M/371 Ft 349.100 1 066000371

6600 M/380

71 darabos szerszámkészlet akasztókkal, panel nélkül



6600 M/380 Ft 231.800 1 066000380

6600 M/406

107 darabos szerszámkészlet akasztókkal, panel nélkül



6600 M/406 Ft 453.600 1 066000406

6600 M/417

43 darabos szerszámkészlet akasztókkal, panel nélkül



6600 M/417 Ft 405.800 1 066000417

6600 M/423

30 darabos szerszámkészlet akasztókkal, panel nélkül



6600 M/423 Ft 413.300 1 066000423

6600 M/424

36 darabos szerszámkészlet akasztókkal, panel nélkül



6600 M/424 Ft 444.500 1 066000424

6600 M/427

24 darabos szerszámkészlet akasztókkal, panel nélkül



6600 M/427 Ft 444.000 1 066000427

6600 M/430

29 darabos szerszámkészlet akasztókkal, panel nélkül



6600 M/430 Ft 430.500 1 066000430

6600 M/440

140 darabos szerszámkészlet akasztókkal, panel nélkül

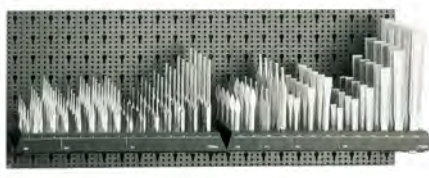

6600 M/440 Ft 812.200 1 066000440

6600 M/456

41 darabos szerszámkészlet akasztókkal, panel nélkül



6600 M/456 Ft 603.800 1 066000456

6600 M/465

36 darabos szerszámkészlet akasztókkal, panel nélkül



6600 M/465 Ft 750.800 1 066000465

6600 M/480

18 darabos szerszámkészlet akasztókkal, panel nélkül



6600 M/480 Ft 470.500 1 066000480

6600 M/485

12 darabos szerszámkészlet akasztókkal, panel nélkül



6600 M/485 Ft 339.600 1 066000485

6600 M/510

16 darabos szerszámkészlet akasztókkal, panel nélkül



6600 M/510 Ft 465.700 1 066000510

6600 M/532

24 darabos szerszámkészlet akasztókkal, panel nélkül



6600 M/532 Ft 376.500 1 066000532

6600 M/534

51 darabos szerszámkészlet akasztókkal, panel nélkül



6600 M/534 Ft 614.600 1 066000534

6600 M/542

53 darabos szerszámkészlet akasztókkal, panel nélkül



6600 M/542 Ft 375.100 1 066000542

6600 M/548

37 darabos szerszámkészlet akasztókkal, panel nélkül

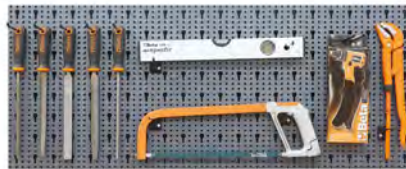

6600 M/548 Ft 339.600 1 066000548

6600 M/561

60 darabos szerszámkészlet akasztókkal, panel nélkül



6600 M/561 Ft 499.000 1 066000561

6600 M/583

22 darabos szerszámkészlet akasztókkal, panel nélkül



6600 M/583 Ft 354.900 1 066000583

6600 M/643

90 darabos szerszámkészlet akasztókkal, panel nélkül



6600 M/643 Ft 757.900 1 066000643

6600 M/650

28 darabos szerszámkészlet akasztókkal, panel nélkül



6600 M/650 Ft 1.049.500 1 066000650

6600 M/657

17 darabos szerszámkészlet akasztókkal, panel nélkül



6600 M/657 Ft 826.700 1 066000657

6600 M/658

14 darabos szerszámkészlet akasztókkal, panel nélkül

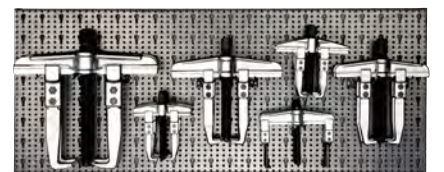

6600 M/658 Ft 927.000 1 066000658



6600 M/716

64 darabos szerszámkészlet akasztókkal, panel nélkül



6600 M/716 Ft 889.000 1 066000716

6600 M/813

25 darabos szerszámkészlet akasztókkal, panel nélkül



6600 M/813 Ft 457.700 1 066000813

6600 M/842

36 darabos szerszámkészlet akasztókkal, panel nélkül



6600 M/842 Ft 602.400 1 066000842

6600 M/852

560 darab kemény csiszolókorong akasztókkal, panel nélkül



6600 M/852 Ft 424.400 1 066000852

6600 M/856

560 darab kemény csiszolókorong akasztókkal, panel nélkül



6600 M/856 Ft 447.900 1 066000856

6600 M/857

560 darab kemény csiszolókorong akasztókkal, panel nélkül



6600 M/857 Ft 462.500 1 066000857

6600 M/871

120 darab csiszoló akasztókkal, panel nélkül



6600 M/871 Ft 222.400 1 066000871

6600 M/878

100 darab csiszoló akasztókkal, panel nélkül



6600 M/878 Ft 199.800 1 066000878

6600 M/881

410 darab csiszoló kiállító tálcával



6600 M/881 Ft 550.500 1 066000881

Robur

8600 R/11

374 darab kábelszerelvény akasztókkal, panel nélkül



8600 R/11 Ft 662.100 1 086000011

8600 R/12

259 darab kábelszerelvény akasztókkal, panel nélkül

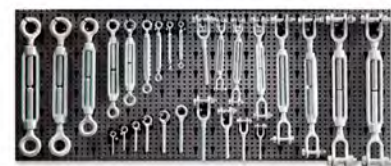

8600 R/12 Ft 647.000 1 086000012



8600 R/13

230 darab kábelszerelvény
akasztókkal, panel nélkül



8600 R/13 Ft 539.200 1 086000013

8600 R/113

1862 darab kábelszerelvény
akasztókkal, panel nélkül



8600 R/113 Ft 747.300 1 086000113

8600 R/114

1045 darab kábelszerelvény
akasztókkal, panel nélkül



8600 R/114 Ft 747.900 1 086000114

8600 R/225

64 darab 8. BIZTONSÁGI FOKÚ szerelvény
akasztókkal, panel nélkül



8600 R/225 Ft 542.900 1 086000225

8600 R/412

348 darab ROZSDAMENTES ACÉL
kábelszerelvény
akasztókkal, panel nélkül

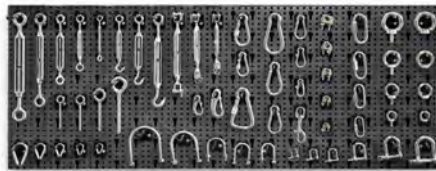

8600 R/412 Ft 844.400 1 086000412

8600 R/511

11 darab oldalhegesztett lánc tekercs
kiállító tálcával



8600 R/511 Ft 625.600 1 086000511

8600 R/601

50 darab racsnis rögzítőheveder
polccal és akasztókkal,
panel nélkül



8600 R/601 Ft 607.800 1 086000601
C88/R601 117.900 1 088000160

8600 R/611

52 darab emelőheveder
polccal és akasztókkal, panel nélkül



8600 R/611 Ft 419.900 1 086000611
C88/R611 69.300 1 088000161

Beta



MUNKAVÉDELMI CIPŐK

FIGYELMEZTETÉSEK

Használat előtt győződjön meg róla, hogy a cipő megfelel a felhasználási igényeknek, illetve a típusának és a munkahelynek megfelelő védelmi osztályba tartozik. A Beta Utensili által gyártott cipők kielégítik az érvényes EURÓPAI SZABVÁNYOK előírásait.

A munkáltató köteles megfelelő egyéni védőfelszerelést biztosítani az esetlegesen kockázatot jelentő munkakörnyezetben dolgozó munkavállalók számára (egyéni védőfelszerelés jellemzői és kategóriái).

ELAVULÁS

A cipők pontos tárolási ideje számos tényező miatt - úgymint a tárolás során uralkodó páratartalom és az anyagok idők során bekövetkező strukturális változásai - nem határozható meg pontosan. Általánosságban elmondható, hogy a tisztán poliuretánból készült vagy poliuretán talpú cipők maximális élettartama a gyártástól számítva három év. A kizárólag PVC anyagú cipők élettartama a gyártástól számított öt év, míg a bőr felsőrésszel és gumiból, hőképlékeny anyagból és EVA anyagú cipők élettartama a gyártástól számított tíz év. Az élettartam ellenőrzött körülmények között csomagolt és tárolt új lábbelikre vonatkozik, vagyis ahol a hőmérséklet és a relatív páratartalom nem változik meg hirtelen.

EURÓPAI SZABVÁNYOK ÉS MAGYARÁZATUK EN ISO 20345:2011 - EN ISO 20347:2012

MEGFELELÉS AZ EN ISO 20345:2011 SZABVÁNYNAK

Ez a nemzetközi szabvány alap és kiegészítő (választható) követelményeket ír elő az általános célú biztonsági lábbelikre.

Az EN ISO 20345:2011 szabványnak megfelelő lábbelik jelölése "S" (=Safety, azaz biztonsági), az orr részük 200 Joule energiájú behatásnak ellenáll.

MEGFELELÉS AZ EN ISO 20347:2012 SZABVÁNYNAK

Ez a nemzetközi szabvány alap és kiegészítő (választható) követelményeket ír elő azokra a munkalábbelikre, amelyek nincsenek kitéve semmilyen mechanikai kockázatnak (ütés vagy nyomás). Az EN ISO 20347:2012 szabványnak megfelelő lábbelik jelölése "O" (=Occupational, azaz munka). A tulajdonságaik a fenti lábbelikkal szinte teljesen megegyeznek azzal a különbséggel, hogy nem követelmény az orrvédő és az áthatolásvédett középtalp.

Az EN ISO 20345:2011 szerinti alapvető követelmények mellett a lábbelik kiegészítő követelményeknek is megfelelhetnek, amit a lábbeli nyelvén található címkén kell szimbólummal vagy betűvel jelölni.

EURÓPAI SZABVÁNYOK ÉS MAGYARÁZATUK EN ISO 20345:2022 - EN ISO 20347:2022

MEGFELELÉS AZ EN ISO 20345:2022 SZABVÁNYNAK

Ez a nemzetközi szabvány alap és kiegészítő (választható) követelményeket ír elő az általános célú biztonsági lábbelikre.

Az EN ISO 20345:2022 szabványnak megfelelő lábbelik jelölése "S" (=Safety, azaz biztonsági), az orr részük 200 Joule energiájú behatásnak ellenáll.

MEGFELELÉS AZ EN ISO 20347:2022 SZABVÁNYNAK

Ez a nemzetközi szabvány alap és kiegészítő (választható) követelményeket ír elő azokra a munkalábbelikre, amelyek nincsenek kitéve semmilyen mechanikai kockázatnak (ütés vagy nyomás). Az EN ISO 20347:2022 szabványnak megfelelő lábbelik jelölése "O" (=Occupational, azaz munka). A tulajdonságaik a fenti lábbelikkal szinte teljesen megegyeznek azzal a különbséggel, hogy nem követelmény az orrvédő és az áthatolásvédett középtalp.

Az EN ISO 20345:2022 szerinti alapvető követelmények mellett a lábbelik kiegészítő követelményeknek is megfelelhetnek, amit a lábbeli nyelvén található címkén kell szimbólummal vagy betűvel jelölni.

Tájékoztató az átszúródásvédő betéttel ellátott lábbelikről

A cipő talpátszúródás elleni védelmét a laboratóriumunkban, szabványos szögekkel és hatóerővel teszteltük. A kisebb átmérőjű szögek, illetve a nagyobb statikus vagy dinamikus terhelés esetén nagyobb az átszúródás kockázata. Ilyen körülmények között további megelőző intézkedéseket is figyelembe kell venni. A munkavédelmi lábbelik jelenleg három különböző átszúródásvédő betéttel kaphatók. A fém vagy nem fém betétet a munka során előforduló kockázatok figyelembevételével kell kiválasztani. Mindhárom betét védelmet nyújt a talpátszúródás ellen, mindazonáltal megvannak a saját előnyei vagy hátrányai, így például:

- Talpátszúródás ellen védő fém betét: az átszúródással szembeni ellenállást kevésbé befolyásolja a hegyes tárgy formája (pl. átmérő, geometria, hegy), viszont a cipő gyártásához meghatározott méretkorlátok miatt a betét nem fed le a teljes talpaprészt.
- Talpátszúródás ellen védő nem fém betét (PL): könnyű, rugalmas és a fémbetéhez képest nagyobb felületet fed le, de az átszúródás elleni védelem foka nagy mértékben függhet a hegyes tárgy formájától (pl. átmérő, geometria, hegy).
- Talpátszúródás ellen védő nem fém betét (PS): könnyű, rugalmas és a fémbetéhez képest nagyobb felületet fed le, de az átszúródás elleni védelem foka nagy mértékben függhet a hegyes tárgy formájától (pl. átmérő, geometria, hegy). A PS besorolású betétek a PL betéteknél nagyobb védelmet nyújtanak a kisebb átmérőjű tárgyak ellen.

OSZTÁLYOZÁS

- I. osztály: Bőrből vagy egyéb anyagból készült lábbeli a tisztán gumi és tisztán polimer kivételével.
- II. osztály: Tiszta gumi (vulkanizált) vagy tiszta polimer (fröccsöntött).

ALAPKÖVETELMÉNYEK

- **A teljes cipő:** felsőrész magassága; sarokrész; talprész szerkezeti teljesítménye (kialakítás és a felsőrész/talprész kötésének erőssége); lábujjvédelem és az orrvédő tulajdonságai (kivéve az EN ISO 20347 szabvány alá tartozó cipők); csúszásállóság.
- **Felsőrész:** a felsőrész, bélés, nyelv, talpbetét/talpbélés tulajdonságai (szakítószilárdság, kopásállóság, nyúlási tulajdonságok, vízgőz átteresztőképesség, pH, talpbetét abszorpció és deszorpció).
- **Talp:** felépítés és szakítószilárdság, kopásállóság, hajtogatással szembeni ellenállás, hidrolízissel szembeni ellenállás, a rétegek közti kötés erőssége és a szénhidrogén olajoknak való ellenállás.

VÉDELMI OSZTÁLY	EN ISO 20345:2011				EN ISO 20347:2012				EN ISO 20345:2011		EN ISO 20347:2012		MINIMÁLIS KÖVETELMÉNYEK
	SB	S1	S2	S3	OB	O1	O2	O3	S4	S5	O4	O5	
Zárt kéreg	0	X	X	X	0	X	X	X	X	X	X	X	
200 joule energiájú behatásnak ellenálló orrvédő	X	X	X	X	-	-	-	-	X	X	-	-	
A Antisztatikus lábbeli	0	X	X	X	0	X	X	X	X	X	X	X	Elektromos ellenállás >100 kΩ, ≤1000 MΩ
E Energiaelnyelő sarok	0	X	X	X	0	X	X	X	X	X	X	X	> 20 Joules
WRU Vízáteresztéssel szemben ellenálló felsőrész	0	-	X	X	0	-	X	X	-	-	-	-	Vízáteresztés: <0,2 g x 60 perc Vízfelvétel: <30% x 60 perc
P Talpátszűrődés elleni védelem	0	0	-	X	0	0	-	X	0	X	0	X	> 1100 N
CI Hideg elleni védelem	0	0	0	0	0	0	0	0	0	0	0	0	A talp belső felületének hőmérsékletváltozása: <10 °C
HI Hőszigetelt	0	0	0	0	0	0	0	0	0	0	0	0	A talp belső felületének hőmérsékletváltozása: <22° C
HRO Hőálló járótalp	0	0	0	0	0	0	0	0	0	0	0	0	Hőállóság max. 300°
WR Vízállóság	0	0	0	0	0	0	0	0	-	-	-	-	Vízfelvétel: < 3 cm ²
FO Fűtőolaj ellen védő járótalp	0	X	X	X	0	0	0	0	X	X	0	0	Járótalp volumnövekedés <12%
SRC Csúszásmentes járótalp	X	X	X	X	X	X	X	X					SRA + SRB követelmény

X	A védelmi osztályra kötelezően előírt követelmény
O	A kötelezően előírt követelmények melletti opcionális követelmény, amennyiben a jelölés tartalmazza
-	Nem kötelezően előírt követelmény, ellenőrizze a cipő jelölését

Antisztatikus lábbeli:

Antisztatikus lábbelit az elektrostatikus minimalizálása érdekében szükséges viselni ott, ahol meg kell előzni a gyúlékony anyagok és gőzök begyulladását, valamint a feszültség alatt álló alkatrészek okozta esetleges áramütést. Az antisztatikus lábbeli nem nyújt védelmet az áramütés ellen, mivel mindössze a padló és a viselő lába között hoz létre elektromos ellenállást. Amennyiben az áramütésveszély nem küszöbölhető ki teljesen, a munkahelyi balesetmegelőzésre vonatkozó tervekben további óvintézkedéseket szükséges tenni. Az antisztatikus követelmények teljesüléséhez a lábbelit tilos átalakítani.

Szigetelő lábbeli:

A szigetelő lábbelik védelmet nyújtanak a maximum 1000 V feszültség véletlen érintése esetén feltéve, hogy a felhasználási körülmények nem változnak, például a villamos ellenállás pára hatására nem változik. Felhívjuk a figyelmet, hogy a lábbeli villamos ellenállása nem a felsőrészre, hanem a talprészre vonatkozik.

Lábbelik villamos osztályai:

- 00 osztály 500V CA vagy 750V CC
- 0 osztály 1000V CA vagy 1500V CC

Disszipatív lábbeli EPA környezetbe:

A kifejezetten EPA (ESDS) környezetre tervezett disszipatív lábbelik lehetővé teszik, hogy a villamos töltés a viselő testétől folyamatos és kontrollált módon oszoljon szét, ezzel védve a villamos alkatrészeket és eszközöket az elektrostatikus jelenségek ellen. A CEI EN 61340-5-1:2016 alapján a földelési ellenállás referenciaértéke a viselő/lábbeli/padló között <1 × 10⁹ Ω.

MUNKAVÉDELMI CIPŐKRE VONATKOZÓ ALAPKÖVETELMÉNYEK + KIEGÉSZÍTŐ KÖVETELMÉNYEK

OSZTÁLYOZÁS

- I. osztály: Bőrből vagy egyéb anyagból készült lábbeli a tisztán gumi és tisztán polimer kivételével.
- II. osztály: Tiszta gumi (vulkanizált) vagy tiszta polimer (fröccsöntött).

ALAPKÖVETELMÉNYEK

- **A teljes cipő:** felsőrész magassága; sarokrész; talpész szerkezeti teljesítménye (kialakítás és a felsőrész/talpész kötésének erőssége); lábujjvédelem és az orrvédő tulajdonságai (kivéve az EN ISO 20347 szabvány alá tartozó cipők); csúszásállóság.
- **Felső rész:** a felsőrész, bélés, nyelv, talpbetét/talpbélés tulajdonságai (szakítószilárdság, kopásállóság, nyúlási tulajdonságok, vízgőz áteresztőképesség, pH, talpbetét abszorpció és deszorpció).
- **Talp:** felépítés és szakítószilárdság, kopásállóság, hajtogatással szembeni ellenállás, hidrolízissel szembeni ellenállás, a rétegek közti kötés erőssége és a szénhidrogén olajoknak való ellenállás.

VÉDELMI OSZTÁLY	EN ISO 20345:2022											EN ISO 20347:2022						MINIMÁLIS KÖVETELMÉNYEK
	SB	S1	S2	S3	S3L	S3S	S6	S7	S7L	S7S	OB	O1	O2	O3	O3L	O3S		
Osztály	I o II	I	I	I	I	I	I	I	I	I	I o II	I	I	I	I	I		
Zárt sarokrész	0	X	X	X	X	X	X	X	X	X	0	X	X	X	X	X		
200 joule energiájú behatásnak ellenálló orrvédő	X	X	X	X	X	X	X	X	X	X	-	-	-	-	-	-		
Megerősített járótalp	0	0	0	X	X	X	0	X	X	X	0	0	0	X	X	X		
P Talpátszűrődés elleni védelem (P fém betét)	0	0	0	X	-	-	0	X	-	-	0	0	0	X	-	-		
PL Talpátszűrődés elleni védelem (nem fém betét, szöggel bevizsgálva, Ø 4.5 mm)	0	0	0	-	X	-	0	-	X	-	0	0	0	-	X	-		
PS Talpátszűrődés elleni védelem (nem fém betét, szöggel bevizsgálva, Ø 3.0 mm)	0	0	0	-	-	X	0	-	-	X	0	0	0	-	-	X		
A Antisztatikus lábbeli	0	X	X	X	X	X	X	X	X	X	0	X	X	X	X	X		
HI Hőszigetelt talpbetét	0	0	0	0	0	0	0	0	0	0	0	0	0	0	0	0		
CI Hideg ellen szigetelt talpbetét	0	0	0	0	0	0	0	0	0	0	0	0	0	0	0	0		
E Energiaelnyelő sarokrész	0	X	X	X	X	X	X	X	X	X	0	X	X	X	X	X		
WR Vízállóság	0	0	0	0	0	0	X	X	X	X	0	0	0	0	0	0		
SC Kopásálló orrmerevítő	0	0	0	0	0	0	0	0	0	0	0	0	0	0	0	0		
SR Glicerines kerámiapadlón csúszásálló	X	X	X	X	X	X	X	X	X	X	X	X	X	X	X	X		
WPA Vízáteresztéssel és vízfelvétellel szembeni ellenállás	0	0	X	X	X	X	-	-	-	-	0	0	X	X	X	X		
HRO Kontakthóval szemben ellenálló járótalp	0	0	0	0	0	0	0	0	0	0	0	0	0	0	0	0		
FO Szénhidrogéneknek való ellenállás	0	0	0	0	0	0	0	0	0	0	0	0	0	0	0	0		
LG Bordázott talp	0	0	0	0	0	0	0	0	0	0	0	0	0	0	0	0		

X	A védelmi osztályra kötelezően előírt követelmény
O	A kötelezően előírt követelmények melletti opcionális követelmény, amennyiben a jelölés tartalmazza
-	Nem kötelezően előírt követelmény, ellenőrizze a cipő jelölését

Részlegesen vezetőképes cipők

Részlegesen vezetőképes cipők viselete olyan helyzetekben ajánlott, amikor az elektrosztatikus töltést a lehető legrövidebb időn belül kell a minimumra csökkenteni, például robbanóanyagok mozgatása során.

Nem ajánlott vezetőképes cipőt viselni, amennyiben fennáll váltó- vagy egyenáramú villamos készülékekből vagy feszültség alatt lévő egységekből eredő áramütés veszélye. A lábbelik részleges elektromos vezetőképességének biztosítása érdekében az új cipők maximális ellenállása 100 kΩ.

Antisztatikus lábbeli

Antisztatikus lábbelit az elektrosztatikusság minimalizálása érdekében szükséges viselni ott, ahol meg kell előzni a gyúlékony anyagok és gőzök begyulladását, valamint a feszültség alatt álló alkatrészek okozta esetleges áramütést. Az antisztatikus lábbeli nem nyújt védelmet az áramütés ellen, mivel mindössze a padló és a viselő lába között hoz létre elektromos ellenállást. Amennyiben az áramütésveszély nem küszöbölhető ki teljesen, a munkahelyi balesetmegelőzésre vonatkozó tervekben további óvintézkedéseket szükséges tenni. Az antisztatikus követelmények teljesüléséhez a lábbelit tilos átalakítani.

NB A szabvány korábbi változata szerint tanúsított cipők tanúsítványa annak érvényességéig marad hatályban.

EN ISO 20345:2011 S1P SRC

TERMÉKCSOPORT	CIKK	KÖVETELMÉNYEK			AJÁNLOTT TERÜLETEK							📄
		TOVÁBBI KÖVETELMÉNYEK			JÁRMŰIPAR	ÉPÍTŐIPAR	VILLAMOSSÁG	IPAR	SZOLGÁLTATÁS-LOGISZTIKA	FÜTÉS ÉS VÍVEZETÉKSZERELÉS		
	7210BKK			X	X	X	X	X	X	X	596	
	7216BKK			X	X	X	X	X	X	X	597	
	7212G	ESD		X	X	X	X	X	X		593	
	7212B	ESD									593	
	7213G	ESD		X	X	X	X	X	X		593	
	7212LG			X	X	X	X	X	X		593	
	7222PEK			X	X	X	X	X	X		591	
	7223PEK			X	X	X	X	X	X		592	
	7224PEK			X	X	X	X	X	X		592	
	7225PEK			X	X	X	X	X	X		592	
	7241BK				X	X	X	X	X		588	
	7243BK				X	X	X	X	X		588	
	7246BK				X	X	X	X	X		590	
	7247BK				X	X	X	X	X		590	
	7246E				X		X	X	X		587	
	7248GK				X		X	X	X		598	
	7249GK	RS			X		X		X		598	
	7314AF			X	X	X	X	X	X		599	
	7316NB	ESD		X	X	X	X	X	X		600	
	7316NG	ESD		X	X	X	X	X	X		600	
	7317NA			X	X	X	X	X	X		600	
	7340B				X		X	X	X		607	
	7352A	HRO		X	X	X	X	X	X		602	
	7352B	HRO		X	X	X	X	X	X		602	
	7352G	HRO ESD	X	X	X	X	X	X	X		602	
	7353Y	HRO			X	X	X	X	X		603	
	7372B	HRO	X	X	X	X	X	X	X		606	
	7376A	HRO	X	X	X	X	X	X	X		606	
	7352LG	HRO		X	X	X	X	X	X		603	

EN ISO 20347:2012 O1 SRC

TERMÉKCSOPORT	CIKK	KÖVETELMÉNYEK	AJÁNLOTT TERÜLETEK	📄
	7362B	FO HRO	X X X X	605

EN ISO 20347:2012 O2 SRC

TERMÉKCSOPORT	CIKK	KÖVETELMÉNYEK	AJÁNLOTT TERÜLETEK	📄
	7243FT	FO	X X	589
	7363N	FO HRO	X X X X	605

EN ISO 20345:2011 S3 SRC

TERMÉKCSOPORT	CIKK	KÖVETELMÉNYEK			AJÁNLOTT TERÜLETEK							📄
		TOVÁBBI KÖVETELMÉNYEK			MEZŐGAZDASÁG	JÁRMŰIPAR	ÉPÜLET	IPAR	VILLAMOSSÁG	SZOLGÁLTATÁS-LOGISZTIKA	OLAJ- ÉS GÁZIPAR	
	7200BKK			X	X	X	X	X	X	X	X	596
	7201BKK			X	X	X	X	X	X	X	X	596
	7310CRK	RS HRO			X	X	X	X		X		597
	7214FN			X	X	X	X	X	X	X		594
	7214G	ESD		X	X	X	X	X	X	X		594
	7215FN			X	X	X	X	X	X	X		595
	7218FN	RS		X	X	X	X	X	X	X		595
	7218G	RS ESD		X	X	X	X	X	X	X		595
	7214LN			X	X	X	X	X	X	X		594
	7220PEK			X	X	X	X	X	X	X		591
	7221PEK	RS		X	X	X	X	X	X	X		591
	7235BK				X	X	X	X	X	X		597
	7236BK	RS			X	X	X	X	X	X		598
	7238WR	RS HRO WR			X	X	X	X	X	X		598
	7239B				X	X	X	X	X	X		598
	7241EN				X	X	X	X	X	X		587
	7243EN	RS			X	X	X	X	X	X		587
	7241CK				X	X	X	X	X	X		588
	7243CK	RS			X	X	X	X	X	X		589
	7243CR	RS HRO			X	X	X	X	X	X		589
	7245BK	RS			X	X	X	X	X	X		589
	7293HM	HRO HI	X		X	X	X	X	X	X		608
	7293HN	HRO HI	X		X	X	X	X	X	X		608
	7294HM	HRO HI	X		X	X	X	X	X	X		609
	7294HMC	HRO HI CI WR	X		X	X	X	X	X	X		609
	7294HN	RS HRO HI	X		X	X	X	X	X	X		609
	7315AN			X	X	X	X	X	X	X		599
	7318AN			X	X	X	X	X	X	X		600
	7320NA			X	X	X	X	X	X	X		601
	7321NA	RS		X	X	X	X	X	X	X		601
	7322SA			X	X	X	X	X	X	X		601
	7323SA	RS		X	X	X	X	X	X	X		601
	7341N				X	X	X	X	X	X		607
	7349RP	HRO	X		X	X	X	X	X	X		607
	7350RP	HRO	X		X	X	X	X	X	X		608
	7354N	HRO	X		X	X	X	X	X	X		603
	7355V	HRO	X		X	X	X	X	X	X		603
	7356G	HRO	X		X	X	X	X	X	X		604
	7357G	HRO	X		X	X	X	X	X	X		604
	7356V	HRO	X		X	X	X	X	X	X		604
	7357V	HRO	X		X	X	X	X	X	X		605
	7356LN	HRO	X		X	X	X	X	X	X		604
	7381N	HRO WR	X	X	X	X	X	X	X	X		606
	7382N	HRO WR	X	X	X	X	X	X	X	X		606

EN ISO 20345:2011 S5 SRC

TERMÉKCSOPORT	CIKK	KÖVETELMÉNYEK	AJÁNLOTT TERÜLETEK	📄
	7328A		X X X	590
	7328N		X X X	590

EASY



7241EN

mérsékeltlen vízálló bőrcipő

- Acél orrvédő
- Áthatolásvédett középtalp rugalmas acélból

**EN ISO
20345
2011**



EU	UK	mm	Ft	👤	🏠
35	2,5	230	11.750	1	072410835
36	3,5	237	11.750	1	072410836
37	4,5	244	11.750	1	072410837
38	5	250	11.750	1	072410838
39	6	257	11.750	1	072410839
40	6,5	264	11.750	1	072410840
41	7	270	11.750	1	072410841
42	8	277	11.750	1	072410842
43	9	284	11.750	1	072410843
44	10	290	11.750	1	072410844
45	10,5	297	11.750	1	072410845
46	11	304	11.750	1	072410846
47	12	310	11.750	1	072410847
48	13	317	11.750	1	072410848



CE

S3 SRC

7243EN

mérsékeltlen vízálló bokacipő
gyorskioldással

- Acél orrvédő
- Áthatolásvédett középtalp rugalmas acélból

**EN ISO
20345
2011**



EU	UK	mm	Ft	👤	🏠
35	2,5	230	12.150	1	072430835
36	3,5	237	12.150	1	072430836
37	4,5	244	12.150	1	072430837
38	5	250	12.150	1	072430838
39	6	257	12.150	1	072430839
40	6,5	264	12.150	1	072430840
41	7	270	12.150	1	072430841
42	8	277	12.150	1	072430842
43	9	284	12.150	1	072430843
44	10	290	12.150	1	072430844
45	10,5	297	12.150	1	072430845
46	11	304	12.150	1	072430846
47	12	310	12.150	1	072430847
48	13	317	12.150	1	072430848



CE

S3 RS SRC

7246E

perforált hasítottbőr félcipő

- Acél orrvédő
- Áthatolásvédett középtalp rugalmas acélból

**EN ISO
20345
2011**



EU	UK	mm	Ft	👤	🏠
35	2,5	230	12.200	1	072460435
36	3,5	237	12.200	1	072460436
37	4,5	244	12.200	1	072460437
38	5	250	12.200	1	072460438
39	6	257	12.200	1	072460439
40	6,5	264	12.200	1	072460440
41	7	270	12.200	1	072460441
42	8	277	12.200	1	072460442
43	9	284	12.200	1	072460443
44	10	290	12.200	1	072460444
45	10,5	297	12.200	1	072460445
46	11	304	12.200	1	072460446
47	12	310	12.200	1	072460447
48	13	317	12.200	1	072460448



CE

S1P SRC

BASIC



7241BK bőr cipő

- Acél orrvédő
- Áthatolásvédett középtalp kompozit szálból

EU	UK	mm	Ft		
35	2,5	228	13.900	1	072411235
36	3,5	235	13.900	1	072411236
37	4,5	242	13.900	1	072411237
38	5	248	13.900	1	072411238
39	6	255	13.900	1	072411239
40	6,5	262	13.900	1	072411240
41	7	268	13.900	1	072411241
42	8	275	13.900	1	072411242
43	9	282	13.900	1	072411243
44	10	288	13.900	1	072411244
45	10,5	295	13.900	1	072411245
46	11	302	13.900	1	072411246
47	12	308	13.900	1	072411247
48	13	315	13.900	1	072411248



CE

S1P SRC

**EN ISO
20345
2011**



7241CK mérsékeltlen vízálló bőr cipő

- Acél orrvédő
- Áthatolásvédett középtalp kompozit szálból

EU	UK	mm	Ft		
35	2,5	228	15.550	1	072411535
36	3,5	235	15.550	1	072411536
37	4,5	242	15.550	1	072411537
38	5	248	15.550	1	072411538
39	6	255	15.550	1	072411539
40	6,5	262	15.550	1	072411540
41	7	268	15.550	1	072411541
42	8	275	15.550	1	072411542
43	9	282	15.550	1	072411543
44	10	288	15.550	1	072411544
45	10,5	295	15.550	1	072411545
46	11	302	15.550	1	072411546
47	12	308	15.550	1	072411547
48	13	315	15.550	1	072411548



CE

S3 SRC

**EN ISO
20345
2011**



7243BK Bőr bokacipő

- Acél orrvédő
- Áthatolásvédett középtalp kompozit szálból

EU	UK	mm	Ft		
35	2,5	228	14.450	1	072431235
36	3,5	235	14.450	1	072431236
37	4,5	242	14.450	1	072431237
38	5	248	14.450	1	072431238
39	6	255	14.450	1	072431239
40	6,5	262	14.450	1	072431240
41	7	268	14.450	1	072431241
42	8	275	14.450	1	072431242
43	9	282	14.450	1	072431243
44	10	288	14.450	1	072431244
45	10,5	295	14.450	1	072431245
46	11	302	14.450	1	072431246
47	12	308	14.450	1	072431247
48	13	315	14.450	1	072431248



CE

S1P SRC

**EN ISO
20345
2011**



7243CK

mérsékeltén vízálló bokacipő
gyorskioldással

- Acél orrvédő
- Áthatolásvédett középtalp kompozit szálból

EU	UK	mm	Ft		
35	2,5	228	15.150	1	072431335
36	3,5	235	15.150	1	072431336
37	4,5	242	15.150	1	072431337
38	5	248	15.150	1	072431338
39	6	255	15.150	1	072431339
40	6,5	262	15.150	1	072431340
41	7	268	15.150	1	072431341
42	8	275	15.150	1	072431342
43	9	282	15.150	1	072431343
44	10	288	15.150	1	072431344
45	10,5	295	15.150	1	072431345
46	11	302	15.150	1	072431346
47	12	308	15.150	1	072431347
48	13	315	15.150	1	072431348

CE



S3 RS SRC

EN ISO
20345
2011



7243CR

bőr bokacipő, mérsékeltén vízálló hosszú
élettartamú gumitalp
és gyorskioldás

- Acél orrvédő
- Áthatolásvédett rugalmas acél középtalp

EU	UK	mm	Ft		
35	2,5	231	21.350	1	072430735
36	3,5	238	21.350	1	072430736
37	4,5	245	21.350	1	072430737
38	5	251	21.350	1	072430738
39	6	258	21.350	1	072430739
40	6,5	265	21.350	1	072430740
41	7	271	21.350	1	072430741
42	8	278	21.350	1	072430742
43	9	285	21.350	1	072430743
44	10	291	21.350	1	072430744
45	10,5	298	21.350	1	072430745
46	11	305	21.350	1	072430746
47	12	311	21.350	1	072430747
48	13	318	21.350	1	072430748

CE



S3 RS HRO SRC

EN ISO
20345
2011



7243FT

bőr bokacipő, mérsékeltén vízálló
orrvédő és áthatolásvédett középtalp nélkül

- Orrvédő nélkül
- Áthatolásvédett középtalp nélkül

EU	UK	mm	Ft		
35	2,5	228	12.300	1	072430635
36	3,5	235	12.300	1	072430636
37	4,5	242	12.300	1	072430637
38	5	248	12.300	1	072430638
39	6	255	12.300	1	072430639
40	6,5	262	12.300	1	072430640
41	7	268	12.300	1	072430641
42	8	275	12.300	1	072430642
43	9	282	12.300	1	072430643
44	10	288	12.300	1	072430644
45	10,5	295	12.300	1	072430645
46	11	302	12.300	1	072430646
47	12	308	12.300	1	072430647
48	13	315	12.300	1	072430648

CE



O2 FO SRC

EN ISO
20347
2012



7245BK

mérsékeltén vízálló fűzős "hegesztő" bokacipő gyorskioldással
és tépőzáras első védőnyelvvel

- Acél orrvédő
- Áthatolásvédett középtalp kompozit szálból

EU	UK	mm	Ft		
35	2,5	228	16.350	1	072451235
36	3,5	235	16.350	1	072451236
37	4,5	242	16.350	1	072451237
38	5	248	16.350	1	072451238
39	6	255	16.350	1	072451239
40	6,5	262	16.350	1	072451240
41	7	268	16.350	1	072451241
42	8	275	16.350	1	072451242
43	9	282	16.350	1	072451243
44	10	288	16.350	1	072451244
45	10,5	295	16.350	1	072451245
46	11	302	16.350	1	072451246
47	12	308	16.350	1	072451247
48	13	315	16.350	1	072451248

CE



S3 RS SRC

EN ISO
20345
2011



7246BK

perforált hasítottbőr cipő

- Acél orrvédő
- Áthatolásvédett középtalp kompozit szálból

EU	UK	mm	Ft	♂	♀
35	2,5	228	14.950	1	072461235
36	3,5	235	14.950	1	072461236
37	4,5	242	14.950	1	072461237
38	5	248	14.950	1	072461238
39	6	255	14.950	1	072461239
40	6,5	262	14.950	1	072461240
41	7	268	14.950	1	072461241
42	8	275	14.950	1	072461242
43	9	282	14.950	1	072461243
44	10	288	14.950	1	072461244
45	10,5	295	14.950	1	072461245
46	11	302	14.950	1	072461246
47	12	308	14.950	1	072461247
48	13	315	14.950	1	072461248



CE

S1P SRC

EN ISO
20345
2011



7247BK

perforált bőrszandál

- Acél orrvédő
- Áthatolásvédett középtalp kompozit szálból

EU	UK	mm	Ft	♂	♀
35	2,5	228	14.500	1	072471235
36	3,5	235	14.500	1	072471236
37	4,5	242	14.500	1	072471237
38	5	248	14.500	1	072471238
39	6	255	14.500	1	072471239
40	6,5	262	14.500	1	072471240
41	7	268	14.500	1	072471241
42	8	275	14.500	1	072471242
43	9	282	14.500	1	072471243
44	10	288	14.500	1	072471244
45	10,5	295	14.500	1	072471245
46	11	302	14.500	1	072471246
47	12	308	14.500	1	072471247
48	13	315	14.500	1	072471248



CE

S1P SRC

EN ISO
20345
2011



7328A

„Top Visibility” nitril-PVC munkavédelmi csizma
Öntisztító, csúszásmentes járőfelület.

- Acél orrvédő
- Rugalmas, áthatolásvédett acél köztalp

EU	UK	mm	Ft	♂	♀
38	5	253	13.450	1	073280638
39	6	260	13.450	1	073280639
40	6,5	267	13.450	1	073280640
41	7	273	13.450	1	073280641
42	8	280	13.450	1	073280642
43	9	287	13.450	1	073280643
44	10	293	13.450	1	073280644
45	10,5	300	13.450	1	073280645
46	11	307	13.450	1	073280646
47	12	313	13.450	1	073280647



CE

S5 SRC

EN ISO
20345
2011



7328N

nitril-PVC munkavédelmi csizma
Öntisztító, csúszásmentes járőfelület.

- Acél orrvédő
- Rugalmas, áthatolásvédett acél köztalp

EU	UK	mm	Ft	♂	♀
38	5	253	13.450	1	073280838
39	6	260	13.450	1	073280839
40	6,5	267	13.450	1	073280840
41	7	273	13.450	1	073280841
42	8	280	13.450	1	073280842
43	9	287	13.450	1	073280843
44	10	293	13.450	1	073280844
45	10,5	300	13.450	1	073280845
46	11	307	13.450	1	073280846
47	12	313	13.450	1	073280847



CE

S5 SRC

EN ISO
20345
2011



EASY PLUS



7220PEK

mérsékeltlen vízálló bőrcipő nylon betétekkel és kopásálló megerősítéssel az orr területén

- Orrvédő kompozit anyagból
- Áthatolásvédett középtalp kompozit szálból

EU	UK	mm	Ft	☞	☞
35	2,5	228	19.300	1	072200235
36	3,5	235	19.300	1	072200236
37	4,5	242	19.300	1	072200237
38	5	248	19.300	1	072200238
39	6	255	19.300	1	072200239
40	6,5	262	19.300	1	072200240
41	7	268	19.300	1	072200241
42	8	275	19.300	1	072200242
43	9	282	19.300	1	072200243
44	10	288	19.300	1	072200244
45	10,5	295	19.300	1	072200245
46	11	302	19.300	1	072200246
47	12	308	19.300	1	072200247
48	13	315	19.300	1	072200248

CE



S3 SRC

EN ISO
20345
2011

METAL
FREE



7221PEK

mérsékeltlen vízálló bőr bokacipő nylon betétekkel kopásálló erősítéssel az orr területén, és gyorskioldással

- Orrvédő kompozit anyagból
- Áthatolásvédett középtalp kompozit szálból

EU	UK	mm	Ft	☞	☞
35	2,5	228	20.600	1	072210235
36	3,5	235	20.600	1	072210236
37	4,5	242	20.600	1	072210237
38	5	248	20.600	1	072210238
39	6	255	20.600	1	072210239
40	6,5	262	20.600	1	072210240
41	7	268	20.600	1	072210241
42	8	275	20.600	1	072210242
43	9	282	20.600	1	072210243
44	10	288	20.600	1	072210244
45	10,5	295	20.600	1	072210245
46	11	302	20.600	1	072210246
47	12	308	20.600	1	072210247
48	13	315	20.600	1	072210248

CE



S3 RS SRC

EN ISO
20345
2011

METAL
FREE



7222PEK

perforált hasítottbőr cipő, jól szellőző mesh betétekkel

- Kompozit orr rész
- Kompozitszálás, áthatolásvédett köztalp

EU	UK	mm	Ft	☞	☞
35	2,5	228	20.350	1	072220135
36	3,5	235	20.350	1	072220136
37	4,5	242	20.350	1	072220137
38	5	248	20.350	1	072220138
39	6	255	20.350	1	072220139
40	6,5	262	20.350	1	072220140
41	7	268	20.350	1	072220141
42	8	275	20.350	1	072220142
43	9	282	20.350	1	072220143
44	10	288	20.350	1	072220144
45	10,5	295	20.350	1	072220145
46	11	302	20.350	1	072220146
47	12	308	20.350	1	072220147
48	13	315	20.350	1	072220148

CE



S1P SRC

EN ISO
20345
2011

METAL
FREE



7223PEK

hasítottbőr cipő jól szellőző mesh betétekkel és kopásálló megerősítéssel az orr területén

- Orrvédő kompozit anyagból
- Áthatolásvédett középtalp kompozit szálból

EU	UK	mm	Ft		
35	2,5	228	20.450	1	072230135
36	3,5	235	20.450	1	072230136
37	4,5	242	20.450	1	072230137
38	5	248	20.450	1	072230138
39	6	255	20.450	1	072230139
40	6,5	262	20.450	1	072230140
41	7	268	20.450	1	072230141
42	8	275	20.450	1	072230142
43	9	282	20.450	1	072230143
44	10	288	20.450	1	072230144
45	10,5	295	20.450	1	072230145
46	11	302	20.450	1	072230146
47	12	308	20.450	1	072230147
48	13	315	20.450	1	072230148



CE

S1P SRC



EN ISO 20345 2011



7224PEK

perforált hasítottbőr cipő kopásálló erősítéssel az orr területén

- Orrvédő kompozit anyagból
- Áthatolásvédett középtalp kompozit szálból

EU	UK	mm	Ft		
35	2,5	228	20.450	1	072240235
36	3,5	235	20.450	1	072240236
37	4,5	242	20.450	1	072240237
38	5	248	20.450	1	072240238
39	6	255	20.450	1	072240239
40	6,5	262	20.450	1	072240240
41	7	268	20.450	1	072240241
42	8	275	20.450	1	072240242
43	9	282	20.450	1	072240243
44	10	288	20.450	1	072240244
45	10,5	295	20.450	1	072240245
46	11	302	20.450	1	072240246
47	12	308	20.450	1	072240247
48	13	315	20.450	1	072240248



CE

S1P SRC



EN ISO 20345 2011



7225PEK

perforált hasítottbőr cipő

- Kompozit orr rész
- Kompozitszálás, áthatolásvédett köztalp

EU	UK	mm	Ft		
35	2,5	228	21.200	1	072250135
36	3,5	235	21.200	1	072250136
37	4,5	242	21.200	1	072250137
38	5	248	21.200	1	072250138
39	6	255	21.200	1	072250139
40	6,5	262	21.200	1	072250140
41	7	268	21.200	1	072250141
42	8	275	21.200	1	072250142
43	9	282	21.200	1	072250143
44	10	288	21.200	1	072250144
45	10,5	295	21.200	1	072250145
46	11	302	21.200	1	072250146
47	12	308	21.200	1	072250147
48	13	315	21.200	1	072250148



CE

S1P SRC



EN ISO 20345 2011



 **Beta**

FLEX



7212B

perforált hasítottbőr cipő, mesh betéttel, kopásgátló betét az orr részen Rendkívül rugalmas és könnyű - a 42-es méret körülbelüli súlya: 490g Nem javasolt nagy igénybevételt jelentő használatra (építőipar, mezőgazdaság, nehézipar)

- Kompozit orrvédő
- Kompozitszálás, áthatolásbiztos betét

EN ISO
20345
2011



EU	UK	mm	Ft	☞	☞
35	2.5	228	22.700	1	072120235
36	3.5	235	22.700	1	072120236
37	4.5	242	22.700	1	072120237
38	5	248	22.700	1	072120238
39	6	255	22.700	1	072120239
40	6.5	262	22.700	1	072120240
41	7	268	22.700	1	072120241
42	8	275	22.700	1	072120242
43	9	282	22.700	1	072120243
44	10	288	22.700	1	072120244
45	10.5	295	22.700	1	072120245
46	11	302	22.700	1	072120246
47	12	308	22.700	1	072120247
48	13	315	22.700	1	072120248



CE

S1P SRC ESD

7212G

perforált hasítottbőr cipő. Kopásgátló betét az orr részen. Rendkívül rugalmas és könnyű - a 42-es méret körülbelüli súlya: 490 g Nem javasolt nagy igénybevételt jelentő munkákhoz (építőipar, mezőgazdaság, nehézipar)

- Kompozit orrvédő
- Kompozitszálás, áthatolásvédett köztalp

EN ISO
20345
2011



EU	UK	mm	Ft	☞	☞
35	2.5	228	22.650	1	072120335
36	3.5	235	22.650	1	072120336
37	4.5	242	22.650	1	072120337
38	5	248	22.650	1	072120338
39	6	255	22.650	1	072120339
40	6.5	262	22.650	1	072120340
41	7	268	22.650	1	072120341
42	8	275	22.650	1	072120342
43	9	282	22.650	1	072120343
44	10	288	22.650	1	072120344
45	10.5	295	22.650	1	072120345
46	11	302	22.650	1	072120346
47	12	308	22.650	1	072120347
48	13	315	22.650	1	072120348



CE

S1P SRC ESD

72121G

perforált női hasítottbőr cipő, mesh betéttel Rendkívül rugalmas és könnyű – a 38-as méret körülbelüli súlya: 380 g Nem javasolt nagy igénybevételt jelentő használatra (építőipar, mezőgazdaság, nehézipar)

- Kompozit orrvédő
- Áthatolásvédett középtalp kompozit szálból

EN ISO
20345
2011



EU	UK	mm	Ft	☞	☞
34	2	222	19.650	1	072120134
35	2.5	228	19.650	1	072120135
36	3.5	235	19.650	1	072120136
37	4.5	242	19.650	1	072120137
38	5	248	19.650	1	072120138
39	6	255	19.650	1	072120139
40	6.5	262	19.650	1	072120140
41	7	268	19.650	1	072120141
42	8	275	19.650	1	072120142



CE

S1P SRC

7213G

perforált hasítottbőr cipő, jól szellőző mesh betétekkel
Rendkívül rugalmas és könnyű - a 42-es méret körülbelüli
súlya: 490g Nem javasolt nagy igénybevételt jelentő
munkákhoz (építőipar, mezőgazdaság, nehézipar)

- Kompozit orrvédő
- Kompozitszálás, áthatolásbiztos betét

EU	UK	mm	Ft	W	W
35	2,5	228	22.700	1	072130135
36	3,5	235	22.700	1	072130136
37	4,5	242	22.700	1	072130137
38	5	248	22.700	1	072130138
39	6	255	22.700	1	072130139
40	6,5	262	22.700	1	072130140
41	7	268	22.700	1	072130141
42	8	275	22.700	1	072130142
43	9	282	22.700	1	072130143
44	10	288	22.700	1	072130144
45	10,5	295	22.700	1	072130145
46	11	302	22.700	1	072130146
47	12	308	22.700	1	072130147
48	13	315	22.700	1	072130148

CE



S1P SRC ESD



EN ISO 20345 2011



7214FN

action nubuk bőr cipő, mérsékelt vízálló
kopásálló orrvédő betéttel Rendkívül rugalmas és könnyű - a
42 méret körülbelüli súlya: 500 g
Nem javasolt nehéz igénybevételhez (építőipar,
mezőgazdaság, nehézipar)

- Orrvédő kompozit anyagból
- Áthatolásvédett középtalp kompozit szálból

EU	UK	mm	Ft	W	W
35	2,5	228	21.400	1	072140035
36	3,5	235	21.400	1	072140036
37	4,5	242	21.400	1	072140037
38	5	248	21.400	1	072140038
39	6	255	21.400	1	072140039
40	6,5	262	21.400	1	072140040
41	7	268	21.400	1	072140041
42	8	275	21.400	1	072140042
43	9	282	21.400	1	072140043
44	10	288	21.400	1	072140044
45	10,5	295	21.400	1	072140045
46	11	302	21.400	1	072140046
47	12	308	21.400	1	072140047
48	13	315	21.400	1	072140048

CE



S3 SRC



EN ISO 20345 2011



7214G

Action vízálló nubuk cipő kopásálló betéttel az orr részen
Rendkívül rugalmas és könnyű - a 42-es méret körülbelüli
súlya: 500g Nem javasolt nagy igénybevételt jelentő
munkákhoz (építőipar, mezőgazdaság, nehézipar)

- Kompozit orrvédő
- Kompozitszálás, áthatolásbiztos betét

EU	UK	mm	Ft	W	W
35	2,5	228	25.800	1	072140235
36	3,5	235	25.800	1	072140236
37	4,5	242	25.800	1	072140237
38	5	248	25.800	1	072140238
39	6	255	25.800	1	072140239
40	6,5	262	25.800	1	072140240
41	7	268	25.800	1	072140241
42	8	275	25.800	1	072140242
43	9	282	25.800	1	072140243
44	10	288	25.800	1	072140244
45	10,5	295	25.800	1	072140245
46	11	302	25.800	1	072140246
47	12	308	25.800	1	072140247
48	13	315	25.800	1	072140248

CE



S3 SRC ESD



EN ISO 20345 2011



7214LN

vízálló női hasítottbőr cipő, kopásálló orrvédő betéttel
Rendkívül rugalmas és könnyű – a 38-as méret körülbelüli
súlya: 380 g
Nem javasolt nagy igénybevételt jelentő használatra (építőipar,
mezőgazdaság, nehézipar)

- Kompozit orrvédő
- Áthatolásvédett középtalp kompozit szálból

EU	UK	mm	Ft	W	W
34	2	222	20.650	1	072140134
35	2,5	228	20.650	1	072140135
36	3,5	235	20.650	1	072140136
37	4,5	242	20.650	1	072140137
38	5	248	20.650	1	072140138
39	6	255	20.650	1	072140139
40	6,5	262	20.650	1	072140140
41	7	268	20.650	1	072140141
42	8	275	20.650	1	072140142

CE



S3 SRC



EN ISO 20345 2011



7215FN

action nabuk bőr mokasszin, mérsékelt vízálló kopásálló orrvédő betéttel Rendkívül rugalmas és könnyű - a 42 méret körülbelüli súlya: 490 g Nem javasolt nehéz igénybevételhez (építőipar, mezőgazdaság, nehézipar)

- Orrvédő kompozit anyagból
- Áthatolásvédett középtalp kompozit szálból

EU	UK	mm	Ft	☑	☑
35	2,5	228	24.250	1	072150135
36	3,5	235	24.250	1	072150136
37	4,5	242	24.250	1	072150137
38	5	248	24.250	1	072150138
39	6	255	24.250	1	072150139
40	6,5	262	24.250	1	072150140
41	7	268	24.250	1	072150141
42	8	275	24.250	1	072150142
43	9	282	24.250	1	072150143
44	10	288	24.250	1	072150144
45	10,5	295	24.250	1	072150145
46	11	302	24.250	1	072150146
47	12	308	24.250	1	072150147
48	13	315	24.250	1	072150148



CE

S3 SRC



EN ISO 20345 2011



7218FN

action nabuk bőr bokacipő, mérsékelt vízálló kopásálló orrvédő betéttel és gyorskioldással Rendkívül rugalmas és könnyű - a 42 méret körülbelüli súlya: 510 g Nem javasolt nehéz igénybevételhez (építőipar, mezőgazdaság, nehézipar)

- Orrvédő kompozit anyagból
- Áthatolásvédett középtalp kompozit szálból

EU	UK	mm	Ft	☑	☑
35	2,5	228	24.850	1	072180035
36	3,5	235	24.850	1	072180036
37	4,5	242	24.850	1	072180037
38	5	248	24.850	1	072180038
39	6	255	24.850	1	072180039
40	6,5	262	24.850	1	072180040
41	7	268	24.850	1	072180041
42	8	275	24.850	1	072180042
43	9	282	24.850	1	072180043
44	10	288	24.850	1	072180044
45	10,5	295	24.850	1	072180045
46	11	302	24.850	1	072180046
47	12	308	24.850	1	072180047
48	13	315	24.850	1	072180048



CE

S3 RS SRC



EN ISO 20345 2011



7218G

Action vízálló nubuk bokacipő kopásálló betéttel az orr részen és gyorskioldással Rendkívül rugalmas és könnyű - a 42-es méret körülbelüli súlya: 550g Nem javasolt nagy igénybevételt jelentő munkákhoz (építőipar, mezőgazdaság, nehézipar)

- Kompozit orrvédő
- Kompozitszál, áthatolásvédett betét

EU	UK	mm	Ft	☑	☑
35	2,5	228	26.950	1	072180135
36	3,5	235	26.950	1	072180136
37	4,5	242	26.950	1	072180137
38	5	248	26.950	1	072180138
39	6	255	26.950	1	072180139
40	6,5	262	26.950	1	072180140
41	7	268	26.950	1	072180141
42	8	275	26.950	1	072180142
43	9	282	26.950	1	072180143
44	10	288	26.950	1	072180144
45	10,5	295	26.950	1	072180145
46	11	302	26.950	1	072180146
47	12	308	26.950	1	072180147
48	13	315	26.950	1	072180148



CE

S3 RS SRC ESD



EN ISO 20345 2011



 **Beta**

BASIC PLUS



7200BKK

Full-grain bőr félcipő, mérsékelten vízálló

Orrvédő kompozit anyagból
Áthatolásbiztos betét kompozit szálból

EU	UK	mm	Ft		
35	2,5	228	22.750	1	072000235
36	3,5	235	22.750	1	072000236
37	4,5	242	22.750	1	072000237
38	5	248	22.750	1	072000238
39	6	255	22.750	1	072000239
40	6,5	262	22.750	1	072000240
41	7	268	22.750	1	072000241
42	8	275	22.750	1	072000242
43	9	282	22.750	1	072000243
44	10	288	22.750	1	072000244
45	10,5	295	22.750	1	072000245
46	11	302	22.750	1	072000246
47	12	308	22.750	1	072000247
48	13	315	22.750	1	072000248



CE

S3 SRC

EN ISO 20345 2011

METAL FREE



7201BKK

Full-grain bőr bokacipő, mérsékelten vízálló

• Orrvédő kompozit anyagból
• Áthatolásbiztos betét kompozit szálból

EU	UK	mm	Ft		
35	2,5	228	23.850	1	072010435
36	3,5	235	23.850	1	072010436
37	4,5	242	23.850	1	072010437
38	5	248	23.850	1	072010438
39	6	255	23.850	1	072010439
40	6,5	262	23.850	1	072010440
41	7	268	23.850	1	072010441
42	8	275	23.850	1	072010442
43	9	282	23.850	1	072010443
44	10	288	23.850	1	072010444
45	10,5	295	23.850	1	072010445
46	11	302	23.850	1	072010446
47	12	308	23.850	1	072010447
48	13	315	23.850	1	072010448



CE

S3 SRC

EN ISO 20345 2011

METAL FREE



7210BKK

Perforált hasítottbőr félcipő

Orrvédő kompozit anyagból
Áthatolásbiztos betét kompozit szálból

EU	UK	mm	Ft		
35	2,5	228	22.300	1	072100335
36	3,5	235	22.300	1	072100336
37	4,5	242	22.300	1	072100337
38	5	248	22.300	1	072100338
39	6	255	22.300	1	072100339
40	6,5	262	22.300	1	072100340
41	7	268	22.300	1	072100341
42	8	275	22.300	1	072100342
43	9	282	22.300	1	072100343
44	10	288	22.300	1	072100344
45	10,5	295	22.300	1	072100345
46	11	302	22.300	1	072100346
47	12	308	22.300	1	072100347
48	13	315	22.300	1	072100348



CE

S1P SRC

EN ISO 20345 2011

METAL FREE



7216BKK

Hasítottbőr szandál,
tépőzárás

- Orrvédő kompozit anyagból
- Áthatolásbiztos betét kompozit szálból

EU	UK	mm	Ft	♂	♀
35	2,5	228	23.000	1	072160335
36	3,5	235	23.000	1	072160336
37	4,5	242	23.000	1	072160337
38	5	248	23.000	1	072160338
39	6	255	23.000	1	072160339
40	6,5	262	23.000	1	072160340
41	7	268	23.000	1	072160341
42	8	275	23.000	1	072160342
43	9	282	23.000	1	072160343
44	10	288	23.000	1	072160344
45	10,5	295	23.000	1	072160345
46	11	302	23.000	1	072160346
47	12	308	23.000	1	072160347
48	13	315	23.000	1	072160348

CE



S1P SRC

METAL
FREE

EN ISO
20345
2011



7310CRK

mérsékeltlen vízálló fűzős "hegesztő" préseltbőr cipő
gyorskioldással, és tépőzárás első védőnyelven és lángálló
varrással Nagy ellenállású gumitalp és kopásálló betét az orr
területén

- Orrvédő kompozit anyagból
- Áthatolásvédett középtalp kompozit szálból

EU	UK	mm	Ft	♂	♀
35	2,5	227	26.750	1	073100335
36	3,5	234	26.750	1	073100336
37	4,5	241	26.750	1	073100337
38	5	247	26.750	1	073100338
39	6	254	26.750	1	073100339
40	6,5	261	26.750	1	073100340
41	7	267	26.750	1	073100341
42	8	274	26.750	1	073100342
43	9	281	26.750	1	073100343
44	10	287	26.750	1	073100344
45	10,5	294	26.750	1	073100345
46	11	301	26.750	1	073100346
47	12	307	26.750	1	073100347
48	13	314	26.750	1	073100348

CE



S3 RS HRO SRC

EN ISO
20345
2011



TREKKING



7235BK

Action nubuk bőr cipő, vízálló
poliuretán erősítésű orrvédő borítással

- Acél orrvédő
- Áthatolásvédett középtalp kompozit szálból

EU	UK	mm	Ft	♂	♀
35	2,5	228	20.100	1	072350335
36	3,5	235	20.100	1	072350336
37	4,5	242	20.100	1	072350337
38	5	248	20.100	1	072350338
39	6	255	20.100	1	072350339
40	6,5	262	20.100	1	072350340
41	7	268	20.100	1	072350341
42	8	275	20.100	1	072350342
43	9	282	20.100	1	072350343
44	10	288	20.100	1	072350344
45	10,5	295	20.100	1	072350345
46	11	302	20.100	1	072350346
47	12	308	20.100	1	072350347
48	13	315	20.100	1	072350348

CE



S3 SRC

EN ISO
20345
2011



7236BK

Action nubuk bőr bokacipő, vízálló, gyorskioldással és poliuretán erősítésű orrvédő borítással

- Acél orrvédő
- Áthatolásvédett középtalp kompozit szálból

EU	UK	mm	Ft	♂	♀
35	2,5	228	21.450	1	072360335
36	3,5	235	21.450	1	072360336
37	4,5	242	21.450	1	072360337
38	5	248	21.450	1	072360338
39	6	255	21.450	1	072360339
40	6,5	262	21.450	1	072360340
41	7	268	21.450	1	072360341
42	8	275	21.450	1	072360342
43	9	282	21.450	1	072360343
44	10	288	21.450	1	072360344
45	10,5	295	21.450	1	072360345
46	11	302	21.450	1	072360346
47	12	308	21.450	1	072360347
48	13	315	21.450	1	072360348

CE



S3 RS SRC

EN ISO
20345
2011



7238WR

hasítottbőr bokacipő nylon betétekkel, nagyellenállású gumitalp és gyorskioldás Vízálló WR cipő: egy 3 cm vízzel elárasztott táliban tesztelve 100 hossz után a cipő belső részének nedvessége nem lehet több, mint 3 cm² (folt)

- Orrvédő kompozit anyagból
- Áthatolásvédett középtalp kompozit szálból

EU	UK	mm	Ft	♂	♀
35	2,5	228	29.900	1	072380235
36	3,5	235	29.900	1	072380236
37	4,5	242	29.900	1	072380237
38	5	248	29.900	1	072380238
39	6	255	29.900	1	072380239
40	6,5	262	29.900	1	072380240
41	7	268	29.900	1	072380241
42	8	275	29.900	1	072380242
43	9	282	29.900	1	072380243
44	10	288	29.900	1	072380244
45	10,5	295	29.900	1	072380245
46	11	302	29.900	1	072380246
47	12	308	29.900	1	072380247
48	13	315	29.900	1	072380248

CE



S3 RS WR HRO SRC

EN ISO
20345
2011



7239B

vízálló nubuk bokacsizma, mesh betétekkel és poliuretán erősítésű orrvédővel

- Acél orrvédő
- Kompozitszálas, áthatolásvédett köztalp

EU	UK	mm	Ft	♂	♀
39	6	258	29.900	1	072390339
40	6,5	265	29.900	1	072390340
41	7	271	29.900	1	072390341
42	8	278	29.900	1	072390342
43	9	285	29.900	1	072390343
44	10	291	29.900	1	072390344
45	10,5	298	29.900	1	072390345
46	11	305	29.900	1	072390346
47	12	311	29.900	1	072390347
48	13	318	29.900	1	072390348

CE



S3 SRC

EN ISO
20345
2011



7248GK

hasítottbőr cipő nylon betétekkel és poliuretán erősítésű orrvédő borítással

- Acél orrvédő
- Áthatolásvédett középtalp kompozit szálból

EU	UK	mm	Ft	♂	♀
35	2,5	231	17.650	1	072480235
36	3,5	238	17.650	1	072480236
37	4,5	245	17.650	1	072480237
38	5	251	17.650	1	072480238
39	6	258	17.650	1	072480239
40	6,5	265	17.650	1	072480240
41	7	271	17.650	1	072480241
42	8	278	17.650	1	072480242
43	9	285	17.650	1	072480243
44	10	291	17.650	1	072480244
45	10,5	298	17.650	1	072480245
46	11	305	17.650	1	072480246
47	12	311	17.650	1	072480247
48	13	318	17.650	1	072480248

CE



S1P SRC

EN ISO
20345
2011



7249GK

hasítottbőr bokacipő nylon betétekkel gyorskioldással és poliuretán erősítésű orrvédő borítással

- Acél orrvédő
- Áthatolásvédett középtalp kompozit szálból

EU	UK	mm	Ft	Á	☒
35	2,5	231	18.600	1	072490235
36	3,5	238	18.600	1	072490236
37	4,5	245	18.600	1	072490237
38	5	251	18.600	1	072490238
39	6	258	18.600	1	072490239
40	6,5	265	18.600	1	072490240
41	7	271	18.600	1	072490241
42	8	278	18.600	1	072490242
43	9	285	18.600	1	072490243
44	10	291	18.600	1	072490244
45	10,5	298	18.600	1	072490245
46	11	305	18.600	1	072490246
47	12	311	18.600	1	072490247
48	13	318	18.600	1	072490248



CE

S1P RS SRC

EN ISO
20345
2011



ACTIVE



7314AF

perforált hasítottbőr cipő nylon mesh és karbon betétekkel

- Orrvédő kompozit anyagból
- Áthatolásvédett középtalp kompozit szálból

EU	UK	mm	Ft	Á	☒
35	2,5	228	30.550	1	073140235
36	3,5	235	30.550	1	073140236
37	4,5	242	30.550	1	073140237
38	5	248	30.550	1	073140238
39	6	255	30.550	1	073140239
40	6,5	262	30.550	1	073140240
41	7	268	30.550	1	073140241
42	8	275	30.550	1	073140242
43	9	282	30.550	1	073140243
44	10	288	30.550	1	073140244
45	10,5	295	30.550	1	073140245
46	11	302	30.550	1	073140246
47	12	308	30.550	1	073140247
48	13	315	30.550	1	073140248



CE

S1P SRC

EN ISO
20345
2011



7315AN

perforált hasítottbőr és mikroszálás cipő mérsékelten vízálló, karbon betétekkel

- Orrvédő kompozit anyagból
- Áthatolásvédett középtalp kompozit szálból

EU	UK	mm	Ft	Á	☒
35	2,5	228	35.400	1	073150535
36	3,5	235	35.400	1	073150536
37	4,5	242	35.400	1	073150537
38	5	248	35.400	1	073150538
39	6	255	35.400	1	073150539
40	6,5	262	35.400	1	073150540
41	7	268	35.400	1	073150541
42	8	275	35.400	1	073150542
43	9	282	35.400	1	073150543
44	10	288	35.400	1	073150544
45	10,5	295	35.400	1	073150545
46	11	302	35.400	1	073150546
47	12	308	35.400	1	073150547
48	13	315	35.400	1	073150548



CE

S3 SRC

EN ISO
20345
2011

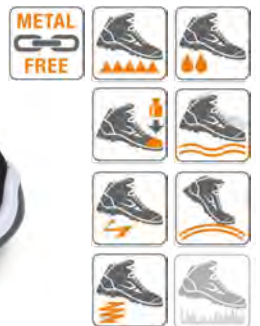

7316NB

jól szellőző hálós hasítottbőr cipő,
a sarok stabilitását segítő alátámasztással

- Kompozit orrvédő
- Kompozitszálás, áthatolásbiztos betét

EU	UK	mm	Ft	W	Color
35	2.5	228	29.600	1	073160735
36	3.5	235	29.600	1	073160736
37	4.5	242	29.600	1	073160737
38	5	248	29.600	1	073160738
39	6	255	29.600	1	073160739
40	6.5	262	29.600	1	073160740
41	7	268	29.600	1	073160741
42	8	275	29.600	1	073160742
43	9	282	29.600	1	073160743
44	10	288	29.600	1	073160744
45	10.5	295	29.600	1	073160745
46	11	302	29.600	1	073160746
47	12	308	29.600	1	073160747
48	13	315	29.600	1	073160748



CE

S1P SRC ESD



EN ISO 20345 2011



7316NC

jól szellőző hálós hasítottbőr cipő,
a sarok stabilitását segítő alátámasztással

- Kompozit orrvédő
- Kompozitszálás, áthatolásbiztos betét

EU	UK	mm	Ft	W	Color
35	2.5	228	29.600	1	073160635
36	3.5	235	29.600	1	073160636
37	4.5	242	29.600	1	073160637
38	5	248	29.600	1	073160638
39	6	255	29.600	1	073160639
40	6.5	262	29.600	1	073160640
41	7	268	29.600	1	073160641
42	8	275	29.600	1	073160642
43	9	282	29.600	1	073160643
44	10	288	29.600	1	073160644
45	10.5	295	29.600	1	073160645
46	11	302	29.600	1	073160646
47	12	308	29.600	1	073160647
48	13	315	29.600	1	073160648



CE

S1P SRC ESD



EN ISO 20345 2011



7317NA

perforált hasítottbőr cipő,
a sarokrésznél mikroszálás erősítéssel

- Kompozit orrvédő
- Áthatolásvédett középtalp kompozit szálból

EU	UK	mm	Ft	W	Color
35	2.5	228	26.200	1	073170135
36	3.5	235	26.200	1	073170136
37	4.5	242	26.200	1	073170137
38	5	248	26.200	1	073170138
39	6	255	26.200	1	073170139
40	6.5	262	26.200	1	073170140
41	7	268	26.200	1	073170141
42	8	275	26.200	1	073170142
43	9	282	26.200	1	073170143
44	10	288	26.200	1	073170144
45	10.5	295	26.200	1	073170145
46	11	302	26.200	1	073170146
47	12	308	26.200	1	073170147
48	13	315	26.200	1	073170148



CE

S1P SRC



EN ISO 20345 2011



7318AN

hasítottbőr és mikroszálás bokacipő
mérsékelten vízálló, karbon betétekkel

- Orrvédő kompozit anyagból
- Áthatolásvédett középtalp kompozit szálból

EU	UK	mm	Ft	W	Color
35	2.5	228	36.000	1	073180535
36	3.5	235	36.000	1	073180536
37	4.5	242	36.000	1	073180537
38	5	248	36.000	1	073180538
39	6	255	36.000	1	073180539
40	6.5	262	36.000	1	073180540
41	7	268	36.000	1	073180541
42	8	275	36.000	1	073180542
43	9	282	36.000	1	073180543
44	10	288	36.000	1	073180544
45	10.5	295	36.000	1	073180545
46	11	302	36.000	1	073180546
47	12	308	36.000	1	073180547
48	13	315	36.000	1	073180548



CE

S3 SRC



EN ISO 20345 2011



7320NA

vízálló nubuk cipő,
kopásgátló erősítéssel az orr részen

- Kompozit orrvédő
- Áthatolásvédett középtalp kompozit szálból

EU	UK	mm	Ft		
35	2,5	228	27.850	1	073200435
36	3,5	235	27.850	1	073200436
37	4,5	242	27.850	1	073200437
38	5	248	27.850	1	073200438
39	6	255	27.850	1	073200439
40	6,5	262	27.850	1	073200440
41	7	268	27.850	1	073200441
42	8	275	27.850	1	073200442
43	9	282	27.850	1	073200443
44	10	288	27.850	1	073200444
45	10,5	295	27.850	1	073200445
46	11	302	27.850	1	073200446
47	12	308	27.850	1	073200447
48	13	315	27.850	1	073200448



CE

S3 SRC



EN ISO
20345
2011



7321NA

vízálló nubuk cipő,
gyorskioldással és kopásgátló erősítéssel az orr részen

- Kompozit orrvédő
- Áthatolásvédett középtalp kompozit szálból

EU	UK	mm	Ft		
35	2,5	228	28.800	1	073210435
36	3,5	235	28.800	1	073210436
37	4,5	242	28.800	1	073210437
38	5	248	28.800	1	073210438
39	6	255	28.800	1	073210439
40	6,5	262	28.800	1	073210440
41	7	268	28.800	1	073210441
42	8	275	28.800	1	073210442
43	9	282	28.800	1	073210443
44	10	288	28.800	1	073210444
45	10,5	295	28.800	1	073210445
46	11	302	28.800	1	073210446
47	12	308	28.800	1	073210447
48	13	315	28.800	1	073210448



CE

S3 RS SRC



EN ISO
20345
2011



7322SA

magas kopásállóságú szövetcipő,
sarok stabilitását segítő alátámasztás

- Kompozit orr rész
- Kompozitszál, áthatolásvédett köztalp

EU	UK	mm	Ft		
35	2,5	228	29.150	1	073220435
36	3,5	235	29.150	1	073220436
37	4,5	242	29.150	1	073220437
38	5	248	29.150	1	073220438
39	6	255	29.150	1	073220439
40	6,5	262	29.150	1	073220440
41	7	268	29.150	1	073220441
42	8	275	29.150	1	073220442
43	9	282	29.150	1	073220443
44	10	288	29.150	1	073220444
45	10,5	295	29.150	1	073220445
46	11	302	29.150	1	073220446
47	12	308	29.150	1	073220447
48	13	315	29.150	1	073220448



CE

S3 SRC



EN ISO
20345
2011



7323SA

magas kopásállóságú szövet bokacipő,
gyorskioldással és sarok stabilitását segítő alátámasztással

- Kompozit orr rész
- Kompozitszál, áthatolásvédett köztalp

EU	UK	mm	Ft		
35	2,5	228	28.500	1	073230435
36	3,5	235	28.500	1	073230436
37	4,5	242	28.500	1	073230437
38	5	248	28.500	1	073230438
39	6	255	28.500	1	073230439
40	6,5	262	28.500	1	073230440
41	7	268	28.500	1	073230441
42	8	275	28.500	1	073230442
43	9	282	28.500	1	073230443
44	10	288	28.500	1	073230444
45	10,5	295	28.500	1	073230445
46	11	302	28.500	1	073230446
47	12	308	28.500	1	073230447
48	13	315	28.500	1	073230448



CE

S3 RS SRC



EN ISO
20345
2011



O-GRAVITY



7352A

jól szellőző mesh szövet cipő TPU betétekkel
A sarok stabilitását segítő alátámasztás, elastikus bebújós szár
és EVA talprész nagy ellenállású nitril gumitalppal

- Orrvédő kompozit anyagból
- Áthatolásvédett középtalp kompozit szálból
- RENDKÍVÜL KÖNNYŰ: a 42-es méret körülbelüli súlya 450 g

EN ISO
20345
2011

EU	UK	mm	Ft	♂	♀
38	5	254	31.900	1	073520038
39	6	261	31.900	1	073520039
40	6,5	268	31.900	1	073520040
41	7	274	31.900	1	073520041
42	8	281	31.900	1	073520042
43	9	288	31.900	1	073520043
44	10	294	31.900	1	073520044
45	10,5	301	31.900	1	073520045
46	11	308	31.900	1	073520046
47	12	314	31.900	1	073520047
48	13	321	31.900	1	073520048



METAL
FREE



CE

S1P HRO SRC

7352B

jól szellőző mesh szövet cipő TPU betétekkel
A sarok stabilitását segítő alátámasztás, elastikus bebújós szár
és EVA talprész nagy ellenállású nitril gumitalppal

- Orrvédő kompozit anyagból
- Áthatolásvédett középtalp kompozit szálból
- KIEMELKEDŐEN KÖNNYŰ: 42-es méret súlya kb.: 450 g

EN ISO
20345
2011

EU	UK	mm	Ft	♂	♀
38	5	254	35.450	1	073520138
39	6	261	35.450	1	073520139
40	6,5	268	35.450	1	073520140
41	7	274	35.450	1	073520141
42	8	281	35.450	1	073520142
43	9	288	35.450	1	073520143
44	10	294	35.450	1	073520144
45	10,5	301	35.450	1	073520145
46	11	308	35.450	1	073520146
47	12	314	35.450	1	073520147
48	13	321	35.450	1	073520148



METAL
FREE



CE

S1P HRO SRC

7352G

jól szellőző mesh szövet cipő TPU betétekkel
Sarok stabilitását segítő alátámasztás, hagyományos fűzés, szélesített kivitel.
EVA talprész nagy ellenállású nitril gumitalppal

- Kompozit orr rész
- Kompozitszál, áthatolásvédett köztalp
- RENDKÍVÜL KÖNNYŰ - a 42-es méret körülbelüli súlya: 450 gramm

EN ISO
20345
2011

EU	UK	mm	Ft	♂	♀
38	5	254	38.450	1	073520338
39	6	261	38.450	1	073520339
40	6,5	268	38.450	1	073520340
41	7	274	38.450	1	073520341
42	8	281	38.450	1	073520342
43	9	288	38.450	1	073520343
44	10	294	38.450	1	073520344
45	10,5	301	38.450	1	073520345
46	11	308	38.450	1	073520346
47	12	314	38.450	1	073520347
48	13	321	38.450	1	073520348



METAL
FREE



CE

S1P HRO SRC ESD

7352LG

jól szellőző női mesh szövet cipő TPU betétekkel
 Jól láthatóságot biztosító fényvisszaverő mesh felsőrész
 Sarok stabilitását segítő alátámasztás, elasztikus bebújós szár
 és EVA talprész nagy ellenállású nitril gumitalppal

- Üvegszál orr rész
- Kompozitszálás, áthatolásvédett köztalp
- RENDKÍVÜL KÖNNYŰ - a 38-es méret körülbelüli súlya: 390 gramm

**EN ISO
20345
2011**

EU	UK	mm	Ft	cs	cs
34	2	228	39.000	1	073520234
35	2,5	234	39.000	1	073520235
36	3,5	241	39.000	1	073520236
37	4,5	248	39.000	1	073520237
38	5	254	39.000	1	073520238
39	6	261	39.000	1	073520239
40	6,5	268	39.000	1	073520240
41	7	274	39.000	1	073520241
42	8	281	39.000	1	073520242

CE



lady



METAL
FREE



S1P HRO SRC

7353Y

jól szellőző mesh szövet cipő TPU betétekkel
 Jó láthatóságot biztosító fényvisszaverő mesh felsőrész
 A sarok stabilitását segítő alátámasztás, elasztikus bebújós szár és EVA talprész nagy ellenállású nitril gumitalppal

- Szénszálas orrvédő
- Áthatolásvédett középtalp kompozit szálból
- KIEMELKEDŐEN KÖNNYŰ: a 42-es méret körülbelüli súlya 420 g

**EN ISO
20345
2011**

EU	UK	mm	Ft	cs	cs
38	5	254	46.250	1	073530038
39	6	261	46.250	1	073530039
40	6,5	268	46.250	1	073530040
41	7	274	46.250	1	073530041
42	8	281	46.250	1	073530042
43	9	288	46.250	1	073530043
44	10	294	46.250	1	073530044
45	10,5	301	46.250	1	073530045
46	11	308	46.250	1	073530046
47	12	314	46.250	1	073530047
48	13	321	46.250	1	073530048

CE



S1P HRO SRC

7354N

vízálló mesh szövet cipő TPU betétekkel
 A sarok stabilitását segítő alátámasztás, elasztikus bebújós szár
 és EVA talprész nagy ellenállású nitril gumitalppal

- Orrvédő kompozit anyagból
- Áthatolásvédett középtalp kompozit szálból
- RENDKÍVÜL KÖNNYŰ: a 42-es méret körülbelüli súlya 460 g

**EN ISO
20345
2011**

EU	UK	mm	Ft	cs	cs
38	5	254	36.100	1	073540038
39	6	261	36.100	1	073540039
40	6,5	268	36.100	1	073540040
41	7	274	36.100	1	073540041
42	8	281	36.100	1	073540042
43	9	288	36.100	1	073540043
44	10	294	36.100	1	073540044
45	10,5	301	36.100	1	073540045
46	11	308	36.100	1	073540046
47	12	314	36.100	1	073540047
48	13	321	36.100	1	073540048

CE



METAL
FREE



S3 HRO SRC

7355V

vízálló mesh szövet bokacipő TPU betétekkel
 A sarok stabilitását segítő alátámasztás, elasztikus bebújós szár
 és EVA talprész nagy ellenállású nitril gumitalppal

- Orrvédő kompozit anyagból
- Áthatolásvédett középtalp kompozit szálból
- RENDKÍVÜL KÖNNYŰ: a 42-es méret körülbelüli súlya 465 g

**EN ISO
20345
2011**

EU	UK	mm	Ft	cs	cs
38	5	254	38.500	1	073550038
39	6	261	38.500	1	073550039
40	6,5	268	38.500	1	073550040
41	7	274	38.500	1	073550041
42	8	281	38.500	1	073550042
43	9	288	38.500	1	073550043
44	10	294	38.500	1	073550044
45	10,5	301	38.500	1	073550045
46	11	308	38.500	1	073550046
47	12	314	38.500	1	073550047
48	13	321	38.500	1	073550048

CE



METAL
FREE



S3 HRO SRC

7356G

vízálló mikroszálal cipő TPU betéttel

Sarok stabilitását segítő alátámasztás, elasztikus bebújós szár és EVA talprész nagy ellenállású nitril gumitalppal

- Kompozit orr rész
- Kompozitszálal, áthatolásvédett köztalp
- RENDKÍVÜL KÖNNYŰ - a 42-es méret körülbelüli súlya: 460 gramm

EN ISO 20345 2011

EU	UK	mm	Ft	kg	csomag
38	5	254	39.950	1	073560038
39	6	261	39.950	1	073560039
40	6,5	268	39.950	1	073560040
41	7	274	39.950	1	073560041
42	8	281	39.950	1	073560042
43	9	288	39.950	1	073560043
44	10	294	39.950	1	073560044
45	10,5	301	39.950	1	073560045
46	11	308	39.950	1	073560046
47	12	314	39.950	1	073560047
48	13	321	39.950	1	073560048



CE

S3 HRO SRC

7356V

vízálló mikroszálal cipő TPU betéttel

Sarok stabilitását segítő alátámasztás, elasztikus bebújós szár és EVA talprész nagy ellenállású nitril gumitalppal

- Kompozit orr rész
- Kompozitszálal, áthatolásvédett köztalp
- RENDKÍVÜL KÖNNYŰ - a 42-es méret körülbelüli súlya: 460 gramm

EN ISO 20345 2011

EU	UK	mm	Ft	kg	csomag
38	5	254	37.150	1	073560138
39	6	261	37.150	1	073560139
40	6,5	268	37.150	1	073560140
41	7	274	37.150	1	073560141
42	8	281	37.150	1	073560142
43	9	288	37.150	1	073560143
44	10	294	37.150	1	073560144
45	10,5	301	37.150	1	073560145
46	11	308	37.150	1	073560146
47	12	314	37.150	1	073560147
48	13	321	37.150	1	073560148



CE

S3 HRO SRC

7356LN

vízálló mikroszálal női cipő TPU betéttel

Sarok stabilitását segítő alátámasztás, elasztikus bebújós szár és EVA talprész nagy ellenállású nitril gumitalppal

- Üvegszál orr rész
- Kompozitszálal, áthatolásvédett köztalp
- RENDKÍVÜL KÖNNYŰ - a 38-es méret körülbelüli súlya: 400 gramm

EN ISO 20345 2011

EU	UK	mm	Ft	kg	csomag
34	2	228	39.950	1	073560234
35	2,5	234	39.950	1	073560235
36	3,5	241	39.950	1	073560236
37	4,5	248	39.950	1	073560237
38	5	254	39.950	1	073560238
39	6	261	39.950	1	073560239
40	6,5	268	39.950	1	073560240
41	7	274	39.950	1	073560241
42	8	281	39.950	1	073560242



CE

S3 HRO SRC

7357G

vízálló mikroszálal bokacipő TPU betéttel

Sarok stabilitását segítő alátámasztás, elasztikus bebújós szár és EVA talprész nagy ellenállású nitril gumitalppal

- Kompozit orr rész
- Kompozitszálal, áthatolásvédett köztalp
- RENDKÍVÜL KÖNNYŰ - a 42-es méret körülbelüli súlya: 480 gramm

EN ISO 20345 2011

EU	UK	mm	Ft	kg	csomag
38	5	254	44.500	1	073570038
39	6	261	44.500	1	073570039
40	6,5	268	44.500	1	073570040
41	7	274	44.500	1	073570041
42	8	281	44.500	1	073570042
43	9	288	44.500	1	073570043
44	10	294	44.500	1	073570044
45	10,5	301	44.500	1	073570045
46	11	308	44.500	1	073570046
47	12	314	44.500	1	073570047
48	13	321	44.500	1	073570048



CE

S3 HRO SRC

7357V

Vízálló mikroszálás bokacipő TPU betéttel

Sarok stabilitását segítő alátámasztás, elasztikus bebújós szár és EVA talprész nagy ellenállású nitril gumitalppal

- Kompozit orr rész
- Kompozitszálás, áthatolásvédett köztalp
- RENDKÍVÜL KÖNNYŰ - a 42-es méret körülbelüli súlya: 480 gramm

EN ISO 20345 2011

EU	UK	mm	Ft	db	azonosító
38	5	254	44.500	1	073570138
39	6	261	44.500	1	073570139
40	6,5	268	44.500	1	073570140
41	7	274	44.500	1	073570141
42	8	281	44.500	1	073570142
43	9	288	44.500	1	073570143
44	10	294	44.500	1	073570144
45	10,5	301	44.500	1	073570145
46	11	308	44.500	1	073570146
47	12	314	44.500	1	073570147
48	13	321	44.500	1	073570148

CE



S3 HRO SRC



7362B

jól szellőző mesh szövet munkacipő TPU betétekkel

Sarok stabilitását segítő alátámasztás, elasztikus bebújós szár és EVA talprész nagy ellenállású nitril gumitalppal

- Orrvédő nélkül
- Átszűrődás ellen védő köztalp nélkül
- RENDKÍVÜL KÖNNYŰ - a 42-es méret körülbelüli súlya: 330 gramm

EN ISO 20347 2012

EU	UK	mm	Ft	db	azonosító
39	6	261	39.750	1	073620039
40	6,5	268	39.750	1	073620040
41	7	274	39.750	1	073620041
42	8	281	39.750	1	073620042
43	9	288	39.750	1	073620043
44	10	294	39.750	1	073620044
45	10,5	301	39.750	1	073620045
46	11	308	39.750	1	073620046
47	12	314	39.750	1	073620047
48	13	321	39.750	1	073620048

CE



01 FO HRO SRC



7363N

vízálló mesh szövet munkacipő TPU betétekkel

Sarok stabilitását segítő alátámasztás, elasztikus bebújós szár és EVA talprész nagy ellenállású nitril gumitalppal

- Orrvédő nélkül
- Átszűrődás ellen védő köztalp nélkül
- RENDKÍVÜL KÖNNYŰ - a 42-es méret körülbelüli súlya: 330 gramm

EN ISO 20347 2012

EU	UK	mm	Ft	db	azonosító
39	6	261	41.250	1	073630039
40	6,5	268	41.250	1	073630040
41	7	274	41.250	1	073630041
42	8	281	41.250	1	073630042
43	9	288	41.250	1	073630043
44	10	294	41.250	1	073630044
45	10,5	301	41.250	1	073630045
46	11	308	41.250	1	073630046
47	12	314	41.250	1	073630047
48	13	321	41.250	1	073630048

CE



02 FO HRO SRC



Beta

7372B

ellenálló, kiválóan szellőző szőtt vászoncipő.

Sarok stabilitását segítő alátámasztás, hagyományos fűzés, szélesített kivitel.

EVA talprész nagy ellenállású nitril gumitalppal.

- Kompozit orrvédő
- Kompozitszálas, áthatolásbiztos betét
- RENDKÍVÜL KÖNNYŰ - a 42-es méret körülbelüli súlya: 450g

**EN ISO
20345
2011**

EU	UK	mm	Ft	kg	cm
38	5	254	40.400	1	073720038
39	6	261	40.400	1	073720039
40	6,5	268	40.400	1	073720040
41	7	274	40.400	1	073720041
42	8	281	40.400	1	073720042
43	9	288	40.400	1	073720043
44	10	294	40.400	1	073720044
45	10,5	301	40.400	1	073720045
46	11	308	40.400	1	073720046
47	12	314	40.400	1	073720047
48	13	321	40.400	1	073720048

CE



S1P HRO SRC



7376A

perforált, jól szellőző mikroszálas és mesh szandál

Sarok stabilitását segítő alátámasztás, hagyományos fűzés, elastikus fűző, szélesített kivitel.

EVA talprész nagy ellenállású nitril gumitalppal.

- Kompozit orrvédő
- Kompozitszálas, áthatolásbiztos betét
- RENDKÍVÜL KÖNNYŰ - a 42-es méret körülbelüli súlya: 490 g

**EN ISO
20345
2011**

EU	UK	mm	Ft	kg	cm
38	5	254	42.150	1	073760038
39	6	261	42.150	1	073760039
40	6,5	268	42.150	1	073760040
41	7	274	42.150	1	073760041
42	8	281	42.150	1	073760042
43	9	288	42.150	1	073760043
44	10	294	42.150	1	073760044
45	10,5	301	42.150	1	073760045
46	11	308	42.150	1	073760046
47	12	314	42.150	1	073760047
48	13	321	42.150	1	073760048

CE



S1P HRO SRC



7381N

EU	UK	mm	Ft	kg	cm
38	5	254	50.800	1	073810038
39	6	261	50.800	1	073810039
40	6,5	268	50.800	1	073810040
41	7	274	50.800	1	073810041
42	8	281	50.800	1	073810042
43	9	288	50.800	1	073810043
44	10	294	50.800	1	073810044
45	10,5	301	50.800	1	073810045
46	11	308	50.800	1	073810046
47	12	314	50.800	1	073810047
48	13	321	50.800	1	073810048

CE



S3 SRC HRO WR



7382N

EU	UK	mm	Ft	kg	cm
38	5	254	56.900	1	073820038
39	6	261	56.900	1	073820039
40	6,5	268	56.900	1	073820040
41	7	274	56.900	1	073820041
42	8	281	56.900	1	073820042
43	9	288	56.900	1	073820043
44	10	294	56.900	1	073820044
45	10,5	301	56.900	1	073820045
46	11	308	56.900	1	073820046
47	12	314	56.900	1	073820047
48	13	321	56.900	1	073820048

CE



S3 SRC HRO WR



SNEAKERS PRO



7340B

jól szellőző mesh szövet cipő
nagyfrekvenciás PU betétekkel és védő erősítéssel
a hasítottbőr ormál.
Rendkívül könnyű - a 42 méret körülbelüli súlya 470 g

- Alumínium orrvédő
- Áthatolásvédett kompozit szálból készült középtalp
- A FixLock zárrendszer egyszerűsíti a cipő viselését és levételét (hagyományos cipőfűzővel is rendelkezik)

**EN ISO
20345
2011**



EU	UK	mm	Ft		
36	3,5	238	48.450	1	073400236
37	4,5	245	48.450	1	073400237
38	5	251	48.450	1	073400238
39	6	258	48.450	1	073400239
40	6,5	265	48.450	1	073400240
41	7	271	48.450	1	073400241
42	8	278	48.450	1	073400242
43	9	285	48.450	1	073400243
44	10	291	48.450	1	073400244
45	10,5	298	48.450	1	073400245
46	11	305	48.450	1	073400246
47	12	311	48.450	1	073400247



CE

S1P SRC

7341N

mikro hasítottbőr cipő, mérsékelten vízálló,
nagyfrekvenciás PU betétekkel és védő erősítéssel
a hasítottbőr ormál.
Rendkívül könnyű - a 42 méret körülbelüli súlya 470 g

- Alumínium orrvédő
- Áthatolásvédett kompozit szálból készült középtalp
- A FixLock zárrendszer egyszerűsíti a cipő viselését és levételét

**EN ISO
20345
2011**



EU	UK	mm	Ft		
36	3,5	238	50.950	1	073410236
37	4,5	245	50.950	1	073410237
38	5	251	50.950	1	073410238
39	6	258	50.950	1	073410239
40	6,5	265	50.950	1	073410240
41	7	271	50.950	1	073410241
42	8	278	50.950	1	073410242
43	9	285	50.950	1	073410243
44	10	291	50.950	1	073410244
45	10,5	298	50.950	1	073410245
46	11	305	50.950	1	073410246
47	12	311	50.950	1	073410247



CE

S3 SRC

7349RP

Nubuck-Look félcipő, mérsékelten vízálló,
gumitalp puha PU-profillal

- Orrvédő kompozit anyagból
- Áthatolásbiztos kompozit szálból készült középtalp

**EN ISO
20345
2011**



EU	UK	mm	Ft		
38	5	254	51.500	1	073490138
39	6	260	51.500	1	073490139
40	6,5	267	51.500	1	073490140
41	7	274	51.500	1	073490141
42	8	280	51.500	1	073490142
43	9	287	51.500	1	073490143
44	10	294	51.500	1	073490144
45	10,5	300	51.500	1	073490145
46	11	307	51.500	1	073490146
47	12	314	51.500	1	073490147



CE

S3 HRO SRC

7350RP

Nubuck-Look bokacipő, mérsékelten vízálló, gumitalp puha PU-profillal

- Orrvédő kompozit anyagból
- Áthatolásvédett kompozit szálból készült középtalp

EN ISO 20345 2011

METAL FREE



EU	UK	mm	Ft	W	Code
38	5	254	52.600	1	073500138
39	6	260	52.600	1	073500139
40	6,5	267	52.600	1	073500140
41	7	274	52.600	1	073500141
42	8	280	52.600	1	073500142
43	9	287	52.600	1	073500143
44	10	294	52.600	1	073500144
45	10,5	300	52.600	1	073500145
46	11	307	52.600	1	073500146
47	12	314	52.600	1	073500147



CE

S3 HRO SRC

HEAVY DUTY



7293HM

mérsékelten vízálló, faggyúzott full-grain bőrcipő nagyteljesítményű VIBRAM® járőfelülettel, kopásálló betéttel a saroknál, és poliuretán orrvédővel

- Üvegszálas orrvédő
- Áthatolásvédett középtalp kompozit szálból

EN ISO 20345 2011

11



EU	UK	mm	Ft	W	Code
39	6	263	53.400	1	072930639
40	6,5	270	53.400	1	072930640
41	7	276	53.400	1	072930641
42	8	283	53.400	1	072930642
43	9	289	53.400	1	072930643
44	10	296	53.400	1	072930644
45	10,5	302	53.400	1	072930645
46	11	309	53.400	1	072930646
47	12	315	53.400	1	072930647
48	13	322	53.400	1	072930648



CE

S3 HRO HI SRC

7293HN

Vízálló nubuck cipő oldalt erősített bokarész Nagy ellenállású gumitalp és poliuretán külső orrvédő borítással Széles fejrész

- Acél orrvédő
- Áthatolásvédett középtalp kompozit szálból

EN ISO 20345 2011

11



E	U	mm	Ft	W	Code
39	6	256	41.300	1	072930839
40	6,5	263	41.300	1	072930840
41	7	269	41.300	1	072930841
42	8	276	41.300	1	072930842
43	9	282	41.300	1	072930843
44	10	289	41.300	1	072930844
45	10,5	295	41.300	1	072930845
46	11	302	41.300	1	072930846
47	12	308	41.300	1	072930847



CE

S3 HRO HI SRC

7294HM

mérsékeltén vízálló, faggyúzott full-grain bőr félcipő
nagyteljesítményű VIBRAM® járőfelülettel, kopásálló betéttel
a saroknál, és poliuretán orrvédővel

- Üvegszálás orrvédő
- Áthatolásvédett középtalp kompozit szálból

EU	UK	mm	Ft		
39	6	263	56.850	1	072940639
40	6,5	270	56.850	1	072940640
41	7	276	56.850	1	072940641
42	8	283	56.850	1	072940642
43	9	289	56.850	1	072940643
44	10	296	56.850	1	072940644
45	10,5	302	56.850	1	072940645
46	11	309	56.850	1	072940646
47	12	315	56.850	1	072940647
48	13	322	56.850	1	072940648

CE



S3 HRO HI SRC



EN ISO
20345
2011



7294HMC

mérsékeltén vízálló, faggyúzott full-grain bőr bokacipő
nagyteljesítményű VIBRAM® járőfelülettel, kopásálló betéttel
a saroknál, és poliuretán orrvédővel
Tepor membránnal, vízhatlan, szélálló, és rendkívül légáteresztő

- Üvegszálás orrvédő
- Áthatolásvédett középtalp kompozit szálból

EU	UK	mm	Ft		
39	6	263	63.600	1	072940739
40	6,5	270	63.600	1	072940740
41	7	276	63.600	1	072940741
42	8	283	63.600	1	072940742
43	9	289	63.600	1	072940743
44	10	296	63.600	1	072940744
45	10,5	302	63.600	1	072940745
46	11	309	63.600	1	072940746
47	12	315	63.600	1	072940747
48	13	322	63.600	1	072940748

CE



S3 HRO HI CI WR SRC



EN ISO
20345
2011



7294HN

Vízálló nubuk bokacipő, oldalt erősített bokarész gyorskioldással
Nagy ellenállású gumitalp és poliuretán külső orrvédő borítással
Széles fejrész

- Acél orrvédő
- Áthatolásvédett középtalp kompozit szálból

EU	UK	mm	Ft		
39	6	263	44.600	1	072940839
40	6,5	269	44.600	1	072940840
41	7	276	44.600	1	072940841
42	8	282	44.600	1	072940842
43	9	289	44.600	1	072940843
44	10	295	44.600	1	072940844
45	10,5	302	44.600	1	072940845
46	11	308	44.600	1	072940846
47	12	315	44.600	1	072940847

CE



S3 HRO HI RS SRC



EN ISO
20345
2011



 **Beta**

ACCESSORIES

7398 O/G

anatómiai formázott EVA hab talpbetét
csillapító sarokrészsel
(a 0-Gravity cipőkhöz ajánlott kiegészítő)



EU	UK	Ft		
38	5	2.790	1	073981238
39	6	2.790	1	073981239
40	6,5	2.790	1	073981240
41	7	2.790	1	073981241
42	8	2.790	1	073981242
43	9	2.790	1	073981243
44	10	2.790	1	073981244
45	10,5	2.790	1	073981245
46	11	2.790	1	073981246
47	12	2.790	1	073981247
48	13	2.790	1	073981248

7398ESD

anatómiai formázott, szellőző talpbetét
szagálló antibakteriális felső réteggel.
ESD tanúsítású lábbelikhez



EU	UK	Ft		
35	2,5	2.480	1	073981435
36	3,5	2.480	1	073981436
37	4,5	2.480	1	073981437
38	5	2.480	1	073981438
39	6	2.480	1	073981439
40	6,5	2.480	1	073981440
41	7	2.480	1	073981441
42	8	2.480	1	073981442
43	9	2.480	1	073981443
44	10	2.480	1	073981444
45	10,5	2.480	1	073981445
46	11	2.480	1	073981446
47	12	2.480	1	073981447
48	13	2.480	1	073981448

7398T

anatómiai formázott, WINTHERM
szigetelésű talpbetét. 70% alumizált
poliészter, 30% polietilén, nem szőtt szintetikus
szálhoz kötve.

Antisztatikus, szellőző, gyors nedvsvívó,
szagálló, antibakteriális, gombaölő.



WINTHERM

EU	UK	Ft		
35	2,5	4.590	1	073981335
36	3,5	4.590	1	073981336
37	4,5	4.590	1	073981337
38	5	4.590	1	073981338
39	6	4.590	1	073981339
40	6,5	4.590	1	073981340
41	7	4.590	1	073981341
42	8	4.590	1	073981342
43	9	4.590	1	073981343
44	10	4.590	1	073981344
45	10,5	4.590	1	073981345
46	11	4.590	1	073981346
47	12	4.590	1	073981347
48	13	4.590	1	073981348

7398U

anatómiai formázott, TPR GEL anyagú,
erősen csillapító hatású talpbetét,
talpboltozat tartó, és sarokrészi párna



EU	UK	Ft		
36 - 40	3,5 - 6,5	4.760	1	073980058
41 - 46	7 - 11	4.760	1	073980063

Beta

7398UP

anatómiai formázott, citrusos illatú TPE
GEL anyagú talpboltozat tartó talpbetét



EU	UK	Ft		
36 - 40	3,5 - 6	4.420	1	073980076
41 - 46	7 - 11	4.420	1	073980081

7398GEL

Talpformát követő gél-betétes talpbetét



EU	UK	Ft		
35	2,5	1.540	1	073980835
36	3,5	1.540	1	073980836
37	4,5	1.540	1	073980837
38	5	1.540	1	073980838
39	6	1.540	1	073980839
40	6,5	1.540	1	073980840
41	7	1.540	1	073980841
42	8	1.540	1	073980842
43	9	1.540	1	073980843
44	10	1.540	1	073980844
45	10,5	1.540	1	073980845
46	11	1.540	1	073980846
47	12	1.540	1	073980847
48	13	1.540	1	073980848

Beta

7398EF

anatómiailag formázott poliuretán hab talpbetét a sarokrészen emelt csillapító betéttel



EU	UK	Ft		
35	2,5	3.350	1	073981135
36	3,5	3.350	1	073981136
37	4,5	3.350	1	073981137
38	5	3.350	1	073981138
39	6	3.350	1	073981139
40	6,5	3.350	1	073981140
41	7	3.350	1	073981141
42	8	3.350	1	073981142
43	9	3.350	1	073981143
44	10	3.350	1	073981144
45	10,5	3.350	1	073981145
46	11	3.350	1	073981146
47	12	3.350	1	073981147
48	13	3.350	1	073981148

7399 A/N...

10 pár cipőfűző



cm	Ft		
100	5.950	1	073990010
120	7.010	1	073990012
140	8.570	1	073990017

A megadott árak 10 párra vonatkoznak.

7421

kompresziós térdzokni nylon és pamut erősítéssel az orrnál és a saroknál Ellenálló, gombaölő és szellőző bambusz szálal talprész



	EU	Ft		
M	39-42	5.240	1	074210002
L	43-46	5.240	1	074210004

7423

kompresziós bokazokni nylon és pamut erősítéssel az orrnál és a saroknál Ellenálló, gombaölő és szellőző bambusz szálal talprész



	EU	Ft		
M	39-42	3.370	1	074230002
L	43-46	3.370	1	074230004

7425

bokazokni szellőző textilbetétekkel és nylon/pamut erősítéssel az orrnál és a saroknál Ellenálló, gombaölő és szellőző bambusz szálal kevert nylon talprész



	EU	Ft		
M	39-42	3.380	1	074250002
L	43-46	3.380	1	074250004

7427

maxi sneaker zokni védő és szellőző betétekkel a sípcsont és a rüsztt területén. Nylon és pamut erősítéssel az orrnál és a saroknál, és ellenálló, gombaölő és szellőző bambusz szálal talprész



	EU	Ft		
M	39-42	2.950	1	074270002
L	43-46	2.950	1	074270004

7429

maxi sneaker zokni szellőző textilbetétekkel és nylon/pamut erősítéssel az orrnál és a saroknál Ellenálló, gombaölő és szellőző bambusz szálal kevert nylon talprész



	EU	Ft		
M	39-42	2.710	1	074290002
L	43-46	2.710	1	074290004

7431P

két pár sneaker zokni szellőző betétekkel és nejlón/pamut erősítéssel az orrnál és a sarokrésznél

Ellenálló, gombásodásgátló és szellőző bambusz szálal nejlón talprésszel. Egy pár fekete/narancs és egy pár fekete/szürke színű zokni.



	EU	Ft		
M	39-42	2.390	1	074310102
L	43-46	2.390	1	074310104



MUNKARUHÁZAT



Az elmúlt évek során a Beta munkaruha családja nagy népszerűsége tett szert és széles körben ismertté vált a legigényesebb szakemberek körében.

A termék sikere a választék állandó fejlesztésében és bővítésében rejlik.

Beta Utensili S.p.a. cég által gyártott munkaruházat a következő szabványnak felel meg:

EN ISO 13688:2013

Az egyéni védőeszköz védelmet biztosít viselőjének a kisebb mértékű behatásokkal szemben, úm. kisebb horzsolások, napsütés, szél, hideg, nem mérgező por és szennyeződés. Ez a védelem az 1992. 12. 04-i, 475 számú törvénytervezet első kategóriájának felel meg.

UTASÍTÁS HASZNÁLATHOZ ÉS TÁROLÁSHOZ

A munkaruhát az előírásoknak megfelelően kell viselni annak érdekében, hogy megvédje viselőjét. A ruhákat szellős, száraz helyen eredeti csomagolásban kell tárolni védve a sugárzó hőtől, napsütéstől, portól és az időjárás viszontagságaitól.

MÉRETVÁLTOZÁS

Minden természetes szál mosás közben változtatja a méretét (összemegy). A méretváltozás mértéke (1% -5%) függ a különböző paramétereiktől, különösen a szál fajtájától és a víz hőmérsékletétől.

A MEGFELELŐ MÉRET MEGHATÁROZÁSA

		FÉRFI RUHÁZAT						NŐI RUHÁZAT							
		I	F	D	E	UK	USA			I	F	D	E	UK	USA
FÉRFI RUHÁZAT	XS	46	38	42	40	30	32	NŐI RUHÁZAT	XS	38	34	32	34	6	2
	S	48	40	44	42	32	34		S	40	36	34	36	8	4
	M	50	42	46	44	34	36		M	42	38	36	38	10	6
	L	52	44	48	46	36	38		L	44	40	38	40	12	8
	XL	54	46	50	48	38	40		XL	46	42	40	42	14	10
	2XL	56	48	52	50	40	42		2XL	48	44	42	44	16	12
3XL	58	50	54	52	42	44	3XL	50	46	44	46	18	14		
4XL	60	52	56	54	44	46									

A RUHA VISELŐJÉNEK MÉRETEI EN ISO 13688:2013

FÉRFI RUHÁZAT

	XS	S	M	L	XL	2XL	3XL	4XL
A	88-92	92-96	96-104	104-108	108-116	116-124	124-132	132-140
B	79-83	83-87	87-91	91-95	95-100	100-107	107-112	112-120
H	158-164	164-170	170-176	176-182	182-188	188-194	194-200	200-206

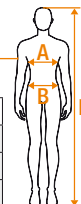

NŐI RUHÁZAT

	XS	S	M	L	XL	2XL	3XL
B	72-77	77-82	82-87	87-93	93-99	99-105	105-111
H	162-165	164-167	168-171	170-173	172-175	174-177	176-179

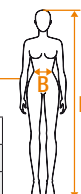

ÚTMUTATÓ MUNKA- ÉS EGYÉB RUHÁZAT KIVÁLASZTÁSÁHOZ – 2023 ÁRLISTA

Kategória	Termékcsalád	Katalógusszám	Oldal	Szín	Ajánlott összeállítások (a nadrággal megegyező színű és anyagú szövet)										
					Bermuda	Oldal	Kertész nadrág	Oldal	Overáll	Oldal	Mellény	Oldal	Dzseki	Oldal	
MUNKANADRÁGOK, KÖNNYÍTETT KIVITEL	Trekking	7610G	614		7611G	618									
		7610N	614												
	Top Line	7660B	614		7661B	618									
		7660G	614		7661G	618									
	Stretch	7830SN	616		7831SN	618									
	Beta Easy	7860G	616		7861G	619	7863G	619	7865G	620	7867G	622	7869G	621	
Pamut	7930G	617		7931G	619	7933G	620	7935G	620			7939G	621		
MUNKANADRÁGOK, EGÉSZ ÉVRE	Trekking	7600G	613												
		7600N	613												
	Top Line	7650	614										7653G	620	
		7650B	614												
		7818BL	615												
		7818CM	615		7815CM	618									
		7818G	615												
	Stretch	7830ST	616		7831ST	618									
	Beta Easy	7840BL	616										7849BL	620	
	Stretch	7880SC	616												
	Beta Easy	7900B	617											7909B	621
		7900G	617		7901G	619	7903G	619	7905G	620	7907G	622	7909G	621	
		7900P	617				7903P	619			7907P	622	7909P	621	
7900V		617										7909V	621		
Többszörös védelmet nyújtó	7940	617										7949	621		
Lady	7818LN	615													

PANTS



7527

farmernadrág,
60% pamut, 27% poliészter és 3% elasztikus
szövet
Normál szabású

CE

Jeans



	I	Ft		
XS	46	17.650	1	075270046
S	48	17.650	1	075270048
M	50	17.650	1	075270050
L	52	17.650	1	075270052
XL	54	17.650	1	075270054
XXL	56	17.650	1	075270056
XXXL	58	17.650	1	075270058

7528

Elasztikus farmernadrág (munkaruha)
98% pamut-denim, 2% elasztán, ~340g/m²

CE

Jeans



	I	Ft		
XS	46	18.750	1	075280046
S	48	18.750	1	075280048
M	50	18.750	1	075280050
L	52	18.750	1	075280052
XL	54	18.750	1	075280054
XXL	56	18.750	1	075280056
XXXL	58	18.750	1	075280058

7530

elasztikus munkanadrág,
98% pamut és 2% elasztikus szövet,
poliészter erősítésekkel
Slim fit

CE

Jeans



	I	Ft		
XS	46	23.000	1	075300046
S	48	23.000	1	075300048
M	50	23.000	1	075300050
L	52	23.000	1	075300052
XL	54	23.000	1	075300054
XXL	56	23.000	1	075300056
XXXL	58	23.000	1	075300058

7600G

„work trekking” nadrág, HEAVY,
90% nejlon, 10% elasztikus szövet, 265 g/m²,
megerősített anyag a térdnél és a háton, elasztikus
lábszár rész függőlegesen záródó cipzárral
Sötétszürke, fluoeszkaló zöld betétekkel
Slim fit

CE

TREKKING
HEAVY



	I	Ft		
XS	46	23.950	1	076000000
S	48	23.950	1	076000001
M	50	23.950	1	076000002
L	52	23.950	1	076000003
XL	54	23.950	1	076000004
XXL	56	23.950	1	076000005
XXXL	58	23.950	1	076000006

7600N

„work trekking” nadrág, HEAVY,
90% nejlon, 10% elasztikus szövet, 265 g/m²,
megerősített anyag a térdnél és a háton, elasztikus
lábszár rész függőlegesen záródó cipzárral
Slim fit

CE

TREKKING
HEAVY



	I	Ft		
XS	46	23.950	1	076000100
S	48	23.950	1	076000101
M	50	23.950	1	076000102
L	52	23.950	1	076000103
XL	54	23.950	1	076000104
XXL	56	23.950	1	076000105
XXXL	58	23.950	1	076000106

7610G

„work trekking” nadrág, LIGHT
90% nejlón, 10% elasztikus szövet, 140 g/m²,
megerősített anyag a térdnél és az ülőrészen,
elasztikus lábszár rész és behúzó
Sötétszürke, sárga betétekkel
Slim fit

CE

TREKKING
LIGHT

MEZMÉRÉS	I	Ft	☺	☒
XS	46	23.150	1	076100000
S	48	23.150	1	076100001
M	50	23.150	1	076100002
L	52	23.150	1	076100003
XL	54	23.150	1	076100004
XXL	56	23.150	1	076100005
XXXL	58	23.150	1	076100006

7610N

„work trekking” nadrág, LIGHT
90% nejlón, 10% elasztikus szövet, 140 g/m²,
megerősített anyag a térdnél és az ülőrészen,
elasztikus lábszár rész és behúzó
Fekete, sárga betétekkel
Slim fit

CE

TREKKING
LIGHT

MEZMÉRÉS	I	Ft	☺	☒
XS	46	23.150	1	076100100
S	48	23.150	1	076100101
M	50	23.150	1	076100102
L	52	23.150	1	076100103
XL	54	23.150	1	076100104
XXL	56	23.150	1	076100105
XXXL	58	23.150	1	076100106

7650

sokszobes elasztikus munkanadrág
90% nejlón - 10% spandex, 260 g/m²,
antracitszürke
600D poliészterrel erősített térdvédőzsebek,
hátsózsombok és lábszárak, elszakíthatatlan
ülőrész

CE

TOP
line

MEZMÉRÉS	I	Ft	☺	☒
XS	46	31.200	1	076500000
S	48	31.200	1	076500001
M	50	31.200	1	076500002
L	52	31.200	1	076500003
XL	54	31.200	1	076500004
XXL	56	31.200	1	076500005
XXXL	60	31.200	1	076500006

7650B

sokszobes elasztikus munkanadrág,
90% nejlón - 10% spandex, 260 g/m², kék
600D poliészterrel erősített térdvédőzsebek,
hátsózsombok és lábszárak, elszakíthatatlan
ülőrész

CE

TOP
line

MEZMÉRÉS	I	Ft	☺	☒
XS	46	31.150	1	076500100
S	48	31.150	1	076500101
M	50	31.150	1	076500102
L	52	31.150	1	076500103
XL	54	31.150	1	076500104
XXL	56	31.150	1	076500105
XXXL	58	31.150	1	076500106

7660B

sokszobes elasztikus munkanadrág, könnyített
kivitel,
86% nejlón - 14% spandex, 140 g/m², kék
300D poliészterrel erősített térdvédőzsebek és
hátsózsombok, elszakíthatatlan ülőrész
Slim fit

CE

TOP
line

MEZMÉRÉS	I	Ft	☺	☒
XS	46	26.800	1	076600100
S	48	26.800	1	076600101
M	50	26.800	1	076600102
L	52	26.800	1	076600103
XL	54	26.800	1	076600104
XXL	56	26.800	1	076600105
XXXL	58	26.800	1	076600106

7660G

sokszobes elasztikus munkanadrág, könnyített
kivitel, 86% nejlón - 14% spandex, 140 g/m²,
antracitszürke
300D poliészterrel erősített térdvédőzsebek és
hátsózsombok, elszakíthatatlan ülőrész
Slim fit

CE

TOP
line

MEZMÉRÉS	I	Ft	☺	☒
XS	46	26.800	1	076600000
S	48	26.800	1	076600001
M	50	26.800	1	076600002
L	52	26.800	1	076600003
XL	54	26.800	1	076600004
XXL	56	26.800	1	076600005
XXXL	58	26.800	1	076600006

7818G

sokzsebes munkanadrág, T/C vászon, 260 g/m², szürke
300D poliészterrel erősített térdvédőzsebek és lábszárok, szakadásbiztos ülőrész és elasztikus szövet betét a szár belső oldalán és a derékrészen a mozgás megkönnyítésére



Méret	I	Ft	CE	Icon
XS	46	21.650	1	078180000
S	48	21.650	1	078180001
M	50	21.650	1	078180002
L	52	21.650	1	078180003
XL	54	21.650	1	078180004
XXL	56	21.650	1	078180005
XXXL	58	21.650	1	078180006



7818BL

sokzsebes munkanadrág, T/C vászon, 260 g/m², kék
A szár belső oldalán elasztikus szövet betéttel
300D poliészterrel erősített térdvédőzsebek és lábszárok, szakadásbiztos ülőrész és elasztikus szövet betét a szár belső oldalán és a derékrészen a mozgás megkönnyítésére

CE



Méret	I	Ft	CE	Icon
XS	46	21.650	1	078180100
S	48	21.650	1	078180101
M	50	21.650	1	078180102
L	52	21.650	1	078180103
XL	54	21.650	1	078180104
XXL	56	21.650	1	078180105
XXXL	58	21.650	1	078180106

7818CM

sokzsebes munkanadrág, T/C vászon, 260 g/m², terepszínű szürke
300D poliészterrel erősített térdvédőzsebek és lábszárok, magas szakítószilárdságú ülőrész és elasztikus szövet betét a szár belső oldalán és a derékrészen a mozgás megkönnyítésének érdekében

CE



Méret	I	Ft	CE	Icon
XS	46	22.900	1	078180300
S	48	22.900	1	078180301
M	50	22.900	1	078180302
L	52	22.900	1	078180303
XL	54	22.900	1	078180304
XXL	56	22.900	1	078180305
XXXL	58	22.900	1	078180306

7818LN

sokzsebes női munkanadrág, fekete szín rózsaszín betétekkel,
100% elasztikus pamut, 220 g/m²
300D poliészterrel erősített térdvédőzsebek és lábszárok, szakadásbiztos ülőrész és elasztikus szövet betét a szár belső oldalán a mozgás megkönnyítésére

CE

lady



Méret	I	Ft	CE	Icon
XS	38	21.650	1	078180200
S	40	21.650	1	078180201
M	42	21.650	1	078180202
L	44	21.650	1	078180203
XL	46	21.650	1	078180204
XXL	48	21.650	1	078180205
XXXL	50	21.650	1	078180206

7830SN

elasztikus munkanadrág,
T/C twill anyagból, 200 g/m², fekete
Slim fit, szakadásbiztos ülőrész és oldalt
gumírozott derékrész

CE

STRETCH



Méret	I	Ft	CS	CS
XS	46	18.900	1	078300100
S	48	18.900	1	078300101
M	50	18.900	1	078300102
L	52	18.900	1	078300103
XL	54	18.900	1	078300104
XXL	56	18.900	1	078300105
XXXL	58	18.900	1	078300106

7830ST

elasztikus munkanadrág
T/C Twill 250 g, szürke
Slim fit, szakadásbiztos ülőrész és oldalt
gumírozott derékrész

CE

STRETCH



Méret	I	Ft	CS	CS
XS	46	19.400	1	078300000
S	48	19.400	1	078300001
M	50	19.400	1	078300002
L	52	19.400	1	078300003
XL	54	19.400	1	078300004
XXL	56	19.400	1	078300005
XXXL	58	19.400	1	078300006

7840BL

T/C twill munkanadrág 245 g, kék
Derékban oldalt elasztikus

CE

Beta EASY



Méret	I	Ft	CS	CS
XS	46	12.250	1	078400100
S	48	12.250	1	078400101
M	50	12.250	1	078400102
L	52	12.250	1	078400103
XL	54	12.250	1	078400104
XXL	56	12.250	1	078400105
XXXL	58	12.250	1	078400106
XXXXL	60	12.250	1	078400107

7860G

munkanadrág, könnyített kivitel,
T/C twill, 180 g/m², Oxford betétekkel, szürke
Új kialakítás – jobb viselhetőség

CE

Beta EASY

LIGHT



Méret	I	Ft	CS	CS
XS	46	15.200	1	078600800
S	48	15.200	1	078600801
M	50	15.200	1	078600802
L	52	15.200	1	078600803
XL	54	15.200	1	078600804
XXL	56	15.200	1	078600805
XXXL	58	15.200	1	078600806
XXXXL	60	15.200	1	078600807

7880SC

elasztikus munkanadrág
T/C Canvas 290 g, fekete
Slim fit, szakadásbiztos ülőrész és oldalt
gumírozott derékrész

CE

STRETCH



Méret	I	Ft	CS	CS
XS	46	19.950	1	078800000
S	48	19.950	1	078800001
M	50	19.950	1	078800002
L	52	19.950	1	078800003
XL	54	19.950	1	078800004
XXL	56	19.950	1	078800005
XXXL	58	19.950	1	078800006

Beta

7900B

munkanadrág,
T/C vászon, 260 g/m², Oxford betétekkel, kék

CE

BetaEASY



	I	Ft		
XS	46	17.550	1	079000700
S	48	17.550	1	079000701
M	50	17.550	1	079000702
L	52	17.550	1	079000703
XL	54	17.550	1	079000704
XXL	56	17.550	1	079000705
XXXL	58	17.550	1	079000706
XXXXL	60	17.550	1	079000707

7900G

munkanadrág,
T/C vászon, 260 g/m², Oxford betétekkel,
szürke
Új kialakítás – jobb viselhetőség

CE

BetaEASY



	I	Ft		
XS	46	17.550	1	079000800
S	48	17.550	1	079000801
M	50	17.550	1	079000802
L	52	17.550	1	079000803
XL	54	17.550	1	079000804
XXL	56	17.550	1	079000805
XXXL	58	17.550	1	079000806
XXXXL	60	17.550	1	079000807

7900P

munkanadrág,
T/C vászon, 260 g/m², Oxford betétekkel,
petrolkék

CE

BetaEASY



	I	Ft		
XS	46	17.550	1	079000600
S	48	17.550	1	079000601
M	50	17.550	1	079000602
L	52	17.550	1	079000603
XL	54	17.550	1	079000604
XXL	56	17.550	1	079000605
XXXL	58	17.550	1	079000606
XXXXL	60	17.550	1	079000607

7900V

munkanadrág,
T/C vászon, 260 g/m², Oxford betétekkel, zöld

CE

BetaEASY



	I	Ft		
XS	46	17.550	1	079000500
S	48	17.550	1	079000501
M	50	17.550	1	079000502
L	52	17.550	1	079000503
XL	54	17.550	1	079000504
XXL	56	17.550	1	079000505
XXXL	58	17.550	1	079000506
XXXXL	60	17.550	1	079000507

7930G

munkanadrág,
97% pamut, 3% elasztikus szövet, 220 g/m²
Slim fit

CE

Cotton



	I	Ft		
XS	46	18.300	1	079300300
S	48	18.300	1	079300301
M	50	18.300	1	079300302
L	52	18.300	1	079300303
XL	54	18.300	1	079300304
XXL	56	18.300	1	079300305
XXXL	58	18.300	1	079300306

7940

többszörös védelmet nyújtó munkanadrág
T/C twill, 250 g/m², kék,
hőálló, lángálló, elektromos ív, hegesztési
szikrák és vegyi anyagok elleni védelem.

CE



7949



621

DPI: III^A Categoria
EN ISO 11611:2015 - Classe 1
EN ISO 11612:2015 - A1 B1 C1
EN 1149-5:2018
EN13034:2005+A1:2009 - Type 6
IEC 61482-2:2018 - APC 1

	I	Ft		
XS	46	25.000	1	079400000
S	48	25.000	1	079400001
M	50	25.000	1	079400002
L	52	25.000	1	079400003
XL	54	25.000	1	079400004
XXL	56	25.000	1	079400005
XXXL	58	25.000	1	079400006
XXXXL	60	25.000	1	079400007

BERMUDA



7529

Elastikus bermuda munkanadrág
98% pamut-denim, 2% elasztán, ~340g/m²

CE

Jeans



Méret	I	Ft	1	2
XS	46	15.000	1	075290046
S	48	15.000	1	075290048
M	50	15.000	1	075290050
L	52	15.000	1	075290052
XL	54	15.000	1	075290054
XXL	56	15.000	1	075290056
XXXL	58	15.000	1	075290058

7611G

„work trekking” bermudanadrág, LIGHT
90% nejlón, 10% elasztikus szövet, 140 g/m²,
megerősített ülőrész.
Sötétszürke, sárga betétekkel.
Slim fit

CE

TREKKING
LIGHT



Méret	I	Ft	1	2
XS	46	17.650	1	076110000
S	48	17.650	1	076110001
M	50	17.650	1	076110002
L	52	17.650	1	076110003
XL	54	17.650	1	076110004
XXL	56	17.650	1	076110005
XXXL	58	17.650	1	076110006

7661B

sokszébes elasztikus bermuda munkanadrág,
könnyített kivitel,
86% nejlón - 14% spandex, 140 g/m², kék
300D poliészterrel erősített hátszések,
magas szakítószilárdságú ülőrész
Slim fit

CE



TOP
line



Méret	I	Ft	1	2
XS	46	21.850	1	076610100
S	48	21.850	1	076610101
M	50	21.850	1	076610102
L	52	21.850	1	076610103
XL	54	21.850	1	076610104
XXL	56	21.850	1	076610105
XXXL	58	21.850	1	076610106

7661G

sokszébes elasztikus bermuda munkanadrág,
könnyített kivitel,
86% nejlón - 14% spandex, 140 g/m²,
antracitszürke
300D poliészterrel erősített hátszések,
magas szakítószilárdságú ülőrész
Slim fit

CE



TOP
line



Méret	I	Ft	1	2
XS	46	21.850	1	076610000
S	48	21.850	1	076610001
M	50	21.850	1	076610002
L	52	21.850	1	076610003
XL	54	21.850	1	076610004
XXL	56	21.850	1	076610005
XXXL	58	21.850	1	076610006

Beta

7815CM

sokszébes bermuda munkanadrág, T/C
vászón, 260 g/m², terepszínű szürke, magas
szakítószilárdságú ülőrész és elasztikus
szövet betét a szár belső oldalán és a
derékrészen a mozgás megkönnyítésének
érdekében

CE



Méret	I	Ft	1	2
XS	46	19.100	1	078150300
S	48	19.100	1	078150301
M	50	19.100	1	078150302
L	52	19.100	1	078150303
XL	54	19.100	1	078150304
XXL	56	19.100	1	078150305
XXXL	58	19.100	1	078150306

7831SN

elasztikus bermuda munkanadrág,
T/C twill anyagból, 200 g/m², fekete
Slim fit, szakadásbiztos ülőrész és oldalt
gumírozott derékrész

CE



Méret	I	Ft	1	2
XS	46	15.450	1	078310100
S	48	15.450	1	078310101
M	50	15.450	1	078310102
L	52	15.450	1	078310103
XL	54	15.450	1	078310104
XXL	56	15.450	1	078310105
XXXL	58	15.450	1	078310106

7831ST

elasztikus bermuda munkanadrág
T/C Twill 250 g, szürke
Slim fit, szakadásbiztos ülőrész és oldalt
gumírozott derékrész

CE



Méret	I	Ft	1	2
XS	46	15.050	1	078310000
S	48	15.050	1	078310001
M	50	15.050	1	078310002
L	52	15.050	1	078310003
XL	54	15.050	1	078310004
XXL	56	15.050	1	078310005
XXXL	58	15.050	1	078310006

7861G

Bermuda munkanadrág, könnyített kivitel
T/C twill, 180 g/m², Oxford betétekkel, szürke
Új kialakítás – jobb viselhetőség



	I	Ft		
XS	46	13.550	1	078610800
S	48	13.550	1	078610801
M	50	13.550	1	078610802
L	52	13.550	1	078610803
XL	54	13.550	1	078610804
XXL	56	13.550	1	078610805
XXXL	58	13.550	1	078610806
XXXXL	60	13.550	1	078610807

7901G

bermuda munkanadrág
T/C vászon, 260 g/m², Oxford betétekkel,
szürke
Új kialakítás – jobb viselhetőség



	I	Ft		
XS	46	14.800	1	079010800
S	48	14.800	1	079010801
M	50	14.800	1	079010802
L	52	14.800	1	079010803
XL	54	14.800	1	079010804
XXL	56	14.800	1	079010805
XXXL	58	14.800	1	079010806
XXXXL	60	14.800	1	079010807

7931G

rövid bermuda munkanadrág,
100% elasztikus pamut, 220 g/m²
Slim fit



	I	Ft		
XS	46	14.800	1	079310300
S	48	14.800	1	079310301
M	50	14.800	1	079310302
L	52	14.800	1	079310303
XL	54	14.800	1	079310304
XXL	56	14.800	1	079310305
XXXL	58	14.800	1	079310306

OVERALLS

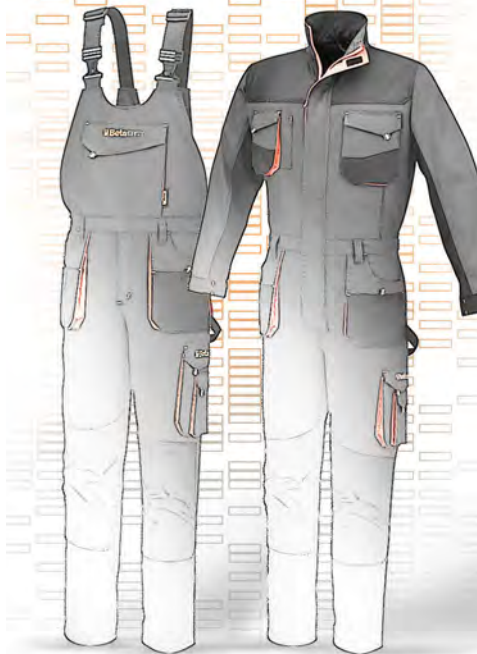

7863G

kertész nadrág, könnyített kivitel
T/C twill, 180 g/m², Oxford betétekkel, szürke
Új kialakítás – jobb viselhetőség



	I	Ft		
XS	46	19.550	1	078630800
S	48	19.550	1	078630801
M	50	19.550	1	078630802
L	52	19.550	1	078630803
XL	54	19.550	1	078630804
XXL	56	19.550	1	078630805
XXXL	58	19.550	1	078630806
XXXXL	60	19.550	1	078630807

7903G

kertész nadrág,
T/C vászon, 260 g/m², Oxford betétekkel,
szürke
Új kialakítás – jobb viselhetőség



	I	Ft		
XS	46	22.200	1	079030800
S	48	22.200	1	079030801
M	50	22.200	1	079030802
L	52	22.200	1	079030803
XL	54	22.200	1	079030804
XXL	56	22.200	1	079030805
XXXL	58	22.200	1	079030806
XXXXL	60	22.200	1	079030807

7903P

kertész nadrág,
T/C vászon, 260 g/m², Oxford betétekkel,
petrolkék



	I	Ft		
XS	46	22.200	1	079030600
S	48	22.200	1	079030601
M	50	22.200	1	079030602
L	52	22.200	1	079030603
XL	54	22.200	1	079030604
XXL	56	22.200	1	079030605
XXXL	58	22.200	1	079030606
XXXXL	60	22.200	1	079030607

7933G

kertész nadrág,

CE

Cotton



Méret	Ft	Ár	Leírás
XS	23.400	1	079330300
S	23.400	1	079330301
M	23.400	1	079330302
L	23.400	1	079330303
XL	23.400	1	079330304
XXL	23.400	1	079330305
XXXL	23.400	1	079330306

7865G

overall, könnyített kivitel,
T/C twill, 180 g/m², Oxford betétekkel, szürke
Új kialakítás – jobb viselhetőség

CE

Beta EASY

LIGHT



Méret	Ft	Ár	Leírás
XS	26.050	1	078650800
S	26.050	1	078650801
M	26.050	1	078650802
L	26.050	1	078650803
XL	26.050	1	078650804
XXL	26.050	1	078650805
XXXL	26.050	1	078650806
XXXXL	26.050	1	078650807

7905G

overall (munkaruha)
T/C vászon, 260 g/m², Oxford betétekkel,
szürke
Új kialakítás – jobb viselhetőség

Beta EASY

CE



Méret	Ft	Ár	Leírás
XS	28.350	1	079050800
S	28.350	1	079050801
M	28.350	1	079050802
L	28.350	1	079050803
XL	28.350	1	079050804
XXL	28.350	1	079050805
XXXL	28.350	1	079050806
XXXXL	28.350	1	079050807

7935G

overall (munkaruha),
100% elasztikus pamut, 220 g/m²
Slim fit

CE Cotton



Méret	Ft	Ár	Leírás
XS	32.150	1	079350300
S	32.150	1	079350301
M	32.150	1	079350302
L	32.150	1	079350303
XL	32.150	1	079350304
XXL	32.150	1	079350305
XXXL	32.150	1	079350306

WORK JACKETS



7653G

sokszéves, elasztikus munkadzseki
90% nejlón, 10% spandex, 260 g/m²,
antracitszürke

CE



TOP line



Méret	Ft	Ár	Leírás
XS	26.700	1	076530000
S	26.700	1	076530001
M	26.700	1	076530002
L	26.700	1	076530003
XL	26.700	1	076530004
XXL	26.700	1	076530005
XXXL	26.700	1	076530006

7849BL

T/C twill munkadzseki 245 g, kék
Elastikus deréksáv

CE

Beta EASY



Méret	Ft	Ár	Leírás
XS	13.300	1	078490100
S	13.300	1	078490101
M	13.300	1	078490102
L	13.300	1	078490103
XL	13.300	1	078490104
XXL	13.300	1	078490105
XXXL	13.300	1	078490106
XXXXL	13.300	1	078490107

7869G

munkadzseki, könnyített kivitel,
T/C twill, 180 g/m², Oxford betétekkel, szürke
Új kialakítás – jobb viselhetőség

CE

Beta EASY

LIGHT



	Ft		
XS	17.900	1	078690800
S	17.900	1	078690801
M	17.900	1	078690802
L	17.900	1	078690803
XL	17.900	1	078690804
XXL	17.900	1	078690805
XXXL	17.900	1	078690806
XXXXL	17.900	1	078690807

7909B

munkadzseki,
T/C vászon, 260 g/m², Oxford betétekkel, kék

CE

Beta EASY



	Ft		
XS	19.800	1	079090700
S	19.800	1	079090701
M	19.800	1	079090702
L	19.800	1	079090703
XL	19.800	1	079090704
XXL	19.800	1	079090705
XXXL	19.800	1	079090706
XXXXL	19.800	1	079090707

7909G

munkadzseki,
T/C vászon, 260 g/m², Oxford betétekkel,
szürke
Új kialakítás – jobb viselhetőség

CE

Beta EASY



	Ft		
XS	19.800	1	079090800
S	19.800	1	079090801
M	19.800	1	079090802
L	19.800	1	079090803
XL	19.800	1	079090804
XXL	19.800	1	079090805
XXXL	19.800	1	079090806
XXXXL	19.800	1	079090807

7909P

munkadzseki,
T/C vászon, 260 g/m², Oxford betétekkel,
petrolkék

CE

Beta EASY



	Ft		
XS	19.800	1	079090600
S	19.800	1	079090601
M	19.800	1	079090602
L	19.800	1	079090603
XL	19.800	1	079090604
XXL	19.800	1	079090605
XXXL	19.800	1	079090606
XXXXL	19.800	1	079090607

7909V

munkadzseki,
T/C vászon, 260 g/m², Oxford betétekkel, zöld

CE

Beta EASY



	Ft		
XS	19.800	1	079090500
S	19.800	1	079090501
M	19.800	1	079090502
L	19.800	1	079090503
XL	19.800	1	079090504
XXL	19.800	1	079090505
XXXL	19.800	1	079090506
XXXXL	19.800	1	079090507

7939G

munkadzseki,
100% elasztikus pamut, 220 g/m²
Slim fit

CE

Cotton



	Ft		
XS	20.450	1	079390300
S	20.450	1	079390301
M	20.450	1	079390302
L	20.450	1	079390303
XL	20.450	1	079390304
XXL	20.450	1	079390305
XXXL	20.450	1	079390306

7949

többszörös védelmet nyújtó munkadzseki,
T/C twill 250 g/m², kék,
hőálló, lángálló, elektromos iv, hegesztési
szikrák és vegyi anyagok elleni védelem.

CE

DPI: III* Categoria
EN ISO 11611:2015 - Classe 1
EN ISO 11612:2015 - A1 B1 C1
EN 1149-5:2018
EN13034:2005+A1:2009 - Type 6
IEC 61482-2:2018 - APC 1



7940

617

	Ft		
XS	28.700	1	079490000
S	28.700	1	079490001
M	28.700	1	079490002
L	28.700	1	079490003
XL	28.700	1	079490004
XXL	28.700	1	079490005
XXXL	28.700	1	079490006
XXXXL	28.700	1	079490007

Beta

Beta

SLEEVELESS JACKETS



7575N

softshell mellény,
90% nejlón, 10% elasztikus szövet, 250 g/m²



Méret	Ft	CS	CS
S	27.350	1	075750301
M	27.350	1	075750302
L	27.350	1	075750303
XL	27.350	1	075750304
XXL	27.350	1	075750305
XXXL	27.350	1	075750306

7579QN

sokszéles munkamellény kétféle anyagból
100% 300D vízálló nejlón és softshell anyag,
96% poliészter, 4% spandex, poliészter
vattázás, 160 g/m²
fekete/antracitszürke

CE



Méret	Ft	CS	CS
S	21.150	1	075790201
M	21.150	1	075790202
L	21.150	1	075790203
XL	21.150	1	075790204
XXL	21.150	1	075790205
XXXL	21.150	1	075790206

Beta

7673NG

munkamellény, GRAFÉN béléssel, 80 g/m²
elől erősített softshell anyag, - 96% poliészter,
4% spandex, hátrész 100% nejlón 20D
antracitszürke (elől), fekete (hátrész)
Elasztikus betét a hónaljnál
Antisztatikus, antibakteriális, szélálló

CE

TOP
LINE



Méret	Ft	CS	CS
S	26.050	1	076730001
M	26.050	1	076730002
L	26.050	1	076730003
XL	26.050	1	076730004
XXL	26.050	1	076730005
XXXL	26.050	1	076730006

7867G

munkamellény, könnyített kivitel,
T/C twill, 180 g/m², Oxford betétekkel, szürke
Új kialakítás – jobb viselhetőség

CE

LIGHT



Méret	Ft	CS	CS
XS	15.050	1	078670800
S	15.050	1	078670801
M	15.050	1	078670802
L	15.050	1	078670803
XL	15.050	1	078670804
XXL	15.050	1	078670805
XXXL	15.050	1	078670806
XXXXL	15.050	1	078670807

7907G

munkamellény,
T/C vászon, 260 g/m², Oxford betétekkel,
szürke

Új kialakítás – jobb viselhetőség

CE

Beta EASY



Méret	Ft	CS	CS
XS	16.850	1	079070800
S	16.850	1	079070801
M	16.850	1	079070802
L	16.850	1	079070803
XL	16.850	1	079070804
XXL	16.850	1	079070805
XXXL	16.850	1	079070806
XXXXL	16.850	1	079070807

7907P

munkamellény,
T/C vászon, 260 g/m², Oxford betétekkel,
petrolkék

CE

Beta EASY



Méret	Ft	CS	CS
XS	16.850	1	079070600
S	16.850	1	079070601
M	16.850	1	079070602
L	16.850	1	079070603
XL	16.850	1	079070604
XXL	16.850	1	079070605
XXXL	16.850	1	079070606
XXXXL	16.850	1	079070607

Beta

JACKETS



7658CM

softshell dzseki, 94% poliészter, 6% spandex, 290 g/m², terepszínű szűrke
Vízálló, szélálló, szellőző TPU membránnal
(vízállóság: max. 8 000 mm, páraáteresztő képesség: 8 000 mvp)

TOP line



	Ft		
S	33.100	1	076580101
M	33.100	1	076580102
L	33.100	1	076580103
XL	33.100	1	076580104
XXL	33.100	1	076580105
XXXL	33.100	1	076580106

7658N

softshell dzseki, 94% poliészter, 6% spandex, 290 g/m², antracitszürke
Vízálló, szélálló, szellőző TPU membránnal
(vízállóság: max. 8 000 mm, páraáteresztő képesség: 8 000 mvp)

TOP line



	Ft		
S	35.800	1	076580001
M	35.800	1	076580002
L	35.800	1	076580003
XL	35.800	1	076580004
XXL	35.800	1	076580005
XXXL	35.800	1	076580006

7659N

softshell dzseki, 94% poliészter, 6% spandex, 290 g/m²,
levehető kapucnival és ujjakkal, fekete
Vízálló, szélálló, szellőző TPU membránnal
(vízállóság: max. 8 000 mm, páraáteresztő

TOP line



	Ft		
S	52.450	1	076590001
M	52.450	1	076590002
L	52.450	1	076590003
XL	52.450	1	076590004
XXL	52.450	1	076590005
XXXL	52.450	1	076590006

7669N

sokzsebes elasztikus munkadzseki, könnyített kivitel, 86% nejlon, 14% spandex, 140 g/m², fekete
Levehető ujjakkal és kapucnival.
Vízálló, szélálló

4-WAY STRETCH

TOP line



	Ft		
XS	36.000	1	076690000
S	36.000	1	076690001
M	36.000	1	076690002
L	36.000	1	076690003
XL	36.000	1	076690004
XXL	36.000	1	076690005
XXXL	36.000	1	076690006

Beta

7670G

Oxford 300D poliészter dzseki vízálló, PU-bevonatú, antracitszürke
Levehető kapucnival és erősített ujjakkal.
Vízálló, szélálló és szellőző (vízállóság: max. 2 000 mm, páraáteresztő képesség: 2 000 mvp)
210T poliészter bélés, poliészter vattázás, törzsrész: 120 g/m², ujjak: 100 g/m²

CE TOP line



	Ft		
S	29.050	1	076700001
M	29.050	1	076700002
L	29.050	1	076700003
XL	29.050	1	076700004
XXL	29.050	1	076700005
XXXL	29.050	1	076700006

7674NG

steppelt munkakabát, GRAFÉN béléssel, 80 g/m²
elől és alkarnál erősített softshell anyag, - 96% poliészter, 4% spandex, hátrész és ujjak 100% nejlon 20D
antracitszürke (elől), fekete (hátról)
rugalmas mandzsetták
Antisztatikus, antibakteriális, szélálló

CE TOP line



	Ft		
S	32.300	1	076740001
M	32.300	1	076740002
L	32.300	1	076740003
XL	32.300	1	076740004
XXL	32.300	1	076740005
XXXL	32.300	1	076740006

Beta

7780QN

sokszéles bomber munkadzseki kétféle anyagból.
100% 300D vízálló nejlón és softshell anyag,
96% poliészter, 4% spandex, poliészter
vattázás, 160 g/m²
kapucni
fix fekete/antracitszürke

CE



	Ft		
S	35.850	1	077800201
M	35.850	1	077800202
L	35.850	1	077800203
XL	35.850	1	077800204
XXL	35.850	1	077800205
XXXL	35.850	1	077800206

7904N

vattázott bomber munkadzseki
T/C vászon, 270 g/m², Oxford betétekkel,
fekete
Poliészter vattázás, 140 g/m²

CE

Beta EASY



	Ft		
XS	34.550	1	079040800
S	34.550	1	079040801
M	34.550	1	079040802
L	34.550	1	079040803
XL	34.550	1	079040804
XXL	34.550	1	079040805
XXXL	34.550	1	079040806
XXXXL	34.550	1	079040807

FLEECE



7637G

hosszú ujjú, kapucnis felső, hosszú cipzáras,
250 g/m²
polár, 100% poliészter, 100D softshell anyagú
betétek, kötött polár, 270 g/m²
melanzs szürke/fekete



	Ft		
XS	27.200	1	076370000
S	27.200	1	076370001
M	27.200	1	076370002
L	27.200	1	076370003
XL	27.200	1	076370004
XXL	27.200	1	076370005
XXXL	27.200	1	076370006

7635N

Mikropolár pulóver rövid cipzárral, 180 g/m²,
fekete



	Ft		
XS	10.850	1	076350500
S	10.850	1	076350501
M	10.850	1	076350502
L	10.850	1	076350503
XL	10.850	1	076350504
XXL	10.850	1	076350505
XXXL	10.850	1	076350506

7654B

elasztikus mikropolár pulóver rövid cipzárral,
180 g/m², kék
95% poliészter, 5% spandex



TOP line



	Ft		
XS	15.150	1	076540100
S	15.150	1	076540101
M	15.150	1	076540102
L	15.150	1	076540103
XL	15.150	1	076540104
XXL	15.150	1	076540105
XXXL	15.150	1	076540106

7654N

elasztikus mikropolár pulóver rövid cipzárral,
180 g/m², fekete
95% poliészter, 5% spandex



TOP line



	Ft		
XS	15.150	1	076540000
S	15.150	1	076540001
M	15.150	1	076540002
L	15.150	1	076540003
XL	15.150	1	076540004
XXL	15.150	1	076540005
XXXL	15.150	1	076540006

7657B

elasztikus polár pulóver hosszú cipzárral,
280 g/m², kék
95% poliészter, 5% spandex



TOP line



	Ft		
XS	19.150	1	076570100
S	19.150	1	076570101
M	19.150	1	076570102
L	19.150	1	076570103
XL	19.150	1	076570104
XXL	19.150	1	076570105
XXXL	19.150	1	076570106

Beta

7657N

elasztikus polár pulóver hosszú cipzárral, 280 g/m², fekete
95% poliészter, 5% spandex



TOP
line



	Ft		
XS	19.150	1	076570000
S	19.150	1	076570001
M	19.150	1	076570002
L	19.150	1	076570003
XL	19.150	1	076570004
XXL	19.150	1	076570005
XXXL	19.150	1	076570006

7664G

hosszú ujjú felső, hosszú cipzáras, 280 g/m², szürke
60% pamut, 40% poliészter

TOP
line



	Ft		
XS	14.350	1	076640100
S	14.350	1	076640101
M	14.350	1	076640102
L	14.350	1	076640103
XL	14.350	1	076640104
XXL	14.350	1	076640105
XXXL	14.350	1	076640106

7664N

hosszú ujjú felső, hosszú cipzáras, 280 g/m², fekete
60% pamut, 40% poliészter

TOP
line



	Ft		
XS	14.350	1	076640000
S	14.350	1	076640001
M	14.350	1	076640002
L	14.350	1	076640003
XL	14.350	1	076640004
XXL	14.350	1	076640005
XXXL	14.350	1	076640006

7665G

hosszú ujjú kapucnis felső, hosszú cipzáras, 280 g/m², szürke
60% pamut, 40% poliészter

TOP
line



	Ft		
XS	15.550	1	076650100
S	15.550	1	076650101
M	15.550	1	076650102
L	15.550	1	076650103
XL	15.550	1	076650104
XXL	15.550	1	076650105
XXXL	15.550	1	076650106

7665N

hosszú ujjú kapucnis felső, hosszú cipzáras, 280 g/m², fekete
60% pamut, 40% poliészter

TOP
line



	Ft		
XS	15.550	1	076650000
S	15.550	1	076650001
M	15.550	1	076650002
L	15.550	1	076650003
XL	15.550	1	076650004
XXL	15.550	1	076650005
XXXL	15.550	1	076650006



SHIRT & T-SHIRT

7545F

kockás flanel munkaing, 100% pamut, 190 g/m²



	Ft		
XS	12.150	1	075450200
S	12.150	1	075450201
M	12.150	1	075450202
L	12.150	1	075450203
XL	12.150	1	075450204
XXL	12.150	1	075450205
XXXL	12.150	1	075450206

7547AZ

három gombos pólóing, 100% pamut, 200 g/m², világoskék



	Ft		
XS	8.670	2	075470500
S	8.670	2	075470501
M	8.670	2	075470502
L	8.670	2	075470503
XL	8.670	2	075470504
XXL	8.670	2	075470505
XXXL	8.670	2	075470506

7547BL

három gombos pólóing, 100% pamut, 200 g/m², kék



	Ft		
XS	8.670	2	075470200
S	8.670	2	075470201
M	8.670	2	075470202
L	8.670	2	075470203
XL	8.670	2	075470204
XXL	8.670	2	075470205
XXXL	8.670	2	075470206

7547Ghárom gombos pólóing,
100% pamut, 200 g/m², szürke

	Ft		
XS	8.670	2	075470300
S	8.670	2	075470301
M	8.670	2	075470302
L	8.670	2	075470303
XL	8.670	2	075470304
XXL	8.670	2	075470305
XXXL	8.670	2	075470306

7549AZ„work” póló, 100% pamut, 150 g/m²,
világoskék

	Ft		
XS	6.560	5	075490500
S	6.560	5	075490501
M	6.560	5	075490502
L	6.560	5	075490503
XL	6.560	5	075490504
XXL	6.560	5	075490505
XXXL	6.560	5	075490506

7549NE„Work” póló, 100% pamut, 150 g/m², fekete

	Ft		
XS	6.560	5	075490700
S	6.560	5	075490701
M	6.560	5	075490702
L	6.560	5	075490703
XL	6.560	5	075490704
XXL	6.560	5	075490705
XXXL	6.560	5	075490706

7547Nhárom gombos pólóing,
100% pamut, 200 g/m², fekete

	Ft		
XS	8.670	2	075470400
S	8.670	2	075470401
M	8.670	2	075470402
L	8.670	2	075470403
XL	8.670	2	075470404
XXL	8.670	2	075470405
XXXL	8.670	2	075470406

7549BL„work” póló, 100% pamut, 150 g/m², kék

	Ft		
XS	6.560	5	075490200
S	6.560	5	075490201
M	6.560	5	075490202
L	6.560	5	075490203
XL	6.560	5	075490204
XXL	6.560	5	075490205
XXXL	6.560	5	075490206

7549N„work” póló, 100% pamut, 150 g/m², fekete

	Ft		
XS	6.560	5	075490400
S	6.560	5	075490401
M	6.560	5	075490402
L	6.560	5	075490403
XL	6.560	5	075490404
XXL	6.560	5	075490405
XXXL	6.560	5	075490406

7547Rhárom gombos pólóing,
100% pamut, 200 g/m², piros

	Ft		
XS	8.670	2	075470600
S	8.670	2	075470601
M	8.670	2	075470602
L	8.670	2	075470603
XL	8.670	2	075470604
XXL	8.670	2	075470605
XXXL	8.670	2	075470606

7549G„work” póló, 100% pamut, 150 g/m², szürke

	Ft		
XS	6.560	5	075490300
S	6.560	5	075490301
M	6.560	5	075490302
L	6.560	5	075490303
XL	6.560	5	075490304
XXL	6.560	5	075490305
XXXL	6.560	5	075490306

7549R„work” póló, 100% pamut, 150 g/m², piros

	Ft		
XS	6.560	5	075490600
S	6.560	5	075490601
M	6.560	5	075490602
L	6.560	5	075490603
XL	6.560	5	075490604
XXL	6.560	5	075490605
XXXL	6.560	5	075490606

7550G

munkapóló, poliészter, 120 g/m²,
37.5° technológia,
szürke – fekete, narancs és fényvisszaverő
betétekkel



	Ft		
XS	12.300	1	075500400
S	12.300	1	075500401
M	12.300	1	075500402
L	12.300	1	075500403
XL	12.300	1	075500404
XXL	12.300	1	075500405
XXXL	12.300	1	075500406

7550N

munkapóló, poliészter, 120 g/m²
37.5° technológia,
fekete – szürke, narancs és fényvisszaverő
betétekkel



	Ft		
XS	12.300	1	075500500
S	12.300	1	075500501
M	12.300	1	075500502
L	12.300	1	075500503
XL	12.300	1	075500504
XXL	12.300	1	075500505
XXXL	12.300	1	075500506

7557BL

három gombos pólóing, hosszú ujjú
100% pamut, 200 g/m², kék



	Ft		
XS	10.750	1	075570200
S	10.750	1	075570201
M	10.750	1	075570202
L	10.750	1	075570203
XL	10.750	1	075570204
XXL	10.750	1	075570205
XXXL	10.750	1	075570206

RAIN

7970

Impregnált nadrág PVC Tricot, kék

CE



EN 343

	Ft		
XS	13.750	1	079700000
S	13.750	1	079700001
M	13.750	1	079700002
L	13.750	1	079700003
XL	13.750	1	079700004
XXL	13.750	1	079700005
XXXL	13.750	1	079700006

7971L

polieszter impregnált nadrág, PVC bevonattal,
hegesztett varratok, kék
Gumírozott derékrész és patentgombbal
bokánál állítható nadrágszár

CE



EN 343

	Ft		
XS	7.480	1	079710100
S	7.480	1	079710101
M	7.480	1	079710102
L	7.480	1	079710103
XL	7.480	1	079710104
XXL	7.480	1	079710105
XXXL	7.480	1	079710106

7978L

Vízálló PVC bevonatos poliészter hosszúkabát
kapucnival és hegesztett varratokkal, kék
Patentgombokkal 3/4-es kabátá alakítható

CE



EN 343

	Ft		
XS	10.500	1	079780100
S	10.500	1	079780101
M	10.500	1	079780102
L	10.500	1	079780103
XL	10.500	1	079780104
XXL	10.500	1	079780105
XXXL	10.500	1	079780106

7979

Impregnált dzseki PVC Tricot, kék

CE



EN 343

	Ft		
S	22.200	1	079790001
M	22.200	1	079790002
L	22.200	1	079790003
XL	22.200	1	079790004
XXL	22.200	1	079790005
XXXL	22.200	1	079790006

UNDERWEAR

7996N

technikai aláöltöző szett - póló, hosszú ujjú + alsónadrág, 92% poliészter, 8% spandex, 160 g/m², fekete



	Ft		
XS-S	12.550	1	079960000
M-L	12.550	1	079960002
XL-XXL	12.550	1	079960004

ACCESSORIES

7800G

Térdvédő (pár) munkaruházathoz



	Ft		
7800G	4.150	1	078000500

7980N

vízhatlan sapka
100% PU-bevonatú poliészter
vízlepergetővel kezelt



	Ft		
L = Ø 58 cm	3.560	1	079800058
XL = Ø 60 cm	3.560	1	079800060

7980NC

polár téli sapka, 100% poliészter, kifordítható, terepszínű fekete



	Ft		
7980NC	3.470	10	079800112

7980R

kötött téli sapka, 100% akril,
3M Thinsulate™ bélés, fekete



	Ft		
7980R	2.990	10	079800111

7984EG

elasztán öv szatinált cink fém csattal
egy méret, hosszúság: 120 cm, rövidíthető,
szélesség: 37 mm,
szürke



	Ft		
7984EG	7.010	1	079840520

7984G

öv, 100% TPE, horgany kromátozott fémcsat,
egy méretben: 125 cm, rövidíthető, szélesség
35 mm,
fekete



	Ft		
7984G	4.400	1	079840525

7985

Nyakmelegítő Mikrofleecce szabályozható,
fekete
Fejfedésre is használható



	Ft		
7985	3.940	10	079850111

7104 90

műanyag terelőoszlop tölthető talppal



	H mm	Ft		
7104 90	90	8.990	4	071040004

7105 6

műanyag zárólánc



	Ø mm	L m	Ft		
7105 6	6	25	30.000	1	071050006

7109A

aluminium figyelmeztető tábla



	H mm	Ft		
7109A1	140	5.400	1	071090001
7109A2	140	5.400	1	071090002
7109A3	140	5.400	1	071090003
7109A4	140	5.400	1	071090004

7109D

tiltó tábla



	H mm	Ft		
7109D1	115	5.400	1	071090051
7109D2	115	5.400	1	071090052
7109D3	115	5.400	1	071090053

7195A

CE



	Ft		
7195A	2.460	10	071950004

7061TC

Védőszemüveg polikarbonát üveggel

CE

EASY



EN166:2001
EN170
2C-1.2 1F

	Ft		
7061TC	3.620	1	070610001

7076BC

Védőszemüveg polikarbonát üveggel

CE

SPORT



EN166:2001
EN172
5-1.7 1F

	Ft		
7076BC	8.050	1	070760009

7076BD

Védőszemüveg sötét polikarbonát üveggel

CE

SPORT



EN166:2001
EN172
5-3.1 1F

	Ft		
7076BD	8.050	1	070760019

7076BP

Védőszemüveg sötét fényszűrő polikarbonát üveggel

CE

SPORT



EN ISO 12312-1:2013+A1:2015
EN 1836
3P

	Ft		
7076BP	13.400	1	070760029

7076BU

védőszemüveg polikarbonát üveggel

CE



EN ISO 12311:2013
UV 500

	Ft		
7076BU	6.460	1	070760039

7093BC

Védőszemüveg polikarbonát üveggel

CE

IMPACT



EN166:2001
EN170
2C-1.2 1F

	Ft		
7093BC	12.350	1	070930009

7093BD

Védőszemüveg sötét polikarbonát üveggel

CE

IMPACT



EN166:2001
EN172
5-3.1 1F

	Ft		
7093BD	12.350	1	070930019

C62M/W

Próbababa



185
cm

65 cm

	Ft		
C62M/W	190.700	1	062000361

6200M/B

tartalék üvegtalp a C62M/W próbababához



	Ft		
6200M/B	27.250	1	062000361

C64

ruházat és lábbeli bemutatóállvány, üres



2400
mm

560
mm

L	Ft		
1 m	460.600	1	064000021
2 m	833.000	1	064000022
3 m	1.205.400	1	064000023
4 m	1.577.800	1	064000024



C64G

ruházat és lábbeli bemutató gondola, üres

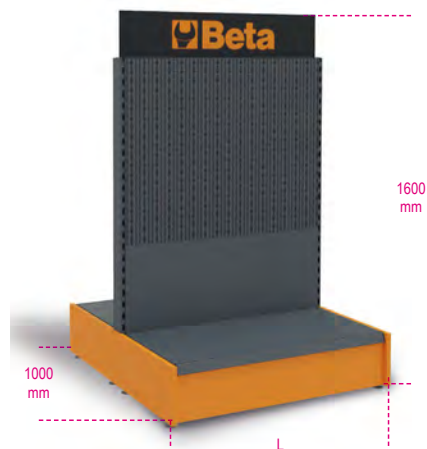

L	Ft	1	2
1 m	562.100	1 064000051	
2 m	1.020.700	1 064000052	

C64CW

öltöző



C64CW	Ft	1	2
	170.500	1 064000610	

6200AP/S10

10 darab ruhafogas



6200AP/S10	Ft	1	2
	16.250	1 062000331	

6800BA

vállfartató rúd a C64 típusú bemutatóállványhoz



6800BA	Ft	1	2
	48.950	1 068000130	

6800RS

cipőtartó a C64 típusú bemutatóállványhoz



6800RS	Ft	1	2
	40.950	1 068000135	

6888GS

cipőtartó a C64 típusú bemutatóállványhoz



6888GS	Ft	1	2
	10.500	2 068880122	

170x120 mm

6888GW

akasztó a C64 típusú bemutatóállványhoz



6888GW	Ft	1	2
	2.710	2 068880121	

400 mm

9562TB

cipő szőnyeg, csúszásmentes, gumibevonatú alsórész



9562TB	L mm	H mm	Ft	1	2
	800	600	12.850	1 095620500	

9565S

lemezacél hordószek kivehető műbőrrel



9565S	H cm	ø cm	Ft	1	2
	60	38	65.200	2 095650300	

Beta



Robur

A Robur 1930 óta gyárt a Beta Utensili elismert minőségi szabványainak megfelelő kábelszerelvényeket.

A piac követelményeinek és elvárásainak átfogó ismeretéből adódó szakértelem, szervezettség és technológia a folyamatos növekedés kulcsa.

1984 óta a Robur legmodernebb, minden igényt kielégítő gyártóbázisa Sulmona.



Bliszteres csomagolás

MEGENGEDETT TERHELÉS

WLL: Maximális üzemi terhelhetőség (emelőszerkezetnél)

WFL: Üzemi terhelhetőség (nem emelőszerkezetnél)

BF: statikus terhelhetőség

LC: húzóerő

8147P

gerenda fogó kézi emelőkhöz

tartógerendákhoz (INP, IPB, IPE, HEA, HEB, stb.) alkalmas

Új termék 2023

CE

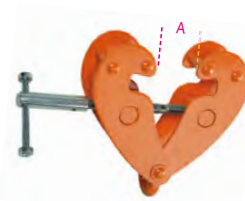

EN13157

Műszaki adatok:

- Biztonsági együttható: 4
- Azonosító címke

Tanúsítványok:

- Gyártói tanúsítvány
- CE Megfelelőségi nyilatkozat
- Vizsgálati jelentés 2.2 UNI EN10204
- Műszaki termékspecifikáció

Egységár

Méret

Egységcsomag

WLL t	A min mm	A max mm	Ft	
1,0	90	180	41.800	1 081470210
2,0	90	190	50.500	1 081470220
3,0	85	280	85.300	1 081470230
5,0	85	280	124.500	1 081470250

Cikkszám

8105

Mindkét oldalon szemes feszítőszerelvény, horganyzott

CE



UNI11841:2022

MŰSZAKI ADATOK

- Min. biztonsági együttható: 5
 - Feszítőszerelvényanya hőkezelése: normál hőkezelés
 - Feszítőszerelvény szemek hőkezelése: díjazás ellenében
- LABORELEMZÉSEK**
- Kémiai elemzés
 - Szakítópróba
- RENDELKEZÉSRE ÁLLÓ TANÚSÍTVÁNYOK**
- Termékleírás
 - Vizsgálati jelentés 2.2 UNI EN10204

ØxE	≈	WFL	Ft		
"	mm	kg			
3/8x6	M10x150	540	5.010	5	081050010
1/2x6	M12x150	1000	9.850	5	081050011
1/2x9	M12x230	1000	10.900	5	081050012
5/8x6	M16x150	1590	13.100	2	081050014
5/8x12	M16x300	1590	22.500	2	081050015
5/8x9	M16x230	1590	16.350	2	081050016
3/4x6	M20x150	2360	24.350	2	081050017
3/4x12	M20x300	2360	33.800	2	081050018
3/4x9	M20x230	2360	24.400	2	081050020
3/4x18	M20x460	2360	42.000	2	081050021
7/8x12	M22x300	3270	41.550	1	081050022
1x6	M24x150	4540	43.700	1	081050024
1x12	M24x300	4540	63.150	1	081050025
1x18	M24x460	4540	86.800	1	081050026
1.1/4x12	M33x300	6900	107.600	1	081050031
1.1/4x18	M33x460	6900	130.500	1	081050032
1.1/2x12	M39x300	9710	151.200	1	081050034
1.1/2x18	M39x460	9710	187.100	1	081050035
1.3/4x18	M45x460	12700	271.700	1	081050036

Különleges csomagolások szabad szolgáltatáshoz



ØxE	Ft		
"			
3/8x6	5.580	1	081059010
1/2x9	11.850	1	081059012

Robur

8109

Mindkét oldalon kengyeles feszítőszerelvény, horganyzott

CE

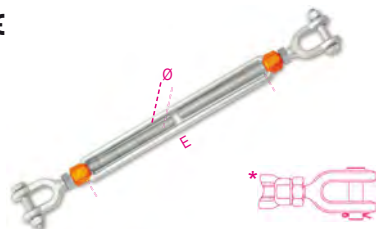

UNI 11841:2022

MŰSZAKI ADATOK

- Min. biztonsági együttható: 5
 - Feszítőszerelvényanya hőkezelése: normál hőkezelés
 - Feszítőszerelvény kengyelek hőkezelése: díjazás ellenében
- LABORELEMZÉSEK**
- Kémiai elemzés
 - Szakítópróba
- RENDELKEZÉSRE ÁLLÓ TANÚSÍTVÁNYOK**
- Termékleírás
 - Vizsgálati jelentés 2.2 UNI EN10204

ØxE	≈	WFL	Ft		
"	mm	kg			
3/8x6	M10x150	540	6.800	5	081090010
1/2x6	M12x150	1000	13.000	5	081090011
1/2x9	M12x230	1000	13.450	5	081090012
1/2x12	M12x300	1000	19.700	5	081090013
5/8x6	M16x150	1590	23.750	2	081090015
5/8x9	M16x230	1590	24.900	2	081090016
5/8x12	M16x300	1590	31.300	2	081090017
3/4x6	M20x150	2360	31.250	2	081090018
3/4x9	M20x230	2360	33.600	2	081090020
3/4x12	M20x300	2360	42.700	2	081090019
3/4x18	M20x460	2360	50.950	2	081090021
7/8x12	M22x300	3270	55.800	1	081090022
7/8x18	M22x460	3270	77.550	1	081090023
1x6	M24x150	4540	55.150	1	081090024
1x12	M24x300	4540	78.200	1	081090025
1x18	M24x460	4540	105.200	1	081090026
* 1.1/4x12	M33x300	6900	125.700	1	081090031
* 1.1/4x18	M33x460	6900	164.500	1	081090032
* 1.1/4x24	M33x610	6900	201.900	1	081090033
* 1.1/2x12	M39x300	9710	208.600	1	081090034
* 1.1/2x18	M39x460	9710	245.800	1	081090038
* 1.1/2x24	M39x610	9710	294.400	1	081090039
* 1.3/4x18	M45x460	12700	351.200	1	081090036

Különleges csomagolások szabad szolgáltatáshoz



ØxE	Ft		
"			
3/8x6	7.380	1	081099010
1/2x9	14.350	1	081099012

8110

kengyeles-szemes feszítőszerelvény, nagy szakítószilárdságú horganyzott acél

CE



UNI 11841:2022

MŰSZAKI ADATOK

- biztonsági együttható: 5
 - feszítőszerelvényanya hőkezelése: normál hőkezelés
 - feszítőszerelvény szemek hőkezelése: edzés és lágyítás
- azonosító kód
- LABORATÓRIUMI TESZTEK**
- vegyelemzés
 - szakítópróba
- TANÚSÍTVÁNYOK**
- Műszaki termékspecifikáció
 - Vizsgálati jelentés 2.2 UNI EN10204
 - Ellenőrző tanúsítvány 3.1 UNI EN10204
 - CE megfelelési nyilatkozat

ØxE	≈	WFL	Ft		
"	mm	kg			
1/2x6	M12x150	1000	11.200	5	081100006
1/2x9	M12x230	1000	14.000	5	081100010
5/8x6	M16x150	1590	16.850	2	081100014
5/8x9	M16x230	1590	19.750	2	081100015
5/8x12	M16x300	1590	26.850	2	081100016
3/4x6	M20x150	2360	29.150	2	081100019
3/4x9	M20x230	2360	33.500	2	081100020
3/4x12	M20x300	2360	38.150	2	081100021
7/8x12	M22x300	3270	55.500	1	081100022
1x6	M24x150	4540	57.200	1	081100027
1x12	M24x300	4540	81.950	1	081100029
* 1.1/4x12	M33x300	6900	136.700	1	081100034
* 1.1/4x18	M33x460	6900	164.200	1	081100035
* 1.1/2x12	M39x300	9710	191.800	1	081100038
* 1.1/2x18	M39x460	9710	217.300	1	081100039
* 1.3/4x18	M45x460	12700	331.200	1	081100044

* Pofák átmenő és hasított csappal

8005Z

Mindkét oldalon szemes feszítőszerelvény, galvanizált

CE

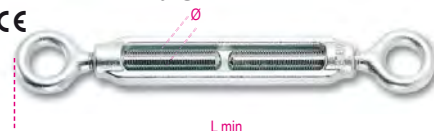

MŰSZAKI ADATOK

- Min. biztonsági együttható: 4
- LABORELEMZÉSEK**
- Kémiai elemzés
 - Szakítópróba
- RENDELKEZÉSRE ÁLLÓ TANÚSÍTVÁNYOK**
- Termékleírás
 - Vizsgálati jelentés 2.2 UNI EN10204
- * CE-Megfelelési nyilatkozat

Ø	≈	L min	WFL	Ft		
mm	"	mm	kg			
M5	3/16	118	115	1.000	400	080050105
M6	1/4	130	160	1.250	300	080050106
M8	5/16	158	300	1.800	200	080050108
M10	3/8	192	470	2.400	100	080050110
M11	7/16	206	580	3.130	80	080050111
M12	1/2	226	690	3.440	60	080050112
M14	9/16	256	940	5.010	15	080050114
M16	5/8	290	1290	7.050	10	080050116
M18	11/16	358	1660	9.930	1	080050118
M20	3/4	358	2130	11.200	1	080050120
M22	7/8	400	2630	14.600	1	080050122
M24	1"	436	3060	18.600	1	080050124
M27	1 1/8	474	4000	26.850	1	080050125
M30	1 3/16	498	4860	31.700	1	080050130
M33	1 1/4	516	6040	37.150	1	080050126
M36	1 3/8	532	6500	46.650	1	080050136
M39	1 1/2	544	7900	55.850	1	080050139

Speciális csomagolás

Ø mm	"	WFL mm	Ft kg	WFL mm	WFL kg	Ft kg	WFL mm	WFL kg
M5	3/16	30	30.000	1	080050705			
M6	1/4	30	33.000	1	080050706			
M8	5/16	20	32.800	1	080050708			
M10	3/8	15	34.800	1	080050710			
M11	7/16	15	45.000	1	080050711			
M12	1/2	15	53.400	1	080050712			

Különleges csomagolások szabad
szolgáltatáshoz



Ø mm	"	Ft kg	WFL mm	WFL kg
M5	2	2.500	1	080059305
M6	2	2.720	1	080059306
M8	1	2.290	1	080059108
M10	1	2.900	1	080059110
M11	1	3.830	1	080059111
M12	1	4.090	1	080059112
M14	1	5.280	1	080059114
M16	1	7.760	1	080059116

8005T2

Mindkét oldalon szemes feszítőszerelvény,
horganyzott



MŰSZAKI ADATOK

- Min. biztonsági koeficiens: 4
- LABORELEMZÉSEK
- Kémiai elemzés
- Szakítópórába
- RENDELKEZÉSRE ÁLLÓ TANÚSÍTVÁNYOK
- Termékleírás
- Vizsgálati jelentés 2.2 UNI EN10204
- CE-Megfelelőségi nyilatkozat

Ø mm	"	WFL mm	Ft kg	WFL mm	WFL kg
M12	1/2	690	4.590	15	080050512
M16	5/8	1290	7.020	1	080050516
M20	3/4	2130	11.350	1	080050520
M24	1"	3060	19.750	1	080050524
M27	1 1/8	4000	25.250	1	080050527
M30	1.3/16	4860	31.350	1	080050530
M36	1.3/8	6500	51.350	1	080050536

Különleges csomagolások szabad
szolgáltatáshoz



Ø mm	"	Ft kg	WFL mm	WFL kg
M12	1	5.570	1	080059512

8006Z

Feszítőszerelvény horoggal
és szemmel, galvanizált

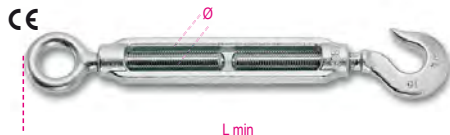

MŰSZAKI ADATOK

- Min. biztonsági koeficiens: 4
- LABORELEMZÉSEK
- Kémiai elemzés
- Szakítópórába
- RENDELKEZÉSRE ÁLLÓ TANÚSÍTVÁNYOK
- Termékleírás
- Vizsgálati jelentés 2.2 UNI EN10204
- CE-Megfelelőségi nyilatkozat

Ø mm	"	L min mm	WFL mm	Ft kg	WFL mm	WFL kg
M5	3/16	121	25	1.050	400	080060105
M6	1/4	132	45	1.180	250	080060106
M8	5/16	170	95	1.860	180	080060108
M10	3/8	204	140	2.410	100	080060110
M11	7/16	221	165	3.150	15	080060111
M12	1/2	244	300	3.590	15	080060112
M14	9/16	284	420	5.080	10	080060114
M16	5/8	322	570	7.350	1	080060116
M18	11/16	373	700	10.550	1	080060118
M20	3/4	391	900	12.800	1	080060120
M22	7/8	433	1100	16.600	1	080060122
M24	1"	470	1300	22.050	1	080060124
M27	1 1/8	503	2300	30.350	1	080060127

Speciális csomagolás

Ø mm	"	Ft kg	WFL mm	WFL kg	
M5	3/16	30	32.850	1	080060705
M6	1/4	30	36.150	1	080060706
M8	5/16	20	34.000	1	080060708
M10	3/8	15	38.800	1	080060710

Különleges csomagolások szabad
szolgáltatáshoz



Ø mm	"	Ft kg	WFL mm	WFL kg
M5	2	2.720	1	080069305
M6	2	3.160	1	080069306
M8	1	2.230	1	080069108
M10	1	2.890	1	080069110
M11	1	3.690	1	080069111
M12	1	4.010	1	080069112
M14	1	5.470	1	080069114

8007Z

Mindkét oldalon horgos
feszítőszerelvény, galvanizált

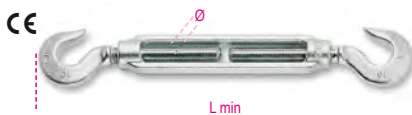

MŰSZAKI ADATOK

- Min. biztonsági koeficiens: 4
- LABORELEMZÉSEK
- Kémiai elemzés
- Szakítópórába
- RENDELKEZÉSRE ÁLLÓ TANÚSÍTVÁNYOK
- Termékleírás
- Vizsgálati jelentés 2.2 UNI EN10204
- CE-Megfelelőségi nyilatkozat

Ø mm	"	L min mm	WFL mm	Ft kg	WFL mm	WFL kg
M5	3/16	124	25	1.230	30	080070105
M6	1/4	134	45	1.270	30	080070106
M8	5/16	181	95	1.800	20	080070108
M10	3/8	211	140	2.570	15	080070110
M11	7/16	231	165	3.280	15	080070111
M12	1/2	262	300	3.830	15	080070112

Ø mm	"	L min mm	WFL mm	Ft kg	WFL mm	WFL kg
M14	9/16	312	420	5.470	1	080070114
M16	5/8	354	570	7.980	1	080070116
M18	11/16	388	700	11.350	1	080070118
M20	3/4	424	900	14.400	1	080070120
M22	7/8	466	1100	18.550	1	080070122
M24	1"	504	1300	26.100	1	080070124
M27	1 1/8	532	2300	33.750	1	080070127

Különleges csomagolások szabad
szolgáltatáshoz



Ø mm	"	Ft kg	WFL mm	WFL kg
M5	2	2.920	1	080079305
M6	2	3.200	1	080079306
M8	1	2.080	1	080079108
M10	1	2.850	1	080079110
M11	1	3.700	1	080079111
M12	1	4.250	1	080079112

8008N

Mindkét oldalon toldatos
feszítőszerelvény, természetes színű



MŰSZAKI ADATOK

- Min. biztonsági koeficiens: 4
- LABORELEMZÉSEK
- Kémiai elemzés
- Szakítópórába
- RENDELKEZÉSRE ÁLLÓ TANÚSÍTVÁNYOK
- Termékleírás
- Vizsgálati jelentés 2.2 UNI EN10204
- CE-Megfelelőségi nyilatkozat

Ø mm	"	L min mm	WFL mm	Ft kg	WFL mm	WFL kg
M5	3/16	160	115	1.050	30	080080205
M6	1/4	180	160	1.030	30	080080206
M8	5/16	210	300	1.470	20	080080208
M10	3/8	250	470	1.970	15	080080210
M12	1/2	280	690	2.530	15	080080212
M14	9/16	340	940	3.530	5	080080214
M16	5/8	380	1290	4.880	5	080080216
M18	11/16	410	1660	7.210	3	080080218
M20	3/4	440	2130	8.430	3	080080220
M22	7/8	480	2630	11.550	2	080080222
M24	1"	520	3060	13.250	2	080080224
M27	1 1/8	560	4000	21.050	1	080080227
M30	1 3/16	560	4860	26.250	1	080080230
M33	1 1/4	600	6040	27.650	1	080080233
M36	1 3/8	600	6500	34.450	1	080080236
M39	1 1/2	600	7900	40.200	1	080080239

Különleges csomagolások szabad
szolgáltatáshoz



Ø mm	"	Ft kg	WFL mm	WFL kg
M5	2	2.890	1	080089305
M6	2	2.920	1	080089306
M8	1	2.210	1	080089208
M10	1	2.430	1	080089210
M12	1	2.960	1	080089212
M14	1	4.220	1	080089214

Robur

8008TZN

kétcsonkos huzalfeszítő
csőanya DIN 1478
fekete végződés, horganyzott test



MŰSZAKI ADATOK

• biztonsági együttható: 4
LABORELEMZÉSEK* vegyi elemzés*
szakítópróbaRENDELKEZÉSRE ÁLLÓ TANÚSÍTVÁNYOK*
Termékleírás* Vizsgálati jelentés a 2.2 UNI EN10204 szerint*
EK Megfeleléségi nyilatkozat

Ø mm	n	WFL kg	Ft	📦	🚚
M12	1/2	690	2.990	10	080080512
M16	5/8	1290	5.440	1	080080516
M20	3/4	2130	8.070	1	080080520
M24	1	3060	12.900	1	080080524
M27	1.1/8	4000	23.100	1	080080527
M30	1.3/16	4860	23.350	1	080080530
M36	1.3/8	6500	41.450	1	080080536

8009Z

Mindkét oldalon kengyeles,
feszítőszerelvény, galvanizált

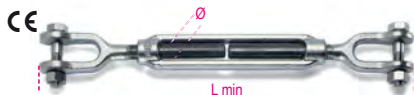

MŰSZAKI ADATOK

• Min. biztonsági koefficiens: 4
LABORELEMZÉSEK
• Kémiai elemzés
• Szakítópróba
RENDELKEZÉSRE ÁLLÓ TANÚSÍTVÁNYOK
• Termékleírás
• Vizsgálati jelentés 2.2 UNI EN10204
• CE-Megfeleléségi nyilatkozat

Ø mm	n	L min mm	WFL kg	Ft	📦	🚚
M8	5/16	192	300	6.100	15	080090008
M10	3/8	234	470	6.920	15	080090010
M12	1/2	274	690	9.010	15	080090012
M14	9/16	342	940	11.700	1	080090014
M16	5/8	372	1290	13.050	1	080090016
M18	11/16	406	1660	18.750	1	080090018
M20	3/4	406	2130	19.750	1	080090020
M22	7/8	466	2630	26.850	1	080090022
M24	1"	486	3060	30.750	1	080090024
M27	1 1/8	510	4000	51.900	1	080090027
M30	1 3/16	566	4860	63.400	1	080090030

Különleges csomagolások szabad
szolgáltatáshoz

Ø mm	📦	Ft	🚚
M8	1	6.200	1
M10	1	6.430	1
M12	1	8.700	1

8009TZ

kétvillás, csőnyás
feszítőszerelvény DIN 1478
horganyzott



MŰSZAKI ADATOK

• biztonsági együttható: 4LABORELEMZÉSEK* vegyi elemzés*
szakítópróbaRENDELKEZÉSRE ÁLLÓ TANÚSÍTVÁNYOK*
Termékleírás* Vizsgálati jelentés a 2.2 UNI EN10204 szerint*
EK Megfeleléségi nyilatkozat

Ø mm	n	WFL kg	Ft	📦	🚚
M12	1/2	690	7.120	10	080090512
M16	5/8	1290	12.350	1	080090516
M20	3/4	2130	17.600	1	080090520
M24	1	3060	27.800	1	080090524
M27	1.1/8	4000	37.000	1	080090527
M30	1.3/16	4860	49.900	1	080090530

Különleges csomagolások szabad
szolgáltatáshoz

Ø mm	📦	Ft	🚚
M12	1	7.780	1

8010Z

Feszítőszerelvény szemmel
és kengyellel, galvanizált



MŰSZAKI ADATOK

• Min. biztonsági koefficiens: 4
LABORELEMZÉSEK
• Kémiai elemzés
• Szakítópróba
RENDELKEZÉSRE ÁLLÓ TANÚSÍTVÁNYOK
• Termékleírás
• Vizsgálati jelentés 2.2 UNI EN10204
• CE-Megfeleléségi nyilatkozat

Ø mm	n	L min mm	WFL kg	Ft	📦	🚚
M8	5/16	175	300	3.910	20	080100008
M10	3/8	215	470	4.360	15	080100010
M12	1/2	250	690	6.010	10	080100012
M14	9/16	299	940	7.830	10	080100014
M16	5/8	331	1290	10.300	1	080100016
M18	11/16	382	1660	15.000	1	080100018
M20	3/4	382	2130	16.400	1	080100020
M22	7/8	433	2630	22.250	1	080100022
M24	1"	461	3060	26.400	1	080100024
M27	1 1/8	492	4000	39.800	1	080100027
M30	1 3/16	529	4860	50.550	1	080100030

Különleges csomagolások szabad
szolgáltatáshoz

Ø mm	📦	Ft	🚚
M8	1	4.670	1
M10	1	5.220	1
M12	1	6.350	1
M14	1	8.440	1

8010TZ

szemes és villás huzalfeszítő
csőanya DIN 1478
horganyzott



MŰSZAKI ADATOK

• biztonsági együttható: 4
LABORELEMZÉSEK* vegyi elemzés*
szakítópróbaRENDELKEZÉSRE ÁLLÓ TANÚSÍTVÁNYOK*
Termékleírás* Vizsgálati jelentés a 2.2 UNI EN10204 szerint*
EK Megfeleléségi nyilatkozat

Ø mm	n	WFL kg	Ft	📦	🚚
M12	1/2	690	6.320	10	080100612
M16	5/8	1290	11.150	1	080100616
M20	3/4	2130	16.450	1	080100620
M24	1	3060	27.200	1	080100624
M27	1.1/8	4000	37.650	1	080100627
M30	1.3/16	4860	46.400	1	080100630

8001Z

Feszítőanya, galvanizált



MŰSZAKI ADATOK

• Min. biztonsági koefficiens: 4
• Gyártási száma
LABORELEMZÉSEK
• Kémiai elemzés
• Szakítópróba
RENDELKEZÉSRE ÁLLÓ TANÚSÍTVÁNYOK
• Termékleírás
• Vizsgálati jelentés 2.2 UNI EN10204
• CE-Megfeleléségi nyilatkozat

Ø mm	n	L mm	WFL kg	Ft	📦	🚚
M5	3/16	80	115	590	100	080010105
M6	1/4	80	160	620	100	080010106
M8	5/16	105	300	895	25	080010108
M10	3/8	125	470	1.210	20	080010110
M11	7/16	135	580	1.400	15	080010111
M12	1/2	140	690	1.570	20	080010112
M14	9/16	170	940	2.160	15	080010114
M16	5/8	190	1290	2.780	15	080010116
M18	11/16	205	1660	4.370	10	080010118
M20	3/4	220	2130	5.190	10	080010120
M22	7/8	240	2630	6.480	8	080010122
M24	1"	260	3060	7.810	5	080010124
M27	1 1/8	270	4000	12.200	1	080010127
M30	1 3/16	280	4860	15.050	1	080010130
M33	1 1/4	290	6040	16.450	1	080010133
M36	1 3/8	300	6500	21.350	1	080010136
M39	1 1/2	300	7900	25.750	1	080010139

Különleges csomagolások szabad
szolgáltatáshoz

Ø mm	📦	Ft	🚚
M5	2	1.890	1
M6	2	2.040	1
M8	1	1.540	1
M10	1	1.790	1
M11	1	2.120	1
M12	1	2.180	1
M14	1	2.720	1
M16	1	3.370	1
M18	1	5.090	1
M20	1	5.550	1
M22	1	6.740	1
M24	1	8.280	1

Robur

8001TZ

Feszítőanya,
horganyzott



DIN 1478

MŰSZAKI ADATOK

- Min. biztonsági koeficiens: 4
- Gyártási száma

LABORELEMZÉSEK

- Kémiai elemzés
- Szakítópórá

RENDELKEZÉSRE ÁLLÓ TANÚSÍTVÁNYOK

- Termékleírás
- Vizsgálati jelentés 2.2 UNI EN10204
- CE-Megfelelőségi nyilatkozat

Ø mm	≈ "	L mm	WFL kg	Ft		
M12	1/2	125	690	2.390	10	080010512
M16	5/8	170	1290	3.620	5	080010516
M20	3/4	200	2130	4.920	5	080010520
M24	1	255	3060	8.720	3	080010524
M27	1 1/8	255	4000	11.700	1	080010527
M30	1 3/16	255	4860	14.400	1	080010530
M36	1 3/8	295	6500	23.150	1	080010536
M42	1 5/8	330	9700	31.550	1	080010542

Különleges csomagolások szabad
szolgáltatáshoz



Ø mm		Ft		
M12	1	2.890	1	080019512
M16	1	4.130	1	080019516
M20	1	5.420	1	080019520
M24	1	9.090	1	080019524

8002ZD

Feszítőcsavar szem, jobbmenetes,
galvanizált

Feszítőcsavar szem, balmenetes



MŰSZAKI ADATOK

- Min. biztonsági koeficiens: 4
- Gyártási száma

LABORELEMZÉSEK

- Kémiai elemzés
- Szakítópórá

RENDELKEZÉSRE ÁLLÓ TANÚSÍTVÁNYOK

- Termékleírás
- Vizsgálati jelentés 2.2 UNI EN10204

Ø mm	≈ "	E mm	WFL kg	Ft		
M5	3/16	37	115	195	200	080020105
M6	1/4	40	160	235	150	080020106
M8	5/16	52	300	380	100	080020108
M10	3/8	60	470	555	100	080020110
M11	7/16	65	580	800	1	080020111
M12	1/2	72	690	995	50	080020112
M14	9/16	85	940	1.250	1	080020114
M16	5/8	95	1290	2.020	1	080020116
M18	11/16	103	1660	2.610	1	080020118
M20	3/4	110	2130	2.970	1	080020120
M22	7/8	120	2630	4.460	1	080020122
M24	1"	130	3060	5.570	1	080020124
M27	1 1/8	135	4000	7.770	1	080020127
M30	1 3/16	140	4860	8.990	1	080020130
M33	1 1/4	148	6040	11.000	1	080020133
M36	1 3/8	150	6500	13.500	1	080020136
M39	1 1/2	150	7900	15.750	1	080020139

Ø mm	≈ "	WFL kg	E mm	Ft		
M5	3/16	40	25	290	150	080030105
M6	1/4	40	45	340	120	080030106
M8	5/16	52	95	440	100	080030108
M10	3/8	60	140	820	70	080030110
M11	7/16	65	165	1.030	1	080030111
M12	1/2	70	300	1.200	30	080030112
M14	9/16	85	420	1.750	1	080030114
M16	5/8	95	570	2.660	1	080030116
M18	11/16	103	700	3.600	1	080030118
M20	3/4	110	900	4.880	1	080030120
M22	7/8	120	1100	6.240	1	080030122
M24	1"	130	1300	9.850	1	080030124
M27	1 1/8	135	2300	11.500	1	080030127
M5	3/16	40	25	280	1	080030305
M6	1/4	40	45	340	1	080030306
M8	5/16	52	95	440	1	080030308
M10	3/8	60	140	820	1	080030310
M11	7/16	65	165	1.030	1	080030311
M12	1/2	70	300	1.200	1	080030312
M14	9/16	85	420	1.750	1	080030314
M16	5/8	95	570	2.660	1	080030316
M18	11/16	103	700	3.600	1	080030318
M20	3/4	110	900	4.880	1	080030320
M22	7/8	120	1100	6.240	1	080030322
M24	1"	130	1300	9.850	1	080030324
M27	1 1/8	135	2300	11.500	1	080030327

8004ND

Jobbmenetes feszítő szár,
fekete

Kérésre balmenettel



MŰSZAKI ADATOK

- Min. biztonsági koeficiens: 4
- Gyártási száma

LABORELEMZÉSEK

- Kémiai elemzés
- Szakítópórá

RENDELKEZÉSRE ÁLLÓ TANÚSÍTVÁNYOK

- Termékleírás
- Vizsgálati jelentés 2.2 UNI EN10204

Ø mm	≈ "	E mm	WFL kg	Ft		
M5	3/16	40	115	225	1	080040005
M6	1/4	44	160	280	1	080040006
M8	5/16	53	300	300	1	080040008
M10	3/8	63	470	420	1	080040010
M12	1/2	70	690	710	1	080040012
M14	9/16	85	940	840	1	080040014
M16	5/8	95	1290	1.140	1	080040016
M18	11/16	103	1660	1.540	1	080040018
M20	3/4	110	2130	1.950	1	080040020
M22	7/8	120	2630	2.400	1	080040022
M24	1"	130	3060	3.360	1	080040024
M27	1 1/8	135	4000	5.420	1	080040027
M30	1 3/16	140	4860	6.750	1	080040030
M33	1 1/4	150	6040	6.930	1	080040033
M36	1 3/8	150	6500	9.020	1	080040036
M39	1 1/2	150	7900	9.940	1	080040039

Ø mm	≈ "	E mm	WFL kg	Ft		
M5	3/16	40	115	225	1	080040105
M6	1/4	44	160	280	1	080040106
M8	5/16	53	300	300	1	080040108
M10	3/8	63	470	420	1	080040110
M12	1/2	70	690	710	1	080040112
M14	9/16	85	940	840	1	080040114
M16	5/8	95	1290	1.140	1	080040116
M18	11/16	103	1660	1.540	1	080040118
M20	3/4	110	2130	1.950	1	080040120
M22	7/8	120	2630	2.400	1	080040122
M24	1"	130	3060	3.360	1	080040124
M27	1 1/8	135	4000	5.420	1	080040127
M30	1 3/16	140	4860	6.750	1	080040130
M33	1 1/4	150	6040	6.930	1	080040133
M36	1 3/8	150	6500	9.020	1	080040136
M39	1 1/2	150	7900	9.940	1	080040139



8009FD

Jobbmenetes feszítő szerelvény kengyeles

- horganyzott

Kérésre balmenettel



MŰSZAKI ADATOK

Min. biztonsági együttható: 4

LABORELEMZÉSEK

• Kémiai elemzés

• Szakítópróba

RENDELKEZÉSRE ÁLLÓ TANÚSÍTVÁNYOK

• Termékleírás

• Vizsgálati jelentés 2.2 UNI EN10204

Ø mm	≈ "	E mm	WFL kg	Ft		
M8	5/16	53	300	2.480	1	080090208
M10	3/8	63	470	2.760	1	080090210
M12	1/2	70	690	3.500	1	080090212
M14	9/16	85	940	4.240	1	080090214
M16	5/8	95	1290	4.820	1	080090216
M18	11/16	103	1660	6.720	1	080090218
M20	3/4	110	2130	6.980	1	080090220
M22	7/8	120	2630	9.710	1	080090222
M24	1"	130	3060	11.700	1	080090224
M27	1 1/8	135	4000	20.950	1	080090227
M30	1 3/16	140	4860	25.650	1	080090230

Ø mm	≈ "	WFL kg	G mm	Ft		
M8	5/16	53	300	2.480	1	080090408
M10	3/8	63	470	2.760	1	080090410
M12	1/2	70	690	3.500	1	080090412
M14	9/16	85	940	4.240	1	080090414
M16	5/8	95	1290	4.820	1	080090416
M18	11/16	103	1660	6.720	1	080090418
M20	3/4	110	2130	6.980	1	080090420
M22	7/8	120	2630	9.710	1	080090422
M24	1"	130	3060	11.700	1	080090424
M27	1 1/8	135	4000	20.950	1	080090427
M30	1 3/16	140	4860	25.650	1	080090430

8048

Szemes húzórudak, jobbmenetes,
természetes színű



UNI 6058

ØxL mm	WFL kg	F mm	Ft		
M8x50	430	6	1.460	20	080480108
M8x65	430	6	1.590	20	080480109
M10x80	690	8	2.110	10	080480110
M10x100	690	8	2.040	10	080480210
M10x130	690	8	2.620	10	080480111
M12x70	1020	10	2.120	8	080480212
M12x95	1020	10	2.170	8	080480112
M12x125	1020	10	3.210	8	080480113
M14x110	1420	12	3.100	6	080480114
M16x100	1980	14	2.570	6	080480115
M16x130	1980	14	2.660	6	080480116
M18x150	2390	16	6.250	2	080480118
M20x160	3100	18	7.690	2	080480120
M22x180	3890	18	12.600	1	080480122
M24x200	4460	20	14.750	1	080480124
M24x220	4460	20	14.800	1	080480125
M27x220	5900	22	19.150	1	080480127

8302Z

Rögítő szemescsavar,
jobbmenetes, galvanizált



MŰSZAKI ADATOK

• Min. biztonsági együttható: 4

RENDELKEZÉSRE ÁLLÓ TANÚSÍTVÁNYOK

• Termékleírás

• Vizsgálati jelentés 2.2 UNI EN10204

Ø mm	E mm	F mm	WFL kg	Ft		
M5	48	8	115	220	200	083020005
M6	55	10	160	255	150	083020006
M8	60	12	300	355	100	083020008
M10	73	14	470	590	100	083020010
M12	90	17	690	1.190	50	083020012

8303Z

Rögítő horog, jobbmenetes,
galvanizált



MŰSZAKI ADATOK

• Min. biztonsági együttható: 4

RENDELKEZÉSRE ÁLLÓ TANÚSÍTVÁNYOK

• Termékleírás

• Vizsgálati jelentés 2.2 UNI EN10204

Ø mm	C mm	E mm	WFL kg	Ft		
M5	6,0	48	25	265	120	083030005
M6	8,0	55	45	260	100	083030006
M8	10,0	60	95	405	75	083030008
M10	12,5	73	140	775	50	083030010
M12	16,0	90	220	1.190	20	083030012



8702N - 8702Z - 8702ZC

kengyel foglalat kovácsolt acélból

zárt

fekete



MŰSZAKI ADATOK

• azonosító kód

LABORATÓRIUMI TESZTEK

• vegyelemzés

• szakítópróba

TANÚSÍTVÁNYOK

• Műszaki termékspecifikáció

• Vizsgálati jelentés 2.2 UNI EN10204

• Ellenőrző tanúsítvány 3.1 UNI EN10204

M	ØB mm	ØA mm	ØD mm	Ft		
6	6,8	13	19	18.500	1	087020106
8	8,8	20	22	22.100	1	087020108
9	9,8	20	22	22.100	1	087020109
10	10,8	20	22	22.100	1	087020110
11	11,8	25	27	27.350	1	087020111
12	12,8	25	27	27.350	1	087020112
13	13,8	25	27	27.350	1	087020113
14	14,8	32	32	38.100	1	087020114
15	15,9	32	32	38.100	1	087020115
16	17,0	32	32	38.100	1	087020116
18	19,0	39	37	49.350	1	087020118
19	20,0	39	37	49.350	1	087020119
20	21,1	39	37	49.350	1	087020120
22	23,2	43	43	68.800	1	087020122
24	25,4	50	52	79.100	1	087020124
25	26,4	50	52	79.100	1	087020125
26	27,4	50	52	79.100	1	087020126

A kengyel kovácsolását megfelelő présgépen és szerszámmal szakember végezheti.

8702Z horganyzott

M	ØB mm	ØA mm	ØD mm	Ft		
6	6,8	13	19	19.200	1	087020306
8	8,8	20	22	23.300	1	087020308
9	9,8	20	22	23.300	1	087020309
10	10,8	20	22	23.300	1	087020310
11	11,8	25	27	28.550	1	087020311
12	12,8	25	27	28.550	1	087020312
13	13,8	25	27	28.550	1	087020313
14	14,8	32	32	39.950	1	087020314
15	15,9	32	32	39.950	1	087020315
16	17,0	32	32	39.950	1	087020316
18	19,0	39	37	51.600	1	087020318
19	20,0	39	37	51.600	1	087020319
20	21,1	39	37	51.600	1	087020320
22	23,2	43	43	64.450	1	087020322
24	25,4	50	52	82.500	1	087020324
25	26,4	50	52	82.500	1	087020325
26	27,4	50	52	82.500	1	087020326

8702ZC tűzhorganyzott

M	ØB mm	ØA mm	ØD mm	Ft		
6	6,8	13	19	20.350	1	087020206
8	8,8	20	22	25.200	1	087020208
9	9,8	20	22	25.200	1	087020209
10	10,8	20	22	25.200	1	087020210
11	11,8	25	27	31.250	1	087020211
12	12,8	25	27	31.250	1	087020212
13	13,8	25	27	31.250	1	087020213
14	14,8	32	32	46.200	1	087020214
15	15,9	32	32	46.200	1	087020215
16	17,0	32	32	46.200	1	087020216
18	19,0	39	37	59.600	1	087020218
19	20,0	39	37	59.600	1	087020219
20	21,1	39	37	59.600	1	087020220
22	23,2	43	43	80.900	1	087020222
24	25,4	50	52	94.500	1	087020224
25	26,4	50	52	94.500	1	087020225
26	27,4	50	52	94.500	1	087020226

8709N - 8709Z - 8709ZC

kengyel foglalat kovácsolt acélból

nyitott

fekete



MŰSZAKI ADATOK

- azonosítókód
- LABORATÓRIUMI TESZTEK
- vegyelemzés
- szakítópróba
- TANÚSÍTVÁNYOK
- Műszaki termékspecifikáció
- Vizsgálati jelentés 2.2 UNI EN10204
- Ellenőrző tanúsítvány 3.1 UNI EN10204

M	Ø B mm	Ø A mm	Ø C mm	Ft		
6	6,8	13	17	25.200	1	087090106
8	8,8	20	21	32.650	1	087090108
9	9,8	20	21	32.600	1	087090109
10	10,8	20	21	32.650	1	087090110
11	11,8	25	25	40.750	1	087090111
12	12,8	25	25	40.750	1	087090112
13	13,8	25	25	40.750	1	087090113
14	14,8	32	30	56.950	1	087090114
15	15,9	32	30	56.950	1	087090115
16	17,0	32	30	56.950	1	087090116
18	19,0	39	35	73.900	1	087090118
19	20,0	39	35	73.900	1	087090119
20	21,1	39	35	73.900	1	087090120
22	23,2	43	41	94.700	1	087090122
24	25,4	50	51	96.950	1	087090124
25	26,4	50	51	96.950	1	087090125
26	27,4	50	51	96.950	1	087090126

A kengyel kovácsolását megfelelő présgépen és szerszámmal szakember végezheti.

8709Z horganyzott

M	Ø B mm	Ø A mm	Ø C mm	Ft		
6	6,8	13	17	25.600	1	087090306
8	8,8	20	21	33.550	1	087090308
9	9,8	20	21	33.550	1	087090309
10	10,8	20	21	33.550	1	087090310
11	11,8	25	25	41.800	1	087090311
12	12,8	25	25	41.800	1	087090312
13	13,8	25	25	41.800	1	087090313
14	14,8	32	30	58.550	1	087090314
15	15,9	32	30	58.550	1	087090315
16	17,0	32	30	58.550	1	087090316
18	19,0	39	35	75.900	1	087090318
19	20,0	39	35	75.900	1	087090319
20	21,0	39	35	75.900	1	087090320
22	23,2	43	41	99.600	1	087090322
24	25,4	50	51	99.600	1	087090324
25	26,4	50	51	99.600	1	087090325
26	27,4	50	51	99.600	1	087090326

8709ZC tüzhorganyzott

M	Ø B mm	Ø A mm	Ø C mm	Ft		
6	6,8	13	17	26.500	1	087090206
8	8,8	20	21	35.300	1	087090208
9	9,8	20	21	35.300	1	087090209
10	10,8	20	21	35.300	1	087090210
11	11,8	25	25	45.600	1	087090211
12	12,8	25	25	45.600	1	087090212
13	13,8	25	25	45.600	1	087090213
14	14,8	32	30	66.200	1	087090214
15	15,9	32	30	66.200	1	087090215
16	17,0	32	30	66.200	1	087090216
18	19,0	39	35	84.300	1	087090218
19	20,0	39	35	84.300	1	087090219
20	21,1	39	35	84.300	1	087090220
22	23,2	43	41	107.600	1	087090222
24	25,4	50	51	118.300	1	087090224
25	26,4	50	51	118.300	1	087090225
26	27,4	50	51	118.300	1	087090226

8015

szorítókeygel, amerikai típus,
acél test,
tüzhorganyzott

CE

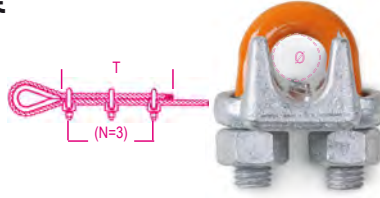

dimenzió EN 13411-5 tipo B

MŰSZAKI ADATOK

- azonosító kód
- LABORATÓRIUMI TESZTEK
- vegyelemzés
- torziós vizsgálat
- TANÚSÍTVÁNYOK
- Műszaki termékspecifikáció
- Vizsgálati jelentés 2.2 UNI EN10204
- Gyártói tanúsítvány UNI EN13411-5
- CE Megfelelőségi nyilatkozat

Ø mm	Ø "	NxT	Nm	Ft		
8	5/16	3x133	40,7	970	12	080150808
10	3/8	3x165	61	1.330	12	080150810
13	1/2	3x292	88	2.060	6	080150813
16	5/8	3x305	129	2.910	6	080150816
20	3/4	4x460	176	4.000	6	080150820
22	7/8	4x480	305	6.330	6	080150822
26	1	5x660	305	6.910	5	080150826
30	1-1/8	6x860	305	7.390	2	080150830

8016

Szorítókeygel acélból, galvanizált

CE

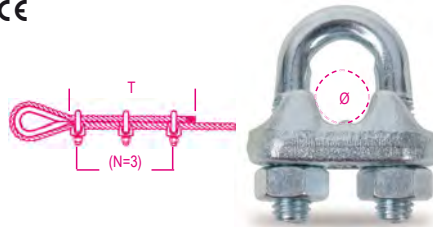

LABORELEMZÉSEK

- Kémiai elemzés
- Nyomaték teszt
- RENDELKEZÉSRE ÁLLÓ TANÚSÍTVÁNYOK
- Termékleírás
- Vizsgálati jelentés 2.2 UNI EN10204
- * CE-Megfelelőségi nyilatkozat

Ø mm	Ø "	NxT	Nm	Ft		
3	1/8	3x80	1,53	245	500	080160003
5	3/16	3x110	3,02	305	300	080160005
6	1/4	3x120	5,19	355	200	080160006
8	5/16	5x210	5,19	430	150	080160008
10	3/8	5x240	12,54	640	70	080160010
11	7/16	5x260	12,54	695	70	080160011
12-13	1/2	5x300	24,76	890	40	080160013
14	9/16	5x295	24,76	990	35	080160014
16	5/8	5x335	24,76	1.170	30	080160016
18	11/16	5x380	42,42	1.580	30	080160018
20	3/4	5x540	42,42	1.740	30	080160020
22	7/8	7x595	42,42	2.030	25	080160022
24-26	1"	7x700	67,56	2.720	15	080160026
28	1 1/16	8x840	67,56	3.400	5	080160028
30-32	1 1/8	8x990	67,56	3.410	5	080160030
34-36	1 1/4	8x1155	105,80	4.480	4	080160034
38-40	1 1/2	8x1320	105,80	5.970	2	080160040
45-50	2"	8x1500	206	8.980	1	080160050

Speciális csomagolás

Ø mm			Ft		
3	1/8	100	24.500	1	080160703
5	3/16	50	15.250	1	080160705
6	1/4	50	17.750	1	080160706
8	5/16	30	12.900	1	080160708
10	3/8	30	19.200	1	080160710
11	7/16	25	17.400	1	080160711
12-13	1/2	15	13.350	1	080160713

Különleges csomagolások szabad
szolgáltatáshoz



Ø mm		Ft		
3	6	1.790	1	080169403
5	4	1.750	1	080169405
6	4	1.930	1	080169406
8	4	2.260	1	080169408
10	2	1.780	1	080169410
11	1	1.290	1	080169011
12-13	1	1.420	1	080169013
14	1	1.540	1	080169014
16	1	1.730	1	080169016
18	1	2.180	1	080169018
20	1	2.180	1	080169020
22	1	2.570	1	080169022
24-26	1	3.280	1	080169026

8016FR

Szorítókeygel acélból, hidegen préselt test,
horganyzott

CE

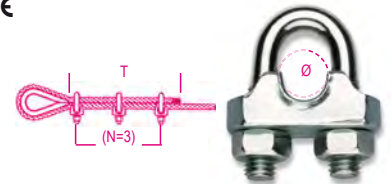

LABORELEMZÉSEK

- Kémiai elemzés
- RENDELKEZÉSRE ÁLLÓ TANÚSÍTVÁNYOK
- Termékleírás
- Vizsgálati jelentés 2.2 UNI EN10204
- CE-Megfelelőségi nyilatkozat

Ø mm	Ø "	NxT	Nm	Ft		
3	1/8	3x80	1,25	245	500	080160253
5	3/16	3x110	2,46	305	300	080160255
6	1/4	3x120	4,24	370	200	080160256
8	5/16	5x210	4,24	395	150	080160258

Különleges csomagolások szabad
szolgáltatáshoz



Ø mm		Ft		
3	6	2.260	1	080169753
5	6	1.950	1	080169755
6	4	2.130	1	080169756
8	4	2.050	1	080169758



8018E

Szorítókegely galvanizált



LABORELEMZÉSEK

- Kémiai elemzés
- RENDELKEZÉSRE ÁLLÓ TANÚSÍTVÁNYOK
- Termékleírás
- Vizsgálati jelentés 2.2 UNI EN10204

Ø	A	L	Nm	Ft		
mm	mm	mm				
4+6	M6	34	4,24	500	100	080180001

8016U2

Szorítókegely, horganyzott

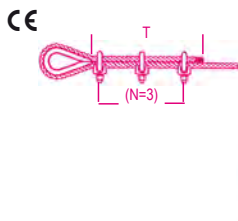

dimensioni EN 13411-5 tipo A

MŰSZAKI ADATOK

- Azonosítókód
- LABORELEMZÉSEK
- Kémiai elemzés
- Nyomaték teszt
- RENDELKEZÉSRE ÁLLÓ TANÚSÍTVÁNYOK
- Termékleírás
- Vizsgálati jelentés 2.2 UNI EN10204
- Gyártói tanúsítvány UNI EN 13411-5
- CE-Megfelelőségi nyilatkozat

Ø	Ø	N x T	Nm	Ft		
mm	"					
5	3/16	3x156	2,0	120	300	080160855
6,5	1/4	3x192	3,5	175	150	080160856
8	5/16	4x320	6	360	70	080160858
10	3/8	4x320	9	380	60	080160860
12	1/2	4x384	20	705	25	080160862
14	9/16	4x448	33	1.130	15	080160864
16	5/8	4x512	49	1.680	10	080160866
19	3/4	4x512	68	1.920	10	080160869
22	7/8	5x680	107	2.760	10	080160872
26	1	5x760	147	5.070	5	080160876
30	1.1/8	6x984	212	6.460	5	080160880
34	1.1/4	6x1080	296	8.910	5	080160884
40	1.1/2	6x1176	363	10.850	5	080160890

Különleges csomagolások szabad
szolgáltatáshoz

Ø	Ft		
mm			
5	4	1.620	1 080169805
6	4	2.280	1 080169806
8	4	3.540	1 080169808
10	2	2.470	1 080169810
12	1	2.210	1 080169612
14	1	2.590	1 080169614
16	1	3.370	1 080169616
19	1	3.600	1 080169619
22	1	4.550	1 080169622
26	1	7.610	1 080169626

8016UGK

szorítókegely,
öntöttvasból,
TÜZIHORGANYZOTT test,
GEOMET-GEOKOTE U-csapszeg és anyja



dimensioni EN 13411-5 tipo A

MŰSZAKI ADATOK

- azonosítókód
- LABORATÓRIUMI TESZTEK
- vegyelemzés
- torziós vizsgálat
- TANÚSÍTVÁNYOK
- Műszaki termékspecifikáció
- Vizsgálati jelentés 2.2 UNI EN10204
- Gyártói tanúsítvány UNI EN13411-5
- CE megfeleléségi nyilatkozat

Ø	Ø	N x T	Nm	Ft		
mm	"					
8	5/16	4x320	6	650	70	080160758
10	3/8	4x320	9	700	60	080160760
12	1/2	4x448	33	1.260	25	080160762
14	9/16	4x384	20	2.190	15	080160764
16	5/8	4x512	49	3.430	10	080160766
19	3/4	4x512	68	3.350	10	080160769
22	7/8	5x680	107	5.110	10	080160772
26	1	5x760	147	7.950	5	080160776
30	1.1/8	6x984	212	9.580	1	080160780
34	1.1/4	6x1080	296	13.650	1	080160784
40	1.1/2	6x1176	363	17.000	1	080160790

8018T

Szorítókegely, galvanizált



RUM-MU-21:1980

LABORELEMZÉSEK

- Kémiai elemzés
- RENDELKEZÉSRE ÁLLÓ TANÚSÍTVÁNYOK
- Termékleírás
- Vizsgálati jelentés 2.2 UNI EN10204

Ø	A	L	Nm	Ft		
mm	mm	mm				
8÷10	M8	42	10,20	530	200	080180003

8020A

kötélszív, könnyített kivitel,
galvanizált

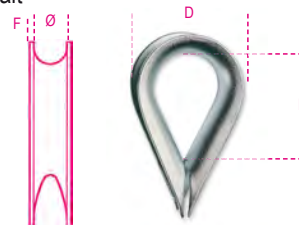

TANÚSÍTVÁNYOK

- Műszaki termékspecifikáció
- Vizsgálati jelentés 2.2 UNI EN10204

Ø	F	B	D	Ft		
mm	mm	mm	mm			
2-3	1,0	20	18	105	150	080200503
4	1,2	23	19	105	150	080200504
5	1,2	24	23	100	100	080200505
6	1,2	27	28	115	100	080200506
8	1,4	33	32	175	50	080200508
10	1,8	41	38	265	30	080200510
12	2,2	44	45	310	30	080200512
14	2,2	52	49	360	50	080200514
16	3,0	58	58	540	50	080200516
18	3,7	64	68	775	50	080200518
20	3,7	73	74	1.110	35	080200520
22	3,7	83	79	1.150	30	080200522
24	3,7	93	88	1.540	20	080200525

Speciális csomagolás

Ø	S	Ft		
mm	mm			
2-3	0,8	150	10.500	1 080200703
4	1,0	150	10.500	1 080200704
5	1,0	100	7.500	1 080200705
6	1,0	100	8.180	1 080200706
8	1,2	50	7.500	1 080200708
10	1,5	30	6.300	1 080200710

8021A

Kötélszív, erősített kivitel, galvanizált

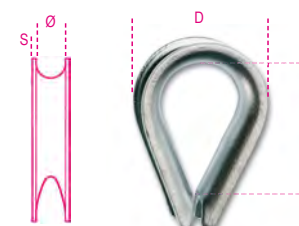

RENDELKEZÉSRE ÁLLÓ TANÚSÍTVÁNYOK

- Termékleírás
- Vizsgálati jelentés 2.2 UNI EN10204

Ø	S	B	D	Ft		
mm	mm	mm	mm			
2-3	0,6	15	16	105	150	080210103
5	1,7	29	28	225	120	080210105
6	1,8	33	30	225	100	080210106
8	2,5	36	37	285	100	080210108
10	2,5	42	43	385	80	080210110
12	2,5	48	50	505	100	080210112
14	2,7	58	57	700	70	080210114
16	3	61	62	840	50	080210116
18	3,5	71	71	1.120	70	080210118
20	4	79	79	1.540	30	080210120
22	4	87	84	1.730	25	080210122
24	4	93	92	2.090	25	080210124
26	4	103	103	2.690	20	080210126
28	5	107	116	5.950	1	080210128
30	5	118	121	6.520	1	080210130
32	5,5	138	135	7.630	1	080210132
35	6	140	147	10.750	1	080210135
40	6,0	174	170	14.000	1	080210140

8026R

egyenes emelőkengyel csavaros csappal,
nagyzilárdságú ötvözött acél
tűzhorganyzott

CE



EN 13889
GRADE 6

MŰSZAKI ADATOK

- legkisebb biztonsági együttható: 6
- hőkezelés: lágyítás
- gyártási sorozatszám a csapon és a kengyelen
- LABORATÓRIUMI ELEMZÉS
- vegyi analízis • metallográfiai analízis
- szakítópróba • fáradáspróba (min. 20.000 ciklus)
- vizsgálati terhelés teszt (2 x wll)
- RENDELKEZÉSRE ÁLLÓ TANÚSÍTVÁNYOK
- Termékleírás • 2.2 UNI EN10204 típusú Tesztjelentés
- 3.1 UNI EN10204 típusú Ellenőrzési tanúsítvány
- EK Megfelelőségi Nyilatkozat

ØD mm	ØA mm	H mm	WLL kg	Ft	📦	🚚
11	10	17	1000	2.000	5	080260210
16	13	21	2000	3.940	5	080260212
19	16	27	3250	6.740	3	080260216
22	19	32	4750	10.000	2	080260219
25	22	37	6500	15.200	2	080260222

Különleges csomagolások szabad
szolgáltatáshoz



ØD mm	📦	Ft	🚚
16	1	4.410	1
19	1	7.320	1

8029R

ívelt emelőkengyel, csavaros csappal
nagyzilárdságú ötvözött acél
tűzhorganyzott



EN 13889
GRADO 6

MŰSZAKI ADATOK

- legkisebb biztonsági együttható: 6
- hőkezelés: lágyítás
- gyártási sorozatszám a csapon és a kengyelen
- LABORATÓRIUMI ELEMZÉS
- vegyi analízis
- metallográfiai analízis
- szakítópróba
- fáradáspróba (min. 20.000 ciklus)
- vizsgálati terhelés teszt (2 x wll)
- RENDELKEZÉSRE ÁLLÓ TANÚSÍTVÁNYOK
- Termékleírás
- 2.2 UNI EN10204 típusú Tesztjelentés
- 3.1 UNI EN10204 típusú Ellenőrzési tanúsítvány
- EK Megfelelőségi Nyilatkozat

ØD mm	ØA mm	H mm	WLL kg	Ft	📦	🚚
8	6	13	500	1.530	20	080290106
10	8	13,5	750	1.800	15	080290108
11	10	17	1000	2.550	15	080290110
13	11	18,5	1500	3.310	10	080290111
16	13	20,5	2000	3.400	8	080290112
19	16	27	3250	5.830	8	080290116
22	19	32	4750	8.450	4	080290120
25	22	37	6500	12.800	4	080290122
28	26	43,5	8500	17.350	1	080290124

ØD mm	ØA mm	H mm	WLL kg	Ft	📦	🚚
32	29	48	9500	31.700	1	080290128
35	32	53	12000	42.850	1	080290132
38	35	59	13500	56.450	1	080290135
42	38	62	17000	73.950	1	080290138
50	45	75	25000	126.200	1	080290145
57	50	83	35000	255.600	1	080290150
65	57	95	42500	440.100	1	080290157
70	65	105	55000	502.800	1	080290165

Különleges csomagolások szabad
szolgáltatáshoz



ØD mm	📦	Ft	🚚
8	1	2.260	1
10	1	2.450	1
11	1	3.120	1
13	1	4.000	1
16	1	4.050	1
19	1	6.720	1

8031R

anyás-sasszeges ívelt emelőkengyel
nagyzilárdságú ötvözött acél
tűzhorganyzott



EN 13889
GRADO 6

MŰSZAKI ADATOK

- legkisebb biztonsági együttható: 6
- hőkezelés: lágyítás
- gyártási sorozatszám a csapon és a kengyelen
- LABORATÓRIUMI ELEMZÉS
- vegyi analízis
- metallográfiai analízis
- szakítópróba
- fáradáspróba (min. 20.000 ciklus)
- vizsgálati terhelés teszt (2 x wll)
- RENDELKEZÉSRE ÁLLÓ TANÚSÍTVÁNYOK
- Termékleírás
- 2.2 UNI EN10204 típusú Tesztjelentés
- 3.1 UNI EN10204 típusú Ellenőrzési tanúsítvány
- EK Megfelelőségi Nyilatkozat

ØD mm	ØA mm	H mm	WLL kg	Ft	📦	🚚
11	10	17	1000	2.870	5	080310110
13	11	18	1500	4.540	5	080310111
16	13	21	2000	4.400	5	080310112
19	16	27	3250	7.360	3	080310116
22	19	32	4750	10.500	2	080310120
25	22	37	6500	14.050	2	080310122
28	26	43	8500	20.800	1	080310124
32	29	48	9500	35.400	1	080310128
35	32	53	12000	46.250	1	080310132
38	35	59	13500	64.950	1	080310135
42	38	62	17000	79.150	1	080310138
50	45	75	25000	136.200	1	080310145
57	50	83	35000	238.700	1	080310150
70	65	105	55000	488.900	1	080310165
83	75	127	85000	741.400	1	080310183

Különleges csomagolások szabad
szolgáltatáshoz



ØD mm	📦	Ft	🚚
16	1	5.540	1
19	1	9.460	1

8032

ívelt emelőkengyel, négyszögletes furatú
csappal
nagyzilárdságú ötvözött acél
tűzhorganyzott

CE



GRADE 6

MŰSZAKI ADATOK

- legkisebb biztonsági együttható: 6
- hőkezelés: lágyítás
- gyártási sorozatszám a csapon és a kengyelen
- LABORATÓRIUMI ELEMZÉS
- vegyi analízis
- metallográfiai analízis
- szakítópróba
- fáradáspróba (min. 20.000 ciklus)
- vizsgálati terhelés teszt (2 x wll)
- RENDELKEZÉSRE ÁLLÓ TANÚSÍTVÁNYOK
- Termékleírás
- 2.2 UNI EN10204 típusú Tesztjelentés
- 3.1 UNI EN10204 típusú Ellenőrzési tanúsítvány
- EK Megfelelőségi Nyilatkozat

ØD mm	ØA mm	H mm	WLL kg	Ft	📦	🚚
11	10	17	1000	3.190	5	080320010
16	13	21	2000	4.230	5	080320012
19	16	27	3250	7.630	3	080320016
22	19	32	4750	12.800	2	080320020
25	22	37	6500	18.600	2	080320022

Különleges csomagolások szabad
szolgáltatáshoz



ØD mm	📦	Ft	🚚
16	1	5.020	1
19	1	8.180	1

8025

egyenes emelőkengyel, széles típus
szénacél
horganyzott

CE



GRADO 4

MŰSZAKI ADATOK

- Min. biztonsági koeficiens: 5
- Hőkezelés: normál hőkezelés
- Gyártási száma
- LABORELEMZÉSEK
- Kémiai elemzés • Metallográfiai elemzés
- Szakítópróba
- RENDELKEZÉSRE ÁLLÓ TANÚSÍTVÁNYOK
- Termékleírás
- Vizsgálati jelentés 2.2 UNI EN10204
- Ellenőrzési tanúsítvány 3.1 UNI EN10204
- CE-Megfelelőségi nyilatkozat

Ø mm	≈ "	B x C mm	WLL kg	Ft	📦	🚚
5	3/16	21x10	70	565	250	080250005
6	1/4	25x12	100	770	250	080250006
8	5/16	33x16	250	1.190	150	080250008
10	3/8	42x20	400	1.320	180	080250010
11	7/16	46x22	500	1.620	130	080250011
12	1/2	50x24	600	1.770	100	080250012
14	9/16	57x28	800	2.310	70	080250014
16	5/8	61x32	1000	3.050	10	080250016
18	11/16	65x36	1300	4.380	10	080250018
20	3/4	70x40	1600	5.240	10	080250020
22	7/8	74x44	2000	7.420	10	080250022
25	1"	80x48	2800	9.740	2	080250025

Speciális csomagolás

Ø mm	"		Ft		
5	3/16	25	14.150	1	080250705
6	1/4	25	19.250	1	080250706
8	5/16	25	29.750	1	080250708
10	3/8	15	19.800	1	080250710
11	7/16	12	19.450	1	080250711
12	1/2	12	21.250	1	080250712
14	9/16	10	23.100	1	080250714

Különleges csomagolások szabad
szolgáltatáshoz



Ø mm		Ft		
5	4	3.340	1	080259205
6	4	4.050	1	080259206
8	2	2.900	1	080259208
10	2	3.290	1	080259210
11	1	2.150	1	080259011
12	1	2.350	1	080259012
14	1	2.930	1	080259014
16	1	3.840	1	080259016
18	1	5.340	1	080259018
20	1	5.840	1	080259020
22	1	8.420	1	080259022
25	1	10.500	1	080259025

8026A

egyenes emelőkenyel, UNI típus
szénacél
horganyzott

CE

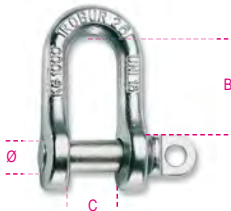

GRADO 4

MŰSZAKI ADATOK

- Min. biztonsági koeficiens: 5
- Hőkezelés: normál hőkezelés
- Gyártási száma

LABORELEMZÉSEK

- Kémiai elemzés
- Metallográfiai elemzés
- Szakítópróba

RENDELKEZÉSRE ÁLLÓ TANÚSÍTVÁNYOK

- Termékleírás
- Vizsgálati jelentés 2.2 UNI EN10204
- Ellenőrzési tanúsítvány 3.1 UNI EN10204
- CE-Megfelelőségi nyilatkozat

Ø mm	"	B x C mm	WLL kg	Ft			
12	1/2	42x20	630	1.890	35	080260012	
14	9/16	46x22	800	2.400	30	080260014	
16	5/8	50x24	1000	3.180	20	080260016	
18	11/16	54x26	1300	4.340	15	080260018	
20	3/4	58x28	1600	5.330	10	080260020	
22	7/8	69x32	2000	7.740	10	080260022	
25	1"	79x36	2500	9.900	5	080260025	
28	1.1/8	90x40	3150	13.650	2	080260028	
32	1.1/4	100x45	4000	19.000	1	080260032	
36	1.3/8	110x50	5000	27.500	1	080260036	
40	1.9/16	120x55	6300	38.050	1	080260040	
42	1.5/8	131x60	8000	48.800	1	080260042	
45	1.3/4	143x65	10000	67.400	1	080260045	
50	2"	155x70	12500	86.800	1	080260050	

Különleges csomagolások szabad
szolgáltatáshoz



Ø mm		Ft		
12	1	2.600	1	080269012
14	1	2.940	1	080269014
16	1	3.690	1	080269016
18	1	5.440	1	080269018
20	1	6.510	1	080269020
22	1	8.700	1	080269022
25	1	10.800	1	080269025

Robur

8028

ívelt emelőkenyel
szénacél
horganyzott

CE

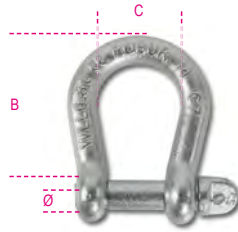

GRADO 4

MŰSZAKI ADATOK

- Min. biztonsági koeficiens: 5
- Hőkezelés: normál hőkezelés
- Gyártási száma

LABORELEMZÉSEK

- Kémiai elemzés
- Metallográfiai elemzés
- Szakítópróba

RENDELKEZÉSRE ÁLLÓ TANÚSÍTVÁNYOK

- Termékleírás
- Vizsgálati jelentés 2.2 UNI EN10204
- Ellenőrzési tanúsítvány 3.1 UNI EN10204
- CE-Megfelelőségi nyilatkozat

Ø mm	"	B x C mm	WLL kg	Ft			
5	3/16	20x16	80	525	100	080280105	
6	1/4	24x20	100	705	70	080280106	
8	5/16	32x24	200	1.200	35	080280108	
10	3/8	40x33	300	1.410	25	080280110	
12	1/2	48x39	500	2.260	15	080280112	
14	9/16	56x46	600	3.300	7	080280114	
16	5/8	64x46	800	5.010	10	080280116	
18	11/16	71x59	950	6.160	5	080280118	
20	3/4	80x65	1100	7.820	5	080280120	
22	7/8	88x72	1500	10.150	5	080280122	
25	1"	100x81	2000	15.750	2	080280125	
28	1.1/8	112x91	2600	24.300	1	080280128	
32	1.1/4	128x104	3200	33.650	1	080280132	
38	1.1/2	152x124	4500	66.500	1	080280138	

Különleges csomagolások szabad
szolgáltatáshoz



Ø mm		Ft		
5	4	2.900	1	080289305
6	4	4.080	1	080289306
8	2	3.420	1	080289308
10	2	3.710	1	080289310
12	1	2.760	1	080289112
14	1	3.670	1	080289114
16	1	5.100	1	080289116
18	1	7.120	1	080289118
20	1	8.960	1	080289120
22	1	11.650	1	080289122

8049 WLL (t)

	A°	M8	M10	M12	M16	M20	M24	M30
	0°	0,3	0,6	1	1,6	2,5	4	6,3
	0°	0,6	1,2	2	3,2	5	8	12,6
	90°	0,3	0,6	1	1,6	2,5	4	6,3
	90°	0,6	1,2	2	3,2	5	8	12,6
	0°	0,4	0,8	1,4	2,2	3,5	5,6	8,8
	46°	0,3	0,6	1	1,6	2,5	4	6,3
	0°	0,6	1,3	2,1	3,4	5,3	8,4	13,2
	46°	0,3	0,6	1	1,6	2,3	4	6,3

8049

Gyűrűs anya, állítható, dupla csuklóval,
ötvözött acélból

CE

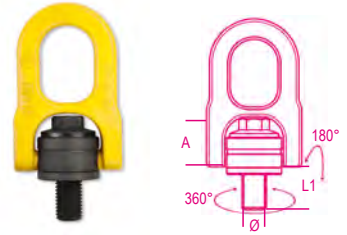

MŰSZAKI ADATOK

- Min. biztonsági koeficiens: 5
- Hőkezelés: díjazás ellenében
- Gyártási száma

LABORELEMZÉSEK

- Kémiai elemzés
- Metallográfiai elemzés
- Szakítópróba

Fáradáspróba (20.000 ciklus)

RENDELKEZÉSRE ÁLLÓ TANÚSÍTVÁNYOK

- Termékleírás
- Vizsgálati jelentés 2.2 UNI EN10204
- Ellenőrzési tanúsítvány 3.1 UNI EN10204
- CE-Megfelelőségi nyilatkozat

Ø mm	A mm	L1 mm	WLL 90° kg	Ft			
M8	31,5	14	300	47.850	1	080490008	
M10	31,5	17	600	48.800	1	080490010	
M12	31,5	21	1000	50.000	1	080490012	
M16	45	27	1600	57.300	1	080490016	
M20	45	30	2500	58.800	1	080490020	
M24	60,5	36	4000	99.550	1	080490024	
M30	60,5	45	6300	102.800	1	080490030	

Robur

8049A WLL (t)

	0°	M6	M8	M10	M12	M16	M20	M24	M30	M36
	0°	400	600	900	1000	2000	4000	6300	10600	11800
	0°	800	1200	1800	2000	4000	8000	12600	21200	23600
	90°	200	300	450	500	1120	2000	3150	5300	8000
	90°	400	600	900	1000	2000	4000	6300	10600	16000
	0° 45°	250	400	600	700	1400	2800	4250	7100	10700
	45° 60°	200	300	450	500	1120	2000	3150	5300	8000
	0° 45°	400	600	900	1000	2100	4200	6300	11200	16000
	45° 60°	250	400	600	750	1500	3000	4750	8000	10700

8049A

gyűrűs anya,
dupla csuklóval, teher alatt elfordul,
hegesztett gyűrűvel
nagyszilárdságú ötvözött acél

CE



MŰSZAKI ADATOK

- biztonsági együttható: 4
- hőkezelés: edzés
- azonosító kód
- LABORATÓRIUMI TESZTEK
- vegyelemzés
- fémszerkezet vizsgálat
- szakítópróba
- fáradáspróba (20.000 ciklus)
- terhelési teszt (minden darabra)
- TANÚSÍTVÁNYOK
- Műszaki termékspecifikáció
- Vizsgálati jelentés 2.2 UNI EN10204
- Ellenőrző tanúsítvány 3.1 UNI EN10204
- CE megfelelési nyilatkozat

Ø	E	A	WLL 90°	Ft		
mm	mm	mm	kg			
M6	13	30	200	20.350	1	080490106
M8	13	30	300	21.000	1	080490108
M10	19	30	450	22.000	1	080490110
M12	19	30	500	23.200	1	080490112
M16	20	30	1120	24.850	1	080490116
M20	30	40	2000	38.600	1	080490120
M24	30	40	3150	55.700	1	080490124
M30	35	50	5300	94.250	1	080490130
M36	54	50	8000	98.700	1	080490136

8049V

gyűrűs anya
eltolt csuklóval
nagyszilárdságú ötvözött acél
360°-ban elforgatható szemescsavar forgócsuklóval

CE



MŰSZAKI ADATOK

- biztonsági együttható: 4
- hőkezelés: edzés és lágyítás
- azonosító kód
- LABORATÓRIUMI TESZTEK
- vegyelemzés
- fémszerkezet vizsgálat
- szakítópróba
- fáradáspróba (20.000 ciklus)
- terhelési teszt (minden darabra)
- TANÚSÍTVÁNYOK
- Műszaki termékspecifikáció
- Vizsgálati jelentés 2.2 UNI EN10204
- Ellenőrző tanúsítvány 3.1 UNI EN10204
- CE megfelelési nyilatkozat

Ø	E	B	WLL	Ft		
mm	mm	mm	kg			
M12	18	37,5	1000	37.450	1	080490312
M16	24	37,5	1500	40.000	1	080490316
M20	35,5	54	2500	58.050	1	080490320
M24	35,5	54	4000	59.750	1	080490324

8068S

hegesztett konzol emeléshez,
egyetlen alap, pozicionáló rugókkal,
nagyszilárdságú ötvözött acél test

- Kompakt méretek emelési műveletekhez
- Teljes terhelés mellett 20 000 munkaciklus kapacitásra tesztelve
- Értékesítése előtt minden részt terheléssel ellenőrzünk
- Biztonsági együttható: minden irányban 4

CE



MŰSZAKI ADATOK

- biztonsági együttható: 4
- hőkezelés: edzés
- azonosító kód
- LABORATÓRIUMI TESZTEK
- vegyelemzés
- fémszerkezet vizsgálat
- szakítópróba
- fáradáspróba (20.000 ciklus)
- terheléspróba (minden egyes darabon)
- TANÚSÍTVÁNYOK
- Műszaki termékspecifikáció
- Vizsgálati jelentés 2.2 UNI EN10204
- Ellenőrző tanúsítvány 3.1 UNI EN10204
- CE megfelelési nyilatkozat

WLL	B	M	A	Ft		
Kg	mm	mm	mm			
1500	78	37	41	4.270	1	080680115
2500	88	40	42	5.600	1	080680125
4000	94	42	45	8.020	1	080680140
6700	118	51	55	14.900	1	080680167

Figyelem:

- Az összekötőelemnek megfelelő mechanikai ellenállásúnak és hegeszhetőnek kell lenni.
- A hegesztést az erre képzett személyek végezhetik.

8041

külső fűlőcsavar emeléshez,
nagyszilárdságú ötvözött acélból

CE



MŰSZAKI ADATOK

- biztonsági együttható: 4
- hőkezelés: lágyítás
- gyártási sorozat száma
- LABORATÓRIUMI ELEMZÉS
- vegyi analízis
- metallográfiai analízis
- szakítópróba
- fáradáspróba (20.000 ciklus)
- teszt terhelés (a sorozat 100%-án)
- RENDELKEZÉSRE ÁLLÓ TANÚSÍTVÁNYOK
- Termékleírás
- 2.2 UNI EN10204 típusú Tesztjelentés
- 3.1 UNI EN10204 típusú Ellenőrzési tanúsítvány
- EK Megfelelési Nyilatkozat

Ø	E	WLL	Ft		
mm	mm	kg			
M6	1	11	400	1.420	10 080410206
* M8	1,25	13	800	1.340	10 080410208
* M10	1,5	17	1000	2.070	6 080410210
* M12	1,75	20,5	1600	3.110	4 080410212
M14	2	20,5	3000	5.150	2 080410214
M16	2,5	30	4000	7.780	2 080410217
M18	2,5	27	5000	7.780	2 080410218
M20	3,0	36	6000	14.350	2 080410221
M22	2,5	30	7000	14.350	2 080410222
M24	3	41	8000	23.850	2 080410225
M27	3	41	10000	27.350	1 080410227
* M30	3,5	45	12000	28.600	1 080410230

(* Méretjellemzők DIN 580:2010

A Robur Műszaki Kiadvány szerint növelt WLL

Különleges csomagolások szabad
szolgáltatáshoz



Ø	Ft		
mm			
* M8	1	2.210	1 080419208
* M10	1	3.240	1 080419210
* M12	1	4.410	1 080419212

Robur

Robur

8043

belső fűlécscsavar emeléshez,
nagyzilárdágú ötvöztött acélból

CE

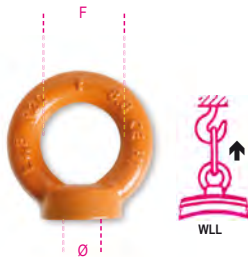

MŰSZAKI ADATOK

- biztonsági együttható: 4
- hőkezelés: lágyítás
- gyártási sorozat száma

LABORATÓRIUMI ELEMZÉS

- vegyi analízis
- metallográfiai analízis
- szakítópróba
- fáradáspróba (20.000 ciklus)
- teszt terhelés (a sorozat 100%-án)

RENDELKEZÉSRE ÁLLÓ TANÚSÍTVÁNYOK

- Termékleírás
- 2.2 UNI EN10204 típusú Tesztjelentés
- 3.1 UNI EN10204 típusú Ellenőrzési tanúsítvány
- EK Megfelelőségi Nyilatkozat

Ø mm	F mm	WLL kg	Ft	📦	🚚
M6	1	20	400	1.250	10 080430206
* M8	1,25	20	800	1.250	10 080430208
* M10	1,50	25	1000	2.080	6 080430210
* M12	1,75	30	1600	3.080	4 080430212
M14	2	35	3000	5.050	2 080430214
M16	2,5	40	4000	6.950	2 080430217
M18	2,5	40	5000	6.950	2 080430218
M20	2,5	50	6000	14.750	2 080430221
M22	2,5	50	7000	14.750	2 080430222
M24	3	55	8000	25.650	2 080430225
M27	3	60	10000	26.200	1 080430227
* M30	3,5	60	12000	27.050	1 080430230

(* Méretjellemzők DIN 582:2010

A Robur Műszaki Kiadvány szerint növelt WLL

Különleges csomagolások szabad
szolgáltatáshoz



Ø mm	Ft	📦	🚚
* M8	1	2.180	1 080439208
* M10	1	3.120	1 080439210
* M12	1	4.220	1 080439212

8040EZ

szemescsavar,
galvanizált

CE



DIN 580:2018-04(**)

MŰSZAKI ADATOK

- biztonsági együttható: 6
- hőkezelés: normál hőkezelés
- azonosító kód

LABORATÓRIUMI VIZSGÁLATOK

- vegyelemzés
- fémszerkezet vizsgálat
- szakítópróba

TANÚSÍTVÁNYOK

- Műszaki termékspecifikáció
- Vizsgálati jelentés 2.2 UNI EN10204
- Ellenőrző tanúsítvány 3.1 UNI EN10204
- CE megfeleléségi nyilatkozat

Ø mm	F mm	E mm	WLL kg	Ft	📦	🚚
* M6	1	11	90	850	60	080400406
M8	1,25	13	140	795	60	080400408
M10	1,5	17	230	1.090	40	080400410
M12	1,75	20,5	340	1.310	20	080400412
* M14	2	20,5	480	1.680	20	080400414
M16	2	27	700	2.040	10	080400416
* M18	2,5	27	930	2.490	10	080400418
M20	2,5	30	1200	3.090	10	080400420
* M22	2,5	30	1450	4.060	10	080400422
M24	3	36	1800	5.840	5	080400424
* M27	3	41	2400	7.060	5	080400427
M30	3,5	45	3200	12.100	2	080400430
* M33	3,5	54	3900	16.050	2	080400433
* M33F	2	54	3900	16.050	2	080400434
M36	4	54	4600	16.800	2	080400436
* M36F	3	54	4600	16.800	2	080400437
M42	4,5	63	6300	31.700	1	080400442
* M42F	3	63	6300	31.700	1	080400443
M48	5	68	8600	50.500	1	080400448
* M48F	3	68	8600	50.500	1	080400449
M56	5,5	78	11500	81.300	1	080400456
* M56F	4	78	11500	81.300	1	080400457
M64	6	90	16000	116.300	1	080400464
* M64F	4	90	16000	116.300	1	080400465

*Méretezés a Robur műszaki fájlnak megfelelően

Különleges csomagolások szabad
szolgáltatáshoz



Ø mm	Ft	📦	🚚
M6	4	4.030	1 080409606
M8	4	4.040	1 080409608
M10	2	2.400	1 080409610
M12	1	1.800	1 080409412
* M14	1	2.110	1 080409414
M16	1	2.570	1 080409416
* M18	1	3.060	1 080409418
M20	1	3.540	1 080409420
* M22	1	4.630	1 080409422
M24	1	6.220	1 080409424
* M27	1	7.900	1 080409427
M30	1	12.800	1 080409430

8040EN

szemescsavar,
fekete

CE



DIN 580:2018-04(**)

MŰSZAKI ADATOK

- biztonsági együttható: 6
- hőkezelés: normál hőkezelés
- azonosító kód

LABORATÓRIUMI VIZSGÁLATOK

- vegyelemzés
- fémszerkezet vizsgálat
- szakítópróba

TANÚSÍTVÁNYOK

- Műszaki termékspecifikáció
- Vizsgálati jelentés 2.2 UNI EN10204
- Ellenőrző tanúsítvány 3.1 UNI EN10204
- CE megfeleléségi nyilatkozat

Ø mm	F mm	E mm	WLL kg	Ft	📦	🚚
* M6	1	11	90	770	60	080400306
M8	1,25	13	140	755	60	080400308
M10	1,5	17	230	1.030	40	080400310
M12	1,75	20,5	340	1.350	20	080400312
* M14	2	20,5	480	1.680	20	080400314
M16	2	27	700	1.970	10	080400316
* M18	2,5	27	930	2.540	10	080400318
M20	2,5	30	1200	2.930	10	080400320
* M22	2,5	30	1450	3.940	10	080400322
M24	3	36	1800	5.590	5	080400324
* M27	3	41	2400	6.980	5	080400327
M30	3,5	45	3200	11.650	2	080400330
* M33	3,5	54	3900	15.750	2	080400333
* M33F	2	54	3900	15.750	2	080400334
M36	4	54	4600	16.450	2	080400336
* M36F	3	54	4600	16.450	2	080400337
M42	4,5	63	6300	30.950	1	080400342
* M42F	3	63	6300	30.950	1	080400343
M48	5	68	8600	49.850	1	080400348
* M48F	3	68	8600	49.850	1	080400349
M56	5,5	78	11500	75.500	1	080400356
* M56F	4	78	11500	75.500	1	080400357
M64	6	90	16000	109.200	1	080400364
* M64F	4	90	16000	109.200	1	080400365

*Méretezés a Robur műszaki fájlnak megfelelően

Különleges csomagolások szabad
szolgáltatáshoz



Ø mm	Ft	📦	🚚
M6	4	3.770	1 080409506
M8	4	4.020	1 080409508
M10	2	2.280	1 080409510
M12	1	1.840	1 080409312
* M14	1	2.180	1 080409314
M16	1	2.550	1 080409316
* M18	1	3.040	1 080409318
M20	1	3.300	1 080409320
* M22	1	4.460	1 080409322
M24	1	5.920	1 080409324
* M27	1	7.500	1 080409327
M30	1	12.350	1 080409330

8042EZ

emelő gyűrűs anya,
galvanizált

CE



DIN582:2018-04(**)

MŰSZAKI ADATOK

- biztonsági együttható: 6
- hőkezelés: normál hőkezelés
- azonosító kód

LABORATÓRIUMI VIZSGÁLATOK

- vegyelemzés
- fémszerkezet vizsgálat
- szakítópóba

TANÚSÍTVÁNYOK

- Műszaki termékspecifikáció
- Vizsgálati jelentés 2.2 UNI EN10204
- Ellenőrző tanúsítvány 3.1 UNI EN10204
- CE megfelelési nyilatkozat

Ø mm	h _h mm	F mm	WLL kg	Ft	h	h _h
* M6	1	14	90	810	60	080420406
M8	1,25	20	140	835	60	080420408
M10	1,5	25	230	1.150	40	080420410
M12	1,75	30	340	1.370	30	080420412
* M14	2	30	480	1.800	30	080420414
M16	2	35	700	2.060	20	080420416
* M18	2,5	35	930	2.530	20	080420418
M20	2,5	40	1200	3.080	10	080420420
* M22	2,5	40	1450	4.130	10	080420422
M24	3	50	1800	5.770	5	080420424
* M27	3	55	2400	7.030	5	080420427
M30	3,5	60	3200	11.150	3	080420430
M36	4	70	4600	16.900	2	080420436
* M36F	3	70	4600	16.900	2	080420437
M42	4,5	80	6300	30.950	1	080420442
* M42F	3	80	6300	30.950	1	080420443
M48	5	90	8600	50.450	1	080420448
* M48F	3	90	8600	50.450	1	080420449

*Méreterezés a Robur műszaki fájljánk megfelelően

Különleges csomagolások szabad
szolgáltatáshoz



Ø mm	h _h	Ft	h	h _h
M6	4	3.830	1	080429606
M8	4	3.870	1	080429608
M10	2	2.350	1	080429610
M12	1	1.810	1	080429412
* M14	1	2.160	1	080429414
M16	1	2.430	1	080429416
* M18	1	2.900	1	080429418
M20	1	3.530	1	080429420
* M22	1	4.570	1	080429422
M24	1	6.710	1	080429424
* M27	1	7.290	1	080429427
M30	1	11.400	1	080429430

Robur

Robur

8042EN

emelő gyűrűs anya,
fekete

CE

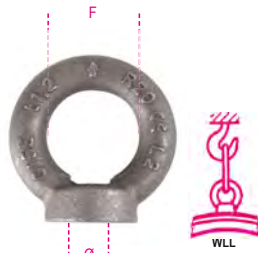

DIN582:2018-04(**)

MŰSZAKI ADATOK

- biztonsági együttható: 6
- hőkezelés: normál hőkezelés
- azonosító kód

LABORATÓRIUMI VIZSGÁLATOK

- vegyelemzés
- fémszerkezet vizsgálat
- szakítópóba

TANÚSÍTVÁNYOK

- Műszaki termékspecifikáció
- Vizsgálati jelentés 2.2 UNI EN10204
- Ellenőrző tanúsítvány 3.1 UNI EN10204
- CE megfelelési nyilatkozat

Ø mm	h _h mm	F mm	WLL kg	Ft	h	h _h
* M6	1	14	90	805	60	080420306
M8	1,25	20	140	805	60	080420308
M10	1,5	25	230	1.090	40	080420310
M12	1,75	30	340	1.370	30	080420312
* M14	2	30	480	1.730	30	080420314
M16	2	35	700	1.890	20	080420316
* M18	2,5	35	930	2.440	20	080420318
M20	2,5	40	1200	2.840	10	080420320
* M22	2,5	40	1450	3.890	10	080420322
M24	3	50	1800	5.490	5	080420324
* M27	3	55	2400	6.670	5	080420327
M30	3,5	60	3200	10.400	3	080420330
M36	4	70	4600	15.800	2	080420336
* M36F	3	70	4600	15.800	2	080420337
M42	4,5	80	6300	29.450	1	080420342
* M42F	3	80	6300	29.450	1	080420343
M48	5	90	8600	47.450	1	080420348
* M48F	3	90	8600	47.450	1	080420349

*Méreterezés a Robur műszaki fájljánk megfelelően

Különleges csomagolások szabad
szolgáltatáshoz



Ø mm	h _h	Ft	h	h _h
M6	4	3.770	1	080429506
M8	4	4.020	1	080429508
M10	2	2.390	1	080429510
M12	1	1.870	1	080429312
* M14	1	2.120	1	080429314
M16	1	2.380	1	080429316
* M18	1	3.010	1	080429318
M20	1	3.320	1	080429320
* M22	1	4.550	1	080429322
M24	1	6.140	1	080429324
* M27	1	7.510	1	080429327
M30	1	11.600	1	080429330

8044

Emelő gyűrűs anya,
természetes színű

CE



UNI 2948

MŰSZAKI ADATOK

- Min. biztonsági koefficiens: 4
- Hőkezelés: normál hőkezelés
- Gyártási száma

LABORELEMZÉSEK

- Kémiai elemzés
- Metallográfiai elemzés
- Szakítópóba

RENDELKEZÉSRE ÁLLÓ TANÚSÍTVÁNYOK

- Termékleírás
- Vizsgálati jelentés 2.2 UNI EN10204
- Ellenőrzési tanúsítvány 3.1 UNI EN10204
- CE-Megfelelési nyilatkozat

Ø mm	h _h mm	WLL kg	Ft	h	h _h
M8	1,25	80	930	4	080440008
M10	1,5	160	1.700	4	080440010
M12	1,75	250	3.030	4	080440012
M14	2	250	3.720	2	080440014
M16	2	400	3.910	2	080440016
M20	2,5	630	7.030	2	080440020
M24	3	1000	11.850	2	080440024



RÖGZÍTŐ HEVEDER

Biztonsági fok 8

WLL Ton		UNI EN 818	
Ø D mm	WLL 1	WLL 2	
		0° < β ≤ 45°	45° < β ≤ 60°
6	1,12	1,6	1,12
7	1,5	2,12	1,5
8	2	2,8	2
10	3,15	4,25	3,15
13	5,3	7,5	5,3
16	8	11,2	8
Ø D mm	WLL 3	WLL 3	
		0° < β ≤ 45°	45° < β ≤ 60°
6	2,36	1,7	
7	3,15	2,24	
8	4,25	3	
10	6,7	4,75	
13	11,2	8	
16	17	11,2	

8091

rögítő emelőheveder
1 karos lánc
táskában

Kérésre Self-locking-gal és megrövidítve

CE

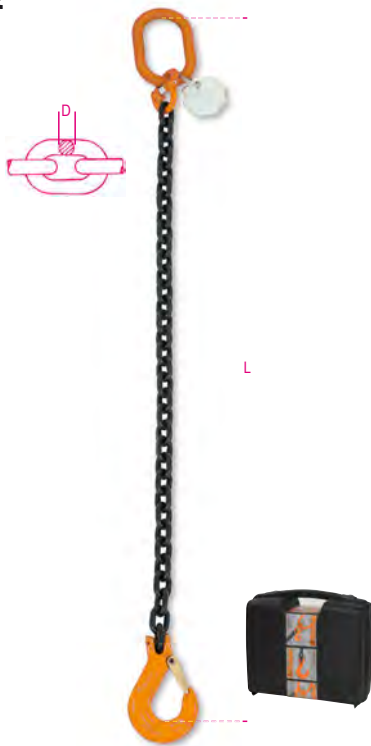

UNI EN 818-4

MŰSZAKI ADATOK

- Min. biztonsági koeficiens: 4
- Szériaazonosítólap
- MELLÉKELT TANÚSÍTVÁNYOK**
- Gyártói tanúsítvány UNI EN818-4
- CE-Megfelelőségi nyilatkozat
- RENDELKEZÉSRE ÁLLÓ TANÚSÍTVÁNYOK**
- Termékleírás

D mm	L m	WLL ton	Ft		
6*	1	1,12	34.200	1	080910001
6*	2	1,12	43.050	1	080910002
6*	3	1,12	51.900	1	080910003
6*	4	1,12	60.750	1	080910004
7*	1	1,5	36.750	1	080910021
7*	2	1,5	47.400	1	080910022
7*	3	1,5	58.050	1	080910023
7*	4	1,5	68.700	1	080910024
8*	1	2	42.300	1	080910041
8*	2	2	54.800	1	080910042
8*	3	2	67.300	1	080910043
8*	4	2	84.300	1	080910044
10*	1	3,15	54.100	1	080910051
10*	2	3,15	72.100	1	080910052
10*	3	3,15	94.650	1	080910053
10*	4	3,15	112.600	1	080910054
13*	1	5,3	86.050	1	080910131
13*	2	5,3	115.400	1	080910132
13*	3	5,3	144.100	1	080910133
13*	4	5,3	173.500	1	080910134
16*	1	8	173.900	1	080910161
16*	2	8	216.100	1	080910162
16*	3	8	259.100	1	080910163
16*	4	8	302.000	1	080910164
20	1	12,5	334.400	1	080910171
20	2	12,5	415.800	1	080910172
20	3	12,5	497.200	1	080910173
20	4	12,5	578.600	1	080910174

* Súlynak megfelelő facsomagolás

8091SL

emelőlánc,
1 karos, önzáró horog
8. osztály

CE

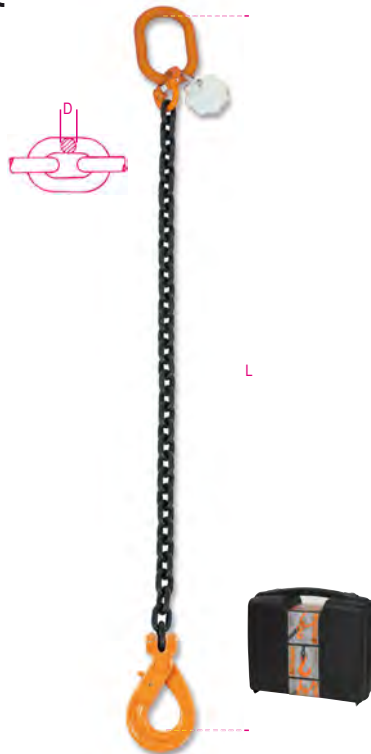

UNI EN 818-4

MŰSZAKI ADATOK

- biztonsági együttható: 4
- emelőlánc azonosító
- MELLÉKELT TANÚSÍTVÁNYOK**
- Gyártói tanúsítvány UNI EN818-4
- CE megfelelőségi nyilatkozat
- RENDELKEZÉSRE ÁLLÓ TANÚSÍTVÁNYOK**
- Termékleírás

D mm	L m	WLL ton	Ft		
6*	1	1,12	44.950	1	080910201
6*	2	1,12	53.800	1	080910202
6*	3	1,12	62.650	1	080910203
6*	4	1,12	71.500	1	080910204
7*	1	1,5	50.450	1	080910221
7*	2	1,5	61.100	1	080910222
7*	3	1,5	71.750	1	080910223
7*	4	1,5	82.400	1	080910224
8*	1	2	55.000	1	080910241
8*	2	2	65.000	1	080910242
8*	3	2	80.000	1	080910243
8*	4	2	97.050	1	080910244
10*	1	3,15	68.450	1	080910251
10*	2	3,15	86.450	1	080910252
10*	3	3,15	109.000	1	080910253
10*	4	3,15	132.400	1	080910254
13*	1	5,3	122.200	1	080910331
13*	2	5,3	160.500	1	080910332
13*	3	5,3	181.000	1	080910333
13*	4	5,3	218.600	1	080910334
16*	1	8	228.000	1	080910361
16*	2	8	283.200	1	080910362
16*	3	8	313.200	1	080910363
16*	4	8	369.100	1	080910364
20	1	12,5	520.400	1	080910401
20	2	12,5	601.800	1	080910402
20	3	12,5	683.200	1	080910403
20	4	12,5	764.600	1	080910404

* Műanyag táskában

8092

rögítő emelőheveder
2 karos lánc
táskában

Kérésre Self-locking-gal és megrövidítve

CE



UNI EN 818-4

MŰSZAKI ADATOK

- Min. biztonsági koeficiens: 4
- Szériaazonosítólap
- MELLÉKELT TANÚSÍTVÁNYOK**
- Gyártói tanúsítvány UNI EN818-4
- CE-Megfelelőségi nyilatkozat
- RENDELKEZÉSRE ÁLLÓ TANÚSÍTVÁNYOK**
- Termékleírás

D mm	L m	WLL ton	Ft		
6*	1	1,6	51.850	1	080920001
6*	2	1,6	69.550	1	080920002
6*	3	1,6	87.250	1	080920003
6*	4	1,6	109.500	1	080920004
7*	1	2,12	58.700	1	080920021
7*	2	2,12	80.000	1	080920022
7*	3	2,12	105.800	1	080920023
7*	4	2,12	127.100	1	080920024
8*	1	2,8	68.750	1	080920041
8*	2	2,8	93.750	1	080920042
8*	3	2,8	123.300	1	080920043
8*	4	2,8	148.300	1	080920044
10*	1	4,25	97.750	1	080920051
10*	2	4,25	133.800	1	080920052
10*	3	4,25	169.100	1	080920053
10*	4	4,25	205.100	1	080920054
13*	1	7,5	157.500	1	080920131
13*	2	7,5	215.600	1	080920132
13	3	7,5	266.600	1	080920133
13	4	7,5	342.400	1	080920134
16*	1	11,2	318.700	1	080920161
16	2	11,2	413.800	1	080920162
16	3	11,2	499.700	1	080920163
16	4	11,2	585.600	1	080920164
20	2	17,0	829.100	1	080920172
20	3	17,0	991.900	1	080920173
20	4	17,0	1.154.700	1	080920174

* Súlynak megfelelő facsomagolás



Robur

8092SL

emelőlánc,
2 karos, önzáró horog
8. biztonsági fok

CE



UNI EN 818-4

MŰSZAKI ADATOK

- biztonsági együttható: 4
- emelőlánc azonosító
- MELLÉKELT TANÚSÍTVÁNYOK
- Gyártói tanúsítvány UNI EN818-4
- CE megfelelési nyilatkozat
- RENDELKEZÉSRE ÁLLÓ TANÚSÍTVÁNYOK
- Termékleírás

D mm	L m	WLL ton	Ft	📄	📄
6*	1	1,6	73.350	1	080920201
6*	2	1,6	87.500	1	080920202
6*	3	1,6	105.200	1	080920203
6*	4	1,6	131.000	1	080920204
7*	1	2,12	86.050	1	080920221
7*	2	2,12	103.100	1	080920222
7*	3	2,12	133.200	1	080920223
7*	4	2,12	154.500	1	080920224
8*	1	2,8	89.150	1	080920241
8*	2	2,8	118.700	1	080920242
8*	3	2,8	143.700	1	080920243
8*	4	2,8	173.700	1	080920244
10*	1	4,25	137.300	1	080920251
10*	2	4,25	162.500	1	080920252
10*	3	4,25	197.800	1	080920253
10*	4	4,25	244.600	1	080920254
13*	1	7,5	247.500	1	080920331
13*	2	7,5	265.000	1	080920332
13*	3	7,5	356.600	1	080920333
13*	4	7,5	432.500	1	080920334
16*	1	11,2	452.800	1	080920361
16*	2	11,2	547.900	1	080920362
16*	3	11,2	633.800	1	080920363
16*	4	11,2	719.700	1	080920364
20	2	17,0	1.322.300	1	080920402
20	3	17,0	1.485.100	1	080920403
20	4	17,0	1.647.900	1	080920404

* Műanyag táskában

8094

rögzítő emelőheveder
4 karos lánc
táskában
Kérésre Self-locking-gal és megrövidítve

CE



UNI EN 818-4

MŰSZAKI ADATOK

- Min. biztonsági koefficiens: 4
- Szériazonosítólap
- MELLÉKELT TANÚSÍTVÁNYOK
- Gyártói tanúsítvány UNI EN818-4
- CE-Megfelelési nyilatkozat
- RENDELKEZÉSRE ÁLLÓ TANÚSÍTVÁNYOK
- Termékleírás

D mm	L m	WLL ton	Ft	📄	📄
6*	1	2,36	110.100	1	080940001
6*	2	2,36	150.000	1	080940002
6*	3	2,36	185.400	1	080940003
6*	4	2,36	220.100	1	080940004
7*	1	3,15	124.900	1	080940021
7*	2	3,15	167.500	1	080940022
7*	3	3,15	209.400	1	080940023
7*	4	3,15	252.000	1	080940024
8*	1	4,25	154.000	1	080940041
8*	2	4,25	203.300	1	080940042
8*	3	4,25	253.300	1	080940043
8	4	4,25	312.600	1	080940044
10*	1	6,7	203.100	1	080940051
10	2	6,7	277.200	1	080940052
10	3	6,7	356.400	1	080940053
10	4	6,7	428.400	1	080940054
13	1	11,2	334.200	1	080940131
13	2	11,2	451.800	1	080940132
13	3	11,2	569.400	1	080940133
13	4	11,2	687.000	1	080940134
16	1	17	659.200	1	080940161
16	2	17	831.000	1	080940162
16	3	17	1.002.800	1	080940163
16	4	17	1.174.600	1	080940164
20	2	26,5	1.517.400	1	080940172
20	3	26,5	1.843.000	1	080940173
20	4	26,5	2.168.600	1	080940174

* Súlynak megfelelő facsomagolás

Robur

Robur

8094SL

emelőlánc,
4 karos, önzáró horog
8. biztonsági fok

CE



UNI EN 818-4

MŰSZAKI ADATOK

- biztonsági együttható: 4
- emelőlánc azonosító
- MELLÉKELT TANÚSÍTVÁNYOK
- Gyártói tanúsítvány UNI EN818-4
- CE megfelelési nyilatkozat
- RENDELKEZÉSRE ÁLLÓ TANÚSÍTVÁNYOK
- Termékleírás

D mm	L m	WLL ton	Ft	📄	📄
6*	1	2,36	153.100	1	080940201
6*	2	2,36	193.000	1	080940202
6*	3	2,36	228.400	1	080940203
6*	4	2,36	263.200	1	080940204
7*	1	3,15	179.600	1	080940221
7*	2	3,15	222.200	1	080940222
7*	3	3,15	264.100	1	080940223
7*	4	3,15	306.700	1	080940224
8*	1	4,25	194.900	1	080940241
8*	2	4,25	244.200	1	080940242
8*	3	4,25	304.200	1	080940243
8	4	4,25	363.400	1	080940244
10*	1	6,7	264.100	1	080940251
10	2	6,7	334.600	1	080940252
10	3	6,7	417.400	1	080940253
10	4	6,7	489.400	1	080940254
13	1	11,2	484.900	1	080940331
13	2	11,2	602.500	1	080940332
13	3	11,2	720.100	1	080940333
13	4	11,2	837.700	1	080940334
16	1	17	884.400	1	080940361
16	2	17	1.056.200	1	080940362
16	3	17	1.228.000	1	080940363
16	4	17	1.399.800	1	080940364
20	2	26,5	2.261.400	1	080940402
20	3	26,5	2.587.000	1	080940403
20	4	26,5	2.912.600	1	080940404

* Műanyag táskában

8096

rögítő emelőheveder
közelítő horgokkal
1 karos lánc, táskában

CE



UNI EN 818-4

MŰSZAKI ADATOK

- Min. biztonsági koefficiens: 4
- Szériaazonosítólap

MELLÉKELT TANÚSÍTVÁNYOK

- Gyártói tanúsítvány UNI EN818-4
- CE-Megfelelőségi nyilatkozat

RENDELKEZÉSRE ÁLLÓ TANÚSÍTVÁNYOK

- Termékleírás

D mm	L m	WLL ton	Ft		
6*	1	1,12	41.600	1	080960001
6*	2	1,12	50.450	1	080960002
6*	3	1,12	59.300	1	080960003
6*	4	1,12	66.350	1	080960004
7*	1	1,5	45.400	1	080960021
7*	2	1,5	56.050	1	080960022
7*	3	1,5	64.550	1	080960023
7*	4	1,5	75.200	1	080960024
8*	1	2	51.300	1	080960041
8*	2	2	63.800	1	080960042
8*	3	2	76.300	1	080960043
8*	4	2	93.350	1	080960044
10*	1	3,15	68.950	1	080960051
10*	2	3,15	91.500	1	080960052
10*	3	3,15	109.500	1	080960053
10*	4	3,15	127.500	1	080960054
13*	1	5,3	111.400	1	080960131
13*	2	5,3	132.000	1	080960132
13*	3	5,3	160.700	1	080960133
13*	4	5,3	198.900	1	080960134
16*	1	8	224.100	1	080960161
16*	2	8	253.500	1	080960162
16*	3	8	296.400	1	080960163
16*	4	8	348.600	1	080960164
20	1	12,5	449.600	1	080960171
20	2	12,5	531.000	1	080960172
20	3	12,5	612.400	1	080960173
20	4	12,5	693.800	1	080960174

*A súly tartalmazza a fakoffer súlyát!

8096SL

emelőlánc,
1 karos, önzáró, kengyeles horgokkal
8. biztonsági fok

CE



UNI EN 818-4

MŰSZAKI ADATOK

- biztonsági együttható: 4
- emelőlánc azonosító

MELLÉKELT TANÚSÍTVÁNYOK

- Gyártói tanúsítvány UNI EN818-4
- CE megfelelési nyilatkozat

RENDELKEZÉSRE ÁLLÓ TANÚSÍTVÁNYOK

- Termékleírás

D mm	L m	WLL ton	Ft		
6*	1	1,12	50.600	1	080960201
6*	2	1,12	59.450	1	080960202
6*	3	1,12	68.300	1	080960203
6*	4	1,12	77.150	1	080960204
7*	1	1,5	56.950	1	080960221
7*	2	1,5	67.600	1	080960222
7*	3	1,5	78.250	1	080960223
7*	4	1,5	88.900	1	080960224
8*	1	2	61.500	1	080960241
8*	2	2	74.000	1	080960242
8*	3	2	86.500	1	080960243
8*	4	2	103.500	1	080960244
10*	1	3,15	83.300	1	080960251
10*	2	3,15	105.900	1	080960252
10*	3	3,15	123.900	1	080960253
10*	4	3,15	141.900	1	080960254
13*	1	5,3	147.600	1	080960331
13*	2	5,3	177.000	1	080960332
13*	3	5,3	205.700	1	080960333
13*	4	5,3	235.100	1	080960334
16*	1	8	278.300	1	080960361
16*	2	8	320.500	1	080960362
16*	3	8	363.500	1	080960363
16*	4	8	402.800	1	080960364
20	1	12,5	635.600	1	080960401
20	2	12,5	717.000	1	080960402
20	3	12,5	798.400	1	080960403
20	4	12,5	879.800	1	080960404

* Műanyag táskában

8097

rögítő emelőheveder
közelítő horgokkal
2 karos lánc, táskában

CE



UNI EN 818-4

MŰSZAKI ADATOK

- Min. biztonsági koefficiens: 4
- Szériaazonosítólap

MELLÉKELT TANÚSÍTVÁNYOK

- Gyártói tanúsítvány UNI EN818-4
- CE-Megfelelőségi nyilatkozat

RENDELKEZÉSRE ÁLLÓ TANÚSÍTVÁNYOK

- Termékleírás

D mm	L m	WLL ton	Ft		
6*	1	1,6	66.650	1	080970001
6*	2	1,6	80.800	1	080970002
6*	3	1,6	102.100	1	080970003
6*	4	1,6	120.800	1	080970004
7*	1	2,12	76.000	1	080970021
7*	2	2,12	97.550	1	080970022
7*	3	2,12	118.900	1	080970023
7*	4	2,12	140.200	1	080970024
8*	1	2,8	86.750	1	080970041
8*	2	2,8	111.300	1	080970042
8*	3	2,8	141.300	1	080970043
8*	4	2,8	166.300	1	080970044
10*	1	4,25	127.500	1	080970051
10*	2	4,25	163.500	1	080970052
10*	3	4,25	198.800	1	080970053
10*	4	4,25	234.800	1	080970054
13*	1	7,5	207.500	1	080970131
13*	2	7,5	266.300	1	080970132
13	3	7,5	316.700	1	080970133
13	4	7,5	375.500	1	080970134
16	1	11,2	402.600	1	080970161
16	2	11,2	488.500	1	080970162
16	3	11,2	574.400	1	080970163
16	4	11,2	660.300	1	080970164
20	2	17,0	950.300	1	080970172
20	3	17,0	1.113.100	1	080970173
20	4	17,0	1.275.900	1	080970174

*A súly tartalmazza a fakoffer súlyát!



8097SL

emelőlánc,
2 karos, önzáró, kengyeles horgokkal
8. biztonsági fok

CE



UNI EN 818-4

MŰSZAKI ADATOK

- biztonsági együttható: 4
- emelőlánc azonosító

MELLÉKELT TANÚSÍTVÁNYOK

- Gyártói tanúsítvány UNI EN818-4
- CE megfelelési nyilatkozat

RENDELKEZÉSRE ÁLLÓ TANÚSÍTVÁNYOK

- Termékleírás

D mm	L m	WLL ton	Ft		
6*	1	1,6	84.650	1	080970201
6*	2	1,6	98.800	1	080970202
6*	3	1,6	120.000	1	080970203
6*	4	1,6	142.300	1	080970204
7*	1	2,12	99.100	1	080970221
7*	2	2,12	120.700	1	080970222
7*	3	2,12	142.000	1	080970223
7*	4	2,12	163.300	1	080970224
8*	1	2,8	107.200	1	080970241
8*	2	2,8	131.700	1	080970242
8*	3	2,8	161.700	1	080970243
8*	4	2,8	186.700	1	080970244
10*	1	4,25	156.200	1	080970251
10*	2	4,25	192.200	1	080970252
10*	3	4,25	227.500	1	080970253
10*	4	4,25	263.500	1	080970254
13*	1	7,5	279.900	1	080970331
13*	2	7,5	338.700	1	080970332
13	3	7,5	406.800	1	080970333
13	4	7,5	447.900	1	080970334
16	1	11,2	536.700	1	080970361
16	2	11,2	622.600	1	080970362
16	3	11,2	708.500	1	080970363
16	4	11,2	768.600	1	080970364
20	2	17,0	1.322.300	1	080970402
20	3	17,0	1.485.100	1	080970403
20	4	17,0	1.647.900	1	080970404

* Műanyag táskában

8098

rögzítő emelőheveder
közelítő horgokkal
4 karos lánc, táskában

CE



UNI EN 818-4

MŰSZAKI ADATOK

- Min. biztonsági koefficiens: 4

- Szériaazonosítólap

MELLÉKELT TANÚSÍTVÁNYOK

- Gyártói tanúsítvány UNI EN818-4

- CE-Megfelelési nyilatkozat

RENDELKEZÉSRE ÁLLÓ TANÚSÍTVÁNYOK

- Termékleírás

D mm	L m	WLL ton	Ft		
6*	1	2,36	139.700	1	080980001
6*	2	2,36	172.600	1	080980002
6*	3	2,36	207.300	1	080980003
6*	4	2,36	242.700	1	080980004
7*	1	3,15	159.400	1	080980021
7*	2	3,15	193.500	1	080980022
7*	3	3,15	235.400	1	080980023
7*	4	3,15	278.000	1	080980024
8*	1	4,25	180.100	1	080980041
8*	2	4,25	229.400	1	080980042
8*	3	4,25	279.400	1	080980043
8	4	4,25	338.600	1	080980044
10*	1	6,7	241.000	1	080980051
10	2	6,7	322.300	1	080980052
10	3	6,7	394.300	1	080980053
10	4	6,7	466.300	1	080980054
13	1	11,2	400.400	1	080980131
13	2	11,2	518.000	1	080980132
13	3	11,2	641.500	1	080980133
13	4	11,2	753.200	1	080980134
16	1	17	808.600	1	080980161
16	2	17	980.400	1	080980162
16	3	17	1.152.200	1	080980163
16	4	17	1.324.000	1	080980164
20	2	26,5	1.899.800	1	080980172
20	3	26,5	2.225.400	1	080980173
20	4	26,5	2.551.000	1	080980174

*A súly tartalmazza a fakoffer súlyát!

8098SL

emelőlánc,
4 karos, önzáró, kengyeles horgokkal
8. biztonsági fok

CE



UNI EN 818-4

MŰSZAKI ADATOK

- biztonsági együttható: 4

- emelőlánc azonosító

MELLÉKELT TANÚSÍTVÁNYOK

- Gyártói tanúsítvány UNI EN818-4

- CE megfelelési nyilatkozat

RENDELKEZÉSRE ÁLLÓ TANÚSÍTVÁNYOK

- Termékleírás

D mm	L m	WLL ton	Ft		
6*	1	2,36	175.700	1	080980201
6*	2	2,36	215.600	1	080980202
6*	3	2,36	243.200	1	080980203
6*	4	2,36	285.700	1	080980204
7*	1	3,15	205.600	1	080980221
7*	2	3,15	239.700	1	080980222
7*	3	3,15	281.600	1	080980223
7*	4	3,15	324.200	1	080980224
8*	1	4,25	230.900	1	080980241
8*	2	4,25	270.200	1	080980242
8	3	4,25	320.200	1	080980243
8*	4	4,25	379.500	1	080980244
10*	1	6,7	298.400	1	080980251
10	2	6,7	379.700	1	080980252
10	3	6,7	451.700	1	080980253
10	4	6,7	523.700	1	080980254
13	1	11,2	545.200	1	080980331
13	2	11,2	662.800	1	080980332
13	3	11,2	786.300	1	080980333
13	4	11,2	898.000	1	080980334
16	1	17	1.033.800	1	080980361
16	2	17	1.205.600	1	080980362
16	3	17	1.377.400	1	080980363
16	4	17	1.540.600	1	080980364
20	2	26,5	2.643.800	1	080980402
20	3	26,5	2.969.400	1	080980403
20	4	26,5	3.295.000	1	080980404

* Műanyag táskában

 **Robur**

 **Robur**

8100

lánc,
nagyzilárdóságú ötvözött acélból

CE

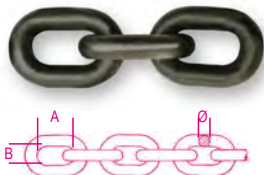

EN 818-2

MŰSZAKI ADATOK

- biztonsági együttható: 4
- hőkezelés: lágyítás
- gyártási sorozatszám

LABORÁTORIUMI ELEMZÉS

- vegyi analízis
- metallográfiai analízis
- szakítópróba

RENDELKEZÉSRE ÁLLÓ TANÚSÍTVÁNYOK

- Termékleírás
- 2.2 UNI EN10204 típusú Tesztjelentés
- EN818-2 Gyártói Tanúsítvány
- EK Megfelelőségi Nyilatkozat

WLL	kg	Ø mm	A mm	B min mm	Ft/m		
1120	6	18	7,8	8.850	1	081000011	
1500	7	21	11,0	10.650	1	081000016	
2000	8	24	12,0	12.500	1	081000020	
3150	10	30	14,5	18.000	1	081000032	
5300	13	39	20,0	29.400	1	081000053	
8000	16	48	20,8	42.950	1	081000080	
12500	20	60	26,0	81.400	1	081000125	

8085R

közösítő emelő láncszem,
nagyzilárdóságú ötvözött acél

CE



EN 1677-4
GRADO 8

MŰSZAKI ADATOK

- biztonsági együttható: 4
- hőkezelés: edzés és lágyítás
- azonosító kód

LABORÁTORIUMI TESZTEK

- kémiai elemzés, metallográfiai elemzés
- terhelhetőségi teszt (WLL x 2,5)
- szakítópróba
- fáradáspróba (min. 20.000 ciklus)

TANÚSÍTVÁNYOK

- Műszaki termékspecifikáció
- Vizsgálati jelentés 2.2 UNI EN10204
- Ellenőrző tanúsítvány 3.1 UNI EN10204
- CE megfelelési nyilatkozat

WLL	kg	Ø mm	A mm	B mm	Ft		
1600	7	110	60	4.220	1	080850215	
2120	8	110	60	5.950	1	080850220	
3150	10	135	75	8.380	1	080850232	
5300	13	160	90	14.100	1	080850253	
8000	16	180	100	30.450	1	080850280	
11200	19	200	110	49.400	1	080850311	
16000	20	260	140	81.250	1	080850316	
17000	22	300	160	115.300	1	080850317	

A munkaterhelés 2 a hevederekkel való használathoz
viszonyítva van.
1 karral. (*) Ø 6-os láncsal kombinálva, WLL= 1120 kg.

8086

hármás közösítő emelő láncszem,
nagyzilárdóságú ötvözött acél

CE



EN 1677-4

MŰSZAKI ADATOK

- Min. biztonsági együttható: 4
- Hőkezelés: díjazás ellenében
- Gyártási száma
- Kémiai elemzés, metallográfiai elemzés
- Terhelhetőségi teszt (WLL x 2,5)
- Szakítópróba
- Fáradáspróba (Min. 20.000 ciklus)
- RENDELKEZÉSRE ÁLLÓ TANÚSÍTVÁNYOK
- Termékleírás
- Vizsgálati jelentés 2.2 UNI EN10204
- Ellenőrzési tanúsítvány 3.1 UNI EN10204
- CE-Megfelelőségi nyilatkozat

WLL	kg	Ø mm	B mm	C mm	Ft		
* 3150	7	135	75	27.150	1	080860021	
4250	8	160	90	41.100	1	080860042	
6700	10	180	100	53.350	1	080860067	
11200	13	200	110	88.450	1	080860100	
17000	16	260	140	127.500	1	080860117	
21200	18	340	180	235.100	1	080860121	
26500	20	350	190	333.400	1	080860126	

A munkaterhelés 3 vagy 4 karos hevederekre vonatkozik.
és a B szög 45°-nál kisebb.
(*) Ø 6 mm-es láncsal kombinálva, WLL= 2360 kg.

8090R

összekötő emelő tag,
nagyzilárdóságú ötvözött acél

CE

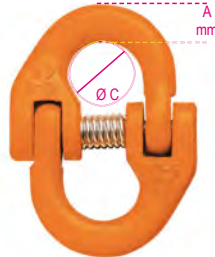

EN 1677-1

MŰSZAKI ADATOK

- Min. biztonsági együttható: 4
- Hőkezelés: díjazás ellenében
- Gyártási száma
- Kémiai elemzés, metallográfiai elemzés
- Terhelhetőségi teszt (WLL x 2,5)
- Szakítópróba
- Fáradáspróba (Min. 20.000 ciklus)
- RENDELKEZÉSRE ÁLLÓ TANÚSÍTVÁNYOK
- Termékspecifikáció
- Vizsgálati jelentés 2.2 UNI EN10204
- Ellenőrzési tanúsítvány 3.1 UNI EN10204
- CE-Megfelelőségi nyilatkozat

WLL	kg	Ø mm	max	A mm	Ft		
1120	6	13	7,5	3.360	1	080900111	
1500	7	18	9	4.500	1	080900115	
2000	8	18	11	5.480	1	080900120	
3150	10	22	13,0	6.600	1	080900131	
5300	13	30	16	13.000	1	080900153	
8000	16	32	22	25.650	1	080900180	
12500	20	40	25	67.500	1	080900312	

8060R

emelőhorog
kengyeles, lánchoz való típus,
nagyzilárdóságú ötvözött acél

CE



EN 1677-2

MŰSZAKI ADATOK

- biztonsági együttható: 4
- hőkezelés: lágyítás
- csap, fül, test sorozatszám
- LABORÁTORIUMI ELEMZÉS
- vegyi analízis, metallográfiai analízis
- vizsgálati terhelés teszt (WLL x 2,5)
- szakítópróba
- fáradáspróba (min. 20.000 ciklus)
- RENDELKEZÉSRE ÁLLÓ TANÚSÍTVÁNYOK
- Termékleírás
- 2.2 UNI EN10204 típusú Tesztjelentés
- 3.1 UNI EN10204 típusú Ellenőrzési tanúsítvány
- EK Megfelelőségi Nyilatkozat

WLL	kg	Ø mm	C mm	Ft		
1120	6	19	7.210	1	080600111	
1500	7	19	7.200	1	080600115	
2000	8	21	8.540	1	080600120	
3150	10	27	14.200	1	080600132	
5300	13	35	21.500	1	080600153	
8000	16	48	70.850	1	080600180	
12500	20	54	126.100	1	080600225	

8058R

emelőhorog
villás önzáró típusú
nagyzilárdóságú ötvözött acél

CE



EN 1677-3

MŰSZAKI ADATOK

- biztonsági együttható: 4
- hőkezelés: lágyítás
- gyártási sorozat száma
- LABORÁTORIUMI ELEMZÉS
- vegyi analízis, metallográfiai analízis
- szakítópróba
- fáradáspróba (min. 20.000 ciklus)
- teszt terhelés (a sorozat 100%-án)
- RENDELKEZÉSRE ÁLLÓ TANÚSÍTVÁNYOK
- Termékleírás
- 2.2 UNI EN10204 típusú Tesztjelentés
- 3.1 UNI EN10204 típusú Ellenőrzési tanúsítvány
- EK Megfelelőségi Nyilatkozat

WLL	kg	Ø mm	J min mm	Ft		
1120	6	28	16.200	1	080580112	
2000	7-8	34	18.750	1	080580120	
3150	10	44	28.550	1	080580132	
5300	13	52	57.700	1	080580153	
8000	16	67	125.000	1	080580180	
12500	20	77	312.100	1	080580225	

8061R

villás közelítő horog
biztosító rögzítőfüllel
nagyszilárdságú ötvöztött acél

CE



EN 1677-1

MŰSZAKI ADATOK

- biztonsági együttható: 4
- hőkezelés: lágyítás
- gyártási sorozat száma

LABORÁTORIUMI ELEMZÉS

- vegyi analízis, metallográfiai analízis
- szakítópróba
- fáradáspróba (min. 20.000 ciklus)
- teszt terhelés (a sorozat 100%-án)

RENDELKEZÉSRE ÁLLÓ TANÚSÍTVÁNYOK

- Termékleírás
- 2.2 UNI EN10204 típusú Tesztjelentés
- 3.1 UNI EN10204 típusú Ellenőrzési tanúsítvány
- EK Megfelelőségi Nyilatkozat

WLL	Ø mm	E	Ft	📄	🏠
1120	6	8	5.640	1	080610211
2000	7-8	11	6.510	1	080610220
3150	10	13	9.480	1	080610231
5300	13	17	16.550	1	080610253
8000	16	20	37.350	1	080610280
12500	20	24	95.600	1	080610312

8052

nagy ellenállású ötvöztött acél emelőhorog
drótkötélhez

CE



EN 1677-2

MŰSZAKI ADATOK

- biztonsági együttható: 4
- hőkezelés: lágyítás
- gyártási sorozat száma

LABORÁTORIUMI ELEMZÉS

- vegyi analízis, metallográfiai analízis
- szakítópróba
- fáradáspróba (min. 20.000 ciklus)
- vizsgálati terhelés teszt (2 x wll)

RENDELKEZÉSRE ÁLLÓ TANÚSÍTVÁNYOK

- Termékleírás
- 2.2 UNI EN10204 típusú Tesztjelentés
- 3.1 UNI EN10204 típusú Ellenőrzési tanúsítvány
- EK Megfelelőségi Nyilatkozat

WLL	C	Ft	📄	🏠	
8052	800	18	2.430	1	080520008
8052	1120	22,5	3.250	1	080520011
8052	2000	30	6.520	1	080520020
8052	3150	36	10.000	1	080520031
8052	4000	39,5	14.100	1	080520040

8055S	5400	32	27.000	1	080550145
8055S	8000	43	47.000	1	080550170
8055S	11500	53	93.450	1	080550215
8055S	16000	58	125.000	1	080550260
8055S	22000	78	287.800	1	080550320

8057R

emelőhorog
füles önzáró típusú
nagyszilárdságú ötvöztött acél

CE

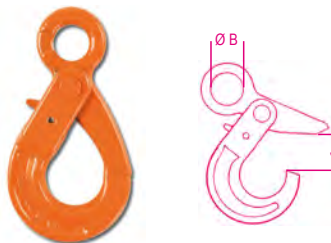

EN 1677-3

MŰSZAKI ADATOK

- biztonsági együttható: 4
- hőkezelés: lágyítás
- gyártási sorozat száma

LABORÁTORIUMI ELEMZÉS

- vegyi analízis, metallográfiai analízis
- szakítópróba
- fáradáspróba (min. 20.000 ciklus)
- teszt terhelés (a sorozat 100%-án)

RENDELKEZÉSRE ÁLLÓ TANÚSÍTVÁNYOK

- Termékleírás
- 2.2 UNI EN10204 típusú Tesztjelentés
- 3.1 UNI EN10204 típusú Ellenőrzési tanúsítvány
- EK Megfelelőségi Nyilatkozat

WLL	Ø mm	J min	ØB	Ft	📄	🏠
1120	6	28	22	10.800	1	080570112
2000	7-8	34	25	13.850	1	080570120
3150	10	44	32	24.950	1	080570132
5300	13	54	40	79.200	1	080570153

8063

emelőhorog
forgatható (terhelés alatt nem)
nagyszilárdságú ötvöztött acél

CE



EN 1677-1

MŰSZAKI ADATOK

- biztonsági együttható: 4
- hőkezelés: lágyítás
- gyártási sorozat száma

LABORÁTORIUMI ELEMZÉS

- vegyi analízis, metallográfiai analízis
- szakítópróba
- fáradáspróba (min. 20.000 ciklus)
- teszt terhelés (a sorozat 100%-án)

RENDELKEZÉSRE ÁLLÓ TANÚSÍTVÁNYOK

- Termékleírás
- 2.2 UNI EN10204 típusú Tesztjelentés
- 3.1 UNI EN10204 típusú Ellenőrzési tanúsítvány
- EK Megfelelőségi Nyilatkozat

WLL	A	E	Ft	📄	🏠
800	32	20,5	5.500	1	080630008
1120	38	20,5	6.950	1	080630011
2000	44,5	22	8.620	1	080630020
3150	44,5	27	10.750	1	080630031

8063SL

önzáró forgóhorog
(nem terhelés alatt)
nagyszilárdságú ötvöztött acél
8. minőségi osztály

CE

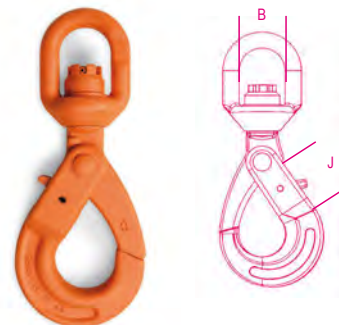

EN 1677-1

MŰSZAKI ADATOK

- biztonsági együttható: 4
- hőkezelés: edzés és lágyítás
- azonosító kód

LABORÁTORIUMI TESZTEK

- kémiai elemzés, metallográfiai elemzés
- szakítópróba
- fáradáspróba (min. 20.000 ciklus)
- terheléspróba (minden egyes darabon)

TANÚSÍTVÁNYOK

- Műszaki termékspecifikáció
- Vizsgálati jelentés 2.2 UNI EN10204
- Ellenőrző tanúsítvány 3.1 UNI EN10204
- CE Megfelelőségi nyilatkozat

WLL	Ø mm	B	J	Ft	📄	🏠
1120	6	32	45	14.550	1	080630311
2000	8	35	59	20.300	1	080630320
3150	10	42	54	35.250	1	080630331
5300	13	49	83	53.850	1	080630353

8064S

állítható emelőhorog
szénacél

CE

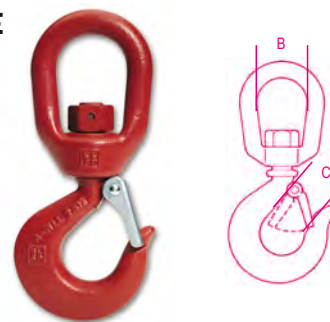

EN 1677-5

MŰSZAKI ADATOK

- Min. biztonsági együttható: 5
- Hőkezelés: díjazás ellenében
- Gyártási száma

LABORELEMZÉSEK

- Kémiai elemzés, metallográfiai elemzés
- Terhelhetőségi teszt (WLL x 2,5)
- Szakítópróba
- Fáradáspróba (Min. 20.000 ciklus)

RENDELKEZÉSRE ÁLLÓ TANÚSÍTVÁNYOK

- Termékleírás
- Vizsgálati jelentés 2.2 UNI EN10204
- Ellenőrzési tanúsítvány 3.1 UNI EN10204
- CE-Megfelelőségi nyilatkozat

WLL	B	C	Ft	📄	🏠
800	31	20	13.400	1	080640107
1000	40	22	17.450	1	080640110
1600	47	23	23.100	1	080640115
2000	47	27	26.300	1	080640120
3200	64	35	46.950	1	080640130
5000	77	43	82.100	1	080640150
7500	90	53	121.300	1	080640175
10000	96	58	208.000	1	080640199

8065SC

terhelés alatt forgó emelőhorog,
csapágyas
szénacél

CE



EN 1677-5

MŰSZAKI ADATOK

- Min. biztonsági koeficiens: 5
- Hőkezelés: díjazás ellenében
- Gyártási száma

LABORELEMZÉSEK

- Kémiai elemzés, metallográfiai elemzés
- Terhelhetőségi teszt (WLL x 2,5)
- Szakítópróba
- Fáradáspróba (Min. 20.000 ciklus)

RENDELKEZÉSRE ÁLLÓ TANÚSÍTVÁNYOK

- Termékleírás
- Vizsgálati jelentés 2.2 UNI EN10204
- Ellenőrzési tanúsítvány 3.1 UNI EN10204
- CE-Megfelelőségi nyilatkozat

WLL kg	B mm	C mm	Ft		
800	38	20	27.550	1	080650107
1000	38	22	29.700	1	080650110
1600	47	23	37.300	1	080650115
2000	47	27	43.500	1	080650120
3200	54	35	78.350	1	080650130
5000	72	43	114.300	1	080650150
7500	82	53	186.200	1	080650175

8062

Szemes horog ötvözött acélból

CE

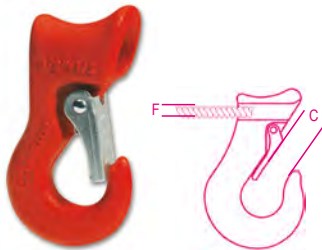

MŰSZAKI ADATOK

- Min. biztonsági koeficiens: 5
- Hőkezelés: díjazás ellenében
- Gyártási száma

LABORELEMZÉSEK

- Kémiai elemzés, metallográfiai elemzés
- Terhelhetőségi teszt (WLL x 2,5)
- Szakítópróba

RENDELKEZÉSRE ÁLLÓ TANÚSÍTVÁNYOK

- Termékleírás
- Vizsgálati jelentés 2.2 UNI EN10204
- Ellenőrzési tanúsítvány 3.1 UNI EN10204
- CE-Megfelelőségi nyilatkozat

WLL kg	C mm	F mm	Ft		
1500	19	10-13	16.700	1	080620013
2000	21	16	22.550	1	080620016
3000	26	18	40.850	1	080620018
5000	34	22-25	55.500	1	080620025

8051S

füles emelőhorog
szénacél
horganyzott

CE



GRADO 4

MŰSZAKI ADATOK

- Min. biztonsági koeficiens: 4
- Hőkezelés: normál hőkezelés
- Gyártási száma

LABORELEMZÉSEK

- Kémiai elemzés
- Metallográfiai elemzés
- Szakítópróba

RENDELKEZÉSRE ÁLLÓ TANÚSÍTVÁNYOK

- Termékleírás
- Vizsgálati jelentés 2.2 UNI EN10204
- Ellenőrzési tanúsítvány 3.1 UNI EN10204
- CE-Megfelelőségi nyilatkozat

WLL kg	C mm	F mm	Ft		
250	14	12	1.190	10	080510202
500	18	16,5	2.600	5	080510205

Különleges csomagolások szabad
szolgáltatáshoz



WLL kg		Ft		
250	1	1.730	1	080519202
500	1	3.350	1	080519205

8135

acéllemez megfogó
csuklós fülescsavarral

CE



EN13155

MŰSZAKI ADATOK

- Biztonsági együtttható: 3
- Sorozatszám azonosító tábla
- Gyártói tanúsítvány
- CE megfelelési nyilatkozat
- Vizsgálati jelentés 2.2 UNI EN10204
- Műszaki termékspecifikáció

WLL t	A mm	kg	Ft		
0,75	0-15	2	46.650	1	081350005
1,0	0-20	5	62.400	1	081350010
2,0	0-25	8	88.950	1	081350020
3,0	0-30	15	146.200	1	081350032
5,0	0-50	23	209.800	1	081350050

8143

kézi láncos emelő

CE



EN13157

WLL t	L mm	H mm	sforzo / effort kg	Ft	
0,5	3	285	27	81.700	1 081430005
1	3	315	44	97.150	1 081430010
2	3	380	44	141.100	1 081430020
3	3	475	45	181.800	1 081430030
5	3	600	47	272.300	1 081430050

0,5	6	285	27	113.300	1 081430105
1	6	315	44	127.200	1 081430110
2	6	380	44	179.200	1 081430120
3	6	475	45	255.400	1 081430130
5	6	600	47	362.400	1 081430150

Robur

8146

karos láncos emelő

CE



H

EN13157

WLL	t	L m	H mm	sforzo / effort	kg	Ft	📦	🚚
0,75	1,5	320	21*		101.200	1	081460008	
1,5	1,5	380	41*		147.200	1	081460015	
3,0	1,5	480	41		191.100	1	081460030	
6,0	1,5	600	46		309.600	1	081460060	

0,75	3,0	320	21*		103.100	1	081460108	
1,5	3,0	380	41*		145.900	1	081460115	
3,0	3,0	480	41		201.600	1	081460130	
6,0	3,0	600	46		341.000	1	081460160	

Robur

Robur

8146C

Kompakt karos láncos emelő

CE

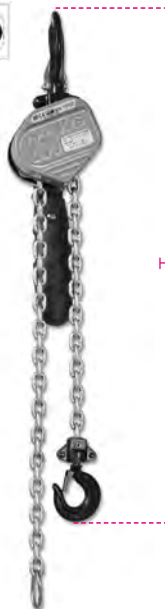

H

EN13157

WLL	t	L m	H mm	sforzo / effort	kg	Ft	📦	🚚
0,25	1,5	230	20,7		92.450	1	081460002	

8149S/A

emelőlánc taska,
fekete szövetből



A	C	8143	8143	Ft	📦	🚚
mm	mm	t	L m			
100	250	0,5 - 1	3/6 - 3/6	9.330	1	081490510
120	350	2 - 3	3/6 - 3	10.200	1	081490512
150	450	3 - 5	6 - 3/6	11.000	1	081490515

8147C

lácós haladómű

kézi emelőkhöz

tartógerendákhoz (INP, IPB, IPE, HEA, HEB, stb.) alkalmas

CE



EN 13157

Műszaki adatok:

- Biztonsági együttható: 4
- Azonosító címke

Tanúsítványok:

- Gyártói tanúsítvány
- CE Megfelelőségi nyilatkozat
- Vizsgálati jelentés 2.2 UNI EN10204
- Műszaki termékspecifikáció

WLL	L min	L max	📏	Ft	📦	🚚
t	mm	mm	Lm			
1,0	58	220	3	100.900	1	081470510
2,0	66	220	3	129.100	1	081470520
3,0	74	220	3	197.600	1	081470530
5,0	90	220	3	272.400	1	081470550

A terméket szétszedett állapotban szállítjuk és használat előtt a használati útmutatónak megfelelően kell összeszerelni.

8147S

haladómű

kézi gerendafogókhoz

tartógerendákhoz (INP, IPB, IPE, HEA, HEB, stb.) alkalmas

CE



EN 13157

Műszaki adatok:

- Biztonsági együttható: 4
- Azonosító címke

Tanúsítványok:

- Gyártói tanúsítvány
- CE Megfelelőségi nyilatkozat
- Vizsgálati jelentés 2.2 UNI EN10204
- Műszaki termékspecifikáció

WLL	L min	L max	øF	Ft	📦	🚚
t	mm	mm	mm			
0,5	50	220	25	64.900	1	081470005
1,0	58	220	30	83.250	1	081470010
2,0	66	220	40	105.700	1	081470020

A terméket szétszedett állapotban szállítjuk és használat előtt a használati útmutatónak megfelelően kell összeszerelni.

Robur

8147P

gerendafogó kézi emelőkhöz

tartógerendákhoz (INP, IPB, IPE, HEA, HEB, stb.) alkalmas

CE

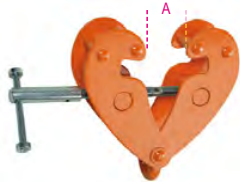

EN 13157

Műszaki adatok:

- Biztonsági együttható: 4
- Azonosító címke

Tanúsítványok:

- Gyártói tanúsítvány
- CE Megfeleléségi nyilatkozat
- Vizsgálati jelentés 2.2 UNI EN10204
- Műszaki termékspecifikáció

WLL t	A min mm	A max mm	Ft		
1,0	90	180	41.800	1	081470210
2,0	90	190	50.500	1	081470220
3,0	85	280	85.300	1	081470230
5,0	85	280	124.500	1	081470250

8148

kézi csőrő,
alumíniumtövezet test,
csőrőkarral, drótkötéssel és horoggal szállítva

Az EN 13517 szabványnak megfelelő, kiemelkedő minőségű anyagból készült könnyű, hordozható Robur karos kézi csőrő terhek emelésére, húzására, megfeszítésére és rögzítésére bármilyen irányban egyaránt alkalmas.

Stabil rögzítési ponthoz köve a terhek pontos elhelyezését teszi lehetővé és minden irányban – függőlegesen, vízszintesen és ferdén – biztonságos munkavégzést biztosít. Kompakt, praktikus kialakításának köszönhetően felszerelése és használata egyszerű.

A Robur kézi csőrő tetszőleges hosszúságú drótkötéssel használható, a referencia szabványnak megfelelően kiegészítő kampós csigákkal – a csőrőház vizsgálatával mellett – a teherbírása 2-, 3-, 4-, vagy akár többszörösére is növelhető.

CE



EN 13157

• Biztonsági együttható: 4:1

WLL t	L m	A mm	Ft		
0,8	20	426	137.000	1	081480008
1,6	20	545	214.800	1	081480016
3,2	20	660	356.000	1	081480032
0,8	30	426	151.800	1	081480108
1,6	30	545	237.200	1	081480116
3,2	30	660	397.300	1	081480132



8148F

galvanizált acélsodrony kötél
keresztarabon
nagyzilárdságú horoggal

CE



WLL t	L m	ØF	Ft		
0,8	20	8,3	39.700	1	081480520
1,6	20	11	62.700	1	081480521
3,2	20	16	122.100	1	081480523

0,8	30	8,3	54.500	1	081480530
1,6	30	11	85.100	1	081480531
3,2	30	16	163.400	1	081480533

8120

oldalthegecszett lánc
statikus csatlakozásokhoz
horganyzott



MŰSZAKI ADATOK

- biztonsági együttható: 4
- RENDELKEZÉSRE ÁLLÓ TANÚSÍTVÁNYOK
- Termékleírás
- 2.2 UNI EN10204 típusú Tesztjelentés

Ø mm	nr	WFL kg	m	Ft		
1,5	10	8	150	83.000	1	081200015
1,6	12	15	150	78.950	1	081200016
2,2	14	25	75	46.500	1	081200022
2,7	16	40	75	57.350	1	081200027
3,0	17	55	75	63.700	1	081200030
3,4	18	100	60	63.100	1	081200034
3,8	19	110	50	70.300	1	081200038
4,4	20	200	40	57.750	1	081200044
4,8	21	250	30	53.200	1	081200048
5,5	22	300	25	53.200	1	081200055
5,8	23	310	25	60.150	1	081200058
6,5	24	400	25	68.700	1	081200065
7,0	25	450	25	95.650	1	081200070
7,5	26	550	20	74.950	1	081200075
* 8,0	27	600	25	148.700	1	081200080
* 9,0	28	800	25	145.700	1	081200090
* 10,0	30	1000	20	190.400	1	081200100
* 12,0	32	1400	15	200.600	1	081200120

Figyelem: a termék NEM alkalmazható emeléshez

(*) TEKERCSSEK kiegészítésben

8120B

oldalthegecszett lánc
statikus csatlakozásokhoz,
horganyzott



MŰSZAKI ADATOK

- biztonsági együttható: 4
- RENDELKEZÉSRE ÁLLÓ TANÚSÍTVÁNYOK
- Termékleírás
- 2.2 UNI EN10204 típusú Tesztjelentés

Ø mm	nr	WFL kg	m	Ft		
1,5	10	8	200	105.700	1	081200315
1,6	12	15	200	111.900	1	081200316
2,2	14	25	100	65.250	1	081200322
2,7	16	40	100	83.400	1	081200327
3,0	17	55	75	70.450	1	081200330
3,4	18	100	100	110.200	1	081200334
3,8	19	110	75	98.250	1	081200338
4,4	20	200	50	75.050	1	081200344
4,8	21	250	50	98.250	1	081200348
5,5	22	300	40	91.550	1	081200355
5,8	23	310	30	79.550	1	081200358
6,5	24	400	30	90.800	1	081200365
7,0	25	450	25	104.800	1	081200370
7,5	26	550	25	100.900	1	081200375
8,0	27	600	15	77.750	1	081200380
9,0	28	800	15	91.800	1	081200390
10,0	30	1000	10	75.200	1	081200400
12,0	32	1400	8	86.900	1	081200420

Figyelem: a termék NEM alkalmas emeléshez

8120D

kalibrált láncok DIN766
galvanikusan horganyzott
kérésre bármilyen méretben kapható (>30m)



MŰSZAKI ADATOK

- biztonsági együttható: 4
- TANÚSÍTVÁNYOK
- Műszaki termékspecifikáció
- Vizsgálati jelentés 2.2 UNI EN10204

Ø mm	P mm	WFL kg	m	Ft		
4	16	200	30	52.150	1	081200640
5	18,5	320	30	73.600	1	081200650
6	18,5	400	30	111.500	1	081200660
7	22	630	30	134.000	1	081200670
8	24	800	30	177.200	1	081200680
10	28	1250	30	270.500	1	081200700

kalibrált láncok DIN766
tűzhorganyzott

Ø mm	P mm	WFL kg	m	Ft		
4	16	200	30	64.900	1	081200840
5	18,5	320	30	88.850	1	081200850
6	18,5	400	30	131.900	1	081200860
7	22	630	30	154.800	1	081200870
8	24	800	30	205.600	1	081200880
10	28	1250	30	311.300	1	081200900



8129

zárlánc,
vörösre és fehérre festett horganyzott fémből



Ø mm	m	Ft		
5	30	109.600	1	081290050

Figyelem: a termék NEM használható emeléshez vagy rögzítéshez

8074

Karabiner horgok, galvanizált,
lakkozott

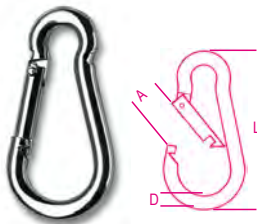

DIN 5299

MŰSZAKI ADATOK

- Min. biztonsági együttható: 4
- RENDELKEZÉSRE ÁLLÓ TANÚSÍTVÁNYOK
- Termékleírás
- Vizsgálati jelentés 2.2 UNI EN10204

DxL mm	A mm	WFL kg	Ft		
* 4x40	6	20	225	100	080740040
5x50	7	30	235	100	080740050
6x60	8	40	265	100	080740060
7x70	9	60	375	50	080740070
8x80	11	75	410	50	080740080
9x90	12	100	550	25	080740090
10x100	13	120	765	25	080740100
11x120	16	140	1.000	20	080740101
12x140	22	140	1.410	15	080740102
13x160	24	200	1.960	10	080740103
* 14x180	32	250	4.060	5	080740104

8074A

gyűrűs karabiner, galvanizált



DIN 5299

MŰSZAKI ADATOK

- Min. biztonsági együttható: 4
- RENDELKEZÉSRE ÁLLÓ TANÚSÍTVÁNYOK
- Termékleírás
- Vizsgálati jelentés 2.2 UNI EN10204

ØAxL mm	D mm	WFL kg	Ft		
5x50	7,4	30	330	50	080740405
6x60	8,7	40	395	50	080740406
8x80	10,5	75	590	25	080740408
10x100	13,3	120	1.070	10	080740410

8074G

Karabiner horg anyával, galvanizált

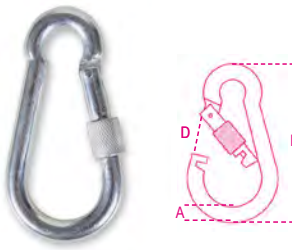

MŰSZAKI ADATOK

- Min. biztonsági együttható: 4
- RENDELKEZÉSRE ÁLLÓ TANÚSÍTVÁNYOK
- Termékleírás
- Vizsgálati jelentés 2.2 UNI EN10204

ØAxL mm	D mm	WFL kg	Ft		
5x50	7,5	30	385	50	080740305
6x60	8,5	40	430	50	080740306
8x80	10,3	75	645	25	080740308
10x100	10,6	120	1.080	10	080740310

8080

Gyorscsatlakozó szem, galvanizált



MŰSZAKI ADATOK

- Min. biztonsági együttható: 4
- RENDELKEZÉSRE ÁLLÓ TANÚSÍTVÁNYOK
- Termékleírás
- Vizsgálati jelentés 2.2 UNI EN10204

DxL mm	A mm	WFL kg	Ft		
3,5x36	5	20	220	100	080800003
4x40	6	30	240	100	080800004
5x49	6	50	235	100	080800005
6x57	8	60	340	100	080800006
7x66	8	100	415	50	080800007
8x74	11	140	515	50	080800008
9x80	11	160	710	25	080800009
10x89	11	220	835	25	080800010
12x105	15	300	1.520	20	080800012
14x125	16,5	400	3.070	3	080800014

8080FM

összekötő elem,
galvanizált

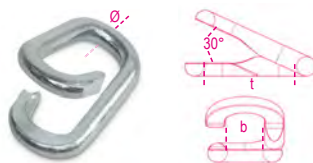

MŰSZAKI ADATOK

- biztonsági együttható: 4
- TANÚSÍTVÁNYOK
- Műszaki termékspecifikáció
- Vizsgálati jelentés 2.2 UNI EN10204

M	Ød mm	b mm	t mm	Ft		
4	3,8	8,6	21,5	165	100	080800204
5	4,7	11,1	25,8	270	50	080800205
6	5,3	13,8	32,0	505	30	080800206
7	6,5	16,8	37,0	615	10	080800207
8	8,0	18,0	38,0	900	10	080800208

8082

Gyűrű
horganyzott acél

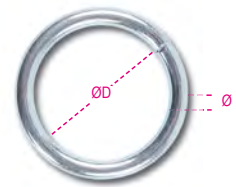

Ø mm	ØD mm	WFL kg	Ft		
4	20	75	155	50	080820004
5	30	125	225	20	080820005
6	40	185	360	10	080820006
7	50	265	590	5	080820007
8	60	350	790	5	080820008

8083

"S" horg
horganyzott acél

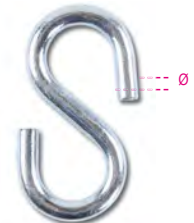

Ø mm	L mm	WFL kg	Ft		
3	33	4	40	100	080830003
4	40	5	65	60	080830004
5	47	12	105	50	080830005
6	59	18	170	30	080830006
8	79	33	470	10	080830008

8114

nyújtott forgószem,
galvanizált

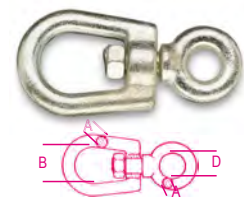

MŰSZAKI ADATOK

- biztonsági együttható: 4
- azonosító kód
- LABORATÓRIUMI TESZTEK
- szakítópróba
- TANÚSÍTVÁNYOK
- Műszaki termékspecifikáció
- Vizsgálati jelentés 2.2 UNI EN10204
- Ellenőrző tanúsítvány 3.1 UNI EN10204

A mm	B mm	D mm	WFL kg	Ft		
8	30	16	250	1.680	10	081140008
10	38	18	300	2.920	10	081140010
12	42	20	650	4.320	5	081140012
14	48	22	820	6.510	5	081140014
16	57	24	1000	9.050	3	081140016
18	64	26	1600	10.850	3	081140018
20	72	30	2000	14.950	1	081140020
22	80	34	2500	20.850	1	081140022

8116

kétoldali nyújtott forgószem,
galvanizált

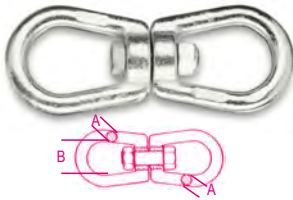

MŰSZAKI ADATOK

- biztonsági együttható: 4
- azonosító kód

LABORATÓRIUMI TESZTEK

- szakítópróba

TANÚSÍTVÁNYOK

- Műszaki termékspecifikáció
- Vizsgálati jelentés 2.2 UNI EN10204
- Ellenőrző tanúsítvány 3.1 UNI EN10204

A mm	B mm	WFL kg	Ft		
6	23	140	1.840	10	081160006
8	30	250	2.310	10	081160008
10	38	300	4.080	5	081160010
12	42	650	6.610	5	081160012
14	48	820	9.900	3	081160014
16	57	1000	12.200	3	081160016
18	64	1600	14.850	1	081160018
20	72	2000	21.300	1	081160020
22	80	2500	33.200	1	081160022

8317SZ

Drótkötélgyely, horganyzott



RENDELKEZÉSRE ÁLLÓ TANÚSÍTVÁNYOK

- Vizsgálati jelentés 2.2 UNI EN10204

Ø mm	L mm	L1 mm	Ft		
2	15	14	85	100	083170102
3	18	16	85	100	083170103
4	20	19	145	100	083170104
5	24	23	145	50	083170105
6	30	27	200	30	083170106
8	36	34	375	20	083170108
10	42	37	545	10	083170110

8317DZ

Dupla drótkötélgyely, horganyzott



RENDELKEZÉSRE ÁLLÓ TANÚSÍTVÁNYOK

- Vizsgálati jelentés 2.2 UNI EN10204

Ø mm	L mm	L1 mm	Ft		
2	30	14	135	50	083170002
3	35	15	175	50	083170003
4	40	18	220	50	083170004
5	50	21	280	25	083170005
6	60	25	340	20	083170006
8	76	33	720	10	083170008
10	95	37	1.070	10	083170010

8381SL

U csőbilincs, könnyített kivitel,
galvanizált

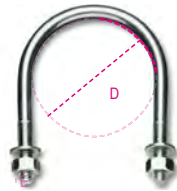

RENDELKEZÉSRE ÁLLÓ TANÚSÍTVÁNYOK

- Termékleírás
- Vizsgálati jelentés 2.2 UNI EN10204

D mm	D gas	E mm	Ft		
11	1/8"	M6	205	100	083810201
14	1/4"	M6	245	100	083810202
18	3/8"	M6	245	100	083810203
22	1/2"	M6	275	100	083810204
27	3/4"	M6	275	100	083810205
34	1"	M6	300	100	083810206
43	1 1/4"	M6	300	100	083810207
49	1 1/2"	M8	550	50	083810208
61	2"	M8	540	50	083810209
77	2 1/2"	M8	680	25	083810210
89	3"	M8	750	25	083810211
102	3 1/2"	M8	850	25	083810212
115	4"	M8	920	25	083810213
140	5"	M8	2.040	25	083810215
168	6"	M10	2.260	25	083810218
220	8"	M10	3.880	10	083810220

8381SP

U csőbilincs erősített kivitel,
galvanizált

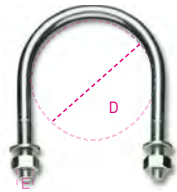

RENDELKEZÉSRE ÁLLÓ TANÚSÍTVÁNYOK

- Termékleírás
- Vizsgálati jelentés 2.2 UNI EN10204

D mm	D gas	E mm	Ft		
22	1/2"	M8	390	100	083810301
27	3/4"	M8	420	100	083810302
34	1"	M8	475	100	083810303
43	1 1/4"	M8	495	100	083810304
49	1 1/2"	M10	775	25	083810305
61	2"	M10	850	25	083810306
77	2 1/2"	M10	945	25	083810307
89	3"	M10	1.010	25	083810308
102	3 1/2"	M12	1.550	25	083810309
115	4"	M12	1.690	15	083810310
140	5"	M12	3.170	15	083810312
168	6"	M16	4.810	15	083810315
220	8"	M16	7.480	10	083810320
274	10"	M16	8.310	1	083810374
274	10"	M20	9.920	1	083810375
324	12"	M20	25.850	1	083810386
408	16"	M24	32.300	1	083810508

8383C

négyszögű csőbilincs
tűzhorganyzott
Peremes anyák

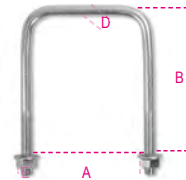

RENDELKEZÉSRE ÁLLÓ TANÚSÍTVÁNYOK

- Termékleírás
- 2.2 UNI EN10204 típusú Tesztjelentés

A mm	E mm	B mm	D mm	Ft		
70	M10	110	8,55	820	130	083830070
80	M10	120	8,55	935	110	083830080
90	M10	130	8,55	1.000	100	083830090
100	M10	155	8,55	1.190	90	083830100
120	M10	175	8,55	1.350	70	083830120

8383P

Alátétel a négyszögű csőbilincshez,
horganyzott

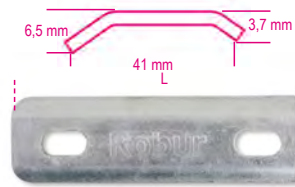

RENDELKEZÉSRE ÁLLÓ TANÚSÍTVÁNYOK

- Termékleírás
- Vizsgálati jelentés 2.2 UNI EN10204

	L mm	Ft		
8383P 150	150	990	150	083830214
8383C/70-80				
/90-100				
8383P 170	170	1.140	120	083830217
8383C/100-120				

8515Z

Drótfeszítő, horganyzott



D mm	H mm	L mm	Ft		
20	25	93	515	50	085150002
24,5	30	100	665	50	085150003

8515V

Drótfeszítő, horganyzott és lakkozott



D mm	H mm	L mm	Ft		
20	25	93	630	50	085150102
24,5	30	100	840	50	085150103

8515CH

drótfeszítő,
horganyzott



L mm	OA mm	OB mm	Ft	📦	🏠
90	8	7,5	270	20	085150901

8531

Egyenes kengyel, horganyzott

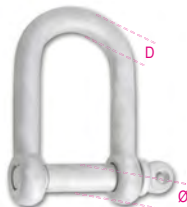

RENDELKEZÉSRE ÁLLÓ TANÚSÍTVÁNYOK

• Vizsgálati jelentés 2.2 UNI EN10204

Ø mm	D mm	WFL kg	Ft	📦	🏠
20	18	1600	7.160	1	085310018
22	20	2500	10.450	1	085310020

8532

Egyenes kengyel, fekete, lakkozott

Négyszögű csapszeg



RENDELKEZÉSRE ÁLLÓ TANÚSÍTVÁNYOK

• Vizsgálati jelentés 2.2 UNI EN10204

Ø mm	D mm	WFL kg	Ft	📦	🏠
20	20	1600	3.610	1	085320020
22	22	2500	5.410	1	085320022

8535

Szemes horog, horganyzott

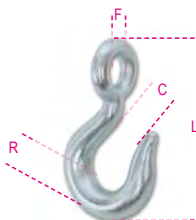

RENDELKEZÉSRE ÁLLÓ TANÚSÍTVÁNYOK

• Vizsgálati jelentés 2.2 UNI EN10204

R mm	C mm	F mm	L mm	Ft	📦	🏠
26	27,5	34	156	8.230	1	085350006
30	36,5	40	185	11.350	1	085350007

8130

lopásvédő lánc ötvözt acélból
edzett és lágyított
horganyzott



Ø mm	L mm	Ft	📦	🏠
6	800	5.970	1	081300068
8	1000	13.000	1	081300081
8	1200	14.400	1	081300082
10	1500	21.950	1	081300105

8130A

lopásgátló lánc gyűrűvel
ötvözt, edzett és lágyított acél
horganyzott



Ø mm	L mm	Ft	📦	🏠
10	900	20.050	1	081300209

8131Z

lopásvédő lánc lakattal



Ø mm	L mm	8139Z Ø mm	Ft	📦	🏠
6	800	8	29.750	1	081310060

8131DL

féktárcsaszár 8130A lopásgátló láncsal



Ø mm	L mm	Ft	📦	🏠
10	900	44.600	1	081310209

8139DL

motorkerékpár féktárcsa reteszelő lakat
edzett acél, ütészédő PVC
bliszteres csomagolás

- 3 db kulccsal, jelzővezetékekkel, tokkal szállítva
- 10 mm láncokhoz használható



Ø mm	L mm	H mm	Ft	📦	🏠
14	108	56	24.550	1	081390214

8139Z

Lakat lopásvédő lánchoz,
cinkötvözetest

- 3 db tollas kulccsal szállítva
- 6, 8, 10 mm-es láncokhoz használható



Ø mm	L mm	H mm	Ft	📦	🏠
8	45	90	23.800	1	081390008

8139ZCH

3 db nyerskulcs
8139Z lakatokhoz



8139ZCH	Ft	📦	🏠
	10.100	1	081390909

Ø8 és Ø10 lakatokhoz használható

8050 D1÷D45

biztosítóelem készlet emelőhorgokhoz



	Ft	📦	🏠
8050D1 8064S-8065SC/800 8055S/1250	4.520	1	080500945
8050D2 8064S-8065SC/1000-8062/1500- 8055S/1600	4.090	1	080500946
8050D3 8064S-8065SC/1600-2000 8055S/2500-3200	4.400	1	080500947
8050D4 8064S-8065SC/3200 8055S/5400	7.150	1	080500948
8050D5 8064S-8065SC/5000 8055S/8000	8.130	1	080500949

8050D6	12.700	1	080500950
8064S/7500			
8055S/11500			
8050D11	7.240	1	080500955
8062/2000			
8050D12	7.850	1	080500956
8062/3000			
8050D13	14.300	1	080500957
8062/5000			
8050D22	17.900	1	080500966
8064S/10000			
8055S/16000			
8050D23	24.650	1	080500967
8055S/22000			
8050D24	280	1	080500969
8051S/250			
8050D25	380	1	080500970
8051S/500			
8050D30	8.820	1	080500975
8061F/8000			
8050D32	12.900	1	080500977
8060/8000			
8050D33	1.180	1	080500978
8052/800			
8050D34	1.320	1	080500979
8052/1120			
8050D35	1.660	1	080500980
8052/2000			
8050D36	1.760	1	080500981
8052/3150			
8050D37	2.030	1	080500982
8052/4000			
8050D38	760	1	080500983
8060R/1120			
8050D53	1.150	1	080500994
8060R/1500			
8050D39	1.030	1	080500984
8060R/2000			
8050D40	1.790	1	080500985
8060R/3150			
8050D41	2.820	1	080500986
8060R/5300			
8050D42	275	1	080500987
8063/800			
8050D43	400	1	080500988
8063/1120			
8050D44	505	1	080500989
8063/2000			
8050D45	635	1	080500990
8063/3150			



8050D46	790	1	080500991
8061R/1120			
8050D47	790	1	080500992
8061R/2000			
8050D48	1.130	1	080500993
8061R/3150			
8050D54	1.240	1	080500995
8061R/5300			



8050 D49	2.610	1	080500849
8057R - 8058R - 8063SL /1120			
8050 D50	2.860	1	080500850
8057R - 8058R - 8063SL /2000			
8050 D51	3.130	1	080500851
8057R - 8058R - 8063SL /3150			
8050 D52	6.960	1	080500852
8057R - 8058R - 8063SL /5300			

8058R/PS

csapszeg készlet 8058R-8061R horgokhoz



	Ø mm	Ft		
8058R/PS	6	2.920	1	080580512
8058R/PS	7-8	3.370	1	080580520
8058R/PS	10	6.670	1	080580532
8058R/PS	13	11.600	1	080580553

8060R/PS

csapszeg készlet 8060R horgokhoz



	Ø mm	Ft		
8060R/PS	6	3.020	1	080600511
8060R/PS	7	3.460	1	080600515
8060R/PS	8	3.460	1	080600520
8060R/PS	10	6.840	1	080600532
8060R/PS	13	11.950	1	080600553

8135/KLA1

működtető kar készlet a 8135 megfogóhoz



8135 t	Ft		
0,75	6.020	1	081350605
1,00	7.450	1	081350610
2,00	8.630	1	081350615
3,00	10.400	1	081350620
5,00	16.100	1	081350625

A javításokért a felelősség a szerelőt terheli.

8135/KCA

javítókészlet a 8135 megfogóhoz



8135 t	Ft		
0,75	5.030	1	081350630
1,00	5.670	1	081350635
2,00	7.300	1	081350640
3,00	9.080	1	081350645
5,00	11.900	1	081350650

A javításokért a felelősség a szerelőt terheli.

8135/KMO

rugókészlet a 8135 megfogóhoz



8135 t	Ft		
0,75	2.670	1	081350655
1,00	3.860	1	081350660
2,00	5.070	1	081350665
3,00	6.510	1	081350670
5,00	9.650	1	081350675

A javításokért a felelősség a szerelőt terheli.

8135/KGF

fix pofa készlet

A javításokért a felelősség a szerelőt terheli.



8135 t	Ft		
0,75	10.050	1	081350705
1,00	17.300	1	081350710
2,00	20.900	1	081350720
3,00	27.200	1	081350730
5,00	32.550	1	081350750

8135/KGM

mozgó pofa készlet

A javításokért a felelősség a szerelőt terheli.



8135 t	Ft		
0,75	32.900	1	081350805
1,00	52.900	1	081350810
2,00	68.150	1	081350820
3,00	100.100	1	081350830
5,00	143.600	1	081350850

8143/RKL

kiakadástgátlós felső és alsó horog készlet a 8143 kézi, láncos emelőhöz



8143 WLL t	Ft		
0,5	545	1	081430500
1,0	630	1	081430501
2,0	940	1	081430502
3,0	1.100	1	081430503
5,0	1.290	1	081430504

8143/RPC

horog csap készlet a 8143 kézi, láncos emelőhöz



8143 WLL t	Ft		
0,5	650	1	081430510
1,0	895	1	081430511
2,0	960	1	081430512
3,0	1.570	1	081430513
5,0	1.710	1	081430514

 **Robur**

8143/RPF

zár készlet
a 8143 kézi, láncos emelőhöz



8143 WLL t	Ft		
0,5	295	1	081430520
1,0	320	1	081430521
2,0	445	1	081430522
3,0	355	1	081430523
5,0	545	1	081430524

8143/RKCI

alsó horog készlet
a 8143 kézi, láncos emelőhöz



8143 WLL t	Ft		
0,5	4.170	1	081430560
1,0	5.490	1	081430561
2,0	10.200	1	081430562
3,0	33.500	1	081430563
5,0	46.150	1	081430564

8146/RK

biztosítóelemek, csapok és zárok
a 8146C-8146 kézi KAROS láncos emelőkhöz



8146C-8146 WLL t	Ft		
0,25	2.220	1	081460902

8146/RKL

kiakadástgátló felső és alsó horoghoz
a 8146 kézi, láncos emelőhöz



8146 WLL t	Ft		
0,75	630	1	081460500
1,5	720	1	081460501
3,0	1.100	1	081460502
6,0	1.260	1	081460503

8146/RPC

horog csap készlet
a 8146 kézi, láncos emelőhöz



8146 WLL t	Ft		
0,75	650	1	081460510
1,5	960	1	081460511
3,0	1.010	1	081460512
6,0	1.010	1	081460513

8146/RKFC

zár készlet
a 8146 kézi, láncos emelőhöz



8146 WLL t	Ft		
0,75	1.730	1	081460520
1,5	2.200	1	081460521
3,0	2.350	1	081460522
6,0	2.770	1	081460523

8146/RKCI

alsó horog készlet
a 8146 kézi, láncos emelőhöz



8146 WLL t	Ft		
0,75	4.770	1	081460560
1,5	10.200	1	081460561
3,0	33.500	1	081460562
6,0	63.350	1	081460563

8148/RA

keresztcsap a 8148 kézi csörlőben használt
drótkötelekhez



8148 t	Ft		
0,8	7.610	1	081480900
1,6	10.200	1	081480901
3,2	13.250	1	081480902

8148/RKS

3 darabos biztonsági csapseg készlet
a 8148 kézi csörlőkhöz



8148 t	Ft		
0,8	1.410	1	081480903
1,6 - 3,2	1.760	1	081480904

8148/RKCM

2 darabos markolatvédő készlet
a 8148 kézi csörlőkhöz



8148/RKCM	Ft		
	645	1	081480905

8148/RKCL

2 darabos emelőrúd védő készlet
a 8148 kézi csörlőkhöz



8148/RKCL	Ft		
	680	1	081480906

8148/RP

horgonycsapok
a 8148 kézi csörlőkhöz



8148 t	Ft		
0,8	5.830	1	081480907
1,6	7.840	1	081480908
3,2	9.840	1	081480909

8148/RKG

2 darabos védőburkolat készlet
a 8148 kézi csörlőkhöz



8148 t	Ft		
0,8	6.020	1	081480910
1,6	6.860	1	081480911
3,2	7.230	1	081480912

8149

lánc

CE

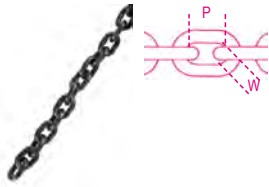

EN 818-7

MŰSZAKI ADATOK

- biztonsági együttható: 4
- hőkezelés: lágyítás
- gyártási sorozatszám

LABORATÓRIUMI ELEMZÉS

- vegyi analízis
- metallográfiai analízis
- szakítópróba

RENDELKEZÉSRE ÁLLÓ TANÚSÍTVÁNYOK

- Termékleírás
- 2.2 UNI EN10204 típusú Tesztjelentés
- EK Megfelelőségi Nyilatkozat

Ø mm	WLL Kg	P mm	W min	Ft/m		
4	500	12	4,8	5.300	1	081490012
5	800	15	6,0	6.460	1	081490015
6	1100	18	7,2	7.410	1	081490018
6,3	1200	19	7,6	8.060	1	081490019
8	2000	24	9,6	10.800	1	081490024
10	3200	30	12	17.150	1	081490030

8149CM

lánc a 8143 kézi láncos emelőhöz



Ø mm	B mm	t mm	Ft/m		
4,8	8,2	22,2	1.860	1	081490901

* FIGYELEM: Amennyiben a rendelésben másképp nem szerepel, a terméket egy hosszúságú láncsal szállítjuk!

8149CM/RA

tartalék hegesztett gyűrű

lánc a 8143 kézi, láncos emelőhöz



L m	Ø mm	B mm	Ft		
3	4,8	8,2	25.850	1	081490903
6	4,8	8,2	39.100	1	081490906

*Hegesztett zárt gyűrű. A lánc cseréje előtt olvassa el a kézikönyvet.



Szakítóerő (BF) - lásd a műszaki adatok specifikációját online
WWW.ROBURITALY.COM

8205

Mindkét oldalon szemes feszítőszerelvény
AISI 316

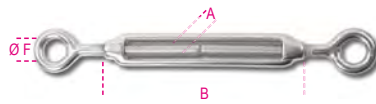

MŰSZAKI ADATOK

- Min. biztonsági koefficiens: 4
- Azonosítókód

LABORELEMZÉSEK

- Szakítópróba

RENDELKEZÉSRE ÁLLÓ TANÚSÍTVÁNYOK

- Termékleírás
- Vizsgálati jelentés 2.2 UNI EN10204

A mm	B mm	ØF mm	WFL kg	Ft		
M4	62	8	75	2.620	10	082050204
M5	72	11	115	3.100	10	082050205
M6	92	12	160	4.110	8	082050206
M8	122	14	300	6.350	8	082050208
M10	150	16	470	9.810	4	082050210
M12	201	18	690	16.050	1	082050212
M14	225	22	940	43.450	1	082050214
M16	244	26	1290	44.000	1	082050216
M20	295	29	2130	61.700	1	082050220
M24	350	33	3000	135.100	1	082050224

8206

Horgos és szemes feszítőszerelvény
AISI 316

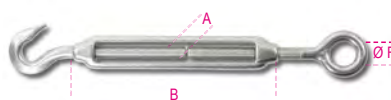

LABORELEMZÉSEK

- Kémiai elemzés
- Szakítópróba

RENDELKEZÉSRE ÁLLÓ TANÚSÍTVÁNYOK

- Termékleírás
- Vizsgálati jelentés 2.2 UNI EN10204

A mm	B mm	ØF mm	WFL kg	Ft		
M5	72	11	25	3.400	10	082060205
M6	92	12	45	4.570	5	082060206
M8	122	14	95	7.150	5	082060208
M10	150	16	140	9.920	1	082060210
M12	201	18	300	16.700	1	082060212
M14	225	22	420	43.100	1	082060214
M16	244	26	570	44.250	1	082060216
M20	295	29	875	62.250	1	082060220

8207

Mindkét oldalon horgos feszítőszerelvény
AISI 316

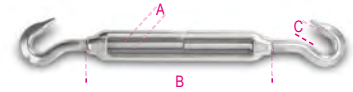

LABORELEMZÉSEK

- Kémiai elemzés
- Szakítópróba

RENDELKEZÉSRE ÁLLÓ TANÚSÍTVÁNYOK

- Termékleírás
- Vizsgálati jelentés 2.2 UNI EN10204

A mm	B mm	C mm	WFL kg	Ft		
M5	72	9	25	3.460	10	082070205
M6	92	9	45	4.550	5	082070206
M8	122	10	95	7.090	5	082070208
M10	150	12	140	10.950	1	082070210
M12	201	14	300	18.450	1	082070212
M14	225	15	420	43.150	1	082070214
M16	244	16	570	44.350	1	082070216
M20	295	19	875	62.100	1	082070220

8209

Mindkét oldalon kengyeles feszítőszerelvény
AISI 316

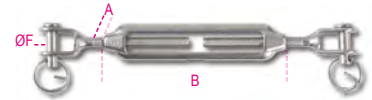

LABORELEMZÉSEK

- Kémiai elemzés
- Szakítópróba

RENDELKEZÉSRE ÁLLÓ TANÚSÍTVÁNYOK

- Termékleírás
- Vizsgálati jelentés 2.2 UNI EN10204

A mm	B mm	ØF mm	WFL kg	Ft		
M5	72	5	115	5.430	5	082090205
M6	92	6	160	6.620	5	082090206
M8	122	8	300	9.440	5	082090208
M10	150	10	470	15.200	1	082090210
M12	201	12	690	25.000	1	082090212
M14	225	14	940	33.550	1	082090214
M16	244	16	1290	51.600	1	082090216
M20	295	20	2130	89.550	1	082090220
M24	350	24	3060	231.100	1	082090224

8210

Kengyeles és anyás feszítőszerelvény
AISI 316

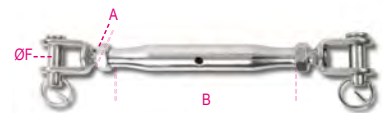

LABORELEMZÉSEK

- Kémiai elemzés
- Szakítópróba

RENDELKEZÉSRE ÁLLÓ TANÚSÍTVÁNYOK

- Termékleírás
- Vizsgálati jelentés 2.2 UNI EN10204

A mm	B mm	ØF mm	WFL kg	Ft		
M5	81	5	115	7.470	3	082100205
M6	92	6	160	8.230	3	082100206
M8	112	8	300	12.000	1	082100208
M10	121	10	470	19.100	1	082100210
M12	150	12	690	31.900	1	082100212
M14	169	14	940	41.500	1	082100214
M16	190	16	1290	62.100	1	082100216
M20	220	20	2130	103.700	1	082100220

8210FTP

drótkötél feszítő szerelvény, kengyel és préselehető cső végekkel
AISI 316 rozsdamentes acél

Nikkelkel, krómmal és molibdénnel ötvözött acél a nagyobb korrózióállóság érdekében.

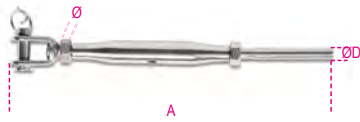

LABORATÓRIUMI VIZSGÁLATOK

- vegyelemzés
 - szakítópróba
- ### TANÚSÍTVÁNYOK
- Műszaki termékspecifikáció
 - Vizsgálati jelentés 2.2 UNI EN10204

Ø mm	A mm	ØD mm	WFL kg	Ft	📄	📄
M5	159	2,70	150	8.290	2	082100605
M6	179	3,30	250	9.810	2	082100606
M8	216	4,30	350	13.450	1	082100608
M10	241	5,30	550	20.600	1	082100610
M12	300	6,30	1000	30.000	1	082100612
M14	345	7,30	1350	45.450	1	082100614
M16	383	8,30	1625	66.100	1	082100616
M20	484	10,50	2125	112.400	1	082100620

8201T

Csőnyás feszítő, rozsdamentes acél (AISI 316)



LABORATÓRIUMI ELEMZÉS

- vegyi elemzés
 - szakítópróba
- ### RENDELKEZÉSRE ÁLLÓ TANÚSÍTVÁNYOK
- Termékleírás
 - Vizsgálati jelentés a 2.2 UNI EN10204 szerint

Ø mm	Ø "	WFL kg	L mm	Ft	📄	📄
M6	1/4	160	95	1.460	5	082010406
M8	5/16	300	105	2.150	5	082010408
M10	3/8	470	125	3.640	3	082010410
M12	1/2	690	150	5.800	3	082010412
M14	9/16	940	165	6.750	1	082010414
M16	5/8	1290	190	11.350	1	082010416
M20	3/4	2130	210	16.350	1	082010420

8210F

Kengyel feszítőszerelvényhez, rozsdamentes acél (AISI 316)

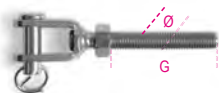

LABORATÓRIUMI TESZTEK

- vegyelemzés
 - szakítópróba
- ### TANÚSÍTVÁNYOK
- Műszaki termékspecifikáció
 - Vizsgálati jelentés 2.2 UNI EN10204

Ø mm	≈	G mm	WFL kg	Ft	📄	📄
M5	3/16	38,5	115	2.450	4	082100305
M6	1/4	49	160	2.760	4	082100306
M8	5/16	56	300	4.020	4	082100308
M10	3/8	61	470	6.870	2	082100310
M12	1/2	81	690	10.800	2	082100312
M14	9/16	93	940	17.050	2	082100314

Ø mm	≈	G mm	WFL kg	Ft	📄	📄
M5	3/16	38,5	115	2.450	4	082100405
M6	1/4	49	160	2.760	4	082100406
M8	5/16	56	300	4.020	4	082100408
M10	3/8	61	470	6.870	2	082100410
M12	1/2	81	690	8.800	2	082100412
M14	9/16	93	940	14.750	2	082100414

8248

szemes feszítő
Rozsdamentes acél 316L
jobbmenetes



UNI 6058

RENDELKEZÉSRE ÁLLÓ TANÚSÍTVÁNYOK

- Termékleírás
- 2.2 UNI EN10204 típusú Tesztjelentés

ØxL mm	F mm	Ft	📄	📄
8X120	6	1.620	1	082480008
10x80	8	3.480	1	082480010
10x130	8	4.650	1	082480012
12x95	10	5.220	1	082480016
12x125	10	6.300	1	082480018

8249

Rögzítő szemescsavar jobbos menettel
AISI 316



LABORELEMZÉSEK

- Kémiai elemzés
 - Szakítópróba
- ### RENDELKEZÉSRE ÁLLÓ TANÚSÍTVÁNYOK
- Termékleírás
 - Vizsgálati jelentés 2.2 UNI EN10204

A mm	Ø B mm	D mm	WFL kg	Ft	📄	📄
M5	11	50	100	1.030	10	082490205
M6	13	55	160	1.340	10	082490206
M8	17	60	300	2.160	5	082490208
M10	21	80	470	3.890	5	082490210
M12	25	120	690	6.710	2	082490212

8249G

Horog rögzítőbetét, rozsdamentes acél
(AISI 316)



LABORATÓRIUMI ELEMZÉS

- vegyi elemzés
 - szakítópróba
- ### RENDELKEZÉSRE ÁLLÓ TANÚSÍTVÁNYOK
- Termékleírás
 - Vizsgálati jelentés a 2.2 UNI EN10204 szerint

A mm	E mm	Ø F mm	WFL kg	Ft	📄	📄
M5	39	9	25	510	5	082490305
M6	43	10,5	45	680	5	082490306
M8	57	14,5	95	1.120	3	082490308

8216

Szorító kengyel
AISI 316

CE

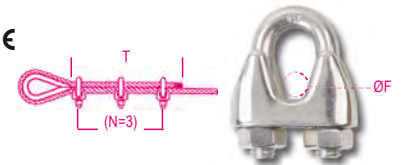

LABORELEMZÉSEK

- Kémiai elemzés
 - Nyomaték teszt
- ### RENDELKEZÉSRE ÁLLÓ TANÚSÍTVÁNYOK
- Termékleírás
 - Vizsgálati jelentés 2.2 UNI EN10204
 - * CE-Megfelelőségi nyilatkozat

Ø F mm	"	T	N	Ft	📄	📄
2	5/64	80	3	1.350	20	082160202
3	1/8	80	3	1.340	20	082160203
4	5/32	80	3	1.470	20	082160204
5	3/16	110	3	1.800	20	082160205
6	1/4	120	5	2.040	10	082160206
8	5/16	210	5	2.590	10	082160208
10	3/8	240	5	3.700	8	082160210
12-13	1/2	300	5	4.990	5	082160213
16	5/8	335	5	7.490	5	082160216
20	3/4	540	5	9.420	5	082160220
22	7/8	595	7	13.900	3	082160222

Különleges csomagolások szabad
szolgáltatáshoz



Ø F mm	📄	Ft	📄	📄
2	4	5.980	1	082169402
3	4	5.450	1	082169403
4	4	6.590	1	082169404
5	2	3.690	1	082169405
6	2	4.520	1	082169406
8	2	5.840	1	082169408
10	2	7.690	1	082169410

8220

Kötélszív
AISI 316

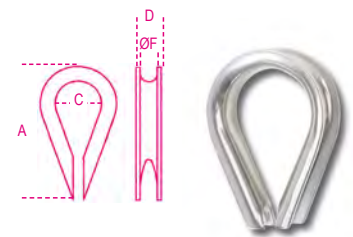

LABORELEMZÉSEK

- Kémiai elemzés
- ### RENDELKEZÉSRE ÁLLÓ TANÚSÍTVÁNYOK
- Termékleírás
 - Vizsgálati jelentés 2.2 UNI EN10204

Ø F mm	D mm	A mm	C mm	Ft	📄	📄
2	4,5	21	7,5	440	15	082200202
3	6	24	10	495	15	082200203
4	6,6	28	11	560	10	082200204
5	8,5	30	13	695	10	082200205
6	10	37	15	775	10	082200206
8	12,5	51	23	1.190	5	082200208
10	14,6	56	27	1.460	5	082200210
12	18	68	32	2.000	5	082200212
14	19	69	34	2.620	5	082200214
16	22	83	37	3.010	5	082200216
18	23	81	38	3.600	1	082200218
20	27,8	105	45	4.150	1	082200220
22	29,6	112	45	5.400	1	082200222

8225

Egyenes kengyelcsavar
AISI 316



LABORELEMZÉSEK

- Kémiai elemzés
 - Szakítópróba
- RENDELKEZÉSRE ÁLLÓ TANÚSÍTVÁNYOK
- Termékleírás
 - Vizsgálati jelentés 2.2 UNI EN10204

ø D mm	"	A mm	WFL kg	Ft		
4	5/32	8	50	1.470	20	082250204
5	3/16	11	70	1.560	20	082250205
6	1/4	13	100	1.700	10	082250206
8	5/16	17	250	2.690	10	082250208
10	3/8	21	400	4.110	8	082250210
12	1/2	25	600	6.290	3	082250212
16	5/8	32	1000	14.800	1	082250216
19	3/4	38	1600	24.100	1	082250219
22	7/8	43	2000	37.900	1	082250222
25	1	46	2800	55.850	1	082250225

8227

Hosszú egyenes kengyelcsavar
AISI 316



LABORELEMZÉSEK

- Kémiai elemzés
 - Szakítópróba
- RENDELKEZÉSRE ÁLLÓ TANÚSÍTVÁNYOK
- Termékleírás
 - Vizsgálati jelentés 2.2 UNI EN10204

ø D mm	"	A mm	WFL kg	Ft		
4	5/32	8	50	1.110	10	082270204
5	3/16	10	70	1.370	10	082270205
6	1/4	13,5	100	1.650	5	082270206
8	5/16	17	250	2.800	5	082270208
10	3/8	21	400	4.450	2	082270210
12	1/2	25	600	7.180	1	082270212

8228

Ivelt kengyelcsavar
AISI 316

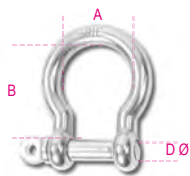

LABORELEMZÉSEK

- Kémiai elemzés
 - Szakítópróba
- RENDELKEZÉSRE ÁLLÓ TANÚSÍTVÁNYOK
- Termékleírás
 - Vizsgálati jelentés 2.2 UNI EN10204

ø D mm	A mm	B mm	WFL kg	Ft		
4	13	20	60	1.250	10	082280204
5	17	23	80	1.340	10	082280205
6	20	27	100	1.470	10	082280206
8	28	36	200	2.460	5	082280208
10	36	44	300	3.790	5	082280210
12	41	53	500	6.540	5	082280212
16	54	74	800	13.800	1	082280216
19	66	86	1100	22.700	1	082280219

8240F

Emelő fülescsavar, A4
belső, KOVÁCSOLT, rozsdamentes acél (AISI 316)

CE



MŰSZAKI ADATOK

- Min. biztonsági koeficiens: 6
 - Gyártási száma
- LABORELEMZÉSEK
- Kémiai elemzés
 - Metallográfiai elemzés
 - Szakítópróba
- RENDELKEZÉSRE ÁLLÓ TANÚSÍTVÁNYOK
- Termékleírás
 - Vizsgálati jelentés 2.2 UNI EN10204
 - Ellenőrzési tanúsítvány 3.1 UNI EN10204
 - CE-Megfelelőségi nyilatkozat

ø mm	WLL mm	WLL kg	Ft		
* M6	1,0	120	2.680	4	082400406
* M8	1,25	200	2.990	4	082400408
* M10	1,5	400	5.170	4	082400410
* M12	1,75	600	8.310	4	082400412
* M14	2	1000	13.400	2	082400414
* M16	2	1200	13.400	2	082400416
* M20	2,5	2000	21.450	2	082400420
* M24	3	2700	40.500	2	082400424
* M30	3,5	4000	89.600	1	082400430

8240

Emelő szemescsavar
AISI 316



LABORELEMZÉSEK

- Kémiai elemzés
 - Szakítópróba
- RENDELKEZÉSRE ÁLLÓ TANÚSÍTVÁNYOK
- Termékleírás
 - Vizsgálati jelentés 2.2 UNI EN10204

A mm	B mm	ø C mm	WFL kg	Ft		
M6	41	15	90	1.230	10	082400206
M8	50	20	140	1.770	10	082400208
M10	62	25	230	2.780	5	082400210
M12	74	30	340	4.720	5	082400212

8242F

Emelő fülescsavar, A4
külső, KOVÁCSOLT, rozsdamentes acél (AISI 316)

CE



MŰSZAKI ADATOK

- Min. biztonsági koeficiens: 6
 - Gyártási száma
- LABORELEMZÉSEK
- Kémiai elemzés
 - Metallográfiai elemzés
 - Szakítópróba
- RENDELKEZÉSRE ÁLLÓ TANÚSÍTVÁNYOK
- Termékleírás
 - Vizsgálati jelentés 2.2 UNI EN10204
 - Ellenőrzési tanúsítvány 3.1 UNI EN10204
 - CE-Megfelelőségi nyilatkozat

ø mm	WLL mm	WLL kg	Ft		
* M6	1,0	120	2.680	4	082420406
* M8	1,25	200	2.990	4	082420408
* M10	1,5	400	5.170	4	082420410
* M12	1,75	600	8.310	4	082420412
* M14	2	1000	13.400	2	082420414
* M16	2	1200	13.400	2	082420416
* M20	2,5	2000	21.450	2	082420420
* M24	3	2700	40.500	2	082420424
* M30	3,5	4000	89.600	1	082420430

Robur

8242

Emelő gyűrűs anya
AISI 316



A	B	ø C	WFL	Ft		
mm	mm	mm	mm	kg		
M6	27	15	90	1.230	10	082420206
M8	36	20	140	1.770	10	082420208
M10	45	25	230	2.780	5	082420210
M12	55	30	340	4.720	5	082420212

8274

Karabiner horog
AISI 316

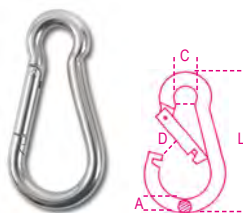

LABORELEMZÉSEK

- Kémiai elemzés
- Szakítópróba
- RENDELKEZÉSRE ÁLLÓ TANÚSÍTVÁNYOK
- Termékleírás
- Vizsgálati jelentés 2.2 UNI EN10204

ø A x L	ø C	D	WFL	Ft		
mm	mm	mm	mm	kg		
4,5x40	6,5	6	20	1.270	20	082740204
5x50	7	6,5	30	1.280	20	082740205
6x60	8,5	7,5	40	1.420	10	082740206
7x70	10	9	60	1.880	10	082740207
8x80	12	10	75	2.250	10	082740208
9x90	12,5	10,5	100	3.050	10	082740209
10x100	15	13	120	4.060	8	082740210
11x120	19	18	140	5.500	1	082740211
12x140	22	21	140	7.490	1	082740212
13x160	22	26	200	9.330	1	082740213

8274A

Gyűrűs karabiner, rozsdamentes acél (AISI 316)

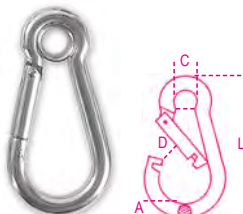

LABORATÓRIUMI ELEMZÉS

- vegyi elemzés
- szakítópróba
- RENDELKEZÉSRE ÁLLÓ TANÚSÍTVÁNYOK
- Termékleírás
- Vizsgálati jelentés a 2.2 UNI EN10204 szerint

ø A x L	ø C	D	WFL	Ft		
mm	mm	mm	mm	kg		
5x50	6,5	7	30	1.240	10	082740405
6x60	7,5	7,5	40	1.570	5	082740406
8x80	9,5	10	75	2.560	5	082740408

82746

Karabiner horog anyával, rozsdamentes acél
(AISI 316)

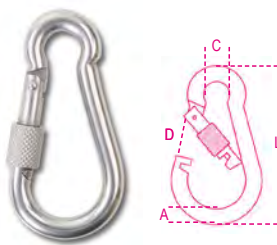

LABORELEMZÉSEK

- Kémiai elemzés
- Szakítópróba
- RENDELKEZÉSRE ÁLLÓ TANÚSÍTVÁNYOK
- Termékleírás
- Vizsgálati jelentés 2.2 UNI EN10204

ø A x L	ø C	D	WFL	Ft		
mm	mm	mm	mm	kg		
6x60	8,5	6,5	40	1.890	5	082740306
8x80	12	8,5	75	3.000	5	082740308
10x100	15	12	120	5.810	3	082740310

8276

Asszimmetrikus karabiner horog
AISI 316

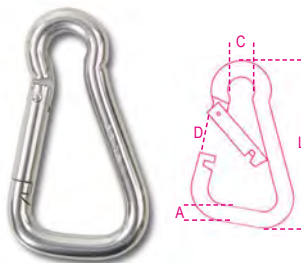

LABORELEMZÉSEK

- Kémiai elemzés
- Szakítópróba
- RENDELKEZÉSRE ÁLLÓ TANÚSÍTVÁNYOK
- Termékleírás
- Vizsgálati jelentés 2.2 UNI EN10204

ø A x L	ø C	D	WFL	Ft		
mm	mm	mm	mm	kg		
6x60	8,5	10	40	1.480	5	082760206
8x80	12	14	75	2.540	5	082760208
10x100	15	18	120	4.500	3	082760210

Robur

Robur

82766

Asszimmetrikus karabiner horog,
rozsdamentes acél (AISI 316)

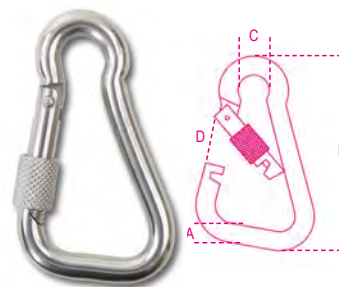

LABORELEMZÉSEK

- Kémiai elemzés
- Szakítópróba
- RENDELKEZÉSRE ÁLLÓ TANÚSÍTVÁNYOK
- Termékleírás
- Vizsgálati jelentés 2.2 UNI EN10204

ø A x L	ø C	D	WFL	Ft		
mm	mm	mm	mm	kg		
6x60	8,5	9	40	2.030	3	082760306
8x80	12	12,5	75	3.440	3	082760308
10x100	15	16	120	6.170	3	082760310

8278

Trapézhorog
AISI 316

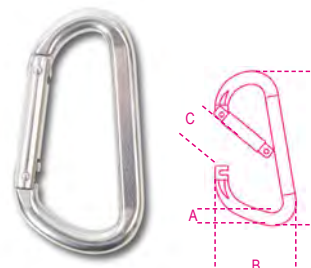

LABORELEMZÉSEK

- Kémiai elemzés
- Szakítópróba
- RENDELKEZÉSRE ÁLLÓ TANÚSÍTVÁNYOK
- Termékleírás
- Vizsgálati jelentés 2.2 UNI EN10204

ø A x L	B	C	WFL	Ft		
mm	mm	mm	mm	kg		
8x80	45	14	75	5.310	3	082780208
10x100	55	16	120	7.990	3	082780210

8280

Gyorscsatlakozó szem
AISI 316

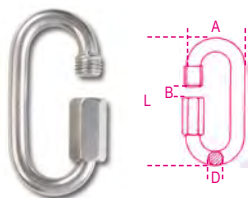

LABORELEMZÉSEK

- Kémiai elemzés
- Szakítópróba
- RENDELKEZÉSRE ÁLLÓ TANÚSÍTVÁNYOK
- Termékleírás
- Vizsgálati jelentés 2.2 UNI EN10204

ø D x L mm	A mm	B mm	WFL kg	Ft		
3,5x35	17	5	20	1.360	10	082800203
4x40	19	6	30	1.410	10	082800204
5x50	23	7	50	1.770	5	082800205
6x60	26	8	60	2.040	5	082800206
7x70	30	9	100	2.360	5	082800207
8x80	33	10	140	3.330	2	082800208
10x90	40	12	220	5.470	2	082800210
12x100	47	14	300	8.250	1	082800212

8250

Rugós füles horgok retesszel
AISI 316



LABORELEMZÉSEK

- Kémiai elemzés
- Szakítópróba
- RENDELKEZÉSRE ÁLLÓ TANÚSÍTVÁNYOK
- Termékleírás
- Vizsgálati jelentés 2.2 UNI EN10204

L mm	A mm	ø B mm	WFL kg	Ft		
50	25	8	40	1.850	5	082500205
70	31	12,5	90	2.860	5	082500207
100	47	20	190	4.530	2	082500210

8264

Forgószem
AISI 316



LABORELEMZÉSEK

- Kémiai elemzés
- Szakítópróba
- RENDELKEZÉSRE ÁLLÓ TANÚSÍTVÁNYOK
- Termékleírás
- Vizsgálati jelentés 2.2 UNI EN10204

B mm	L mm	C mm	WFL kg	Ft		
12	88	12	60	4.850	5	082640212
16	90	12	60	4.950	5	082640216
19	93	12	60	5.040	2	082640219

8267

Rugós füles horog
AISI 316



LABORELEMZÉSEK

- Kémiai elemzés
- Szakítópróba
- RENDELKEZÉSRE ÁLLÓ TANÚSÍTVÁNYOK
- Termékleírás
- Vizsgálati jelentés 2.2 UNI EN10204

A mm	L mm	B mm	WFL kg	Ft		
10	87	21	30	4.360	5	082670210
12	118	22	70	7.230	2	082670213

8272

Mindkét oldalas szemes forgószem
AISI 316

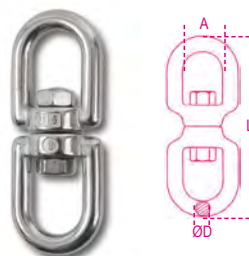

LABORELEMZÉSEK

- Kémiai elemzés
- Szakítópróba
- RENDELKEZÉSRE ÁLLÓ TANÚSÍTVÁNYOK
- Termékleírás
- Vizsgálati jelentés 2.2 UNI EN10204

ø D mm	A mm	L mm	WFL kg	Ft		
4	11	50	90	2.450	5	082720204
5	13	60	115	3.120	5	082720205
6	15	66	140	3.920	5	082720206
8	19	90	250	6.390	3	082720208
10	23	112	300	9.720	1	082720210
13	33	148	650	19.750	1	082720213
16	38	184	1000	36.700	1	082720216
19	40	223	1600	67.300	1	082720219

8273

Karabiner horog gyorscsatlakozóval
és szemes forgószem
Nemesacél AISI 316



LABORELEMZÉSEK

- Kémiai elemzés
- Szakítópróba
- RENDELKEZÉSRE ÁLLÓ TANÚSÍTVÁNYOK
- Termékleírás
- Vizsgálati jelentés 2.2 UNI EN10204

ø C x L mm	B mm	WFL kg	BF kg	Ft		
12x70	12	230	1100	6.820	1	082730012
16x85	14,50	440	2000	9.340	1	082730016
22x120	20	700	3500	14.650	1	082730022

8282S

Szimmetrikus "S" horog, rozsdamentes acél
(AISI 316)

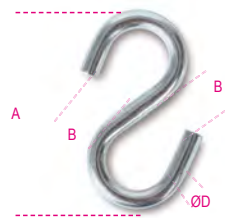

LABORATÓRIUMI ELEMZÉS

- vegyi elemzés
- szakítópróba
- RENDELKEZÉSRE ÁLLÓ TANÚSÍTVÁNYOK
- Termékleírás
- Vizsgálati jelentés a 2.2 UNI EN10204 szerint

ø D mm	B mm	A mm	WFL kg	Ft		
3	5,5	34	4	135	40	082820303
4	7,0	40	5	255	30	082820304
5	9,0	46	12	415	20	082820305
6	10	54	18	730	15	082820306

8284

"Pelikán" horog Nemesacél AISI 316



LABORELEMZÉSEK

- Kémiai elemzés
- Szakítópróba
- RENDELKEZÉSRE ÁLLÓ TANÚSÍTVÁNYOK
- Termékleírás
- Vizsgálati jelentés 2.2 UNI EN10204

ø C mm	B mm	L mm	WFL kg	Ft		
6	11	73	200	6.390	3	082840006
8	14	98	300	8.520	3	082840008
10	23	143	450	17.350	1	082840010

8285

Kengyeles vég
AISI 316

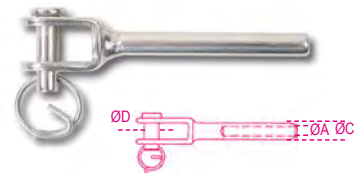

LABORELEMZÉSEK

- Kémiai elemzés
- Szakítópróba
- RENDELKEZÉSRE ÁLLÓ TANÚSÍTVÁNYOK
- Termékleírás
- Vizsgálati jelentés 2.2 UNI EN10204

ø A M	ø C mm	ø D mm	WFL kg	Ft		
3	6,3	6	180	2.200	5	082850203
4	7,5	8	200	2.820	3	082850204
5	9	10	330	4.140	2	082850205
6	12,5	12	720	6.940	2	082850206
7	12,5	12	850	8.040	2	082850207
8	15,5	16	1120	10.350	2	082850208
10	18	16	1300	11.250	2	082850210
12	20	19	2400	13.400	2	082850212

8286

Szemes vég
AISI 316



LABORELEMZÉSEK

- Kémiai elemzés
- Szakítópróba
- RENDELKEZÉSRE ÁLLÓ TANÚSÍTVÁNYOK
- Termékleírás
- Vizsgálati jelentés 2.2 UNI EN10204

Ø D	Ø A	Ø C	WFL	Ft		
M	mm	mm	kg			
3	6,5	6,3	180	2.370	5	082860203
4	8,5	7,5	200	2.870	3	082860204
5	10	9	330	3.880	2	082860205
6	12,5	12,6	720	5.870	2	082860206
7	12,5	14,2	850	3.470	2	082860207
8	14,5	16	1120	9.560	2	082860208
10	16,4	18	1300	11.300	2	082860210
12	19,3	20	2400	16.150	2	082860212

8287

Közcsavar
AISI 316

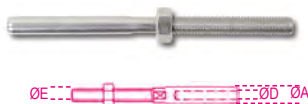

LABORELEMZÉSEK

- Kémiai elemzés
- Szakítópróba
- RENDELKEZÉSRE ÁLLÓ TANÚSÍTVÁNYOK
- Termékleírás
- Vizsgálati jelentés 2.2 UNI EN10204

Ø D	Ø A	E	WFL	Ft		
M	mm	mm	kg			
3	6,2	M6	180	1.740	5	082870203
4	7,5	M8	200	2.180	3	082870204
5	8,7	M10	330	2.920	2	082870205
6	12,6	M12	720	5.800	2	082870206
7	12,6	M14	850	6.130	2	082870207
8	16	M16	1120	11.450	2	082870208
10	18	M16	1300	9.840	2	082870210
12	20	M20	2400	13.500	2	082870212

8290

Szemesvég
AISI 316



LABORELEMZÉSEK

- Kémiai elemzés
- RENDELKEZÉSRE ÁLLÓ TANÚSÍTVÁNYOK
- Termékleírás
- Vizsgálati jelentés 2.2 UNI EN10204

Ø A	B	Ø C	L	Ft		
mm	mm	mm	mm			
5	18	4,3	40	640	5	082900205
6	22	5,2	44	775	5	082900206
8	23	5,2	51	1.180	5	082900208

8381SX

U csőbilincs, rozsdamentes acél (AISI 304)

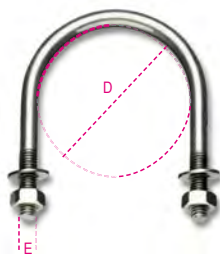

AISI 304

LABORELEMZÉSEK

- Kémiai elemzés
- RENDELKEZÉSRE ÁLLÓ TANÚSÍTVÁNYOK
- Vizsgálati jelentés 2.2 UNI EN10204

D	D	E	Ft		
mm	gas	mm			
11	1/8"	M6	885	20	083810401
14	1/4"	M6	920	20	083810402
18	3/8"	M6	955	20	083810403
22	1/2"	M6	980	20	083810404
27	3/4"	M6	1.020	20	083810405
34	1"	M6	1.050	20	083810406
43	1 1/4"	M6	1.180	20	083810407
49	1 1/2"	M8	2.130	10	083810408
61	2"	M8	2.200	10	083810409
77	2 1/2"	M8	3.040	10	083810410
89	3"	M8	3.410	10	083810412
115	4"	M8	4.440	10	083810413
168	6"	M10	8.440	1	083810416
220	8"	M10	9.870	1	083810418

8279

oldalhegesztett lánc tekercs
statikus csatlakozásokhoz,
AISI 304 rozsdamentes acél



MŰSZAKI ADATOK

- biztonsági együttható: 4
- TANÚSÍTVÁNYOK
- Műszaki termékspecifikáció
- Vizsgálati jelentés 2.2 UNI EN10204

Ø mm	nr	WFL	Ft			
		kg	m			
2	13	20	50	108.300	1	082790020
3	17	55	50	216.900	1	082790030
4	19	100	50	306.000	1	082790040
5	21	250	40	310.900	1	082790050
6	23	310	30	316.700	1	082790060
8	27	400	15	311.000	1	082790080
10	30	1000	10	487.200	1	082790400

Figyelem: a termék NEM emeléshez tervezett

8293

racsnis rögzítőrendszer AISI 304
nagy szakítószilárdságú poliészter heveder,
terheléshatár 300 kg
kampós horog
felfüggeszhető csomagolásban

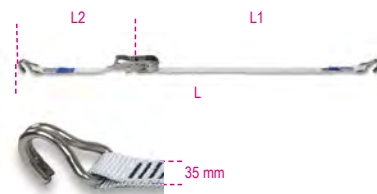

L	L2	L1	STF	Ft		
m	mm	mm	daN			
6	5700	300	100	29.200	1	082930106

LC = 300 kg

8297C

gyűrűs rögzítő rendszer
mini racsnival AISI 304
nagy szakítószilárdságú poliészter heveder,
terheléshatár 700 kg
felfüggeszhető csomagolásban

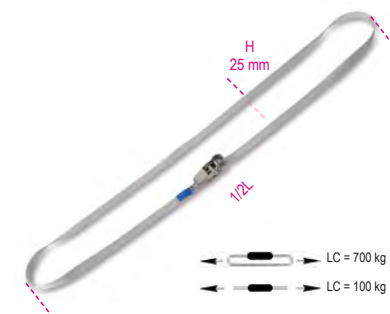

L	H	Ft		
m	mm			
5	25	14.700	1	082970350

8297F

2 gyűrűs rögzítőrendszer
csattal AISI 304
nagy szakítószilárdságú poliészter heveder,
terheléshatár 250 kg
felfüggeszhető csomagolásban

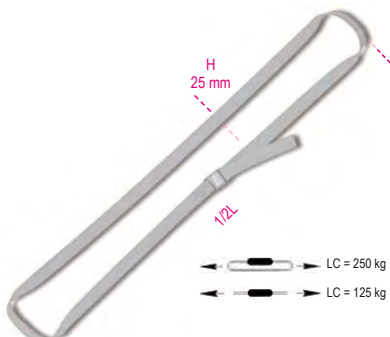

L	H	Ft		
m	mm			
3	25	14.700	1	082970230

LC = 250 kg



HEVEDER

Biztonsági faktor 7:1
Gyártó tanúsítvány
UNI EN 1492 szerint

MŰSZAKI ADATOK

- Min. biztonsági koeficiens: 7
- Gyártási száma
- LABORELEMZÉSEK
- Szakítópróba

RENDELKEZÉSRE ÁLLÓ TANÚSÍTVÁNYOK

- Termékleírás
- Vizsgálati jelentés 2.2 UNI EN10204
- Gyártói tanúsítvány UNI EN1492
- CE-Megfelelőségi nyilatkozat

				$\beta = 0^\circ - 45^\circ$	$\beta = 45^\circ - 90^\circ$
	1t	0,8t	2t	1,4t	1t
	2t	1,6t	4t	2,8t	2t
	3t	2,4t	6t	4,2t	3t
	4t	3,2t	8t	5,6t	4t
	5t	4t	10t	7t	5t
	6t	4,8t	12t	8,4t	6t
	8t	6,4t	16t	11,2t	8t
	10t	8t	20t	14t	10t
	12t	9,6t	24t	16,8t	12t
	15t	12t	30t	21t	15t
	20t	16t	40t	28t	20t
	25t	20t	50t	35t	25t
	30t	24t	60t	42t	30t
	40t	32t	80t	56t	40t
	50t	40t	100t	70t	50t

8150

1 t lila emelőheveder
kétrétegű, lapos szalag, erősített karikákkal,
nagy ellenállású polieszter (PES)

CE



UNI EN 1492-1

L m	H mm	WLL ton	Ft		
0,5	30	1	2.000	1	081500005
1	30	1	2.490	1	081500010
1,5	30	1	3.180	1	081500015
2	30	1	3.850	1	081500020
2,5	30	1	4.660	1	081500025
3	30	1	5.420	1	081500030
3,5	30	1	5.240	1	081500035
4	30	1	6.860	1	081500040
5	30	1	8.580	1	081500050
6	30	1	10.050	1	081500060
8	30	1	13.450	1	081500080

Robur

8153

2 t zöld emelőheveder
kétrétegű, lapos szalag, erősített karikákkal,
nagy ellenállású polieszter (PES)

CE



UNI EN 1492-1

L m	H mm	WLL ton	Ft		
1	60	2	4.820	1	081530010
1,5	60	2	6.380	1	081530015
2	60	2	7.410	1	081530020
2,5	60	2	8.800	1	081530025
3	60	2	10.150	1	081530030
3,5	60	2	10.100	1	081530035
4	60	2	12.600	1	081530040
5	60	2	14.950	1	081530050
6	60	2	17.350	1	081530060
8	60	2	22.550	1	081530080
10	60	2	27.850	1	081530100

8156

3 t sárga emelőheveder
kétrétegű, lapos szalag, erősített karikákkal,
nagy ellenállású polieszter (PES)

CE

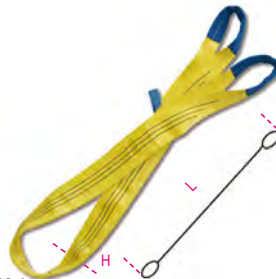

UNI EN 1492-1

L m	H mm	WLL ton	Ft		
1	90	3	6.430	1	081560010
1,5	90	3	8.310	1	081560015
2	90	3	10.450	1	081560020
2,5	90	3	12.400	1	081560025
3	90	3	14.450	1	081560030
3,5	90	3	14.800	1	081560035
4	90	3	18.600	1	081560040
5	90	3	23.100	1	081560050
6	90	3	26.650	1	081560060
8	90	3	34.750	1	081560080
10	90	3	42.300	1	081560100
12	90	3	48.600	1	081560120

8157

4 t szürke emelőheveder
kétrétegű, lapos szalag, erősített karikákkal,
nagy ellenállású polieszter (PES)

CE



UNI EN 1492-1

L m	H mm	WLL ton	Ft		
2	120	4	14.950	1	081570020
3	120	4	20.250	1	081570030
4	120	4	25.900	1	081570040
5	120	4	31.600	1	081570050
6	120	4	37.600	1	081570060
8	120	4	49.050	1	081570080
10	120	4	60.450	1	081570100
12	120	4	72.800	1	081570120

8158

5 t piros emelőheveder
kétrétegű, lapos szalag, erősített karikákkal,
nagy ellenállású polieszter (PES)

CE



UNI EN 1492-1

L m	H mm	WLL ton	Ft		
2	150	5	19.000	1	081580020
3	150	5	26.650	1	081580030
4	150	5	32.800	1	081580040
5	150	5	39.950	1	081580050
6	150	5	48.050	1	081580060
8	150	5	62.750	1	081580080
10	150	5	75.750	1	081580100
12	150	5	91.350	1	081580120

Robur

8159

6 t barna emelőheveder
kétrétegű, lapos szalag, erősített karikákkal,
nagy ellenállású polieszter (PES)



UNI EN 1492-1

L m	H mm	WLL ton	Ft		
2	180	6	24.950	1	081590020
3	180	6	37.050	1	081590030
4	180	6	46.850	1	081590040
5	180	6	57.100	1	081590050
6	180	6	67.600	1	081590060
8	180	6	88.000	1	081590080
10	180	6	109.900	1	081590100

8160

8 t kék emelőheveder
kétrétegű, lapos szalag, erősített karikákkal,
nagy ellenállású polieszter (PES)

CE



UNI EN 1492-1

L m	H mm	WLL ton	Ft		
3	240	8	49.950	1	081600030
4	240	8	64.700	1	081600040
5	240	8	77.600	1	081600050
6	240	8	91.350	1	081600060
8	240	8	121.300	1	081600080
10	240	8	147.400	1	081600100

8161

10 t narancs emelőheveder
kétrétegű, lapos szalag, erősített karikákkal,
nagy ellenállású polieszter (PES)

CE



UNI EN 1492-1

L m	H mm	WLL ton	Ft		
3	300	10	74.400	1	081610030
4	300	10	96.950	1	081610040
5	300	10	118.900	1	081610050

L m	H mm	WLL ton	Ft		
6	300	10	138.000	1	081610060
8	300	10	182.700	1	081610080
10	300	10	224.100	1	081610100
12	300	10	263.000	1	081610120

8170

1 t emelőheveder
végtelenített heveder, lila,
nagy ellenállású polieszter (PES)

CE



UNI EN 1492-2

L m	WLL ton	H mm	Ft		
0,5	1	45	2.440	1	081700010
1	1	45	2.890	1	081700020
1,5	1	45	4.050	1	081700030
2,5	1	45	5.830	1	081700050
2	1	45	5.140	1	081700040
3	1	45	7.520	1	081700060
4	1	45	9.840	1	081700080
5	1	45	13.050	1	081700100

8173

2 t emelőheveder
végtelenített heveder, zöld,
nagy ellenállású polieszter (PES)

CE

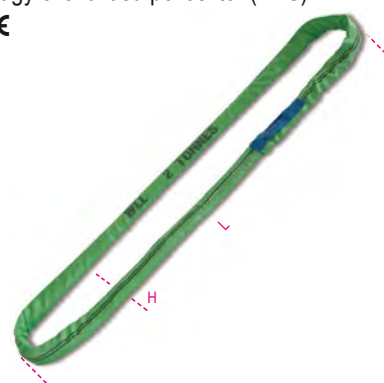

UNI EN 1492-2

L m	H mm	WLL ton	Ft		
0,5	50	2	2.890	1	081730010
1	50	2	4.610	1	081730020
1,5	50	2	6.760	1	081730030
2	50	2	8.800	1	081730040
2,5	50	2	10.750	1	081730050
3	50	2	12.850	1	081730060
4	50	2	17.350	1	081730080
5	50	2	21.600	1	081730100
6	50	2	25.900	1	081730120
8	50	2	33.150	1	081730160

Robur

8176

3 t emelőheveder
végtelenített heveder, sárga,
nagy ellenállású polieszter (PES)

CE



UNI EN 1492-2

L m	H mm	WLL ton	Ft		
0,5	60	3	2.830	1	081760010
1	60	3	6.040	1	081760020
1,5	60	3	8.990	1	081760030
2	60	3	11.650	1	081760040
2,5	60	3	14.300	1	081760050
3	60	3	16.850	1	081760060
4	60	3	22.550	1	081760080
5	60	3	28.550	1	081760100
6	60	3	34.300	1	081760120
8	60	3	44.900	1	081760160

8177

4 t emelőheveder
végtelenített heveder, szürke,
nagy ellenállású polieszter (PES)

CE



UNI EN 1492-2

L m	H mm	WLL ton	Ft		
0,5	65	4	5.660	1	081770010
1	65	4	7.220	1	081770020
1,5	65	4	10.900	1	081770030
2	65	4	14.450	1	081770040
2,5	65	4	18.050	1	081770050
3	65	4	21.200	1	081770060
4	65	4	28.000	1	081770080
5	65	4	32.550	1	081770100
6	65	4	39.250	1	081770120
8	65	4	52.100	1	081770160

Robur

8178

5 t emelőheveder
végtelenített heveder, piros,
nagy ellenállású polieszter (PES)

CE

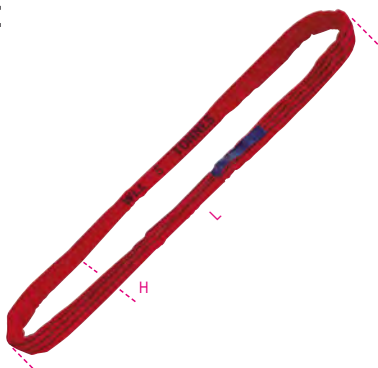

UNI EN 1492-2

L m	H mm	WLL ton	Ft		
0,5	70	5	8.890	1	081780010
1	70	5	8.850	1	081780020
1,5	70	5	12.850	1	081780030
2	70	5	17.650	1	081780040
2,5	70	5	21.600	1	081780050
3	70	5	25.900	1	081780060
4	70	5	35.200	1	081780080
5	70	5	42.650	1	081780100
6	70	5	48.600	1	081780120
8	70	5	64.700	1	081780160

8179M

6 t emelőheveder
végtelenített heveder, barna
nagy ellenállású polieszter (PES)

CE

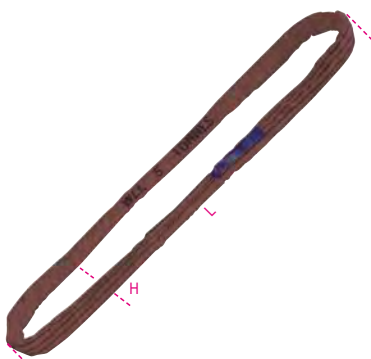

UNI EN 1492-2

L m	H mm	WLL ton	Ft		
1	80	6	9.550	1	081790020
1,5	80	6	14.000	1	081790030
2	80	6	18.450	1	081790040
2,5	80	6	22.700	1	081790050
3	80	6	28.350	1	081790060
4	80	6	39.400	1	081790080
5	80	6	44.800	1	081790100
6	80	6	58.550	1	081790120
8	80	6	77.600	1	081790160

8179B

8 t emelőheveder végtelenített szalag, kék
nagy szakítószilárdságú polieszter szövet (PES)

CE

UNI EN 1492-2

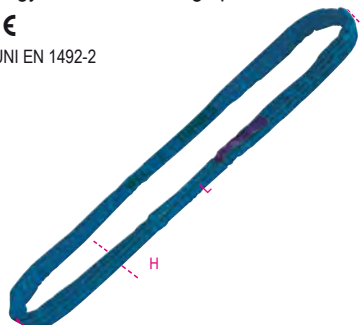

L m	H mm	WLL ton	Ft		
1	85	8	17.350	1	081790220
1,5	85	8	18.450	1	081790230
2	85	8	24.550	1	081790240
2,5	85	8	30.300	1	081790250
3	85	8	39.400	1	081790260
4	85	8	51.300	1	081790280
5	85	8	60.400	1	081790300
6	85	8	78.500	1	081790320
8	85	8	103.200	1	081790360

8179A

10 t emelőheveder végtelenített szalag, narancs
nagy szakítószilárdságú polieszter szövet (PES)

CE

UNI EN 1492-2

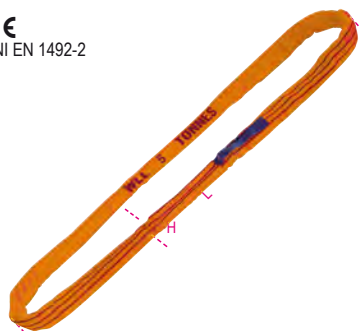

L m	H mm	WLL ton	Ft		
1	95	10	18.750	1	081790502
1,5	95	10	25.350	1	081790503
2	95	10	41.800	1	081790505
2	95	10	37.350	1	081790504
3	95	10	57.050	1	081790506
4	95	10	76.000	1	081790508
5	95	10	80.650	1	081790510
6	95	10	126.300	1	081790512
8	95	10	170.100	1	081790516
10	95	10	211.700	1	081790520
2	100	12	65.300	1	081791204
2,5	100	12	84.800	1	081791205
3	100	12	97.700	1	081791206
3,5	100	12	110.400	1	081791207
4	100	12	123.800	1	081791208
4,5	100	12	125.000	1	081791209
5	100	12	149.600	1	081791210
5,5	100	12	162.900	1	081791211
6	100	12	175.500	1	081791212
6,5	100	12	188.800	1	081791213
7	100	12	201.900	1	081791214
7,5	100	12	214.600	1	081791215
8	100	12	227.400	1	081791216
8,5	100	12	240.700	1	081791217
9	100	12	253.900	1	081791218
9,5	100	12	266.800	1	081791219
10	100	12	279.300	1	081791220
2	110	15	91.850	1	081791504
2,5	110	15	107.300	1	081791505
3	110	15	122.700	1	081791506
3,5	110	15	138.100	1	081791507
4	110	15	153.600	1	081791508
4,5	110	15	169.200	1	081791509
5	110	15	184.500	1	081791510
5,5	110	15	200.100	1	081791511
6	110	15	215.300	1	081791512
6,5	110	15	230.800	1	081791513
7	110	15	246.400	1	081791514
7,5	110	15	261.800	1	081791515

L m	H mm	WLL ton	Ft		
8	110	15	277.300	1	081791516
8,5	110	15	292.800	1	081791517
9	110	15	308.100	1	081791518
9,5	110	15	327.400	1	081791519
10	110	15	339.000	1	081791520
2	130	20	108.100	1	081792004
2,5	130	20	126.900	1	081792005
3	130	20	145.600	1	081792006
3,5	130	20	164.300	1	081792007
4	130	20	183.000	1	081792008
4,5	130	20	201.800	1	081792009
5	130	20	220.500	1	081792010
5,5	130	20	239.300	1	081792011
6	130	20	257.900	1	081792012
6,5	130	20	276.700	1	081792013
7	130	20	295.500	1	081792014
7,5	130	20	314.300	1	081792015
8	130	20	333.000	1	081792016
8,5	130	20	351.700	1	081792017
9	130	20	370.400	1	081792018
9,5	130	20	389.100	1	081792019
10	130	20	407.900	1	081792020
2	135	25	119.500	1	081792504
2,5	135	25	142.900	1	081792505
3	135	25	166.400	1	081792506
3,5	135	25	189.900	1	081792507
4	135	25	213.400	1	081792508
4,5	135	25	236.900	1	081792509
5	135	25	260.400	1	081792510
5,5	135	25	283.900	1	081792511
6	135	25	307.400	1	081792512
6,5	135	25	330.900	1	081792513
7	135	25	354.400	1	081792514
7,5	135	25	377.800	1	081792515
8	135	25	401.300	1	081792516
8,5	135	25	424.800	1	081792517
9	135	25	448.400	1	081792518
9,5	135	25	471.900	1	081792519
10	135	25	495.300	1	081792520
2	160	30	140.500	1	081793004
2,5	160	30	169.200	1	081793005
3	160	30	197.800	1	081793006
3,5	160	30	226.300	1	081793007
4	160	30	254.900	1	081793008
4,5	160	30	283.500	1	081793009
5	160	30	312.100	1	081793010
5,5	160	30	340.700	1	081793011
6	160	30	369.300	1	081793012
6,5	160	30	397.900	1	081793013
7	160	30	426.500	1	081793014
7,5	160	30	455.100	1	081793015
8	160	30	483.800	1	081793016
8,5	160	30	512.400	1	081793017
9	160	30	541.000	1	081793018
9,5	160	30	569.600	1	081793019
10	160	30	598.200	1	081793020
2	165	40	188.700	1	081794004
2,5	165	40	210.700	1	081794005
3	165	40	245.100	1	081794006
3,5	165	40	279.800	1	081794007
4	165	40	314.600	1	081794008
4,5	165	40	349.000	1	081794009
5	165	40	383.800	1	081794010
5,5	165	40	418.500	1	081794011
6	165	40	452.700	1	081794012
6,5	165	40	487.700	1	081794013
7	165	40	521.100	1	081794014
7,5	165	40	557.600	1	081794015
8	165	40	589.400	1	081794016
8,5	165	40	627.500	1	081794017
9	165	40	661.500	1	081794018
9,5	165	40	695.300	1	081794019
10	165	40	729.200	1	081794020
3	180	50	284.000	1	081795006
3,5	180	50	324.300	1	081795007
4	180	50	364.200	1	081795008
4,5	180	50	403.200	1	081795009
5	180	50	442.700	1	081795010
5,5	180	50	482.100	1	081795011
6	180	50	521.100	1	081795012
6,5	180	50	561.900	1	081795013
7	180	50	599.900	1	081795014
7,5	180	50	640.200	1	081795015
8	180	50	678.500	1	081795016
8,5	180	50	716.500	1	081795017
9	180	50	754.700	1	081795018
9,5	180	50	797.100	1	081795019
10	180	50	835.300	1	081795020

Robur

8166

Dörzsölésgátló burkolat hevederekhez,
nagy szakítószilárdságú poliészter (PES)
Elastomer alsó réteggel



H mm	ø mm	L m	Ft		
70	45	3	9.480	1	081660073
80	52	3	11.350	1	081660083
110	70	3	14.050	1	081660103
155	100	3	28.550	1	081660153
170	110	3	31.400	1	081660170
235	150	4	86.600	1	081660235

H mm			
70	8150	8170-8173	081660073
80	8153	8176	081660083
110	8153-8156	8177-8178	081660103
155	8157	8178-8179A 8179B-8179M	081660153
170	8158	-	081660170
235	8159	-	081660235

8090F

összekötő emelő tag,
polieszter hevederekhez,
nagy szilárdságú ötvöztött acél

CE

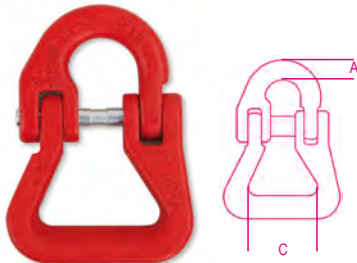

EN 1677-1

MŰSZAKI ADATOK

- Min. biztonsági koeficiens: 4
- Hőkezelés: díjazás ellenében
- Gyártási száma
- LABORELEMZÉSEK
- Kémiai elemzés, metallográfiai elemzés*
- Terhelhetőségi teszt (WLL x 2,5)
- Szakítópróba
- Fáradáspróba (min. 20.000 ciklus)
- RENDELKEZÉSRE ÁLLÓ TANÚSÍTVÁNYOK
- Termékleírás
- Vizsgálati jelentés 2.2 UNI EN10204
- Ellenőrzési tanúsítvány 3.1 UNI EN10204
- CE-Megfelelőségi nyilatkozat

WLL kg	Ø mm	A mm	C mm	Ft		
2000	7-8	10,5	40	11.950	1	080900220
3150	10	12	50	14.650	1	080900232
5300	13	17	60	23.050	1	080900253
8000	16	21	75	34.850	1	080900280

Robur

RÖGZÍTŐ HEVEDER

2:1

UNI EN 12195 szabvány szerint

Min. biztonsági koeficiens: 2

- Azonosítókód
- LABORELEMZÉSEK
- Racsni terhelési teszt
- Fémrészek deformálódási teszt
- Komplet termékre szakítópróba
- RENDELKEZÉSRE ÁLLÓ TANÚSÍTVÁNYOK
- Termékleírás
- Vizsgálati jelentés 2.2 UNI EN10204

8180

Racsnis rögzítő heveder, egyhorgos

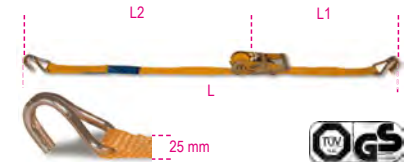

EN 12195-2

L m	L2 mm	L1 mm	STF daN	Ft		
4	3750	250	200	7.220	1	081800004
6	5750	250	200	7.950	1	081800006
8	7750	250	200	8.910	1	081800008

LC = 750 kg

8181

Racsnis rögzítő heveder, egyhorgos



EN 12195-2

L m	L2 mm	L1 mm	STF daN	Ft		
4	3600	400	180	10.600	1	081810004
6	5600	400	180	11.700	1	081810006
8	7600	400	180	12.650	1	081810008

LC = 1000 kg

8181S

racsnis rögzítő rendszer, LC 1000 kg
nagy szakítószilárdságú poliészter szalag
(PES)
platórögzítő horgok



EN 12195-2

L m	L2 mm	L1 mm	STF daN	Ft		
6	5600	400	180	11.450	1	081810206

LC = 1000 kg

8182E

racsnis rögzítő rendszer furgonokba és teherautókba, terheléshatár 1.000 kg nagy szakítószilárdságú poliészter heveder (PES)

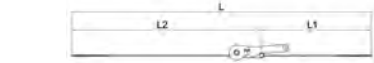

EN 12195-2

L m	L2 mm	L1 mm	STF daN	Ft		
4	3500	500	220	8.620	1	081820440

LC = 1000 kg

	L2 mm	Ft		
8182EL	2500	2.480	1	081820942
8182EC		5.330	1	081820945

8182T

racsnis rögzítő rendszer, LC 1500kg nagy szakítószilárdságú poliészter szalag (PES)
OLDALFAL rögzítő horgok

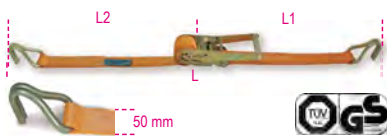

EN 12195-2

L m	L2 mm	L1 mm	STF daN	Ft		
8,5	8100	400	300	13.800	1	081821085
10,5	10100	400	300	15.550	1	081821105

LC = 1500 kg

8182TS

racsnis rögzítő rendszer, LC 1500kg nagy szakítószilárdságú poliészter szalag (PES)
horgos rögzítés

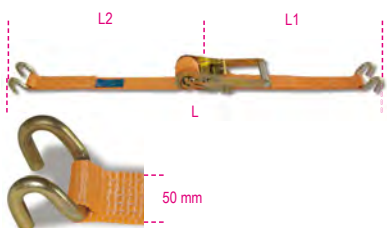

EN 12195-2

L m	L2 mm	L1 mm	STF daN	Ft		
8,5	8100	400	300	14.350	1	081821285
10,5	10100	400	300	16.250	1	081821305

LC = 1500 kg

8182

Racsnis rögzítő heveder, egyhorgos

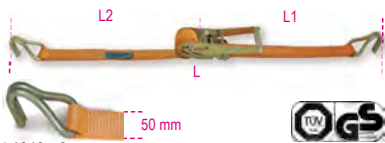

EN 12195-2

L m	L2 mm	L1 mm	STF daN	Ft		
4,5	4100	400	300	12.850	1	081820045
6,5	6100	400	300	14.300	1	081820065
8,5	8100	400	300	16.200	1	081820085
10,5	10100	400	300	17.700	1	081820105
14,5	14100	400	300	19.750	1	081820145
16,5	16100	400	300	22.450	1	081820165

LC = 2000 kg

	L2 mm	Ft		
8182LP	8100	7.880	1	081820902
hosszú rész				
8182SP		8.110	1	081820905
rövid rész				

8182S

Racsnis rögzítő heveder, kéthorgos

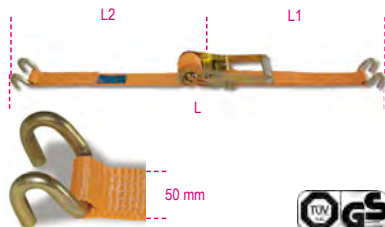

EN 12195-2

L m	L2 mm	L1 mm	STF daN	Ft		
8,5	8100	400	300	14.050	1	081820265
8,5	8100	400	350	15.950	1	081820285
10,5	10100	400	350	17.700	1	081820305

LC = 2000 kg

	L2 mm	Ft		
8182SLP	8100	7.650	1	081820912
hosszú rész				
8182SSP		7.740	1	081820915
rövid rész				

8182GD

racsnis rögzítőheveder delta karabinerrel, LC 2000 kg, nagy szakítószilárdságú poliészter heveder (PES)

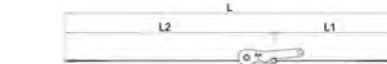

EN 12195-2

L m	L2 mm	L1 mm	STF daN	Ft		
8,5	8100	400	300	17.500	1	081820485

LC = 2000 kg

8182A

racsnis rögzítő rendszer 2 tartógyűrűvel nagy szakítószilárdságú poliészter heveder (PES) terheléshatár 2.000 kg



EN 12195-2

L m	L2 mm	L1 mm	STF daN	Ft		
8,5	8100	400	300	14.800	1	081820585

LC = 2000 kg

8182H

racsnis rögzítő rendszer, LC 2500kg nagy szakítószilárdságú poliészter szalag (PES)
horgos rögzítés

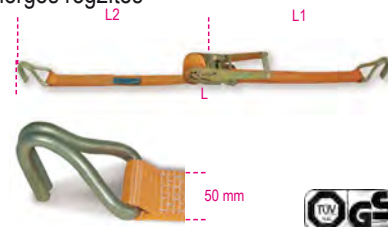

EN 12195-2

L m	L2 mm	L1 mm	STF daN	Ft		
6,5	6100	400	300	16.000	1	081820406
8,5	8100	400	300	17.550	1	081820408
10,5	10100	400	300	19.350	1	081820410
14,5	14100	400	300	24.500	1	081820414

LC = 2500 kg



8182H/2

racsnis rögzítőheveder, kéthorgos, LC 2500 kg, nagy szakítószilárdságú poliészter heveder (PES)

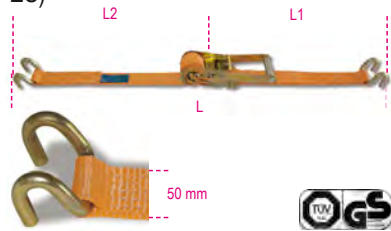

EN 12195-2

L m	L1 mm	L2 mm	STF daN	Ft	📦	🚚
8,5	8100	400	300	17.100	1	081820385

LC = 2500 kg

8184

irányváltós racsnis rögzítőheveder, hosszú karos, egyhorgos, LC 2500 kg, nagy szakítószilárdságú poliészter heveder (PES)



EN12195-2

L m	L2 mm	L1 mm	STF daN	Ft	📦	🚚
6,5	6100	400	500	17.300	1	081840065
8,5	8100	400	500	18.100	1	081840085
10,5	10100	400	500	19.350	1	081840105

LC = 2500 kg

8183

racsnis rögzítőheveder, egyhorgos, LC 5000 kg, nagy szakítószilárdságú poliészter heveder (PES)



EN 12195-2

L m	L2 mm	L1 mm	STF daN	Ft	📦	🚚
8,5	8000	500	500	50.850	1	081830085
12,5	12000	500	500	60.900	1	081830125

LC = 5000 kg

8190

kéthorgos racsnis teherkötöző
8. biztonsági fokozatú



EN12195/3

MŰSZAKI ADATOK

- Min. biztonsági koeficiens: 2
 - Hökezelés: díjazás ellenében
 - Termékspecifikáció
- RENDELKEZÉSRE ÁLLÓ TANÚSÍTVÁNYOK
- Termékleírás
 - Vizsgálati jelentés 2.2 UNI EN10204
 - Ellenőrzési tanúsítvány 3.1 UNI EN10204

📏	LC daN	📏	LC daN	Ft	📦	🚚
∅ mm	10	6300	8	4000	43.150	1 081900010

* FIGYELEM: A termék használható 8mm-es láncsal is, de figyelembe kell venni a terhelhetőség (WLL) csökkenését (LC 400daN)

8190B

horgos teherkötöző rögzítőlánc



EN12195/3

MŰSZAKI ADATOK

- Min. biztonsági koeficiens: 2
 - Hökezelés: díjazás ellenében
 - Emelőlánc azonosító
- MELLÉKELT TANÚSÍTVÁNYOK
- Gyártói tanúsítvány
- RENDELKEZÉSRE ÁLLÓ TANÚSÍTVÁNYOK
- Vizsgálati jelentés 2.2 UNI EN10204
 - Termékleírás

📏	LC daN	L m	L1 m	Ft	📦	🚚
∅ mm	8	4000	3,5	3,30	73.150	1 081901308
10	6300	3,5	3,28	108.300	1 081901310	

8185

Racsnis rögzítő heveder

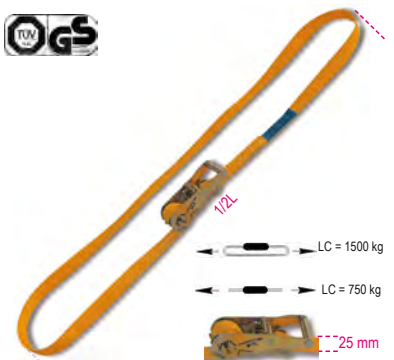

EN 12195-2

L m	STF daN	Ft	📦	🚚
5	200	6.060	1	081850005
8	200	7.500	1	081850008

8186

Racsnis rögzítő heveder



EN 12195-2

L m	STF daN	Ft	📦	🚚
5	180	7.370	1	081860005
8	180	9.050	1	081860008

8187

Racsnis rögzítő heveder



EN 12195-2

L m	STF daN	Ft		
5	350	11.400	1	081870005
8	350	13.300	1	081870008

8188C

Racsnis rögzítő heveder, LC 750 kg, nagy szakítószilárdságú polieszter szalag (PP)



- 1,5 m
- 2,5 m
- 5,0 m



EN 12195-2

L m	STF daN	Ft		
1,5	72	2.050	3	081880315
2,5	72	2.330	3	081880325
5	72	3.100	3	081880350

8188CG/25

Racsnis 2 horgos rögzítő heveder, LC 400 kg nagy szakítószilárdságú polieszter szalag (PES)



EN 12195-2

L m	L1 mm	L2 mm	STF daN	Ft		
3	480	170	120	4.710	1	081880430
5	480	170	120	5.150	1	081880450

8188CU/25

racsnis rögzítőheveder, egyhorgos, LC 400 kg, nagy szakítószilárdságú poliészter szalag (PES)



EN 12195-2

L m	L1 mm	L2 mm	Ft		
5	300	4700	4.730	1	081880750

8188F

Rögzítő heveder LC 200 kg, nagy szakítószilárdságú polieszter szalag (PP)

- 1,5 m
- 2,0 m
- 2,5 m
- 3,0 m
- 5,0 m

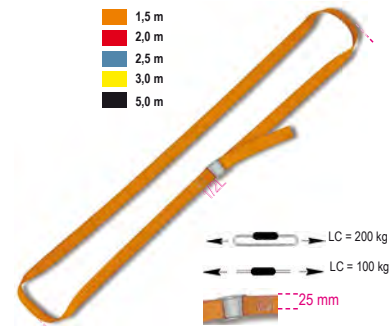

EN 12195-2

L m	Ft		
1,5	1.240	10	081880215
2,0	1.280	10	081880220
2,5	1.490	10	081880225
3,0	1.560	10	081880230
5,0	2.100	6	081880250

8188F35

rögzítő heveder, LC 500 kg, nagy szakítószilárdságú polipropilén szalag (PP)



EN 12195-2

L m	Ft		
5	4.290	1	081880295

8188VFG2

2 horgos rögzítő heveder LC 250 kg nagy szakítószilárdságú polypropilén szalag (PP)



EN 12195-2

L m	L1 mm	L2 mm	Ft		
3	450	110	5.680	1	081881530

8189

Poliészterszalag (PES) racsnis hevederhez



H mm	L m	LC kg	Ft		
25	100	750	45.100	1	081890902
35	100	1000	60.100	1	081890903
50	100	2000	90.250	1	081890905

8189A

csúszásmentes szőnyeg teherrögzítéshez



L m	H mm	S mm	μ	Ft		
5	250	8	0,6	36.000	1	081890525

8189PA

2 sarokvédő poliészter rögzítő hevederekhez

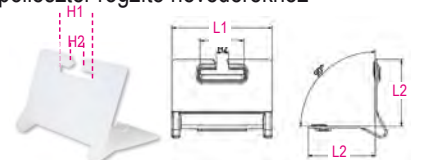

L1xL2 mm	H1 mm	H2 mm	Ft		
135x90	60	18	1.730	1	081890090

Termék	Vizsgálati jelentés 2.2 (UNI EN 10204)	Teszt tanúsítvány 3.1(UNI EN 10204)	Gyártói tanúsítvány	CE-Megfelelőségi nyilatkozat
8001Z	✓	✓		✓
8001TZ	✓	✓		✓
8002ZD	✓			
8003ZD	✓			
8004ND	✓			
8005Z	✓			✓
8005TZ	✓			✓
8006Z	✓			✓
8007Z	✓			✓
8008N	✓			✓
8008TZN	✓			✓
8009FD	✓			
8009Z	✓			✓
8009TZ	✓			✓
8010Z	✓			✓
8010TZ	✓			✓
8015	✓		✓	✓
8016	✓			✓
8016DA	✓			✓
8016FR	✓			
8016U2	✓		✓	✓
8016UGK	✓		✓	✓
8018E	✓			
8018T	✓			
8020A	✓			
8021A	✓			
8025	✓	✓		✓
8026A	✓	✓		✓
8026R	✓	✓		✓
8028	✓	✓		✓
8029R	✓	✓		✓
8031R	✓	✓		✓
8032	✓	✓		✓
8040EN	✓	✓		✓
8040EZ	✓	✓		✓
8042EN	✓	✓		✓
8042EZ	✓	✓		✓
8041	✓	✓		✓
8043	✓	✓		✓
8044	✓	✓		✓
8048	✓			
8049	✓	✓		✓
8049A	✓	✓		✓
8049V	✓	✓		✓
8051S	✓	✓		✓
8052	✓	✓		✓
8057R	✓	✓		✓
8058R	✓	✓		✓
8060R	✓	✓		✓
8061R	✓	✓		✓
8062	✓	✓		✓
8063	✓	✓		✓
8063SL	✓	✓		✓
8064S	✓	✓		✓
8065SC	✓	✓		✓
8068G	✓	✓		✓
8074	✓			
8074A	✓			
8074G	✓			
8080	✓			
8080FM	✓			
8085R	✓	✓		✓
8086	✓	✓		✓
8090	✓	✓		✓
8090F	✓	✓		✓

Termék	Vizsgálati jelentés 2.2 (UNI EN 10204)	Teszt tanúsítvány 3.1(UNI EN 10204)	Gyártói tanúsítvány	CE-Megfelelőségi nyilatkozat
8090R	✓	✓		✓
8091			✓	✓
8091SL			✓	✓
8092			✓	✓
8092SL			✓	✓
8094			✓	✓
8094SL			✓	✓
8096			✓	✓
8096SL			✓	✓
8097			✓	✓
8097SL			✓	✓
8098			✓	✓
8098SL			✓	✓
8100	✓	✓		✓
8105	✓	✓		✓
8109	✓	✓		✓
8110	✓			
8114	✓			
8116	✓			
8120 - 8120D	✓			
8120B	✓			
8130A	✓			
8135	✓		✓	✓
8139DL	✓			
8143	✓		✓	✓
8146	✓		✓	✓
8146K	✓		✓	✓
8147C-S-P	✓		✓	✓
8148	✓		✓	✓
8149	✓			✓
8150	✓		✓	✓
8153	✓		✓	✓
8156	✓		✓	✓
8157	✓		✓	✓
8158	✓		✓	✓
8159	✓		✓	✓
8160	✓		✓	✓
8161	✓		✓	✓
8166	✓			
8170	✓		✓	✓
8173	✓		✓	✓
8176	✓		✓	✓
8177	✓		✓	✓
8178	✓		✓	✓
8179M-B-A	✓		✓	✓
8180	✓			
8181	✓			
8181S	✓			
8182	✓			
8182A-GD	✓			
8182E	✓			
8182H-H2	✓			
8182M	✓			
8182S	✓			
8182T	✓			
8182T-TS	✓			
8182TS	✓			
8185	✓			
8186	✓			
8187	✓			
8188C	✓			
8188CG/25	✓			
8188CU	✓			
8188F	✓			
8188VF/35	✓			

Termék	Vizsgálati jelentés 2.2 (UNI EN 10204)	Teszt tanúsítvány 3.1(UNI EN 10204)	Gyártói tanúsítvány	CE-Megfelelőségi nyilatkozat
8188FG2	✓			
8190	✓	✓		
8190B	✓		✓	
8302Z	✓			
8303Z	✓			
8317DZ	✓			
8317SZ	✓			
8381SL	✓			
8381SP	✓			
8383C	✓			
8383P	✓			
8515V	✓			
8515Z	✓			
8531	✓			
8532	✓			
8535	✓			
8201T	✓			
8205	✓			
8206	✓			
8207	✓			
8209	✓			
8210	✓			
8210F	✓			
8210FTP	✓			
8216	✓			✓
8220	✓			
8225	✓			
8227	✓			
8228	✓			
8240	✓			
8240F	✓	✓		✓
8242	✓			
8242F	✓	✓		✓
8248	✓			
8249	✓			
8249G	✓			
8250	✓			
8264	✓			
8267	✓			
8272	✓			
8273	✓			
8274	✓			
8274A	✓			
8274G	✓			
8276	✓			
8276G	✓			
8278	✓			
8280	✓			
8282	✓			
8282S	✓			
8284	✓			
8285	✓			
8286	✓			
8287	✓			
8290	✓			
8293	✓			
8297C	✓			
8297F	✓			
8381SX	✓			
8702...	✓	✓		
8709...	✓	✓		



Beta Collection



Exkluzív termékek, amelyek által a Beta karaktere jut kifejezésre, több mint 200 kiváló minőségű, eredeti termék: sportruházat, technikai ruházat és számos személyes ajándék. Ideális reklámkampányhoz, elengedhetetlen a kikapcsolódáshoz.



9500TL

softshell, 100% poliészter szövet 320 g, háromrétegű mikroszálás külső, középső vízhatlan és szellőző membrán, polár belső



	Ft		
S	52.700	1	095000051
M	52.700	1	095000052
L	52.700	1	095000053
XL	52.700	1	095000054
XXL	52.700	1	095000055

9501TLD

CVC női felső, 80% pamut, 20% poliészter, 320 g/m²



	Ft		
S	25.750	1	095010061
M	25.750	1	095010062
L	25.750	1	095010063
XL	25.750	1	095010064

9501TL

CVC férfi felső, 80% pamut, 20% poliészter, 320 g/m²



	Ft		
S	30.150	1	095010051
M	30.150	1	095010052
L	30.150	1	095010053
XL	30.150	1	095010054
XXL	30.150	1	095010055

9502TL

pólóing, 100% piqué pamut, 210 g



	Ft		
S	17.700	1	095020051
M	17.700	1	095020052
L	17.700	1	095020053
XL	17.700	1	095020054
XXL	17.700	1	095020055

9504TL

dzseki, kívül 100% poliészter, vízhatlanított



	Ft		
S	36.050	1	095040051
M	36.050	1	095040052
L	36.050	1	095040053
XL	36.050	1	095040054
XXL	36.050	1	095040055

9508TL

vízálló dzseki, 100% poliészter, összehajtható



	Ft		
S	29.600	1	095080051
M	29.600	1	095080052
L	29.600	1	095080053
XL	29.600	1	095080054
XXL	29.600	1	095080055

9599 GARAGE

Beta Garage pólóing szellőző poliészterből, 175 g/m², fekete



	Ft		
S	7.740	1	095999011
M	7.740	1	095999012
L	7.740	1	095999013
XL	7.740	1	095999014
XXL	7.740	1	095999015

9505TL

ujjatlan dzseki, kívül 100% poliészter, vízhatlanított, 100 g/m² bélés, belső zsebbel



	Ft		
S	43.600	1	095050051
M	43.600	1	095050052
L	43.600	1	095050053
XL	43.600	1	095050054
XXL	43.600	1	095050055

9510W

elasztikus hosszú ujjú férfi ing, 120 g/m², 97% pamut, 3% elasztán. Fehér, fekete logóval. Hátsó vállrésznél két oldalt szűkítővarrás, félcápa gallér. Fehér gombok, két mandzsettagomb. Slim fit



	Ft		
XS	21.300	1	095100100
S	21.300	1	095100101
M	21.300	1	095100102
L	21.300	1	095100103
XL	21.300	1	095100104
XXL	21.300	1	095100105

9503TL

póló, 100% jersey pamut, 160 g



	Ft		
S	11.700	1	095030051
M	11.700	1	095030052
L	11.700	1	095030053
XL	11.700	1	095030054
XXL	11.700	1	095030055

9572LB

Beta-March póló, 100% pamut, 200 g/m² narancsszínű, fekete betétekkel



	Ft		
S	13.400	1	095720801
M	13.400	1	095720802
L	13.400	1	095720803
XL	13.400	1	095720804
XXL	13.400	1	095720805

9534WO

kétgombos pólóing, pamutdszörz, 200 g/m², narancsszínű betétekkel



	Ft		
S	16.400	1	095340031
M	16.400	1	095340032
L	16.400	1	095340033
XL	16.400	1	095340034
XXL	16.400	1	095340035

953480

kétgombos pólóing, pamutdszörz, 200 g/m²,
kék, szürke betétekkel



	Ft		
S	16.400	1	095340071
M	16.400	1	095340072
L	16.400	1	095340073
XL	16.400	1	095340074
XXL	16.400	1	095340075

95377L

polár pulóver, 100% poliészter



	Ft		
S	17.750	1	095370051
M	17.750	1	095370052
L	17.750	1	095370053
XL	17.750	1	095370054
XXL	17.750	1	095370055

9580S

napszemüveg

CE



EN ISO 12312-1:2013+A1:2015
UV400
FILTER CAT. III

	Ft		
9580S	9.030	1	095800100

9593S

érintőképernyős okosóra, fitneszmérő, szilikon
pánt



	Ft		
9593S	43.650	1	095930200

9593SB

multifunkciós okoskarkötő, érintőképernyő,
fitneszmérő, pulzuszámoló, lépésszámláló,
alvásfygelő, szilikon pánt, fekete

Kompatibilitás: IOS 8.2 vagy újabb / Android 4.4 vagy újabb
Bluetooth 4.2
IP67

CE



IP67

	Ft		
9593SB	30.900	1	095930205

9593M

automata óra, acélház, 5 ATM vízálló, acél
szíjjal



	Ft		
9593M	94.100	1	095930120

9593A

kronográf óra, acélház, vízálló 5 ATM,
szilikon szíj



	Ft		
9593A	82.750	1	095930050

9593W

analog óra, soft touch műanyag ház
acélgyűrűvel,
vízálló 3 ATM, szilikon szíj



	Ft		
9593W	16.350	1	095930150

9544C

keményfalú gurulós bőrönd 4 dupla kerékkel,
TSA zár, USB csatlakozó + 3,5 mm jack



	L	S	H	Ft		
	cm	cm	cm			
9544C	40	20	55	35.900	1	095440101

Beta

9557J 2.0

bevont szövet/poliészter sporttáska, oxford 600d, méret 47x28x25 cm



	L	S	H	Ft		
	cm	cm	cm			
9557J 2.0	47	25	28	24.750	1	095570020

9557N

„Racing“-táska laminált PVC, vízálló



	L	S	H	Ft		
	cm	cm	cm			
9557N	35	35	80	31.950	1	095570001

9541F

bevont szövet/poliészter hátizsák, oxford 600D, méret 50x33x16 cm



	L	S	H	Ft		
	cm	cm	cm			
9541F	33	16	50	23.450	1	095410011

9541PC

sokszemes munkahátizsák laptartó rekesszel, 100% poliészter

- 3 rekeszes hátizsák vízzáró cipzárral
- laptartó rekesz
- párnázott hordozó fül
- USB csatlakozó
- hálós palack-/esernyőtartó oldalzseb
- vállpánton szemüvegtartó zseb
- állítható mellheveder



	L	S	H	Ft		
	cm	cm	cm			
9541PC	34	18	52	18.650	1	095410041

9541S

Hátizsák vízálló béléssel, 210D vízálló poliészter, 33x45 cm



	L	H	Ft		
	cm	cm			
9541S	33	45	2.900	1	095410031

9541BIKE

oxford poliészter hátizsák, méret 41x24x16 cm



	L	S	H	Ft		
	cm	cm	cm			
9541BIKE	24	16	41	5.630	1	095410021

95740

munkakesztyű, elasztizált gumis csuklórésszel, erősített hüvelykujj és mutatóujj, érintőképernyős eszközök használatra alkalmas műbőrrel

CE



	Ft		
M	9.390	1	095740202
L	9.390	1	095740203
XL	9.390	1	095740204
XXL	9.390	1	095740205

9574B

munkakesztyű, elasztizált gumis csuklórésszel, erősített hüvelykujj és mutatóujj, érintőképernyős eszközök használatra alkalmas műbőrrel

CE



	Ft		
M	9.390	1	095740102
L	9.390	1	095740103
XL	9.390	1	095740104
XXL	9.390	1	095740105

9525TL

Top Line sapka



	Ft		
9525TL	7.390	1	095250010

9525F

sapka



	Ft		
9525F	7.310	1	095250099

9525/B

Baseball sapka, 100% pamut, egy méretben, állítható, elöl, oldalt és hátul hímzett, fehér



	Ft		
9525B	4.100	5	095251031

9521

automata fekete nejlon esernyő, T210 alumínium tokszár, 3 szelvény



	Ft		
9521	8.330	1	095210000

95210B

esernyő 210T nylon, 100 cm átmérő



	cm	Ft	
95210B	100	9.130	1 095210021

9599CB-N2

Atala® city bike, Hi-Ten Tig TKK 700c váz, Shimano® Tourney RD-TZ50 6 sebességes hátsó váltó, V-Brakes® fék, 28" alumínium kerekek, csomagtartóval, kitámasztóval és csengővel, matt fekete



	Ft		
9599CB-N2	212.700	1	095990031

9599CB-W

Atala® city bike, alumínium váz, shimano® 6 fokozatú sebességváltó, V-Brake® fékek 28" alumínium kerekek



	Ft		
9599CB-W	205.800	1	095990023

9598W-N

Whistle® mountain bike, alumínium váz, Suntour XCT30 villa, 29" 100 mm, Shimano RD-TX500 hátsó váltó, 7 sebességes, hidraulikus Shimano BR-M200 tárcsafék és 29" alumínium kerék, fluoreszkáló narancsszín / matt antracitszürke



	Ft		
9598W-N M	318.400	1	095980130
9598W-N L	318.400	1	095980132

9598WHP-N

Whistle® mountain bike, alumínium váz, Suntour XCM PL villa, 29" 100 mm, kormányról vezérelhető lockout, Shimano XT RD-M8100 Shadow Plus hátsó váltó, 12 sebességes, hidraulikus Shimano BL-MT201/BR-MT200 tárcsafék és 29" alumínium kerék, fehér / matt vörös



	Ft		
9598WHP-N M	584.300	1	095980140
9598WHP-N L	584.300	1	095980142

9515M

műszaki szövet trikó, szellőzik és gyorsan szárad; hálós oldalbetétek



	Ft		
S	23.300	1	095150051
M	23.300	1	095150052
L	23.300	1	095150053
XL	23.300	1	095150054
XXL	23.300	1	095150055
XXXL	23.300	1	095150056

9516B

rövidnadrág, Lycra 180 g, szellőzik, gyorsan szárad, gumírozott derékkal a jobb viselhetőségért



	Ft		
S	27.350	1	095160051
M	27.350	1	095160052
L	27.350	1	095160053
XL	27.350	1	095160054
XXL	27.350	1	095160055
XXXL	27.350	1	095160056

9539CB

kerékpáros bukósisak levehető állvédővel, állítható méret



	Ft		
S-M	48.250	1	095390010
L-XL	48.250	1	095390011

9542M

légáteresztő mikroszálás rövidujjú trikó, fedett hosszú cipzár, három hátsó zseb, egyikük cipzárral, szilikon gumi a trikó szélén



	Ft		
S	34.100	1	095420051
M	34.100	1	095420052
L	34.100	1	095420053
XL	34.100	1	095420054
XXL	34.100	1	095420055
XXXL	34.100	1	095420056

Beta
Quality Tools

9542C

lycra kertész nadrág, szilikon gumi a lábnál, antibakteriális légáteresztő ülőbetéttel



	Ft		
S	34.050	1	095420061
M	34.050	1	095420062
L	34.050	1	095420063
XL	34.050	1	095420064
XXL	34.050	1	095420065
XXXL	34.050	1	095420066

9542GW

téli dzseki, szélálló és jó légáteresztő képességű szövetből és bolyhos szövetből; hosszú cipzár, szilikonmentes gumirozott sáv deréktájon; hozzásimuló Lycra csuklórés; hátsó fényvisszaverő betétek, 3 külső hátsó zseb, egyikük cipzáras



	Ft		
S	62.800	1	095420101
M	62.800	1	095420102
L	62.800	1	095420103
XL	62.800	1	095420104
XXL	62.800	1	095420105
XXXL	62.800	1	095420106

Beta

9542G

Téli trikó, légáteresztő szövet béléssel, hosszú cipzár, hátul három zseb, szilikon gumi a trikó szélén



	Ft		
S	31.300	1	095420012
M	31.300	1	095420013
L	31.300	1	095420014
XL	31.300	1	095420015
XXL	31.300	1	095420016
XXXL	31.300	1	095420017

9542S

Téli sport nadrág, Lycra, antibakteriális légáteresztő ülőbetéttel



	Ft		
S	46.650	1	095420022
M	46.650	1	095420023
L	46.650	1	095420024
XL	46.650	1	095420025
XXL	46.650	1	095420026
XXXL	46.650	1	095420027

9542AT

téli ujjatlan mellény, légáteresztő kombinált szövetből, hosszú cipzár



	Ft		
S	27.050	1	095420072
M	27.050	1	095420073
L	27.050	1	095420074
XL	27.050	1	095420075
XXL	27.050	1	095420076
XXXL	27.050	1	095420077

9542AL

hosszú ujjú szélvédő, vízálló, légáteresztő textilköpeny



	Ft		
S	40.000	1	095420042
M	40.000	1	095420043
L	40.000	1	095420044
XL	40.000	1	095420045
XXL	40.000	1	095420046
XXXL	40.000	1	095420047

9543C

csőszál, 100% mikroszál as poliészter, varratmentes



	L cm	H cm	Ft		
9543C	25	50	2.440	1	095430100

Beta

Beta

9523T

rozsdamentes acél termosz, 500 ml,
kétrétegű vákuumtechnológia,
csepegésmentes kupak,
narancsszín

- a hideg italokat 24 órán át hidegen tartja
- a meleg italokat 12 órán át melegen tartja



EC1935/EC2023

	ml	L	Ft		
9523T	500	255	5.410	1	095230050

9528B

Műanyag palack, 500 ml



	ml	Ft		
9528B	500	1.970	1	095280005

9597P

oszlopos pumpa nyomásmérővel

- Adapter az összes kerékpár szeleptípushoz (Schrader, Presta/Sclaverand, Regina)
- Maximum nyomás: 12 bar/ 180 psi



	Ft		
9597P	18.600	1	095970100

9524SC

Miniatűr Beta műhely/garázs berendezés
gyűjtők részére



	Ft		
1:18	26.150	1	095240018

9548KB

futóbicikli, acél váz, 12" kerék belső gumival,
3 éves kortól ajánlott, legnagyobb teherbírás:
30 kg



	Ft		
9548KB	44.500	1	095480110

9548KB 20

Atala® 20" gyermek mountain bike, Hi-Ten Tig
20" acélváz, 30-mm teleszkópos villa, RD-
TY21SS 6V hátsó váltó, alumínium V-fék és
36 lyukas alumínium kerék,
fluoreszkáló sárga / matt kék



	Ft		
9548KB 20	151.200	1	095480120

9548KB 24

Atala® 24" gyermek mountain bike, Hi-Ten
Tig 24" acélváz, teleszkópos villa, Shimano
Tourney RD-TYZ50 6V hátsó váltó, alumínium
V-fék és 36 lyukas alumínium kerék,
matt fluoreszkáló narancsszín



	Ft		
9548KB 24	160.800	1	095480122

Beta

9547WSK

„Kinder Work Station“ munkapad
szerszámokkal 3 éves kortól

CE



	H cm	Ft		
9547WSK	74	29.500	1	095473801

9547T

„Kinder trolley“, szerszámkocsi szerszámokkal
3 év feletti gyermekek számára

CE



	Ft		
9547T	18.450	1	095470100

9548G

„Kinder Garage“ 6 szintes, autómóssal, lifttel
és rámpákkal



	H cm	Ft		
9548G	69	18.700	1	095480100

9561V 2,5

reklámszázló 2,5x0,50 m
aluminium zászlórúddal,
keresztalpap gyűrű alakú súllyal



	L m	H m	Ft		
9561V 2,5	0,50	2,5	74.400	1	095610200

9561VV 2,5

reklámszázló 2x0,50 m,
zászlórúddal



	L m	H m	Ft		
9561VV 2,5	0,50	2,5	66.550	1	095610201

9561VV

reklámszázló 3,50x0,75 m,
zászlórúddal



	L m	H m	Ft		
9561VV	0,75	3,50	73.500	1	095610101

9561V

vitorlazászló, 4x0,75 m
krómozott fém rúd
50 cm-es cementöntvény talp



	L m	H m	Ft		
9561V	0,75	4	110.700	1	095610001

9559

Egyoldalon nyomott reklámfelirat, 3x0,8 m



	L m	H m	Ft		
9559	3	0,8	7.840	1	095591001

9559/30MT

10 db nemszövet Beta logó tekercs



	Ft		
9559/30MT	67.800	1	095591031

9590B

feliratozott nylon zászló
40 x 215 cm



	L cm	H cm	Ft		
9590B	215	140	34.800	1	095900000

9577R

munkaoverál, motorsport stílus, elastikus
szöveg, 260 g/m², fekete-narancs, fehér és
fényvisszaverő betétekkel

CE



	I	Ft		
S	48	38.050	1	095770151
M	50	38.050	1	095770152
L	52	38.050	1	095770153
XL	54	38.050	1	095770154
XXL	56	38.050	1	095770155
XXXL	58	38.050	1	095770156

9579C

Munkaköpeny, poliészter/pamut



	Ft		
M	18.350	1	095791002
L	18.350	1	095791003
XL	18.350	1	095791004

9565BBQ

lemezacél grillhordó ráccsal, parázstartóval és
zárható fedéllel

Krómozott acélgrill (a 21/03/73 olasz miniszteri rendeletnek és az élelmiszerekkel rendeltetésszerűen kapcsolatba kerülő anyagokról és tárgyakról szóló 1935/2004/EK rendeletnek megfelelően) fogóval és lábbal



	H cm	ø cm	Ft		
9565BBQ	88	59	170.900	1	095650100

9565T

lemezacél hordóasztal lakkozott rétegelt nyírfa
asztallappal

A függőleges beállításhoz dupla távtartó csövekkel (7 cm és 20 cm) szállítva.



	H cm	ø cm	Ft		
9565T	95 → 108	70	145.300	1	095650200

9565S

lemezacél hordószék kivehető műbőrrel



	H cm	Ø cm	Ft		
9565S	60	38	65.200	2	095650300

9565ICE

lemezacél jégtároló hordó fedéllel

- Karcolásmentes tartállyal, élelmiszer célú felhasználásra tanúsítva
- A belső oldalon rozsdagátló, vízálló festék bevonat
- A tartályt jéggel feltöltve palackos és dobozos italok hűthetők



	H cm	Ø cm	Ft		
9565ICE	60	38	69.000	1	095650400

9565K

hordóasztal két székkal



	Ft		
9565K	275.700	1	095650500

9563G

irodai fotel, vendégeknek



	Ft		
9563G	43.350	1	095630050

9563U

ergonómikus irodai fotel



	Ft		
9563U	86.800	1	095630020

9549ABW

vezeték nélküli Bluetooth V5.0 fülhallgató beépített mikrofonnal, mágneses töltés, USB-C töltőállomás, fekete

CE



	L mm	H mm	S mm	Ft		
9549ABW	61	34,5	41	9.210	1	095490091

9549SBW

vezeték nélküli, hordozható Bluetooth hangszóró, 6 funkció

Bluetooth verzió: 5.0

FUNKCIÓK:

- Bluetooth lejátszás
- Lejátszás TF kártyáról
- Lejátszás USB-ről
- 3.5 mm jack aljzat
- FM rádió
- hívás funkció

CE



	L mm	S mm	H mm	Ft		
9549SBW	73	73	124	10.950	1	095490072

9549BP

hordozható akkumulátor 10000mAh



	Ft		
9549BP	6.330	1	095490052

9549CR

4 az 1-ben töltőkábel, fonott nejlon, gyors töltés támogatás

- USB-A tápegység csatlakozó

- Lightning csatlakozó Apple termékekhez
- Micro USB töltőcsatlakozó
- USB-C töltőcsatlakozó
- USB-C töltő- és adatátviteli csatlakozó



	L mm	Ft		
9549CR	120	4.770	1	095490042

9549MPC

multiport töltőállomás, 6 USB csatlakozó egyszerre több eszköz töltéséhez maximum 65W felvett teljesítményig

- 4 USB aljzat, 5V 2.4A
- 1 USB aljzat, Q.C 3.0
- 1 USB-C aljzat, 20W PD

önálló KI/BE kapcsolóval, Watt összteljesítményt, port számot és áramerősséget jelző LED

CE



	L mm	S mm	H mm	Ft		
9545MPC	110	72	35	13.450	1	095490082

9549BRW

vezetéknélküli töltő állomás,
gyorstöltő funkcióval és töltöttségi szint
kijelzéssel

- 1 m hosszú, adapterhez csatlakoztatható USB-USB C kábellel szállítva
- Minden vezeték nélküli töltést támogató eszközzel kompatibilis
- Bemenet: DC 5V/2A, 9V/2A, 12V/1.5A
- Kimenet: 5W/ 7.5W/ 10W/ 15W

CE



	Ø	H	Ft		
9549BRW	mm	mm		1	095490100
	58	6	7.690		

9549C

USB kulcs, 32 GB



	Ft		
9549C	4.600	1	095490062

9547

Asztali számológép

CE



	Ft		
9547	5.500	1	095470000

9594

Falióra hő- és levegő páratartalommérővel,
átmérő 26 cm



	Ø	Ft	
9594	cm		1 095940051
	26	9.080	

9526P

kapszulás espresszó kávéfőző gép

Lavazza™, Espresso Point™ kapszula kompatibilitás
professzionális használatra



	Ft		
9526P	100.100	1	095260010

9527 6T

6 darabos kávécsésze készlet



	Ft		
9527 6T	27.900	1	095270001

9527MUG

"mug" bögre, szilikon fedél és csík



	Ft		
9527MUG	7.510	1	095270020

9522A

ergonomikus sömnyítő



	Ft		
9522A	5.340	1	095220010

9523A

alumínium palack, 500 ml



	ml	Ft	
9523A	500	3.280	1 095230005

9586K

többfunkciós acél zsebkész,
10 funkció



	Ft		
9586K	4.380	1	095860100

9526RMN

két csomag 55 lapos Modiano® francia kártya



	Ft		
9526RMN	8.240	1	095260001

9592B/C50

50 darabos golyóstoll készlet



	Ft		
9592B/C50	14.300	1	095920050

9592B/P

feliratozott golyóstoll



	Ft		
9592B/P	380	500	095920051

9592MB

Parker® golyóstoll



	Ft		
9592MB	22.600	1	095920060

9592M/50

50 darabos ceruza készlet



	Ft		
9592M/50	14.850	1	095920100

9588M

puha hőformált tálcá 1 tollal és 2 notesszel



9588M Ft 6.310 1 095880011

9596

Nyakba akasztható telefontartó fém karabinerrel



9596 Ft 1.280 10 095961001

9595C

bőr kulcstartó



9595C Ft 2.400 1 095950011

9595T

krómozott fém kulcstartó, bársonyokban



9595T Ft 2.160 1 095950021

9595 C25

krómozott fém kulcstartó gumihoroggal



9595 C25 Ft 2.510 1 095950031

9569P

Poliétilén bevásárló szatyor



9569P L 34 cm H 44 cm Ft 200 50 095691001

9569S

nemszövet harmonikás bevásárló szatyor, 38x42 cm



9569S L 38 cm H 42 cm Ft 680 50 095690051

9569MS-2

tartós polipropilén bevásárló szatyor



9569MS-2 L 45 cm H 40 cm Ft 1.780 5 095690055

9569MS

tartós polipropilén bevásárló szatyor, duplafüles



9569MS L 60 cm H 40 cm Ft 1.780 5 095690052

9587 9x14

jegyzetfüzet, 9x14 cm



9587 9X14 L 9 cm H 14 cm Ft 3.800 5 095870009

9587 13x21

jegyzetfüzet, 13x21 cm



9587 13X21 L 13 cm H 21 cm Ft 4.990 5 095870013

9588S/10...

Jegyzetömb



9588S/10A Ft 6.100 1 095881001
21x29 cm
9588S/10B Ft 6.370 1 095881002
15x21 cm
9588S/10C Ft 4.410 1 095881003
10x15 cm
9588S/10D Ft 3.440 1 095880054
7,5x10,5 cm

Beta

9588/10PI

Jegyzetömb + öntapadós lapok



9588S/10PI	Ft	1	095880055
7,5x7,5 cm	7.630		

9589A/36

36 tekercs ragasztószalag Beta logoval, barna



9589A/36	Ft	1	095890035
	42.200		

9589B/36

36 tekercs ragasztószalag Beta logoval, fehér



9589B/36	Ft	1	095890036
	42.200		

9562TB

cipő szőnyeg, csúszásmentes, gumibevonatú alsórész



9562TB	L mm	H mm	Ft	1	095620500
	800	600	12.850		

9562T2

munkapad alátétszőnyeg, 200x160 cm

- Védi a padlót az olaj- és benzincsoepektől, környezetbarát
- Könnyen tisztítható, csúszásmentes, gumibevonatú alsórész



9562T2	L cm	H cm	Ft	1	095620200
	200	160	66.300		

9562T1

garázs szőnyeg, 100x80 cm

- különösen alkalmas a BETA 3071 és 3071B motorkerékpár emelő alá
- Könnyen tisztítható, csúszásmentes, gumibevonatú alsórész



9562T1	L cm	H cm	Ft	1	095620150
	100	80	22.400		

9562T3

garázs szőnyeg

Méret: 300x160 cm

- Különösen alkalmas motorkerékpár emelők alá

- Védi a padlót az olaj- és benzincsoepektől, környezetbarát
- Könnyen tisztítható, csúszásmentes, gumibevonatú alsórész



9562T3	L cm	H cm	Ft	1	095620300
	300	160	96.900		

9562P2

multilogo szőnyeg, 200x80 cm

- különösen alkalmas a C55 műhelyberendezéshez vagy motorkerékpár alá



9562P2	L cm	H cm	Ft	1	095620400
	200	80	47.150		

9562P12

multilogo szőnyeg tekercs, 12 m x 80 cm

A szőnyeg tetszőleges méretűre vágható



9562P12	L m	H cm	Ft	1	095620425
	12	80	240.600		



Beta

MEGSZŪNT TERMÉKEK – HELYETTESÍTŐ/AJÁNLOTT TERMÉKEK

	MEGSZŪNT TERMÉK
	HELYETTESÍTŐ TERMÉK
	JAVASOLT TERMÉK

96AS/G7	000960745		
111 100	001110010	111E 100	001110110
111 150	001110015	111E 150	001110115
111 200	001110020	111E 200	001110120
111 250	001110025	111E 250	001110125
111 300	001110030	111E 300	001110130
111 380	001110038	111E 380	001110138
111 450	001110045	111E 450	001110145
111 600	001110060	111E 600	001110160
111N 100	001110210	111EN 100	001110410
111N 150	001110215	111EN 150	001110415
111N 200	001110220	111EN 200	001110420
111N 250	001110225	111EN 250	001110425
111N 300	001110230	111EN 300	001110430
111N 380	001110238	111EN 380	001110438
111N 450	001110245	111EN 450	001110445
111G 200	001110620	111CM 170	001110770
111G 250	001110625	111CM 220	001110722
111G 300	001110630	111CM 270	001110727
111HS 200	001114020	111E-HS 200	001114120
111HS 250	001114025	111E-HS 250	001114125
111HS 300	001114030	111E-HS 300	001114130
111HS 380	001114038	111E-HS 380	001114138
111HS 450	001114045	111E-HS 450	001114145
111K 100	001119010		
111K 150	001119015		
111K 200	001119020		
111K 250	001119025		
111K 300	001119030		
410/SPV1	004100420	410/SPVP1	004100421
410/SPV2	004100426	410/SPVP2	004100427
412/SPV1	004120420	410/SPVP1	004100421
412/SPV2	004120426	410/SPVP2	004100427
414/SPV1	004140420	410/SPVP1	004100421
414/SPV2	004140426	410/SPVP2	004100427
415/SPV1	004150420	410/SPVP1	004100421
415/SPV2	004150426	410/SPVP2	004100427
442 22	004420022		
442 24	004420024		
564-3R/VA	005640603	564-3R/V	005640613
564-4R/VA	005640604	564-4R/V	005640614
588	005880001	680/3	006800000
677/50	006770050	677/600	006770006
677/70	006770070	677/800	006770008
677/100	006770100	677/1000	006770010
677/CV1	006770450	677/CVN1	006770455
677/C50	006770606	677/C600	006770607

677/C70	006770611	677/C800	006770612
677/C100	006770615	677/C1000	006770616
677/C150	006770620	677/C1500	006770621
677/CP200	006770720	677/CP2000	006770721
680/2,5	006800002	680/30	006800003
680/40	006800040	680/350	006800035
680/100	006800100	680/2100	006800210
920/55L	009200927		
970OT 65	009700165		
970OT 80	009700180		
970OT 96	009700196		
970OT 111	009700211		
970EA 98	009700398		
970EB 110	009700410		
970EB 95	009700595		
970Q 56	009700756		
970Q 60	009700760		
970C 80	009700808		
970C 95	009700815		
970C 100	009700820		
970C 109	009700829		
970C 115	009700835		
970C 120	009700840		
1046 240	010460240	1044F 250	010440015
1046 400	010460400		
1046K 240	010469240	1044FK 250	010449015
1048 175	010480010	1048N 175	010480910
1048 250	010480015	1048N 250	010480915
1048 300	010480020	1048N 300	010480920
1048V 175	010480110	1048VN 175	010480111
1048V 250	010480115	1048VN 250	010480116
1048V 300	010480120	1048VN 300	010480121
1048K 175	010489010	1048NK 175	010489910
1048VK 250	010489025	1048VNK 250	010489116
1048VK 175	010489110	1048VNK 175	010489111
1048K 250	010489250	1048NK 250	010489915
1309	013090001		
1313	013130001		
1362	013620010	1362B	013620011
1450GC	014500005		
1461/C3B	014610032		
1461/C8G	014610084		
1461/C10G	014610103		
1461/C11G	014610113		
1461/C12G	014610124		
1461/C13A	014610133		
1461/C17B	014610171		
1461/C22B	014610223		
1461/C31B	014610232		

1473Q	014730005		
1498MN/12	014980000	1498BC/12	014980040
1569/A	015690011	1569/SB	015690016
1569/B	015690015	1569/SB	015690017
1590 75	015900307		
1590 125	015900312		
1640K	016400001		
1640T 22,5	016400022		
1640T 25,5	016400025		
1640T 32,5	016400032		
1640T 55,5	016400055		
1640Q 45	016400065		
1640A	016400080		
1640P/9	016400088		
1640P/19	016400089		
1640	016400100		
1651DGT 150	016510111	1651DGTB 150	016510211
1651DGT 200	016510112	1651DGTB 200	016510212
1651DGT/IP	016510611	1651DGTB/IP	016510711
1658DGT25	016580325	1658DGTB 25	016580525
1658DGT50	016580350	1658DGTB 50	016580550
1729	017290001		
1729LR	017290010		
1751 200	017510002	1751N 200	017510020
1751 300	017510003	1751N 300	017510030
1751 500	017510005	1751N 500	017510050
1751 750	017510007	1751N 750	017510075
1751R	017510010	1751NR	017510110
1751 1000	017510011	1751N 1000	017510100
1778D	017780060	1778P	017780088
1778U	017780070	1778AN	017780065
1836A	018360050	1836AW	018360051
1838SL	018380101		
1838S	018380122	1838SW	018380142
1860 160A	018600006	1860BHT/160A	018600179
1860RC/140A	018600604		
1860RC/160A	018600606		
1937 2,5	019370000		
1947M	019470021	1947H	019470011
1947M-ST	019470025		
1947M-T	019470026		
1947M-P	019470027		
1949F	019490027	1949F2	019490028
1949G	019490035		
2029/RT	020290900	C9/RT	021090900
2060/VV	020600101		
2200-COVER RSC22	022000910		
2251-O	022510011		
2252-O	022520001		
2252-R	022520003		

MEGSZÜNT TERMÉKEK – HELYETTESÍTŐ/AJÁNLOTT TERMÉKEK

	MEGSZÜNT TERMÉK
	HELYETTESÍTŐ TERMÉK
	JAVASOLT TERMÉK

2300-COVER RSC23	023000920		
2300-COVER RSC23T	023000930		
TV110	024000477		
T56	024240056		
T110	024240110	T111	024240111
TV56	024249901		
M199	024500199	M201	024500201
M202	024500202	M201	024500201
MV130	024510130		
MV153	024510153		
MV199	024510199		
MV202	024510202		
MV292	024510292		
MV165	024510874		
MBV11	024524211		
MBV34	024524234		
MMV140	024590140		
MCV20	027510020		
3000M/RLS	030000206	3000L/RLS	030000212
3000M/LT	030000220	3000L	030000210
C35/6G	035000062	C35/6GM	035000162
C35/7G	035000072	C35/7GM	035000172
C35/8G	035000082	C35/8GM	035000182
C35/9G	035000092	C35/9GM	035000192
3500/P	035000502		
4100-COVER C41H	041000930		
C43	043000003	C42H	042000002
C45PRO PA	045000280	C45PRO PAS	045000290
C50S-O	050000301	RSC51-FO	051000300
C50S-G	050000302	RSC51-A	051000307
C50S-R	050000303	RSC51-R	051000303
5000MS	050000901	2400 RSC24/MP	024004900
C59A-O	059000001	C59A-O	059000011
C59B-O	059000002	C59B-O	059000012
C59C-O	059000003	C59C-O	059000013
C59A-G	059000021	C59A-A	059000031
C59B-G	059000022	C59B-A	059000032
C59C-G	059000023	C59C-A	059000033
C59A-R	059000041	C59A-R	059000051
C59B-R	059000042	C59B-R	059000052
C59C-R	059000043	C59C-R	059000053
5904VU/2M	059041202	5904VU/2M	059041212
7051MP	070510001		
7212FG 35	072120035	7212G 35	072120335
7212FG 36	072120036	7212G 36	072120336
7212FG 37	072120037	7212G 37	072120337
7212FG 38	072120038	7212G 38	072120338

7212FG 39	072120039	7212G 39	072120339
7212FG 40	072120040	7212G 40	072120340
7212FG 41	072120041	7212G 41	072120341
7212FG 42	072120042	7212G 42	072120342
7212FG 43	072120043	7212G 43	072120343
7212FG 44	072120044	7212G 44	072120344
7212FG 45	072120045	7212G 45	072120345
7212FG 46	072120046	7212G 46	072120346
7212FG 47	072120047	7212G 47	072120347
7212FG 48	072120048	7212G 48	072120348
7213FG 35	072130035	7213G 35	072130135
7213FG 36	072130036	7213G 36	072130136
7213FG 37	072130037	7213G 37	072130137
7213FG 38	072130038	7213G 38	072130138
7213FG 39	072130039	7213G 39	072130139
7213FG 40	072130040	7213G 40	072130140
7213FG 41	072130041	7213G 41	072130141
7213FG 42	072130042	7213G 42	072130142
7213FG 43	072130043	7213G 43	072130143
7213FG 44	072130044	7213G 44	072130144
7213FG 45	072130045	7213G 45	072130145
7213FG 46	072130046	7213G 46	072130146
7213FG 47	072130047	7213G 47	072130147
7213FG 48	072130048	7213G 48	072130148
7217FG 35	072170235	7212B 35	072120235
7217FG 36	072170236	7212B 36	072120236
7217FG 37	072170237	7212B 37	072120237
7217FG 38	072170238	7212B 38	072120238
7217FG 39	072170239	7212B 39	072120239
7217FG 40	072170240	7212B 40	072120240
7217FG 41	072170241	7212B 41	072120241
7217FG 42	072170242	7212B 42	072120242
7217FG 43	072170243	7212B 43	072120243
7217FG 44	072170244	7212B 44	072120244
7217FG 45	072170245	7212B 45	072120245
7217FG 46	072170246	7212B 46	072120246
7217FG 47	072170247	7212B 47	072120247
7217FG 48	072170248	7212B 48	072120248
7219FY 35	072190035	7214G 35	072140235
7219FY 36	072190036	7214G 36	072140236
7219FY 37	072190037	7214G 37	072140237
7219FY 38	072190038	7214G 38	072140238
7219FY 39	072190039	7214G 39	072140239
7219FY 40	072190040	7214G 40	072140240
7219FY 41	072190041	7214G 41	072140241
7219FY 42	072190042	7214G 42	072140242
7219FY 43	072190043	7214G 43	072140243
7219FY 44	072190044	7214G 44	072140244
7219FY 45	072190045	7214G 45	072140245
7219FY 46	072190046	7214G 46	072140246
7219FY 47	072190047	7214G 47	072140247

7219FY 48	072190048	7214G 48	072140248
7328EA 38	073280538	7328A 38	073280638
7328EA 39	073280539	7328A 39	073280639
7328EA 40	073280540	7328A 40	073280640
7328EA 41	073280541	7328A 41	073280641
7328EA 42	073280542	7328A 42	073280642
7328EA 43	073280543	7328A 43	073280643
7328EA 44	073280544	7328A 44	073280644
7328EA 45	073280545	7328A 45	073280645
7328EA 46	073280546	7328A 46	073280646
7328EA 47	073280547	7328A 47	073280647
7328EN 38	073280738	7328N 38	073280838
7328EN 39	073280739	7328N 39	073280839
7328EN 40	073280740	7328N 40	073280840
7328EN 41	073280741	7328N 41	073280841
7328EN 42	073280742	7328N 42	073280842
7328EN 43	073280743	7328N 43	073280843
7328EN 44	073280744	7328N 44	073280844
7328EN 45	073280745	7328N 45	073280845
7328EN 46	073280746	7328N 46	073280846
7328EN 47	073280747	7328N 47	073280847
7340R 36	073400436		
7340R 37	073400437		
7340R 38	073400438		
7340R 39	073400439		
7340R 40	073400440		
7340R 41	073400441		
7340R 42	073400442		
7340R 43	073400443		
7340R 44	073400444		
7340R 45	073400445		
7340R 46	073400446		
7340R 47	073400447		
7525 XS	075250046	7530 XS	075300046
7525 S	075250048	7530 S	075300048
7525 M	075250050	7530 M	075300050
7525 L	075250052	7530 L	075300052
7525 XL	075250054	7530 XL	075300054
7525 XXL	075250056	7530 XXL	075300056
7525 XXXL	075250058	7530 XXXL	075300058
7579T S	075790001	7579QN S	075790201
7579T M	075790002	7579QN M	075790202
7579T L	075790003	7579QN L	075790203
7579T XL	075790004	7579QN XL	075790204
7579T XXL	075790005	7579QN XXL	075790205
7579T XXXL	075790006	7579QN XXXL	075790206
7634G XS	076340100	7637G XS	076370000
7634G S	076340101	7637G S	076370001
7634G M	076340102	7637G M	076370002
7634G L	076340103	7637G L	076370003
7634G XL	076340104	7637G XL	076370004

MEGSZÜNT TERMÉKEK – HELYETTESÍTŐ/AJÁNLOTT TERMÉKEK

	MEGSZÜNT TERMÉK
	HELYETTESÍTŐ TERMÉK
	JAVASOLT TERMÉK

7634G XXL	076340105	7637G XXL	076370005
7634G XXXL	076340106	7637G XXXL	076370006
7634B XS	076340200		
7634B S	076340201		
7634B M	076340202		
7634B L	076340203		
7634B XL	076340204		
7634B XXL	076340205		
7634B XXXL	076340206		
7780T S	077800101	7780QN S	077800201
7780T M	077800102	7780QN M	077800202
7780T L	077800103	7780QN L	077800203
7780T XL	077800104	7780QN XL	077800204
7780T XXL	077800105	7780QN XXL	077800205
7780T XXXL	077800106	7780QN XXXL	077800206
7810 S	078100101	7600G S	076000001
7810 M	078100102	7600G M	076000002
7810 L	078100103	7600G L	076000003
7810 XL	078100104	7600G XL	076000004
7810 XXL	078100105	7600G XXL	076000005
7812 S	078120001	7610G S	076100001
7812 M	078120002	7610G M	076100002
7812 L	078120003	7610G L	076100003
7812 XL	078120004	7610G XL	076100004
7812 XXL	078120005	7610G XXL	076100005
7813 S	078130001	7611G S	076110001
7813 M	078130002	7611G M	076110002
7813 L	078130003	7611G L	076110003
7813 XL	078130004	7611G XL	076110004
7813 XXL	078130005	7611G XXL	076110005
7816G XS	078160000	7818G XS	078180000
7816G S	078160001	7818G S	078180001
7816G M	078160002	7818G M	078180002
7816G L	078160003	7818G L	078180003
7816G XL	078160004	7818G XL	078180004
7816G XXL	078160005	7818G XXL	078180005
7816G XXXL	078160006	7818G XXXL	078180006
7816BL XS	078160100	7818BL XS	078180100
7816BL S	078160101	7818BL S	078180101
7816BL M	078160102	7818BL M	078180102
7816BL L	078160103	7818BL L	078180103
7816BL XL	078160104	7818BL XL	078180104
7816BL XXL	078160105	7818BL XXL	078180105
7816BL XXXL	078160106	7818BL XXXL	078180106
7817N S	078170101	7600N S	076000101
7817N M	078170102	7600N M	076000102
7817N L	078170103	7600N L	076000103

7817N XL	078170104	7600N XL	076000104
7817N XXL	078170105	7600N XXL	076000105
7819B S	078190101	7610N S	076100101
7819B M	078190102	7610N M	076100102
7819B L	078190103	7610N L	076100103
7819B XL	078190104	7610N XL	076100104
7819B XXL	078190105	7610N XXL	076100105
8021 3	080210003	8021A 3	080210103
8021 5	080210005	8021A 5	080210105
8021 6	080210006	8021A 6	080210106
8021 8	080210008	8021A 8	080210108
8021 10	080210010	8021A 10	080210110
8021 12	080210012	8021A 12	080210112
8021 14	080210014	8021A 14	080210114
8021 16	080210016	8021A 16	080210116
8021 18	080210018	8021A 18	080210118
8021 20	080210020	8021A 20	080210120
8021 22	080210022	8021A 22	080210122
8021 24	080210024	8021A 24	080210124
8021 26	080210026	8021A 26	080210126
8021 28	080210028	8021A 28	080210128
8021 30	080210030	8021A 30	080210130
8021 32	080210032	8021A 32	080210132
8021 35	080210035	8021A 35	080210135
8041 M16	080410216	8041HP M16	080410217
8041 M20	080410220	8041HP M20	080410221
8043 M16	080430216	8043HP M16	080430217
8043 M24	080430224	8043HP M24	080430225
8050D29	080500974		
8057 5,3	080570053	8057R 5,3	080570153
8058 8,0	080580080	8058 8,0	080580180
8060 8	080600080	8060R 8000	080600180
8061F 8	080610180	8061R 8,0	080610280
8085 8,0	080850080	8085 8,0	080850280
8085 11,2	080850190	8085 11,2	080850311
8090 8,0	080900080	8090 8,0	080900180
8131Z 6X800	081310068		
8131Z 8X1000	081310081		
8131Z 8X1200	081310082		
8131Z 10X1500	081310105		
8135/KLA 0,75	081350905	8135/KLA1 0,75	081350605
8135/KLA 0,75	081350905	8135/KCA 0,75	081350630
8135/KLA 0,75	081350905	8135/KMO 0,75	081350655
8135/KLA 1,0	081350910	8135/KLA1 1,0	081350610
8135/KLA 1,0	081350910	8135/KCA 1,0	081350635
8135/KLA 1,0	081350910	8135/KMO 1,0	081350660
8135/KLA 2,0	081350920	8135/KLA1 2,0	081350615
8135/KLA 2,0	081350920	8135/KCA 2,0	081350640
8135/KLA 2,0	081350920	8135/KMO 2,0	081350665
8135/KLA 3,0	081350930	8135/KLA1 3,0	081350620
8135/KLA 3,0	081350930	8135/KCA 3,0	081350645
8135/KLA 3,0	081350930	8135/KMO 3,0	081350670

8135/KLA 5,0	081350950	8135/KLA1 5,0	081350625
8135/KLA 5,0	081350950	8135/KCA 5,0	081350650
8135/KLA 5,0	081350950	8135/KMO 5,0	081350675
8139Z 10	081390009		
8143/RK 0,5	081430905	8143/RKL 0,5	081430500
8143/RK 0,5	081430905	8143/RPC 0,5	081430510
8143/RK 0,5	081430905	8143/RPF 0,5	081430520
8143/RK 1,0	081430915	8143/RKL 1,0	081430501
8143/RK 1,0	081430915	8143/RPC 1,0	081430511
8143/RK 1,0	081430915	8143/RPF 1,0	081430521
8143/RK 2,0	081430920	8143/RKL 2,0	081430502
8143/RK 2,0	081430920	8143/RPC 2,0	081430512
8143/RK 2,0	081430920	8143/RPF 2,0	081430522
8143/RK 3,0	081430930	8143/RKL 3,0	081430503
8143/RK 3,0	081430930	8143/RPC 3,0	081430513
8143/RK 3,0	081430930	8143/RPF 3,0	081430523
8143/RK 5,0	081430950	8143/RKL 5,0	081430504
8143/RK 5,0	081430950	8143/RPC 5,0	081430514
8143/RK 5,0	081430950	8143/RPF 5,0	081430524
8146/RK 0,75	081460908	8146/RKL 0,75	081460500
8146/RK 0,75	081460908	8146/RPC 0,75	081460510
8146/RK 0,75	081460908	8146/RKFC 0,75	081460520
8146/RK 1,5	081460915	8146/RKL 1,5	081460501
8146/RK 1,5	081460915	8146/RPC 1,5	081460511
8146/RK 1,5	081460915	8146/RKFC 1,5	081460521
8146/RK 3,0	081460930	8146/RKL 3,0	081460502
8146/RK 3,0	081460930	8146/RPC 3,0	081460512
8146/RK 3,0	081460930	8146/RKFC 3,0	081460522
8146/RK 6,0	081460960	8146/RKL 6,0	081460503
8146/RK 6,0	081460960	8146/RPC 6,0	081460513
8146/RK 6,0	081460960	8146/RKFC 6,0	081460523
9557J 3,0	095570030		
9577M S	095770051	9577R S	095770151
9577M M	095770052	9577R M	095770152
9577M L	095770053	9577R L	095770153
9577M XL	095770054	9577R XL	095770154
9811L T100 (1-2)	098110510		
9811L T100 (3)	098112510		
9812M T100 (1-2)	098120510		
9812M T100 (3)	098122510		
9813H T100 (1-2)	098130510		
9813H T100 (3)	098132510		
9821L T100 (1-2)	098210510		
9821L T100 (3)	098212510		
9822M T100 (1-2)	098220510		
9822M T100 (3)	098222510		
9823H T100 (1-2)	098230510		
9823H T100 (3)	098232510		
9851 500 (1-2)	098510050		
9851 500 (3)	098512050		
11050 180X7	110500180		

Acéllemez megfogók	649
Ácsceruza	218
Akkumulátoros gépek	315
Állítható hajtóvasak menetfúrókhoz	46, 49
Állítható villáskulcsok, skálával	24, 63, 289, 295, 303, 309
Állványozó csillagkulcs, speciális fejkiképzés	17, 308
Alumínium fellépő küszöb	239
Ásólapát, szikramentes	314
Asztali csősatu	35
Autójavítás	117÷126, 160÷166, 170÷211, 231÷239
Automata kábeldob szerelőlámpával	248÷250
Automata tömlődob levegő vagy hideg víz tömlő hosszabbítására	337
Bádogos ollók	136-137
Bemutatóállványok	569÷582, 629-630
Beta BM	547÷553
Beta Csiszolástechnika	527÷543
Beta Kollekción	672÷683
Beta vegyi anyagok	521÷526
BetaEVOX csavarhúzó	146÷148
BetaGrip csavarhúzó	152÷155, 292-293
BetamaX csavarhúzó	157÷159, 304, 312
Biztonsági szelepszáró kulcs, szikramentes	307÷311
Blister (áruházi polccsomagolás)	554÷568
Bőrlyukasztó fogó	238
Cink spray	526
Csákány, szikramentes	314
Csapágylehúzó hidraulikus rásegítéssel	211
Csapos dörzskorongok	532÷535
Csapos dörzskorongok	540÷542
Csapózsínór	221
Csapszegvágó	135
Csavaranyavágók	221
Csavarhúzóbetétek és betéttartók	25, 78÷85, 150-151, 155, 289
Csavartartó csavarhúzó	150
Csigafúró, hengerelt	36÷42
Csillag-villáskulcsok	11÷13, 25-26, 296, 302, 307
Csipeszek	126÷128, 291
Csiszolókörongok	529÷531, 542
Csőfogók	33-34, 296, 303, 309
Csőhajlító	34-35
Csőhegesztő	28
Csőperemező	32-33
Csősorjázó	31
Csővágók	28÷30, 32, 309
Dekorkések	240
Derékszögek	215-216
Digitális hőmérő, kétutas	237
Digitális olajátfolyás-számláló	259
Digitális-fordulatszám-mérő műszer	236
Dőlésszögmérő	216
Drótkötélvágók	135
Drótsodró fogó	238
Dugókulcs-csavarhúzó	113-114, 291, 570
Dugókulcsok, tartozékok és készletek, 1"	109-110
Dugókulcsok, tartozékok és készletek, 1/2"	99÷108, 290-291, 303, 310
Dugókulcsok, tartozékok és készletek, 1/4"	86÷93
Dugókulcsok, tartozékok és készletek, 3/4"	108-109, 310-311

TARTALOMJEGYZÉK



Dugókulcsok, tartozékok és készletek, 3/8"	93÷98, 289-290, 309
Ecetsavas szilikon tömítő	524
Egy- és kétoldalas villáskulcsok	14-15, 289, 295, 307
Egyenes élű műszerész ollók	137-138, 291, 297
Egyenes extra hosszú laposfogók	128, 140÷144, 292, 298, 311
Ékszíjtárcsalehúzó	201÷211
Elektromos platós kézikocsi	386
Elektronikai laposfogó	143-144
Elektronikai oldalcsipőfogók	144-145
Elektronikus nyomatékmérőkészülék digitális kijelzővel, Dynatester	70
Elektronikus nyomatékszögmérő	61
Elektronikus videószkóp	123
Emelőhevederek és kötelek	664÷667
Emelőkengyelek	639-640,655
Emelőpárna	242
Erősített laposvágók	10, 294, 302, 306, 314
Erősített tizenkétszögű csőkulcsok	111-112
Fafűrész	226
Fáziskereső csavarhúzó	150
Fejsze, szikramentes	314
Feltölthető LED-lámpák	244÷248
Festékszórók, szórópisztolyok	337
Feszítőcsavarok	632÷637
Feszítővasak	123, 221, 311
Feszültségvizsgáló műszer	237
Figyelmeztető és tiltó jelzések	629
Flakontartó	365-366
Flexibilis csavarkiszedő	222
Flexibilis mágneses csavarkiszedő	221
Folyadékelszívó	259
Folyékony tömítőanyag	523
Fűrészek és fűrészlapok	226
Fúrók, menetvágók és süllyesztők	47
Gépi dugókulcs, tartozékok és készletek	70÷74
Hajlított csillagkulcsok	15,÷17, 289, 295, 307-308
Hajlított imbuszkulcs XZN® csavarokhoz	23
Hajlított imbuszkulcsok és imbuszkulcsok Torx®-csavarokhoz	18-23
Háromkörmös csapáglehúzó	202÷205, 211
Hegesztőmaszk	255-256
Hengeres nyomatékkulcsok	62, 67÷69
Hézagmérő	221
Hidraulikus prés	211
Hidraulikus pumpa	163
Hőformált tálcák	493÷518
Hőkamera	237
Hőlégfúvópisztolyok	250
Hordozható szerszámosládák	357÷359, 372-373, 377-378, 382,
Hosszú ráverőkalapácsok	169, 313
Húzható szerszámládák	349, 351
Impregnáló spray	526
Inverteres hegesztőkészülékek	254-255
Ipari szerszámszekrények	357÷359, 372-373, 377-378, 382,
Jégoldó spray	526
Jelölő körzők	216-217
Kábelcsupaszoló és kábelcsupaszító fogók	139-140
Kábelkötegelő fogók	552
Kábelvágók	139, 291
Kalapácsok	162, 166÷168, 312, 298-299, 304

Kalibráló szerszám többretegű csövekhez	31
Kapcsolószekrény kulcsok	213
Karos zsírzókészülék	230
Karoszsírzók	229
Kerékagy és kerékdob lehúzó	205-206
Kerekes szerszámtáska	345-346, 348-349, 383-38
Kerekes ülőke	265÷267
Kerekhegyű ár	222
Kerékpáremelők	283
Kerékpárszerelő szerszámok	282÷286
Keresztvágó	10
Kések	241, 293, 314,
Kétkörmös csapáglehúzó	201÷205, 211
Kéttappancsos vákuumos üvegfogó	238
Kettős csuklós dugókulcs	15, 496,
Kézi csörlők és tartozékok	652÷658
Kézi emelők és emelőláncok	650÷652
Kézi menetfúrók és készletek	43÷45
Kinyomópisztoly	229
Kiütők	9, 306, 509
Kiütők	9, 306
Kombinálható szerszámdobozok és kiegészítők	352÷356
Kombinált fogók	140-141, 292, 298, 303, 312
Körmöskulcsok	23-24, 64, 309
Környezeti mérőműszerek	237-238
Koronafúrók, -fűrészek és tartozékok	51÷53
Kötélszívek	638
Kúpos lemezfúrók	41-42
Lamellás csiszolótárcsák	535÷539
Laposvágók karosszériaműhelyeknek	126, 161
Laposvésők	220
LED reflektor	245
Leesésvédett szerszámok	294÷300
Lézeres távolságmérő	218
Lyukasztófogó	133
Mágneses korongok fémlemez emeléséhez	255
Mágneses szögtartó hegesztéshez	255
Mágneses szorítók hegesztéshez	255
Mágneses tartó levegős géphez	324
Mágnesező/mágnesmentesítő	145
Megfordítható csavarhúzószárak	155-156
Menetjavító készletek	46-47
Menetmetszők és készletek	47÷51
Menetrögzítő	522
Menetsablon	221
Menettömítő	522
Mérőórák	215
Mérőszalagok és colstokok	218
Mikrométer	214
Mobil munkapad	371
Morse-kúpos kiütő	44
Motorkerékpár-szerelő szerszámok	276÷281
Műanyag behúzószalag	546
Műanyag kábelkötözők	550÷553
Műanyag kalapácsok cserélhető végekkel	169-170, 299, 313,
Műanyag tálka kis tárgyak elhelyezésére, mágneses	239
Műanyag terelőszlop és zárólánc	628



Műanyagjavító készlet	166
Műhelyberendezés	398÷440
Műhelyszekrények	420÷422, 439
Multifunkciós hegesztő fogók	255
Multiméterek	234-235
Multiméter-lakatfogók	235-236
Munkapadok	389,391-392,394÷397,402÷404, 407, 430-431,
Munkaruházat	612÷630
Munkaszőnyeg	266, 278, 293, 397, 652
Munkavédelmi cipők	583÷611
Műszerész csavarhúzó	151
Nemesacél szerszámok	301÷305
Nyitható racsnis hollander kulcsok	25÷27, 296
Nyitott hollander kulcsok	17
Nyomatékcavarhúzó	60
Nyomatékkulcsok	60÷69, 289, 296
Nyomatéksokszorozók	55-56
Olajbefecskendező	231
Olajozó fémkanna	230-231
Olajozó pisztoly	259
Oldalcsipőfogók	133-134
Ollók	138, 242, 314
Ónszippantó	254
Önzáró csipeszek	173, 186, 222, 240, 314
Önzáró fogók	131÷133, 297, 303
Összecsukható szerszámkocsi	355, 375
Övtáska övvel	344
Papirtekerstartó	365
Párhuzamsatu	212
Párhuzamszorító	212
Peremezőfogó	133
Pillanatforrasztópáka	253-254
Pillanatragasztó	524
Platnis kézi csőhegesztő műanyag csövekhez	28
Pneumatikus szerszámok és tartozékok	318÷340
Ponthelesztés lefűró	41
Pontozó	10
Popszegecshúzó és szegecsek	227÷229
Pumpa	259
Rabitz-fogók	134-135
Racsnis csővágóolló PVC csövekhez	30
Rádiusz-sablon	221
Ragasztó pisztoly	250
Rajztű	217-218
Ráverő kalapácsok, fanyéllal	169, 313
Reszelők	161, 223÷226, 314
Reszelőtisztító kefék	227, 314
Robur szerelvények	631÷671
Rögzítő emelőhevederek	644÷650
Rögzítőanyag	523
Rögzítőhevederek	663, 667÷670
Rozsdamentes acél szerelvények	658÷663
Rugóbeakasztó	226
Sarokcsavarhúzó	149
Saruzófogók szigetelt kábelsarukhoz	544÷546
Seeger-fogók	129-130, 173, 209, 296-297, 311
Sörtésecset	227
Spaklik	226, 314



Szállító kocsi	358
Száraz és nedves porszívók	256-257
Szemescsavarok	640÷643
Szerszámkészletek	441÷492
Szerszámkészletek hőformált tálcákban	494÷517
Szerszámkocsi takarók	381
Szerszámkocsik	368÷370, 385, 387-388, 413, 435
Szerszámkocsik	360÷368, 374÷381, 408-409, 431
Szerszámos hátizsák	347-348
Szerszámsekrények	390, 419
Szerszám tartó falak	365, 376, 393, 414, 416-417, 436-437
Szerszám táskák	333, 336÷338
Szerszám táskák	348÷351
Szerszám táskák	342÷346, 352÷355
Szigetelő aláfekvő	293
Szigetelő borítások	553
Szigetelőszalag	553
Szigetelt kábelsaruk	548
Szigetelt szerszámok, 1000V-ig	287÷293
Szikramentes szerszámok	306÷314
Szilikon spray	525
Szőghajtómű	84
Szőgmérő	216
Szorítókegyelek	637-638
Tartozékok szerszámsekrényhez, fiókokhoz és panelekhez	518÷520
Tépfázis kábelkötegelő szalagok	552
Térdeplő	266
Tisztító spray	525-526
Tisztítószer	525-526
Tizenkétszögű pipakulcsok	112-113, 296, 311
Többcélú kenőanyag	524
Tolómérők	213-214
Tömítéskivágók	135-136
Törtcsavarkiszedők	170-171
T-szárú dugókulcsok és dugókulcsok Torx®-csavarokhoz	115÷117
T-szárú imbusz kulcsok és imbusz kulcsok Torx®-csavarokhoz	115÷117, 291, 311
T-szárú imbusz kulcsok és imbusz kulcsok Torx®-csavarokhoz	21÷23, 191, 295, 303,
Ultrahangos mosóberendezés	263-264
Univerzális párhuzamoszorító	212
Üthető acélfejű csavarhúzó	149-150
Útvecsavarhúzó	158-159
Védőmaszk	629
Védőszemüveg	629
Végtelenített szalagok	543
Villamossági termékek	544÷553
Villanyszerelő kesztyű	293
Villás dugókulcs, 3/8"-os	96
Villáskulcsok	14-15, 307-308
Vízmértékek és szintezőlécek	219-220
Vízpumpafogók	130-132, 140-141, 184, 297, 303, 312,
Vizsgálótűk	222
Vízvezeték szerelő szerszámok	28÷35
Vonalzók	217, 299
Zárt végű sorkapcsok	549
Zseblámpa	243-244
Zsírspray	524-525

AUTÓSZERELŐ SZERSZÁMOK ABC SORRENDEN

Automotive



Ablaktömítés kisedő	239
Abronsperem illesztő	336
Akkumulátor töltő készülék	198÷200
Akkumulátorsav feltöltő kanna	231
Aláfekvő ágy	268
Aláfekvő ágy	266-267
Alkatrészmosó berendezés	263÷265
Áttételes kárpitpatent-kisedő fogó	185
Autó külső/belső tisztítóeszközök	256-257, 265
Autókárpitos fogó	238
Automata sebességváltó karbantartó berendezés	260
Autóvédők	266
Benzincső lehúzó fogó	187
Biztosítógyűrűfogó	173
Digitális hordozható feszültségvizsgáló műszer	201
Digitális nyomás és kompresszió mérő	177÷180
Dízel porlasztócsúcs kisedő szerszámkészlet Common-Rail rendszerhez	121
Dízel porlasztócsúcs vizsgáló készülék	122
Dízel porlasztócsúcskisedő dugókulcs	118-119
Dízelmotorturbina szerelő kulcs	184
Dízelolaj leeresztő dugókulcs-betét	193
Dobfékkrugófogó	180
DSG váltóhoz való speciális célszerszám	172
Dugattyúgyűrű szorító szalag	173
Dugókulcs lambdaszondához	119
Dugókulcs Volvo teherautó lengéscsillapítóhoz, erősített	209
Egyengető idom	160-161
Emelő teherautókerékhez	268
Fagyállóvizsgáló üvegtest	233
Fáradtolaj gyűjtő	257-258
Fékdugattyú szerelő készlet	181
Fékfolyadékleszívó	179-180
Féltengelycsukló lehúzó	210
Feszültség stabilizátor	201
Feszültségvizsgáló műszer	196
Földgázszelep kulcs	189-190
Folyadékgyűjtő tartály	258-259
Gázolajszűrő feltöltő szerszám	186
Gömbfejlehúzó	210
Gumiabroncs szerelővas	123, 285
Gumiabroncs tároló zsákok	124
Gumigyűrű kisedő szerszám	170
Gumiprofil-mélységmérő, digitális	221

AUTÓSZERELŐ SZERSZÁMOK ABC SORRENDEN

Gyertyakiszedő fogó	184
Gyertyakiszedő készlet	183
Gyorsindító és akkumulátortöltő	198
Hajtómű/sebességváltó szerelőkocsi	388
Hidraulikus daru	270
Hidraulikus emelő	269
Hidraulikus emelő kerékkel	273-274
Hidraulikus hajtómű emelő	270-271
Hidraulikus prés	271-272
Hidropneumatikus emelő	275
Hőmérséklet-érzékelőkhöz való kulcsok	120
Horpadás ellenőrző lap	163
Horpadáskihúzó	162-163
Hűtőrendszer tömítettségét ellenőrző műszer	233
Injektor fészekmaró készlet	122
Jelkereső	236
Kanálvas	161
Karosszéria hézagbeállító kések rozsdamentes acélból	162
Karosszéria reszelő	161
Karosszéria spotter kerékkel	164÷165
Karosszériakalapács	162
Kefe akkusaru és pólus tisztításához	227
Kerékagyszerelő dugókulcs	124
Kerékagyszerelő dugókulcs, erősített	124
Kerékanya műanyag kupakhoz való fogó	125
Kerékanya-dugókulcs	72-73
Kerékanya-dugókulcs Isuzuhoz, gépi	76
Kerékemelő, gurulós	268
Keréksúlyszerelő fogó	126
Kerékszelepszereelő szerszám	124-125
Kerékszerelő vezetőcsap	125
Keresztkulcs kerékanyához	124
Kipufogócsővágó fogó, állítható	184
Klimaberendezés karbantartásához való szerszámkészlet	188
Kompressziómérő közvetlen benzinbefecskendezős motorokhoz	121-122
Kormánykar leszereléséhez célszerszám	210
Kuplungtárcsa központosító	172
Kúpos csapágy és olajvédő ütve beillesztő	211
Láncszem- és szegecseltávolító, összeszerelő készülék	280
Légkondicionáló feltöltő berendezés	262÷263
Légzsákszereléshez való szerszámkészlet	172
Lengőkar gömbfej lehúzó kulcs	210
Levegős rugóösszehúzó	209
Mobil munkaállomás diagnosztikai eszközkhöz	385
Modellezhető lemez alumíniumból	232
Motoralkatrész tisztítók	265
Motorkerékpár tartó állvány	277
Motortartó kengyel	269

AUTÓSZERELŐ SZERSZÁMOK ABC SORRENDENBEN

	☰
Olajgőzelszívó	122
Olajleeresztő kulcs	194-195
Olajsűrűleszedő dugókulcs	190÷193
Pneumatikus horpadás kihúzó	164
Pneumatikus szelepcsizoló	173
Racsnis heveder	238
Rádió kiszerelő szerszámkészlet	238
Relé fogó	195-196
Savsűrűségmérő	233
Sérült és törött gyújtógyertyához való szerszámkészlet	121-122
Spakli acélból	161
Szeleprugó feszítő fogó	162
Szeleptányér lenyomó készülék	180
Szeleptömítés kisedő	173
Szemcseszóró, asztali	264
Szerelőbak	268
Szerszámkészlet az elektromos dugasz szerelésére	196
Szilentblokk lehúzó szerszám	211
Sztetoszkóp	201
Teleszkópos támasztórúd	239
T-gyertyakulcs, rövid csuklós	118
Tolatóradar érzékelőkhöz való kivágók	165
Tölcsér, műanyag	232, 314
Tolómérő féktárcsához	73
Tömítésleszedő szerszám	206
Tömlőbilincsfogó	182-183
Tömlőfúvató	336
Tömlőzáró fogó	187
Torziós rúd kerékanyához	77
Üzemanyagcsatlakozókhoz való kulcsok	176
Üzemanyagtartály szereléséhez állítható kulcs	187
Vezérlés beállításához való szerszámkészlet	173÷176
Vezérműtengely-bordás szíj rögzítő szerszámkészlet	177

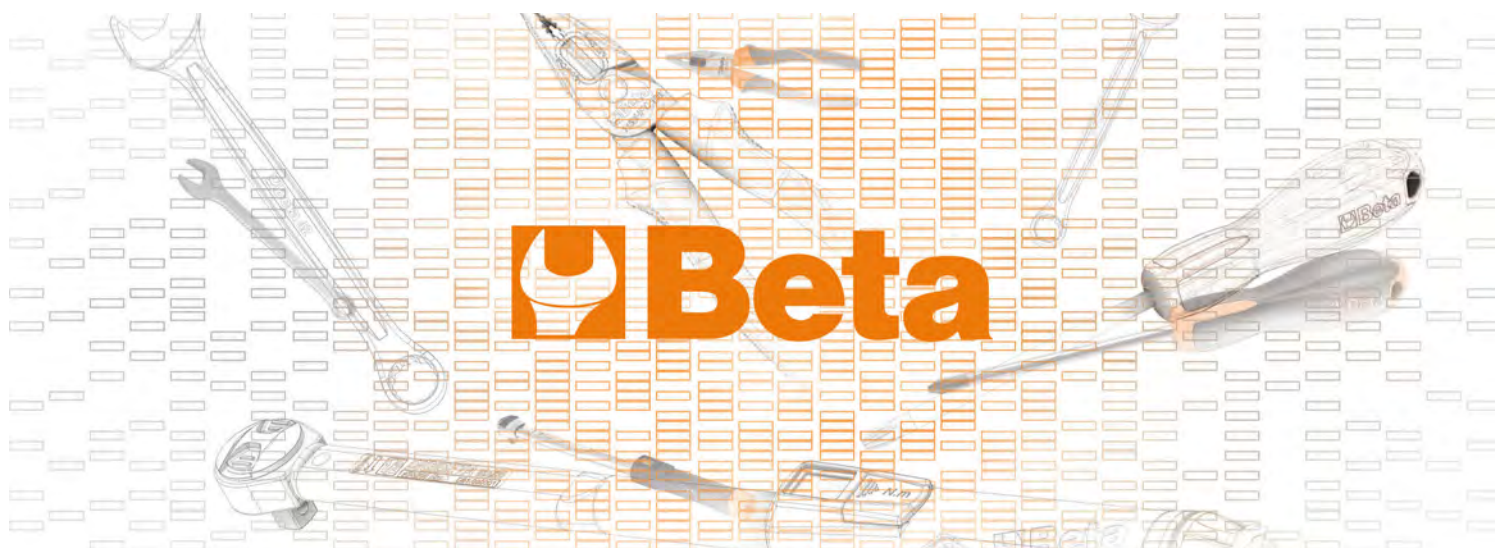

TARTALOMJEGYZÉK CIKKSZÁM SZERINT

1		1032HS	296	1081	133	1126	137	1149F	140
		1032BA	311	1082	133	1127	137	11491	543
100	24	1032K	559	1082BM	133	1128BAX	137	11493	543
100/KIT	24	1033	129	1082G	133	1128BMX	137	11495	543
110BA	309	1033K	559	1082GBM	134	1128BMX/F	137	11498	543
110MQ	289	1034	129	1082MQ	291	1128BM	138	1150	140
111CM	24	1034L	129	1082BM-HS	297	1128BSX	138	1150G	140
111E	24	1034HS	297	1082INOX	303	1128FX	138	1150BM	141
111EN	24	1034K	559	1082BA	312	1128FXS	138	1150GBM	141
111ER	24	1036	129	1082GK	559	1128MQ	291	1150HPC	141
111E-HS	295	1036HS	297	1082K	559	1128BAX-HS	297	1150MQ	292
111INOX	303	1036BA	311	1082BMK	560	1129BM	138	1150BM-HS	298
120	25	1036K	559	1082GBMK	560	1129BMK	561	1150INOX	303
120/B6N	25	1037	129	1084	134	1130BMX	138	1150BA	312
123/K4	25	1037K	559	1084BM	134	11300A	541	1150BMK	561
123E1/4	25	1038	129	1084G	134	11300B	541	1150GBMK	561
123Q1/2	25	1038HS	297	1084GBM	134	11300C	541	1150GK	561
123Q1/4	25	1038K	559	1084MQ	291	11300D	541	1150K	561
123Q3/8	25	1039	130	1084BMK	560	11300E	541	1153	141
141	25	1044	130	1084GBMK	560	11300F	541	1153INOX	303
141/B	25	1044F	130	1084GK	560	11300G	541	1162	141
141/S	25	1044FK	559	1084K	560	1131CK	138	1162BM	142
142	25	1044K	559	1088	134	1132	139	1162G	142
142/B	26	1046BA	312	1088BM	134	1132BM	139	1162GBM	142
142/S	26	1047	130	1088MQ	291	11320	541	1162MQ	292
142/SC9I-E	26	1047BM	130	1088BM-HS	297	1132MQ	291	1162BA	312
142AS	26	1048BM	130	1088BMK	560	1132BM-HS	298	1162BMK	561
142AS/S	26	1048N	130	1088K	560	1132BMK	561	1162GK	561
142C	26	1048N/D3	130	1092V	134	1132K	561	1162K	561
142C/A	26	1048VN	130	1094V	134	1133	139	1162GBMK	562
142HS	296	1048MQ	291	1095N	134	1133RL	139	1164	142
142K	556	1048BM-HS	297	1096	134	1134	139	1164BM	142
142MC	26	1048INOX	303	1096K	560	1134A	139	1164MQ	292
142MC/SC9I-E	26	1048NK	559	1098	135	1134A/RL	139	1164BMK	562
142SN	26	1048VNK	559	1098PL	135	1134RL	139	1164K	562
142SN/S	26	1050	131	1098K	560	1137BA	312	1166	142
142SN/SC9	26	1051	131	1098PLK	560	1137BA/RC	312	1166BM	142
186	27	1051GM	131	1100BA 600	312	11411	541	1166G	142
187	27	1051L	131	1101	135	11415B	541	1166GBM	142
187/B5	27	1051XL	131	1101R	135	1142BM	139	1166MQ	292
188	27	1052	131	1102	135	11420B	542	1166BM-HS	298
192	27	1052HS	297	1103	135	1142MQ	292	1166BA	312
192/S2	27	1052BA	312	1103R	135	1142BMK	561	1166BMK	562
194	27	1052K	559	1104	135	1143	139	1166GBMK	562
195	27	1053	131	1104R	135	1143R	139	1166GK	562
195/B5	27	1054	131	1105	135	11431	542	1166K	562
195AS	27	1055	131	1105/C10T	136	11435	542	1168	142
195AS/B	27	1055D	131	1105/C16T	136	1144D	139	1168G	142
195K	556	1056	131	1105/C32T	136	1144D/RG	139	1168BM	143
195P	27	1057A	132	1105AD-50	136	1144D/RL	139	1168GBM	143
195P/B5	27	1058	132	1105T20	136	1144G	139	1168MQ	292
1002	128	1059	132	1105T30	136	1144G/RL	140	1168BM-HS	298
1008	128	1060	132	1105T50	136	1144L	140	1168BMK	562
1008BM	128	1061	132	1112	136	1144T	140	1168GBMK	562
1009	128	1062	132	1114	136	11440A	542	1168GK	562
1009L/A	128	1062AL	132	1118	136	11440B	542	1168K	562
1009L/B	128	1062GM	132	1120A	136	11440C	542	1169/D3	143
1009L/C	128	1063	132	1120ARL - ARG	136	11450A	542	1169BM/D3	143
1009L/D	128	1064	133	1122	136	11450B	542	1169G/D3	143
1009L/DP	128	1065F	133	1122 - 1125MOL	137	11450C	542	1169GBM/D3	143
1009L/DP-S2	128	1065P	133	1122K	560	1148A	140	1171BM	143
1010	128	1066	133	1123	137	1148A/R	140	1172BM	143
1010BM	128	1067	133	1123K	560	1148B	140	1172BM/P	143
1010MQ	291	1077	133	1124	137	1148B/R	140	1173BM	144
1031/S4	129	1078	133	1124K	560	1148P	140	1175BM	144
1032	129	1080D	133	1125	137	11488PF	543	1177BM	144

TARTALOMJEGYZÉK CIKKSZÁM SZERINT

1177BM/Z	144	1253A	150	1269PZ	155	1294L	158	1366B	164
1178BM	144	1254	150	1269PZ/S4	155	1294HS	298	1366KF	164
1178BM/P	144	1256/C36-2	150	1269N/PZK	564	1294K	564	1366S	164
1182BM	144	1256LP	150	1269PZK	564	1295	158	1366S KIT	164
1183BM	144	1256PE	150	1270BA	312	1295/C14	159	1366S/R1	164
1184BM	145	1256PH	150	1272MQ	292	1297TX	159	1366S/R2	164
1185BM	145	1256PZ	150	1272MQ/S	292	1297TX/D6	159	1366S/R3	164
1186BM	145	1256/20	151	1272MQF	292	1297TX/L	159	1366S/R4	164
1188BM	145	1256/30	151	1272BA	312	1297TX/L-S5	159	1366S/R5	164
1190BM	145	1256RTX	151	1273MQ/D6	292	1297TX/S12	159	1366SL	164
1191BM	145	1256TX	151	1273MQF/D6	292	1298RTX	159	1366ST	164
1191BM/L	145	1257BE	151	1273MQF/E1	573	1298RTX/S8	159	1366S/R10	165
1191R/5-M	145	1257ES	151	1273MQF/E4	573	1298RTXK	564	1366S/R11	165
1200MS	145	1257ESB/S8	151	1274MQ	292	1299N/PZ	159	1366S/R12	165
1201E	146	1257LP	151	1274MQF	292	1299PZ	159	1366S/R13	165
1201E/DZ	146	1257LP/S	151	1274MQ/S	293	1299PZ/S6	159	1366S/R14	165
1201E/S6	146	1257LPH/S8	151	1275MQ/C	293	1299HS	298	1366S/R21	165
1201EN	146	1257PH	151	1276MQ/C	293	1299N/PZK	564	1366S/R22	165
1201E/K	562	1257TX	151	1277BA	312	1299PZK	564	1366S/R24	165
1201EN/K	562	1257TX/S	151	1279MQ	293	1302	160	1366S/R25	165
1202E	147	1260	152	1279MQ/F	293	1303	160	1366S/R26	165
1202E/S4	147	1260/S6	152	1279MQ/S	293	1304	160	1366S/R6	165
1202EL	147	1260N	152	1281BG	155	1305	160	1366S/R7	165
1202EN	147	1260E	153	1281LP	155	1305Z	160	1366S/R8	165
1202E/K	562	1260MC	153	1281PB	155	1306	160	1366S/R9	165
1202EN/K	562	1260EK	563	1281PM	155	1307	160	1367/K10	165
1203E/D	147	1260K	563	1281/B28A	156	1308	160	1367/S4	165
1203E/S	147	1260NK	563	1281BG/A9	156	1310	160	1368	166
1203/E10P	571	1262	153	1281BG/B28NA	156	1312	160	1368G/C2U	166
1203/E1P	571	1262/S4	153	1281BG-TX/A8	156	1314	161	1368G/CV	166
1203/E4P	571	1262E	153	1281LPH	156	1326	161	1368G/K400	166
1203/E5P	571	1262L	153	1281PE	156	1327	161	1368G/OD	166
1204E	147	1262MC	153	1281PH	156	1328	161	1368G/SD	166
1204E/S5	147	1262N	153	1281PZ	156	1329	161	1369/C11	166
1204EL	148	1262EK	563	1281RTX	156	1330	161	1370	166
1204E/K	562	1262K	563	1281TX	156	1331	161	1370/MR...	167
1205E/ES	148	1262NK	563	1290	157	1335BM	161	1370F	167
1205E/ES-S8	148	1263/D...	153	1290/S	157	1337/S5	161	1370F/MR...	167
1206E/BP	148	1263/S12	154	1290N	157	1338	161	1370FT	167
1206E/BP-S7	148	1263MC/D8	154	1290HS	298	1338A - 1338B	161	1370T	167
1207E/TX	148	1263/E74	571	1290INOX	304	1338R9 - 1338R12	161	1370T-HS	298
1207E/TX-D	148	1263/E78	571	1290K	564	1342	161	1370FT-HS	299
1207E TX/K	563	1263/E39	572	1290K/INOX	564	1342PM	161	1370INOX	304
1208E/RTX	148	1263/E40	572	1290NK	564	1342PMR	161	1370BA	312
1208E/RTX-D	148	1263/E50	572	1292	157	1343	161	1370BA/MR	313
1208E RTX/K	563	1263/E62	572	1292/S4	157	1344	162	1370BA/PL	313
1209E/PZ	148	1263/E70	572	1292L	157	1344A/VW	162	1374F	167
1209E/PZ-S4	148	1263/E85	572	1292N	157	1345	162	1374F/MR...	167
1209EN/PZ	148	1264	154	1292HS	298	1351	162	1375	167
1209E PZ/K	563	1264/S5	154	1292INOX	304	1353	162	1375/MR	167
1209EN-PZ/K	563	1264L	154	1292K	564	1357Z/45	162	1375A	167
1229LP	149	1264K	563	1292NK	564	1359T	162	1375B	167
1229LP/S	149	1265ES	154	1292K/INOX	564	1360/K6	162	1375BA/PL	313
1229LPH/A6	149	1265ES/S8	154	1293/D...	158	1360/KP3	162	1376X	167
1229PH	149	1266BP	154	1293/S...	158	1360G	162	1376X/MR	168
1236B	149	1266BP/S8	154	1293BP	158	1361/C12	162	1376XT	168
1238B	149	1267TX	154	1293BP/S	158	1361/K9	162	1376XT/MR	168
1241	149	1267MC/TX	155	1293ES	158	1362B	163	1377	168
1242	149	1267MC/TX-D7	155	1293ES/S7	158	1364SCP	163	1377/MR...	168
1243/D7	149	1267TX/D7	155	1293INOX/D9	304	1364SE	163	1377T	168
1243LP/D6	149	1267TX/S13	155	1293BX/DA	573	1364SP	163	1377INOX	304
1243/S11	150	1267TXK	563	1293BX/DD	573	1364SV	163	1377BA	313
1250	150	1268RTX	155	1293BX/DE	573	1365/K13	163	1377BA/PL	313
1251	150	1268RTX/S8	155	1293BX/DF	573	1365P10	163	1378	168
1252/S5	150	1268RTXK	564	1294	158	1366A	163	1378/MR...	168
1253	150	1269N/PZ	155	1294/S7	158	1366/K5	164	1379F	168

TARTALOMJEGYZÉK CIKKSZÁM SZERINT

1379F/MR...	168	1455SVP/R...	173	1467LF/RC	180	1478/3P	185	1488 - 1488L	190
1379BA	313	1457/B4	173	1467T/C6	180	1478/K3	185	1488/1	190
1380	168	1458	173	1467TU	180	1478NSS	185	1488R...	190
1380/MR...	168	1460F	173	1468N	180	1478T	185	1489/31T	190
1380S	168	1461/C5G	173	1470	180	1479	185	1489/33	190
1380S/MR...	168	1461/C6B	173	1470FT	180	1479/B27	185	1489/33P	191
1380T	169	1461/C11A	174	1470PF	180	1479L/S2	185	1489/C14	191
1380BA	313	1461/C12A	174	1471	180	1479LB/C5	185	1489/E	191
1380BA/MR	313	1461/C13B	174	1471A	180	1479L/K4	186	1489/Y	191
1380BA/PL	313	1461/C18B	174	1471CF	181	1479LV/S3	186	1489R	191
1381	169	1461/C20G	174	1471CM	181	1479ML/B17	186	1490	191
1381/MR...	169	1461/C6G	174	1471CM/E11	181	1479ML/S3	186	1490/R1 - 1490/R2	191
1381T	169	1461/C7B	174	1471GF	181	1479N/S5	186	1490F	191
1381BA	313	1461/C8B	174	1471M/50	181	1479RB/1	186	1491	191
1381BA/MR	313	1461/C9B	174	1471M/C22	181	1479RB/2	186	1491A	191
1381BA/PL	313	1461/C21G	175	1471M/P	181	1479RB/3	186	1491R	191
1385	169	1461/C23B	175	1471M/W50	181	1479U/13	186	1491T	191
1385/MR	169	1461/C24B	175	1471PN/B1	181	1479U/32	186	1492/1 - 1492/2	192
1390	169	1461/C25G	175	1471PN/B2	181	1480	186	1492T	192
1390/MR...	169	1461/C27G	175	1471PN/B3	181	1481/C12	186	1493	192
1390N	169	1461/C28B	175	1471PN/B4	181	1481K/S4	187	1493/C30	192
1390NR	169	1461/C29B	175	1471PN/B5	181	1481PL	187	1493/PF	192
1390R	169	1461/C30G	175	1471PT/C5	181	1481PL/S3	187	1493AL	192
1390HS	299	1461/C32G	175	1471D2	182	1481T/C12	187	1493AL 4S	192
1390BA	313	1461/C33B	176	1471T/C5	182	1482	187	1493B	192
1390BA/R	313	1462/KD	176	1472	182	1482/8 - 1482/10	187	1493B/S5	192
1391	169	1462/KI	176	1472AU	182	1482A/1	187	1493/C19	193
1391A	170	1462/KMRC	176	1472AU/P	182	1482A/3	187	1493/C7	193
1392	170	1462/KU	176	1472AU/RP	182	1482A/5	187	1493AL CF	193
1392R	170	1462/MB	176	1472B/RNLT	182	1482B	187	1493DSG	193
1392HS	299	1462CF	176	1472FC	182	1482SN	187	1493FF	193
1393	170	1462CF/C6	176	1472FC/GE	182	1482C	188	1493FT	193
1410/M	170	1462CF-SN	176	1472FC/L	182	1482D	188	1493H	193
1428	170	1462CF-SN/C6	176	1472FCA	182	1483K/12	188	1493HK	193
1428/SB11	170	1462/EI	177	1472R/AU	182	1483K/22	188	1493J	193
1428L	170	1462AD/BSC	177	1472FCL/RP	182	1483KV-PT/S7	188	1493VW	193
1428L/B3	170	1462AD/SMN	177	1472H	183	1484	188	1493/S-U	194
1429	171	1462PIM	177	1472MT/VW	183	1484PSA	188	1493C/ADB	194
1429/SB7	171	1463/KIT	177	1472TM	183	1485BP	188	1493U/ADB	194
1430/...	171	1464CBD	177	1472VW	183	1485BPM	188	1493X	194
1430/S	171	1464IC	177	1473	183	1485FCA/K2	188	1493Y	194
1431/...	171	1464T	177	1473A	183	1485FCA/T	188	1494	194
1431/C5	171	1464T/SP80	177	1473FN	183	1485FCA/TS	188	1494BMW	194
1433	171	1464ADB	178	1473P	183	1485FRD/T	188	1494E	194
1433/C11	171	1464AP	178	1473T	183	1485KIT	189	1494FPC	194
1435	171	1464AP T	178	1474/C4	183	1485MJ	189	1494MAN	194
1435/1	171	1464AP T16X12	178	1474E/VW	183	1485MRC/T	189	1494MRC	194
1435/1R	171	1464APB	178	1474E/VW2	183	1485PMTJ	189	1494T/C5	194
1435R	171	1464FAP	178	1474DL	184	1485R	189	1494VW	194
1437/C12	172	1464FG	178	1474G	184	1485R/P10	189	1494/C14A	195
1438	172	1464FG/CP4	178	1474L	184	1485R/P17	189	1494M	195
1438DCT	172	1464IC/RK	178	1475U	184	1485TC	189	1494Q	195
1438DCT/S	172	1464PB	178	1476	184	1485VAG	189	1494T	195
1438DSG	172	1464PF	179	1476/RC	184	1485VAG/K2	189	1494VW/K	195
1438EVO	172	1464PT	179	1476A	184	1485VLV/T	189	1494VW/KT	195
1438K/DSG-2	172	1464TDI	179	1476A/RC	184	1486/10	189	1494XZN	195
1438K/PWR	172	1464VD	179	1476C/1	184	1486/20	190	1495/C6	195
1438R	172	1465	179	1476GT	184	1486/30	190	1495M	195
1439/K7	172	1466/C5	179	1476PSA	184	1486/40	190	1495T	195
1440/...	173	1466L 11	179	1476T	184	1486/50	190	1496/C	195
1445/1 - 1445/2	173	1466TLF	179	1477/C10	184	1486/60	190	1497D	195
1452K	173	1467	179	1477D	185	1486/70	190	1497/C23	196
1452PN/K	173	1467/RK1	180	1477D/S5	185	1486/80	190	1497/C94	196
1454P	173	1467/RK2	180	1477K/7	185	1486/90	190	1497/S3	196
1455SVP	173	1467LF/2	180	1478	185	1487/K2	190	1497BS	196

TARTALOMJEGYZÉK CIKKSZÁM SZERINT

1497KB/S3	196	1529	205	1585GI/5 - 6 - 7	211	1654	214	1700N	220
1497P	196	1529/C7	205	1589PI/50 - 100 - 150	211	1654DGT	214	1700N/PM	220
1497RC	196	1529/PG	205	1589VI	211	1656	214	1701N	220
1497SS	196	1529PI	205	1590	212	1657DGT/2	214	1701N/PM	220
1497TE	196	1530/C16	205	1591	212	1658/...	214	1701NE/...	220
1498	196	1530/C5	205	1593	212	1658/C4	214	1701PMR	220
1498BC/12	197	1531/C7	206	1594	212	1658DGTB	214	1701BA	314
1498LT/12	197	1532	206	1595	212	1658SP/1	215	1702N	220
1498LT/12-R7	197	1533/...	206	1599B	212	1659	215	1702N/PM	220
1498LT/12-SF	197	1533PR/1 - 2 - 3	206	1599F	212	1662/1 - 1662/2	215	1702PMR	220
1498MN/12-C	197	1534/...	206	1599GI	212	1662AN	215	1703BA/A	314
1498MN/12-P	197	1535/C...	206	1599GR	212	1662DGT/A	215	1703BA/P	314
1498MN/12-R	197	1539	206	1599P	212	1662SP0	215	1703BA/PL	314
1498MN/12-U	197	1540	206	1599T	212	1662SP2	215	1704	221
1498/12	198	1542/1 - 1542/2	207	1599G	213	1666	215	1704A	221
1498/12-24 R20	198	1544/...	207	1600Q 10	213	1666A	215	1704C	221
1498/24	198	1545/C5M	207	1600Q 8	213	1668	215	1705	221
1498/2A	198	1547/C6	207	1601/PC	544	1668A	216	1705PT	221
1498/4A	198	1547KP	207	1602A-HS	299	1670	216	1706DGT	221
1498B12/R02	198	1547P	207	1602BA	314	1670A	216	1707	221
1498LT/12-24	198	1547PC/2	207	1602/C10	544	1672	216	1707A/1 - 2 - 3	221
1498SA/2A-4A	198	1547PL/2	207	1602A	545	1672A	216	1708/8 - 13 - 20	221
1498/16A	199	1549	207	1603	544	1674A	216	1708HS/21	299
1498/25A	199	1550U	208	1603A	545	1676	216	1709/10 - 1709/18	221
1498/2A-8A-PR	199	1550U/CGS-R	208	1603B	545	1678/C3	216	1710	221
1498/4A-8A CO	199	1550U/M	208	1603BK	565	1679	216	1712E/1 - 2 - 3	221
1498/4A-8A CP	199	1550U/MRC-ABE	208	1603K	565	1679/PR	216	1712TF	221
1498/8A	199	1550U/MRC-C	208	1604	545	1680	216	1713M	222
1498/120A	200	1550U/S...	208	1606/3	545	1680A	217	1714	222
1498/40A	200	1550U/SS187	208	1606A	545	1680B	217	1715	222
1498SM	200	1551/C20	208	1606A/C10	545	1680C	217	1715B/R5L	222
1498SM-A	200	1552/C9	208	1606T	545	1682	217	1715FL/A	222
1498SM-C	200	1555/Q	209	1607	545	1682HS	299	1715FL/B	222
1498SM-CP	200	1555/QS	209	1608	545	1683	217	1715R/FL	222
1498TB/6-12	200	1555C	209	1608/C10	546	1685/C7	217	1716A	222
1498PC	201	1555S/BMW-RNT	209	1608A	546	1687/S4	217	1716P	222
1498ST/TB	201	1556/1A	209	1609A	546	1687A	217	1716Q	222
1498ST/TB ROT	201	1556/2A	209	1609B	546	1687AC	217	1716R	222
1498TB/12-24	201	1557	209	1609C/C6	546	1687D	217	1716U	222
1498TC	201	1557/S3	209	1609M	546	1687U	217	1717A	222
1499	201	1557V	209	1610	546	1688	217	1717B	222
1500/...	201	1558/C4	130	1610-B	548	1688A	217	1717C	222
1500/SP	201	1558/C13	209	1614-P	548	1688M	218	1717D	222
1500G/...	201	1558P	209	1616-SM	548	1688PC	218	1717T	222
1500N/...	202	1559	210	1618-SF	548	1688PC/R	218	1717T RS	222
1500N/G...	202	1559V/8T	210	1620-M	548	1690F	218	1717T RT	222
1500N/SP	202	1560/2	210	1622-F	548	1690L	218	1717V	223
1501/1 - 2 - 3	202	1560A	210	1624-FI	548	1691BM	218	1717V R	223
1501G/1 - 2 - 3	202	1561/...	210	1628-C	548	1691MG	218	1717BA	314
1501Z/S - P - R	202	1562D	210	1630-CR	548	1692	218	1717BA/1	314
1502/...	202	1563/C4	210	1632-TS	548	1692HS	299	1718A...M	223
1505V	202	1565/1 - 2 - 3	210	1634-TD	548	1693	218	1718A...P	223
1505/C5	203	1566/GO1	210	1635-D	549	1693M	218	1718A...Q	223
1506	203	1566N	210	1635-S	549	1694/L	219	1718A...R	223
1508/1 - 1508/2	203	1566P	210	1638M	553	1694A/L	219	1718A...T	223
1511/1 - 2 - 3	203	1566R	210	1639S	546	1694B/L	219	1718D...M	223
1515/1 - 2 - 3	203	1567	210	1639EAB	553	1695XS	219	1718D...P	223
1516/1 - 2 - 3	203	1568	211	1639ESB	553	1696	219	1718D...Q	223
1517	203	1569/F	211	1639ESC	553	1696A	219	1718D...R	223
1517C/...	204	1569/SB	211	1639ETA	553	1696B	219	1718D...S5	223
1518/...	204	1569CP	211	1650	213	1696D	219	1718D...T	223
1518U/...	204	1570/3	211	1650FD	213	1696S	219	1718A...S5	224
1519/...	204	1580/8I	211	1650FT	213	1697	220	1719BMA...M	224
1520/1 - 1520/2	205	1580GL	211	1651DGTB	213	1699L	220	1719BMA...P	224
1521/1 - 1521/2	205	1585/5I - 6I - 7I	211	1651DGTB/IP	214	1699L/1	220	1719BMA...Q	224
1528	205			1652	214	1699Q	220	1719BMA...R	224

TARTALOMJEGYZÉK CIKKSZÁM SZERINT

1719BMA...T	224	1742KR	228	1757A	231	1767PMC	239	1833RB-L/USB	243
1719BMD...M	224	1742R-A/M...	228	1758	231	1767PMR	239	1833XS/1	243
1719BMD...P	224	1742R-AL/M...	228	1758ADB-D	231	1768	239	1833XS/2	243
1719BMD...Q	224	1742A/C	229	1758A	232	1770	239	1833L	244
1719BMD...R	224	1742A/KR	229	1758ADB-45°	232	1770A	240	1833M	244
1719BMD...T	224	1743HS	299	1758B	232	1770BM	240	1833S	244
1719BMX...M	224	1743T	552	1758B/K5	232	1770RL	240	1833XL	244
1719BMX...P	224	1744	552	1758B-1,6	232	1771	240	1834RR	244
1719BMX...Q	224	1748-BV3	549	1758B-RNT	232	1771BM	240	1836AW	244
1719BMX...T	224	1748N	549	1758LG	232	1771HD	240	1836B	244
1719BM/RL	225	1748V	549	1758M	232	1771RL	240	1837F	244
1719BM/RR	225	1748-BL	550	1758R	232	1772H	240	1837F/USB	244
1719BMA...B5	225	1748-BV1	550	1758VT	232	1772M	240	1837C	245
1719BMA...S5	225	1748-BX	550	1758VT/L	233	1772R	240	1837M	245
1719BMB/P	225	1748-N2D	550	1758BA	314	1772RL/2	240	1837RB-F/USB	245
1719BMC	225	1748-NL	550	1759	233	1772H-HS	300	1837S	245
1719BMD...B5	225	1748-UL	550	1759A	233	1773A	240	1838FLASH	245
1719BMD...S5	225	1748-BA2	551	1759B	233	1773RL	240	1838POCKET	245
1719BMR	225	1748-BH	551	1759HD/3	233	1774	240	1838RB/FLASH	245
1719BMX...R	225	1748-BP	551	1759HD/RR	233	1774A	240	1838/11LED	246
1719BMX...S5	225	1748-BR	551	1759HD/TRUCK	233	1774A/RL	240	1838AM	246
1719R/...	225	1748-BT	551	1759LR	233	1774S	240	1838COB	246
1719BA12	314	1748-BT2	551	1759TT	233	1776BA	314	1838P	246
1719BA8	314	1748-BT3	551	1760DGT	234	1777BM	241	1838RA/10-11LED	246
1720/...	225	1748-NA2	551	1760DGT/2	234	1777BMT	241	1838RB/10LED	246
1720/B	225	1748-BA3	552	1760/OHM	235	1777T	241	1838RR/11LED	246
1720/S	225	1748-BV	552	1760/RMS	235	1777MQ/C	293	1838RV/11LED	246
1720D/...	226	1748-NA3	552	1760B	235	1777MQ/U	293	1838SLIM	246
1720D/B	226	1748-NV	552	1760PA/80	235	1777RL/U	293	1838E	247
1721/B6	226	1748-S	552	1760PA/AC	235	1778AN	241	1838E-BT	247
1723	226	1748-SC	552	1760S	235	1778AX	241	1838SW	247
1725	226	1748-N	553	1760/RSE	236	1778CM	241	1838UV	247
1725CR	226	1748-ST	553	1760/TC2	236	1778M7	241	1839/R1	247
1725MQ	293	1749	229	1760DGT-R3	236	1778P	241	1839/R2	247
1726	226	1749A	229	1760K	236	1778SCL	241	1839/R4	247
1726BM	226	1749A/RB	229	1760PA/AC-DC	236	1778SOS	241	1839/R5	247
1727	226	1749A/RT	229	1760PA/AC-DC2000	236	1778V18	241	1839/R6	247
1727BM	226	1749AC	229	1760R/TC2	236	1778X	241	1839BRW	247
1727HS	299	1750	229	1760/IR1000	237	1778MT	242	1840BM	248
1727BA	314	1750CG	229	1760/IR1600	237	1778SOS-HS	300	1842LED/ABM	248
1728...	226	1750R/1 - 1750R/2	229	1760/IR500	237	1781	242	1842LED/BM	248
1728BA	314	1750RC	229	1760LX	237	1783	242	1842	249
1729CG	226	1750RP/1 - 1750RP/2	229	1760PT	237	1784	242	1843	249
1729DM 450	226	1750RT	229	1760TMC	237	1784BA	314	1844	249
1730	226	1750KG10	230	1760WWM	238	1800/100	242	1844SCK	249
1730M	226	1750M	230	1760BHS	299	1808	253	1845	249
1730V 38	226	1750M3	230	1761	238	1812 150	253	1846	249
1730INOX	304	1750TA	230	1761RS/1	238	1814M	253	1846R-LED/BM	249
1736A	227	1750TLA	230	1762	238	1820	253	1847	250
1737	227	1750HS	299	1762K	566	1820 60	253	1848	250
1737AC	227	1751N	230	1763	238	1820 80	253	1850D	250
1737B	227	1751NR	230	1763G/S500	238	1822	253	1850E	250
1737NX	227	1752	230	1764/K5	238	1822 180	253	1851VK	250
1737BA	314	1752R	230	1765/C24	238	1822 320	253	1851VK-12C	250
1738	227	1753	230	1766	238	1823 60	253	1851VK-12V	250
1739B	227	1753R	230	1766/8	238	1823R/60	253	1852R1750	250
1740A	227	1754	231	1766A	238	1824R	253	1852S-CC	250
1740B	227	1755	231	1766ER	239	1825B	253	1852S-CNT	250
1741B	227	1756	231	1766ER/VW	239	1827	253	1852 S-PIATTE	251
1741B/C5	228	1756B	231	1766G	239	1827PC	253	1852S-F	251
1741BP	228	1756C	231	1766I	239	1827PCL	253	1852S-FLESS	251
1741RV...K	228	1756C-2OR	231	1766L	239	1827/K	254	1852S-KR/CNT	251
1741U	228	1756D	231	1766LI	239	1827F	254	1852S-L	251
1742	228	1756D-2OR	231	1766T	239	1827PFL	254	1860BH R/CM	254
1742/C4	228	1756G	231	1767A	239	1830T	254	1860BH R/CS	254
1742A	228	1757	231	1767B	239	1833L/USB	243	1860BH/120A	254

TARTALOMJEGYZÉK CIKKSZÁM SZERINT

1860BH/160A	254	1885/C2-R7	262	1919F1/2	340	1935F	329	1949DGT/2	336
1860BH/200A	254	1885/C3	262	1919F1/4	340	1936/4A	329	1949F2	336
1860BHT R/CM	255	1885/C3-R1	262	1919F3/8	340	1936/5A	329	1949GPA	336
1860BHT R/CS	255	1885/C3-R10	262	1919L	340	1936/7A	329	1949GPN	336
1860BHT/160A	255	1885/C3-R2	262	1919ML	340	1937	329	1949M	336
1860DM	255	1885/C3-R3	262	1919RB-F	340	1937KC	329	1949R	336
1860EI	255	1885/C3-R4	262	1919RB-FE1/4	340	1937R/P	329	1949T	336
1860M	255	1885/C3-R5	262	1919RF-F	340	1937C...	330	1950BZK	336
1860PMIG	255	1885/C3-R6	262	1919RF-FE1/4	340	1937K...	330	1951	337
1860RG	255	1885/C3-R7	262	1919RM-F	340	1937KL	330	1951A	337
1860SQ	255	1885/C3-R8	262	1919RM-FE1/4	340	1937KL-D	330	1952	337
1870	256	1885/C3-R9	262	1919SC	340	1937M	330	1957 115-750W	316
1870I	256	1885/XC60	262	1921B1	321	1937M-01÷11	330	1957 125-1400W	317
1870-20/5S	257	1889	260	1921M1	321	1937N10	330	1957 230-2400W	317
1870-72 /FC	257	1889CF	260	1921M2	321	1937N10-GR	330	1972/13	315
1870-72/FL	257	1893/134A	262	1921N3	321	1937N20	330	1984/18QM	315
1872L	256	1893/1234YF	263	1922P1	321	1937N20-GR	331	1995MQ/G1 - G2	293
1872L 35/5S	257	1893TR/1234YF	263	1922P2	321	1938	331	1995MQ/T	293
1872L 35/FC	257	1893TR/134A	263	1922P3	321	1938R/L	331	1996MQ/GM	293
1873	256	1893TR/CI	263	1924F	321	1938R/S5	331	1996MQ/T	293
1873-30/5S	257	1895 13	263	1924B	322	1940	331	1996SVG	293
1874	257	1895 6	263	1924CD	322	1940/C6	331	11001H	529
1874-50/5S	257	1895/S	263	1924XM	322	1940/S5	331	11002	529
1874-50/FC	257	1895G	263	1927B	322	1940E10	331	11003	529
1875LT	257	1895 27	264	1927B/K5	322	1940MT	331	11011	529
1875SP/K3	257	1895/RC	264	1927CD	322	1940S...	331	11011H	529
1877	257	1897	264	1927CD/K3	323	1940E10/MT	332	11018	529
1877A	258	1897/CRB	264	1927P	323	1940E10/S...	332	11019	530
1877F	258	1897/G	264	1927P/K3	323	1940E10/S5	332	11021	530
1878 2	258	1897/MV	264	1927PAL	323	1942A	332	11023	530
1878 3	258	1898/B	264	1927XM	323	1942LR	332	11024	530
1878 4	258	1898/K40	264	1927XM/K5	323	1944A	332	11031÷11039	530
1878 8	258	1898/D	265	1927AN	324	1944AR 2	332	11032	530
1878 11	259	1898/M	265	1927G	324	1944N	332	11034	530
1878 30	259	1898/S	265	1927SP-AM	324	1944PA	332	11035	530
1879	259	1899A	265	1928CD	324	1945S	332	11037	530
1879 6	259	1899SI	265	1928DA	324	1945S/G...	332	11038	530
1879/FUEL	259	1900M 8X15 - 1900M	337	1928DAL	324	1945C	333	11040	531
1879R/K4	259	10X15		1928XM	324	1945C/G...	333	11045	531
1880	259	1900S 8x10	337	1928K4	325	1945C/GP...	333	11046	531
1880ADB	259	1914	337	1930A	325	1945P	333	11048	531
1881	259	1915B	337	1930CD	325	1945P/S...	333	11049	531
1882	259	1915C	338	1930LA	325	1946C4,8	333	11050	531
1883	259	1915C/L	338	1930LH	325	1946T	333	11069	531
1883NC	259	1915D	338	1930PA	325	1946C/T...	334	11100	532
1884	260	1915E	338	1930HLA	326	1946C7,8	334	11101	532
1884/C12	260	1915E/XL	338	1930ZL	326	1946KF	334	11102	532
1884N/C8	260	1916G	338	1931AN10	326	1946KF/M...	334	11105	532
1885	260	1916GF	338	1931CD10	326	1947	334	11106	532
1885/C1	261	1916GFE	338	1931CD13	326	1947G	334	11107	533
1885/C1-R1	261	1916I	338	1931CD6	326	1947G2	334	11110	533
1885/C1-R2	261	1916JF	338	1932B10	327	1947H	334	11111	533
1885/C1-R3	261	1916JM	338	1932B13	327	1948	335	11115	533
1885/C1-R4	261	1916P	338	1932RS13	327	1948PR	335	11116	533
1885/C1-R5	261	1916S	339	1933	327	1949BC	335	11120	533
1885/C1-R6	261	1917F	339	1933AN90-H	327	1949BC/RU	335	11121	534
1885/C1-R7	261	1917JF	339	1933IH	327	1949P	335	11125	534
1885/C1-R8	261	1917JM	339	1933ILH	327	1949U5	335	1112K	560
1885/C2	261	1917M	339	1933AN90	328	1949U5/A	335	11130	534
1885/C2-R1	261	1917RG	339	1933I	328	1949U5/B	335	11131	534
1885/C2-R2	261	1917SP	339	1933IL	328	1949U5/C	335	11132	534
1885/C2-R3	261	1917ST	339	1933L	328	1949U5/D	335	11135	534
1885/C2-R4	261	1918	339	1934BV	328	1949U5/E	335	11140	535
1885/C2-R5	261	1918N	339	1934MAV	328	1949U5/F	335	11141	535
1885/C2-R6	261	1918R	339	1934MAV70	328	1949U5/G	335	11145	535
		1919FE1/4	339						

TARTALOMJEGYZÉK CIKKSZÁM SZERINT

11200A	535	2002/BV13	344	31BM/D6	9	345SB2	31	3000L	266
11200B	535	2002/BV42	344	31L	10	345SC	31	3000L/RLS	266
11202A	535	2005MPU	344	31SE	10	345SI	31	3000M/PLM	371
11202B	535	2005PA/D	344	32	10	345SI/R	31	3002	266
11202C	535	2005PA/E	344	32AU	10	345U	31	3002/RLS	266
11204A	536	2005PA/S	344	32AUR	10	345U/A	31	3003	267
11204B	536	2009ID	344	32BA	306	349	31	3003/RLS	267
11204C	536	2009N/BV	344	34	10	349/SMAS	31	3003C	267
11208A	536	2028/VV	344	34BA	306	349/SMM	31	3003C/RLS	267
11208B	536	2028E	344	34INOX	302	350	32	3003PRO	267
11210A	536	2029/VV	345	35	10	351C	32	3003PRO/PM	267
11210B	536	2029E	345	35HS	294	351P	32	3003PRO/RCR	267
11210C	536	2032/TE	345	35PM	10	352C/U	32	3003PRO/RRG	267
11212A	536	2032/TV	345	35PMR	10	352U	32	3003PRO/RT	267
11212B	536	2033L	345	36	10	353N	32	3003PRO/SP	267
11214A	537	2033L/VV	345	37	10	353N/C6	32	3004	267
11214B	537	2036/TV	345	37PM	10	353NM	32	3006	268
11214C	537	2036E	345	37PMR	10	355	32	3006 R/RG	268
11216A	537	2037/TV	345	38/DS1	570	357F3	32	3006 R/RGF	268
11216B	537	2038/TV	346	38/DS2	570	357R/F3	32	3007	268
11216C	537	2041UC	346	39BA	307	358	33	3007 R/RG	268
11218A	537	2051N	346	39INOX	302	358RL	33	3007 R/RGF	268
11218B	537	2055HB	346	310	27	359	33	3008	268
11220A	537	2080/VG	265	310/C4	28	359CH	33	3009	268
11220B	537	2080/V6	346	310/C8	28	360	33	3009R/GR4	269
11220C	537	2080/V6-U	346	310B	27	360HS	296	3010/T...	269
11223	538	2080/D10	347	311	28	360R/...	33	3010H	269
11230A	538	2080/V12	347	330	28	361N	33	3010V	269
11230B	538	2080/V12-...	347	330BA	309	362	33	3011/T	269
11232A	538	2115P L-MQ32	291	330BA/2R	309	362INOX	303	3012	269
11234A	538	2115PI/BIKE-HOME	350	330R/A	28	362R/...	33	3012C	269
11234B	538	2250-O	265	330R/I	28	363	33	3012I	269
11240A	539	2252	265	331C	28	363BA	309	3014	270
11240B	539	2252KR4	265	332	29	363R/...	33	3014 SAR	270
11242A	539	2254A	266	334	29	365	33	3014R/GR5	270
11242B	539	2254C	266	334R	29	365R/...	33	3014SAR/1	270
11246A	539	2254F	266	334R/I	29	366	33	3014SAR/2	270
11248A	539	2254K	266	336	29	374	34	3014SAR/RR	270
11248B	539	2254SM	266	338	29	374K	556	3023	270
11259	539	2254T	266	338R	29	374R/...	34	3025	270
11260	540	2258-O	266	338R/I	29	375	34	3025/PF	270
11263	540	2300ST/KIT	359	338RP	29	376	34	3025/RF	270
11264	540	2400 RSC24/PC	365	339A	29	378	34	3025/RG	270
11265	540	2400 RSC24/PD	365	339A/R	29	378BA	309	3026 0,3	270
11266	540	2400 RSC24/PF	365	340	29	383	34	3026 0,5	271
11268	540	2400 RSC24/PF-	365	340C	30	383R	34	3026 1,0	271
11271A	540	2400 RSC24/PL	365	340C/KRL	30	384	34	3026/R 1,0	271
11271B	540	2400 RSC24/SPC	365	340RL	29	384RC	34	3026/R0,3	271
11271C	540	2400 RSC24/MP	366	341	30	386A/RC	34	3026/R0,5	271
11276A	540	2400-COVER RSC24	381	341B	30	386A	35	3026/S	271
11276B	540	2400-COVER	381	341B/RL	30	386BA	309	3026/SA	271
11276C	540	RSC24AXL		341B/RM	30	387	34	3026/SAM	271
		2499PC	366	341RL	30	387R	34	3026/SP	271
		2499PF	366	342	30	388	34	3027 10	271
		2499PF/M	366	342A	30	388A	34	3027 20	271
2001/B26	342			342A/MOL	30	388C/C8	34	3027 100	272
2001/BV	342			342A/RL	30	389/K4	35	3027 30	272
2001/BZV	342			342MOL	30	392C	35	3027 50	272
2001/BZ24 MQ	343	30	9	342P	30	392RG/C	35	3027/KP	272
2001/BZ27 VU	343	30BA	306	342P/RL	30	393	35	3027/KPP50	272
2002/BV12	343	31	9	342RL	30	395	35	3027/PR	272
2002/BV6	343	31/B6N-LSE	10	345	31	395T	35	3028 20	272
2002/BV7-ZIP	343	31/B6N	9	345C	31	398	35	3028SP/20	272
2002/BV8	343	31BA	306	345SB	31	399	35	3028 30	273
2002/BV9	343	31BA/C	306	345SB/R	31	399R/...	35	3028 50	273
2002/BVL6	343	31BM	9					3028SP/30	273

2

3

TARTALOMJEGYZÉK CIKKSZÁM SZERINT

3028SP/50	273	3092	281	3992	286	420A	41	437K/12	47	
3029/2T	273	3093/E	281	4		420B	41	437K/16	47	
3029/2T-L/R5	273	3093/U	281			421	41	437K/33	47	
3029/2T-L/R6	273	3094PA	281		42	11	421/SP6	41	437P	46
3029/2T-L/RP	273	3095	281		42/B	10	422	41	437U/09	47
3029L/2T	273	3099E	281		42/B9N	11	423	41	437U/E-M...	47
3030/2T	273	3099T	281		42/S	11	423A	41	437U/PM	47
3030/2T-R5	273	3500/P-M	373		42/SC9I-E	12	424	41	438...	47
3030/2T-R6	273	3700/PC	376		42/SP25	12	424/SP	41	438A	47
3030/2TRP	274	3700/PF	376		42AS	12	425	42	440	47
3030H/2T	274	3700/PFL	376		42AS/B9N	12	425/SP	42	440A	48
3033/3T	274	3700/PLA	376	42AS/S	12	426	42	440ASC	48	
3033E/3T	274	3700/PLL	376	42BA	307	426/SP	42	440ASF	48	
3033S 3T/R2	274	3700-COVER C37	381	42BA-AS	307	426MD-3/CP3	42	440ASG	48	
3035	274	3910	283	42HS/AS	294	426MD-3/CT3	42	440ASW	48	
3036	274	3912PP	283	42INOX	302	426MD-3/F3	42	440B	48	
3040C	277	3912TP	283	42INOX/S	302	426MD-3/FA3	42	441	48	
3040C/S1	277	3912TP/A	283	42INOX/SC10	302	426MD-3/OG3	42	441A	48	
3040C/S2	277	3912TP/C	283	42INOX-AS	302	426MD/CP	43	441B	49	
3041C	277	3912TP/FOX	283	42INOX-AS/S10	302	426MD/CT	43	442	49	
3041C/12	277	3912TP/QRE	283	42LMP	13	426MD/F	43	443	49	
3041C/16	277	3912TP/ROAD	283	42LMP/S	13	426MD/FA	43	444	49	
3042C	277	3912TP/RS	283	42MP	12	426MD/OG	43	444G	49	
3043C	277	3912TP/ST	283	42MP/B9N	12	426MD/OV	43	446/C30	49	
3043C/ 41÷47	277	3916MMP	284	42MP/S	12	426MD/S	43	446/C48	49	
3047C	277	3918MML	284	42NEWHS	294	426MD/SP10	43	446/C110	50	
3048C	277	3921	284	42NEWK	555	426MD/T	43	446ASC/C37	50	
3050/CC	277	3923	284	42SLIM	13	426MD/TA	43	446ASF/C29	50	
3050/600	278	3927	284	42SLIM/B8NI-E	13	426MD-3/A9	43	446ASG/C23	50	
3050/KA	278	3932U	284	42SLIM/S11	13	426MD-3/OV3	43	446ASW/C36	50	
3050/LA	278	3935	284	45	13	426MD-3/S3	43	447/C37	51	
3050/MS	278	3937	284	410	36	426MD-3/T3	43	447/C53	51	
3050/MV	278	3948	284	410/SP	36	426MD-3/TA3	43	447/C70	51	
3054	278	3952	284	410/SEL	37	426SB	42	450	51	
3055M	278	3952/S	284	410A	37	426SB/SP	42	450/C13	52	
3057	278	3953	284	410AS	37	426T	42	450/C15	52	
3061/2T	274	3955	284	410AS/SEL	37	426T/SP	42	450/C21	52	
3061/2T-P100	274	3961 3,2	284	410AS/SP	37	427	44	450/C9	52	
3061/2T-P50	274	3961 3,3	284	410MIX/SEL19	37	428/C14	44	450AD	51	
3065/20-10T	275	3961 3,5	285	412	37	428FC	44	450AL	51	
3065/40-20T	275	3961U	285	412/SP	37	428FP	44	450PA/1	52	
3067/60-15T	275	3962MV	285	412/C150	38	429/C14	44	450PA/2	52	
3067/70-13T	275	3962SH	285	412/SP91	38	429FC	44	450PR	52	
3070B	278	3963P	285	412A	38	429FP	44	451	52	
3070B/10	279	3964	285	412C	38	430	44	451GA	53	
3070BE/B	279	3965	285	412L	38	430/SP	44	451PA	53	
3070BE/F	279	3965C	285	412XL	38	430ASC	45	451PR	53	
3070BE/K	279	3967	285	414	38	430ASW	45	452	53	
3070BE/S	279	3969	285	414/C116	39	431	45	452GA	53	
3071A	279	3969K3	285	414/SP	39	431/SP	45	460	53	
3071B	279	3971	285	415	39	433	45	460G	53	
3071RS	279	3972	285	415/C116	39	433ASF	45	460PP	53	
3072N	280	3973/1	285	415/SP	39	433ASG	45	4900-COVER C49	385	
3073	280	3973/2	285	415/SP91	39	434	45	5		
3075/CM	280	3973PF	285	415CO	39	435	46		52	13
3075/K10	280	3973/3	286	415CO-A	39	435G	46		52MQ	289
3075A	280	3973/4	286	415C	40	436	46		53	13
3075B 55	280	3975	286	415CO/SP	40	436L	46		55	13
3075MV	280	3984/1	286	415L	40	436R	46		55/B12N	14
3079/21	280	3984/2	286	416	40	437C	46		55/B8N	14
3080/C15	280	3984/3	286	416/SP19	40	437C/...	46		55/S	14
3080R/CS3	280	3984/4	286	417	40	437C/RM14	46		55/SP	14
3081	280	3984/5	286	417/SP	40	437K/8	46		55AS	14
3085	280	3984/6	286	419	40	437K/9	46	55AS	14	
3091	281	3991	286	419T	41	437K/10	47	55AS/S	14	

TARTALOMJEGYZÉK CIKKSZÁM SZERINT

55BA	307	5915VU/AS	463	667N	67	6600 M/424	579	720AS	72
55BA-AS	307	5927VU/M	463	668N	67	6600 M/427	579	720B	72
55HS	295	5935VI/2MB	449	668RG	67	6600 M/430	579	720FRD	73
55K	555	5935ET/1MB	472	668RGC	67	6600 M/440	579	720FTX	73
55MP	14	5935VG/1MB	488	669N	68	6600 M/456	579	720FTX/SB	73
55MP/S	14	5938U/2T	464	671B/C10	68	6600 M/465	579	720IC	73
58	14	5940SBK	488	671B/C5	68	6600 M/480	579	720LS	123
58BA	307	5941VU/M	489	671N/C10	68	6600 M/485	579	720L	72
58BA-AS	307	5945VUM	490	671N/C20	68	6600 M/510	580	720L/S3	72
560/C12	55	5954VI	451	671N/C30	68	6600 M/532	580	720LC	72
560/C2	55	5954VG	491	674/C	69	6600 M/534	580	720LC/C3	72
560/C3	55	5957VI	450	677	69	6600 M/542	580	720LC/PM5	72
560/C3PLUS	55	5957U-P	465	677/C	69	6600 M/548	580	720LC/S5	72
560/C4+	55	5957VG	492	677/CP200	69	6600 M/561	580	720LCL	73
560/C6	55	5958U	466	677/CV - 678/CV	69	6600 M/583	580	720LCL/C3	73
561/1	55	5980U/BIKE	468	678/C	69	6600 M/643	580	720MC	71
562-1/VA - 562-2/VA	56	5980ET/A	473	680TC	70	6600 M/650	580	720MC/C13	71
562VV-A	56	5980/MQ	474	682	70	6600 M/657	580	720ME	73
564-3R/V - 564-4R/V	56	5980ET/B	474	6200M/B	629	6600 M/658	580	720ME/C8	73
565-1R/VA - 565-2R/ VA - 565-3R/VA	56	5980EL/A	475	6200AP/S10	630	6600 M/716	581	720MRC	73
565-4R/VB	56	5980EL/B	476	6600 M/14	575	6600 M/813	581	720S	72
565-5R/VB	56	5980ID	477	6600 M/22	575	6600 M/842	581	720S/SB6	72
565VV-B	56	5988U/7M	459	6600 M/27	575	6600 M/852	581	720TC	73
567-4R/VB	56	5988H/7M	469	6600 M/29	575	6600 M/856	581	720TC/S5	73
567-5R/VB	56	5988L/4M	470	6600 M/33	575	6600 M/857	581	720TX	73
581	60	5988U/6M	471	6600 M/40	576	6600 M/871	581	720TX/C6	73
583	60	5988 VHB-MQ	475	6600 M/42	576	6600 M/878	581	720XZN	74
583/C31	60	5990V1	467	6600 M/44	576	6600 M/881	581	727/ES16	74
590 - 592	60	5990V3	467	6600 M/47	576	6800 VE	575	727/ES16TX	74
594	60	6		6600 M/51	576	6800BA	630	727/C16	75
596 - 598	60			6600 M/52	576	6800RS	630	727/ES22	75
599DGT	61	600	61	6600 M/58	576	6888B1/2	568	727/ES22TX	75
599DGT-AN	61	601C	61	6600 M/59	576	6888B1/4	568	727/ES32	75
5700LAMP	393	601CA	61	6600 M/61	576	6888B3/8	568	727PI/16	74
5902VI	443	603	62	6600 M/62	576	6888	575	727PI/16 1/2	74
5902MT	477	604B	62	6600 M/63	576	6888GS	630	727PI/22	75
5902MT/AS	478	605E	62	6600 M/73	576	6888GW	630	727PI/32	75
5904VI/1T	443	606MQ/50	289	6600 M/112	577	7		728	75
5904VI/2T	444	610/5	62	6600 M/116	577			728/C10	75
5904VI/3T	445	610L/5	62	6600 M/120	577	73	15	728/15	76
5904VU/1M	452	610L/5L	62	6600 M/125	577	73/B13N	15	728/16	76
5904VU/2M	453	611	62	6600 M/126	577	73/S	15	728/21	76
5904VU/2T	454	612 ÷ 614	62	6600 M/131	577	78	15	728/22	76
5904VU/3T	455	614/50	62	6600 M/174	577	78AS	15	728/22L	76
5904VU/4T	456	615	63	6600 M/175	577	78BA	307	728/25	76
5904VG/2M	479	616 - 617 - 619	63	6600 M/217	577	78BA-AS	308	728/OR - 728/SP	76
5904VG/2T	480	621	63	6600 M/218	577	710	70	728AS	75
5904VG/3	481	622	63	6600 M/222	577	710/16	70	728B	76
5904VG/3T	482	641	63	6600 M/223	577	710/20	70	728FTX	75
5904VG/5T	483	642	63	6600 M/230	578	710/C10	70	728L	76
5905VG/1	484	643	63	6600 M/236	578	710/21	71	728L/S	76
5905VG/2	485	644	63	6600 M/241	578	710/22	71	728LQ	76
5908VI/2T	446	650A	63	6600 M/242	578	710/25	71	728LS	76
5908VU/2T	457	650H	64	6600 M/253	578	710/OR... - 710/SP...	71	728ME	75
5908VG/2T	486	652	64	6600 M/311	578	720	71	729	76
5910VI/3	447	653	64	6600 M/315	578	720/C12	71	729/15	103
5910VI/3T	448	654	64	6600 M/320	578	720/C24	71	729/16	77
5910VG/3T	487	659/15	64	6600 M/326	578	720/C6	71	729/21	77
5914VU/M	458	659/16	64	6600 M/327	578	720/15	74	729/21L	77
5915VU/0	460	665	65	6600 M/330	578	720/16	74	729/22	77
5915VU/1	460	665LB	66	6600 M/371	578	720/20	74	729/25	77
5915VU/2	461	665SW	66	6600 M/380	579	720/21	74	729/OR... - 729/SP...	77
5915VU/3	461	666HS	296	6600 M/406	579	720/22	74	729L	77
5915VU/4	462	666N	66	6600 M/417	579	720/25	74	729LS	77
5915VU/5	462	666N LBF.IN	67	6600 M/423	579	720/OR... - 720/SP...	74	729T	77

TARTALOMJEGYZÉK CIKKSZÁM SZERINT

730	77	7294HM	609	7549N	626	7905G	620	861RIBE	81
730/15	78	7294HMC	609	7549NE	626	7907G	622	861RTX	81
730/21	78	7294HN	609	7549R	626	7907P	622	861SP	81
730/25	78	7310CRK	597	7550G	627	7909B	621	861TX	80
730L	77	7314AF	599	7550N	627	7909G	621	861TQS	81
733/15	78	7315AN	599	7557BL	627	7909P	621	861TRW	81
7041LCD/4S	255	7316NB	600	7575N	622	7909V	621	861TX/C	81
7041LCD/4S-VE	255	7316NG	601	7579QN	622	7930G	617	861XZN	81
7041LCD/4S-VI	255	7317NA	600	7600G	613	7931G	619	862F/A7	557
7042LCD	256	7318AN	600	7600N	613	7933G	620	862F	82
7042LCD/RV	256	7320NA	600	7610G	614	7935G	620	862LP	81
7042LCD/RV-INT	256	7321NA	601	7610N	614	7939G	621	862PH	81
7043	256	7322SA	601	7611G	618	7940	617	862PE	82
7061TC	629	7323SA	601	7635N	624	7949	621	862PH/L	82
7076BC	629	7328A	590	7637G	624	7970	627	862PH-XL	82
7076BD	629	7328N	590	7650	614	7971L	627	862PZ	82
7076BP	629	7340B	607	7650B	614	7978L	627	862TX	82
7076BU	629	7341N	607	7653G	620	7979B	628	862TX/L	82
7093BC	629	7349RP	607	7654B	624	7980N	628	862TX-XL	82
7093BD	629	7350RP	608	7654N	624	7980NC	628	866LP	82
7104 90	628	7352A	602	7657B	624	7980R	628	866PH	82
7105 6	628	7352B	602	7657N	625	7984EG	628	866PZ	82
7109A	629	7352G	602	7658CM	623	7984G	628	866PE	83
7109D	629	7352LG	603	7658N	623	7985	628	866RTX	83
7195A	629	7353Y	603	7659N	623	7996N	628	866TX	83
7200BKK	596	7354N	603	7660B	614			867/...	84
7201BKK	596	7355V	603	7660G	614			867/C20	84
7210BKK	596	7356G	604	7661B	618			867/C38	84
7212B	593	7356LN	604	7661G	618	80	15	867/C52	84
7212G	593	7356V	604	7664G	625	80/S	15	867PE	83
7212LG	593	7357G	604	7664N	625	83	15	867PE/L	83
7213G	594	7357V	605	7665G	625	83/S	15	867RIBE	83
7214FN	594	7362B	605	7665N	625	83AS	16	867RTX	83
7214G	594	7363N	605	7669N	623	83AS/S	16	867RTX/L	83
7214LN	594	7372B	606	7670G	623	88	16	867RIBE/L	84
7215FN	595	7376A	606	7673NG	622	88/S7	16	867TX	83
7216BKK	597	7381N	606	7674NG	623	89BA	308	867TX/L	83
7218FN	595	7382N	606	7780QN	624	89MQ	289	867XZN	83
7218G	595	7398 0/G	610	7800G	628	850MQ	289	867XZN/L	83
7220PEK	591	7398ESD	610	7815CM	618	851	78	882	84
7221PEK	591	7398GEL	610	7818BL	615	851SR	78	882AN	84
7222PEK	591	7398T	610	7818CM	615	852	116	882M	84
7223PEK	592	7398U	610	7818G	615	855P	78	882M1	84
7224PEK	592	7398UP	610	7818LN	616	860/58K	557	882MSR	85
7225PEK	592	7398EF	611	7830SN	616	860/C27	557	882P	85
7235BK	597	7399 A/N...	611	7830ST	616	860/55	79	892	85
7236BK	598	7421	611	7831SN	618	860/58	79	895	85
7238WR	598	7423	611	7831ST	618	860/C38P	80	897	85
7239B	598	7425	611	7840BL	616	860LP	557	897L	85
7241EN	587	7427	611	7849BL	620	860MIX/A10	557	8001Z	634
7241BK	588	7429	611	7860G	616	860MIX/A31	557	8001Z-K	634
7241CK	588	7431P	611	7861G	619	860PE	557	8001TZ	635
7243EN	587	7527	613	7863G	619	860PH	557	8001TZ-K	635
7243BK	588	7528	613	7865G	620	860PZ	557	8002ZD	635
7243CK	589	7529	618	7867G	622	860PE/A10	79	8002ZS	635
7243CR	589	7530	613	7869G	621	860PHZ/A10	79	8003ZD	635
7243FT	589	7545F	625	7880SC	616	860RTX	557	8003ZS	635
7245BK	589	7547AZ	625	7900B	617	860TX	557	8004ND	635
7246E	587	7547BL	625	7900G	617	860TX/A10	557	8004NS	635
7246BK	590	7547G	626	7900P	617	861/C61P	81	8005Z	632
7247BK	590	7547N	626	7900V	617	861LP	80	8005TZ	633
7248GK	598	7547R	626	7901G	619	861PE	80	8005TZ-K	633
7249GK	599	7549AZ	626	7903G	619	861PH	80	8005Z-K	633
7293HM	608	7549BL	626	7903P	619	861PH/C	80	8006Z	633
7293HN	608	7549G	626	7904N	624	861PZ	80	8006Z-K	633
						861PZ/C	80		

TARTALOMJEGYZÉK CIKKSZÁM SZERINT

8007Z	633	8060R/PS	656	8146/RKCI	657	8205	658	8600 R/601	582
8007Z-K	633	8061R - 8061F	649	8146/RKFC	657	8206	658	8600 R/611	582
8008N	633	8062	650	8146/RKLL	657	8207	658	8702N	636
8008N-K	633	8063	649	8146/RPC	657	8209	658	8702Z	636
8008TZN	634	8063SL	649	8147C	651	8210	658	8702ZC	636
8009TZ	634	8064S	649	8147S	651	8210F	659	8709N	637
8009TZ-K	634	8065SC	650	8147P	652	8210FTP	659	8709Z	637
8009Z	634	8068S	641	8148	652	8216	659	8709ZC	637
8009Z-K	634	8074	653	8148F	652	8216-K	659	8872	300
8009FD	636	8074A	653	8148/RA	657	8220	659	8872A	300
8009FS	636	8074G	653	8148/RKCL	657	8225	660	8872AS	300
8010TZ	634	8080	653	8148/RKCM	657	8227	660	8873	300
8010Z	634	8080FM	653	8148/RKG	657	8228	660	8877	300
8010Z-K	634	8082	653	8148/RKS	657	8240	660	8877M	300
8015	637	8083	653	8148/RP	657	8240F	660	8879	300
8016	637	8085R	648	8149S/A	651	8242F	660	8880	300
8016FR	637	8086	648	8149	658	8242	661	8883	300
8016FR-K	637	8090R - 8090	648	8149CM	658	8248	659	8889C1	518
8016-K	637	8090F	667	8149CM/RA	658	8249	659	8889C2	518
8016U2	638	8091	644	8150	664	8249G	659	8889C3	518
8016UGK	638	8091SL	644	8153	664	8250	662	8889P1	518
8016U-K	638	8092	644	8156	664	8264	662	8889P2	518
8018E	638	8092SL	645	8157	664	8267	662	8889P3	518
8018T	638	8094	645	8158	664	8272	662	8889C6	519
8020A	638	8094SL	645	8159	665	8273	662	8889CD	519
8021A	638	8096	646	8160	665	8274	661	8889CS	519
8025	639	8096SL	646	8161	665	8274A	661	8889I4	519
8025-K	640	8097	646	8166	667	8274G	661	8889P4	519
8026R	639	8097SL	647	8170	665	8276	661	8889PD	519
8026R-K	639	8098	647	8173	665	8276G	661	8889PS	519
8026A	640	8098SL	647	8176	665	8278	661	9	
8026A-K	640	8100	648	8177	665	8279	663		
8028	640	8105	632	8178	666	8280	662	90	16
8028-K	640	8105-K	632	8179A	666	8282S	662	90/B8N	16
8029R	639	8109	632	8179B	666	8284	662	90/S	16
8029R-K	639	8109-K	632	8179M	666	8285	662	90/SP	16
8031R	639	8110	632	8180	667	8286	663	90AS	16
8031R-K	639	8114	653	8181	667	8287	663	90AS/S	16
8032	639	8116	654	8181S	667	8290	663	90BA	308
8032-K	639	8120	652	8182	668	8293	663	90K	555
8040EN	642	8120B	652	8182A	668	8297C	663	91	17
8040EN-K	642	8120D	652	8182E	668	8297F	663	91BA	308
8040EZ	642	8120DZC	652	8182GD	668	8302Z	636	91HS	295
8040EZ-K	642	8129	653	8182H	668	8303Z	636	91HS-C	295
8041	641	8130	655	8182S	668	8317DZ	654	92	17
8041-K	641	8130A	655	8182T	668	8317SZ	654	92BA	308
8042EN	643	8131DL	655	8182TS	668	8381SL	654	92HS	295
8042EN-K	643	8131Z	655	8182H/2	669	8381SP	654	93	17
8042EZ	643	8135	650	8183	669	8381SX	663	93BA	308
8042EZ-K	643	8135/KCA	656	8184	669	8383C	654	93C	17
8043	642	8135/KGF	656	8185	669	8383P	654	93HS	295
8043-K	642	8135/KGM	656	8186	669	8515V	654	93K	555
8044	643	8135/KLA1	656	8187	670	8515Z	654	94	17
8048	636	8135/KMO	656	8188C	670	8515CH	655	94/S	17
8049	640	8139DL	655	8188CG/25	670	8531	655	94K	555
8049A	641	8139Z	655	8188CU/25	670	8532	655	95	17
8049V	641	8139ZCH	655	8188F	670	8535	655	95/S	17
8050 D	655	8143	650	8188F35	670	8600 R/11	581	95BA	308
8051S	650	8143/RKLL	656	8188VFG2	670	8600 R/12	581	95FTX	17
8051S-K	650	8143/RPC	656	8189	670	8600 R/113	582	95FTX/S	17
8052 - 8055S	649	8143/RKCI	657	8189A	670	8600 R/114	582	96	18
8057R - 8057	649	8143/RPF	657	8189PA	670	8600 R/13	582	96/B	18
8058R - 8058	648	8146	651	8190	669	8600 R/225	582	96/BG7	18
8058R/PS	656	8146C	651	8190B	669	8600 R/412	582	96/BGS7	18
8060R - 8060	648	8146/RK	657	8201T	659	8600 R/511	582	96/SC12	18

TARTALOMJEGYZÉK CIKKSZÁM SZERINT

96/SC9	18	97BTXL	23	900FTX/SB9	87	910AN	96	920/25	103
96/ST	18	97BTXL/SC8	23	900FL	88	910A/C10	97	920/35A	103
96/ST6K	555	97RTX	23	900K	557	910A/C16	97	920/36A	103
96AS	19	97RTX/B	23	900L	86	910A/C16Q	97	920/38	103
96AS/B	19	97RTX/SC8	23	900L/SB	86	910A/C16HR	98	920/40	103
96AS/BG7	19	97TTX	23	900LP	87	910A/C17	98	920/42	103
96AS/SC9	19	97TTX/S	23	900M/R55	110	910A/C29	98	920/44	103
96AS/T	19	97TTX/SP	23	900MB	86	910AS/C13	98	920/46	103
96BA	308	97TTXHS	295	900MB/L	86	910AS/MBM-C18	98	920/50	104
96BA/BP	308	97TX	22	900MB/SB	86	910B	93	920/50F	104
96BAF-AS	309	97TX/B	22	900MC	86	910B/SB	93	920/55	104
96BP	20	97TX/BG8	22	900MC/LP	87	910B/SN	94	920/55LC	104
96BP/SC9	20	97TX/G	22	900MC/PH	87	910BL	94	920/55Q	104
96BPC	20	97TX/SC8	22	900MC/TX	88	910BL/SB	94	920/55X	104
96BPC/SC9	20	97TX/ST	22	900ME	88	910BP	95	920/56A	104
96BP-CL	20	98XZN	23	900ME/SB8	88	910BP/SB6L	95	920/58	104
96BP-CL/SC9	20	98XZN/B	23	900M/35	89	910B/C10	97	920/C37	107
96BP/AS	21	99	23	900M/55	90	910B/C16	98	920/R50	111
96BP/ASB	21	99 VN/...	24	900MB/C19	91	910B/C16Q	98	920/R55	111
96BP/AS-SC9	21	99BA	309	900MB/C28	91	910B/C29	98	920/R55LC	111
96BPA	21	99SQ	23	900MC/C24	92	910CF	96	920/R55Q	111
96BPA/SC9	21	99ST	24	900MC/C32	92	910CF/SB	96	920/R55X	111
96BPINOX	302	900	86	900PH	87	910E-HS/56	296	920/55INOX	303
96BPINOX-AS	302	900/R55	110	900PH/SB4	87	910FTX	94	920/R55INOX	303
96BPINOX-AS/B9	302	900/R55-Z	110	900PZ	87	910FTX/SB	94	920/21K	558
96C-AS/SC9	19	900/20LK	557	900PE/AS	88	910FTX/L	95	920/25K	558
96C/AS	19	900/25K	558	900PT	88	910FTX/LSB	95	920/55K	558
96INOXBP/B	302	900/55K	558	900TX	88	910FTX/XL	95	920/58K	558
96L	20	900/55ZK	558	900TX/SB	88	910FTX-XL/C10	95	920A/AS	100
96L/SC12	20	900/58K	558	900T/44	89	910LP	95	920A-AS/SB11	100
96L/SP8	20	900/SB	86	900U	87	910M/R55	111	920AS	100
96LBP	20	900/...	88	900U/SB	87	910MQ/21	289	920AS/L	100
96LBP/SC9	20	900/16	88	900U/C12M	92	910MQ/22	289	920AS/SB11	100
96LC	19	900/25	88	902A/C22	93	910MQ/B	289	920ASL/SB11	100
96LC/SC12	20	900/32	89	902R/C6	93	910MQ/PE	289	920AN	103
96LC/SC8	20	900/35A	89	910/R55	111	910MQ/PT	289	920A/C11	105
96N	18	900/40	89	910/R55Q	111	910MQ/TX	289	920A/C12	105
96N/B	19	900/42	89	910/R55X	111	910MQ/XZN	289	920A/C12X	105
96N/G	19	900/55	89	910/21K	558	910MQ/55	290	920A/C20	105
96N/SC12	19	900/55Z	89	910/25K	558	910MQ/C16	290	920A/C20Q	105
96N/SC9	19	900/58	90	910/55K	558	910MQ/T	290	920A/C20X	105
96N/ST	19	900/C11	90	910/58K	558	910ME	95	920A/C21	106
96N/ST6K	555	900/C11Z	90	910/15	96	910ME/SB	95	920A/C21X	106
96T	21	900/C12MR	90	910/16	96	910M/35	96	920A/C33	106
96T/AS	21	900/C39N	90	910/20 - 910/21 - 910/22	96	910M/55	97	920A/C17M	107
96T/S11	21	900/C39U	90	910/25	96	910M/56	97	920A/C17MR	107
96T/S6	21	900/C12MZ	91	910/36A	96	910PE	95	920AS/C10	107
96T/SP	21	900/C13-5	91	910/40	97	910PE/AS	95	920AS/C15	107
96T/SPV	520	900/C13-8	91	910/42	97	910PE/SB	95	920AS/C17X	107
96TAS/S	21	900/C24	91	910/46	97	910PH	95	920AS/MBM-C21	107
96TBP	22	900/C11HR	93	910/55	97	910PH/SB4	95	920A/C17HR	108
96TBP/S6	22	900AS	86	910/55Q	97	910PT	96	920AK	558
96TBP-HS	295	900AS/MB	86	910/58	97	910PT/SB	96	920A	99
96THS	295	900AS/SB11	86	910AK	558	910TX	96	920A/SB13	99
96THS-AS	295	900AS/L	87	910A	93	910TX/SB	96	920A/SB8	99
96TINOX	303	900AS/MBL	87	910A/SB	93	910XZN	96	920AL	99
96TINOX/S6	303	900AN	88	910AL	93	911BA	309	920AL/SB11	99
96TINOX-AS	303	900AS/C10	92	910AL/SB14	93	911BA/16	309	920BP	101
96TINOX-AS/S8	303	900AS/C17-MBM	92	910A/AS	94	911BA/20	309	920BP/SB	101
96TK	556	900AS/MB-C17	92	910A-AS/SB13	94	911BA/55	309	920B/C11	105
97BTX	22	900BG/30K	558	910AS	94	914MQ/A	290	920B/C12	105
97BTX/B	22	900BG/30	89	910AS/L	94	914MQ-A/S4	290	920B/C12X	105
97BTX/SC8	22	900BG/30C	89	910AS/SB13	94	920/15	103	920B/C20	105
97BTX-C	22	900E-HS/56	296	910AS/SN	94	920/16	103	920B/C20X	106
97BTX-C/SC8	22	900FTX	87	910ASL/SB12	94	920/20+920/23	103	920B/C21	106

TARTALOMJEGYZÉK CIKKSZÁM SZERINT

920B/C21X	106	921BA/50	310	944BX/D	114	960PI/S	122	991	126
920B/C30Q	106	921BA/R50	310	944BX/S	114	960PMC	122	992	126
920B/C33	106	921BA-AS	310	944BX/DG	570	960RPI	122	993	126
920B	99	926BA	310	949	114	960S	119	993G	127
920B/SB13	99	926BA/15	310	949/S6	114	960SL	119	993MQ	291
920B/SB8	99	926BA/22	310	950	114	960SN	119	993PL	126
920BL	99	926BA/42	310	950/S	114	960T/A	119	994	127
920BL/SB11	99	926BA/50	311	951	115	960T/B	119	994MQ	291
920ES	102	926BA/R50	311	951/S	115	960T/C11	119	994PL	127
920ES/SB	102	928.../C12	109	951/SP	115	960T/C	120	994TF	127
920ES/XL-SB	102	928/15	109	951AS	115	960T/D	120	996	127
920E-HS/55LC	296	928/16	109	951AS/S	115	960T/E	120	998	127
920FTX	100	928/20 - 928/21 -	109	951BA	311	960T/F	120	999	127
920FTX/C	100	928/22		951K	559	960T/G	120	999/B6N	127
920FTX/L	100	928/25	109	951MQ	291	960T/H	120	999A	127
920FTX/LSB	100	928/36A	109	951TX	115	960T/I	120	999B	127
920FTX/SB	100	928/42	109	951TX/S	115	960T/L	120	999C	127
920INOX-A	303	928/55	109	952	116	960T/M	120	999D	127
920LH/SB7	101	928/R55	111	952/S	116	960UC	122	999E	127
920LP	101	928/R55X	111	952AS	116	960VTC	122	999G	127
920ME	101	928A	108	952FTX	116	960YP	121	9500TL	672
920ME/SB	101	928AS	108	952FTX/S	117	961BA	311	9501TL	672
920ME/C	102	928AS/C12	109	952L	116	961P6	123	9501TLD	672
920M/35	103	928B	108	953	117	961P6/S	123	9502TL	673
920M/35L	103	928B/C12	109	953/S	117	962	123	9503TL	673
920M/55	104	928ME	108	953TX	117	962C	123	9504TL	673
920M/56	104	929	109	953TX/S	117	962M	123	9505TL	673
920MC/C14	105	929/15	110	955	117	962P	123	9508TL	673
920M/R55	111	929/21 - 929/22	110	956C	117	963	123	9510W	673
920MQ/21	290	929/42	110	956E	117	963BA	311	9515M	676
920MQ/22	290	929/55	110	956F	117	964	123	9516B	676
920MQ/55A	290	929/55PR	110	956L	118	964BA	311	9521	676
920MQ/A	290	929/C8	110	957	118	964BA/L	311	9521OB	676
920MQ/PE	290	929/R55	111	959	118	965	123	9522A	681
920MQ/T	290	930	111	959R	118	965/S	123	9523T	678
920MQ/C16	291	930/C	111	960	118	965BA	311	9523A	681
920MC	99	930/S	111	960/22EP	120	966/C3	123	9524SC	678
920PE	101	932	112	960/C6	120	966BA	311	9525/B	675
920PE/AS	101	932/S	112	960/D	120	966BA/V	311	9525F	675
920PE/C	101	932HS	296	960A	118	969/C5	124	9525TL	675
920PE/SB	101	933	112	960AVE	121	969B	124	9526P	681
920PE-AS/SB6	101	933/S	112	960AVL	122	970B	124	9526RMN	681
920PH	101	935	112	960AD/TP2	177	970IVECO	124	9527 6T	681
920PH/SB4	101	935/S	112	960BC	118	971/C8	124	9527MUG	681
920RTX	102	935K	558	960BC/C5	118	972/C10	124	9528B	678
920RTX/SB	102	937	112	960BC/P 28	118	972/C4BMW	124	9534WO	673
920TX	102	937/S	112	960BT/B	118	973	124	9534BO	674
920TX/C	102	937BA	311	960CMB	121	978 - 979	124	9537TL	674
920TX/L-SB4	102	937K	558	960CMB/R2	121	982	125	9539CB	676
920TX/SB	102	940	112	960CMD	121	983 PM/R-DA	125	9541BIKE	675
920TX/C17	108	941	113	960CMD/R1	121	983PM	125	9541F	675
920U	100	941/S	113	960ER	119	984	125	9541PC	675
920U/SB13	100	942BX	113	960EPC	121	985/B7	125	9541S	675
920U/SB4	100	942BX/S	113	960EPC/L	121	985F	125	9542M	676
920U/C17M	108	942BX/DG	570	960E-PI/P	121	985M	125	9542AL	677
920XZN	102	943BX	113	960F	119	986 48	125	9542AT	677
920XZN/LS	102	943BX/D	113	960G	119	986 78	125	9542C	677
920XZN/SB12	102	943BX/S	113	960H/C4	119	986PT	125	9542G	677
920XZN/SB7	102	943BXK	559	960KC-M8/M9/M10	121	987	125	9542GW	677
921BA	310	943BX/DG	570	960KPC	122	987AR	126	9542S	677
921BA/15	310	943FL	113	960L	119	987P	126	9543C	677
921BA/16	310	943FL/S	113	960M	119	988/K4	126	9544C	674
921BA/21 - 921BA/22	310	943MQ	291	960P	122	989	126	9547T	678
921BA/25	310	943MQ/S	291	960PI	122	989A	126	9547WSK	678
921BA/42	310	943MQ/BG	570	960PI/C19	122	989B	126	9547	681
		944BX	114			990	126		

TARTALOMJEGYZÉK CIKKSZÁM SZERINT

9548G	678	9597P	678	C11 - 2111	349	C45PRO M7	432	C55M4	410
9548KB	678	9598WHP-N	676	C12 - 2112	349	C45PRO M7A/W	429	C55M7	410
9548KB 20	678	9598W-N	676	C13	349	C45PRO M7A/X	429	C55M8	411
9548KB 24	678	9599 GARAGE	673	C14	349	C45PRO M8	433	C55MA	412
9549ABW	680	9599CB-N2	676	C16 - 2116	350	C45PRO MA	434	C55MDO	412
9549BP	680	9599CB-W	676	C18 - 2118	350	C45PRO ML	434	C55MP	418
9549CR	680	9711 - LUBRIBETA	524	C19 - 2119 - C19L - 2119L	351	C45PRO MS	433	C55MS	413
9549MPC	680	universal				C45PRO MWS/W	430	C55P/2MDX-SX	414
9549SBW	680	9713 - Ultra Sblock	524	C20 - C20L - 2120	351	C45PRO MWS/X	429	C55P/MCD	414
9549BRW	681	9721 - Multi Grease	524	C20TSS	304	C45PRO PAS	436	C55PB/3	401
9549C	681	9723 - Lithium Grease	524	C22B	351	C45PRO PF	436	C55PFA-0,8	416
9557J 2.0	675	9725 - PTFE Grease	525	C22P	351	C45PRO PFE	437	C55PFA-1,0	414
9557N	675	9727 - Copper Grease	525	C22W	351	C45PRO PM	438	C55PM	414
9559	679	9730 - Silic Spray	525	C25	368	C45PRO PML	438	C55PM/M0,8	416
9559/30MT	679	9739 - Cutting Oil	525	C27S	369	C45PRO RD	433	C55PRO B/2	402
9561V	679	9741 - Brake Cleaner	525	C30M	371	C45PRO SL	436	C55PRO B/2,8	403
9561V 2,5	679	9742 - Multi Cleaner	525	C35/6GM	372	C45PRO SS	436	C55PRO B-D4	404
9561VV	679	9743 - Contact Cleaner	525	C35/7GM	373	C45PRO T3	435	C55PS	417
9561VV 2,5	679	9744 - Surface Cleaner	525	C35/8GM	373	C45PRO TC	435	C55PSE	417
9562T1	278	9746 - Carb Cleaner	525	C35/9GM	373	C45PRO W	424	C55PT0,8x0,6	416
9562T3	278	9747 - Clima Cleaner	526	C37/6	375	C45PRO X	423	C55PT1,0x0,6	415
9562T2	397	9750 - Air Spray	526	C37/7	374	C45PW/1-0,7MT	430	C55PTE-0,8	416
9562TB	630	9753 - Zinc 98%	526	C37/8	375	C45PW/2-1,3MT	430	C55PTE-1,0	415
9562P12	683	9756 - Welding Spray	526	C37A/7	375	C45PW/3-2,0MT	431	C55RB	407
9562P2	683	9766 - De-icer Spray	526	C38	377	C45PX/1-0,7MT	430	C55STR	422
9563G	680	9801L	522	C38C	378	C45PX/2-1,3MT	430	C55T3	413
9563U	680	9802M	522	C38L	377	C45PX/3-2,0MT	431	C56	394
9565S	630	9803H	522	C38L A	377	C45STR	439	C56B	394
9565BBQ	679	9811L	522	C38T	378	C48M	386	C56M	395
9565T	679	9812M	522	C39/6	380	C48P	386	C56P O	389
9565ICE	680	9813H	522	C39/7	379	C51	387	C56PL O	389
9565K	680	9821L	523	C39/8	380	C54S	390	C56W	394
9569MS	682	9822M	523	C39MD	382	C55	400	C57SA	391
9569MS-2	682	9823H	523	C39SM	382	C55/1PF	416	C57SB	392
9569P	682	9823L	523	C39T	380	C55/2PM	415	C57SC	392
9569S	682	9824H	523	C41H	383	C55/PF	414	C57SD	391
9572LB	673	9825	524	C41H/CE	383	C55/PL-1,024	407	C57SP	393
9574B	675	9826	524	C41S	383	C55A1	420	C58B	395
9574O	675	9827	524	C42H	384	C55A1/R42	420	C58M	395
9577R	679	9828	524	C45LMP	440	C55A2	421	C58M/PA	396
9579C	679	9829	524	C45PRO ACT	435	C55A2/R70	421	C58P	393
9580S	674	9830	524	C45PRO AS1	439	C55AB	401	C59A	396
9586K	681	9831	523	C45PRO AS2	439	C55AC	418	C59B	397
9587 13x21	682	9832	523	C45PRO AW	424	C55AE	417	C59C	397
9587 9x14	682	9833	523	C45PRO AX	424	C55AT1	422	C62M/W	629
9588M	682	9834	523	C45PRO BPW-1,3	428	C55AT2	422	C64/1	629
9588S/10...	682	9835	523	C45PRO BPW-2,0	428	C55B PT/2	407	C64CW	630
9588/10PI	683	9836	523	C45PRO BPX-1,3	427	C55B PT/2,8	407	C64G/1	630
9589A/36	683	9837	523	C45PRO BPX-2,0	428	C55B/1	419	C68	574
9589B/36	683	9838	523	C45PRO BW	425	C55B/2	402	C68 G	574
9590B	679	9839	523	C45PRO BX	425	C55B/2,8	403	C68N	574
9592B/C50	681	9840	523	C45PRO C5	431	C55B/G	405	C88 R/1	574
9592B/P	681	9841	523	C45PRO C7	431	C55B/GAA	405	C88NR/1	574
9592M/50	681	9842	523	C45PRO CAI/W	438	C55B/GAE	406	C88SE	574
9592MB	681	9843	523	C45PRO CAI/X	438	C55B/GDP	405	C88VE	574
9593A	674	9844	523	C45PRO CORNER/W	437	C55B/GDS	405	C99	352
9593M	674	9845	523	C45PRO CORNER/X	437	C55B/GE	406	C99C-V3	355
9593S	674	9846	523	C45PRO CW	427	C55B/VS	407	C99M	356
9593SB	674	9847	523	C45PRO CX	427	C55B-D4	404	C99P	355
9593W	674	9848	523	C45PRO DW	426	C55C	419	C99P12-V0	353
9594	681	9849	523	C45PRO DX	425	C55C7	408	C99PC	356
9595 C25	682	9850	523	C45PRO EW	426	C55C8	409	C99PP	356
9595C	682	9851	523	C45PRO EX	426	C55CS	411	C99P-V3	356
9595T	682	9852	524	C45PRO M3A	434	C55KAI	418	C99T	356
9596	682	9853	523	C45PRO M4	432	C55KAS	418	C99T-V3	356
		9854	523	C45PRO M5	432	C55M2	409	C99V0	352

TARTALOMJEGYZÉK CIKKSZÁM SZERINT

C99V0-P12	353	M125	498	MC20	504	T45	509	T201	515
C99V1	354	M126	499	MC21	504	T46	509	T202	515
C99V2	354	M127	499	MM105	506	T48	509	T204	515
C99V3/2C	355	M128	499	MM11	506	T50	509	T205	515
CA49-G	385	M129	499	MM140	507	T52	509	T206	515
CB/2	520	M133	499	MM210	507	T53	509	T207	515
CB52	388	M134	499	MM400	507	T55	509	T208	515
CD23S	358	M135	499	MM401	507	T57	510	T209	515
CP	440	M136	499	MM61	506	T59	510	T211	515
CP15 - 2115	349	M137	499	MM63	506	T63	510	T213	515
CP15L - 2115	350	M145	499	P	T64	510	T216	515	
CP17 - CP17L - 2117	350	M153	500		T65	510	T221	516	
CP51	388	M161	500	PM 1/2-Q5	102	T68	510	T226	516
CX49-G	385	M162	500	PM/5C	440	T73	510	T227	516
G, K		M166	500	PM/6C	440	T75	510	T228	516
		M170	500	PV	393	T76	510	T231	516
		M172	500			T77	510	T233	516
GM	519	M174	500	R	T79	510	T234	516	
KIT/GPS	519	M180	500		T80	511	T236	516	
M		M195	500	RSC22	357	T81	511	T239	516
		M201	500	RSC23	358	T82	511	T241	516
		M204	501	RSC23C	358	T83	511	T250	516
M01	494	M208	501	RSC23T	359	T85	511	T256	516
M02	494	M209	501	RSC24/5	361	T91	511	T259	517
M05	494	M213	501	RSC24/6	361	T92	511	T264	517
M06	494	M214	501	RSC24/7	360	T99	511	T270	517
M13	494	M216	501	RSC24/8	361	T100	511	T273	517
M25	494	M217	501	RSC24A/6	362	T101	511	T281	517
M30	494	M218	501	RSC24A/7	362	T102	511	T284	517
M31	494	M219	501	RSC24A/8	362	T103	512	T285	517
M33	494	M222	501	RSC24AXL/7	363	T105	512	T289	517
M38	494	M226	501	RSC24AXL/8	364	T106	512	T291	517
M39	495	M227	502	RSC24AXL/9	364	T111	512	T297	518
M40	495	M230	502	RSC24L/7	367	T112	512	TSP	519
M44	495	M231	502	RSC24L-CAB	367	T113	512	V	
M45	495	M234	502	RSC28	370	T121	512		
M46	495	M236	502	RSC51	387	T123	512		
M49	495	M237	502	S	T124	512	VE1	519	
M50	495	M240	502		S42/17	520	T136	VP1 - VP2	518
M52	495	M264	502	S55/12	519	T137	VP3 - VP4	518	
M53	495	M284	503	S55/8	519	T138	VP5	518	
M55	495	M285	503	S96T/8	520	T140	VP6	518	
M60	496	M289	503	S951/6	520	T144	VP-3SC	518	
M62	496	M292	503	S952/10	520	T145	VP-LD	518	
M63	496	M295	503	S1719BM	520	T146	VP-LS	518	
M65	496	M305	503	SB	519	T151	VPM	507	
M67	496	M310	503	SGN	520	T153	VPM0	507	
M69	496	M400	503	SPC	440	T156	VPM3	507	
M75	496	M401	503	SPG11 - S1203/8	520	T157	VPM7	507	
M78	496	MB	519	ST2P	519	T160	VPM7-C	507	
M79	496	MB12	504	T	T161	513	VPM8	507	
M82	496	MB37	504		T164	513	VPM9	507	
M83	497	MB38	504	T167	514				
M85	497	MB39	504	T168	514				
M86	497	MB44	505	T170	514				
M91	497	MB45	505	T171	514				
M92	497	MB46	505	T172	514				
M94	497	MB47	505	T173	514				
M96	497	MB56	505	T175	514				
M100	497	MB58	505	T176	514				
M105	498	MB59	505	T177	514				
M108	498	MB63	506	T180	514				
M110	498	MB64	506	T183	514				
M112	498	MB65	506	T198	514				
M115	498	MC10	504	T199	515				
M120	498	MC12	504	T41	509				
M121	498		504						

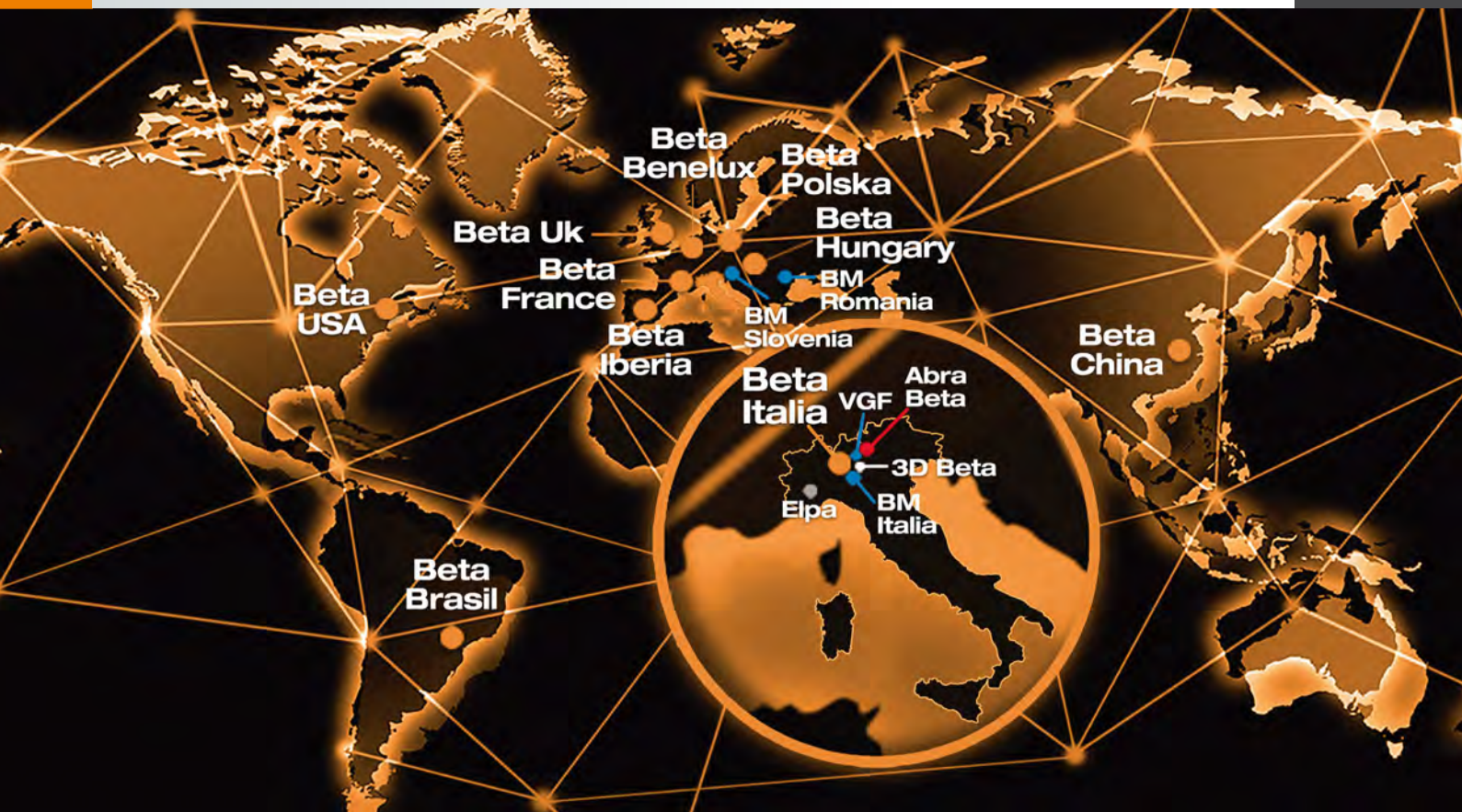

**8 termelési egység
OLASZORSZÁGBAN**



Mintegy 900 alkalmazott

**Világszerte 11
leányvállalat**

**Több mint 250
importőr a világ
több mint 100
országában**



BETA UTENSILI S.p.A. - 20845 Sovico (MB)
Via A. Volta, 18 - Tel. 039.2077.1 - Fax 039.2010742
www.beta-tools.com

Sede produttiva Accessori per funi Robur:
67039 Sulmona (AQ) Zona industriale - C.da S. Nicola
Tel. 0864.2504.1 - Fax 0864.253132
www.roburitaly.com - info@roburitaly.com

AZ OLASZ SZERSZÁMKÉSZÍTÉS TÖRTÉNETE

- 1923** ● Alessandro Ciceri megalapítja a vas- és acél öntvények gyártására az „Alessandro Ciceri & Figli” vállalatot.
- 1939** ● A Beta védjegy bejegyzésre kerül és a Vállalat elsősorban professzionális kéziszerszámok gyártásában lesz érdekelt. A Vállalat székhelye Sovico.
- 1960** ● A Beta Utensili már 200 főt foglalkoztat, külföldre is szállítja termékeit és professzionális kéziszerszámok gyártójaként tűnik ki.
- 1969** ● Kifejlesztésre kerül a forradalmian új, narancssárga, fém “Tank” szerszámkocsi; ettől kezdve a narancs szín a Beta egyedi stílusának védjegyévé válik.
- 1971** ● A Beta Utensili belép a motorsportok világába – először a Formula 1-ben, ezt követően a rally versenyekben, majd valamennyi motorsport területén megjelenik.
- 1973** ● Megkezdzi működését az új gyár Castiglione d’Adda-ban, ezzel kiegészül a Sovico-i gyár.
- 1975** ● Az első alkalom, hogy a Vállalat komoly sikert ér el a Formula 1-ben. Vittorio Brambilla szakadó esőben megnyeri az Osztrák Nagy Díjat Zeltwegben a narancssárga March-Beta Utensili-vel.
- 1980** ● A Beta Utensili fokozatosan tovább terjeszkedik és kereskedelmi kirendeltségeket alapít Franciaországban, Angliában, Hollandiában, Spanyolországban, Lengyelországban és Magyarországon.
- 1984** ● A Vállalat megnyitja harmadik gyárát Sulmona-ban és megkezdzi az 42-es cikkszámú ikonikus csillag-villáskulcsok gyártását. Emellett Robur márkanév alatt elindul az emelőtechnikai szerelvények gyártása és tesztelése.
- 1995** ● A Vállalat nem több, mint 8 hónap alatt kiérdemli az ISO 9001 minőségi irányítási tanúsítványt.
- 2000** ● A Beta Utensili katalógus kiadása igazolja a folyamatos növekedést. Az elérhető termékek száma megduplázódott, ezzel több mint 10.000 termék vált elérhetővé 20 termékcsaládban.
- 2002** ● A Beta Utensili termékválasztéka tovább bővül a védőlábbelikkel csakúgy, mint a munka- és szabadidőruházattal a "Beta Work" termékcsalád egésze alatt.
- 2009** ● A Beta tovább bővíti piacait és megalapítja kirendeltségét Kínában.
- 2012** ● Beta Brazília megalapítása.
- 2016** ● A Beta egy új moduláris műhelyberendezési rendszert mutat be. Ez az RSC55.
- 2018** ● A krimpelhető kábelsaruk és az elektromos csatlakozók gyártásában és értékesítésében piacvezető BM S.p.A., az egyedi műhelyberendezés összeállítások tervezésére és gyártására specializálódott 3D Beta S.r.l., és a fém bútorok porfestésére szakosodott VGF S.r.l. a Beta Csoport tagjává válik. A Csoport növekedési stratégiáját továbbblendítette a csiszolótermékek gyártásában vezető Abra Beta S.p.A. és Elpa Abrasivi S.r.l. felvásárlása, mellyel tovább bővült a Csoport által kínált professzionális termékek skálája.
- 2020** ● Megalapításra került a Beta Tools USA, mely mérföldkő az Észak-Amerikai piacon való terjeszkedésben.
- 2023** ● A folyamatos növekedés gyümölcse a jelenlegi, világszerte értékesített termékkínálat, mely egy 30 termékcsaládból és 16.000 cikkszámából álló, a legigényesebb szakemberek elvárásainak kielégítésére tervezett, jó minőségű és hosszú élettartamú termékportfólió, mely a „Beta Well Done” alapelvnek megfelelően készült. Mi, a Beta-nál ezen alapelv szerint végezzük munkánkat, hogy bármit is teszünk, a dolgokat csak egyféleképpen csinálhatjuk: jól.



1923 Alessandro Ciceri & Figli



1939 Vas és acél süllyesztéses kovácslás



1955 Vágástechnika

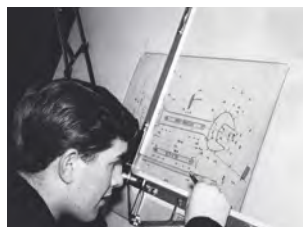

1960 Tervezés



1969 Tank szerszámkocsi



1974 Szerszámkészlet reklám



1975 Vittorio Brambilla



2002 "BetaWork"

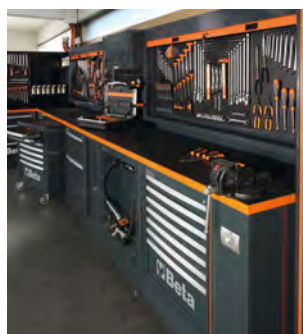

2016 RSC55 műhelyberendezés összeállítás

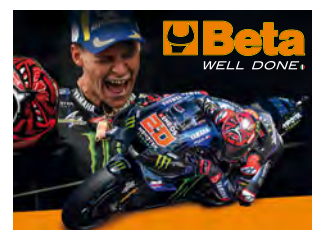

2022 Fabio Quartararo, a Beta nagykövete

TANÚSÍTOTT MINŐSÉG

A Beta szerszámkocsik 2018 óta rendelkeznek az elismert Tüv tanúsítvánnyal, amit a szigorú EK5/TA5 protokoll tesztheinek történő megfelelés után kaptak.

Az EK5/TA5 protokoll 31 jól körülhatárolt gyártási jellemzőt, szigorú statikai tesztek és dinamikai viselkedési tesztek irányoz elő. További tesztek határozzák meg a magas és az alacsony hőmérsékletekkel szembeni ellenállást, a jelölések időtállóságát és a korrózióállóságot.

Ennek a célnak az elérése azt a tapasztalt tervezést, a gondos megvalósítást és a szigorú ellenőrzést értékeli, amit a Beta a szerszámkocsik gyártása során alkalmaz, és ami a mai napig biztosítja a végfelhasználók elismerését.



KONTROLL ÉS MINŐSÉG

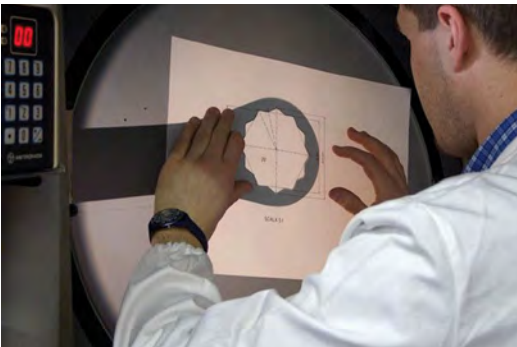
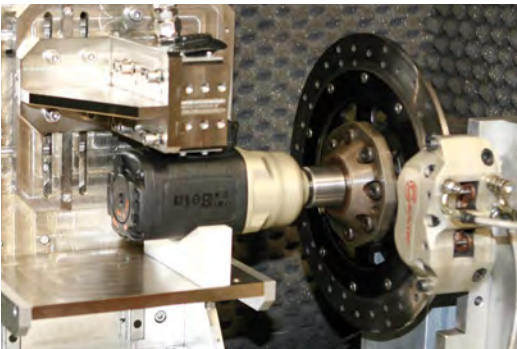
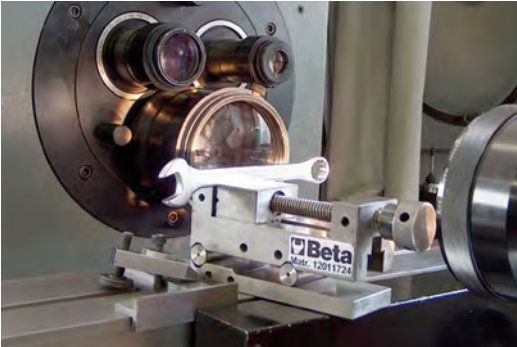

A Beta-nál a minőségnek egyszerű és egyértelmű definíciója van: "az, ami teljes mértékben kielégíti a professzionális felhasználók igényeit és elvárásait, akik pótolhatatlan munkaeszközként tekintenek termékeinkre". Szerszámainkat nem csak egy egyszerű igény kielégítésére tervezzük és gyártjuk, de az idő előrehaladtával következetesen garantálniuk kell az állandó teljesítményt.

A Beta-nál a minőség a gyártási folyamatra és az értékesítési politikára jellemző pusztán figyelmességen túlmutatóan minden részleget áthat és mindannyiunkat arra buzdít, hogy egyre ambiciózusabb célokat érjünk el az ügyfelek elégedettségének terén. A Beta erre a koncepcióra építette fel történetét.

A Beta minőség a legkézzelfoghatóbb eredményünk.

A Beta szerszámok minősége a régi, jól bevált technikák és az új technológiák szinergiája.



Gyártásunk 1995 óta az ISO 9001 minőségirányítási rendszer szabványai szerint működik.



LOGISZTIKA



**22,000 m²
terület**



16.000
cikkszám több mint
27.000
rakodási egység



**Gyors, pontos
és hiánytalan
szállítások**



MUNKASZERVEZÉS

Az 5S egy japán eredetű munkahelyi rendszerezési módszer. A név öt japán szó (**seiri, seiton, seiso, seiketsu és shitsuke**) angolos átírásából származik.

A szavakból létrehozott öt lépés egy rendezett, megismételhető módszert eredményez, melynek célja a munkafolyamatok optimalizálása és a működési teljesítmény fejlesztése.



SEIRI

SZELEKTÁLÁS

A munkahelyen levő szükségtelen dolgok eltávolítása, csak a szükséges dolgok megtartása.



SEITON

ELRENDEZÉS

Minden kerüljön a megfelelő helyére: mindennek legyen helye, és minden legyen a helyén.



SEISO

TISZTASÁG

Legyen a munkahely tiszta és rendezett.



SEIKETSU

STANDARDIZÁLÁS

Következetes munkagyakorlatok létrehozása az erőforrások és a hely racionalizálása, egy megvalósítandó szabvány meghatározása céljából.



SHITSUKE

FENNTARTÁS

A fenti szemlélet és magatartás támogatása és elterjesztése az egész szervezetben.



ELŐNYÖK



Kevesebb idővesztés és jobb költséghatékonyság



Jobb minőség és fokozott termelékenység



Kevesebb munkabaleset



Nagyobb hatékonyság



ELŐTTE



UTÁNA

HATÉKONY JELENLÉT

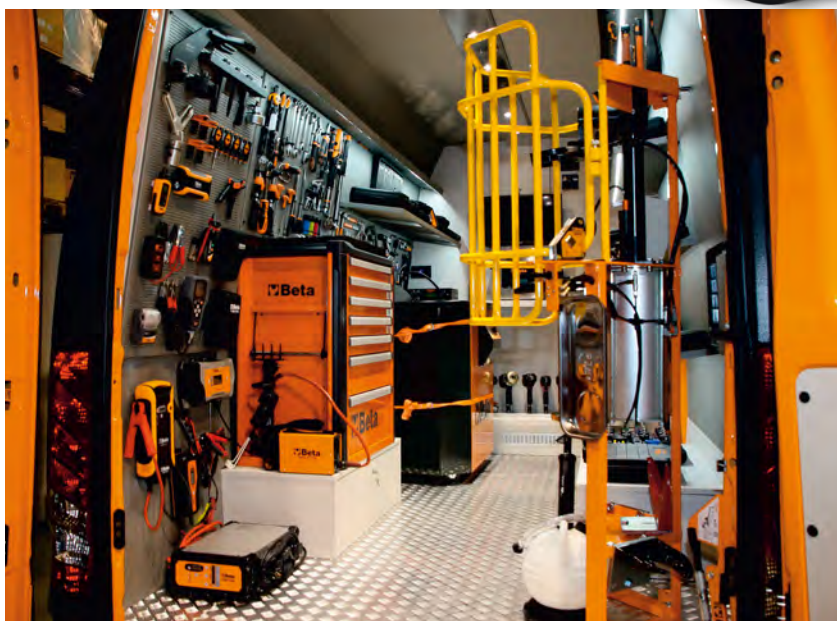
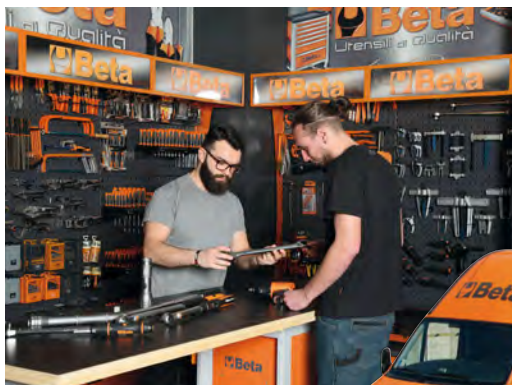

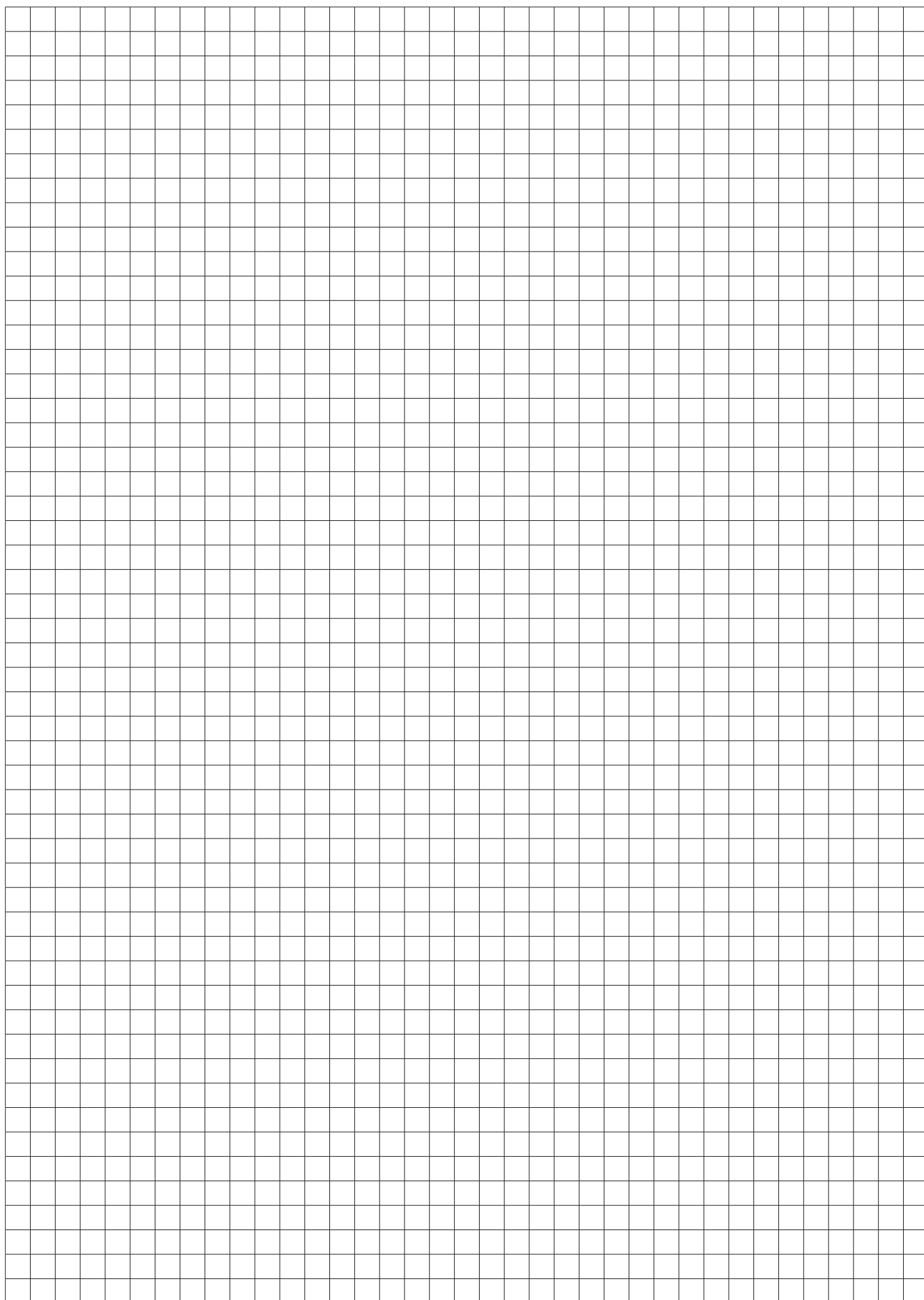

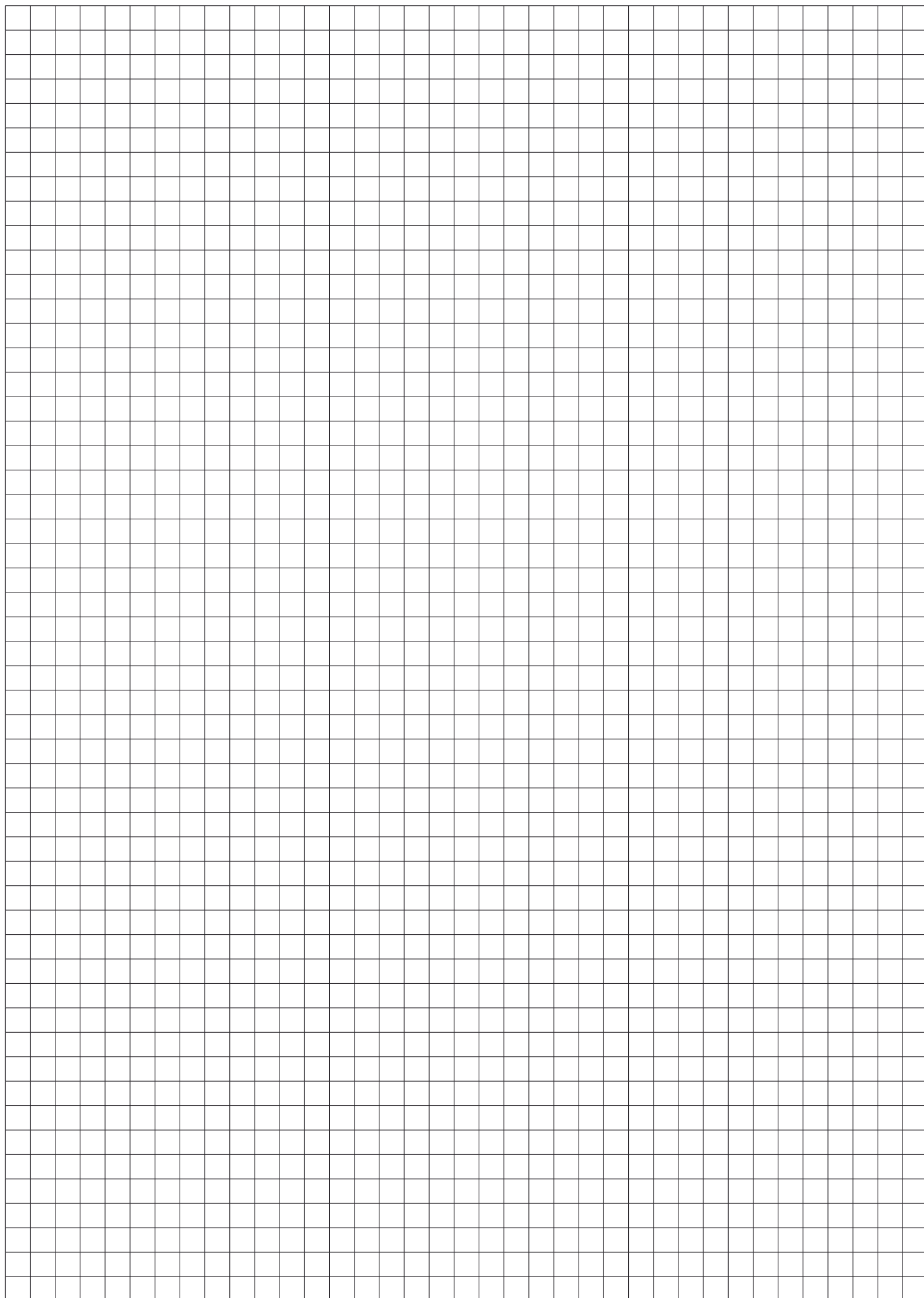

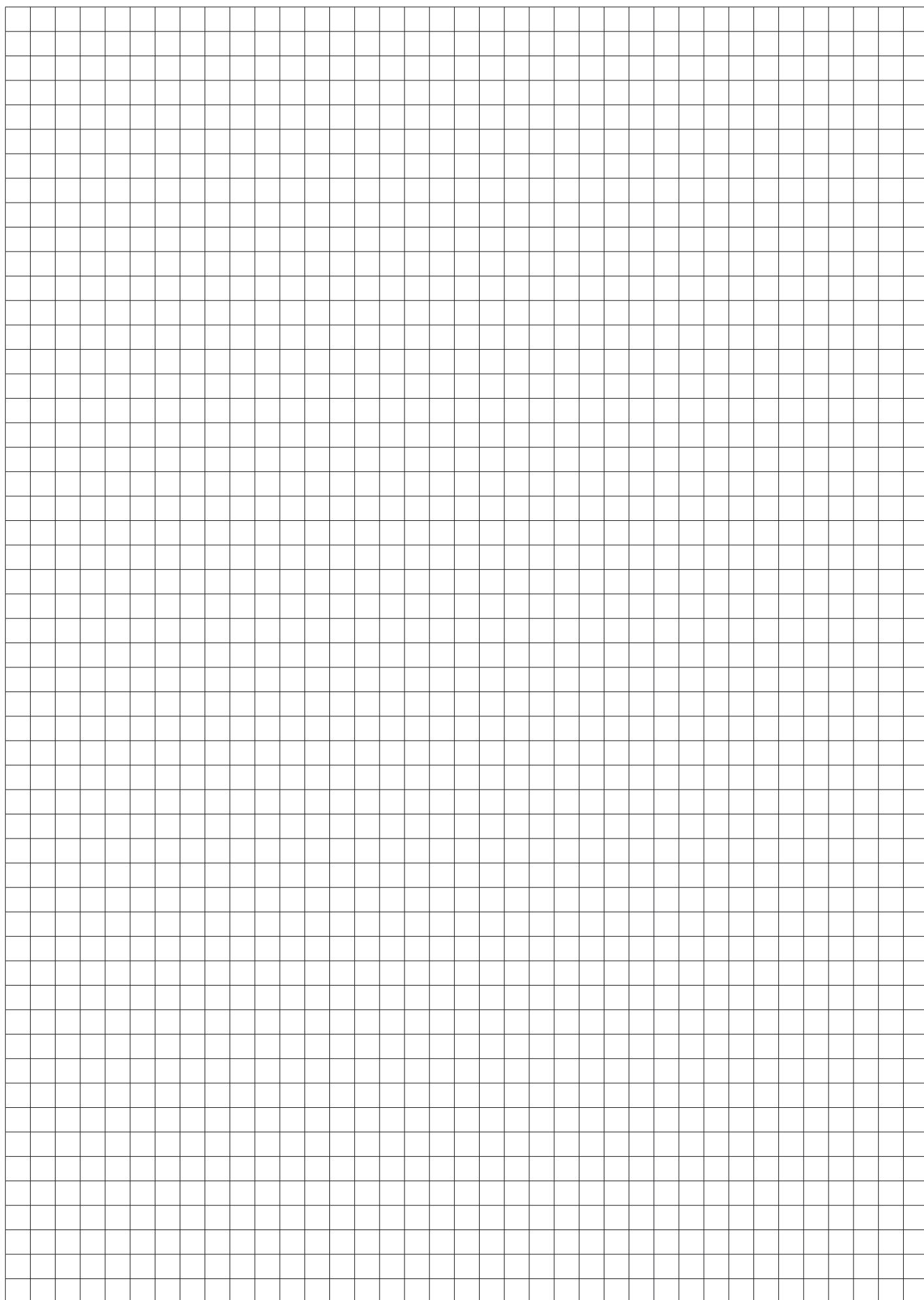

Fabio Quartararo
2022 MotoGP
World Championship



Partnership 2022



50 Years in Motorsports

PARTNERSHIP

2022



TEAM
speedup

ALONSO LOPEZ
Moto2 World
Championship



Technical
Partner



Beta | **aprilia**
RACING



998069102

